



LAWNTON

MEDIZINTECHNIK



Chirurgie
Surgery
Cirugía
Chirurgie
Chirurgia

Wir behalten uns vor, Änderungen und Verbesserungen durchzuführen und die Instrumente und Geräte ohne besonderen Hinweis in der modifizierten Ausführung auszuliefern.

Die Verwendung dieses Kataloges zu anderen Zwecken als ausschließlich der zum Vertrieb von LAWTON-Produkten erforderlichen Handlungen, ist untersagt. Zuwiderhandlungen werden rechtlich geahndet. Der Nachdruck, auch auszugsweise, ist verboten.

We reserve the right of technical modifications and improvements and to supply the instruments and apparatus without specific indication in the modified finish.

The use of this catalogue is restricted to actions necessary for selling original LAWTON products. The use for any purpose other than selling original LAWTON products is prohibited and will be prosecuted. Reprinting, even partially, is not allowed.

Nos reservamos el derecho de realizar modificaciones y mejoras y de entregar los instrumentos y los aparatos, sin avisar específicamente que se ha modificado la versión correspondiente.

Se prohíbe el uso de este prospecto para otras finalidades que las acciones exclusivamente necesarias para comercializar los productos de LAWTON. Se perseguirá jurídicamente a los infractores. Queda prohibida la reimpresión, incluso de partes del catálogo.

Nous nous réservons le droit d'effectuer des modifications et des améliorations et de livrer les instruments et appareils dans leur version modifiée sans mention spéciale.

L'utilisation de ce catalogue à d'autres fins que les seules opérations nécessaires à la vente des produits LAWTON est interdite. Toute infraction fera l'objet d'une poursuite en justice. La reproduction, même partielle, est interdite.

Ci riserviamo il diritto di apportare modifiche e migliorie nonché di fornire gli strumenti e gli apparecchi nella versione modificata senza particolare preavviso.

Evietato l'utilizzo di questo catalogo informativo per qualsiasi altro scopo che esula dalle iniziative atte esclusivamente alla vendita dei prodotti LAWTON. Eventuali trasgressioni saranno perseguite per via legale. La riproduzione, anche parziale, di questo catalogo non è autorizzata.



LAWTON

MEDIZINTECHNIK

GERMANY

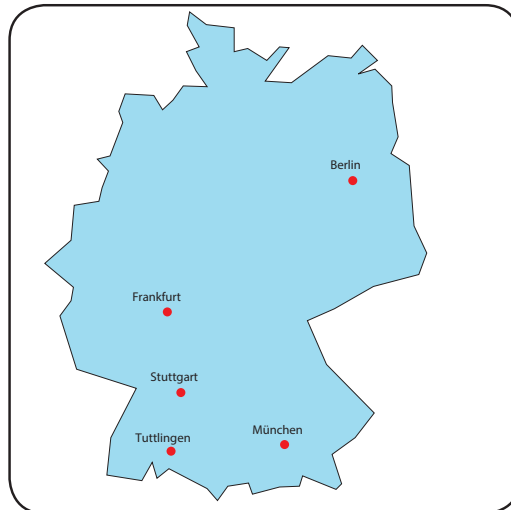

BADEN-WÜRTTEMBERG

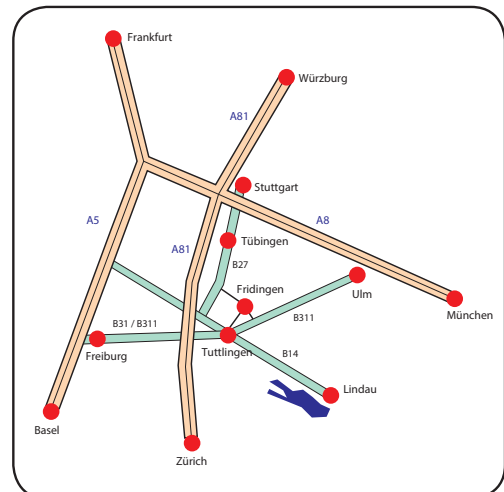

LAWTON GmbH & Co. KG
Württembergischer Str. 23
Telefon: +49 (0) 7463 99 65-0
e-mail: info@lawton.de

D-78567 Fridingen/Germany
Telefax: +49 (0) 7463 99 65-20
<http://www.lawton.de>

Seit 1947 werden in unserem Hause qualitativ hochwertige chirurgische Instrumente und medizintechnische Geräte hergestellt und vertrieben, die weltweit anerkannt und geschätzt werden.

Die Erfolge der Vergangenheit und besonders das Verantwortungsbewußtsein gegenüber dem Chirurgen und dem Patienten sind uns Verpflichtung, auch in Zukunft unsere ganze Kraft, Erfahrung und Kreativität zum Fortschritt der Medizintechnik einzusetzen.

Der vorliegende Chirurgie-Katalog Nr. 6/98 zeigt auf 758 Seiten mehr als 6.000 verschiedene Instrumente für die Medizintechnik. Er enthält von Seite 1 bis 380 das allgemeine Instrumentarium, das in allen chirurgischen Disziplinen erforderlich ist. Von der Seite 381 bis 730 finden Sie Instrumente für die verschiedenen Fachdisziplinen. An diese Seiten schließen sich die Bereiche Sterilisation und Reinigung an.

Der Katalog wird ergänzt durch zusätzliche Kataloge über MIC- (Minimal Invasive Chirurgie), HNO- (Hals / Nase / Ohr) und Ophthalmologie-Instrumente sowie durch Prospektunterlagen über Spezialitäten und Neuentwicklungen.

Since 1947, our company has been manufacturing and distributing high-quality surgical instruments and medical equipment that have gained a worldwide reputation for excellence.

We view our past success and, in particular, our responsibility towards the surgeon and the patient as an obligation to continue to focus our skill, experience, and creativity on advancing the art of medical technology in the future.

Containing 758 pages, our latest surgical catalogue, No. 6/98, describes more than 6,000 different instruments in the area of medical technology. Pages 1 to 380 cover the general instrumentation common for all surgical disciplines. Specialized instruments for particular areas of surgery can be found on pages 381 to 730. The final section of our catalogue covers the area of sterilization and cleaning.

Specialized catalogues for MIS (Minimal Invasive Surgery), ENT (Ear / Nose / Throat), and ophthalmological instruments, together with brochures covering special products and the latest developments, round out the offerings in our main catalogue.

Desde 1947 que fabricamos y comercializamos en nuestra empresa instrumentos quirúrgicos y aparatos de tecnología médica, los cuales están aceptados y son apreciados a nivel mundial.

Los éxitos del pasado, y especialmente la responsabilidad mostrada ante los cirujanos y los pacientes, nos compromete de forma que, también en el futuro, nos esforcemos para utilizar todos nuestros esfuerzos, experiencia y creatividad en el avance de la tecnología médica.

El presente catálogo n° 6/98, destinado a la cirugía, muestra en 758 páginas más de 6.000 diferentes instrumentos de tecnología médica. En las páginas 1 a 380 contiene el instrumental standard que es necesario en todas las disciplinas quirúrgicas. Desde la página 381 a la 730 se encuentran instrumentos para otras disciplinas médicas. Estas páginas van seguidas de los ámbitos de esterilización y de limpieza.

Este catálogo es completado por medio de catálogos adicionales acerca de instrumentos MIC (cirugía mínima invasiva), ORL (otorrinolaringología) y oftalmológicos, así como mediante prospectos sobre especialidades y nuevos desarrollos.

Depuis 1947, des instruments chirurgicaux et des appareils médicaux de très haute qualité reconnus et appréciés dans le monde entier sont produits et vendus au sein de notre société.

Les succès du passé et, notamment, la conscience de notre responsabilité à l'égard du chirurgien et du patient signifient pour nous le devoir de mettre en œuvre à l'avenir également toute notre force, notre expérience et notre créativité au service du progrès de la médecine.

Ce catalogue de produits chirurgicaux no. 6/98 montre sur 758 pages plus de 6.000 différents instruments destinés à la technique médicale. Il comporte aux pages 1 à 380 l'instrumentation générale nécessaire dans toutes les disciplines chirurgicales. A partir de la page 381 jusqu'à la page 730 se trouvent les instruments destinés aux différentes disciplines. A ces pages s'ajoutent enfin les domaines stérilisation et nettoyage.

Le catalogue est complété par des catalogues supplémentaires se rapportant aux instruments de la chirurgie invasive minimale, de l'oto-rhino-laryngologie et de l'ophtalmologie et par une documentation concernant les spécialités et les nouveaux développements.

Dal 1947 la nostra azienda produce e commercializza strumenti chirurgici ed apparecchi tecnico-medicali di alta qualità, rinomati ed apprezzati in tutto il mondo.

I successi conseguiti nel passato e, soprattutto, la consapevolezza della nostra responsabilità sono per noi motivo d'impegno affinché la nostra forza, la nostra esperienza e la nostra creatività possano anche in futuro essere al servizio del progresso del settore tecnico-medicale.

Il presente catalogo n. 6/98 dedicato alla chirurgia, presenta in oltre 758 pagine più di 6.000 diversi strumenti tecnico-medicali. Dalla pagina 1 alla pagina 380 è illustrata la strumentazione generica idonea per tutte le discipline chirurgiche. Da pagina 381 a pagina 730 troverete gli strumenti specifici per le singole discipline. In queste pagine trovano spazio gli strumenti di pulizia e sterilizzazione.

Il catalogo è intergrato da ulteriori cataloghi illustranti gli strumenti specifici dei settori di chirurgia di minima invasiva, di otorinolaringoiatria e di oftalmologia, nonché da documentazione informativa dedicata alle varie specialità e alle novità.



CERTIFICATE



This is to certify that the company

Lawton GmbH & Co. KG

Württembergischer Straße 23
78567 Fridingen
Germany

has implemented and maintains a **Quality Management System**.

Scope:

Design, development, production and distribution of surgical instruments, endoscopes, insufflators, suction-/irrigation units, non-active implants for osteosyntheses, tonometers, wound clamps, surgical scalpels, scalpel blades (sterile), aneurysm clips (permanent and temporary).

Through an audit, documented in a report, performed by DQS Medizinprodukte GmbH, it was verified that the management system fulfills the requirements of the following standard:

EN ISO 13485 : 2012 + AC : 2012

Certificate registration No. 230466 MP2012
Certificate unique ID 170595175
Effective date 2014-08-11
Expiry date 2017-08-10
Frankfurt am Main 2014-08-11



DQS Medizinprodukte GmbH

Frank Graichen
Managing Director

Dr. Thomas Feldmann
Head of Certification Body



August-Schanz-Straße 21, 60433 Frankfurt am Main, Tel. +49 (0) 69 95427-263, medical.devices@dqs.de

20121211/4/EN380307

Alles spricht über Qualität - LAWTON dokumentiert Qualität

LAWTON - where Certified Quality is at Home

Todos hablan de calidad - LAWTON documenta calidad

Tout le monde parle de la qualité - LAWTON la certifie

Tutti parlano di qualità - LAWTON documenta qualità

LAWTON
Medizintechnik

Mit der erfolgreich abgeschlossenen Überprüfung durch die DQS ist die Firma LAWTON nach EN ISO 9001, EN ISO 13485, EG-Richtlinie 93/42, Anhang 2 und 5 und damit nach den höchsten Nachweisstufen zertifiziert.

Die EN ISO 9001 ist die Basisform für ein umfassendes Qualitätsmanagementsystem von der Produktidee bis zum Kundenservice. Diese Norm gilt für sämtliche Branchen, vom Maschinenbau bis zur Medizintechnik. Für die Medizintechnik gelten jedoch zusätzliche Anforderungen, welche in der EN ISO 13485 festgeschrieben sind.

Die EG-Richtlinie 93/42, Anhang 2 und 5, sowie die nationalen Medizinprodukte-Gesetze beschreiben ein Qualitätsmanagement nach EN ISO 13485. Zum Patientenschutz werden darin darüberhinaus Nachweise zur Eignung und Risikominimierung von Medizinprodukten gefordert.

Following successful conclusion of a review by DQS, LAWTON is now certified in conformity with EN ISO 9001, EN ISO 13485, EG guideline 93/42, annexes 2 and 5, and thus in accordance with the highest verification levels.

EN ISO 9001 is the basic standard which governs a total quality management system from the product idea to after-sales service. This standard applies to all sectors, from mechanical to medical engineering. Additional requirements apply to medical engineering. These are laid down in EN ISO 13485.

The EG guideline 93/42, annexes 2 and 5, and also the national medical products laws, describe quality management in conformity with EN ISO 13485. To protect patients, proof of suitability and risk minimisation of medical products is also required.

Gracias a que el DQS ha terminado la comprobación del sistema de producción con éxito, la empresa LAWTON ya queda certificada con la presente según las normas EN ISO 9001, EN ISO 13485 y la directriz de la CE 93/42, anexos 2 y 5, es decir, al máximo nivel de certificación.

La norma EN ISO 9001 es la norma básica para un amplio sistema de gestión de calidad, el cual abarca, desde la concepción de la idea del producto, hasta el servicio al cliente. Esta norma es válida para todos los sectores, desde la construcción de maquinaria, hasta la tecnología médica. De todas formas, para la tecnología médica son aplicables unos requisitos especiales, los cuales quedan determinados por la norma EN ISO 13485.

La directriz de la CE 93/42, anexos 2 y 5, así como las leyes nacionales sobre productos medicinales, describen un sistema de gestión de calidad según la norma EN ISO 13485. Para proteger a los pacientes, se requiere además la demostración de que los productos medicinales son idóneos y minimizan los riesgos correspondientes.

Avec la vérification couronnée de succès effectuée par le contrôle technique DQS, la Société LAWTON a été certifiée selon EN ISO 9001, EN ISO 13485, Directive CE 93/42, annexes 2 et 5, la plus haute justification possible.

La EN ISO 9001 est la forme fondamentale pour un vaste système de gestion de la qualité, depuis l'idée du produit jusqu'au service clients. Cette norme est en vigueur pour toutes les branches, de la construction mécanique à la technique médicale. Cependant, pour la technique médicale, des exigences supplémentaires sont applicables et fixées dans la norme EN ISO 13485.

La Directive CE 93/42, annexes 2 et 5, ainsi que les lois nationales relatives aux produits médicaux décrivent une gestion de la qualité selon EN ISO 13485. Pour la protection des patients, des preuves de l'adéquation et de la minimisation des risques des produits médicaux y sont exigées.

In seguito all'esito positivo dato dalle prove eseguite dal DQS, la ditta LAWTON è certificata a norme EN ISO 9001, EN ISO 13485, direttiva CE 93/42, allegato 2 e 5 e può pertanto fregiarsi del massimo livello di certificazione qualitativa.

La certificazione EN ISO 9001 fissa le regole del sistema di gestione della qualità nel suo complesso, dall'ideazione di un prodotto fino al servizio alla clientela. Questa norma è applicata in tutti i settori, dall'industria meccanica a quella tecnico-sanitaria. L'industria tecnico-sanitaria deve comunque rispondere ad ulteriori requisiti, quelli fissati dalla normative EN ISO 13485.

La direttiva CE 93/42, allegato 2 e 5, e le leggi nazionali sui prodotti medicali esprimono una gestione della qualità ai sensi di EN ISO 13485. In essa si richiedono ulteriori dimostrazioni dell'adeguatezza dei prodotti medicali e della minimizzazione dei rischi per la salvaguardia del paziente.



Ein hohes Entwicklungspotential und über 50 Jahre Erfahrung in der Medizintechnik haben LAWTON zu einem zuverlässigen Wegbegleiter der Medizin wachsen lassen.

A high development potential and more than 50 years of experience in medical engineering have made LAWTON a reliable partner in the medical sector.

El elevado potencial de desarrollo, así como la experiencia de más de 50 años en la tecnología médica, han convertido a LAWTON en un confiable compañero de la medicina.

Un fort potentiel de développement et plus de 50 ans d'expérience dans la technique médicale ont fait de LAWTON un compagnon fiable de la médecine.

Un alto potenziale di sviluppo e oltre 50 anni di esperienza nel settore tecnico-medica, hanno reso la LAWTON un partner sicuro ed affidabile della moderna medicina.



Das Fertigungs- und Lieferprogramm umfaßt derzeit über 12.000 verschiedene Produkte und wird heute über das weltweite LAWTON-Händlernetz vertrieben.

The production and delivery range currently embraces more than 12,000 different products and is today marketed through LAWTON's worldwide network of dealers.

El programa de producción y de suministro abarca actualmente más de 12.000 diferentes productos, siendo comercializados hoy en día a través de la red mundial de distribuidores de LAWTON.

Le programme de fabrication et de livraison comporte à l'heure actuelle plus de 12.000 différents produits; de nos jours, il est commercialisé dans le monde entier par le réseau de vendeurs de LAWTON.

La gamma di produzione e di distribuzione comprende attualmente oltre 12.000 diversi prodotti commercializzati attraverso la rete di vendita mondiale LAWTON.



Die permanente Verbesserung bestehender Produkte und die Entwicklung von Produktinnovationen sowie der Einsatz neuester Werkstoffe sichern die Wettbewerbsfähigkeit von LAWTON.

LAWTON's competitiveness is safeguarded by the permanent enhancement of existing products and the development of product innovations as well as use of the most modern materials.

La permanente mejora de los productos existentes y el desarrollo de productos innovativos, así como el uso de materiales totalmente nuevos, nos permite asegurar la competitividad de LAWTON.

L'amélioration permanente des produits existants, la mise au point d'innovations ainsi que la mise en œuvre des matériaux les plus modernes garantissent la compétitivité des produits LAWTON.

Il costante miglioramento dei prodotti già esistenti e la realizzazione di prodotti innovativi nonché l'impiego di nuovi materiali, confermano l'alto livello di competitività della LAWTON.



Die hohen Anforderungen der Norm EN ISO 9001 mit dem Medizialzusatz EN ISO 13485 gewährleisten den hochwertigen Qualitätsstandard und die Modelltreue aller LAWTON-Instrumente.

The high requirements of the EN ISO 9001 requirement in conjunction with the additional medical standard EN ISO 13485 guarantee the high quality standard and model fidelity of all LAWTON instruments.

Los elevados requisitos derivados de la norma EN ISO 9001, junto al complemento médico de la norma EN ISO 13485, garantizan el elevado nivel de calidad y la fidelidad de los modelos de instrumentos de LAWTON.

Les hautes exigences imposées par la norme EN ISO 9001 avec son complément médical EN ISO 13485 garantissent le haut standard de qualité et la fidélité des modèles de tous les instruments LAWTON.

I severi requisiti imposti dalla norma EN ISO 9001 insieme alla norma EN ISO 13485 specifica per il settore medicale, garantiscono l'alta qualità e la conformità di tutti gli strumenti LAWTON.



Die moderne Produktionsstätte von LAWTON befindet sich nur wenige Kilometer von Tuttlingen entfernt, das weltweit bekannt ist als Zentrum der Herstellung chirurgischer Instrumente.

LAWTON's modern production facility is located only a few kilometres away from Tuttlingen, which is known throughout the world as a centre for the production of surgical instruments.

El moderno lugar de producción de LAWTON se encuentra ubicado sólo a unos pocos kilómetros de Tuttlingen, la cual es conocida en todo el mundo como centro de fabricación de instrumentos quirúrgicos.

Le site moderne de production de LAWTON ne se trouve qu'à quelques kilomètres de Tuttlingen, mondialement connu comme le centre de la fabrication d'instruments chirurgicaux.

I moderni stabilimenti di produzione della LAWTON si trovano solo a pochi chilometri da Tuttlingen, il centro di produzione di strumenti chirurgici famoso in tutto il mondo.



Die sorgfältige Auswahl von qualitativ hochwertigen Roh-, Hilfs- und Betriebsstoffen schaffen die Basis für das hohe Qualitätsniveau aller LAWTON-Instrumente.

Careful selection of high-grade raw materials and consumables creates the basis for the high quality level of all LAWTON instruments.

La cuidadosa selección de materias primas, materiales adicionales y medios de producción de alta calidad crea la base para el elevado nivel de calidad de los instrumentos de LAWTON.

Le choix méticuleux des matériaux bruts, auxiliaires et des produits d'exploitation de haute qualité sont la base du haut niveau de qualité de tous les instruments LAWTON.

L'attenta selezione di materiali grezzi, ausiliari e d'esercizio di alta qualità sta alla base dell'alto standard qualitativo di tutti gli strumenti LAWTON.



Moderne, CNC-gesteuerte Bearbeitungszentren und neu entwickelte Fertigungsverfahren garantieren von der maschinellen Vorfertigung bis zur Endkontrolle des fertigen Produkts für hohe Qualität und Funktionalität der LAWTON-Instrumente.

From machine preproduction to final inspection of the finished product, modern CNC-controlled machining centres and newly developed production processes are guarantors of the high quality and functionality of LAWTON instruments.

Modernos centros de elaboración controlados por CNC y procesos de producción de nuevo desarrollo garantizan, desde la preproducción maquina, hasta llegar al control final del producto acabado, la elevada calidad y funcionalidad de los instrumentos de LAWTON

Les centres d'usinage modernes à commande CNC et des processus de fabrication nouvellement développés sont la garantie de la haute qualité et fonctionnalité des instruments LAWTON depuis la préfabrication mécanique jusqu'au contrôle final du produit fini.

Moderni centri di lavorazione a controllo numerico computerizzato e processi produttivi altamente innovativi, dalla prelavorazione in macchina fino al collaudo finale dei prodotti finiti, sono garanzia di qualità e funzionalità degli strumenti LAWTON.



Das handwerkliche Geschick und das geschulte Auge des Chirurghiemechanikers sichern die einwandfreie Funktion und Zuverlässigkeit aller LAWTON-Instrumente.

The craftsman's skills and the trained eye of the surgical mechanic ensure perfect functioning and reliability of all LAWTON instruments.

La pericia manual y la vista experta de los mecánicos quirúrgicos asegura que los instrumentos de LAWTON funcionen a la perfección y sean confiables.

L'adresse artisanale et l'œil exercé du mécanicien chirurgical garantissent la fonction parfaite et la fiabilité de tous les instruments LAWTON.

L'abilità artigianale e l'occhio esperto del meccanico del settore chirurgico assicurano la massima funzionalità e affidabilità di tutti gli strumenti LAWTON.



Ständige Kontrollen während der Fertigung und am Ende des Produktionsprozesses gewährleisten Zuverlässigkeit und Funktionalität über die gesamte Lebensdauer aller LAWTON-Instrumente.

Constant inspections during production and at the end of the production process guarantee reliability and functionality throughout the entire service life of all LAWTON instruments.

Constantes controles durante la producción y al final del proceso de fabricación garantizan que los instrumentos de LAWTON sean confiables y funcionen durante toda su vida útil.

Des contrôles permanents en cours de fabrication et à la fin du processus de production garantissent la fiabilité et la fonctionnalité pour l'ensemble de la durée de vie utile de tous les instruments LAWTON.

Controlli ripetuti e costanti in fase di produzione e al termine del processo produttivo garantiscono massima affidabilità e funzionalità durante l'intera vita operativa di tutti gli strumenti LAWTON.



Die Abteilung „Technischer Kundenservice“ führt innerhalb einer Woche Reparaturen von Instrumenten aller Art - mit einem geringen Kostenaufwand - durch.

The „Technical After-Sales Service“ department repairs all manner of instruments within one week and at low cost.

El departamento de „Servicio técnico al cliente“ realiza, en el plazo de una semana - reparaciones de instrumentos de todo tipo - a bajo costo.

Le département „Service technique après-vente“ effectue en une semaine - à peu de frais - les réparations des instruments de toute nature.

Il reparto „Assistenza Tecnica alla Clientela“ esegue nell'arco di una settimana - a costi contenuti - la riparazione di strumenti di tutti i generi.

Informationen

Informations
Informaciones
Informations
Informazioni

LAWTON
Medizintechnik



Das gut sortierte Instrumentenlager sowie eine mit modernster Daten- und Informationstechnik gesteuerte Produktionsplanung, Disposition und Lagerlogistik bieten unseren Kunden schnelle und zuverlässige Informationen und eine optimale Lieferbereitschaft. In der Regel sind alle Standard-Instrumente ab Lager lieferbar.

The well-appointed instruments warehouse and production planning, control, dispatching and warehouse logistics controlled by the most up-to-date data processing and information systems offer our customers fast and reliable information and optimum delivery readiness. All standard instruments are generally available from stocks.

El almacén de instrumentos bien surtido, así como la moderna tecnología de procesamiento de datos e informática aplicada a la planificación y al control de la producción, la disposición y la logística de almacenamiento, ofrece a nuestros clientes informaciones rápidas y confiables, así como una óptima disponibilidad de entrega. Normalmente, todos los instrumentos standards, están disponibles del stock.

Le stock d'instruments bien assorti et une planification et gestion des produits, la disposition et la logistique des stocks, commandées par une technique d'information et de communication les plus modernes, offrent à nos clients des informations rapides et fiables et une capacité de livraison optimale. En règle générale, tous les instruments standards sont disponibles en stock.

Un magazzino ben organizzato e una pianificazione, gestione, disposizione della produzione e una logistica di stoccaggio gestiti con le più moderne tecniche informatiche assicurano alla nostra clientela un veloce ed affidabile scambio di informazioni e un'ottimale disponibilità alla fornitura. Di regola, tutti gli strumenti standard sono disponibili a magazzino.



Alle von LAWTON hergestellten und vertriebenen Instrumente tragen das LAWTON-LOGO und die individuelle Artikelnummer sowie das europäische CE-Zeichen.

All instruments manufactured and sold by LAWTON bear the LAWTON logo and their individual article numbers as well as the European CE mark.

Todos los instrumentos fabricados y comercializados por LAWTON llevan el logotipo de LAWTON y el número del artículo correspondiente, así como la marca CE europea.

Tous les instruments produits et vendus par LAWTON portent les logo LAWTON, le numéro individuel d'article et la marque CE européenne.

Su tutti gli strumenti prodotti e commercializzati da LAWTON è riportato il logo LAWTON con il rispettivo codice articolo e il marchio europeo CE.



Moderne Kommunikations- und Informationstechnik unterstützen unsere Mitarbeiter in ihren Bemühungen, unseren Kunden in aller Welt einen optimalen After-Sales-Service zu gewähren.

Modern communication and information technology support our staff in their endeavours to provide optimum after-sales service to our customers throughout the world.

Nuestros empleados son apoyados en sus esfuerzos, con moderna tecnología de comunicaciones e informática, que garantiza un servicio postventa óptimo a nuestra clientela en el mundo entero.

La technique moderne de communication et d'information assiste nos collaborateurs dans leurs efforts consacrés à garantir un service après-vente optimal dans le monde entier.

I nostri collaboratori si avvalgono delle più moderne tecniche informatiche e di comunicazione per poter garantire alla clientela di tutto il mondo un servizio di assistenza post-vendita ottimale.



In unserem Ausstellungszentrum sowie auf den wichtigsten nationalen und internationalen Fachmessen zeigt LAWTON Neuheiten und ihr bewährtes Lieferprogramm für alle Bereiche der modernen Medizin.

In our exhibition centre, and at the most important national and international trade fairs, LAWTON presents new products and its proven delivery range for all areas in modern medicine.

LAWTON muestra las novedades y el programa de suministro para todas las disciplinas de la medicina moderna, en nuestro centro de exposición, así como en las ferias especializadas nacionales e internacionales más importantes.

Dans notre centre d'exposition et les salons nationaux et internationaux les plus importants, LAWTON montre des nouveautés et son programme de livraison éprouvé pour toutes les disciplines de la médecine moderne.

Nel nostro centro espositivo e presso le più importanti fiere nazionali e internazionali specifiche del settore, la LAWTON mostra le sue novità e la sua gamma di prodotti per tutti i settori della moderna medicina.

Informationen

Informations
Informaciones
Informations
Informazioni

LAWTON
Medizintechnik

Instrumente mit Hartmetallschneiden

Instruments with tungsten carbide edges
Instrumentos con filos de carburo tungsteno
Instruments avec des lames en tungstène
Strumenti con lame in carburo di tungsteno

DURACUT®

Instrumente mit Hartmetalleinlagen

Instruments with tungsten carbide inserts
Instrumentos con bocas de carburo tungsteno
Instruments avec mors en tungstène
Strumenti con morsi in carburo di tungsteno

TITE GRIP®

Instrumente mit spezialbeschichteten Maulteilen

Instruments with specially coated jaws
Instrumentos con bocas cubiertas especiales
Instruments avec mors recouverts d'une couche spéciale
Strumenti con copertura speciale della punta

PERFECT-GRIP

Instrumente mit atraumatischer Riefung

Instruments with non-traumatic serration
Instrumentos con bocas atraumáticas
Instruments avec mors atraumatiques
Strumenti con presa atraumatica

ATRAUMATIC-GRIP

Instrumente aus TITAN

Instruments made from TITANIUM
Instrumentos de TITANIO
Instruments en TITANE
Strumenti in TITANIO

TITAN-LINE

Flüssiges Konzentrat zur Pflege chirurgischer Instrumente

Liquid concentrate for surgical instrument care
Líquido concentrado para el cuidado de instrumental quirúrgico
Concentré liquide pour l'entretien des instruments
Concentrato liquido per la cura degli strumenti chirurgici

PREP LUBE



Diagnostik	Seite	1 - 14
Diagnostics	Page	1 - 14
Diagnóstico	Página	1 - 14
Diagnostic	Page	1 - 14
Diagnostica	Pagina	1 - 14



Vorbereitung, Dermatologie	Seite	15 - 20
Preparation, Dermatology	Page	15 - 20
Preparación, Dermatología	Página	15 - 20
Préparation, Dermatologie	Page	15 - 20
Preparazione, Dermatologia	Pagina	15 - 20



Narkose	Seite	21 - 32
Anaesthesia	Page	21 - 32
Anestesia	Página	21 - 32
Anesthésie	Page	21 - 32
Anestesia	Pagina	21 - 32

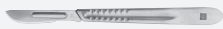

Skalpelle, Messer	Seite	33 - 42
Scalpels, Knives	Page	33 - 42
Bisturíes, Cuchillos	Página	33 - 42
Bistouris, Couteaux	Page	33 - 42
Bisturi, Coltelli	Pagina	33 - 42



DURACUT® Scheren mit Hartmetallschneiden	Seite	43 - 60
DURACUT® Scissors with tungsten carbide edges	Page	43 - 60
DURACUT® Tijeras con filos de carburo tungsteno	Página	43 - 60
DURACUT® Ciseaux avec des lames en tungstène	Page	43 - 60
DURACUT® Forbici con lame in carburo di tungsteno	Pagina	43 - 60

Inhaltsübersicht

Table of Contents

Sumario

Table de matières

Indice

LAWTON
Medizintechnik

Scheren	Seite	61 - 110
Scissors	Page	61 - 110
Tijeras	Página	61 - 110
Ciseaux	Page	61 - 110
Forbici	Pagina	61 - 110



TITE GRIP® Pinzetten mit Hartmetalleinlagen	Seite	111 - 118
TITE GRIP® Forceps with tungsten carbide inserts	Page	111 - 118
TITE GRIP® Pinzas con bocas de carburo tungsteno	Página	111 - 118
TITE GRIP® Pincers avec mors en tungstène	Page	111 - 118
TITE GRIP® Pinze con morsi in carburo di tungsteno	Pagina	111 - 118



Pinzetten	Seite	119 - 152
Forceps	Page	119 - 152
Pinzas	Página	119 - 152
Pincers	Page	119 - 152
Pinze	Pagina	119 - 152



Klemmen, Klemmzangen	Seite	153 - 198
Forceps, Clamps Forceps	Page	153 - 198
Pinzas, Pinzas-clamps	Página	153 - 198
Pincers, Pincers-clamps	Page	153 - 198
Pinze, Pinze emostatiche	Pagina	153 - 198



Tuchklemmen, Schlauchklemmen, Tupferzangen	Seite	199 - 210
Towel Clamps, Tubing Clamps, Cotton Swab Forceps	Page	199 - 210
Pinzas de campo, Pinzas para tubos, Pinzas para tampones	Página	199 - 210
Pincers à compresses, Pincers presse-tubes, Pincers à tampons	Page	199 - 210
Pinze per fissare le compresse, Pinze per tubi, Pinze per tamponi	Página	199 - 210





Wundhaken	Seite	211 - 268
Retractors	Page	211 - 268
Separadores	Página	211 - 268
Ecarteurs	Page	211 - 268
Divaricatori	Pagina	211 - 268

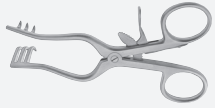

Wundspreizer (selbsthaltend), Bauchdeckenhalter	Seite	269 - 310
Self-Retaining Retractors, Abdominal Retractors	Page	269 - 310
Separadores con retenida automática, Separadores abdominales	Página	269 - 310
Ecarteurs autostatiques, Ecarteurs abdominaux	Page	269 - 310
Divaricatori autostatici, Divaricatori addominali	Pagina	269 - 310



Sonden, Trokare, Saugrohre, Spritzen	Seite	311 - 334
Probes, Trocars, Suction Tubes, Syringes	Page	311 - 334
Sondas, Trócares, Tubos de aspiración, Jeringas	Página	311 - 334
Sondes, Trocars, Canules d'aspiration, Seringues	Page	311 - 334
Sonde, Tre quarti, Tubi aspirazione, Siringhe	Pagina	311 - 334

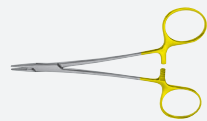

TITE GRIP® Nadelhalter mit Hartmetalleinlagen	Seite	335 - 350
TITE GRIP® Needle Holders with tungsten carbide inserts	Page	335 - 350
TITE GRIP® Porta-agujas con bocas de carburo tungsteno	Página	335 - 350
TITE GRIP® Porte-aiguilles avec mors en tungstène	Page	335 - 350
TITE GRIP® Portaghi con morsi in carburo di tungsteno	Pagina	335 - 350

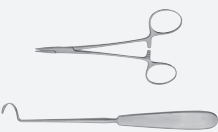

Nahtinstrumente	Seite	351 - 380
Suture Instruments	Page	351 - 380
Instrumentos para sutura	Página	351 - 380
Instrumenti à suture	Page	351 - 380
Strumenti per sutura	Pagina	351 - 380

Inhaltsübersicht

Table of Contents

Sumario

Table de matières

Indice

LAWTON
Medizintechnik

Darm, Magen, Mastdarm	Seite	381 - 412
Intestines, Stomach, Rectum	Page	381 - 412
Intestino, Estómago, Recto	Página	381 - 412
Intestins, Estomac, Rectum	Page	381 - 412
Intestino, Stomaco, Retto	Pagina	381 - 412



Galle, Leber, Niere, Blase, Urologie	Seite	413 - 426
Gall, Liver, Kidney, Bladder, Urology	Page	413 - 426
Bilis, Hígado, Riñón, Vejiga, Urología	Página	413 - 426
Bile, Foie, Rein, Vessie, Urologie	Page	413 - 426
Bile, Fegato, Rene, Vescica, Urologia	Pagina	413 - 426



Gynäkologie	Seite	427 - 474
Gynecology	Page	427 - 474
Ginecología	Página	427 - 474
Gynécologie	Page	427 - 474
Ginecologia	Pagina	427 - 474



Geburtshilfe	Seite	475 - 486
Obstetrics	Page	475 - 486
Obstetricia	Página	475 - 486
Obstétrique	Page	475 - 486
Ostetricia	Pagina	475 - 486



Thorax- und Gefäßchirurgie	Seite	487 - 566
Thoracic and Vascular Surgery	Page	487 - 566
Cirugía torácica y vascular	Página	487 - 566
Chirurgie thoracique et vasculaire	Page	487 - 566
Chirurgia toracica e vascolare	Pagina	487 - 566

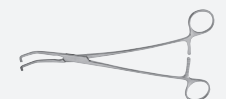



Knochenchirurgie	Seite	567 - 670
Bone Surgery	Page	567 - 670
Cirugía ósea	Página	567 - 670
Chirurgie osseuse	Page	567 - 670
Chirurgia ossea	Pagina	567 - 670



Verband und Gips	Seite	671 - 682
Dressing	Page	671 - 682
Vendajes	Página	671 - 682
Pansements, Appareils plâtrés	Page	671 - 682
Bendaggi, Gessature	Pagina	671 - 682



Neurochirurgie und Laminektomie	Seite	683 - 722
Neurosurgery and Laminectomy	Page	683 - 722
Neurocirugía y Laminectomía	Página	683 - 722
Neurochirurgie et Laminectomie	Page	683 - 722
Neurochirurgia e Laminectomia	Pagina	683 - 722



Tracheotomie	Seite	723 - 730
Tracheotomy	Page	723 - 730
Traqueotomía	Página	723 - 730
Trachéotomie	Page	723 - 730
Tracheotomia	Pagina	723 - 730



Sterilisation, Verschiedenes	Seite	731 - 758
Sterilization, Miscellaneous	Page	731 - 758
Esterilización, Diversos artículos	Página	731 - 758
Stérilisation, Divers articles	Page	731 - 758
Sterilizzazione, Diversi articoli	Pagina	731 - 758



LAWNTON

Medizintechnik



Diagnostik
Diagnostics
Diagnóstico
Diagnostic
Diagnostica



Perkussions- und Reflexhämmer
Percussion Hammers
Martillos de percusión y para reflejos
Marteaux à percussion et à réflexe
Martelli percussori



1/2

TAYLOR
18-0110 18 cm, 7"
▶ 18-0115 20 cm, 8"



1/2

BERLINER
18-0117
20 cm, 8"



1/2

DEJERINE
18-0103
20 cm, 8"



1/2

DEJERINE
18-0104
21,5 cm, 8 1/2"

mit Nadel
with needle
con aguja
avec aiguille
con ago



BUCK
 18-0105
 18 cm, 7"

Hammer für neurologische Untersuchungen, mit Pinsel und Nadel

Hammer for neurological examinations, with brush and needle

Martillo para exámenes neurológicos, con cepillo y aguja

Marteau avec brosse et aiguille pour examens neurologiques

Martello neurologico, con ago e pennello



RABINER
 18-0100
 23,5 cm, 9¹/₄"

Hammer für neurologische Untersuchungen, mit Pinsel und Nadel

Hammer for neurological examinations, with brush and needle

Martillo para exámenes neurológicos, con cepillo y aguja

Marteau avec brosse et aiguille pour examens neurologiques

Martello neurologico, con ago e pennello



TROEMNER
 18-0106
 23 cm, 9"



Sensibilitätsinstrumente
Sensibility Instruments
Instrumentos para examinar la sensibilidad
Instruments pour mesurer la sensibilité
Strumenti per misurare la sensibilità

Stimmgabeln
Tuning Forks
Diapasónes
Diapasons
Diapason



WEBER
18-0134
9,5 cm, 3³/₄"
Ästhesiometer
Aesthesiometer
Estesiometro
Aesthésiomètre
Estensiometro

1/2



ALY
18-0132
17,5 cm, 7"
Algesimeter (Nadel und Pinsel)
Algesimeter (needle and brush)
Algesímetro (aguja y cepillo)
Algesimètre (aiguille et brosse)
Algesiometro (ago e pennello)

1/2



WARTENBERG
18-0130
19 cm, 7 1/2"
Algesimeter (Nervrädchen)
Algesimeter (pinwheel)
Algesímetro (rueda con espinas)
Algesimètre (roue avec aiguilles pour nerfs)
Algesiometro (rotella neurologica)

1/2



HARTMANN
65-0281 c 128
65-0282 c¹ 256
▶ 65-0273 c² 512
65-0274 c³ 1024
Stimmgabeln
Tuning forks
Diapasónes
Diapason
Diapason

1/2



65-0285
a¹ 440
Stimmgabel
Tuning fork
Diapasón
Diapason
Diapason

1/2



verschiebbar
bis h
variable up to h
(engl. b)
variable hasta h
variable jusqu'à h
variabile fino a h

LUCAE
65-0234
c 128
Stimmgabel für Neurologie
Tuning fork for neurology
Diapasón para neurologia
Diapason pour neurologie
Diapason per neurologia

1/2

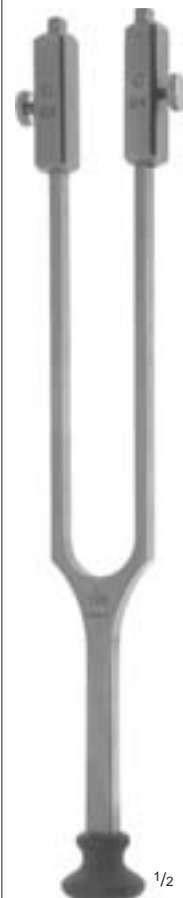

mit Dämpfer c 64
ohne Dämpfer c 128
with clamps c 64
without clamp c 128
con sordinas c 64
sin sordinas c 128
avec curseurs c 64
sans curseurs c 128
con cursori c 64
senza cursori c 128

RYDEL-SEIFFER
65-0230
c 64 / c 128
Stimmgabel für Neurologie
Tuning fork for neurology
Diapasón para neurologia
Diapason pour neurologie
Diapason per neurologia

1/2



WINTER
 18-0191
 13,5 cm, 5 1/4"
 Stethoskop aus Holz, zur Wahrnehmung
 fötaler Herztöne
 Stethoscope of wood, for fetal heart sounds
 Estetoscopio de madera, para tonos cardíacos
 fetal
 Stéthoscope en bois, pour examen foetal
 Stetoscopio per toni cardiaci fetali, in legno



PINARD
 18-0190
 15 cm, 6"
 Stethoskop aus Aluminium, zur Wahrnehmung
 fötaler Herztöne
 Stethoscope of aluminium, for fetal heart sounds
 Estetoscopio de aluminio, para tonos cardíacos
 fetal
 Stéthoscope en aluminium, pour examen foetal
 Stetoscopio per toni cardiaci fetali, in alluminio



SUPER
 18-0170
 Kombinations-Stethoskop aus Leichtmetall, mit drehbarem Membran- (ø 48 mm) und Trichter-
 Bruststück (ø 33 mm)
 Stethoscope combination of light metal, with turnable diaphragm- (ø 48 mm) and bell type chest
 piece (ø 33 mm)
 Estetoscopio combinado de metal ligero, con diafragma girable (ø 48 mm) y parte pectoral con
 forma de campana (ø 33 mm)
 Stéthoscope combiné en métal léger, avec membrane rotative (ø 48 mm) et pavillon entonnoir
 (ø 33 mm)
 Combinazione stetoscopica in metallo leggero con parte pettorale (ø 33 mm) a diaframma (ø 48
 mm) girevole



Prüf- und Meßinstrumente
 Examination and Measuring Instruments
 Instrumentos para exámenes y medición
 Instruments pour examiner et mesurer
 Strumenti per esaminare e misurare



1/2

COLLIN
 18-0150
 12,5 cm, 5"

Dynamometer für Erwachsene, Druck 70 kg
 Dynamometer for adults, pressure 70 kg
 Dinamómetro para adultos, presión 70 kg
 Dynamomètre pour adultes, pression 70 kg
 Dinamometro per adulti, pressione 70 kg



1/4

18-0155
 260 x 105 x 125 mm

Kraftmesser komplett in Plastik-Kassette, bestehend aus 3 Gummibällen (klein, mittel, groß) mit Konusansätzen, Schlauch mit Steckkonus und Meßuhr.

Dynamometer complete in plastic case, consisting of 3 rubber bulbs (small, medium, large), with cone adaptors, tubing with metal mount and manometer.

Dinamómetro completo en estuche de plástico, compuesto de 3 peras de goma (pequeña, mediana, grande), con cono para conexión, tubo con racor metálico y manómetro.

Dynamomètre, complet en boîte plastique, composé de 3 poires (petite, moyenne et grosse) avec raccords coniques, tube et manomètre.

Dinamometro completo in scatola di plastica, composto da 3 perette (piccola, media, grande) con raccordo conico, tubo e manometro



1/2

18-0158
 1,5 m, 60"

Maßband aus Wachstuch, mit Millimeter-Einteilung, in Kunststoffgehäuse

Tape measure of oilcloth, graduated in millimeters, in plastic case

Cinta métrica de tela encerada, graduada en milímetros, en caja de plástico

Ruban métrique toile cirée en boîtier plastique

Nastro metrico di tela in millimetri in scatola di plastica

► **18-0160**
 2 m, 80"

Stahlmaßband mit Millimeter-Einteilung, in Metallgehäuse

Steel tape measure, graduated in millimeters, in metal case

Cinta métrica de acero, graduada en milímetros, en caja de metal

Ruban métrique acier en boîtier métal

Nastro metrico di acciaio, in millimetri in scatola di metallo

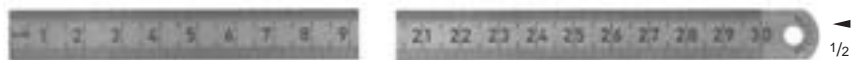

1/2

18-0161 15 cm, 6"

18-0164 20 cm, 8"

► **18-0162** 30 cm, 12"

18-0163 50 cm, 20"

Stahl-Maßstäbe, mit Millimeter-Einteilung

Steel rules, graduated in millimeters

Regla graduada en milímetros

Règle en acier, graduée en millimètres

Righe graduate in acciaio, millimetri



1/2

18-0165
 50 cm, 20"

Röntgen-Maßstab, mit Millimeter-Einteilung

Ruler for x-ray, graduated in millimeters

Regla graduada en milímetros para rayos-x

Règle radiologique graduée en millimètres

Riga graduata per misure radiologiche, in millimetri



Meßbereich: 15 mm
 Measuring range: 15 mm
 Alcance de medición: 15 mm
 Calibre: 15 mm
 Campo di misura: 15 mm



CASTROVIEJO
 63-1800
 8 cm, 3 1/8"

Zirkel
 Caliper
 Compás
 Compas
 Compasso

Meßbereich: 20 mm
 Measuring range: 20 mm
 Alcance de medición: 20 mm
 Calibre: 20 mm
 Campo di misura: 20 mm



CASTROVIEJO
 63-1801
 8 cm, 3 1/8"

Zirkel
 Caliper
 Compás
 Compas
 Compasso

Meßbereich: 40 mm
 Measuring range: 40 mm
 Alcance de medición: 40 mm
 Calibre: 40 mm
 Campo di misura: 40 mm



CASTROVIEJO
 18-0147
 9 cm, 3 1/2"

Zirkel
 Caliper
 Compás
 Compas
 Compasso

Meßbereich: 40 mm
 Measuring range: 40 mm
 Alcance de medición: 40 mm
 Calibre: 40 mm
 Campo di misura: 40 mm



CASTROVIEJO
 18-0148
 17 cm, 6 3/4"

Zirkel
 Caliper
 Compás
 Compas
 Compasso



Meßbereich: 180°
 Measuring range: 180°
 Alcance de medición: 180°
 Calibre: 180°
 Campo di misura: 180°

MÖLTGEN
 18-0140
 23 cm, 9"

Winkelmesser für Gliedmaßen
 Goniometer (flexometer)
 Goniómetro para extremidades
 Goniomètre pour les membres
 Goniometro per le membra



Meßbereich: 155 mm
 Measuring range: 155 mm
 Alcance de medición: 155 mm
 Calibre: 155 mm
 Campo di misura: 155 mm

18-0167
 23,5 cm, 9 1/4"

Schieblehre
 Caliper
 Calibrador
 Pied à coulisse
 Calibratore



Binokulare Kopflupen
 Binocular Head Magnifiers
 Lupas frontales binoculares
 Loupes binoculaires frontales
 Lenti binoculari frontali



BERGER
18-0241

Binokulare Kopflupe, mit 2 auswechselbaren prismatischen Linsen, Vergrößerung 2,5x (bei ca. 130 mm Arbeitsabstand = 7 Dioptrien), in weißemaltem Metallgehäuse, mit verstellbarem Federstahl-Stirnband.

Binocular head magnifier with 2 interchangeable prismatic lenses, magnification 2.5x (at a working distance of about 130 mm = 7 diopters), in white enamelled metal frame, with adjustable spring-steel head band.

Lupa frontal binocular con 2 lentes prismáticas intercambiables, aumento 2,5x (con distancia de observación de aprox. 130 mm = 7 dioptrías), en montura esmaltada en blanco, con cinta de acero de resorte regulable.

Loupe binoculaire frontale, avec 2 lentilles prismatiques interchangeables agrandissement 2,5x (à une distance d'observation de 130 mm environ = 7 dioptries), monture métallique, vernie émail blanc, avec bandeau frontal en acier à ressort.

Lente binoculare frontale, con 2 lenti prismatiche intercambiabili, ingrandimento: 2,5x (a una distanza d'osservazione di circa mm. 130 = 7 diottrie) in montatura metallica smaltata bianca, con fascia frontale in acciaio a molla.



BERGER
18-0243

Binokulare Kopflupe, mit 2 auswechselbaren prismatischen Linsen, Vergrößerung 2,5x (bei ca. 130 mm Arbeitsabstand = 7 Dioptrien), in weißemaltem Metallgehäuse, **aufklappbar**, mit verstellbarem Federstahl-Stirnband.

Binocular head magnifier with 2 interchangeable prismatic lenses, magnification 2.5x (at a working distance of about 130 mm = 7 diopters), in white enamelled metal frame, **swivel**, with adjustable spring-steel head band.

Lupa frontal binocular con 2 lentes prismáticas intercambiables, aumento 2,5x (con distancia de observación de aprox. 130 mm = 7 dioptrías), en montura esmaltada en blanco, **móvil**, con cinta de acero de resorte regulable.

Loupe binoculaire frontale, avec 2 lentilles prismatiques interchangeables agrandissement 2,5x (à une distance d'observation de 130 mm environ = 7 dioptries), monture métallique, vernie émail blanc, **escamotable**, avec bandeau frontal en acier à ressort.

Lente binoculare frontale, con 2 lenti prismatiche intercambiabili, ingrandimento: 2,5x (a una distanza d'osservazione di circa mm. 130 = 7 diottrie) in montatura metallica smaltata bianca, **ruotabile**, con fascia frontale in acciaio a molla.

Ersatzteile • Spare parts • Piezas de repuesto • Pieces de rechange • Pezzi di ricambio



Vergrößerung Magnification Aumento Agrandissement Ingrandimento	Arbeitsabstand (mm = Dioptrien) Working distance (mm = diopters) Distancia de observación (mm = dioptrías) Distance d'observation (mm = dioptries) Distanza d'osservazione (mm = diottrie)
---	--

18-0244	1,5	220 mm = 4 dioptr.
18-0245	2,0	170 mm = 5 1/2 dioptr.
18-0246	2,5	130 mm = 7 dioptr.
18-0247	3,0	100 mm = 8 1/2 dioptr.

Optik mit 2 Linsen für BERGER Kopflupen
 Twinlenses for BERGER binocular head magnifiers
 Lente doble para lupas binoculares frontales de BERGER
 Optique avec 2 lentilles pour loupe binoculaire de BERGER
 Ottica con 2 lenti per lenti binoculari frontali BERGER

Binokulare Lupenbrille
 Binocular Magnifying Spectacles
 Gafas de lupa binocular
 Lunettes à loupes binoculaires
 Occhiali a lenti binoculari

Binokulare Kopflupe
 Binocular Head Magnifier
 Lupa frontal binocular
 Loupe binoculaire frontale
 Lente binoculare frontale



flexibler Bügel
 malleable bow
 arco flexible
 branche flexible
 arco flessibile

18-0250

Binokulare Lupenbrille, bestehend aus Brillengestell und Lupe, Vergrößerung 1,8x, Arbeitsabstand ca. 40 cm, Gesichtsfeld ca. ø 10 cm, Augenabstand sowie Blickfeld sind verstellbar.

Binocular magnifying glass spectacles, consisting of spectacle frame and loupe, magnifying 1.8x, free working distance 40 cm approx., vision field ø 10 cm, working distance and size of field adjustable.

Gafas de lupa binocular, compuesta de montura y lupa, aumento 1,8x, distancia de observación de aprox. 40 cm, campo de visión ø 10 cm aprox., distancia y campo ajustable.

Lunettes à loupe binoculaire, composées de la monture et de la loupe, agrandissement 1,8x, distance d'observation 40 cm environ, champ de vision ø 10 cm environ, l'écart interpupillaire ainsi que le champ de vision sont réglables.

Occhiali a lenti binoculari, composti di montatura e lente, ingrandimento 1,8x, distanza di osservazione circa 40 cm, campo visivo ø 10 cm circa, la distanza fra gli occhi e campo visivo è regolabile.



18-0252

Binokulare Kopflupe, bestehend aus schwarzem Stirnband aus Celluloid und Lupe, Vergrößerung 1,8x, Arbeitsabstand ca. 40 cm, Gesichtsfeld ca. ø 10 cm, Augenabstand sowie Blickfeld sind verstellbar.

Binocular head magnifier, consisting of headband of black celluloid and magnifying glass, magnifying 1.8x, free working distance 40 cm approx., vision field ø 10 cm, working distance and size of field adjustable.

Lupa frontal binocular, compuesta de cinta frontal de celuloide negro y lupa, aumento 1,8x, distancia de observación de aprox. 40 cm, campo de visión ø 10 cm aprox., distancia y campo ajustable.

Loupe binoculaire frontale, composée d'un bandeau frontal noir en cellulose et loupe, agrandissement 1,8x, distance d'observation 40 cm environ, champ de vision ø 10 cm environ, l'écart interpupillaire ainsi que le champ de vision sont réglables.

Lente binoculare frontale, composta da fascia frontale di cellulose nera e lente, ingrandimento 1,8x, distanza di osservazione circa 40 cm, campo visivo ø 10 cm circa, la distanza fra gli occhi e campo visivo è regolabile.

Ersatzteile • Spare parts • Piezas de repuesto • Pieces de rechange • Pezzi di ricambio



18-0255

Lupe allein, Vergrößerung 1,8x, für 18-0250 und 18-0252
 Magnifying glass only, magnifying 1.8x, for 18-0250 and 18-0252
 Lente de aumento suelta, aumento 1,8x, para 18-0250 y 18-0252
 Loupe seule, agrandissement 1,8x, pour 18-0250 et 18-0252
 Lente sola, ingrandimento 1,8x, per 18-0250 e 18-0252



18-0260

2 Zusatzlinsen, Vergrößerung 2,0x, für 18-0250 - 18-0255
 2 Accessory lenses, magnifying 2.0x, for 18-0250 - 18-0255
 2 Lentes adicionales, aumento 2,0x, para 18-0250 - 18-0255
 2 lentilles supplémentaires agrandissement 2,0x pour 18-0250 - 18-0255
 2 lenti addizionali, ingrandimento 2,0x per 18-0250 - 18-0255

18-0257

2 Zusatzlinsen, Vergrößerung 2,5x, für 18-0250 - 18-0255
 2 Accessory lenses, magnifying 2.5x, for 18-0250 - 18-0255
 2 Lentes adicionales, aumento 2,5x, para 18-0250 - 18-0255
 2 lentilles supplémentaires agrandissement 2,5x pour 18-0250 - 18-0255
 2 lenti addizionali, ingrandimento 2,5x per 18-0250 - 18-0255



Stirnspiegel
Head Mirrors
Espejos frontales
Miroirs frontaux
Specchi frontali



ZIEGLER
18-0200
ø 90 mm

Reflexspiegel, komplett, bestehend aus:
18-0220 1 Stirnspiegel ø 90 mm, mit Gummifassung
18-0210 1 Stirnband aus schwarzem Plastik, mit Kugelgelenk

Head mirror, complete, consisting of:
18-0220 1 Head mirror ø 90 mm, with rubber coating
18-0210 1 Head band of black plastic, with ball-and-socket joint

Espejo frontal, completo, compuesto de:
18-0220 1 Espejo frontal ø 90 mm, con montura de goma
18-0210 1 Cinta frontal de plástico negro, con articulación esférica

Miroir frontal, complet, composé de:
18-0220 1 Miroir frontal d'un ø de 90 mm, avec monture caoutchouc
18-0210 1 Bandeau articulé en plastique noir

Specchio frontale, composto di:
18-0220 1 Specchio frontale ø 90 mm, con incastratura di gomma
18-0210 1 Fascia frontale di materia plastica nera, con sondo sferico

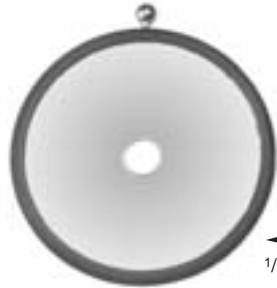

ZIEGLER
► 18-0220 ø 90 mm
18-0221 ø 100 mm

Stirnspiegel allein, mit Gummifassung

Head mirrors only, with rubber coating

Espejos frontales sueltos, con montura de goma

Miroir frontal, seul, avec monture caoutchouc

Specchi frontali, solo, con incastratura di gomma



18-0213

Gelenk allein, für Stirnband und -spiegel

Joint only, for head band and mirror

Articulación suelta, para cinta y espejo frontal

Articulation, seule, pour bandeau et miroir frontal

Snodo sferico solo, per fascia frontale e specchio frontale



ZIEGLER
18-0210

Stirnband aus schwarzem Plastik, mit Gelenk
Head band of black plastic, with joint
Cinta de plástico negro, con articulación
Bandeau frontal plastique noir, avec articulation
Fascia frontale di materia plastica nera, con snodo sferico



MURPHY
18-0211

Stirnband aus weißem Celluloid, mit Gelenk
Head band of white celluloid, with joint
Cinta de celuloide blanco, con articulación
Bandeau frontal en celluloid blanc, avec articulation
Fascia frontale di celluloido bianca, con snodo sferico

Stirnlampen für Schwachstrom
 Head Lamps for low voltage current
 Lámparas frontales para corriente de baja tensión
 Eclairage frontal pour courant à basse tension
 Lampada frontale con energia elettrica a bassa tensione



CLAR
 18-0301

Stirnlampe (6 Volt), komplett mit Reflektor ø 55 mm, verstellbarem Gelenk, weißem Stirnband aus Celluloid, Schaumgummipolsterung und Kabel mit Zwischenstecker zu Trafo 18-0325.

Head light (6 volts), complete with mirror ø 55 mm, adjustable joint, white celluloid head band, foam rubber pad and cord with plugs for transformer 18-0325.

Lámpara frontal (6 voltios), completa con reflector ø 55 mm, articulación regulable, cinta frontal de celuloide, almohadilla de goma-espuma y cable con enchufe intermedio para transformador 18-0325.

Eclaireur frontal (6 volts), complet avec réflecteur ø 55 mm, articulation réglable, bandeau frontal en celluloid blanc, coussin en caoutchouc mousse, et cordon avec fiche intermédiaire pour transformateur 18-0325.

Lampada (6 volt), completa con specchio riflettore ø 55 mm, sondo regolabile, fascia frontale bianca di celuloide, imbottitura frontale e cavo con spina intermedia per trasformatore 18-0325.

Ersatzteile • Spare parts • Piezas de repuesto
 Pièces de rechange • Pezzi di ricambio

18-0304

Reflektor ø 55 mm
 Mirror ø 55 mm
 Reflector ø 55 mm
 Réflecteur ø 55 mm
 Riflettore ø 55 mm

18-0307

Ersatzbirne 6 Volt
 Spare bulb, 6 volts
 Bombilla de repuesto, 6 voltios
 Lampe de rechange, 6 volts
 Lampadina di ricambio, 6 volt

18-0305

Stirnband aus weißem Celluloid, mit Kabelaschen und Schaumgummipolsterung
 Head band of white celluloid, with cable clips and foam rubber pad
 Cinta frontal de celuloide blanco con bridas de cable y almohadilla de goma-espuma
 Bandeau frontal en celluloid blanc, anses pour le cordon et coussin en caoutchouc mousse.
 Fascia frontale di celuloide bianca, porta-cordini e imbottitura frontale

18-0308

Ersatz-Schaumgummipolsterung für Stirnband
 Spare foam rubber pad for head band
 Almohadilla de goma-espuma de repuesto para cinta frontal
 Coussin en caoutchouc de rechange pour bandeau frontal
 Imbottitura frontale per fascia frontale



JANSEN
 18-0335

Stirnlampe (6 Volt), komplett mit verstellbarem Fokus und Gelenk, schmalen Stirnband aus weißem Celluloid und Kabel mit Zwischenstecker zu Trafo 18-0325.

Head lamp (6 volts), complete with adjustable focus and joint, narrow head band of white celluloid and cord with plugs for transformer 18-0325.

Lámpara frontal (6 voltios), completa con foco regulable y articulación, cinta frontal estrecha y blanca de celuloide y cable con enchufe intermedio para transformador 18-0325.

Eclaireur frontal (6 volts), complet avec foyer réglable et articulation, bandeau frontal en celluloid blanc, et cordon avec fiche intermédiaire pour transformateur 18-0325.

Lampada (6 volt), completa con messa a fuoco regolabile, sondo, fascia frontale bianca di celuloide, imbottitura frontale e cavo con spina intermedia per trasformatore 18-0325.

18-0303

Ersatzbirne 6 Volt
 Spare bulb, 6 volts
 Bombilla de repuesto, 6 voltios
 Lampe de rechange, 6 volts
 Lampadina di ricambio, 6 volt



18-0325

Klein-Transformator für 220 Volt Wechselstrom, mit Gummikabel und Steckbuchse für Schwachstrom, stufenlos regelbar 0-10 Volt.

Mini-transformer unit for 220 volts alternating current, with cable and outlet for low voltage current, infinitely variable from 0-10 volts.

Transformador eléctrico pequeño para 220 voltios corriente alterna, con cable y borne para corriente de baja tensión, regulador sin escalones desde 0-10 voltios.

Petit transformateur fonctionnant sur 220 volts, C.A., avec cordon en caoutchouc et fiches pour courant à basse tension, réglage continu 0-10 volts.

Mini-trasformatore elettrico, per 220 volt, corrente alternata a bassa tensione, regolazione continua da 0-10 volt.



Zungenspatel
Tongue Depressors
Depresor lingual
Abaisse-langues
Abbassalingua



80-0372
14 cm, 5 1/2"



80-0370
14,5 cm, 5 3/4"

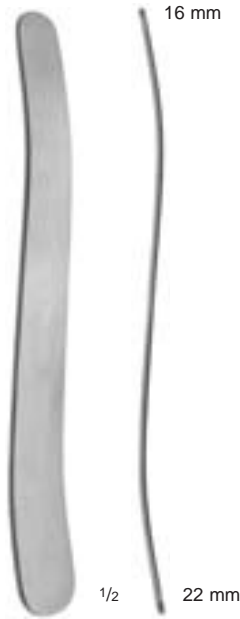

MAYO
80-0373
16 cm, 6 1/4"

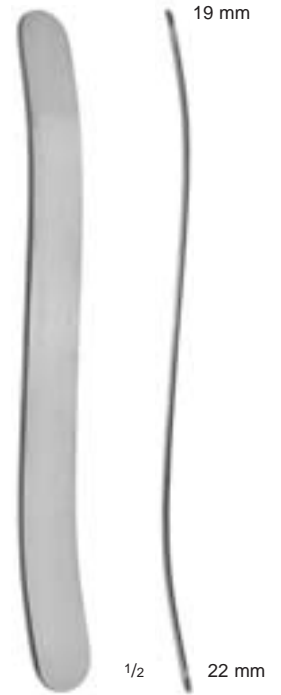

BUCHWALD
80-0376
18 cm, 7"

aus Holz, in Packung zu 100 Stück
of wood, in package of 100 pieces
de madera, en paquete de 100 piezas
en bois, en paquet de 100 pièces
di legno, per 100 pezzi

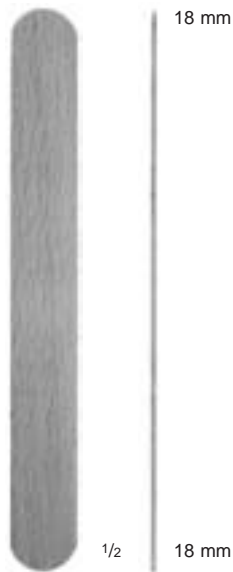

80-0377
15 cm, 6"

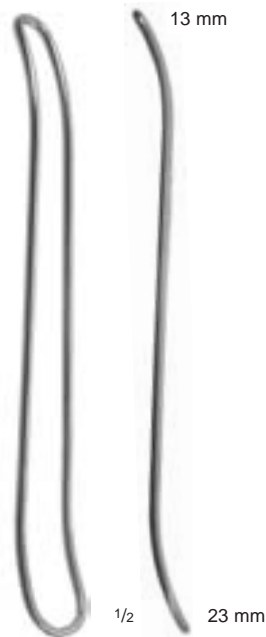

FRENZEL
80-0379
16,5 cm, 6 1/2"



BRUENINGS
80-0378
19 cm, 7 1/2"

Kehlkopfspiegel
Laryngeal Mirrors
Espejos laríngeos
Miroirs laryngiens
Specchi laringei

Metallgriffe
Metal Handles
Mangos metálicos
Manches en métal
Manici metallici

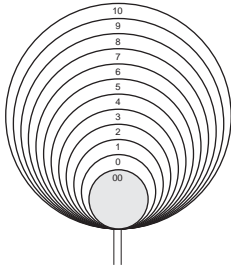

- 85-1100 Fig.00 = \varnothing 8 mm
 - 85-1101 Fig. 0 = \varnothing 10 mm
 - 85-1102 Fig. 1 = \varnothing 12 mm
 - 85-1103 Fig. 2 = \varnothing 14 mm
 - 85-1104 Fig. 3 = \varnothing 16 mm
 - 85-1105 Fig. 4 = \varnothing 18 mm
 - 85-1106 Fig. 5 = \varnothing 20 mm
 - 85-1107 Fig. 6 = \varnothing 22 mm
 - 85-1108 Fig. 7 = \varnothing 24 mm
 - 85-1109 Fig. 8 = \varnothing 26 mm
 - ▶ 85-1110 Fig. 9 = \varnothing 28 mm
 - 85-1111 Fig.10 = \varnothing 30 mm
- 13,0 – 14,5 cm, 5¹/₈ – 5³/₄"

Kehlkopfspiegel ohne Griff
Laryngeal mirrors without handle
Espejos laríngeos sin mango
Miroirs laryngiens sans manche
Specchi laringei senza manico



85-1132
9,5 cm, 3³/₄"

Metallgriff für Kehlkopfspiegel
85-1100 – 85-1111

Metal handle for laryngeal mirrors
85-1100 – 85-1111

Mango metálico para espejos laríngeos
85-1100 – 85-1111

Manche en métal pour miroirs laryngiens
85-1100 – 85-1111

Manici metallici per specchi laringei
85-1100 – 85-1111



85-1130
11 cm, 4³/₈"

Metallgriff für Kehlkopfspiegel
85-1100 – 85-1111

Metal handle for laryngeal mirrors
85-1100 – 85-1111

Mango metálico para espejos laríngeos
85-1100 – 85-1111

Manche en métal pour miroirs laryngiens
85-1100 – 85-1111

Manici metallici per specchi laringei
85-1100 – 85-1111



Kehlkopfspiegel
Laryngeal Mirrors
Espejos laríngeos
Miroirs laryngiens
Specchi laringei

Rhinoskopiespiegel
Rhinoscopic Mirrors
Espejos rinoscópicos
Miroirs pour rhinoscopie
Specchi per rinoscopia

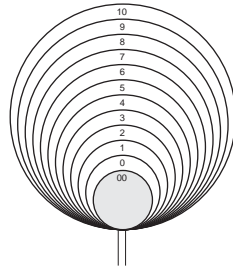
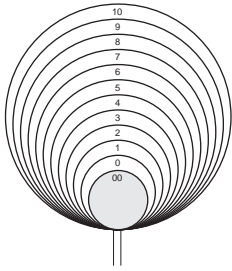

85-0149
ø 10 mm



▶ 85-0150
ø 12 mm



85-0151
ø 14 mm



85-0152
ø 16 mm



MICHEL
85-0149

- 85-0152
27,0 – 28,0 cm, 10^{3/4} – 11^{1/4}“

Rhinoskopiespiegel, beweglich
Rhinoscopic mirrors, moveable
Espejos rinoscópicos, movable
Miroirs pour rhinoscopie, mobiles
Specchi per rinoscopia, mobili

- 85-0120 Fig.00 = ø 8 mm
 - 85-0121 Fig. 0 = ø 10 mm
 - 85-0122 Fig. 1 = ø 12 mm
 - 85-0123 Fig. 2 = ø 14 mm
 - 85-0124 Fig. 3 = ø 16 mm
 - 85-0125 Fig. 4 = ø 18 mm
 - 85-0126 Fig. 5 = ø 20 mm
 - 85-0127 Fig. 6 = ø 22 mm
 - ▶ 85-0128 Fig. 7 = ø 24 mm
 - 85-0129 Fig. 8 = ø 26 mm
 - 85-0130 Fig. 9 = ø 28 mm
 - 85-0131 Fig.10 = ø 30 mm
- 18,0 – 19,5 cm, 7 – 7^{3/4}“

Kehlkopfspiegel mit festem Griff
Laryngeal mirrors with fixed handle
Espejos laríngeos con mango fijo
Miroirs laryngiens avec manche fixe
Specchi laringei con manico fisso

- 85-0100 Fig.00 = ø 8 mm
 - 85-0101 Fig. 0 = ø 10 mm
 - 85-0102 Fig. 1 = ø 12 mm
 - 85-0103 Fig. 2 = ø 14 mm
 - 85-0104 Fig. 3 = ø 16 mm
 - 85-0105 Fig. 4 = ø 18 mm
 - 85-0106 Fig. 5 = ø 20 mm
 - ▶ 85-0107 Fig. 6 = ø 22 mm
 - 85-0108 Fig. 7 = ø 24 mm
 - 85-0109 Fig. 8 = ø 26 mm
 - 85-0110 Fig. 9 = ø 28 mm
 - 85-0111 Fig.10 = ø 30 mm
- 22,0 – 23,5 cm, 8^{3/4} – 9^{1/4}“

Kehlkopfspiegel mit festem Griff
Laryngeal mirrors with fixed handle
Espejos laríngeos con mango fijo
Miroirs laryngiens avec manche fixe
Specchi laringei con manico fisso



LAWNTON

Medizintechnik



Vorbereitung, Dermatologie
Preparation, Dermatology
Preparación, Dermatología
Préparation, Dermatologie
Preparazione, Dermatologia



Nagelhautscheren
Cuticle Scissors
Tijeras cuticulares
Ciseaux à envies
Forbici per la cuticola

Nagelscheren
Nail Scissors
Tijeras para uñas
Ciseaux à ongles
Forbici per unghie



► 19-0399
8,5 cm, 3³/₈"

19-0400
8,5 cm, 3³/₈"

19-0399
- 19-0400

Nagelhautscheren
Cuticle scissors
Tijeras cuticulares
Ciseaux à envies
Forbici per la cuticola



► 19-0402
9,5 cm, 3³/₄"

19-0403
9,5 cm, 3³/₄"

19-0402
- 19-0403

Nagelscheren
Nail scissors
Tijeras para uñas
Ciseaux à ongles
Forbici per unghie

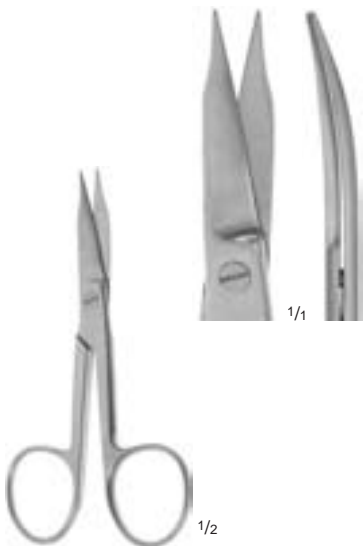

19-0460
10 cm, 4"

Nagelschere
Nail scissors
Tijera para uñas
Ciseaux à ongles
Forbici per unghie



19-0483
10,5 cm, 4¹/₈"

Nagelschere
Nail scissors
Tijera para uñas
Ciseaux à ongles
Forbici per unghie

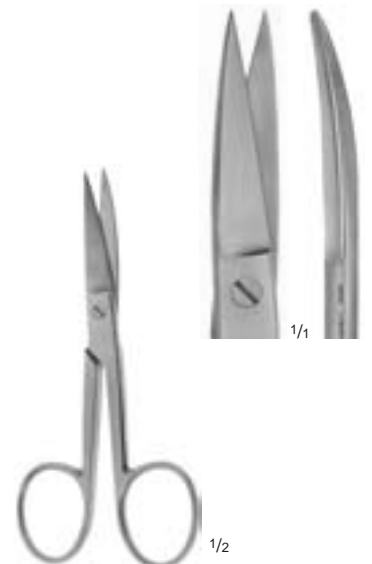

19-0487
10,5 cm, 4¹/₈"

Nagelschere
Nail scissors
Tijera para uñas
Ciseaux à ongles
Forbici per unghie

Nagelhautzangen
 Cuticle Nippers
 Pinzas cuticulares
 Pincès à envies
 Tronchesine per la cuticola

Nagelzangen
 Nail Nippers
 Pinzas corta-uñas
 Pincès à ongles
 Tronchesine per unghie



19-0358
 10,5 cm, 4 1/8"

Nagelhautzange
 Cuticle nipper
 Pinza cuticular
 Pincès à envies
 Tonchesina per la cuticola



19-0360
 10,5 cm, 4 1/8"

Nagelhautzange
 Cuticle nipper
 Pinza cuticular
 Pincès à envies
 Tonchesina per la cuticola



19-0305
 12,5 cm, 5"

Nagelspaltzange
 Nail splitter forceps
 Pinza corta-uñas
 Pincès à ongles
 Tonchesina per unghie



19-0325
 14 cm, 5 1/2"

Nagelzange
 Nail nipper
 Pinza corta-uñas
 Pincès à ongles
 Tonchesina per unghie

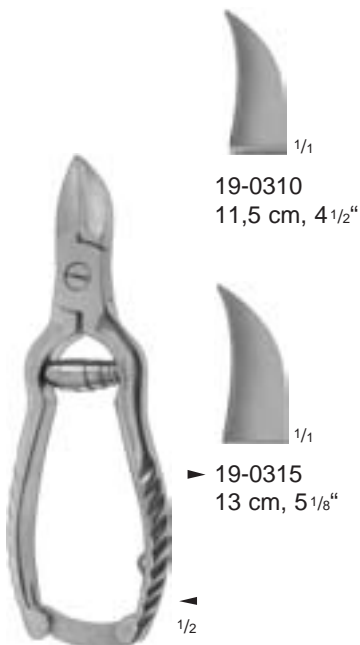

19-0310
 11,5 cm, 4 1/2"

▶ 19-0315
 13 cm, 5 1/8"

19-0310
 - 19-0315

Nagelzangen
 Nail nippers
 Pinzas corta-uñas
 Pincès à ongles
 Tonchesina per unghie



19-0302
 13 cm, 5 1/8"

Nagelzange
 Nail nipper
 Pinza corta-uñas
 Pincès à ongles
 Tonchesina per unghie

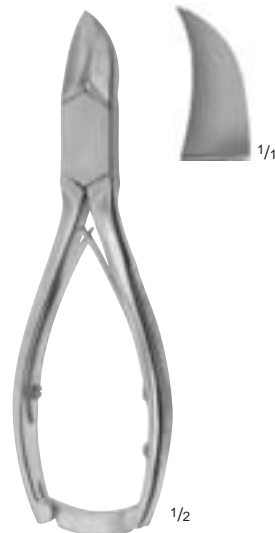

19-0300
 14 cm, 5 1/2"

Nagelzange
 Nail nipper
 Pinza corta-uñas
 Pincès à ongles
 Tonchesina per unghie

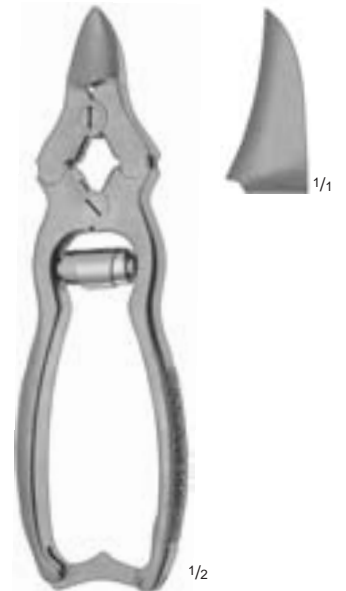

19-0307
 15,5 cm, 6"

Nagelzange
 Nail nipper
 Pinza corta-uñas
 Pincès à ongles
 Tonchesina per unghie



Nagelfeilen
Nail Files
Limas para uñas
Limes à ongles
Lime per le unghie

Schwesterngarnitur
Set for Nurses
Surtido para enfermeras
Etui pour infirmières
Necessario per infermiera



19-0517
11 cm, 4 3/8"

Nagelfeile
Nail file
Lima para uñas
Lime à ongles
Lima per unghie



19-0521 10 cm, 4"
▶ 19-0522 12 cm, 4 3/4"

Nagelfeilen
Nail files
Limas para uñas
Limes à ongles
Lime per unghie



19-0530
13 cm, 5 1/8"

Nagelfeile mit Diamantstaub belegt, mit Kunststoffgriff

Diamond cover coated nail file, with plastic handle

Lima para uñas cubierta con polvo de diamante, con mango de plástico

Lime à ongles revêtue de diamant indestructible, avec manche en plastique

Lima per unghie diamantata, con manico di plastica



19-0410

Schwesterngarnitur, 2-teilig in Plastiketui, bestehend aus 1 Nagelschere (19-0403), 1 Nagelfeile (19-0521) und 1 Kette, 35 cm lang.

Set for nurses, two part in plastic case, consisting of: 1 nail scissors (19-0403), 1 nail file (19-0521) and 1 chain, 35 cm long.

Surtido para enfermeras, de 2 piezas en estuche de plástico, compuesto de 1 tijera de uñas (19-0403), 1 lima de uñas (19-0521) y 1 cadena, 35 cm de larga.

Etui pour infirmières, en 2 parties, étui en matière plastique contenant 1 ciseaux à ongles (19-0403), 1 lime à ongles (19-0521) et 1 chaîne, 35 cm de long.

Necessario per infermiera, in busta di plastica, composto di: 1 forbici per unghie (19-0403), 1 lima per unghie (19-0521) e 1 catena, lunghezza 35 cm

Lupusschaber
Lupus Scraper
Legra para lupus
Grattoir pour lupus
Cucchiaio per lupus

Komedonenquetscher
Comedo Extractors
Saca-comedones
Tire-comédons
Tiracomedoni



VIDAL
19-0230
14 cm, 5 1/2"

Lupusschaber
Lupus scraper
Legra para lupus
Grattoir pour lupus
Cucchiaio per lupus

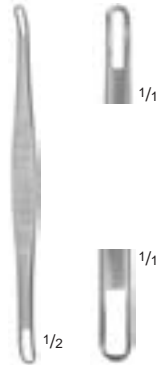

SCHAMBERG
19-0130
9,5 cm, 3 3/4"

Komedonenquetscher
Comedo extractor
Saca-comedones
Tire-comédons
Tiracomedoni



UNNA
19-0101
13,5 cm, 5 1/4"

Komedonenquetscher
Comedo extractor
Saca-comedones
Tire-comédons
Tiracomedoni



UNNA
19-0100
14,5 cm, 5 3/4"

Komedonenquetscher
Comedo extractor
Saca-comedones
Tire-comédons
Tiracomedoni

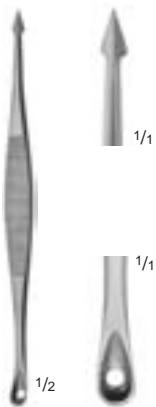

SAALFELD
19-0120
10,5 cm, 4 1/8"

Komedonenquetscher, mit Lanze
Comedo extractor, with lancet
Saca-comedones, con lanceta
Tire-comédons, avec lancette
Tiracomedoni, con lancetta

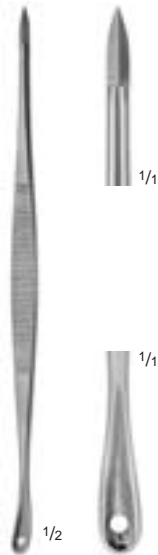

SAALFELD
19-0125
14,5 cm, 5 3/4"

Komedonenquetscher, mit Messer
Comedo extractor, with acne knife
Saca-comedones, con escarificador
Tire-comédons, avec couteau
Tiracomedoni, con cucchiaio



KATSCH
19-0110
14,5 cm, 5 3/4"

Komedonenquetscher, mit Lanze
Comedo extractor, with lancet
Saca-comedones, con lanceta
Tire-comédons, avec lancette
Tiracomedoni, con lancetta



UNNA-VIDAL
19-0135
18 cm, 7"

Komedonenquetscher, mit Nadel, umschraubbar
Comedo extractor, with needle, reversible
Saca-comedones, con aguja, reversible
Tire-comédons, avec aiguille, reversible
Tiracomedoni, con ago, reversibile



Lupusküretten
Lupus Currettes
Curetas para lupus
Curettes pour les lupus
Raschiatoio per lupus

Hautstanzen
Dermal Punches
Trépanos cutáneos
Trépanos cutanés
Trapani dermatici

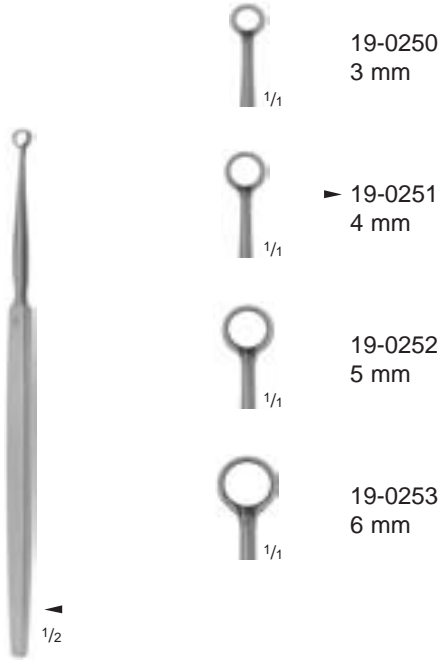

FOX
19-0250
- 19-0253
14 cm, 5 1/2"

Lupusküretten
Lupus curettes
Curetas para lupus
Curettes pour les lupus
Raschiatoio per lupus

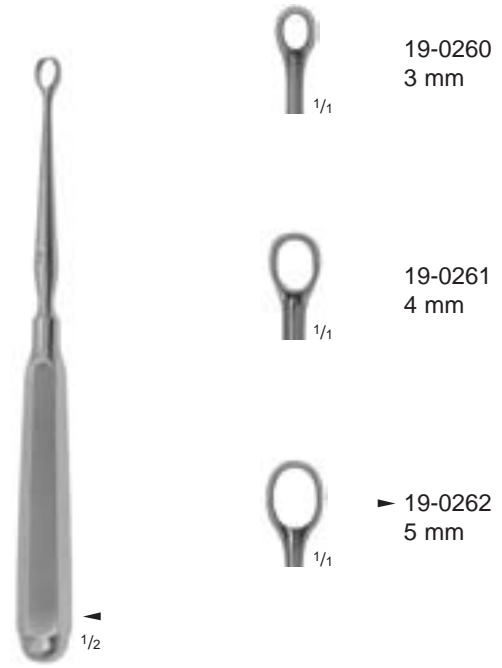

PIFFARD
19-0260
- 19-0262
16 cm, 6 1/4"

Lupusküretten
Lupus curettes
Curetas para lupus
Curettes pour les lupus
Raschiatoio per lupus

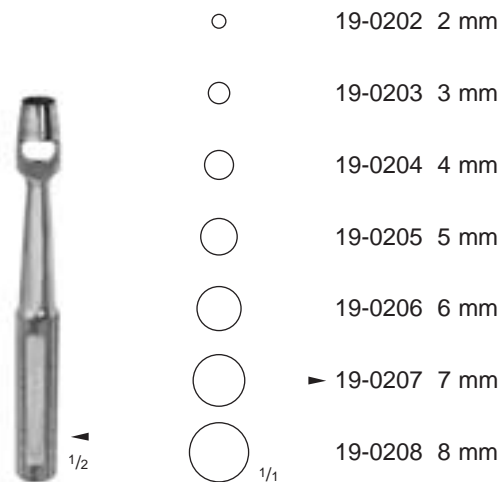

KEYES
19-0202
- 19-0208
10 cm, 4"

Hautstanzen
Dermal punches
Trépanos cutáneos
Trépanos cutanés
Trapani dermatici

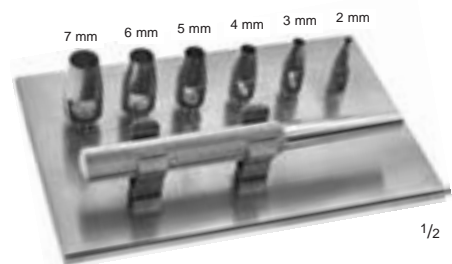

KEYES
19-0210

Hautstanzbesteck, komplett, mit 6 auswechselbaren Aufsätzen, Griff und Gestell

Dermal punch set, complete, with 6 interchangeable tips, handle and rack

Juego de trépanos cutáneos, completo con 6 insertadas intercambiables, mango y bastidor

Jeu de trépanos cutanés, complet, avec 6 embouts interchangeables, manche et support

Strumentario per trapanazione della pelle, completo di 6 teste punzonatrici intercambiabili, manico, su sostegno



LAWNTON
Medizintechnik



Narkose
Anaesthesia
Anestesia
Anesthésie
Anestesia



Mundkeil
Oral Screw
Garrote
Bâillon
Apribocca

Mundsperrer
Mouth Gags
Abre-bocas
Ouvre-bouches
Apriboccas



Ø 32 mm

1/2

MAUNDER
80-0275
9,5 cm, 3 3/4"

Mundkeil aus Holz
Oral screw of wood
Garrote de madera
Bâillon en bois
Apribocca di legno



1/2

HEISTER
80-0105
13 cm, 5 1/8"

Mundsperrer
Mouth gag
Abre-boca
Ouvre-bouches
Apribocca



1/2

DENHARDT
80-0100
12,5 cm, 5"

Mundsperrer
Mouth gag
Abre-boca
Ouvre-bouches
Apribocca



1/2

ROSER-KÖNIG
80-0112
18,5 cm, 7 1/4"

Mundsperrer
Mouth gag
Abre-boca
Ouvre-bouches
Apribocca



16-0325

1 Paar Ersatzgummi
 1 pair of rubber pads
 1 par de gomas de repuesto
 1 paire de mors en caoutchouc
 1 paio di morsi di ricambio

YOUNG
 16-0320
 15,5 cm, 6"

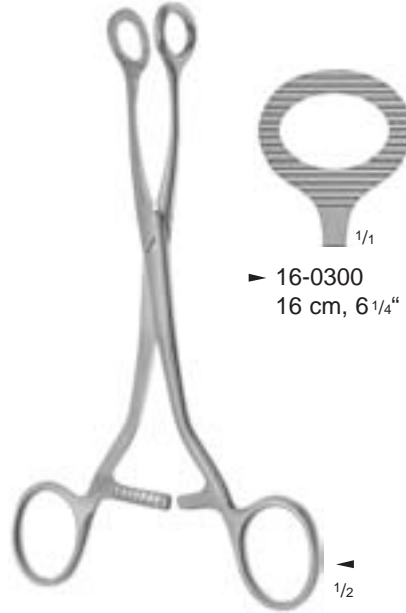

▶ 16-0300
 16 cm, 6 1/4"

16-0305
 18 cm, 7"

COLLIN
 16-0300
 - 16-0305

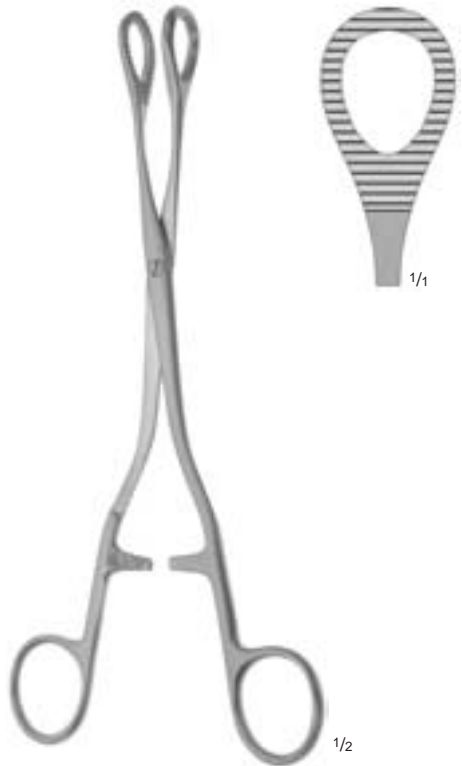

HEYWOOD-SMITH
 16-0338
 21 cm, 8 1/4"



HEYWOOD-SMITH
 16-0340
 21,5 cm, 8 1/2"



MC INTOSH Laryngoskope
 MC INTOSH Laryngoscopes
 MC INTOSH Laringoscopios
 MC INTOSH Laryngoscopes
 MC INTOSH Laringoscopi



MC INTOSH 85-0090

Laryngoskopie-Besteck, bestehend aus:
 85-0073 1 Laryngoskopie-Spatel 70/92 mm
 85-0074 1 Laryngoskopie-Spatel 90/112 mm
 85-0075 1 Laryngoskopie-Spatel 110/132 mm
 85-0098 1 Batteriegriff ø 30 mm (ohne Batterien)
 85-0099 1 Etui

Laryngoscope set, consisting of:
 85-0073 1 Laryngoscope blade 70/92 mm
 85-0074 1 Laryngoscope blade 90/112 mm
 85-0075 1 Laryngoscope blade 110/132 mm
 85-0098 1 Battery handle, ø 30 mm (without batteries)
 85-0099 1 Case

Juego para laringoscopia, compuesto de:
 85-0073 1 Espátula de laringoscopia 70/92 mm
 85-0074 1 Espátula de laringoscopia 90/112 mm
 85-0075 1 Espátula de laringoscopia 110/132 mm
 85-0098 1 Mango de pila ø 30 mm (sin pilas)
 85-0099 1 Estuche

Trousse à laryngoscopie, composée de:
 85-0073 1 Spatule pour laryngoscopie 70/92 mm
 85-0074 1 Spatule pour laryngoscopie 90/112 mm
 85-0075 1 Spatule pour laryngoscopie 110/132 mm
 85-0098 1 Poignée à piles ø 30 mm (sans piles)
 85-0099 1 Boîte

Set per laringoscopia, composto da:
 85-0073 1 Spatola per laringoscopia 70/92 mm
 85-0074 1 Spatola per laringoscopia 90/112 mm
 85-0075 1 Spatola per laringoscopia 110/132 mm
 85-0098 1 Manico per pila ø 30 mm (senza pila)
 85-0099 1 astuccio

1/3



MC INTOSH 85-0091

Laryngoskopie-Besteck, bestehend aus:
 85-0073 1 Laryngoskopie-Spatel 70/92 mm
 85-0074 1 Laryngoskopie-Spatel 90/112 mm
 85-0075 1 Laryngoskopie-Spatel 110/132 mm
 85-0076 1 Laryngoskopie-Spatel 130/152 mm
 85-0098 1 Batteriegriff ø 30 mm (ohne Batterien)
 85-0072 1 Etui

Laryngoscope set, consisting of:
 85-0073 1 Laryngoscope blade 70/92 mm
 85-0074 1 Laryngoscope blade 90/112 mm
 85-0075 1 Laryngoscope blade 110/132 mm
 85-0076 1 Laryngoscope blade 130/152 mm
 85-0098 1 Battery handle, ø 30 mm (without batteries)
 85-0072 1 Case

Juego para laringoscopia, compuesto de:
 85-0073 1 Espátula de laringoscopia 70/92 mm
 85-0074 1 Espátula de laringoscopia 90/112 mm
 85-0075 1 Espátula de laringoscopia 110/132 mm
 85-0076 1 Espátula de laringoscopia 130/152 mm
 85-0098 1 Mango de pila ø 30 mm (sin pilas)
 85-0072 1 Estuche

Trousse à laryngoscopie, composée de:
 85-0073 1 Spatule pour laryngoscopie 70/92 mm
 85-0074 1 Spatule pour laryngoscopie 90/112 mm
 85-0075 1 Spatule pour laryngoscopie 110/132 mm
 85-0076 1 Spatule pour laryngoscopie 130/152 mm
 85-0098 1 Poignée à piles ø 30 mm (sans piles)
 85-0072 1 Boîte

Set per laringoscopia, composto da:
 85-0073 1 Spatola per laringoscopia 70/92 mm
 85-0074 1 Spatola per laringoscopia 90/112 mm
 85-0075 1 Spatola per laringoscopia 110/132 mm
 85-0076 1 Spatola per laringoscopia 130/152 mm
 85-0098 1 Manico per pila ø 30 mm (senza pila)
 85-0099 1 astuccio

1/3

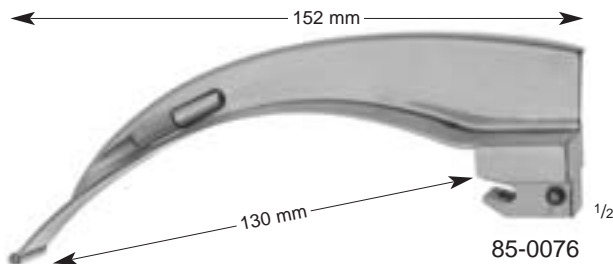
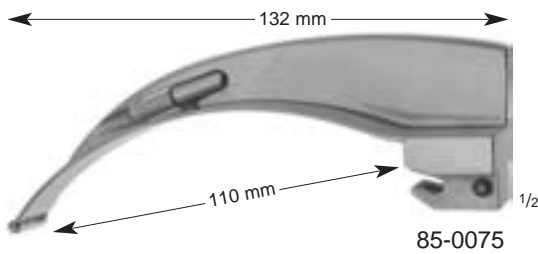
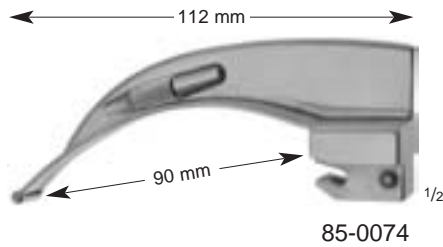
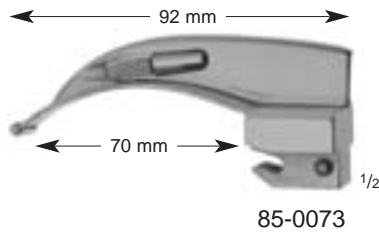
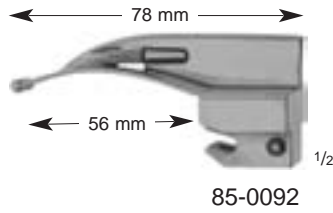
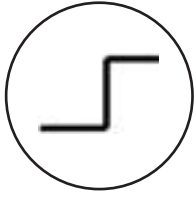

MC INTOSH
 85-0073
 - 85-0092
 Laryngoskopie-Spatel
 Laryngoscope blades
 Espátulas de laringoscopios
 Spatules de laryngoscopie
 Spatole per laringoscopi



85-0058
 2,5 V

Ersatzbirnchen für
 Laryngoskopie-Spatel
 85-0092

Spare bulb for
 laryngoscope blade
 85-0092

Bombilla de repuesto para
 espátula de laringoscopia
 85-0092

Lampe de rechange pour
 spatule de laryngoscope
 85-0092

Lampadine di ricambio per
 spatola per laringoscopia
 85-0092



85-0059
 2,5 V

Ersatzbirnchen für
 Laryngoskopie-Spatel
 85-0073 - 85-0076

Spare bulb for
 laryngoscope blades
 85-0073 - 85-0076

Bombilla de repuesto para
 espátulas de laringoscopios
 85-0073 - 85-0076

Lampe de rechange pour
 spatule de laryngoscope
 85-0073 - 85-0076

Lampadine di ricambio per
 spatola per laringoscopia
 85-0073 - 85-0076



85-0098
 14,5 cm, 5^{3/4}"

Batteriegriff ø 30 mm (2 Baby-
 Zellen, 1,5 Volt, sind erforderlich)

Battery handle, ø 30 mm (2 Baby
 batteries, 1,5 volt, are required)

Mango de pila ø 30 mm (se necesi-
 tan 2 pilas Mignon de 1,5 V)

Poignée à piles ø 30 mm (2 piles
 Mignon, 1,5 volts sont nécessaires)

Manico per pila ø 30 mm (2 pile
 Mignon di 1,5 volt sono necessarie)



85-0094
 15 cm, 6"

Batteriegriff ø 18 mm (2 Mini-
 Zellen, 1,5 Volt, sind erforderlich)

Battery handle, ø 18 mm (2 Mini
 batteries, 1,5 volt, are required)

Mango de pila ø 18 mm (se necesi-
 tan 2 pilas Mini de 1,5 V)

Poignée à piles ø 18 mm (2 piles
 Mini, 1,5 volts sont nécessaires)

Manico per pila ø 18 mm (2 pile
 Mini di 1,5 volt sono necessarie)



MC INTOSH Laryngoskope mit Kaltlicht
 MC INTOSH Laryngoscopes with Cold Light
 MC INTOSH Laringoscopios de luz fría
 MC INTOSH Laryngoscopes lumière froide
 MC INTOSH Laringoscopi luce fredda



1/3

MC INTOSH 85-0006

Laryngoskopie-Besteck, bestehend aus:

- 85-0002 1 Spatel mit Kaltlicht 70/92 mm
- 85-0003 1 Spatel mit Kaltlicht 90/112 mm
- 85-0004 1 Spatel mit Kaltlicht 110/132 mm
- 85-0009 1 Batteriegriff ø 30 mm (ohne Batterien)
- 85-0099 1 Etui

Laryngoscope set, consisting of:

- 85-0002 1 Blade with cold light 70/92 mm
- 85-0003 1 Blade with cold light 90/112 mm
- 85-0004 1 Blade with cold light 110/132 mm
- 85-0009 1 Battery handle, ø 30 mm (without batteries)
- 85-0099 1 Case

Juego para laringoscopia, compuesto de:

- 85-0002 1 Espátula con luz fría 70/92 mm
- 85-0003 1 Espátula con luz fría 90/112 mm
- 85-0004 1 Espátula con luz fría 110/132 mm
- 85-0009 1 Mango de pila ø 30 mm (sin pilas)
- 85-0099 1 Estuche

Trousse à laryngoscopie, composée de:

- 85-0002 1 Spatule lumière froide 70/92 mm
- 85-0003 1 Spatule lumière froide 90/112 mm
- 85-0004 1 Spatule lumière froide 110/132 mm
- 85-0009 1 Poignée à piles ø 30 mm (sans piles)
- 85-0099 1 Boîte

Set per laringoscopia, composto da:

- 85-0002 1 Spatola con luce fredda 70/92 mm
- 85-0003 1 Spatola con luce fredda 90/112 mm
- 85-0004 1 Spatola con luce fredda 110/132 mm
- 85-0009 1 Manico per pila ø 30 mm (senza pila)
- 85-0099 1 astuccio

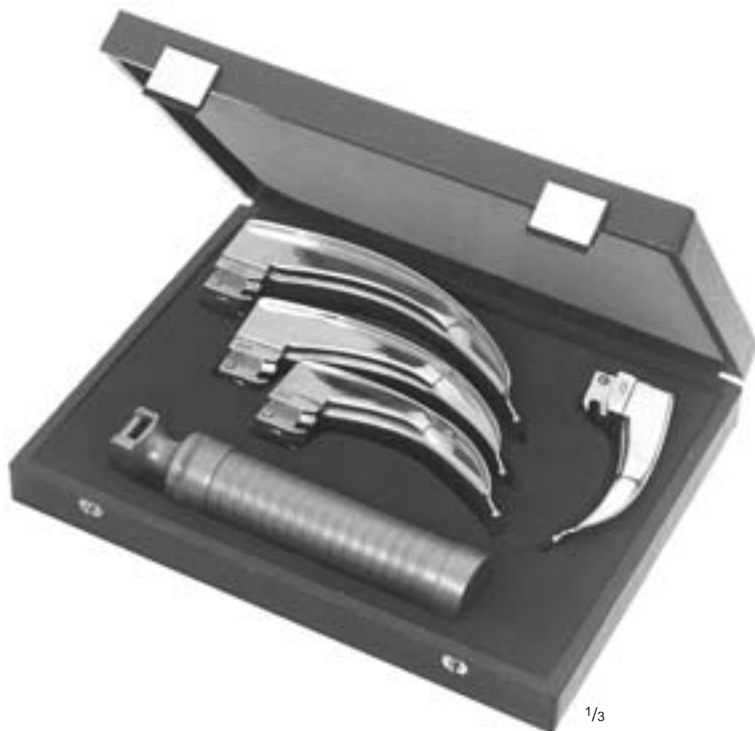

1/3

MC INTOSH 85-0007

Laryngoskopie-Besteck, bestehend aus:

- 85-0002 1 Spatel mit Kaltlicht 70/92 mm
- 85-0003 1 Spatel mit Kaltlicht 90/112 mm
- 85-0004 1 Spatel mit Kaltlicht 110/132 mm
- 85-0005 1 Spatel mit Kaltlicht 130/152 mm
- 85-0009 1 Batteriegriff ø 30 mm (ohne Batterien)
- 85-0072 1 Etui

Laryngoscope set, consisting of:

- 85-0002 1 Blade with cold light 70/92 mm
- 85-0003 1 Blade with cold light 90/112 mm
- 85-0004 1 Blade with cold light 110/132 mm
- 85-0005 1 Blade with cold light 130/152 mm
- 85-0009 1 Battery handle, ø 30 mm (without batteries)
- 85-0072 1 Case

Juego para laringoscopia, compuesto de:

- 85-0002 1 Espátula con luz fría 70/92 mm
- 85-0003 1 Espátula con luz fría 90/112 mm
- 85-0004 1 Espátula con luz fría 110/132 mm
- 85-0005 1 Espátula con luz fría 130/152 mm
- 85-0009 1 Mango de pila ø 30 mm (sin pilas)
- 85-0072 1 Estuche

Trousse à laryngoscopie, composée de:

- 85-0002 1 Spatule lumière froide 70/92 mm
- 85-0003 1 Spatule lumière froide 90/112 mm
- 85-0004 1 Spatule lumière froide 110/132 mm
- 85-0005 1 Spatule lumière froide 130/152 mm
- 85-0009 1 Poignée à piles ø 30 mm (sans piles)
- 85-0072 1 Boîte

Set per laringoscopia, composto da:

- 85-0002 1 Spatola con luce fredda 70/92 mm
- 85-0003 1 Spatola con luce fredda 90/112 mm
- 85-0004 1 Spatola con luce fredda 110/132 mm
- 85-0005 1 Spatola con luce fredda 130/152 mm
- 85-0009 1 Manico per pila ø 30 mm (senza pila)
- 85-0072 1 astuccio

MC INTOSH Laryngoskope mit Kaltlicht
 MC INTOSH Laryngoscopes with Cold Light
 MC INTOSH Laringoscopios de luz fría
 MC INTOSH Laryngoscopes lumière froide
 MC INTOSH Laringoscopi luce fredda

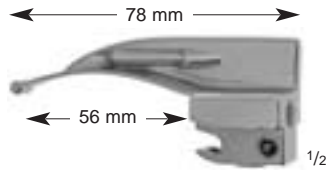
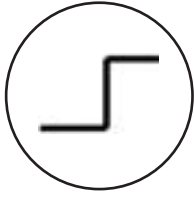

85-0001

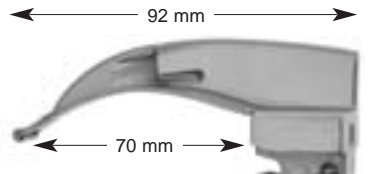

85-0002

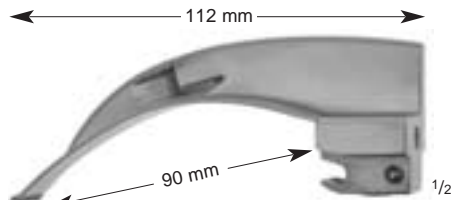

85-0003

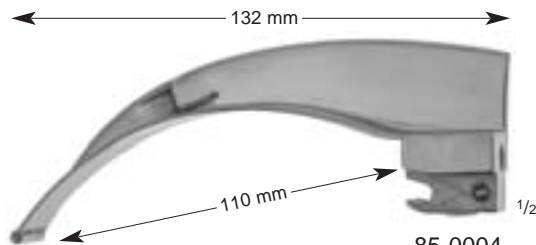

85-0004

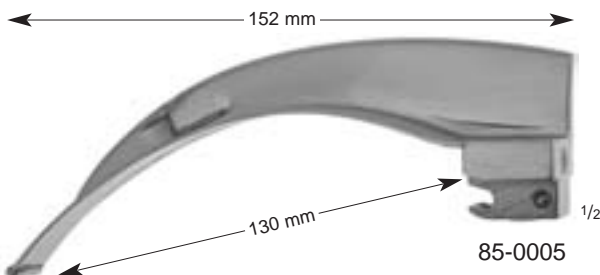

85-0005

MC INTOSH
 85-0001
 - 85-0005

Laryngoskopie-Spatel mit integriertem Kaltlichtträger
 Laryngoscope blades with integrated cold light carrier
 Espátulas de laringoscopios con luz fría integrada
 Spatules de laryngoscopie, avec lumière froide intégrée
 Spatole per laringoscopia, luce fredda



85-0008
 2,5 V

Ersatzbirnchen (Halogen) für
 Batteriegriff 85-0009

Spare bulb (Halogen) for
 battery handle 85-0009

Bombilla de repuesto (halogena)
 para mango de pila 85-0009

Lampe de rechange (halogène) pour
 poignée à piles 85-0009

Lampadina di ricambio (alogeno) per
 manico per pila 85-0009



85-0009
 16 cm, 6 1/4"

Batteriegriff ø 30 mm (2 Baby-Zellen,
 1,5 Volt, sind erforderlich)

Battery handle, ø 30 mm (2 Baby batteries,
 1,5 volt, are required)

Mango de pila ø 30 mm (se necesitan 2 pilas
 Mignon de 1,5 V)

Poignée à piles ø 30 mm (2 piles Mignon,
 1,5 volts sont nécessaires)

Manico per pila ø 30 mm (2 pile Mignon di
 1,5 volt sono necessarie)



MILLER Laryngoskope
 MILLER Laryngoscopes
 MILLER Laringoscopios
 MILLER Laryngoscopes
 MILLER Laringoscopi



1/3

MILLER 85-0045

Laryngoskopie-Besteck, bestehend aus:

- 85-0041 1 Laryngoskopie-Spatel 78/102 mm
- 85-0042 1 Laryngoskopie-Spatel 130/155 mm
- 85-0043 1 Laryngoskopie-Spatel 170/195 mm
- 85-0098 1 Batteriegriff ø 30 mm (ohne Batterien)
- 85-0047 1 Etui

Laryngoscope set, consisting of:

- 85-0041 1 Laryngoscope blade 78/102 mm
- 85-0042 1 Laryngoscope blade 130/155 mm
- 85-0043 1 Laryngoscope blade 170/195 mm
- 85-0098 1 Battery handle, ø 30 mm (without batteries)
- 85-0047 1 Case

Juego para laringoscopia, compuesto de:

- 85-0041 1 Espátula de laringoscopia 78/102 mm
- 85-0042 1 Espátula de laringoscopia 130/155 mm
- 85-0043 1 Espátula de laringoscopia 170/195 mm
- 85-0098 1 Mango de pila ø 30 mm (sin pilas)
- 85-0047 1 Estuche

Trousse à laryngoscopie, composée de:

- 85-0041 1 Spatule pour laryngoscopie 78/102 mm
- 85-0042 1 Spatule pour laryngoscopie 130/155 mm
- 85-0043 1 Spatule pour laryngoscopie 170/195 mm
- 85-0098 1 Poignée à piles ø 30 mm (sans piles)
- 85-0047 1 Boîte

Set per laringoscopia, composto da:

- 85-0041 1 Spatola per laringoscopia 78/102 mm
- 85-0042 1 Spatola per laringoscopia 130/155 mm
- 85-0043 1 Spatola per laringoscopia 170/195 mm
- 85-0098 1 Manico per pila ø 30 mm (senza pila)
- 85-0047 1 astuccio



1/3

MILLER 85-0046

Laryngoskopie-Besteck, bestehend aus:

- 85-0040 1 Laryngoskopie-Spatel 53/75 mm
- 85-0041 1 Laryngoskopie-Spatel 78/102 mm
- 85-0042 1 Laryngoskopie-Spatel 130/155 mm
- 85-0043 1 Laryngoskopie-Spatel 170/195 mm
- 85-0044 1 Laryngoskopie-Spatel 180/204 mm
- 85-0098 1 Batteriegriff ø 30 mm (ohne Batterien)
- 85-0048 1 Etui

Laryngoscope set, consisting of:

- 85-0040 1 Laryngoscope blade 53/75 mm
- 85-0041 1 Laryngoscope blade 78/102 mm
- 85-0042 1 Laryngoscope blade 130/155 mm
- 85-0043 1 Laryngoscope blade 170/195 mm
- 85-0044 1 Laryngoscope blade 180/204 mm
- 85-0098 1 Battery handle, ø 30 mm (without batteries)
- 85-0048 1 Case

Juego para laringoscopia, compuesto de:

- 85-0040 1 Espátula de laringoscopia 53/75 mm
- 85-0041 1 Espátula de laringoscopia 78/102 mm
- 85-0042 1 Espátula de laringoscopia 130/155 mm
- 85-0043 1 Espátula de laringoscopia 170/195 mm
- 85-0044 1 Espátula de laringoscopia 180/204 mm
- 85-0098 1 Mango de pila ø 30 mm (sin pilas)
- 85-0048 1 Estuche

Trousse à laryngoscopie, composée de:

- 85-0041 1 Spatule pour laryngoscopie 78/102 mm
- 85-0042 1 Spatule pour laryngoscopie 130/155 mm
- 85-0043 1 Spatule pour laryngoscopie 170/195 mm
- 85-0044 1 Spatule pour laryngoscopie 180/204 mm
- 85-0098 1 Poignée à piles ø 30 mm (sans piles)
- 85-0047 1 Boîte

Set per laringoscopia, composto da:

- 85-0041 1 Spatola per laringoscopia 78/102 mm
- 85-0042 1 Spatola per laringoscopia 130/155 mm
- 85-0043 1 Spatola per laringoscopia 170/195 mm
- 85-0044 1 Spatola per laringoscopia 180/204 mm
- 85-0098 1 Manico per pila ø 30 mm (senza pila)
- 85-0047 1 astuccio

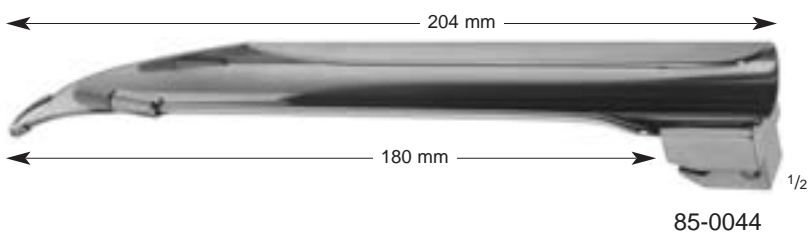
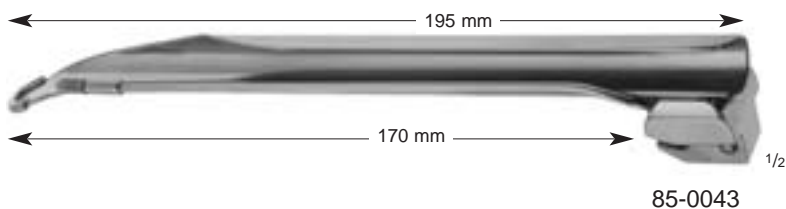
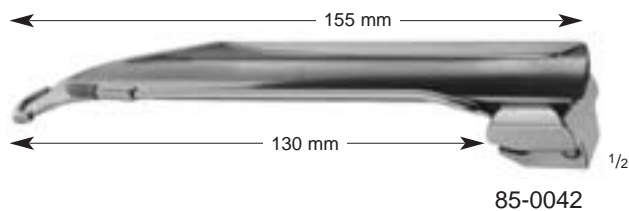
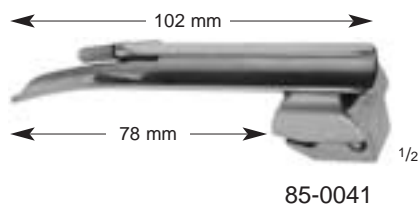
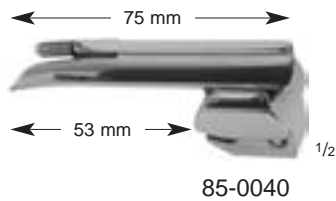

MILLER
 85-0040
 - 85-0044

Laryngoskopie-Spatel
 Laryngoscope blades
 Espátulas de laringoscopios
 Spatules de laryngoscopie
 Spatole per laringoscopi



85-0058
2,5 V

Ersatzbirnchen für
 Laryngoskopie-Spatel
 85-0040 - 85-0043

Spare bulb for
 laryngoscope blades
 85-0040 - 85-0043

Bombilla de repuesto para
 espátulas de laringoscopios
 85-0040 - 85-0043

Lampe de rechange pour
 spatule de laryngoscope
 85-0040 - 85-0043

Lampadine di ricambio per
 spatola per laringoscopia
 85-0040 - 85-0043



85-0059
2,5 V

Ersatzbirnchen für
 Laryngoskopie-Spatel
 85-0044

Spare bulb for
 laryngoscope blade
 85-0044

Bombilla de repuesto para
 espátula de laringoscopia
 85-0044

Lampe de rechange pour
 spatule de laryngoscope
 85-0044

Lampadine di ricambio per
 spatola per laringoscopia
 85-0044



85-0098
14,5 cm, 5 3/4"

Batteriegriff ø 30 mm (2 Baby-
 Zellen, 1,5 Volt, sind erforderlich)

Battery handle, ø 30 mm (2 Baby
 batteries, 1.5 volt, are required)

Mango de pila ø 30 mm (se necesi-
 tan 2 pilas Mignon de 1,5 V)

Poignée à piles ø 30 mm (2 piles
 Mignon, 1,5 volts sont nécessaires)

Manico per pila ø 30 mm (2 pile
 Mignon di 1,5 volt sono necessarie)



85-0094
15 cm, 6"

Batteriegriff ø 18 mm (2 Mini-
 Zellen, 1,5 Volt, sind erforderlich)

Battery handle, ø 18 mm (2 Mini
 batteries, 1.5 volt, are required)

Mango de pila ø 18 mm (se necesi-
 tan 2 pilas Mini de 1,5 V)

Poignée à piles ø 18 mm (2 piles
 Mini, 1,5 volts sont nécessaires)

Manico per pila ø 18 mm (2 pile
 Mini di 1,5 volt sono necessarie)



MILLER Laryngoskope mit Kaltlicht
 MILLER Laryngoscopes with Cold Light
 MILLER Laringoscopios de luz fría
 MILLER Laryngoscopes lumière froide
 MILLER Laringoscopi luce fredda



1/3

MILLER 85-0087

Laryngoskopie-Besteck, bestehend aus:

- 85-0082 1 Spatel mit Kaltlicht 78/102 mm
- 85-0083 1 Spatel mit Kaltlicht 130/155 mm
- 85-0084 1 Spatel mit Kaltlicht 170/195 mm
- 85-0009 1 Batteriegriff ø 30 mm (ohne Batterien)
- 85-0047 1 Etui

Laryngoscope set, consisting of:

- 85-0082 1 Blade with cold light 78/102 mm
- 85-0083 1 Blade with cold light 130/155 mm
- 85-0084 1 Blade with cold light 170/195 mm
- 85-0009 1 Battery handle, ø 30 mm (without batteries)
- 85-0047 1 Case

Juego para laringoscopia, compuesto de:

- 85-0082 1 Espátula con luz fría 78/102 mm
- 85-0083 1 Espátula con luz fría 130/155 mm
- 85-0084 1 Espátula con luz fría 170/195 mm
- 85-0009 1 Mango de pila ø 30 mm (sin pilas)
- 85-0047 1 Estuche

Trousse à laryngoscopie, composée de:

- 85-0082 1 Spatule lumière froide 78/102 mm
- 85-0083 1 Spatule lumière froide 130/155 mm
- 85-0084 1 Spatule lumière froide 170/195 mm
- 85-0009 1 Poignée à piles ø 30 mm (sans piles)
- 85-0047 1 Boîte

Set per laringoscopia, composto da:

- 85-0082 1 Spatola con luce fredda 78/102 mm
- 85-0083 1 Spatola con luce fredda 130/155 mm
- 85-0084 1 Spatola con luce fredda 170/195 mm
- 85-0009 1 Manico per pila ø 30 mm (senza pila)
- 85-0047 1 astuccio



1/3

MILLER 85-0088

Laryngoskopie-Besteck, bestehend aus:

- 85-0081 1 Spatel mit Kaltlicht 53/75 mm
- 85-0082 1 Spatel mit Kaltlicht 78/102 mm
- 85-0083 1 Spatel mit Kaltlicht 130/155 mm
- 85-0084 1 Spatel mit Kaltlicht 170/195 mm
- 85-0085 1 Spatel mit Kaltlicht 180/204 mm
- 85-0009 1 Batteriegriff ø 30 mm (ohne Batterien)
- 85-0048 1 Etui

Laryngoscope set, consisting of:

- 85-0081 1 Blade with cold light 53/75 mm
- 85-0082 1 Blade with cold light 78/102 mm
- 85-0083 1 Blade with cold light 130/155 mm
- 85-0084 1 Blade with cold light 170/195 mm
- 85-0085 1 Blade with cold light 180/204 mm
- 85-0009 1 Battery handle, ø 30 mm (without batteries)
- 85-0048 1 Case

Juego para laringoscopia, compuesto de:

- 85-0081 1 Espátula con luz fría 53/75 mm
- 85-0082 1 Espátula con luz fría 78/102 mm
- 85-0083 1 Espátula con luz fría 130/155 mm
- 85-0084 1 Espátula con luz fría 170/195 mm
- 85-0085 1 Espátula con luz fría 180/204 mm
- 85-0009 1 Mango de pila ø 30 mm (sin pilas)
- 85-0048 1 Estuche

Trousse à laryngoscopie, composée de:

- 85-0082 1 Spatule lumière froide 78/102 mm
- 85-0083 1 Spatule lumière froide 130/155 mm
- 85-0084 1 Spatule lumière froide 170/195 mm
- 85-0085 1 Spatule lumière froide 180/204 mm
- 85-0009 1 Poignée à piles ø 30 mm (sans piles)
- 85-0048 1 Boîte

Set per laringoscopia, composto da:

- 85-0082 1 Spatola con luce fredda 78/102 mm
- 85-0083 1 Spatola con luce fredda 130/155 mm
- 85-0084 1 Spatola con luce fredda 170/195 mm
- 85-0085 1 Spatola con luce fredda 180/204 mm
- 85-0009 1 Manico per pila ø 30 mm (senza pila)
- 85-0048 1 astuccio

MILLER Laryngoskope mit Kaltlicht
 MILLER Laryngoscopes with Cold Light
 MILLER Laringoscopios de luz fría
 MILLER Laryngoscopes lumière froide
 MILLER Laringoscopi luce fredda

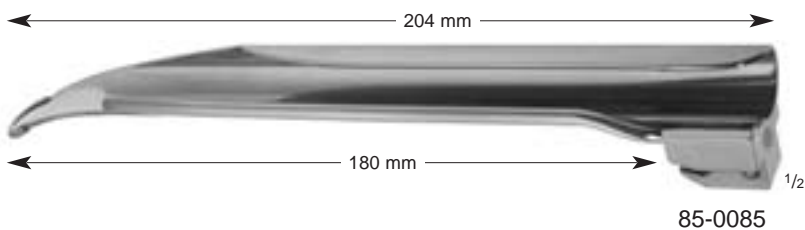
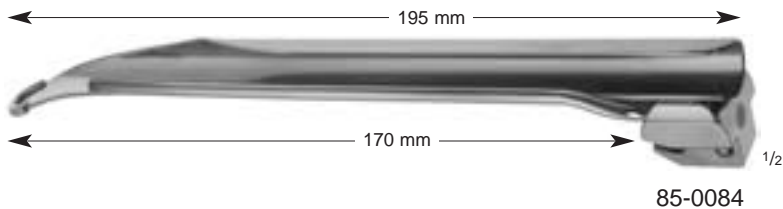
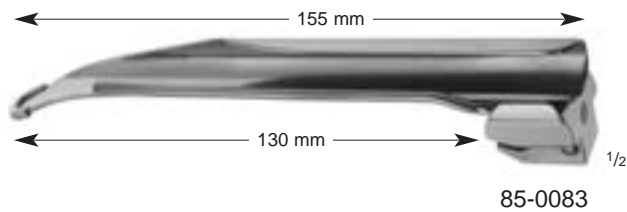
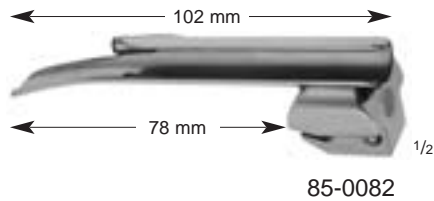
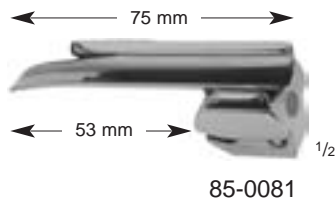
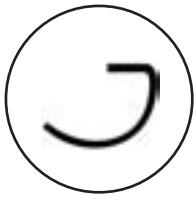

MILLER
 85-0081
 - 85-0085

Laryngoskopie-Spatel mit integriertem Kaltlichtträger
 Laryngoscope blades with integrated cold light carrier
 Espátulas de laringoscopios con luz fría integrada
 Spatules de laryngoscopie, avec lumière froide intégrée
 Spatole per laringoscopia, luce fredda



85-0008
 2,5 V

Ersatzbirnchen (Halogen) für Batteriegriff 85-0009

Spare bulb (Halogen) for battery handle 85-0009

Bombilla de repuesto (halogena) para mango de pila 85-0009

Lampe de recharge (halogène) pour poignée à piles 85-0009

Lampadina di ricambio (alogeno) per manico per pila 85-0009



85-0009
 16 cm, 6 1/4"

Batteriegriff ø 30 mm (2 Baby-Zellen, 1,5 Volt, sind erforderlich)

Battery handle, ø 30 mm (2 Baby batteries, 1,5 volt, are required)

Mango de pila ø 30 mm (se necesitan 2 pilas Mignon de 1,5 V)

Poignée à piles ø 30 mm (2 piles Mignon, 1,5 volts sont nécessaires)

Manico per pila ø 30 mm (2 pile Mignon di 1,5 volt sono necessarie)



Katheter-Einführungszangen
Catheter Introducing Forceps
Pinzas para introducir catéteres
Pinces pour intubation
Pinze introduttrici di cateteri

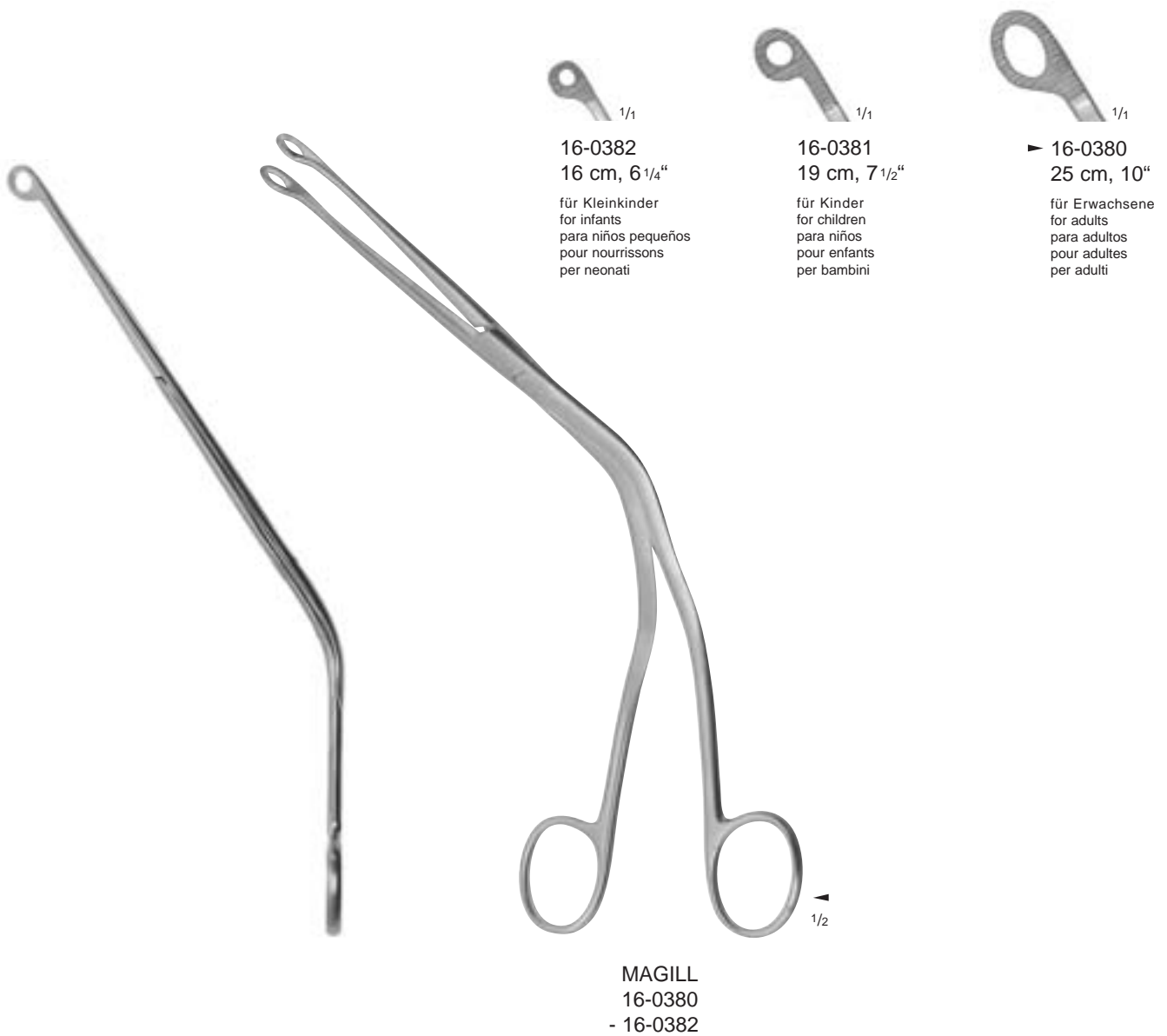

16-0382
16 cm, 6 1/4"

für Kleinkinder
for infants
para niños pequeños
pour nourrissons
per neonati



16-0381
19 cm, 7 1/2"

für Kinder
for children
para niños
pour enfants
per bambini



▶ 16-0380
25 cm, 10"

für Erwachsene
for adults
para adultos
pour adultes
per adulti

MAGILL
16-0380
- 16-0382



LAWNTON

Medizintechnik



Skalpelle, Messer
Scalpels, Knives
Bisturíes, Cuchillos
Bistouris, Couteaux
Bisturi, Coltelli



Sterile Skalpellklingen
 Sterile Scalpel Blades
 Hojas de bisturíes, estériles
 Lames de bistouris, stériles
 Lame per bisturi, sterili

Skalpellgriffe
 Scalpel Handles
 Mangos de bisturíes
 Manches pour bistouris
 Manici per bisturi



Fig. 10
04-1010



Fig. 11
04-1011



Fig. 12
04-1012



Fig. 13
04-1013



Fig. 15
04-1015



Fig. 12d
04-1112
doppelschneidig
double cutting edges
filo doble
double tranchant
filo doppio

in Packungen zu 100 Stück • in packages of 100 pieces • en paquets de 100 piezas • en paquets de 100 pièces • in confezioni di 100 pezzi



No. 3
04-1050
12 cm, 4 3/4"



No. 3L
04-1051
21 cm, 8 1/4"
gerade
straight
recto
droit
retto



No. 3L
04-1059
20,5 cm, 8"
abgewinkelt
angled
acodado
coudé
angolato



No. 7
04-1057
16 cm, 6 1/4"



No. 7L
04-1058
22 cm, 8 3/4"

Sterile Skalpellklingen
 Sterile Scalpel Blades
 Hojas de bisturíes, estériles
 Lames de bistouris, stériles
 Lame per bisturi, sterili

Skalpellgriffe
 Scalpel Handles
 Mangos de bisturíes
 Manches pour bistouris
 Manici per bisturi



1/1

Fig. 18

04-1018



1/1

Fig. 20

04-1020



1/1

Fig. 21

04-1021



1/1

Fig. 22

04-1022



1/1

Fig. 23

04-1023



1/1

Fig. 24

04-1024

in Packungen zu 100 Stück • in packages of 100 pieces • en paquets de 100 piezas • en paquets de 100 pièces • in confezioni di 100 pezzi



1/1

Fig. 25

04-1025



1/1

Fig. 36d

04-1136

doppelschneidig
 double cutting edges
 filo doble
 double tranchant
 filo doppio



1/2

No. 4

04-1055

13 cm, 5 1/8"



1/2

No. 4L

04-1056

21 cm, 8 1/4"



Klingen
Blades
Hojas
Lames
Lamette

Rasierklingen-Halter und -Brecher
Razor Blade Holders and Breakers
Pinzas para sujetar y romper hojas de afeitarse
Pincettes pour saisir et casser les lames de rasoir
Pinze per afferrare e rompere le lamette de rasoio

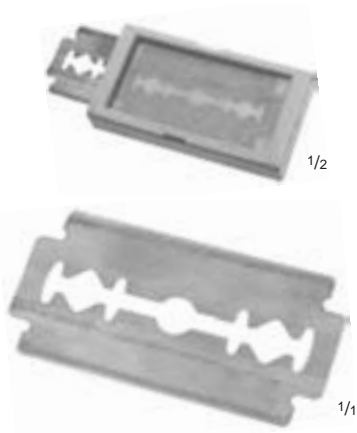

60-1780

Rasierklingen, brechbar, rostfrei, in Packungen zu 10 Stück

Razor blades, breakable, stainless steel, in packages of 10 pieces

Hojas de afeitarse, rompibles de acero inoxidable, en paquetes de 10 piezas

Lames de rasoir, cassables, en inox, en paquets de 10

Lamette di rasoio, per rompere, acciaio inossidabile, scatola di 10 pezzi



TROUTMAN
60-1793
9 cm, 3 1/2"

Rasierklingen-Halter und -Brecher
Razor blade holder and breaker
Pinza para sujetar y romper hojas de afeitarse
Pincette pour saisir et casser les lames de rasoir
Pinza per afferrare e rompere le lamette da rasoio

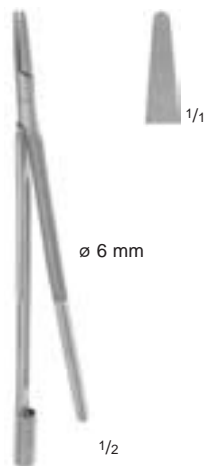

CASTROVIEJO
60-1797
12 cm, 4 3/4"

Rasierklingen-Halter und -Brecher
Razor blade holder and breaker
Pinza para sujetar y romper hojas de afeitarse
Pincette pour saisir et casser les lames de rasoir
Pinza per afferrare e rompere le lamette da rasoio



CASTROVIEJO
60-1791
13,5 cm, 5 1/4"

Rasierklingen-Halter und -Brecher
Razor blade holder and breaker
Pinza para sujetar y romper hojas de afeitarse
Pincette pour saisir et casser les lames de rasoir
Pinza per afferrare e rompere le lamette da rasoio

Nasenplastikmesser
 Rhinoplastic Knives
 Bisturíes para rinoplastia
 Bistouris pour plastie du nez
 Bisturi per rino plastica

Tenotom
 Tenotome
 Tenotomo
 Ténotome
 Tenotomo

Duramesser
 Dura Knives
 Cuchillos p. dura-madré
 Couteaux pour dure-mère
 Coltelli per dura-madre

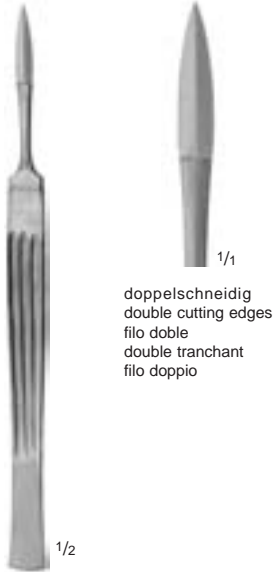

doppelschneidig
 double cutting edges
 filo doble
 double tranchant
 filo doppio

JOSEPH
 75-0100
 15 cm, 6"

Nasenplastikmesser
 Rhinoplastic knife
 Bisturí para rinoplastia
 Bistouri pour plastie du nez
 Bisturi per rinoplastica



doppelschneidig
 double cutting edges
 filo doble
 double tranchant
 filo doppio

04-1225
 16,5 cm, 6 1/2"

Nasenplastikmesser
 Rhinoplastic knife
 Bisturí para rinoplastia
 Bistouri pour plastie du nez
 Bisturi per rinoplastica



04-1228
 16,5 cm, 6 1/2"

Tenotom
 Tenotome
 Tenotomo
 Ténotome
 Tenotomo



TÖNNIS
 04-1250
 12,5 cm, 5"

Duramesser
 Dura knife
 Cuchillo para dura-madré
 Couteau pour dure-mère
 Coltello per dura-madre



TÖNNIS
 04-1252
 20,5 cm, 8"

Duramesser
 Dura knife
 Cuchillo para dura-madré
 Couteau pour dure-mère
 Coltello per dura-madre



HALLE
 04-1260
 21 cm, 8 1/4"

Duramesser
 Dura knife
 Cuchillo para dura-madré
 Couteau pour dure-mère
 Coltello per dura-madre



ULRICH
 04-1270
 22,5 cm, 9"

Fistelmesser
 Fistula knife
 Cuchillo para fistulas
 Bistouri pour fistules
 Bisturi per fistole



Resektionsmesser
 Resection Knives
 Cuchillos para resección
 Couteaux à résection
 Coltelli per resezione

Amputationsmesser
 Amputation Knives
 Cuchillos para amputación
 Couteaux à amputation
 Coltelli per amputazione



LANGENBECK
 47-0262
 55 mm
 Resektionsmesser
 Resection knife
 Cuchillo para resección
 Couteau à résection
 Coltello per resezione



LANGENBECK
 47-0263
 55 mm
 Resektionsmesser
 Resection knife
 Cuchillo para resección
 Couteau à résection
 Coltello per resezione

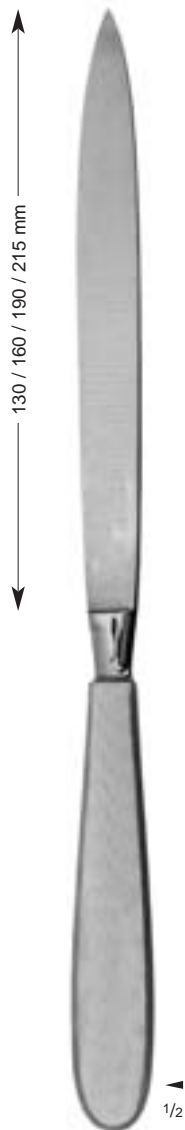

LISTON
 47-0250 130 mm
 ▶ 47-0251 160 mm
 47-0252 190 mm
 47-0254 215 mm
 Amputationsmesser
 Amputation knives
 Cuchillos para amputación
 Couteau à amputation
 Coltello per amputazione

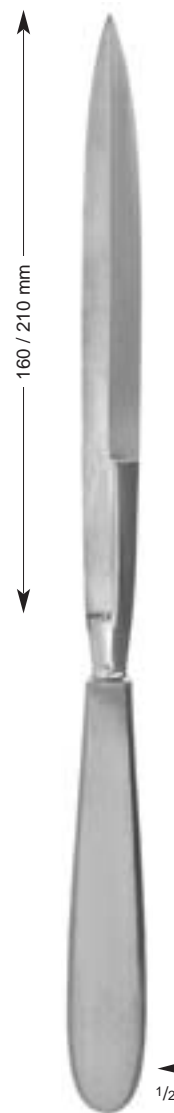

CATLIN
 ▶ 47-0255 160 mm
 47-0256 210 mm
 Amputationsmesser,
 doppelschneidig
 Amputation knives,
 double cutting edges
 Cuchillos para amputación,
 filo doble
 Couteau à amputation,
 double tranchant
 Coltello per amputazione,
 filo doppio



47-0265
65 mm

Beinhautmesser
mit Schaber
 Periosteum knife
with raspatory
 Cuchillo para periostio,
con periostótomio
 Couteau à périoste
avec râpe
 Coltell per periostio
con raschiatoio

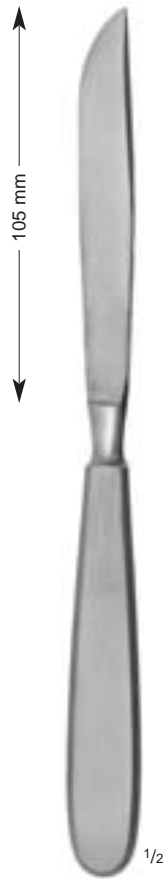

47-0264
105 mm

Phalangenmesser
Phalangeal knife
Cuchillo para falanges
Couteau à phalanges
Cottello per falangi

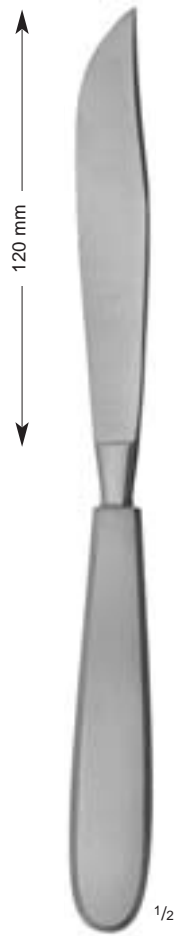

LANGENBECK
47-0260
120 mm

Lappenmesser
Flap knife
Cuchillo para lóbulos
Couteau à lobe
Cottello per lobi

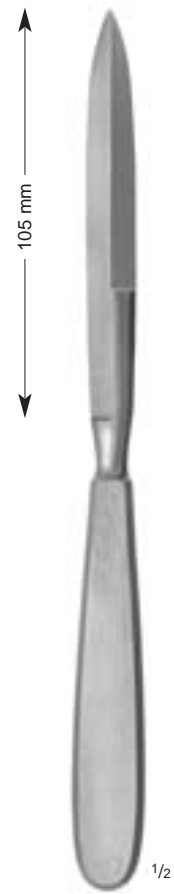

47-0266
105 mm

Zwischenknochenmesser,
doppelschneidig
 Interosseous knife,
double cutting edges
 Cuchillo interóseo,
filo doble
 Couteau interosseux,
double tranchant
 Cottello interosseo,
filo doppio



Messer für Autopsie
 Post Mortem Knives
 Cuchillos para autopsia
 Bistouris à autopsie
 Coltello per autopsia

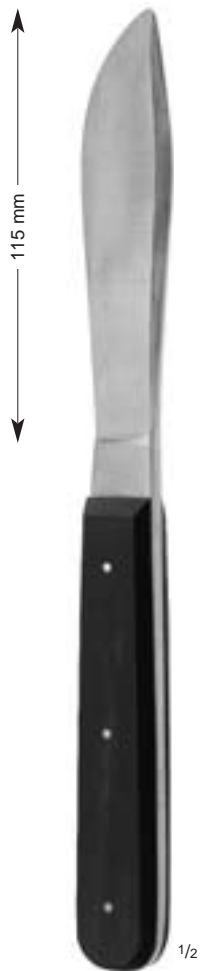

04-1352
 115 mm

Seziermesser mit Holzheft

Autopsy knife with wooden handle

Cuchillo para autopsia, con mango de madera

Bistouri à autopsie, manche en bois

Coltello per autopsia con manico in legno

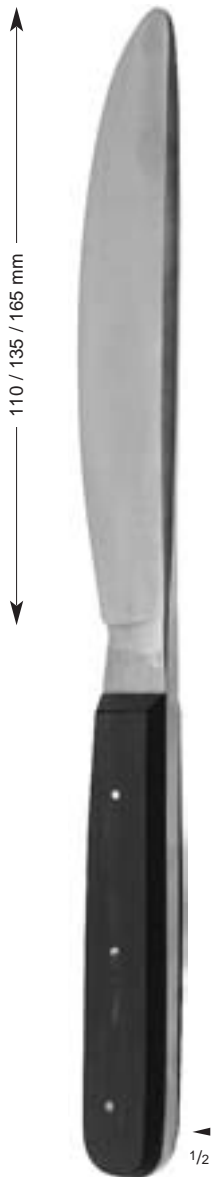

WALB

04-1355 110 mm

04-1356 135 mm

► 04-1357 165 mm

Organmesser mit Holzheft

Post mortem knives with wooden handle

Cuchillos post mortem, con mango de madera

Couteaux à autopsie, manche en bois

Coltello per autopsia con manico in legno

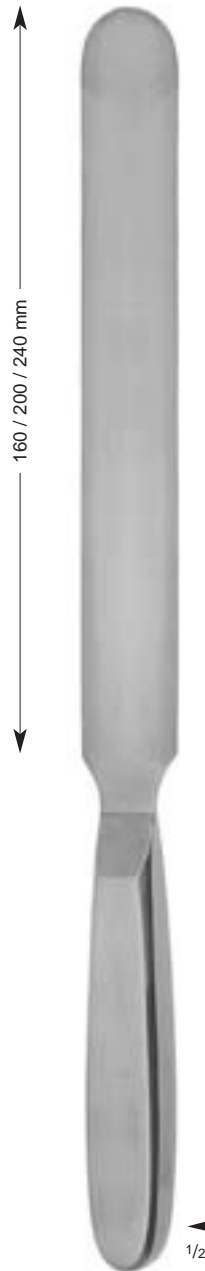

VIRCHOW

04-1360 160 mm

► 04-1361 200 mm

04-1362 240 mm

Hirnmesser mit Metallheft

Brain knives with metal handle

Cuchillos para cerebro, con mango de metal

Couteaux à cerveau, manche métal

Coltello per il cervello con manico in metallo

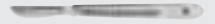

SILVER
 04-1385
 19,5 cm, 7³/₄"

Dermatom für handelsübliche Rasierklingen
 Dermatome for razor blades standard model in trade
 Dermátomo para hojas de afeitar corrientes
 Dermatome pour lames de rasoir standard
 Dermatomo per lame di rasoio standard



SCHINK
 04-1390
 30 cm, 12"

Dermatom, einstellbar von 0,1 bis 2,0 mm (maximale Breite des Hautlappens: 100 mm, 4"), komplett, mit 1 auswechselbaren Klinge und 2 Haut-Spannplatten

Dermatome, adjustable from 0.1 to 2.0 mm (maximum width of skin graft: 100 mm, 4"), complete, with 1 interchangeable blade and 2 skin straightening plates

Dermátomo, graduable de 0,1 hasta 2,0 mm (anchura máx. de injerto cataneo: 100 mm, 4"), completo, con 1 hoja intercambiable y placas para extender la piel

Dermatome réglable de 0,1 à 2,0 mm, épaisseur (maximale du greffon: 100 mm, 4") complet avec une lame interchangeable et 2 plaques pour tendre la peau

Dermatomo regolabile da 0,1 a 2,0 mm (larghezza massima del taglio: mm 100, 4") completo di 1 lama intercambiabile e 2 placche per stendere la pelle



04-1391

Ersatzklinge allein
 Spare blade only
 Hoja de repuesto, suelta
 Lame de rechange seule
 Lama di ricambio, sola



04-1392

Haut-Spannplatte allein
 Skin straightening plate only
 Placa para extender la piel, suelta
 Plaque pour tendre la peau seule
 Placca per stendere la pelle, sola



Dermatom
Dermatome
Dermátomo
Dermatome
Dermatomo



1/2



1/2

04-1396

Ersatzklinge allein
Spare blade only
Hoja de repuesto, suelta
Lame de rechange seule
Lama di ricambio

HUMBY

04-1395

32 cm, 12 1/2"

Dermatom, einstellbar von 0,1 bis 1,5 mm (maximale Breite des Hautlappens : 150 mm, 6"), komplett mit 1 auswechselbaren Klinge
Dermatome, adjustable from 0.1 to 1.5 mm (maximum width of skin graft: 150 mm, 6"), complete, with 1 interchangeable blade
Dermátomo, graduable de 0,1 hasta 1,5 mm (anchura máx. de injerto cutáneo: 150 mm, 6"), completo, con 1 hoja intercambiable
Dermatome réglable de 0,1 à 1,5 mm, épaisseur (maximale du greffon: 150 mm, 6") complet avec une lame interchangeable
Dermatomo regolabile da 0,1 a 1,5 mm (larghezza massima del taglio: mm 150, 6") completo di 1 lama intercambiabile



LAWNTON

Medizintechnik

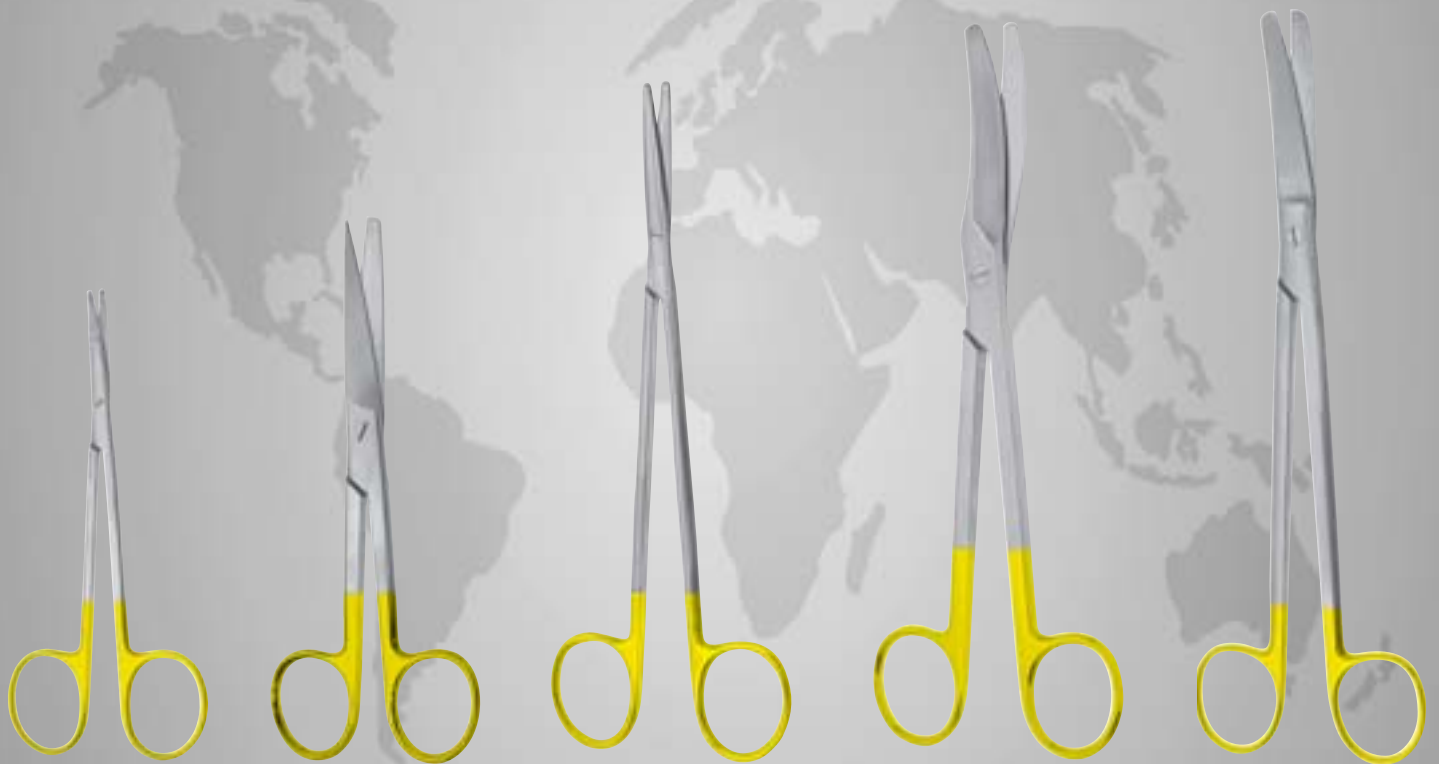

DURACUT® Scheren
DURACUT® Scissors
DURACUT® Tijeras
DURACUT® Ciseaux
DURACUT® Forbici



DURACUT® Scheren mit Hartmetallschneiden
DURACUT® Scissors with tungsten carbide edges
DURACUT® Tijeras con filos de carburo tungsteno
DURACUT® Ciseaux avec des lames en tungstène
DURACUT® Forbici con lame in carburo di tungsteno



- In der Marke DURACUT® spiegelt sich die längste Erfahrung in der Herstellung von Scheren mit aufgeschweißten Hartmetallschneiden wider. Vorteile:
 - dauerhafte Schnitthaltigkeit
 - weicher, gleichmäßiger Gang
 - vergoldete Griffe als leichte Kennzeichnung
- The name DURACUT® reflects longest experience in producing scissors with welded hard faced cutting edges. Advantages:
 - longer lasting cut
 - smooth and regular cutting
 - golden handles for easy identification
- La marca DURACUT® refleja la experiencia más avanzada en la producción de las tijeras con los filos de carburo tungsteno fundidos. Ventajas:
 - duración de la agudeza
 - corte suave y regular
 - mangos dorados para su identificación
- La marque DURACUT® reflète l'expérience la plus longue qui soit dans le domaine de la fabrication de ciseaux à lames de métal dur soudées. Avantages:
 - excellente tenue de coupe
 - souplesse et régularité de manoeuvre
 - anneaux dorés pour une identification facile
- Nella marca DURACUT® si riflette una lunga esperienza nella produzione di forbici con lame in carburo metallico saldate. I vantaggi:
 - maggior durata delle lame
 - taglio morbido e regolare
 - impugnatura dorata per una facile identificazione

DURACUT® Feine Scheren mit Hartmetallschneiden
 DURACUT® Delicate Scissors with tungsten carbide edges
 DURACUT® Tijeras finas con filos de carburo tungsteno
 DURACUT® Ciseaux fins avec des lames en tungstène
 DURACUT® Forbici fini con lame in carburo di tungsteno



► 05-1450
11,5 cm, 4 1/2"

05-1455
11,5 cm, 4 1/2"

05-1450
- 05-1455

Irisscheren
Iris scissors
Tijeras para iridectomía
Ciseaux à iridectomie
Forbici per iridectomia



05-1459
11 cm, 4 3/8"

Irisschere
Iris scissors
Tijera para iridectomia
Ciseaux à iridectomie
Forbici per iridectomia



► 05-1460
14 cm, 5 1/2"

05-1461
14 cm, 5 1/2"

JOSEPH
05-1460
- 05-1461

Scheren für plastische Chirurgie
Plastic surgery scissors
Tijeras para la cirugía plástica
Ciseaux pour la chirurgie plastique
Forbici per la chirurgia plastica



► 05-1480
16 cm, 6 1/4"

05-1481
16 cm, 6 1/4"

KELLY
05-1480
- 05-1481

Gefäß- und Fistelscheren
Vascular and fistula scissors
Tijeras para vasos y fistulas
Ciseaux vasculaires et pour fistules
Forbici vascolare e per fistole



DURACUT® Chirurgische Scheren mit Hartmetallschneiden
 DURACUT® Surgical Scissors with tungsten carbide edges
 DURACUT® Tijeras para cirugía con filos de carburo tungsteno
 DURACUT® Ciseaux à chirurgie avec des lames en tungstène
 DURACUT® Forbici per chirurgia con lame in carburo di tungsteno



► 05-1501
14,5 cm, 5³/₄"



► 05-1500
14,5 cm, 5³/₄"



► 05-1504
14,5 cm, 5³/₄"



05-1503
14,5 cm, 5³/₄"



05-1502
14,5 cm, 5³/₄"



05-1505
14,5 cm, 5³/₄"

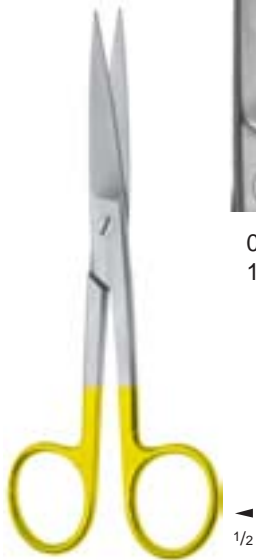

05-1501
- 05-1503

Standard Modelle
Standard patterns
modelos standard
modèles standard
modelli standard



05-1500
- 05-1502

Standard Modelle
Standard patterns
modelos standard
modèles standard
modelli standard



05-1504
- 05-1505

Standard Modelle
Standard patterns
modelos standard
modèles standard
modelli standard

DURACUT® Präparierscheren mit Hartmetallschneiden
 DURACUT® Dissecting Scissors with tungsten carbide edges
 DURACUT® Tijeras de disección con filos de carburo tungsteno
 DURACUT® Ciseaux à dissection avec des lames en tungstène
 DURACUT® Forbici per dissezione con lame in carburo di tungsteno



05-1550
14,5 cm, 5^{3/4}"



▶ 05-1560
17 cm, 6^{3/4}"



05-1570
23 cm, 9"



MAYO
05-1550
- 05-1571



05-1551
14,5 cm, 5^{3/4}"



05-1561
17 cm, 6^{3/4}"



05-1571
23 cm, 9"



DURACUT® Präparierscheren mit Hartmetallschneiden
DURACUT® Dissecting Scissors with tungsten carbide edges
DURACUT® Tijeras de disección con filos de carburo tungsteno
DURACUT® Ciseaux à dissection avec des lames en tungstène
DURACUT® Forbici per dissezione con lame in carburo di tungsteno

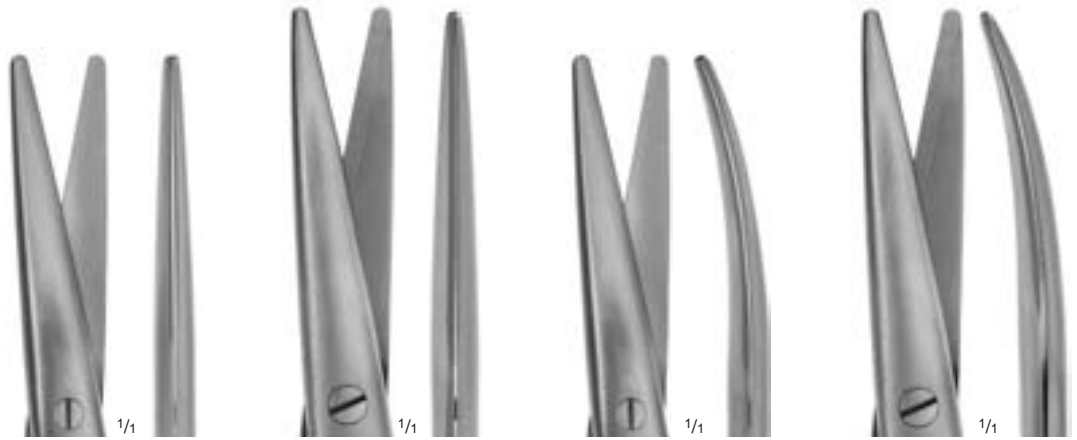

► 05-1555
14,5 cm, 5³/₄"

05-1565
17 cm, 6³/₄"

05-1556
14,5 cm, 5³/₄"

05-1566
17 cm, 6³/₄"

MAYO-STILLE
05-1555
- 05-1566

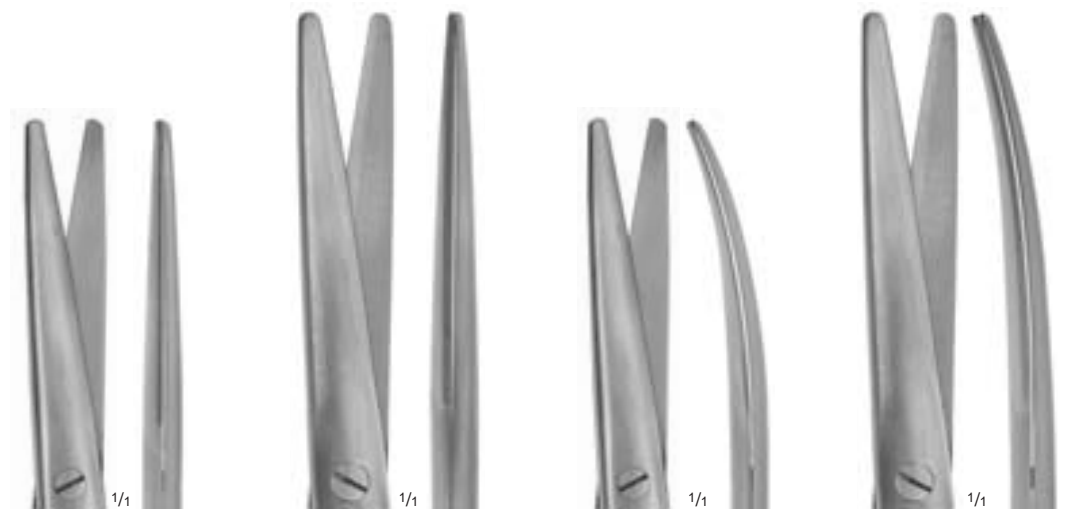

► 05-1580
16 cm, 6¹/₄"

05-1582
21 cm, 8¹/₄"

05-1581
16 cm, 6¹/₄"

05-1583
21 cm, 8¹/₄"

MAYO-LEXER
05-1580
- 05-1583

DURACUT® Präparierscheren mit Hartmetallschneiden
 DURACUT® Dissecting Scissors with tungsten carbide edges
 DURACUT® Tijeras de disección con filos de carburo tungsteno
 DURACUT® Ciseaux à dissection avec des lames en tungstène
 DURACUT® Forbici per dissezione con lame in carburo di tungsteno



RAGNELL
 05-1491
 12,5 cm, 5"



LEXER
 05-1584
 - 05-1585



► 05-1584
 16 cm, 6 1/4"



05-1585
 16 cm, 6 1/4"



TOENNIS-ADSON
 05-1579
 17,5 cm, 7"



METZENBAUM
 05-1465
 - 05-1466



► 05-1465
 11,5 cm, 4 1/2"



05-1466
 11,5 cm, 4 1/2"



DURACUT® Präparierscheren mit Hartmetallschneiden
 DURACUT® Dissecting Scissors with tungsten carbide edges
 DURACUT® Tijeras de disección con filos de carburo tungsteno
 DURACUT® Ciseaux à dissection avec des lames en tungstène
 DURACUT® Forbici per dissezione con lame in carburo di tungsteno



05-2000
14,5 cm, 5³/₄"



▶ 05-2002
18 cm, 7"



05-2004
20,5 cm, 8"



05-2006
23 cm, 9"



05-2001
14,5 cm, 5³/₄"



05-2003
18 cm, 7"



05-2005
20,5 cm, 8"



05-2007
23 cm, 9"



1/2

METZENBAUM
05-2000
- 05-2007

Standard Modelle
Standard patterns
modelos standard
modèles standard
modelli standard

DURACUT® Präparierscheren mit Hartmetallschneiden
 DURACUT® Dissecting Scissors with tungsten carbide edges
 DURACUT® Tijeras de disección con filos de carburo tungsteno
 DURACUT® Ciseaux à dissection avec des lames en tungstène
 DURACUT® Forbici per dissezione con lame in carburo di tungsteno



05-2010
14,5 cm, 5 3/4"



▶ 05-2020
18 cm, 7"



05-2040
20,5 cm, 8"



05-2060
23 cm, 9"



METZENBAUM
05-2010
- 05-2062

feine Modelle
delicate patterns
modelos finos
modèles fins
modelli delicati



05-2012
14,5 cm, 5 3/4"



05-2022
18 cm, 7"



05-2042
20,5 cm, 8"



05-2062
23 cm, 9"



DURACUT® Präparierscheren mit Hartmetallschneiden
DURACUT® Dissecting Scissors with tungsten carbide edges
DURACUT® Tijeras de disección con filos de carburo tungsteno
DURACUT® Ciseaux à dissection avec des lames en tungstène
DURACUT® Forbici per dissezione con lame in carburo di tungsteno



05-2011
14,5 cm, 5³/₄"



▶ 05-2021
18 cm, 7"



05-2041
20,5 cm, 8"



05-2061
23 cm, 9"



05-2013
14,5 cm, 5³/₄"



05-2023
18 cm, 7"



05-2043
20,5 cm, 8"



05-2063
23 cm, 9"



METZENBAUM
05-2011
- 05-2063

sehr feine Modelle
very delicate patterns
modelos muy finos
modèles très fins
modelli molto delicati

DURACUT® Präparierscheren mit Hartmetallschneiden
 DURACUT® Dissecting Scissors with tungsten carbide edges
 DURACUT® Tijeras de disección con filos de carburo tungsteno
 DURACUT® Ciseaux à dissection avec des lames en tungstène
 DURACUT® Forbici per dissezione con lame in carburo di tungsteno



► 05-2072 26,0 cm, 10 1/4"
 05-2074 28,5 cm, 11 1/4"



05-2076
 31 cm, 12 1/4"



► 05-2082 26,0 cm, 10 1/4"
 05-2084 28,5 cm, 11 1/4"



05-2073 26,0 cm, 10 1/4"
 05-2075 28,5 cm, 11 1/4"



05-2077
 31 cm, 12 1/4"



05-2083 26,0 cm, 10 1/4"
 05-2085 28,5 cm, 11 1/4"



NELSON-METZENBAUM
 05-2072
 - 05-2077

Standard Modelle
 Standard patterns
 modelos standard
 modèles standard
 modelli standard



NELSON-METZENBAUM
 05-2082
 - 05-2085

feine Modelle
 delicate patterns
 modelos finos
 modèles fins
 modelli delicati



DURACUT® Scheren mit Hartmetallschneiden
DURACUT® Scissors with tungsten carbide edges
DURACUT® Tijeras con filos de carburo tungsteno
DURACUT® Ciseaux avec des lames en tungstène
DURACUT® Forbici con lame in carburo di tungsteno



METZENBAUM
05-2064
- 05-2068



▶ 05-2064
18 cm, 7"



05-2066
20,5 cm, 8"



05-2068
23 cm, 9"

Präparierscheren • Dissecting scissors • Tijeras de disección • Ciseaux à dissection • Forbici per dissezione



METZENBAUM-THOREK
05-1656
- 05-1658



▶ 05-1656
20 cm, 8"



05-1658
22,5 cm, 9"



05-1657
27,5 cm, 10³/₄"

Adnexscheren • Adnex scissors • Tijeras adnex • Ciseaux adnex • Forbici adnex

DURACUT® Zahnfleischscheren mit Hartmetallschneiden
 DURACUT® Gum Scissors with tungsten carbide edges
 DURACUT® Tijeras para encías con filos de carburo tungsteno
 DURACUT® Ciseaux pour gencive avec des lames en tungstène
 DURACUT® Forbici per gengiva con lame in carburo di tungsteno





► 05-1470
13 cm, 5 1/8"

05-1471
13 cm, 5 1/8"

◄ 1/2

GOLDMANN-FOX
05-1470
- 05-1471





► 05-1476
13 cm, 5 1/8"

05-1477
13 cm, 5 1/8"

◄ 1/2

GOLDMANN-FOX
05-1476
- 05-1477



1 Blatt gezahnt
1 blade serrated
1 hoja dentada
1 lame dentelée
1 lama dentata



1 Blatt gezahnt
1 blade serrated
1 hoja dentada
1 lame dentelée
1 lama dentata

◄ 1/2

LOCKLIN
05-1472
16 cm, 6 1/4"

1 Blatt gezahnt
1 blade serrated
1 hoja dentada
1 lame dentelée
1 lama dentata

◄ 1/2

LOCKLIN
05-1473
16 cm, 6 1/4"



1 Blatt gezahnt
1 blade serrated
1 hoja dentada
1 lame dentelée
1 lama dentata

◄ 1/2

DEAN
05-1474
17 cm, 6 3/4"



DURACUT® Gefäßscheren mit Hartmetallschneiden
 DURACUT® Vascular Scissors with tungsten carbide edges
 DURACUT® Tijeras vasculares con filos de carburo tungsteno
 DURACUT® Ciseaux vasculaires avec des lames en tungstène
 DURACUT® Forbici vascolari con lame in carburo di tungsteno



30-2070
18 cm, 7"



▶ 30-2071
18 cm, 7"



30-2072
17,5 cm, 7"

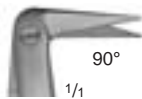

30-2073
17 cm, 6 3/4"



30-2074
17 cm, 6 3/4"



HEGEMANN-DIETRICH
30-2070
- 30-2074



30-2000
19 cm, 7 1/2"



30-2001
18,5 cm, 7 1/4"



▶ 30-2002
18 cm, 7"



POTTS-SMITH
30-2000
- 30-2002

DURACUT® Gefäßscheren mit Hartmetallschneiden
 DURACUT® Vascular Scissors with tungsten carbide edges
 DURACUT® Tijeras vasculares con filos de carburo tungsteno
 DURACUT® Ciseaux vasculaires avec des lames en tungstène
 DURACUT® Forbici vascolari con lame in carburo di tungsteno



▶ 30-2005
19 cm, 7 1/2"



▶ 30-2010
23 cm, 9"



30-2006
18,5 cm, 7 1/4"



30-2011
22,5 cm, 9"

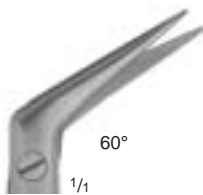

30-2007
18 cm, 7"



30-2012
22 cm, 8 3/4"



DE BAKEY
30-2005
- 30-2007



DE BAKEY
30-2010
- 30-2012



DURACUT® Nasenscheren mit Hartmetallschneiden
DURACUT® Nasal Scissors with tungsten carbide edges
DURACUT® Tijeras nasales con filos de carburo tungsteno
DURACUT® Ciseaux nasaux avec des lames en tungstène
DURACUT® Forbici nasali con lame in carburo di tungsteno



1 Blatt gezahnt
1 blade serrated
1 hoja dentada
1 lame dentelée
1 lama dentata

KNIGHT
05-1664
17,5 cm, 7"



1 Blatt gezahnt
1 blade serrated
1 hoja dentada
1 lame dentelée
1 lama dentata

HEYMANN
05-1666
18,5 cm, 7 1/4"



1 Blatt gezahnt
1 blade serrated
1 hoja dentada
1 lame dentelée
1 lama dentata

FOMON
05-1660
13,5 cm, 5 1/4"



1 Blatt gezahnt
1 blade serrated
1 hoja dentada
1 lame dentelée
1 lama dentata

COTTLE
05-1662
16 cm, 6 1/4"

DURACUT® Scheren mit Hartmetallschneiden
 DURACUT® Scissors with tungsten carbide edges
 DURACUT® Tijeras con filos de carburo tungsteno
 DURACUT® Ciseaux avec des lames en tungstène
 DURACUT® Forbici con lame in carburo di tungsteno



CAPLAN
 05-1668
 20 cm, 8"

Septumschere, gezahnt
 Septum scissors, serrated
 Tijera para el tabique nasal, dentada
 Ciseaux dentelés pour septum
 Forbici per il setto nasale, dentate

1/2

1/1



BLESSING
 05-1600
 30 cm, 12"

Schere für die Rektumchirurgie. Die stumpfe Form erleichtert das Präparieren in der richtigen Schicht, wodurch das präsakrale Nervengeflecht besser geschont werden kann.

Scissors for rectal surgery. The blunt shape facilitates the preparation of the correct layer, so that the presacral neuroplexus can be better preserved.

Tijera para la cirugía del recto. La forma roma facilita la preparación en la película precisa, por la cual se puede preservar mejor el neuroplexus presacral.

Ciseaux pour la chirurgie rectale. Sa forme émoussée facilite la dissection dans la bonne épaisseur et permet ainsi de mieux ménager le plexus pré-sacré.

Forbici per la chirurgia rettale. La forma smussata permette un facile incanalamento durante la dissezione senza ledere e meglio proteggendo il plesso nervoso sacrale.

1/1

1/2



GORNEY
 05-1670
 21,5 cm, 8 1/2"

Septumschere, gezahnt
 Septum scissors, serrated
 Tijera para el tabique nasal, dentada
 Ciseaux dentelés pour septum
 Forbici per il setto nasale, dentate

1/2

1/1



DURACUT® Gynäkologische Scheren mit Hartmetallschneiden
 DURACUT® Gynecological Scissors with tungsten carbide edges
 DURACUT® Tijeras para ginecología con filos de carburo tungsteno
 DURACUT® Ciseaux pour gynécologie avec des lames en tungstène
 DURACUT® Forbici per ginecologia con lame in carburo di tungsteno

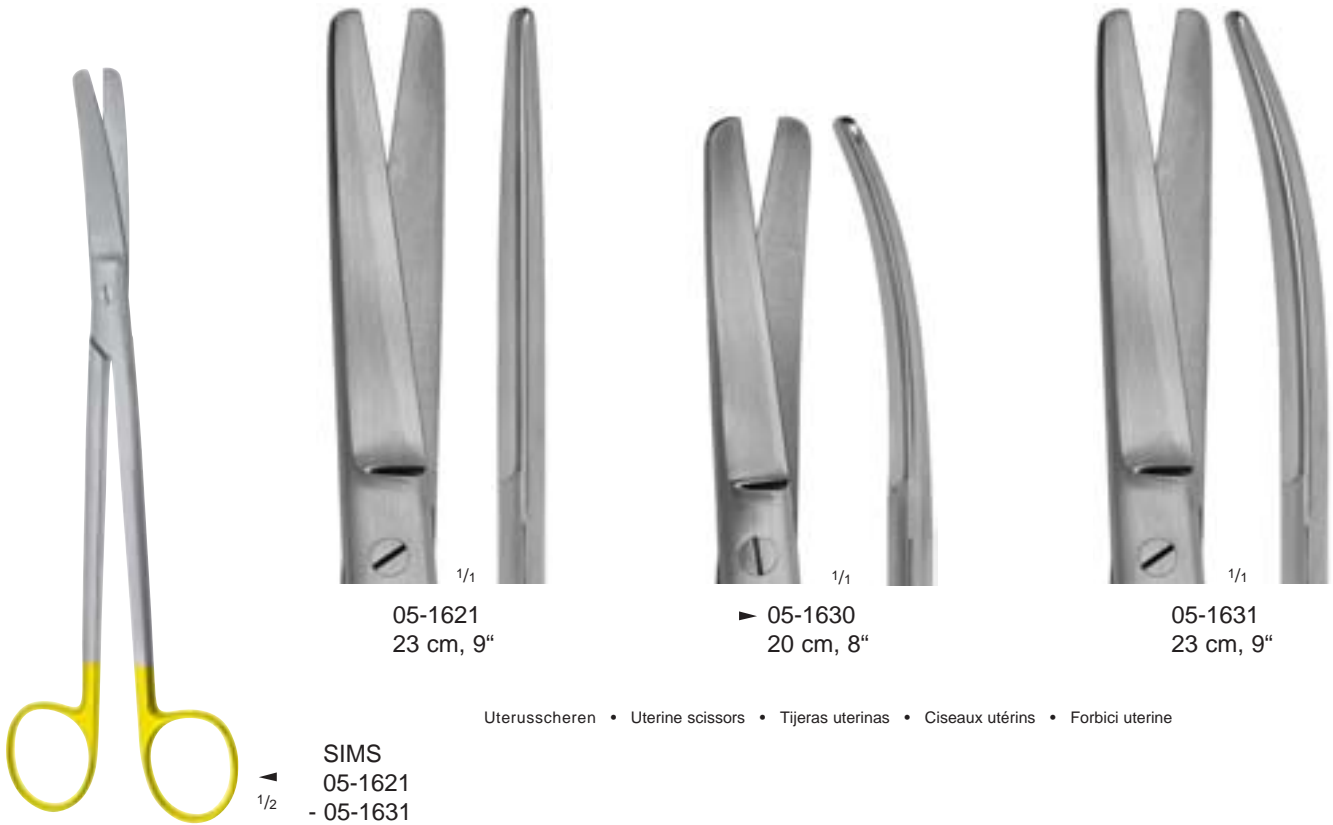

Uterusscheren • Uterine scissors • Tijeras uterinas • Ciseaux utérins • Forbici uterine

◀ SIMS
 05-1621
 1/2 - 05-1631

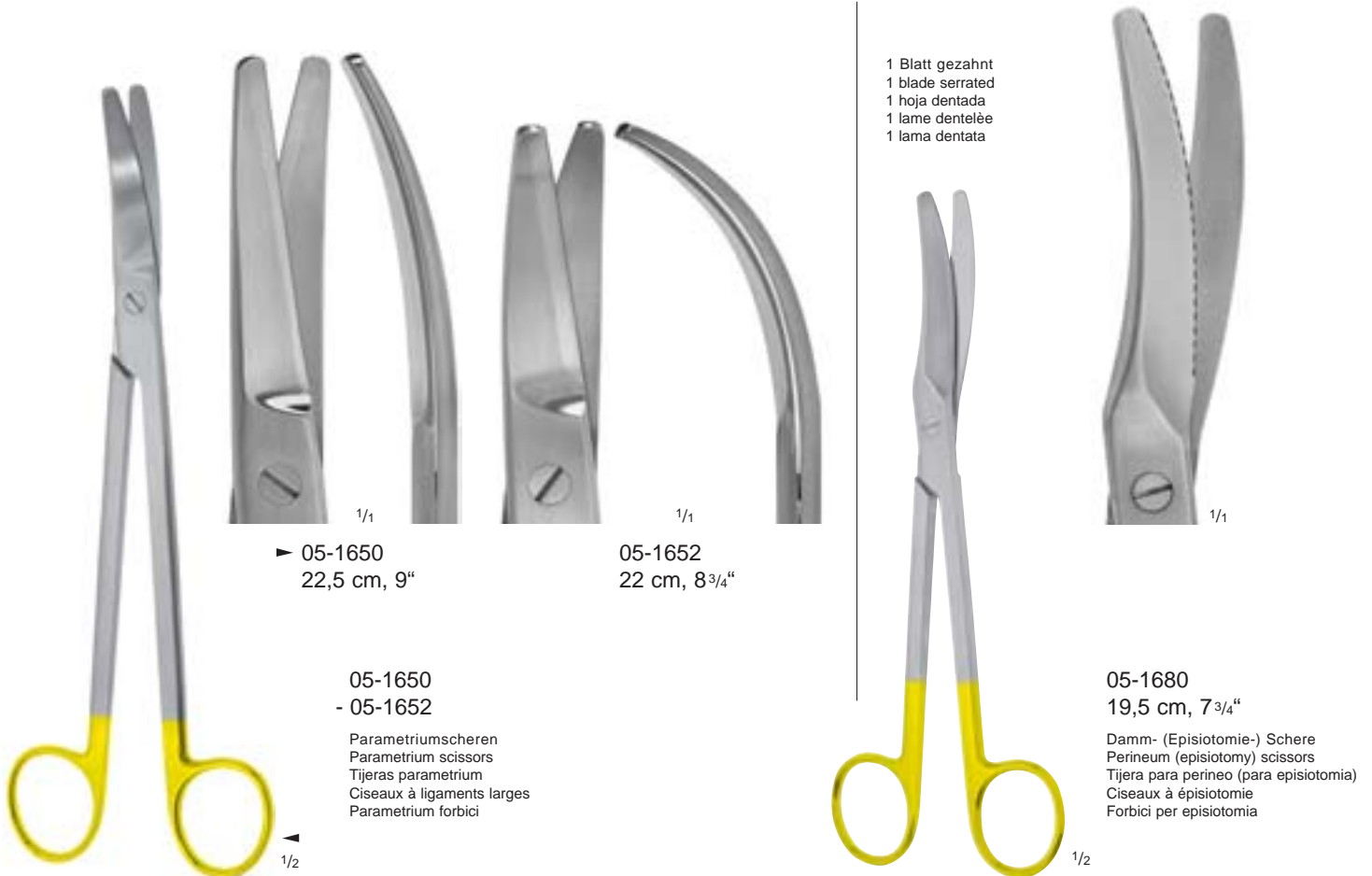

1 Blatt gezahnt
 1 blade serrated
 1 hoja dentada
 1 lame dentelée
 1 lama dentata

▶ 05-1650
 22,5 cm, 9"

05-1652
 22 cm, 8³/₄"

05-1650
 - 05-1652

Parametriumscheren
 Parametrium scissors
 Tijeras parametrium
 Ciseaux à ligaments larges
 Parametrium forbici

05-1680
 19,5 cm, 7³/₄"

Damm- (Episiotomie-) Schere
 Perineum (episiotomy) scissors
 Tijera para perineo (para episiotomia)
 Ciseaux à épisiotomie
 Forbici per episiotomia



LAWNTON
Medizintechnik



Scheren
Scissors
Tijeras
Ciseaux
Forbici



Mikro-Scheren mit flachen Federgriffen
Micro Scissors with Flat Spring Type Handles
Micro-tijeras con mangos de resortes planos
Micro-ciseaux avec manches à ressorts plats
Micro-forbici con manici a molla piatta

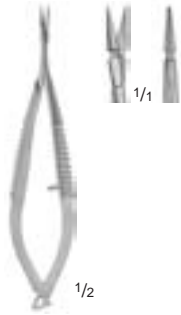

VANNAS
63-1400
8 cm, 3 1/8"

gerade
straight
recta
droit
retto

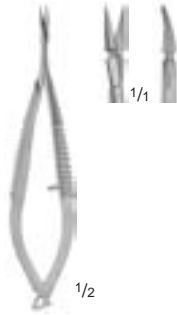

VANNAS
63-1401
8 cm, 3 1/8"

gebogen
curved
curva
courbe
curvo

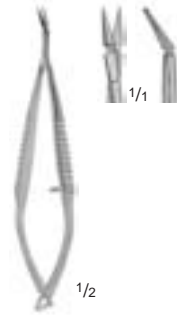

VANNAS
63-1402
8 cm, 3 1/8"

aufgewinkelt
angled on flat
angulada hacia arriba
coudé en haut
angolato in alto



VANNAS
63-1403
8 cm, 3 1/8"

seitlich abgewinkelt
angled on side
angulada hacia un lado
coudé sur le côté
angolato lateralmente

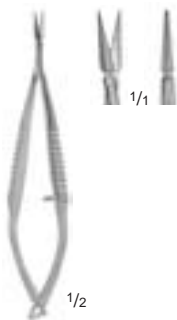

VANNAS
MOD. TÜBINGEN
63-1406
8,5 cm, 3 3/8"

gerade
straight
recta
droit
retto

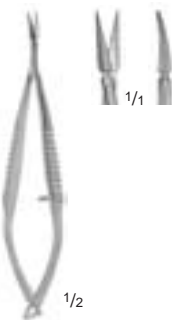

VANNAS
MOD. TÜBINGEN
63-1407
8,5 cm, 3 3/8"

gebogen
curved
curva
courbe
curvo

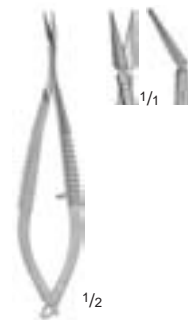

VANNAS
MOD. TÜBINGEN
63-1408
8,5 cm, 3 3/8"

aufgewinkelt
angled on flat
angulada hacia arriba
coudé en haut
angolato in alto

Mikro-Scheren mit flachen Federgriffen
 Micro Scissors with Flat Spring Type Handles
 Micro-tijeras con mangos de resortes planos
 Micro-ciseaux avec manches à ressorts plats
 Micro-forbici con manici a molla piatta



► 05-0020
 12 cm, 4³/₄"

gerade
 straight
 recta
 droit
 retto

1/2

VANNAS
 05-0020
 - 05-0023



1/1



1/1

05-0021
 12 cm, 4³/₄"

gebogen
 curved
 curva
 courbe
 curvo

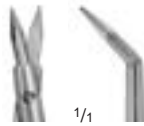

1/1

05-0023
 12 cm, 4³/₄"
 aufgewinkelt
 angled on flat
 angulada hacia arriba
 coudé en haut
 angolato in alto



► 05-0026
 16 cm, 6¹/₄"



1/1



1/1

05-0027
 16 cm, 6¹/₄"

1/2

VANNAS
 05-0026
 - 05-0027



► 05-0030
 12,5 cm, 5"

1/2

05-0030
 - 05-0031



1/1



1/1

05-0031
 12,5 cm, 5"



1/1

Venenschere
 Vein scissors
 Tijera para venas
 Ciseaux pour veines
 Forbici per vene

1/2

BIEMER
 05-0028
 12,5 cm, 5"



Mikro-Scheren mit flachen Federgriffen
 Micro Scissors with Flat Spring Type Handles
 Micro-tijeras con mangos de resortes planos
 Micro-ciseaux avec manches à ressorts plats
 Micro-forbici con manici a molla piatta



► 05-0034
16 cm, 6 1/4"



05-0035
16 cm, 6 1/4"

1/2

05-0034
- 05-0035



► 05-0038
16 cm, 6 1/4"



05-0039
16 cm, 6 1/4"

Schneiden gezahnt
 toothed blades
 hojas dentadas
 Lames dentelées
 Lame dentate

1/2

MILLES
 05-0038
 - 05-0039

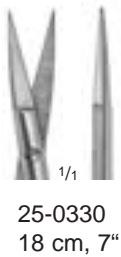

25-0330
18 cm, 7"



► 25-0331
18 cm, 7"

1/2

JACOBSON
 25-0330
 - 25-0331



25-0335
18 cm, 7"



► 25-0336
17,5 cm, 7"



25-0337
17 cm, 6 3/4"

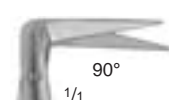

25-0338
16,5 cm, 6 1/2"



25-0339
16,5 cm, 6 1/2"

1/2

25-0335
 - 25-0339

seitlich abgewinkelt
 angled on side
 angulada hacia un lado
 coudé sur le côté
 angolate lateralmente

Mikro-Scheren mit runden Federgriffen
 Micro Scissors with Round Spring Type Handles
 Micro-tijeras con mangos de resortes redondos
 Micro-ciseaux avec manches à ressorts ronds
 Micro-forbici con manici a molla rotonda

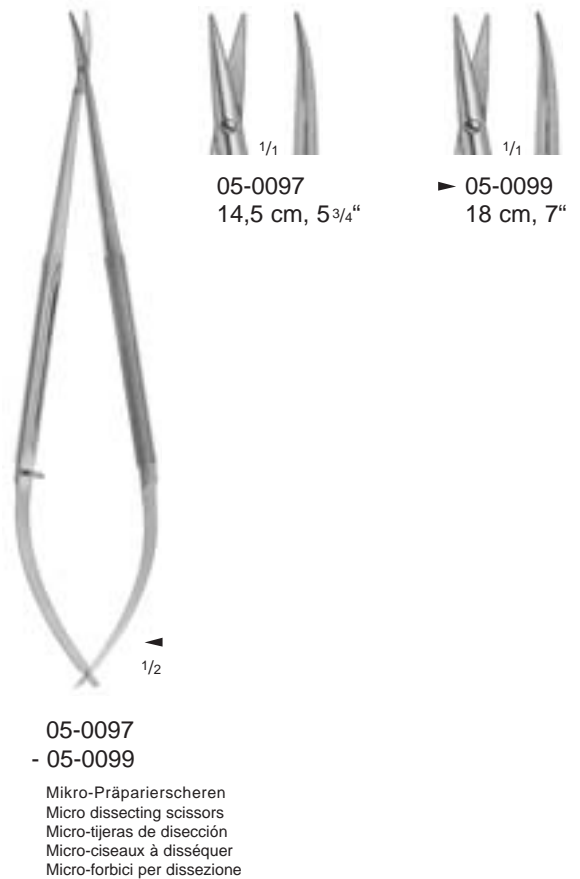
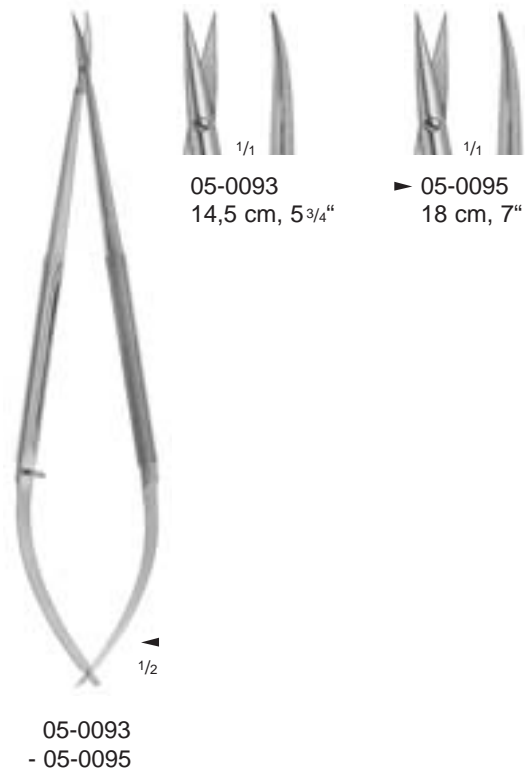
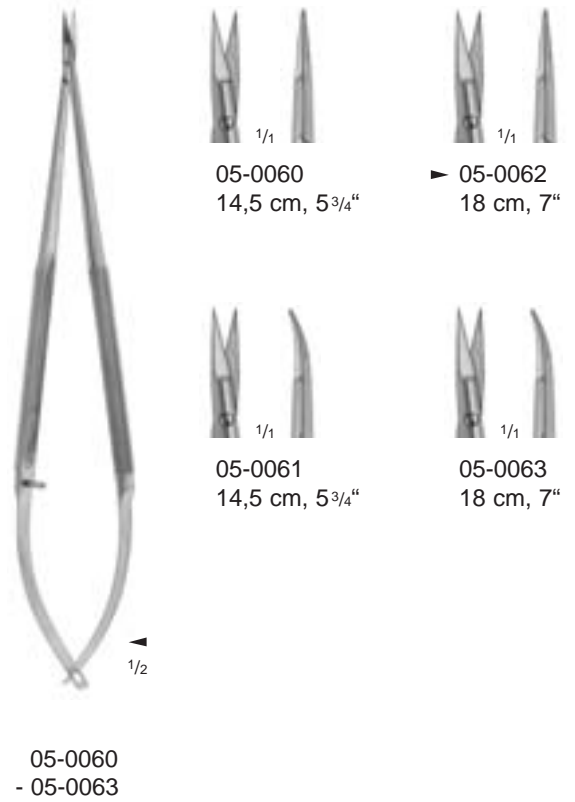
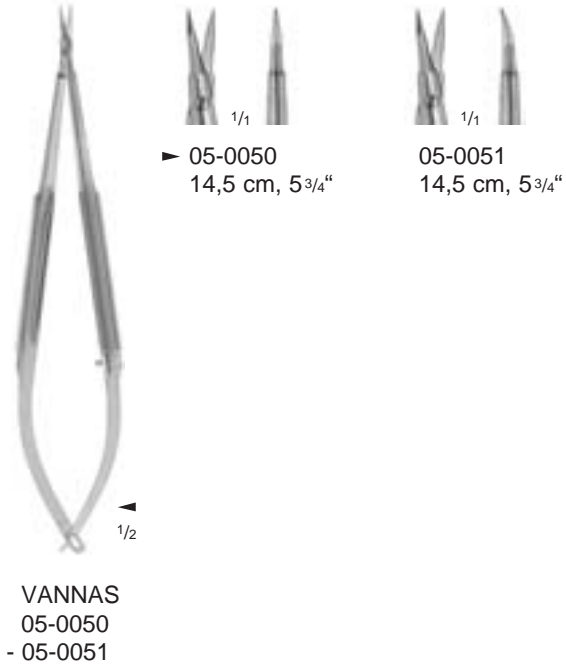



Mikro-Federscheren, bajonettförmig
 Micro Spring Type Scissors, bayonet-shaped
 Micro-tijeras con mangos de resortes, en forma bayoneta
 Micro-ciseaux en forme de baïonnette avec manches à ressorts
 Micro-forbici con manici a molla, forma a baionetta

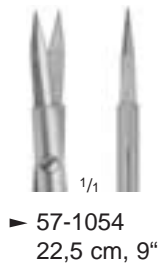

VANNAS-YASARGIL
57-1054
- 57-1055

◀ 1/2

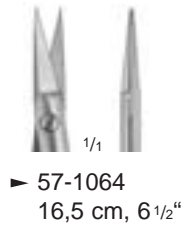

YASARGIL
57-1064
- 57-1065

◀ 1/2

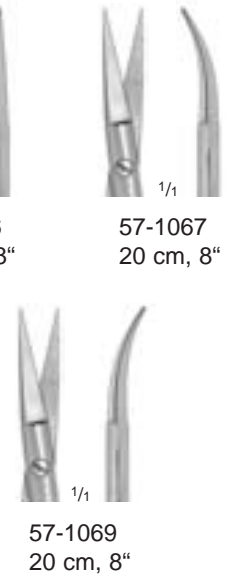
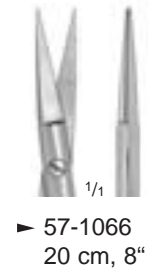

YASARGIL
57-1066
- 57-1069

◀ 1/2

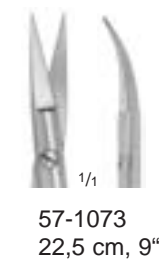
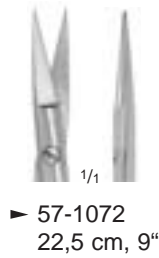

YASARGIL
57-1072
- 57-1073

◀ 1/2



YASARGIL
57-1074
22,5 cm, 9"

Schneiden gezahnt
toothed blades
hojas dentadas
Lames dentelées
Lame dentate

◀ 1/2



YASARGIL
57-1079
24,5 cm, 9 3/4"

◀ 1/2

Mikro-Federscheren, bajonettförmig
 Micro Spring Type Scissors, bayonet-shaped
 Micro-tijeras con mangos de resortes, en forma bayoneta
 Micro-ciseaux en forme de baïonnette avec manches à ressorts
 Micro-forbici con manici a molla, forma a baionetta

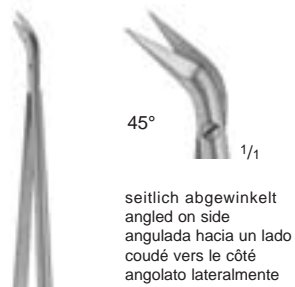

NAGEL
 57-1081
 19,5 cm, 7 3/4"

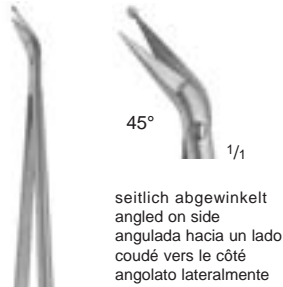

57-1082
 19,5 cm, 7 3/4"



57-1083
 18,5 cm, 7 1/4"

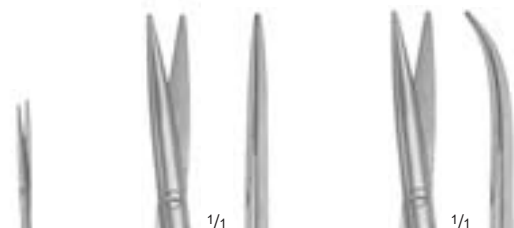

► 57-1086
 20 cm, 8"

57-1087
 20 cm, 8"



YASARGIL
 57-1086
 - 57-1087

Mikro-Präparierscheren
 Micro dissecting scissors
 Micro-tijeras de disección
 Micro-ciseaux à disséquer
 Micro-forbici per dissezione

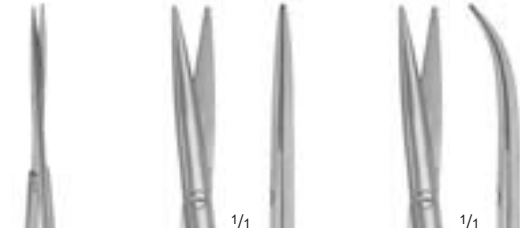

► 57-1088
 22,5 cm, 9"

57-1089
 22,5 cm, 9"



YASARGIL
 57-1088
 - 57-1089

Mikro-Präparierscheren
 Micro dissecting scissors
 Micro-tijeras de disección
 Micro-ciseaux à disséquer
 Micro-forbici per dissezione



Feine chirurgische Scheren
 Delicate Surgical Scissors
 Tijeras finas para cirugía
 Ciseaux chirurgicaux fins
 Forbici fine per chirurgia



▶ 63-0906
9 cm, 3 1/2"



▶ 63-0910
10 cm, 4"



▶ 05-0330
10,5 cm, 4 1/8"



63-0906
- 63-0907



63-0907
9 cm, 3 1/2"



63-0910
- 63-0911



63-0911
10 cm, 4"



05-0330
- 05-0331



05-0331
10,5 cm, 4 1/8"



▶ 63-0330
10,5 cm, 4 1/8"



▶ 63-0331
10,5 cm, 4 1/8"



▶ 76-0415
11 cm, 4 3/8"



KNAPP
63-0330
- 63-0332



63-0332
10,5 cm, 4 1/8"



KNAPP
63-0331
- 63-0333



63-0333
10,5 cm, 4 1/8"



SEALY
76-0415
- 76-0416



76-0416
11 cm, 4 3/8"

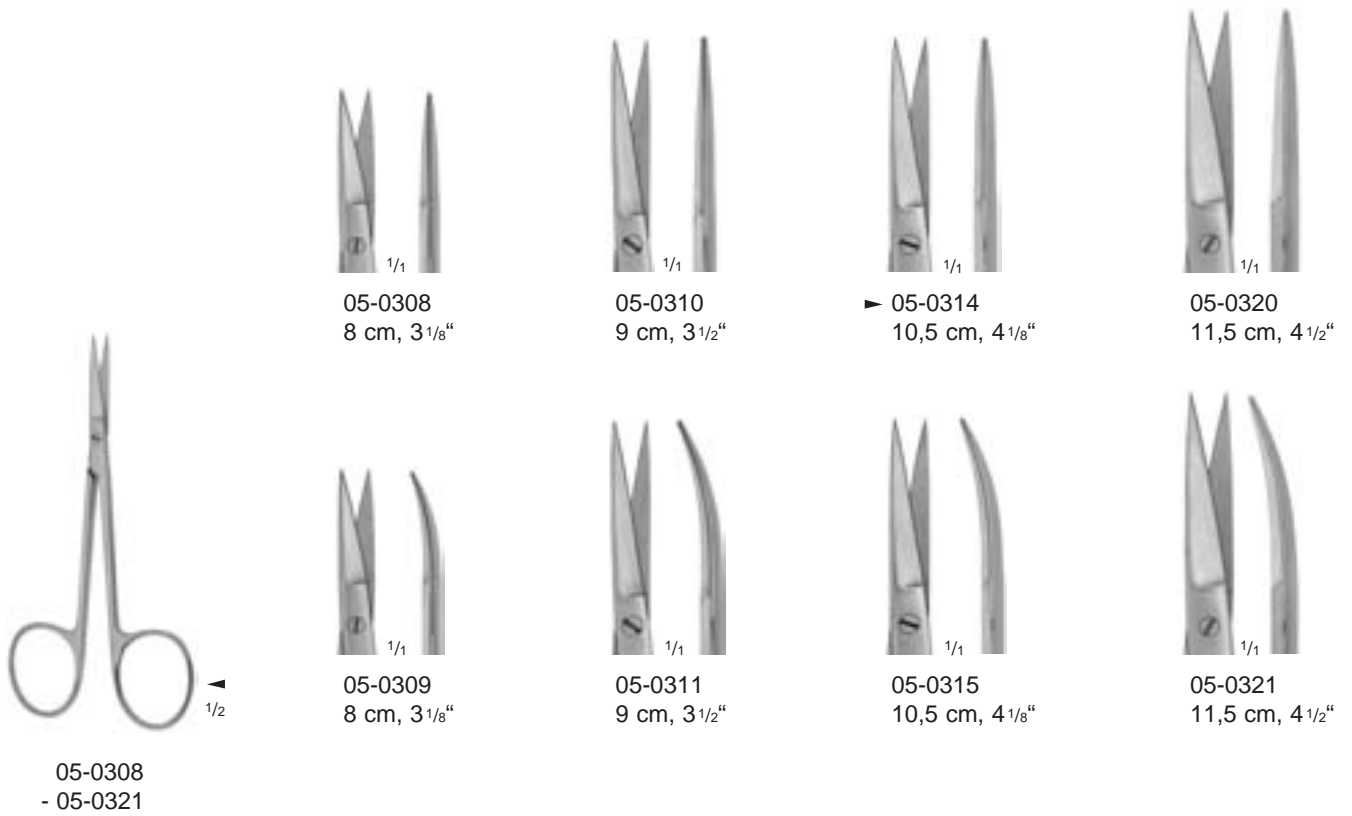



Feine chirurgische Scheren
 Delicate Surgical Scissors
 Tijeras finas para cirugía
 Ciseaux chirurgicaux fins
 Forbici fine per chirurgia

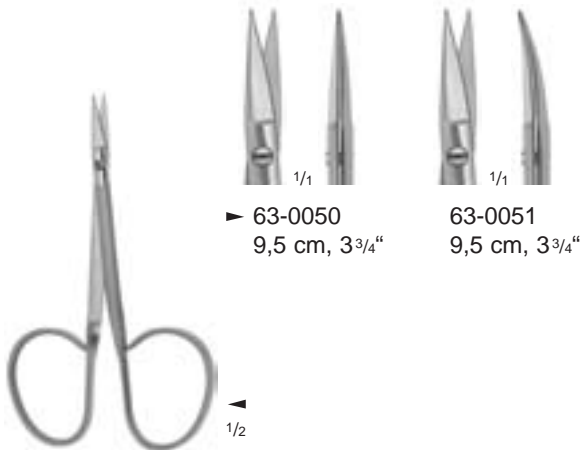

▶ 63-0050 9,5 cm, 3³/₄"
 ▶ 63-0051 9,5 cm, 3³/₄"

63-0050
 - 63-0051

mit flachen Branchen und großen ergonomischen Ringen
 with flat shanks and large ergonomic rings
 brazos de la tijera planos y con grandes anillos ergonómicos
 avec branches plates et grands anneaux ergonomiques
 con fusto piatto e grandi anelli ergonomici

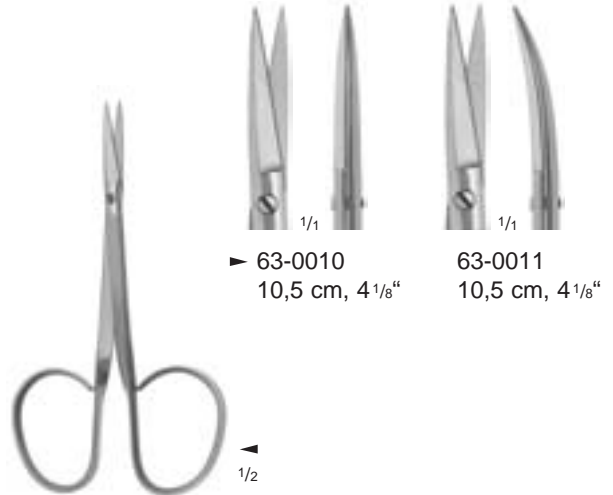

▶ 63-0010 10,5 cm, 4¹/₈"
 ▶ 63-0011 10,5 cm, 4¹/₈"

63-0010
 - 63-0011

mit flachen Branchen und großen ergonomischen Ringen
 with flat shanks and large ergonomic rings
 brazos de la tijera planos y con grandes anillos ergonómicos
 avec branches plates et grands anneaux ergonomiques
 con fusto piatto e grandi anelli ergonomici

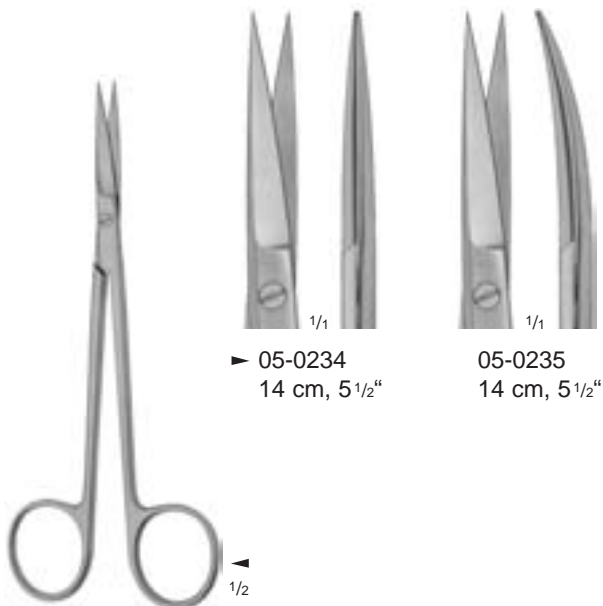

▶ 05-0234 14 cm, 5¹/₂"
 ▶ 05-0235 14 cm, 5¹/₂"

SANVENERO
 05-0234
 - 05-0235

Scheren für plastische Chirurgie
 Plastic surgery scissors
 Tijeras para la cirugía plástica
 Ciseaux pour chirurgie plastique
 Forbici per la chirurgia plastica

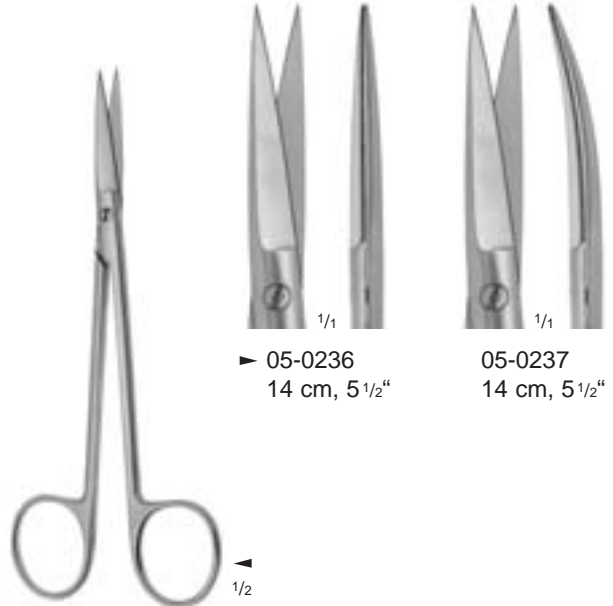

▶ 05-0236 14 cm, 5¹/₂"
 ▶ 05-0237 14 cm, 5¹/₂"

JOSEPH
 05-0236
 - 05-0237

Scheren für plastische Chirurgie
 Plastic surgery scissors
 Tijeras para la cirugía plástica
 Ciseaux pour chirurgie plastique
 Forbici per la chirurgia plastica



► 05-0220
 14 cm, 5 1/2"



► 05-0222
 14 cm, 5 1/2"



► 05-0224
 14 cm, 5 1/2"



05-0221
 14 cm, 5 1/2"



DEAVER
 05-0220
 - 05-0221



05-0223
 14 cm, 5 1/2"



DEAVER
 05-0222
 - 05-0223



05-0225
 14 cm, 5 1/2"



DEAVER
 05-0224
 - 05-0225



Chirurgische Scheren
Surgical Scissors
Tijeras para cirugía
Ciseaux à chirurgie
Forbici per chirurgia



05-0100
12 cm, 4^{3/4}"



05-0101
13 cm, 5^{1/8}"



▶ 05-0102
14,5 cm, 5^{3/4}"



05-0100
- 05-0104

Standard Modelle
Standard patterns
modelos standard
modèles standard
modelli standard



05-0103
15 cm, 6"



05-0104
16,5 cm, 6^{1/2}"



05-0105
 12 cm, 4^{3/4}"



05-0106
 13 cm, 5^{1/8}"



▶ 05-0107
 14,5 cm, 5^{3/4}"



05-0105
 - 05-0109

Standard Modelle
 Standard patterns
 modelos standard
 modèles standard
 modelli standard



05-0108
 15 cm, 6"



05-0109
 16,5 cm, 6^{1/2}"



Chirurgische Scheren
Surgical Scissors
Tijeras para cirugía
Ciseaux à chirurgie
Forbici per chirurgia



05-0110
12 cm, 4^{3/4}"



05-0111
13 cm, 5^{1/8}"



▶ 05-0112
14,5 cm, 5^{3/4}"



05-0113
15 cm, 6"

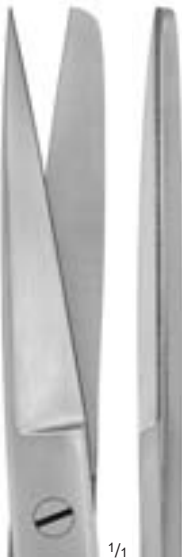

05-0114
16,5 cm, 6^{1/2}"



05-0135
17,5 cm, 7"



05-0136
18,5 cm, 7^{1/4}"



05-0138
20,5 cm, 8"



05-0110
- 05-0138

Standard Modelle
Standard patterns
modelos standard
modèles standard
modelli standard



05-0115
 12 cm, 4³/₄"



05-0116
 13 cm, 5¹/₈"



► 05-0117
 14,5 cm, 5³/₄"



05-0118
 15 cm, 6"



05-0119
 16,5 cm, 6¹/₂"



05-0145
 17,5 cm, 7"



05-0146
 18,5 cm, 7¹/₄"



05-0148
 20,5 cm, 8"



05-0115
 - 05-0148

Standard Modelle
 Standard patterns
 modelos standard
 modèles standard
 modelli standard



Chirurgische Scheren
Surgical Scissors
Tijeras para cirugía
Ciseaux à chirurgie
Forbici per chirurgia



05-0120
12 cm, 4³/₄"



05-0121
13 cm, 5¹/₈"



▶ 05-0122
14,5 cm, 5³/₄"



05-0123
15 cm, 6"



05-0124
16,5 cm, 6¹/₂"



05-0155
17,5 cm, 7"



05-0156
18,5 cm, 7¹/₄"



05-0158
20,5 cm, 8"



05-0120
- 05-0158

Standard Modelle
Standard patterns
modelos standard
modèles standard
modelli standard



05-0125
 12 cm, 4³/₄"



05-0126
 13 cm, 5¹/₈"



▶ 05-0127
 14,5 cm, 5³/₄"



05-0128
 15 cm, 6"



05-0129
 16,5 cm, 6¹/₂"



05-0185
 17,5 cm, 7"



05-0186
 18,5 cm, 7¹/₄"



05-0188
 20,5 cm, 8"



05-0125
 - 05-0188

Standard Modelle
 Standard patterns
 modelos standard
 modèles standard
 modelli standard



Chirurgische Scheren
 Surgical Scissors
 Tijeras para cirugía
 Ciseaux à chirurgie
 Forbici per chirurgia



05-0200 12,5 cm, 5"
 05-0210 13 cm, 5 1/8"
 ▶ 05-0250 14,5 cm, 5 3/4"

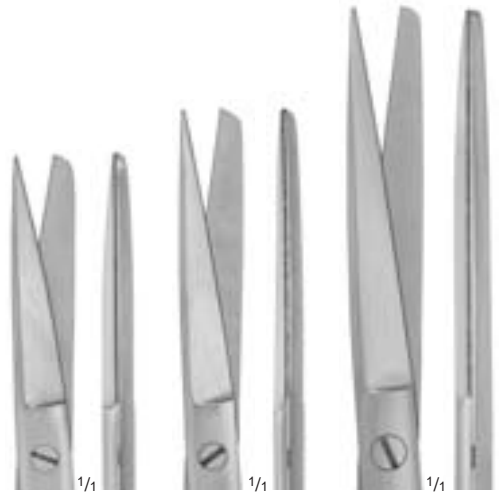

05-0202 12,5 cm, 5"
 05-0212 13 cm, 5 1/8"
 ▶ 05-0252 14,5 cm, 5 3/4"

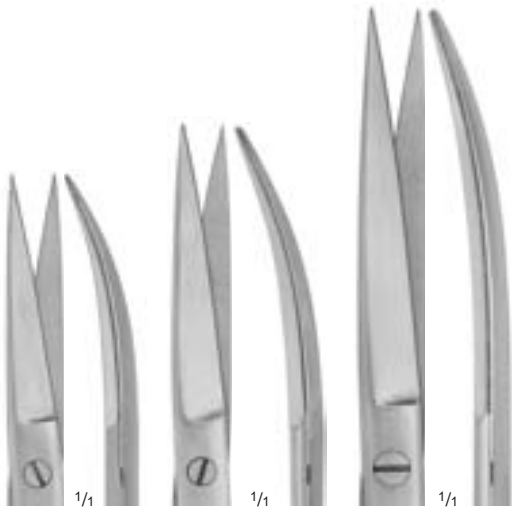

05-0201 12,5 cm, 5"
 05-0211 13 cm, 5 1/8"
 05-0251 14,5 cm, 5 3/4"

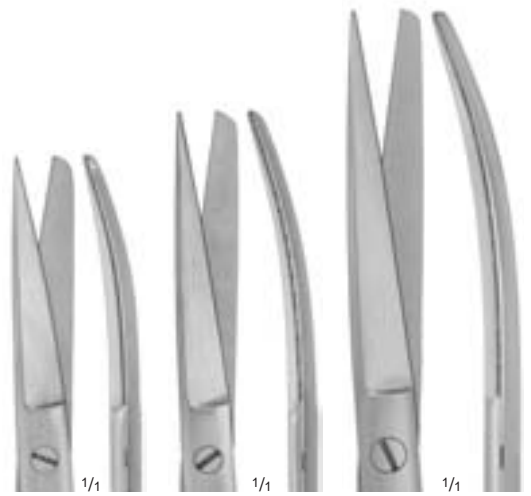

05-0203 12,5 cm, 5"
 05-0213 13 cm, 5 1/8"
 05-0253 14,5 cm, 5 3/4"



05-0200
 - 05-0251
 schlanke Modelle
 slender patterns
 modelos finos
 modèles fins
 modelli fini



05-0202
 - 05-0253
 schlanke Modelle
 slender patterns
 modelos finos
 modèles fins
 modelli fini



05-0204
 12,5 cm, 5"



05-0214
 13 cm, 5 1/8"



▶ 05-0254
 14,5 cm, 5 3/4"



▶ 05-0230
 15,5 cm, 6"



05-0205
 12,5 cm, 5"



05-0215
 13 cm, 5 1/8"



05-0255
 14,5 cm, 5 3/4"



05-0231
 15,5 cm, 6"



05-0204
 - 05-0255

schlanke Modelle
 slender patterns
 modelos finos
 modèles fins
 modelli fini



MIXTER
 05-0230
 - 05-0231



Chirurgische Scheren
Surgical Scissors
Tijeras para cirugía
Ciseaux à chirurgie
Forbici per chirurgia



► 05-0240
16 cm, 6 1/4"



05-0241
16 cm, 6 1/4"

KELLY
05-0240
- 05-0241

Gefäß- und Fistelscheren
Vascular and fistula scissors
Tijeras para vasos y fistulas
Ciseaux vasculaires et pour des fistules
Forbici vascolare e per fistole



RICHTER
05-0177
14 cm, 5 1/2"

Operationsschere
Operating scissors
Tijera para operaciones
Ciseaux pour opérations
Forbici per operazioni



► 05-0166
13 cm, 5 1/8"



05-0167
14,5 cm, 5 3/4"

05-0166
- 05-0167

Inzisionsscheren
Incision scissors
Tijeras para incisión
Ciseaux à incision
Forbici incisione



FERGUSON
05-0785
18 cm, 7"

Operationsschere
Operating scissors
Tijera para operaciones
Ciseaux pour opérations
Forbici per operazioni

Chirurgische Scheren
Surgical Scissors
Tijeras para cirugía
Ciseaux à chirurgie
Forbici per chirurgia

Präparierscheren
Dissecting Scissors
Tijeras de disección
Ciseaux à dissection
Forbici per dissezione



SYSTRUNK
05-0197
13 cm, 5 1/8"

Nagelspaltschere
Nail splitting scissors
Tijera para hender las uñas
Ciseaux à fendre les ongles
Forbici per fissurare le unghie



05-0198
15,5 cm, 6"

Nagelspaltschere
Nail splitting scissors
Tijera para hender las uñas
Ciseaux à fendre les ongles
Forbici per fissurare le unghie

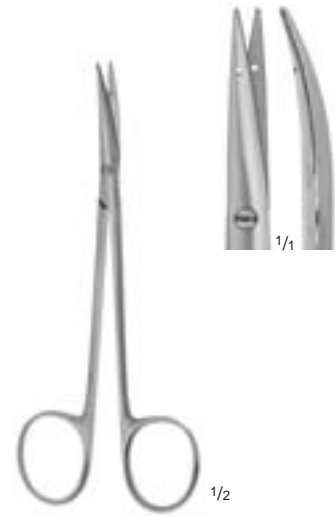

LITTLER
76-0760
12 cm, 4 3/4"

Präparierschere mit Fadenbohrung
in der Spitze
Dissecting scissors, tips with eye for
suture
Tijera de disección, con ojal en las
puntas
Ciseaux à dissection avec chas
Forbici per dissezione con foro per
il filo alla punta



05-0549
12 cm, 4 3/4"

Präparierschere
Dissecting scissors
Tijera de disección
Ciseaux à dissection
Forbici per dissezione



FOMON
76-0620
11,5 cm, 4 1/2"

Nasenflügelschere
Lower lateral scissors
Tijera para ala nasal
Ciseaux pour ailes du nez
Forbici con aletta nasale



FOMON
76-0623
14 cm, 5 1/2"

Nasenflügelschere
Lower lateral scissors
Tijera para ala nasal
Ciseaux pour ailes du nez
Forbici con aletta nasale



Chirurgische Scheren und Präparierscheren, Blätter außen angeschliffen

Surgical and Dissecting Scissors, outside cutting edges

Tijeras para cirugía y disección, con filos de corte exteriores

Ciseaux à chirurgie et à dissection, lames aiguisées à l'extérieur

Forbici per chirurgia e per dissezione, con lame affilate all'esterno



▶ 76-0610
13,5 cm, 5 1/4"



76-0611
13,5 cm, 5 1/4"

1 Blatt gezahnt
1 blade serrated
1 hoja dentada
1 lame dentelée
1 lama dentata

FOMON
76-0610
- 76-0611

Scheren für plastische Chirurgie
Plastic surgery scissors
Tijeras para la cirugía plástica
Ciseaux pour chirurgie plastique
Forbici per la chirurgia plastica



▶ 76-0472
15 cm, 6"



76-0473
15 cm, 6"

AUFRICT
76-0472
- 76-0473

Scheren für plastische Chirurgie
Plastic surgery scissors
Tijeras para la cirugía plástica
Ciseaux pour chirurgie plastique
Forbici per la chirurgia plastica



▶ 76-0478
19,5 cm, 7 3/4"



76-0479
19,5 cm, 7 3/4"

Blätter innen fein gezahnt
blades inside with fine serration
hojas dentadas finas en el interior
lames dentelées délicatement à l'intérieur
lama interne finemente dentate

GORNEY
76-0478
- 76-0479

Scheren für plastische Chirurgie
Plastic surgery scissors
Tijeras para la cirugía plástica
Ciseaux pour chirurgie plastique
Forbici per la chirurgia plastica



MC INDOE
76-0475
18,5 cm, 7 1/4"



Knorpelschere
Scissors for cartilage
Tijera para cartilago
Ciseaux pour cartilage
Forbici per cartilagini

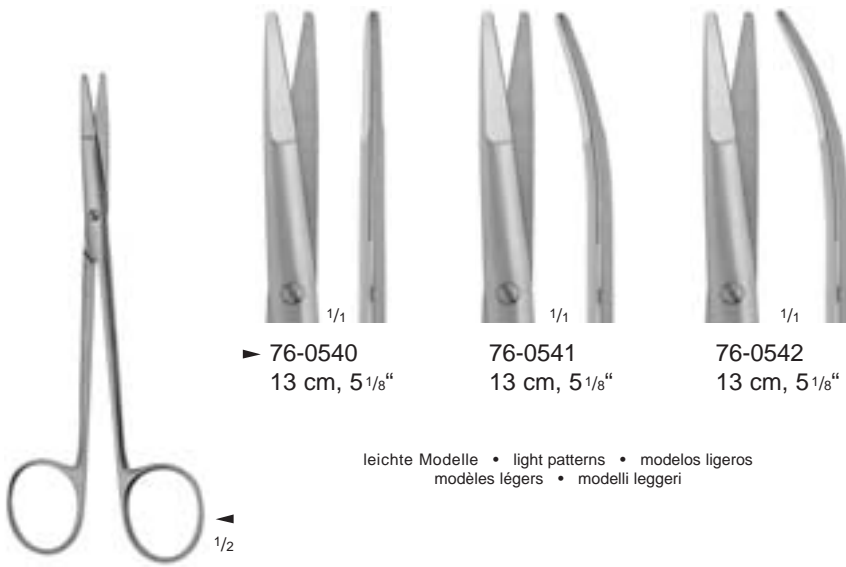

▶ 76-0540
13 cm, 5 1/8"

76-0541
13 cm, 5 1/8"

76-0542
13 cm, 5 1/8"

leichte Modelle • light patterns • modelos ligeros
 modèles légers • modelli leggeri

RAGNELL
76-0540
- 76-0542

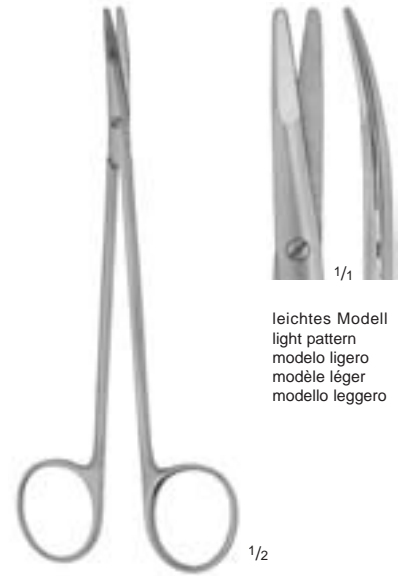

1/1

leichtes Modell
light pattern
modelo ligero
modèle léger
modello leggero

RAGNELL
76-0543
15 cm, 6"



05-0541
12,5 cm, 5"

05-0585
13,5 cm, 5 1/4"

▶ 05-0543
15 cm, 6"

05-0587
17,5 cm, 7"

kräftige Modelle • heavy patterns • modelos fuertes
 modèles fort • modelli robusti

KILNER (GLASSMANN)
05-0541
- 05-0587

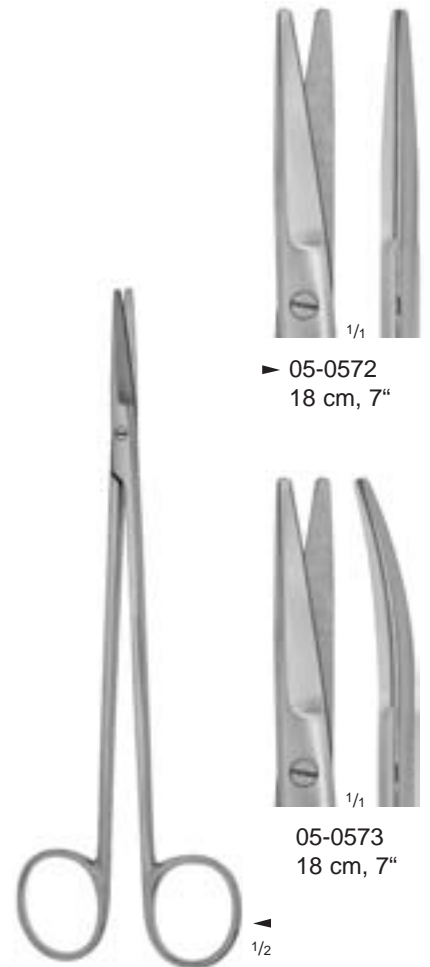

▶ 05-0572
18 cm, 7"

05-0573
18 cm, 7"

TOENNIS
05-0572
- 05-0573



Präparierscheren
Dissecting Scissors
Tijeras de disección
Ciseaux à dissection
Forbici per dissezione



05-0450
14,5 cm, 5³/₄"



▶ 05-0452
15 cm, 6"



05-0460
17 cm, 6³/₄"



05-0464
23 cm, 9"



05-0451
14,5 cm, 5³/₄"



05-0453
15 cm, 6"



05-0461
17 cm, 6³/₄"



05-0465
23 cm, 9"



MAYO
05-0450
- 05-0465



05-0482
 15 cm, 6"



▶ 05-0490
 17 cm, 6³/₄"



05-0492
 19,5 cm, 7³/₄"



MAYO-STILLE
 05-0482
 - 05-0495



05-0483
 15 cm, 6"



05-0491
 17 cm, 6³/₄"



05-0493
 19,5 cm, 7³/₄"



05-0495
 21 cm, 8¹/₄"



Präparierscheren
Dissecting Scissors
Tijeras de disección
Ciseaux à dissection
Forbici per dissezione



► 05-0400
16,5 cm, 6 1/2"



► 05-0470
23 cm, 9"



05-0401
16,5 cm, 6 1/2"



05-0471
23 cm, 9"



MAYO-NOBLE
05-0400
- 05-0401



MAYO-HARRINGTON
05-0470
- 05-0471



▶ 05-0550
 10,5 cm, 4 1/8"



▶ 05-0420
 16 cm, 6 1/4"



▶ 05-0416
 16,5 cm, 6 1/2"



05-0551
 10,5 cm, 4 1/8"



05-0421
 16 cm, 6 1/4"



05-0417
 16,5 cm, 6 1/2"



BABY-LEXER
 05-0550
 - 05-0551



MAYO-LEXER
 05-0420
 - 05-0421



LEXER
 05-0416
 - 05-0417



Präparierscheren
Dissecting Scissors
Tijeras de disección
Ciseaux à dissection
Forbici per dissezione



63-0200
- 63-0202



▶ 63-0200
10,5 cm, 4 1/8"



▶ 63-0201
10,5 cm, 4 1/8"



▶ 63-0202
10,5 cm, 4 1/8"

mit flachen Branchen und großen ergonomischen Ringen
with flat shanks and large ergonomical rings
brazos de la tijera planos y con grandes anillos ergonómicos
avec branches plates et grands anneaux ergonomiques
con fusto piatto e grandi anelli ergonomici



▶ 63-0402
11,5 cm, 4 1/2"



▶ 63-0403
11,5 cm, 4 1/2"



METZENBAUM
63-0402
- 63-0403



▶ 05-0554
12,5 cm, 5"



▶ 05-0555
12,5 cm, 5"



METZENBAUM
05-0554
- 05-0555

Präparierscheren

Dissecting Scissors

Tijeras de disección

Ciseaux à dissection

Forbici per dissezione

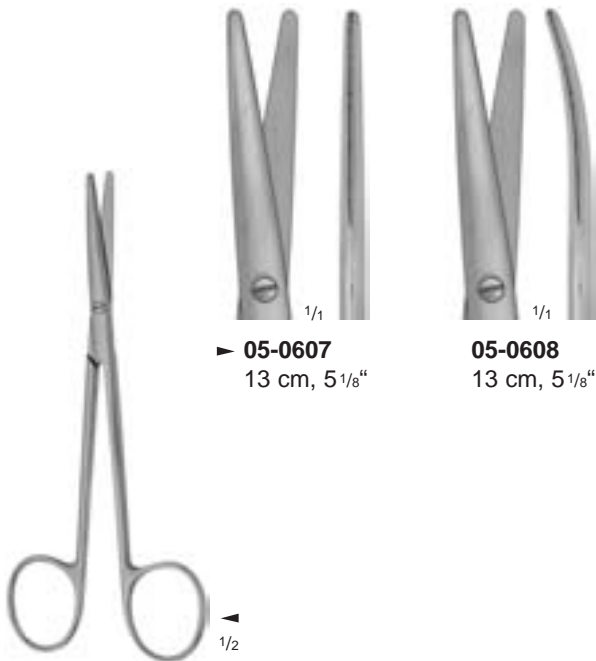

► **05-0607**
13 cm, 5 1/8"

05-0608
13 cm, 5 1/8"

METZENBAUM
05-0607
- **05-0608**



► **05-0560**
14,5 cm, 5 3/4"

05-0561
14,5 cm, 5 3/4"

BABY-METZENBAUM
05-0560
- **05-0561**

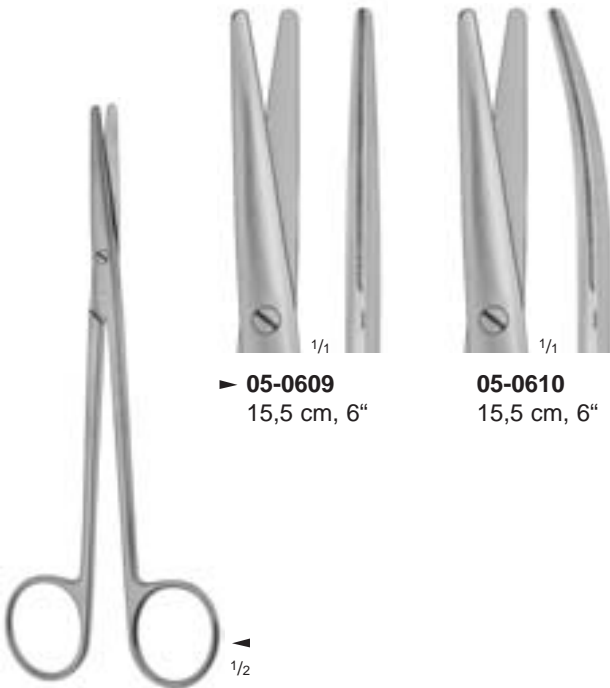

► **05-0609**
15,5 cm, 6"

05-0610
15,5 cm, 6"

METZENBAUM
05-0609
- **05-0610**



sehr feines Model
very delicate pattern
modelo muy fino
modèle très fin
modello molto delicato

TOENNIS-ADSON
05-0575
17,5 cm, 7"



Präparierscheren
 Dissecting Scissors
 Tijeras de disección
 Ciseaux à dissection
 Forbici per dissezione



► **05-0619**
18 cm, 7"

05-0621
20,5 cm, 8"

05-0640
23 cm, 9"

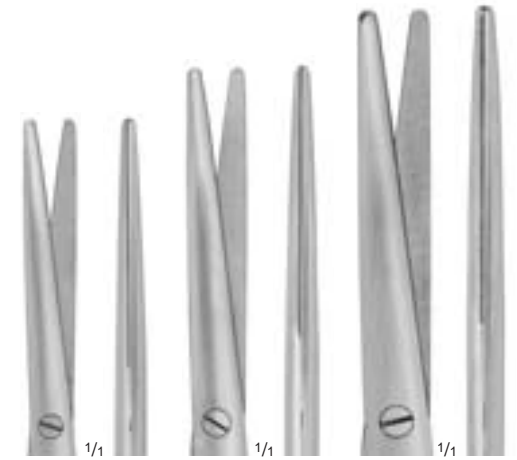

► **05-0660**
18 cm, 7"

05-0662
20,5 cm, 8"

05-0664
23 cm, 9"



05-0620
18 cm, 7"

05-0622
20,5 cm, 8"

05-0641
23 cm, 9"

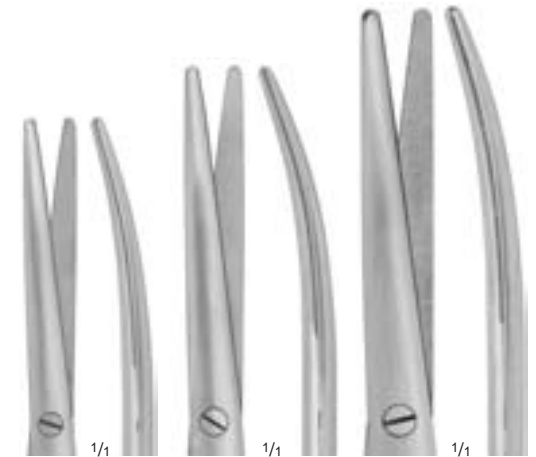

05-0661
18 cm, 7"

05-0663
20,5 cm, 8"

05-0665
23 cm, 9"

Standard Modelle
 Standard patterns
 modelos standard
 modèles standard
 modelli standard

feine Modelle
 delicate patterns
 modelos finos
 modèles fins
 modelli delicati



METZENBAUM
05-0619
 - **05-0641**



METZENBAUM
05-0660
 - **05-0665**

Präparierscheren

Dissecting Scissors

Tijeras de disección

Ciseaux à dissection

Forbici per dissezione



05-0642
26 cm, 10 1/4"



▶ **05-0644**
28,5 cm, 11 1/4"



05-0643
26 cm, 10 1/4"



05-0645
28,5 cm, 11 1/4"



NELSON-METZENBAUM
05-0642
- **05-0645**



Feine Präparier- und Sehnenscheren

Delicate Dissecting and Tendon Scissors

Tijeras finas de disección y tenotomía

Ciseaux fins à dissection et à ténotomie

Forbici fine per dissezione e per tenotomia

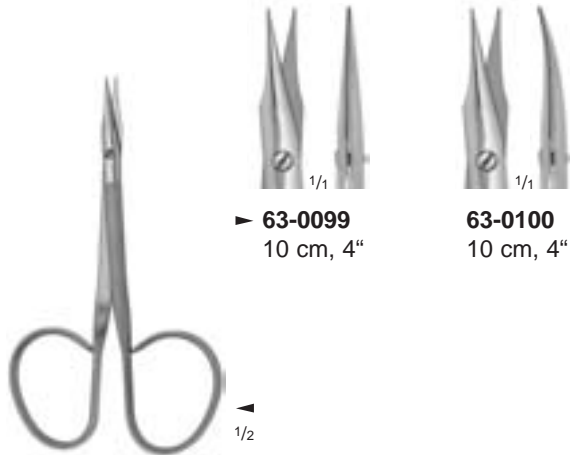

▶ **63-0099**
10 cm, 4"

▶ **63-0100**
10 cm, 4"

STEVENS
63-0099
- **63-0100**

mit flachen Branchen und großen ergonomischen Ringen
with flat shanks and large ergonomical rings
brazos de la tijera planos y con grandes anillos ergonómicos
avec branches plates et grands anneaux ergonomiques
con fusto piatto e grandi anelli ergonomici

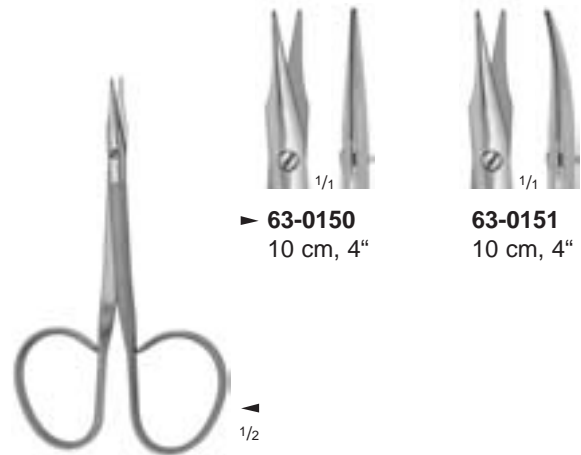

▶ **63-0150**
10 cm, 4"

▶ **63-0151**
10 cm, 4"

STEVENS
63-0150
- **63-0151**

mit flachen Branchen und großen ergonomischen Ringen
with flat shanks and large ergonomical rings
brazos de la tijera planos y con grandes anillos ergonómicos
avec branches plates et grands anneaux ergonomiques
con fusto piatto e grandi anelli ergonomici



▶ **05-0340**
10,5 cm, 4 1/8"

▶ **05-0341**
10,5 cm, 4 1/8"

STEVENS
05-0340
- **05-0341**

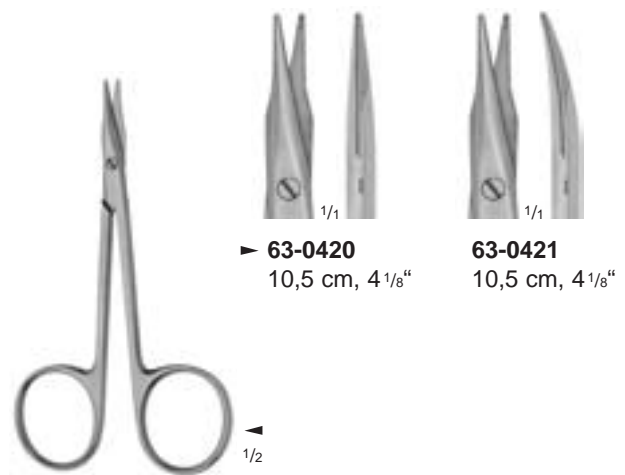

▶ **63-0420**
10,5 cm, 4 1/8"

▶ **63-0421**
10,5 cm, 4 1/8"

STEVENS
63-0420
- **63-0421**

Feine Präparierscheren
 Delicate Dissecting Scissors
 Tijeras de disección
 Ciseaux fins à dissection
 Forbici fine per dissezione

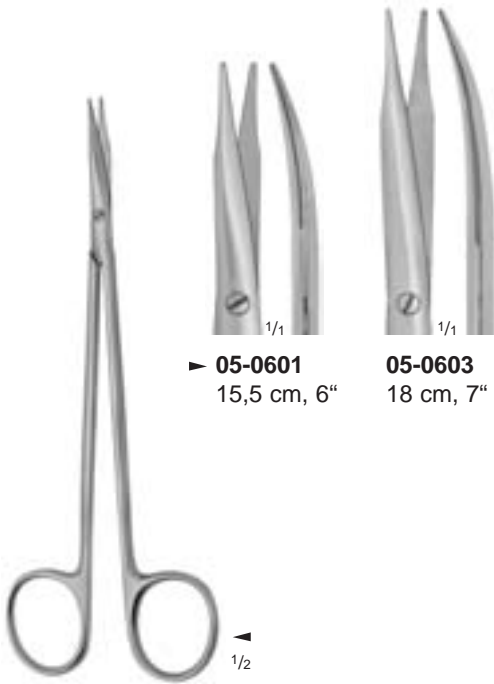

► **05-0601** 15,5 cm, 6"
05-0603 18 cm, 7"

JAMESON
05-0601
- 05-0603

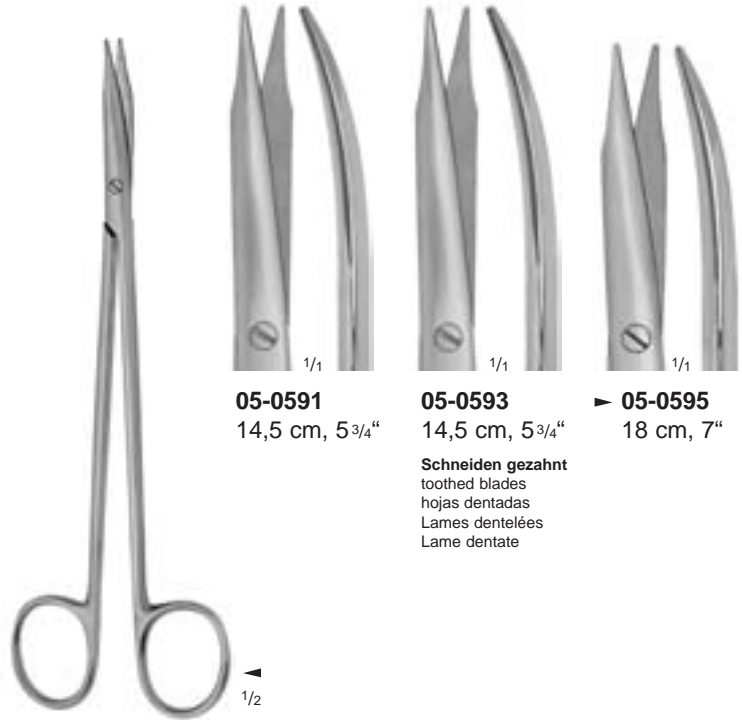

05-0591 14,5 cm, 5 3/4"
05-0593 14,5 cm, 5 3/4"
 ► **05-0595** 18 cm, 7"

Schneiden gezahnt
 toothed blades
 hojas dentadas
 Lames dentelées
 Lame dentate

REYNOLDS
05-0591
- 05-0595

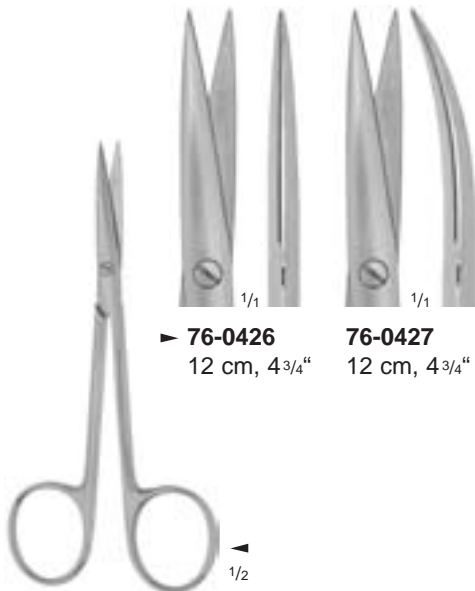

► **76-0426** 12 cm, 4 3/4"
76-0427 12 cm, 4 3/4"

KILNER
76-0426
- 76-0427



► **76-0570** 14,5 cm, 5 3/4"
76-0571 14,5 cm, 5 3/4"

BROPHY (SULLIVAN)
76-0570
- 76-0571

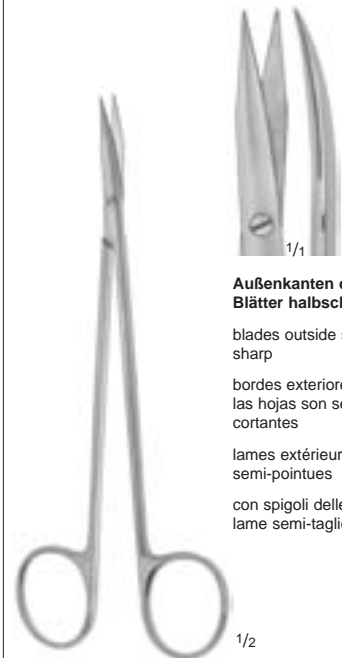

Außenkanten der Blätter halbscharf
 blades outside semi-sharp
 bordes exteriores de las hojas son semi-cortantes
 lames extérieures semi-pointues
 con spigoli delle lame semi-taglienti

05-0567
 15 cm, 6"

Nerv-Präparierschere
 Nerve dissecting scissors
 Tijera para nervios
 Ciseaux à dissection des nerfs
 Forbici per dissezione di nervi



Zahnfleischscheren

Gum Scissors

Tijeras para encías

Ciseaux pour gencive

Forbici per gengiva



LA GRANGE
63-1360
11,5 cm, 4 1/2"



GOLDMANN-FOX
05-0440
- **05-0441**



► **05-0440**
13 cm, 5 1/8"



05-0441
13 cm, 5 1/8"

1 Blatt gezahnt
1 blade serrated
1 hoja dentada
1 lame dentelée
1 lama dentata



QUINBY
76-0561
13 cm, 5 1/8"

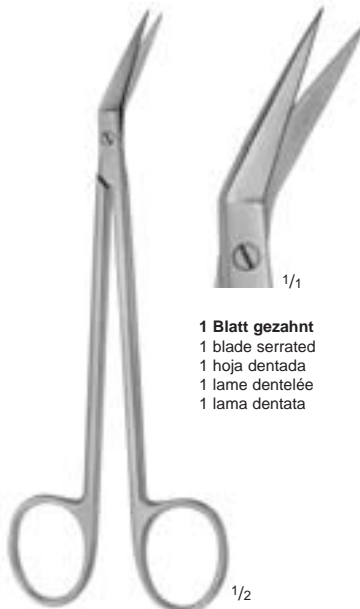

LOCKLIN
05-0443
16 cm, 6 1/4"

1 Blatt gezahnt
1 blade serrated
1 hoja dentada
1 lame dentelée
1 lama dentata

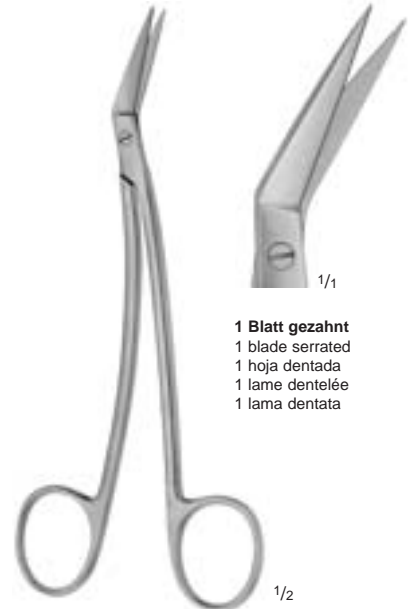

LOCKLIN
05-0445
16 cm, 6 1/4"

1 Blatt gezahnt
1 blade serrated
1 hoja dentada
1 lame dentelée
1 lama dentata

Gefäßscheren

Vascular Scissors

Tijeras vasculares

Ciseaux vasculaires

Forbici vascolari

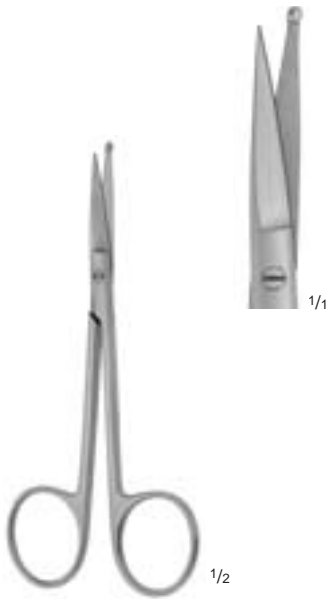

05-0364
12 cm, 4³/₄"

Präparierschere mit 1 geknöpften Blatt
Dissecting scissors with 1 probe-pointed blade
Tijera de disección con una punta botonada
Ciseaux à dissection avec 1 lame boutonnée
Forbici per dissezione con 1 lama botonuta



05-0366
14,5 cm, 5³/₄"

Präparierschere mit Sondenspitze
Dissecting scissors with 1 probe-pointed blade
Tijera de disección con una punta de sonda
Ciseaux à dissection avec 1 pointe pour sonde
Forbici per dissezione con 1 punta per sonda



FAVALORO
30-0187
14 cm, 5¹/₂"

Coronararterien-Schere
Coronary artery scissors
Tijera para arteria coronar
Ciseaux coronaire
Forbici per arteria coronaria

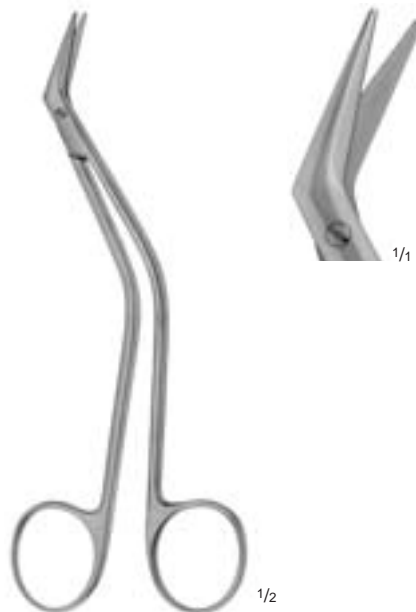

DE BAKEY
30-0185
16 cm, 6¹/₄"

Arteriotomieschere
Arteriotomy scissors
Tijera para arteriotomia
Ciseaux à artériotomie
Forbici per arteriotomia



Gefäßscheren

Vascular Scissors

Tijeras vasculares

Ciseaux vasculaires

Forbici vascolari



30-0211
18 cm, 7"



30-0212
18 cm, 7"



▶ **30-0213**
17,5 cm, 7"



30-0214
17 cm, 6 3/4"



30-0216
17 cm, 6 3/4"



HEGEMANN-DIETRICH

30-0211

- **30-0216**

seitlich abgewinkelt
angled on side
angulada hacia un lado
coudé vers le côté
angolato lateralmente



▶ **30-0200**
19 cm, 7 1/2"



30-0205
18,5 cm, 7 1/4"

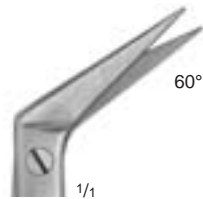

30-0210
18 cm, 7"

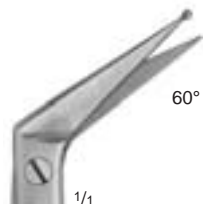

30-0208
18 cm, 7"

1 Blatt geknöpft
1 probe-pointed blade
1 hoja botonada
1 lame boutonnée
1 lama bottonuta



POTTS-SMITH

30-0200

- **30-0210**

seitlich abgewinkelt
angled on side
angulada hacia un lado
coudé vers le côté
angolato lateralmente



30-0221
17 cm, 6 3/4"



▶ **30-0224**
16,5 cm, 6 1/2"



30-0227
16 cm, 6 1/4"



DE BAKEY

30-0221

- **30-0227**

seitlich abgewinkelt
angled on side
angulada hacia un lado
coudé vers le côté
angolato lateralmente

Gefäßscheren

Vascular Scissors

Tijeras vasculares

Ciseaux vasculaires

Forbici vascolari



DIETRICH
30-0236
17,5 cm, 7"

seitlich abgewinkelt
angled on side
angulada hacia un lado
coudé vers le côté
angolato lateralmente



POTTS-SMITH
30-0189
19 cm, 7 1/2"

aufgewinkelt
angled on flat
angulada hacia arriba
coudé en haut
curvo in alto



POTTS-SMITH
30-0190
19 cm, 7 1/2"

aufgewinkelt
angled on flat
angulada hacia arriba
coudé en haut
curvo in alto



Gefäßscheren

Vascular Scissors

Tijeras vasculares

Ciseaux vasculaires

Forbici vascolari

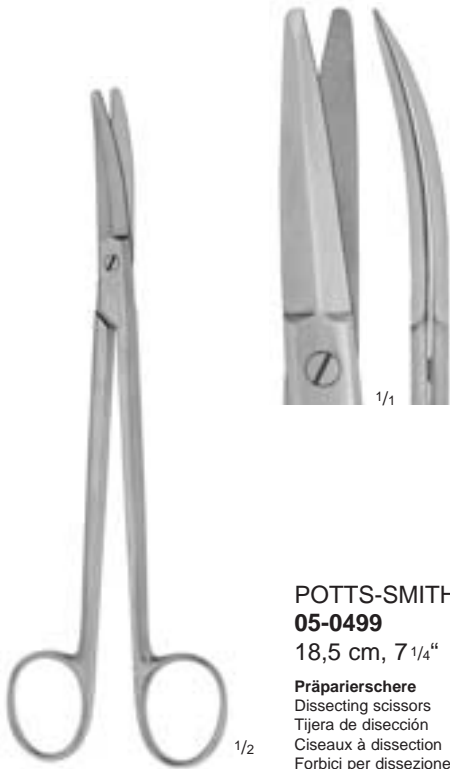

POTTS-SMITH

05-0499

18,5 cm, 7 1/4"

Präparierschere
Dissecting scissors
Tijera de disección
Ciseaux à dissection
Forbici per dissezione



► **05-0655**

18,5 cm, 7 1/4"

05-0657

25,5 cm, 10"

THOREK

05-0655

- **05-0657**

Präparierschere
Dissecting scissors
Tijeras de disección
Ciseaux à dissection
Forbici per dissezione



JORGENSON

30-0247

22 cm, 8 3/4"

Präparierschere
Dissecting scissors
Tijera de disección
Ciseaux à dissection
Forbici per dissezione



KLINGENBERGH-LOTH

05-0435

23 cm, 9"

Präparierschere
Dissecting scissors
Tijera de disección
Ciseaux à dissection
Forbici per dissezione

Vena cave-Schere

Vena Cava Scissors
Tijera para la vena cava
Ciseaux pour la veine cave
Forbici per vena cava

Lungenlappen- und Rektumschere

Lobectomy and Rectal Scissors
Tijera para lobectomía y recto
Ciseaux à lobectomie et pour le rectum
Forbici per lobo polmonare e per il retto



SATINSKY

30-0260

24,5 cm, 9³/₄"

Schere zum Ausschneiden eines Teiles der vena cava inferior vor Anastomose

Scissors for cutting out a part of the vena cava inferior before Anastomosis

Tijera para cortar una parte de la vena cava inferior, antes de anastomosis

Ciseaux pour enlever une partie la veine cave inférieure avant l'anastomose

Forbici per estinguere una parte della vena cava inferiore prima di anastomosi

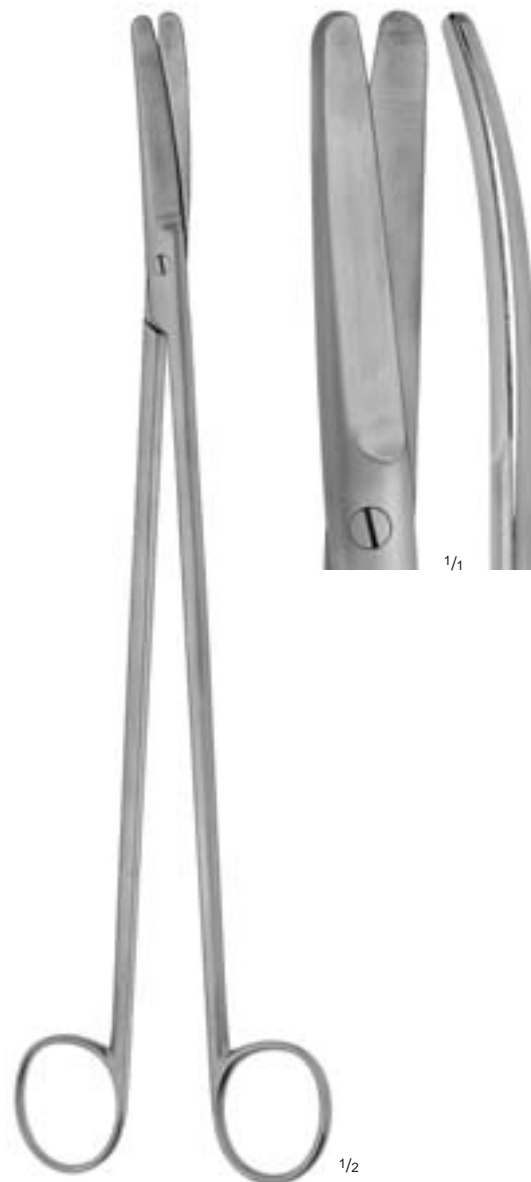

CRAFOORD (STELZNER)

30-0240

30,5 cm, 12"

Lungenlappen- und Rektumschere

Lobectomy and rectal scissors

Tijera para lobectomía y recto

Ciseaux à lobectomie et pour le rectum

Forbici per lobo polmonare e per il retto



Scheren für Neurochirurgie
Neurosurgical Scissors
Tijeras para neurocirugía
Ciseaux pour la neuro-chirurgie
Forbici per neurochirurgia

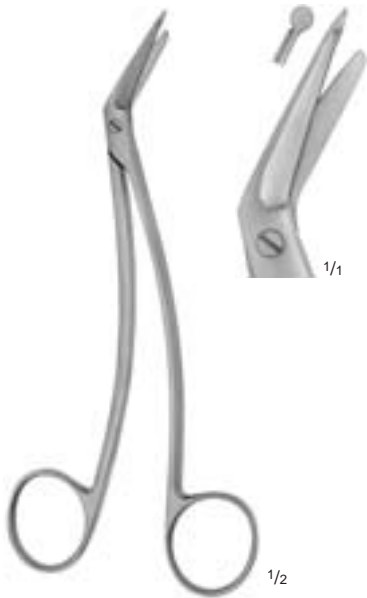

SCHMIEDEN-TAYLOR
50-0400
15,5 cm, 6"

Duraschere
Dura scissors
Tijera para dura-madre
Ciseaux pour dure-mère
Forbici per dura madre

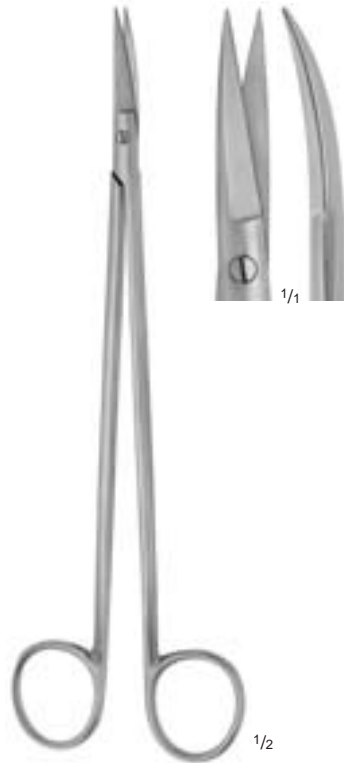

STRULLY
50-0419
20 cm, 8"

Neurochirurgische Schere
Scissors for neurosurgery
Tijera para neurocirugía
Ciseaux pour la neuro-chirurgie
Forbici per neurochirurgia

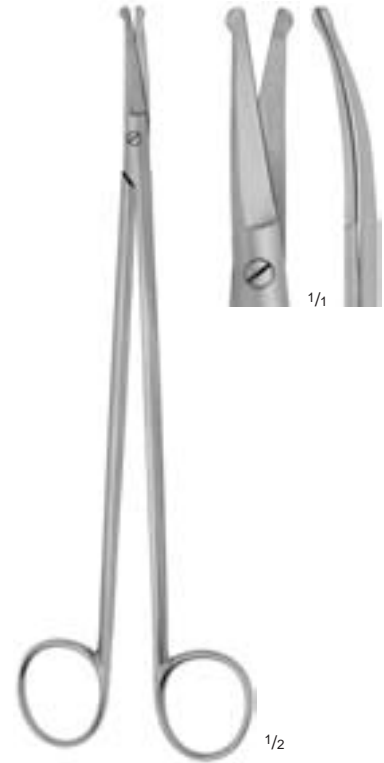

STRULLY
50-0420
20 cm, 8"

Neurochirurgische Schere
Scissors for neurosurgery
Tijera para neurocirugía
Ciseaux pour la neuro-chirurgie
Forbici per neurochirurgia



OLIVECRONA
50-0465
23 cm, 9"

Trigeminal-Schere (auch für Nase),
Arbeitslänge: 140 mm, 5 1/2"

Trigeminal scissors (also nasal),
working length: 140 mm, 5 1/2"

Tijera para nervio trigémino (también para la
nariz), longitud útil: 140 mm, 5 1/2"

Ciseaux pour le nerf trigéminal (également pour
le nez), longueur de tige: 140 mm, 5 1/2"

Forbici per nervo trigemino (anche nasale)
lunghezza di lavoro: 140 mm, 5 1/2"



KNIGHT
71-0120
 17,5 cm, 7"



1 Blatt gezahnt
 1 blade serrated
 1 hoja dentada
 1 lame dentelée
 1 lama dentata

KNIGHT
71-0122
 17,5 cm, 7"



HEYMANN
71-0100
 17,5 cm, 7"



1 Blatt gezahnt
 1 blade serrated
 1 hoja dentada
 1 lame dentelée
 1 lama dentata

HEYMANN
71-0102
 18,5 cm, 7 1/4"



Nasenscheren
Nasal Scissors
Tijeras nasales
Ciseaux nasaux
Forbici nasali

Septumschere
Septum Scissors
Tijera para el tabique nasal
Ciseaux pour la cloison des fosses nasales
Forbici per il setto nasale



FOMON
76-0630
13,5 cm, 5 1/4"

Nasenschere
Nasal scissors
Tijera nasal
Ciseaux nasaux
Forbici nasali



FOMON
76-0631
13,5 cm, 5 1/4"

Nasenschere, 1 Blatt gezahnt
Nasal scissors, 1 blade serrated
Tijera nasal, 1 hoja dentada
Ciseaux nasaux, 1 lame dentelée
Forbici nasali, 1 lama dentata



COTTLE
76-0640
16 cm, 6 1/4"

Nasenschere
Nasal scissors
Tijera nasal
Ciseaux nasaux
Forbici nasali



MÜHLING (KILLIAN)
76-0650
22 cm, 8 3/4"

Septumschere mit gezahnten Schneiden. Die Übersetzung gewährleistet eine optimale Kraftübertragung auf die Schneiden.

Septum scissors with serrated blades. The double-action ensures optimal power transmission on the blades.

Tijera para el tabique nasal con hojas dentadas. La fuerza de la palanca proporcionan una transmisión de fuerza óptima sobre las puntas cortantes.

Ciseaux pour cloison des fosses nasales avec lames dentelées. La double articulation garanti une transmission de force optimale sur les lames.

Forbici per il setto nasale con taglio dentato. La doppia azione garantisce un'ottimale trasmissione al taglio



Weitere Septumscheren siehe Seite 59.

Further septum scissors see page 59.

Más tijeras para el tabique nasal, vean página 59.

Autres ciseaux pour cloison des fosses nasales voir page 59.

Altre forbici per il setto nasale, vedi pagina 59.

Tonsillenscheren

Tonsil Scissors

Tijeras para amígdalas

Ciseaux pour les amygdales

Forbici per tonsille



1/1

1 Blatt gezahnt
1 blade serrated
1 hoja dentada
1 lame dentelée
1 lama dentata



1/1



1/1



1/2

DEAN
81-0655
17 cm, 6³/₄"



1/2

BOETTCHER
81-0650
18,5 cm, 7¹/₄"



1/2

GOOD
81-0677
19,5 cm, 7³/₄"



Uterusscheren
Uterine Scissors
Tijeras uterinas
Ciseaux utérins
Forbici da utero



▶ **05-0740**
20 cm, 8"



▶ **05-0742**
20 cm, 8"



05-0752
23 cm, 9"

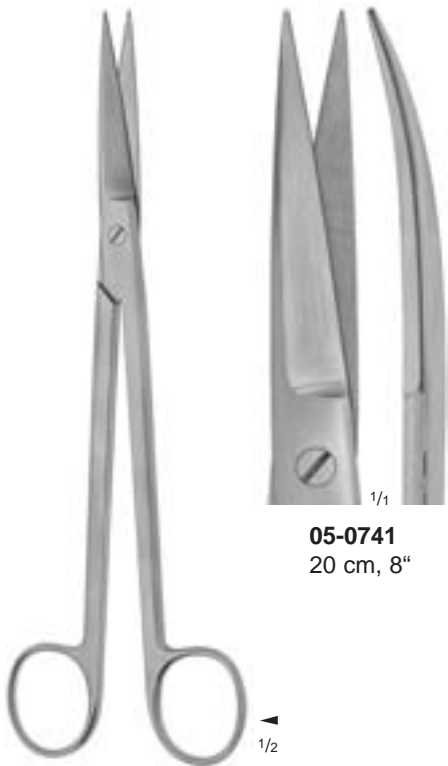

05-0741
20 cm, 8"

SIMS
05-0740
- **05-0741**

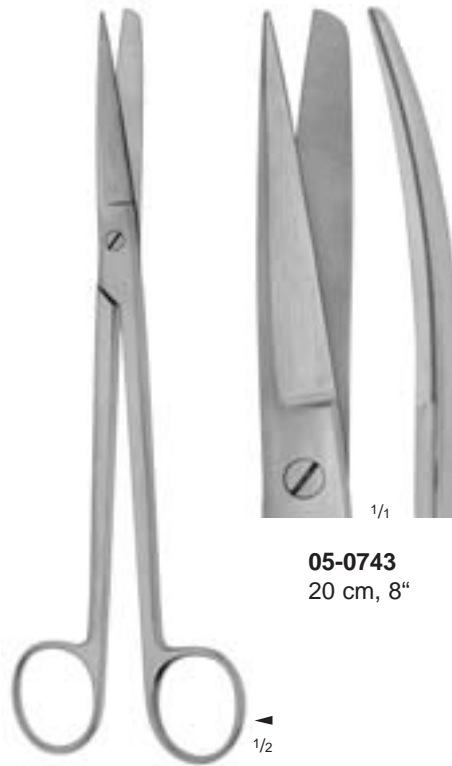

05-0743
20 cm, 8"

SIMS
05-0742
- **05-0753**



05-0753
23 cm, 9"

Uterusscheren
 Uterine Scissors
 Tijeras uterinas
 Ciseaux utérins
 Forbici da utero



► **05-0744**
 20 cm, 8"



05-0754
 23 cm, 9"



► **05-0431**
 20 cm, 8"



05-0745
 20 cm, 8"



05-0755
 23 cm, 9"



05-0433
 23 cm, 9"



SIMS
05-0744
 - **05-0755**



WERTHEIM
05-0431
 - **05-0433**



Uterusscheren

Uterine Scissors
Tijeras uterinas
Ciseaux utérins
Forbici da utero

Bauchdeckenscheren

Abdominal Scissors
Tijeras abdominales
Ciseaux pour interventions en profondeur
Forbici per pareti addominali



SIMS-SIEBOLD
05-0770
24,5 cm, 9³/₄"

Uterusschere
Uterine scissors
Tijera uterina
Ciseaux utérins
Forbici da utero



SIEBOLD
05-0773
24,5 cm, 9³/₄"

Uterusschere
Uterine scissors
Tijera uterina
Ciseaux utérins
Forbici da utero



► **05-0780**
18,5 cm, 7¹/₄"



05-0781
18,5 cm, 7¹/₄"

Bauchdeckenscheren

Abdominal scissors
Tijeras abdominales
Ciseaux pour interventions en profondeur
Forbici per pareti addominali

DOYEN
05-0780
- 05-0781

Damm- (Episiotomie-) Scheren

Perineum (Episiotomy) Scissors

Tijeras para perineo (episiotomía)

Ciseaux à périnée (à épisiotomie)

Forbici per perineo (episiotomia)



BRAUN-STADLER
96-0980
- **96-0985**

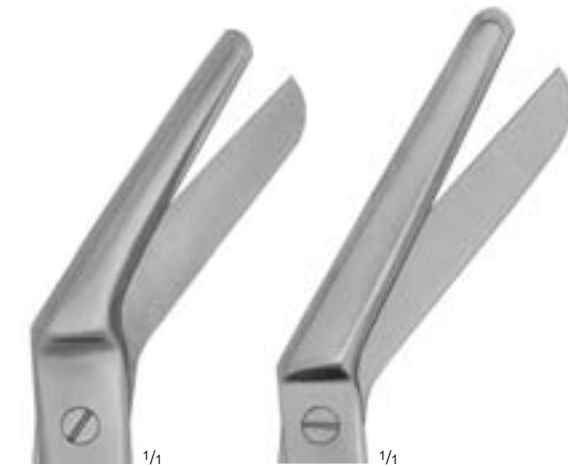

▶ **96-0980**
14,5 cm, 5³/₄"

96-0985
22 cm, 8³/₄"

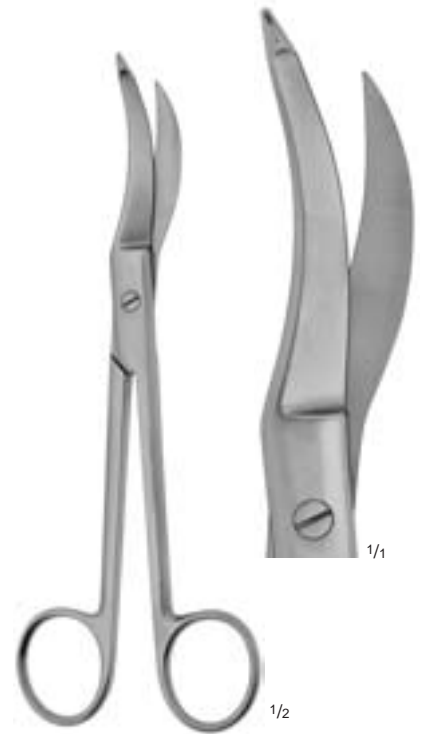

WALDMANN
96-0987
18 cm, 7"

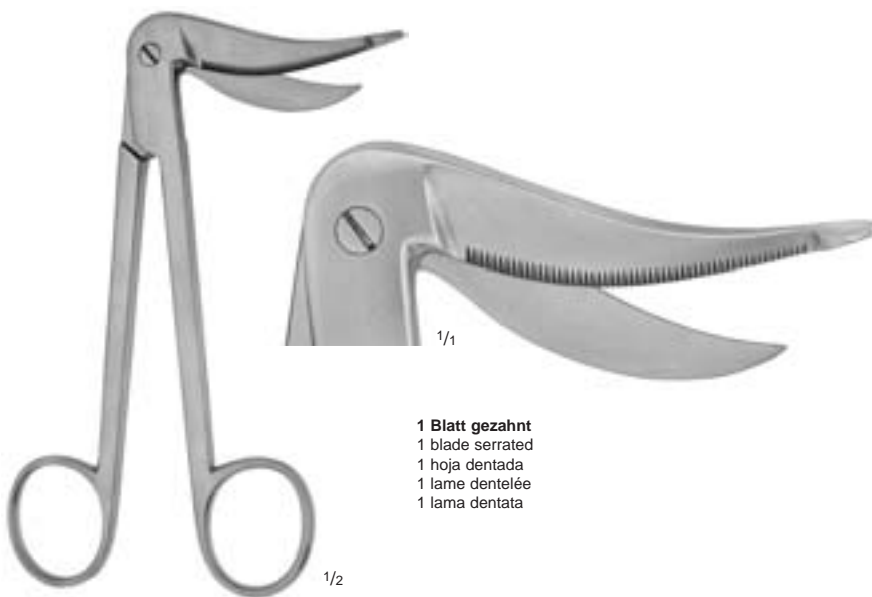

MARBACH
96-0988
15,5 cm, 6"

1 Blatt gezahnt
1 blade serrated
1 hoja dentada
1 lame dentelée
1 lama dentata



96-0989
19,5 cm, 7³/₄"

1 Blatt gezahnt
1 blade serrated
1 hoja dentada
1 lame dentelée
1 lama dentata



Nabelschnurscheren

Umbilical Cord Scissors

Tijeras umbilicales

Ciseaux pour le cordon ombilical

Forbici ombelicali



BUSH
05-0173
16 cm, 6 1/4"



1 Blatt gezahnt
1 blade serrated
1 hoja dentada
1 lame dentelée
1 lama dentata

BUSH
05-0174
16 cm, 6 1/4"



MOD. USA
96-0990
10,5 cm, 4 1/8"



SCHUMACHER
96-0993
15,5 cm, 6"

Kephalotomiescheren

Decapitating Scissors
Tijeras para decapitación
Ciseaux à détroncation
Forbici per decapitazione

Darmscheren

Enterotomy Scissors
Tijeras enterótomos
Ciseaux entérotomes
Forbici per enterotomia



► **97-0435**
27 cm, 10³/₄"



97-0436
27 cm, 10³/₄"



DUBOIS
97-0435
- **97-0436**

Kephalotomiescheren
Decapitating (embryotomy) scissors
Tijeras para decapitación
Ciseaux à détroncation
Forbici per decapitazione



98-0200
21,5 cm, 8¹/₂"

Darmschere für Anatomie
Enterotomy scissors for anatomy
Tijera enterótomo para anatomía
Ciseaux entérotomes pour l'anatomie
Forbici per enterotomia



98-0210
21,5 cm, 8¹/₂"

Darmschere für Anatomie
Enterotomy scissors for anatomy
Tijera enterótomo para anatomía
Ciseaux entérotomes pour l'anatomie
Forbici per enterotomia

**Weitere Scheren**

Further Scissors
 Más tijeras
 Autres ciseaux
 Altre forbici



Nagelhautscheren, Nagelscheren	Seite	16
Cuticle Scissors, Nail Scissors	Page	16
Tijeras cuticulares, Tijeras para uñas	Página	16
Ciseaux à envies, Ciseaux à ongles	Page	16
Forbici per la cuticola, Forbici per unghie	Pagina	16



DURACUT® Scheren mit Hartmetallschneiden	Seite	43 - 60, 353, 665, 673, 676
DURACUT® Scissors with tungsten carbide edges	Page	43 - 60, 353, 665, 673, 676
DURACUT® Tijeras con filos de carburo tungsteno	Página	43 - 60, 353, 665, 673, 676
DURACUT® Ciseaux avec des lames en tungstène	Page	43 - 60, 353, 665, 673, 676
DURACUT® Forbici con lame in carburo di tungsteno	Pagina	43 - 60, 353, 665, 673, 676



Ligaturscheren, Fadenscheren	Seite	352 - 353
Ligature Scissors	Page	352 - 353
Tijeras para ligaduras	Página	352 - 353
Ciseaux à ligatures	Page	352 - 353
Forbici per legature	Pagina	352 - 353



Drahtscheren	Seite	665
Wire Cutting Scissors	Page	665
Cizallas para cortar alambre	Página	665
Ciseaux pour couper les fils	Page	665
Forbici per tagliare i filiferri	Pagina	665



Verband- und Kleiderstoffscheren	Seite	672 - 675
Bandage and Cloth Scissors	Page	672 - 675
Tijeras para vendajes y tela	Página	672 - 675
Ciseaux pour pansements et vêtements	Page	672 - 675
Forbici per bendaggi e vestiti	Pagina	672 - 675



Gipsscheren	Seite	675 - 678
Plaster-of-Paris Shears	Page	675 - 678
Cizallas para yesos	Página	675 - 678
Cisailles à plâtres	Page	675 - 678
Cesoie per apparecchi gessati	Pagina	675 - 678



LAWNTON

Medizintechnik



- TITE GRIP® Pinzetten
- TITE GRIP® Forceps
- TITE GRIP® Pinzas
- TITE GRIP® Pincés
- TITE GRIP® Pinze



TITE GRIP® Pinzetten mit Hartmetalleinlagen
 TITE GRIP® Forceps with tungsten carbide inserts
 TITE GRIP® Pinzas con bocas de carburo tungsteno
 TITE GRIP® Pincers avec mors en tungstène
 TITE GRIP® Pinze con morsi in carburo di tungsteno

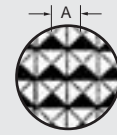

Riefung
 Serration
 Estriadura
 Structure
 Struttura



- Hartmetalleinlagen mit präzis gearbeitetem Pyramidenprofil.
Sicheres und schonendes Fassen von Gefäßen, Gewebe und Nahtmaterial.
Vergoldete Federenden als leichte Kennzeichnung.
- Tungsten carbide inserts with precisely worked out structure.
Firm and gentle grip of vessels, tissues and sutures.
Gold-plated ends for easy identification.
- Capas intermedias de carburo tungsteno con perfil amoldado piramidal que permite un sujeto seguro y cuidadoso de los vasos, tejidos y materiales de sutura.
Identificación: Cabos dorados.
- Mors en tungstène à structure pyramidale.
Préhension sûre et légère des vaisseaux, tissus et sutures
Talon plaqué or pour identification facile.
- Morsi in carburo di tungsteno con struttura piramidale lavorata
Impugnatura più sicura e delicata per vasi, tessuti e suture.
Estremità dorate per una facile identificazione

Je nach Anwendungsgebiet stehen 4 verschiedene Arten von Hartmetalleinlagen zur Verfügung:
 According to the field of application, there are 4 various types of tungsten carbide inserts available:
 Según campo de aplicación, disponemos de 4 diferentes capas intermedias de carburo tungsteno:
 Selon champ d'application, il existe 4 types différents de mors en tungstène:
 A secondo del campo di applicazione Vi sono a disposizione 4 diversi tipi di morsi in carburo di tungsteno

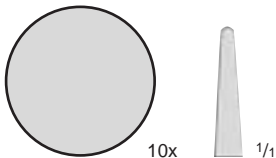
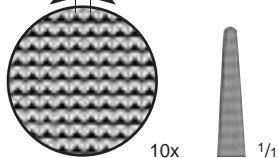
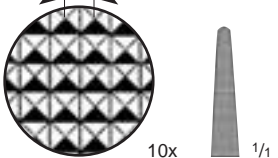
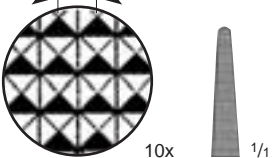
	0,2 mm	0,4 mm	0,5 mm
			
GLATT Zum Halten von extrem feinem Nahtmaterial	TEILUNG 0,2 mm Zum Halten von feinem Nahtmaterial der Stärken 7/0 bis 10/0	TEILUNG 0,4 mm Zum Halten von Nahtmaterial der Stärken 4/0 bis 6/0	TEILUNG 0,5 mm Zum Halten von Nahtmaterial der Stärke 3/0 und kräftiger
SMOOTH For holding the smallest suture sizes	SERRATION 0.2 mm For holding the delicate suture sizes from 7/0 to 10/0	SERRATION 0.4 mm For holding the suture sizes from 4/0 to 6/0	SERRATION 0.5 mm For holding the suture size 3/0 and larger
LISA Para sujetar suturas muy finas	ESTRIADURA 0,2 mm Para sujetar suturas finas de 7/0 hasta 10/0 de gruesas	ESTRIADURA 0,4 mm Para sujetar suturas de 4/0 hasta 6/0 de gruesas	ESTRIADURA 0,5 mm Para sujetar suturas de 3/0 y más gruesas
LISSE Pour tenir les sutures très fines	STRUCTURE 0,2 mm Pour les sutures fines tailles 7/0 à 10/0	STRUCTURE 0,4 mm Pour les sutures tailles 4/0 à 6/0	STRUCTURE 0,5 mm Pour les sutures tailles 3/0 et plus grosses
PIATTA Per tenere materiale da sutura estremamente sottile	STRUTTURA 0,2 mm Per tenere suture sottile dello spessore da 7/0 a 10/0	STRUTTURA 0,4 mm Per tenere suture dello spessore da 4/0 a 6/0	STRUTTURA 0,5 mm Per tenere suture dello spessore da 3/0 e più robuste

TITE GRIP® Anatomische Pinzetten mit Hartmetalleinlagen
 TITE GRIP® Dissecting Forceps with tungsten carbide inserts
 TITE GRIP® Pinzas de disección con bocas de carburo tungsteno
 TITE GRIP® Pincès à dissection avec mors en tungstène
 TITE GRIP® Pinze anatomiche per dissezione con morsi in carburo di tungsteno

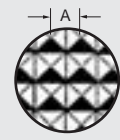

Riefung
 Serration
 Estriadura
 Structure
 Struttura



ADSON
 09-1375
 - 09-1378



0,4 mm (A)
 ▶ 09-1376
 12 cm, 4³/₄"



0,5 mm (A)
 09-1377
 15 cm, 6"



ADSON
 09-1379
 12 cm, 4³/₄"



0,4 mm (A)



SEMKEN
 09-1559
 15 cm, 6"
 mit Dissektor-Ende
 with dissector end
 con cabo disecador
 avec dissecteur
 con estremità per dissezione

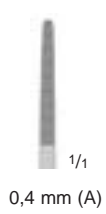

0,4 mm (A)



MC INDOE
 09-1380
 15 cm, 6"



0,4 mm (A)



OBWEGESER
 09-1382
 16 cm, 6¹/₄"
 Knüpfpinzette
 Suture tying forceps
 Pinza de ligadura
 Pince à ligatures
 Pinza per legature



0,2 mm (A)



OBWEGESER
 09-1384
 18 cm, 7"
 Knüpfpinzette
 Suture tying forceps
 Pinza de ligadura
 Pince à ligatures
 Pinza per legature



0,2 mm (A)



TITE GRIP® Anatomische Pinzetten mit Hartmetalleinlagen
 TITE GRIP® Dissecting Forceps with tungsten carbide inserts
 TITE GRIP® Pinzas de disección con bocas de carburo tungsteno
 TITE GRIP® Pincès à dissection avec mors en tungstène
 TITE GRIP® Pinze anatomiche per dissezione con morsi in carburo di tungsteno

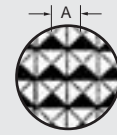

Riefung
 Serration
 Estradadura
 Structure
 Struttura



GERALD
 09-1386
 17,5 cm, 7"



CUSHING
 09-1740
 17,5 cm, 7"
 mit Dissektor-Ende
 with dissector end
 con cabo disecador
 avec dissecteur
 con estremità per dissezione







CUSHING
 09-1741
 17,5 cm, 7"
 mit Dissektor-Ende
 with dissector end
 con cabo disecador
 avec dissecteur
 con estremità per dissezione



TAYLOR-CUSHING
 09-1710
 18,5 cm, 7 1/4"
 mit Dissektor-Ende
 with dissector end
 con cabo disecador
 avec dissecteur
 con estremità per dissezione



POTTS-SMITH
 09-1574
 - 09-1591

				
0,4 mm (A)	0,4 mm (A)	0,4 mm (A)	0,4 mm (A)	0,4 mm (A)
09-1574 16 cm, 6 1/4"	▶ 09-1576 18,5 cm, 7 1/4"	09-1581 21 cm, 8 1/4"	09-1586 24,5 cm, 9 3/4"	09-1591 26 cm, 10 1/4"

mit Dissektor-Ende • with dissector end • con cabo disecador • avec dissecteur • con estremità per dissezione

TITE GRIP® Anatomische Pinzetten mit Hartmetalleinlagen
 TITE GRIP® Dissecting Forceps with tungsten carbide inserts
 TITE GRIP® Pinzas de disección con bocas de carburo tungsteno
 TITE GRIP® Pincès à dissection avec mors en tungstène
 TITE GRIP® Pinze anatomiche per dissezione con morsi in carburo di tungsteno

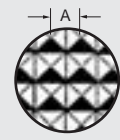

Riefung
 Serration
 Estriadura
 Structure
 Struttura



	0,5 mm (A)	0,5 mm (A)	0,5 mm (A)	0,5 mm (A)	0,5 mm (A)	0,5 mm (A)
	09-1116	09-1121	09-1126	▶ 09-1131	09-1136	09-1141
	13 cm, 5 1/8"	14,5 cm, 5 3/4"	16 cm, 6 1/4"	18 cm, 7"	20 cm, 8"	25 cm, 10"

Standard Modelle • Standard patterns • modelos standard • modèles standard • modelli standard

09-1116
 - 09-1141

	0,5 mm (A)	0,5 mm (A)	0,5 mm (A)
	09-1800	▶ 09-1802	09-1804
	15 cm, 6"	23 cm, 9"	25,5 cm, 10"

BONNEY
 09-1145
 17 cm, 6 3/4"

WANGENSTEEN
 09-1800
 - 09-1804



TITE GRIP® Gewebefaß- und Nadelzieh-Pinzetten
 TITE GRIP® Needlepulling Tissue Forceps
 TITE GRIP® Pinzas para tejidos y tirar uñas
 TITE GRIP® Pincés pour saisir les tissus et tirer les aiguilles
 TITE GRIP® Pinze per tessuti e per infilare aghi

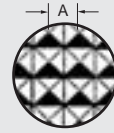

Riefung
 Serration
 Estradura
 Structure
 Struttura

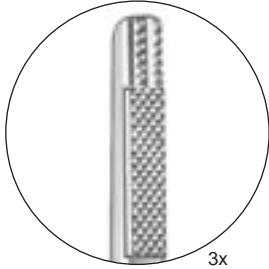

1,5 mm



1/1

0,2 mm (A)

09-1051
 15,5 cm, 6"

1,5 mm



1/1

0,2 mm (A)

09-1061
 20 cm, 8"

1,5 mm



1/1

0,2 mm (A)

09-1071
 24 cm, 9 1/2"



1/2

2 mm



1/1

0,4 mm (A)

09-1050
 15,5 cm, 6"

2 mm



1/1

0,4 mm (A)

▶ 09-1060
 20 cm, 8"

2 mm



1/1

0,4 mm (A)

09-1070
 24 cm, 9 1/2"

DE BAKEY
 09-1050
 - 09-1071

Mit der atraumatischen Riefung am vorderen Maulende wird feines Gewebe schonend und sicher gefaßt, während mit den dahinterliegenden Hartmetalleinlagen eine Wundnadel sicher gehalten werden kann.

With the atraumatic jaws at the tips, fine tissues are hold gently and in a secure way. The tungsten carbide inserts provide safe gripping of needle.

Con la estradura atraumatica en la parte delantera de la boca, se sujeta cuidadoso y seguro tejido fino, mientras que con las capas intermedias de carburo tungsteno detrás se puede sujetar seguro una aguja.

Avec la striure atraumatique à l'extrémité des mors, les tissus fins sont saisis d'une manière délicate et ferme. Les mors en tungstène assurent une très bonne tenue de l'aiguille.

La pinza si presenta con una scanalatura atraumatica all'estremità anteriore. Ha la capacità di afferrare un tessuto in modo delicato e sicuro ed inoltre le sue estremità a morsi in carburo di tungsteno consentono di tenere fermo un ago da sutura.

TITE GRIP® Chirurgische Pinzetten mit Hartmetalleinlagen
 TITE GRIP® Tissue Forceps with tungsten carbide inserts
 TITE GRIP® Pinzas quirúrgicas con bocas de carburo tungsteno
 TITE GRIP® Pincès à dissection à griffes avec mors en tungstène
 TITE GRIP® Pinze per dissezione con denti con morsi in carburo di tungsteno

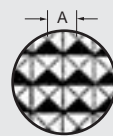

Riefung
 Serration
 Estriadura
 Structure
 Struttura

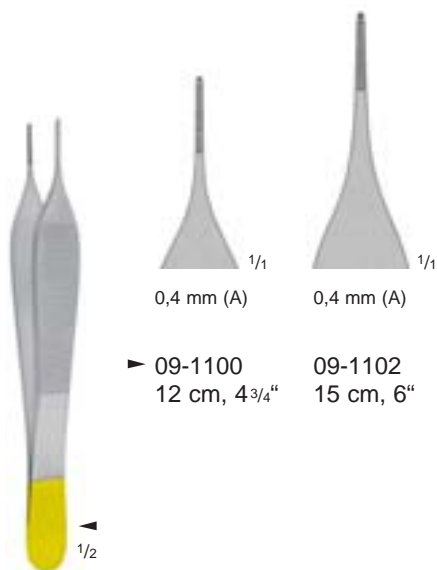

► 09-1100 09-1102
 12 cm, 4 3/4" 15 cm, 6"

MICRO-ADSON
 09-1100
 - 09-1102

1x2 Zähne
 1x2 teeth
 1x2 dientes
 1x2 dents
 1x2 denti

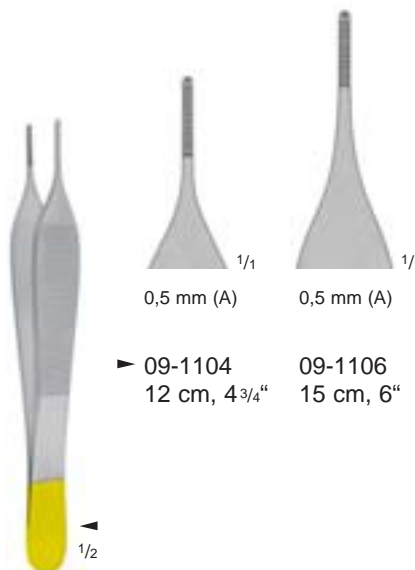

► 09-1104 09-1106
 12 cm, 4 3/4" 15 cm, 6"

ADSON
 09-1104
 - 09-1106

1x2 Zähne
 1x2 teeth
 1x2 dientes
 1x2 dents
 1x2 denti

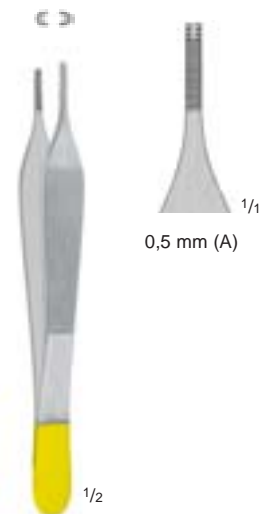

ADSON-BROWN
 09-1110
 12 cm, 4 3/4"

3x4 Zähne
 3x4 teeth
 3x4 dientes
 3x4 dents
 3x4 denti

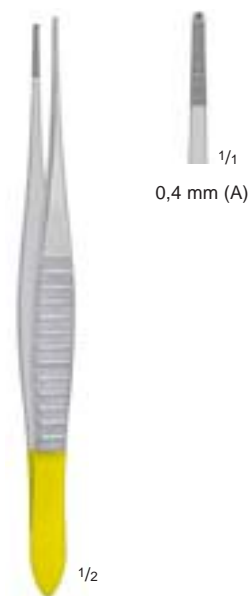

GILLIES
 09-1112
 15 cm, 6"

1x2 Zähne
 1x2 teeth
 1x2 dientes
 1x2 dents
 1x2 denti



► 09-1118 09-1120
 16 cm, 6 1/4" 18 cm, 7"

SEMKEN
 09-1118
 - 09-1120

1x2 Zähne
 1x2 teeth
 1x2 dientes
 1x2 dents
 1x2 denti



GERALD
 09-1122
 17,5 cm, 7"

1x2 Zähne
 1x2 teeth
 1x2 dientes
 1x2 dents
 1x2 denti



TITE GRIP® Pinzetten mit Hartmetalleinlagen
 TITE GRIP® Forceps with tungsten carbide inserts
 TITE GRIP® Pinzas con bocas de carburo tungsteno
 TITE GRIP® Pincers avec mors en tungstène
 TITE GRIP® Pinze con morsi in carburo di tungsteno

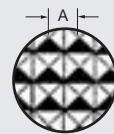





Riefung
 Serration
 Estradatura
 Structure
 Struttura



1/2

OEHLER
 09-1161
 - 09-1181

Chirurgische Pinzetten, 1x2 Zähne
 Tissue forceps, 1x2 teeth
 Pinzas quirúrgicas, 1x2 dientes
 Pincers à dissection à griffes, 1x2 dents
 Pinze chirurgiche a denti di topo, 1x2 denti

				
1/1	1/1	1/1	1/1	1/1
0,5 mm (A)	0,5 mm (A)	0,5 mm (A)	0,5 mm (A)	0,5 mm (A)
09-1161 14,5 cm, 5 ³ / ₄ "	09-1168 16 cm, 6 ¹ / ₄ "	▶ 09-1171 18 cm, 7"	09-1176 20,5 cm, 8"	09-1181 25 cm, 10"



1/2

BONNEY
 09-1185
 17,5 cm, 7"

Chirurgische Pinzetten, 1x2 Zähne
 Tissue forceps, 1x2 teeth
 Pinzas quirúrgicas, 1x2 dientes
 Pincers à dissection à griffes, 1x2 dents
 Pinze chirurgiche a denti di topo, 1x2 denti

0,5 mm (A)



1/1



1/2

57-0325
 21,5 cm, 8¹/₂"

Mikro-Pinzette
 Micro forceps
 Micro-Pinza
 Micro-Pince
 Micro-Pinza

glatt
 smooth
 liso
 lisse
 piatta



1/1



1/2

57-0365
 21,5 cm, 8¹/₂"

Mikro-Pinzette
 Micro forceps
 Micro-Pinza
 Micro-Pince
 Micro-Pinza

glatt
 smooth
 liso
 lisse
 piatta



1/1



LAWNTON
Medizintechnik

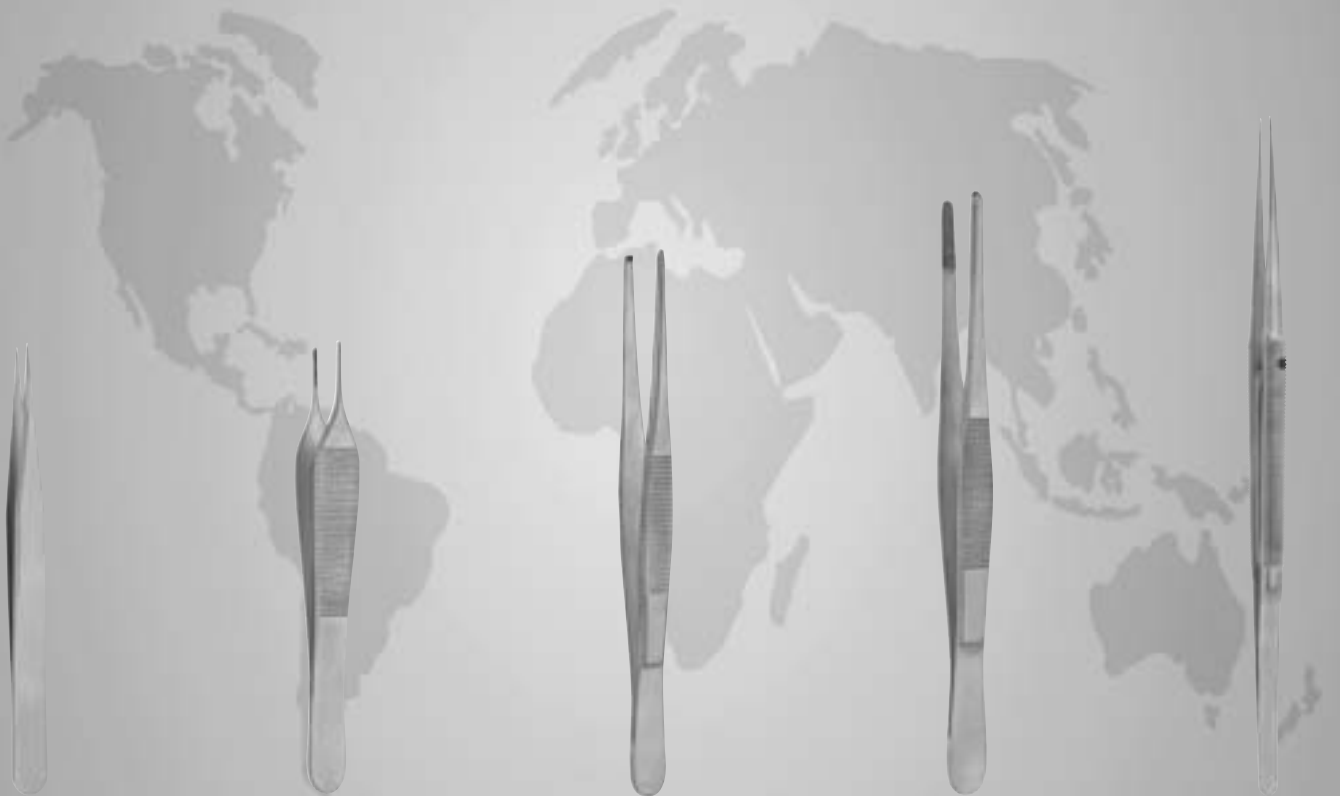

Pinzetten
Forceps
Pinzas
Pinces
Pinze



Mikro-Pinzetten (Uhrmacher-Modelle)
 Micro Forceps (Jeweler Patterns)
 Micro-pinzas (modelos de relojero)
 Micro-pinces (modèles horloger)
 Micro-pinze (modello orologiaio)

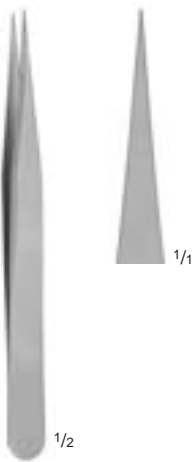

Fig. 1

MOD. SWITZERLAND
 09-0950
 12 cm, 4^{3/4}"

feine Spitzen
 fine points
 puntas finas
 pointes fines
 punte fini

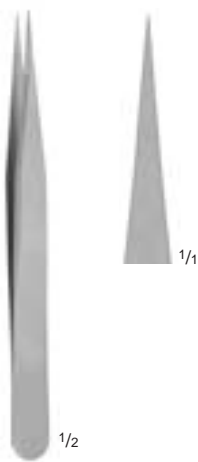

Fig. 3

MOD. SWITZERLAND
 09-0952
 12 cm, 4^{3/4}"

extra feine Spitzen
 extra fine points
 puntas extra finas
 pointes très fines
 punte extra fini

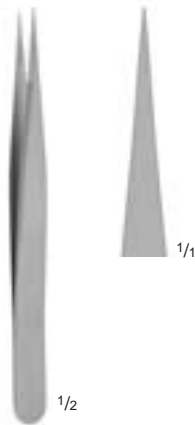

Fig. 3c

MOD. SWITZERLAND
 09-0954
 11 cm, 4^{3/8}"

extra feine Spitzen
 extra fine points
 puntas extra finas
 pointes très fines
 punte extra fini

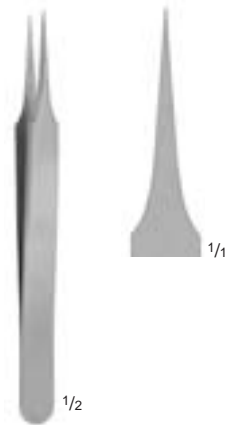

Fig. 4

MOD. SWITZERLAND
 09-0956
 11 cm, 4^{3/8}"

extra feine Spitzen
 extra fine points
 puntas extra finas
 pointes très fines
 punte extra fini

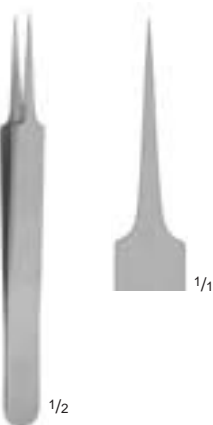

Fig. 5

MOD. SWITZERLAND
 09-0958
 11 cm, 4^{3/8}"

superfeine Spitzen
 super fine points
 puntas super finas
 pointes superfines
 punte super fini

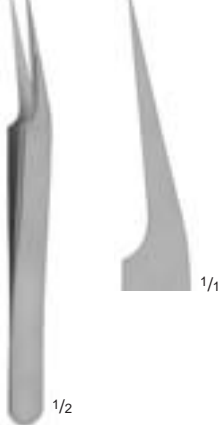

Fig. 5a

MOD. SWITZERLAND
 09-0955
 11,5 cm, 4^{1/2}"

feine Spitzen
 fine points
 puntas finas
 pointes fines
 punte fini

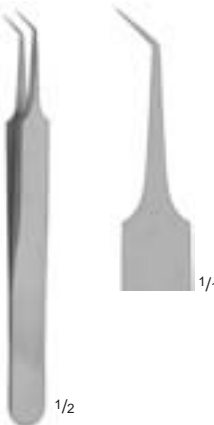

Fig. 5s

MOD. SWITZERLAND
 09-0957
 11 cm, 4^{3/8}"

superfeine Spitzen
 super fine points
 puntas super finas
 pointes superfines
 punte super fini

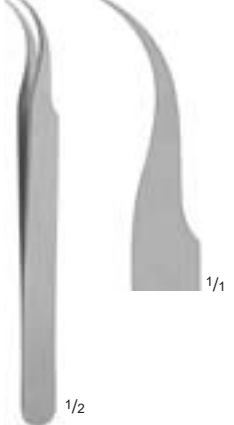

Fig. 7

MOD. SWITZERLAND
 09-0959
 11,5 cm, 4^{1/2}"

feine Spitzen
 fine points
 puntas finas
 pointes fines
 punte fini

Mikroskopier-Pinzetten
 Microscopic Forceps
 Pinzas para microscopia
 Pincès pour microscopie
 Pinze per microscopia

Mikro-Knüpfpinzetten
 Micro Suture Tying Forceps
 Micro-pinzas de ligadura
 Micro-pincès à ligatures
 Micro-pinze per legature

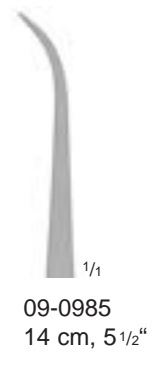
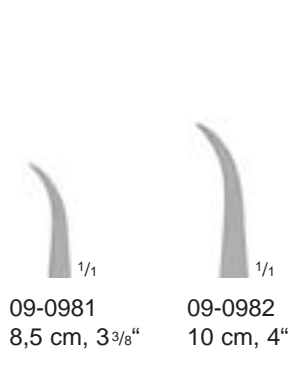
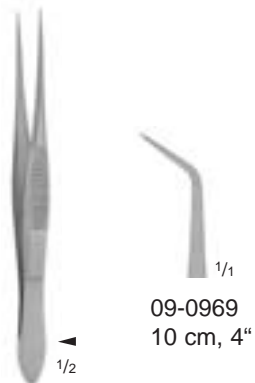
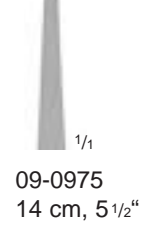
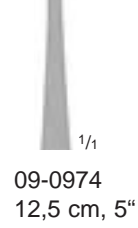
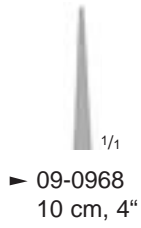

09-0968
 - 09-0969

09-0971
 - 09-0985

Mikroskopier-Pinzetten • Microscopic forceps • Pinzas para microscopia • Pincès pour microscopie • Pinze per microscopia

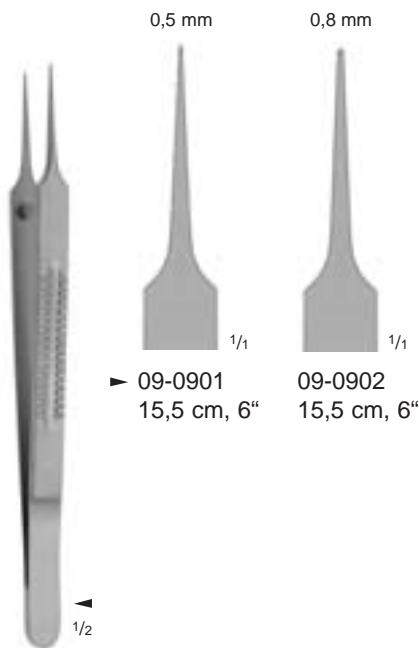

LAZAR
 09-0901
 - 09-0902

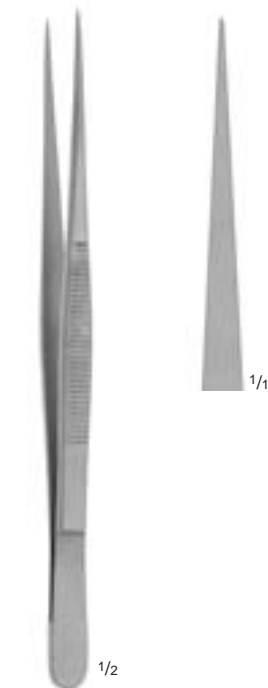

09-0903
 18 cm, 7"

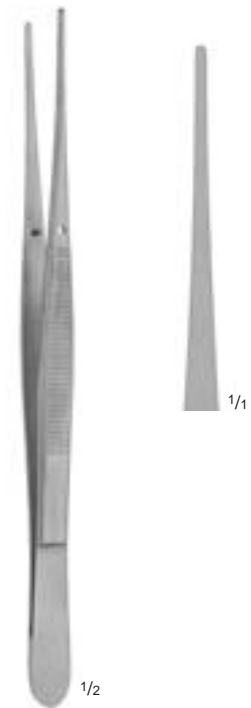

09-0232
 18 cm, 7"

Mikro-Knüpfpinzetten • Micro suture tying forceps • Micro-pinzas de ligadura • Micro-pincès à ligatures • Micro-pinze per legature



Mikro-Knüpfpinzetten mit Flachgriffen
 Micro Suture Tying Forceps with Flat Handles
 Micro-pinzas de ligadura con mangos planos
 Micro-pinces à ligatures avec manches plats
 Micro-pinze per legature con manici piatti

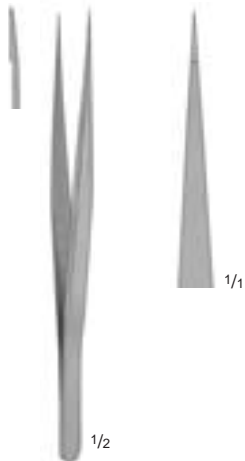

09-3000
 12 cm, 4^{3/4}"

mit glatten Fadenplatten
 with smooth tying platforms
 con piattaforme lisas
 avec plateaux lisses à ligatures
 con piattaforme liscie

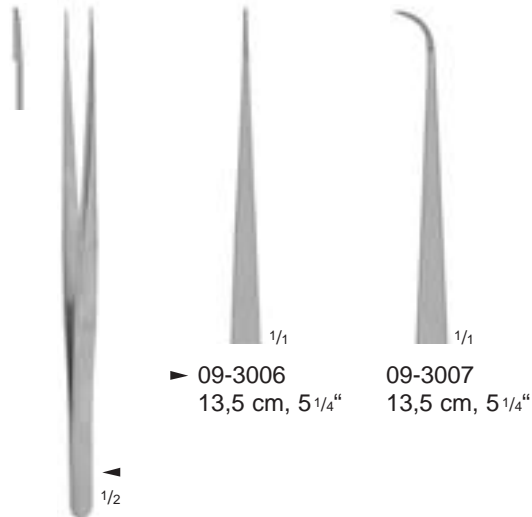

► 09-3006 13,5 cm, 5^{1/4}"
 09-3007 13,5 cm, 5^{1/4}"

VISE
 09-3006
 - 09-3007

mit glatten Fadenplatten
 with smooth tying platforms
 con piattaforme lisas
 avec plateaux lisses à ligatures
 con piattaforme liscie

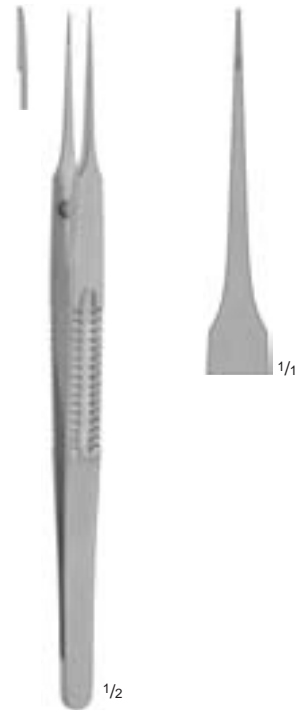

09-3010
 18,5 cm, 7^{1/4}"

mit glatten Fadenplatten
 with smooth tying platforms
 con piattaforme lisas
 avec plateaux lisses à ligatures
 con piattaforme liscie

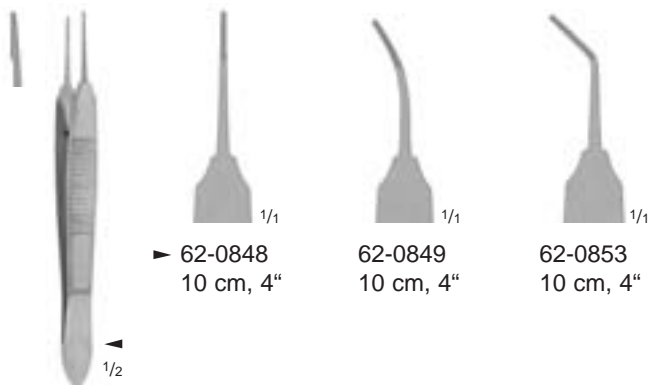

► 62-0848 10 cm, 4"
 62-0849 10 cm, 4"
 62-0853 10 cm, 4"

MC PHERSON
 62-0848
 - 62-0853

mit glatten Fadenplatten
 with smooth tying platforms
 con piattaforme lisas
 avec plateaux lisses à ligatures
 con piattaforme liscie

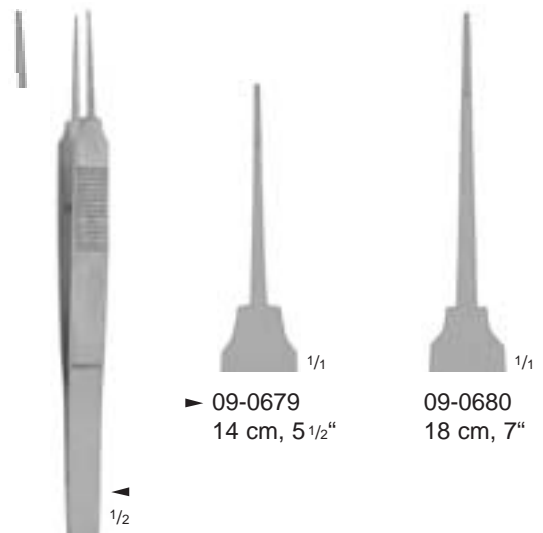

► 09-0679 14 cm, 5^{1/2}"
 09-0680 18 cm, 7"

AUSTIN
 09-0679
 - 09-0680

mit glatten Fadenplatten
 with smooth tying platforms
 con piattaforme lisas
 avec plateaux lisses à ligatures
 con piattaforme liscie

Mikro-Knüppfzangen mit Rundgriffen
 Micro Suture Tying Forceps with Round Handles
 Micro-pinzas de ligadura con mangos redondos
 Micro-pinces à ligatures avec manches ronds
 Micro-pinze per legature con manici rotondi

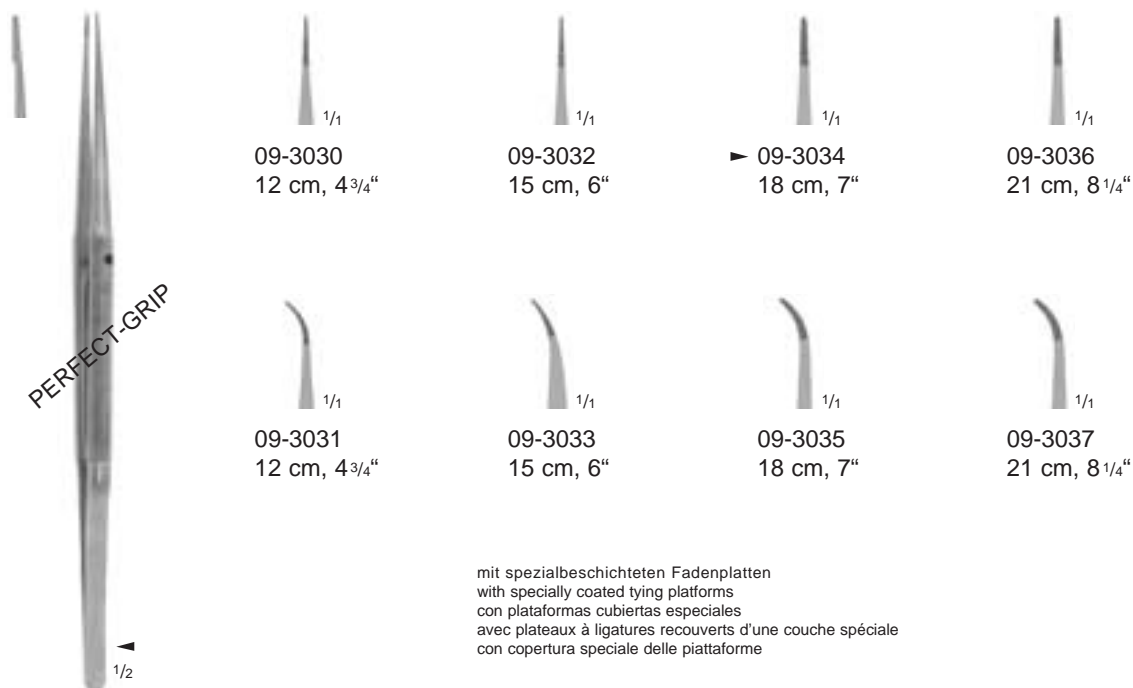

09-3030
 - 09-3037

mit spezialbeschichteten Fadenplatten
 with specially coated tying platforms
 con plataformas cubiertas especiales
 avec plateaux à ligatures recouverts d'une couche spéciale
 con copertura speciale delle piattaforme

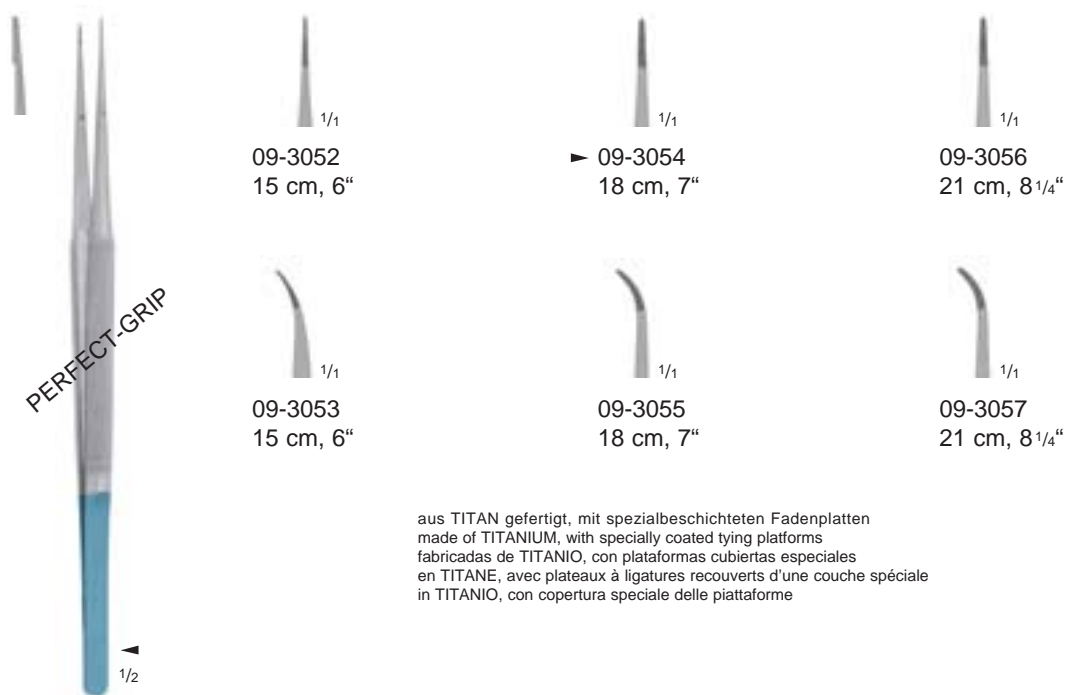

09-3052
 - 09-3057

aus TITAN gefertigt, mit spezialbeschichteten Fadenplatten
 made of TITANIUM, with specially coated tying platforms
 fabricadas de TITANIO, con plataformas cubiertas especiales
 en TITANE, avec plateaux à ligatures recouverts d'une couche spéciale
 in TITANIO, con copertura speciale delle piattaforme



Mikro-Faßpinzetten mit Rundgriffen
 Micro Grasping Forceps with Round Handles
 Micro-pinzas de agarre con mangos redondos
 Micro-pinces pour saisir les tissus avec des manches ronds
 Micro-pinze per afferrare tessuti con manici rotondi



mit glatten Fadenplatten,
1x2 Zähne
 with smooth tying plat-
forms, 1x2 teeth
 con piattaforme lisas,
1x2 dientes
 avec plateaux lisses à
ligatures, 1x2 dents
 con piattaforme lisce,
1x2 denti

09-3062
18 cm, 7"



mit DE BAKEY-Zahnung
with toothing DE BAKEY
con dentado DE BAKEY
avec mors DE BAKEY
con dentatura DE BAKEY













09-3064
18 cm, 7"



aus TITAN gefertigt,
mit DE BAKEY-Zahnung
made of TITANIUM,
with toothing DE BAKEY
fabricada de TITANIO,
con dentado DE BAKEY
en TITANE,
avec mors DE BAKEY
in TITANO,
con dentatura DE BAKEY

09-3066
18 cm, 7"













PERFECT-GRIP

		
		
09-3132 15 cm, 6"	09-3134 18 cm, 7"	09-3136 21 cm, 8 1/4"
		
		
09-3142 15 cm, 6"	09-3144 18 cm, 7"	09-3146 21 cm, 8 1/4"

mit spezialbeschichteten Maulteilen
with specially coated jaws
con bocas cubiertas especiales
avec mors recouverts d'une couche spéciale
con copertura speciale dei morsi

09-3132
- 09-3146

PERFECT-GRIP

		
		
09-3172 15 cm, 6"	09-3174 18 cm, 7"	09-3176 21 cm, 8 1/4"
		
		
09-3182 15 cm, 6"	09-3184 18 cm, 7"	09-3186 21 cm, 8 1/4"

aus TITAN gefertigt, mit spezialbeschichteten Maulteilen
made of TITANIUM, with specially coated jaws
fabricadas de TITANIO, con bocas cubiertas especiales
en TITANE, avec mors recouverts d'une couche spéciale
in TITANIO, con copertura speciale dei morsi

09-3172
- 09-3186

Mikro-Pinzetten, bajonettförmig
 Micro Forceps, bayonet-shaped
 Micro-pinzas, en forma bayoneta
 Micro-pinces en forme de baïonnette
 Micro-pinze con manici a baionetta



0,4 mm



► 57-1110
 18 cm, 7"

0,4 mm



57-1112
 20 cm, 8"

0,4 mm



57-1114
 22 cm, 8^{3/4}"

0,4 mm



57-1116
 24,5 cm, 9^{3/4}"

0,9 mm



57-1120
 18 cm, 7"

0,9 mm



57-1122
 20 cm, 8"

0,9 mm



57-1124
 22 cm, 8^{3/4}"

0,9 mm



57-1126
 24,5 cm, 9^{3/4}"



YASARGIL
 57-1110
 - 57-1126

mit glatten Maulteilen
 with smooth jaws
 con bocas lisas
 avec mors lisses
 con morsi lisci

0,4 mm



YASARGIL
 57-1130
 18 cm, 7"

1x2 Zähne
 1x2 teeth
 1x2 dientes
 1x2 dents
 1x2 denti



Tumor- und Gewebefaßpinzetten, bajonettförmig
 Tumor and Tissue Grasping Forceps, bayonet-shaped
 Pinzas de agarre para tejido y tumor, en forma bayoneta
 Pincers en forme de baïonnette pour saisir tumeurs et tissus
 Pinze per afferare tessuti e tumori, a baionetta

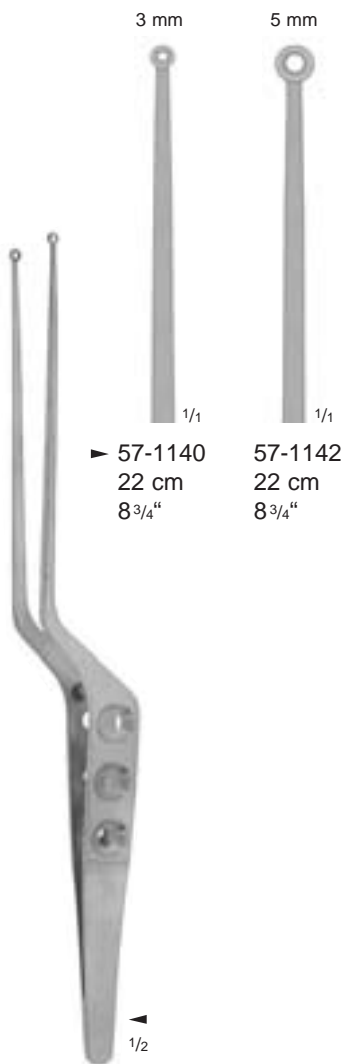

YASARGIL
 57-1140
 - 57-1142

Maul löffelförmig
 jaws spoon-shaped
 boca forma cuchara
 Mors en forme de cuillère
 Morsi a forma di cucchiaio

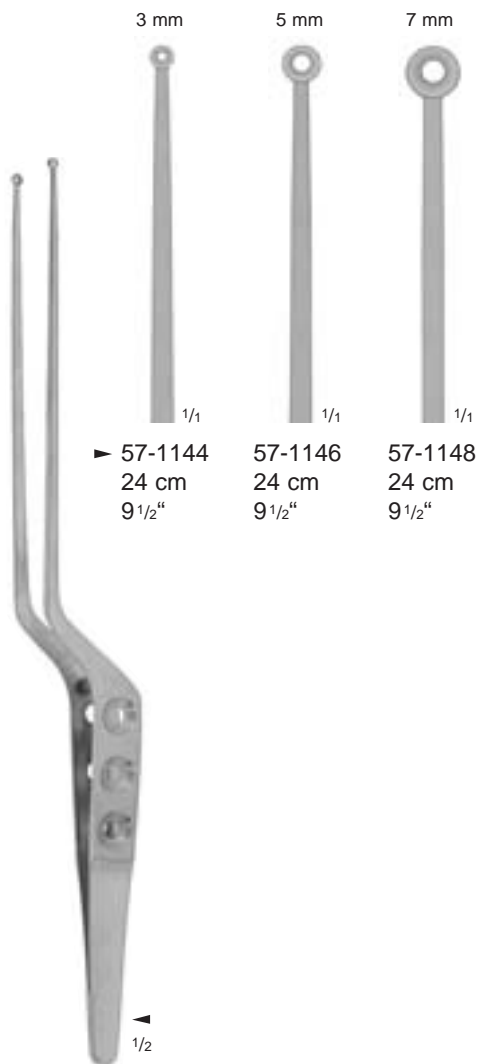

YASARGIL-SAMII
 57-1144
 - 57-1148

Maul löffelförmig
 jaws spoon-shaped
 boca forma cuchara
 Mors en forme de cuillère
 Morsi a forma di cucchiaio

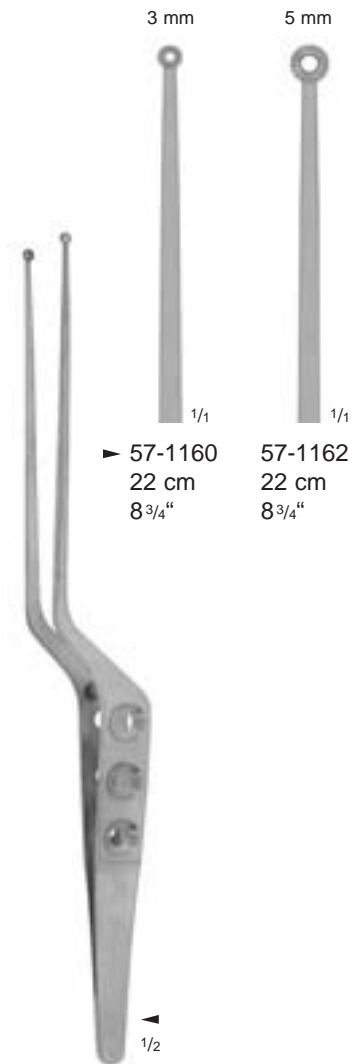

YASARGIL
 57-1160
 - 57-1162

Maul flach, gezahnt
 flat jaws, serrated
 boca plana, dentada
 Mors plats, dentelés
 Morsi piatti, dentati

Tumor- und Gewebefaßpinzetten, bajonettförmig
 Tumor and Tissue Grasping Forceps, bayonet-shaped
 Pinzas de agarre para tejido y tumor, en forma bayoneta
 Pincers en forme de baïonnette pour saisir tumeurs et tissus
 Pinze per afferare tessuti e tumori, a baionetta

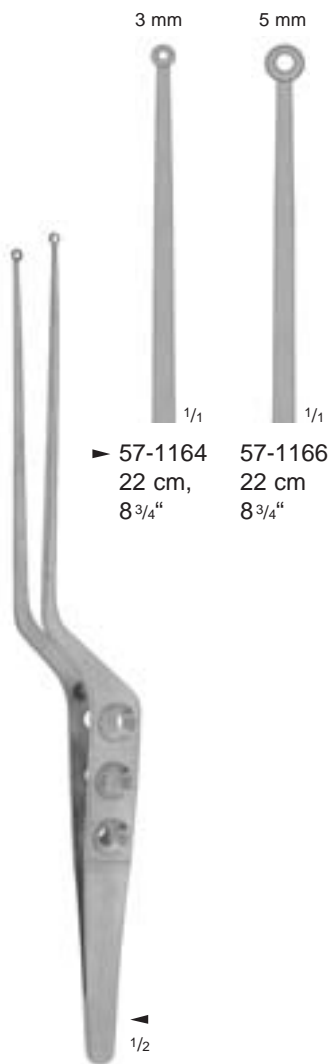

▶ 57-1164 22 cm, 8 3/4"
 ▶ 57-1166 22 cm 8 3/4"

HEIFETZ
 57-1164
 - 57-1166

Maul kürettenförmig, gezahnt
 curette jaws, toothed
 boca forma cureta, dentada
 Mors en forme de curette, dentelés
 Morsi a forma di curetta, dentati

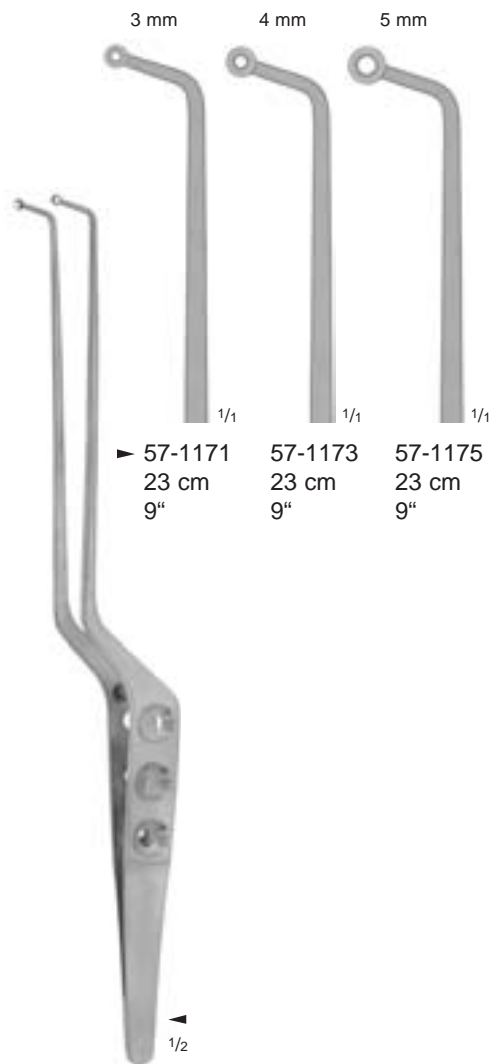

▶ 57-1171 23 cm 9"
 ▶ 57-1173 23 cm 9"
 ▶ 57-1175 23 cm 9"

SAMII
 57-1171
 - 57-1175

Maul löffelförmig
 jaws spoon-shaped
 boca forma cuchara
 Mors en forme de cuillère
 Morsi a forma di cucchiaio

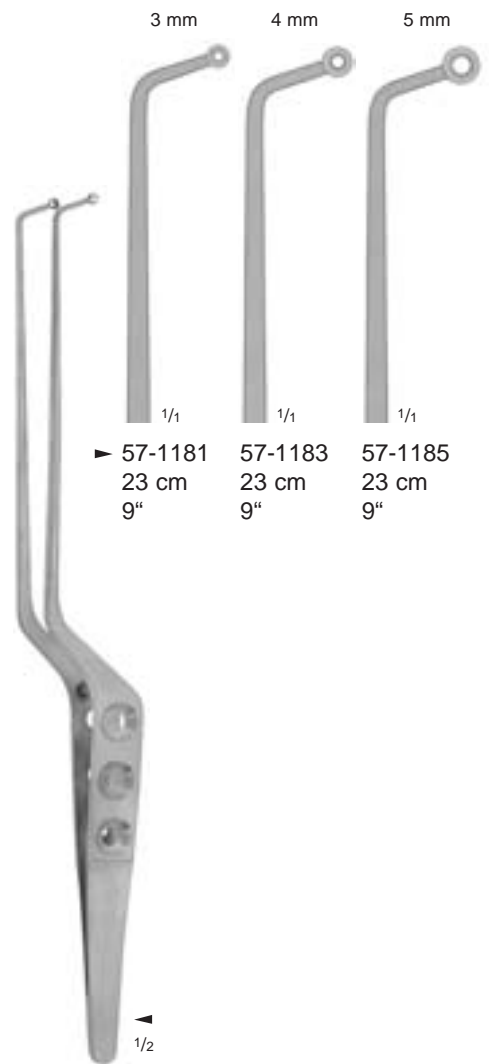

▶ 57-1181 23 cm 9"
 ▶ 57-1183 23 cm 9"
 ▶ 57-1185 23 cm 9"

SAMII
 57-1181
 - 57-1185

Maul löffelförmig
 jaws spoon-shaped
 boca forma cuchara
 Mors en forme de cuillère
 Morsi a forma di cucchiaio



Feine anatomische Pinzetten
 Delicate Dissecting Forceps
 Pinzas finas de disección
 Pincas fines pour dissection
 Pinze anatomiche per dissezione, fini

0,3 mm



09-0006
10 cm, 4"

0,5 mm



▶ 09-0016
10 cm, 4"

1,0 mm



09-0010
10 cm, 4"

0,5 mm



62-0251
7 cm, 2 3/4"

0,7 mm



▶ 62-0261
7 cm, 2 3/4"

1,0 mm



62-0271
7 cm, 2 3/4"

0,3 mm



09-0007
10 cm, 4"

0,5 mm



09-0017
10 cm, 4"

1,0 mm



09-0011
10 cm, 4"

0,5 mm



62-0253
7 cm, 2 3/4"

0,7 mm



62-0263
7 cm, 2 3/4"

1,0 mm



62-0273
7 cm, 2 3/4"



1/2

GRAEFE
62-0251
- 62-0273

0,3 mm



09-0009
9,5 cm, 3 3/4"

0,5 mm



09-0019
9,5 cm, 3 3/4"

1,0 mm



09-0013
9,5 cm, 3 3/4"



1/2

09-0006
- 09-0019

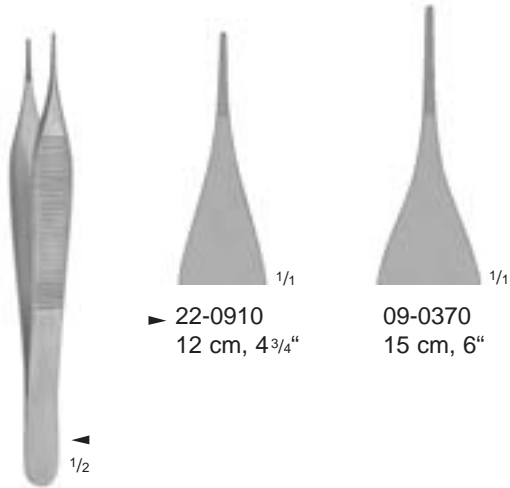

▶ 22-0910
12 cm, 4³/₄"

09-0370
15 cm, 6"

MICRO-ADSON
09-0370
- 22-0910

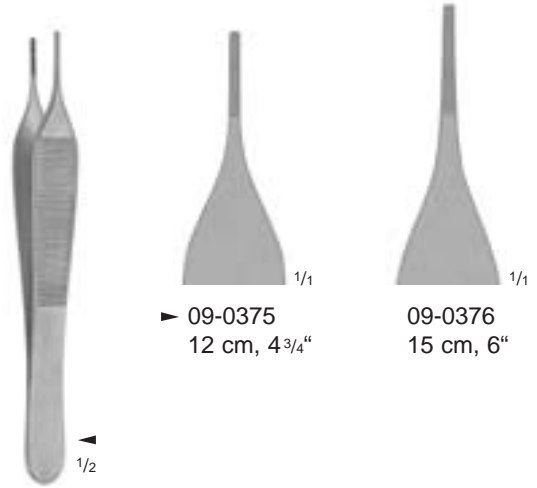

▶ 09-0375
12 cm, 4³/₄"

09-0376
15 cm, 6"

ADSON
09-0375
- 09-0376



ADSON
09-0378
12 cm, 4³/₄"



EWALD
09-0395
12 cm, 4³/₄"

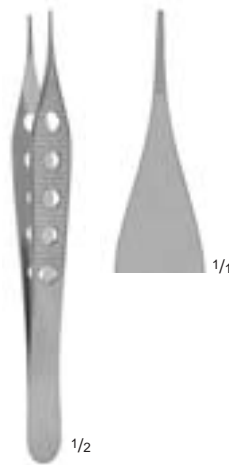

MICRO-ADSON
22-0912
12 cm, 4³/₄"

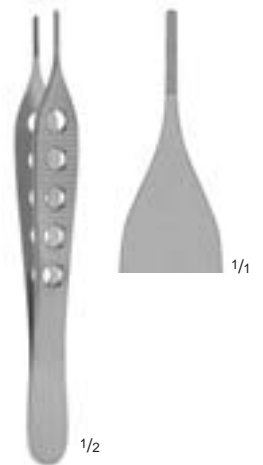

ADSON
09-0377
12 cm, 4³/₄"



Feine anatomische Pinzetten
 Delicate Dissecting Forceps
 Pinzas finas de disección
 Pincas fines pour dissection
 Pinze anatomiche per dissezione, fini



09-0040
 12,5 cm, 5"

▶ 09-0042
 15 cm, 6"

1/2

SEMKEN
 09-0040
 - 09-0042



1/1



1/1



1/2

MC INDOE
 09-0438
 15 cm, 6"



1/1



1/2

GERALD
 09-0610
 - 09-0611



1/1

▶ 09-0610
 17,5 cm, 7"



1/1

09-0611
 17,5 cm, 7"



1/2

CUSHING
 09-0740
 - 09-0742



1/1

▶ 09-0740
 17,5 cm, 7"



1/1

09-0742
 17,5 cm, 7"

mit Dissektor-Ende
 with dissector end
 con cabo disecador
 avec talon dissecteur
 con dissettore

Feine anatomische Pinzetten
 Delicate Dissecting Forceps
 Pinzas finas de disección
 Pincas fines pour dissection
 Pinze anatomiche per dissezione, fini



mit Dissektor-Ende
 with dissector end
 con cabo dissecador
 avec talon dissecteur
 con dissettore

TAYLOR-CUSHING
 09-0700
 17,5 cm, 7"



▶ 09-0560
 18,5 cm, 7 1/4"

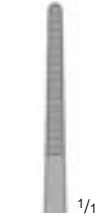

09-0565
 21 cm, 8 1/4"



09-0570
 24,5 cm, 9 3/4"

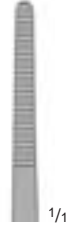

09-0572
 30,5 cm, 12"

POTTS-SMITH
 09-0560
 - 09-0572



BROPHY
 09-0284
 - 09-0285



▶ 09-0284
 19,5 cm, 7 3/4"



09-0285
 19,5 cm, 7 3/4"



WAUGH
 09-0422
 20 cm, 8"



09-0239
 20 cm, 8"



Anatomische Pinzetten
 Dissecting Forceps
 Pinzas de disección
 Pincès à dissection
 Pinze anatomiche per dissezione

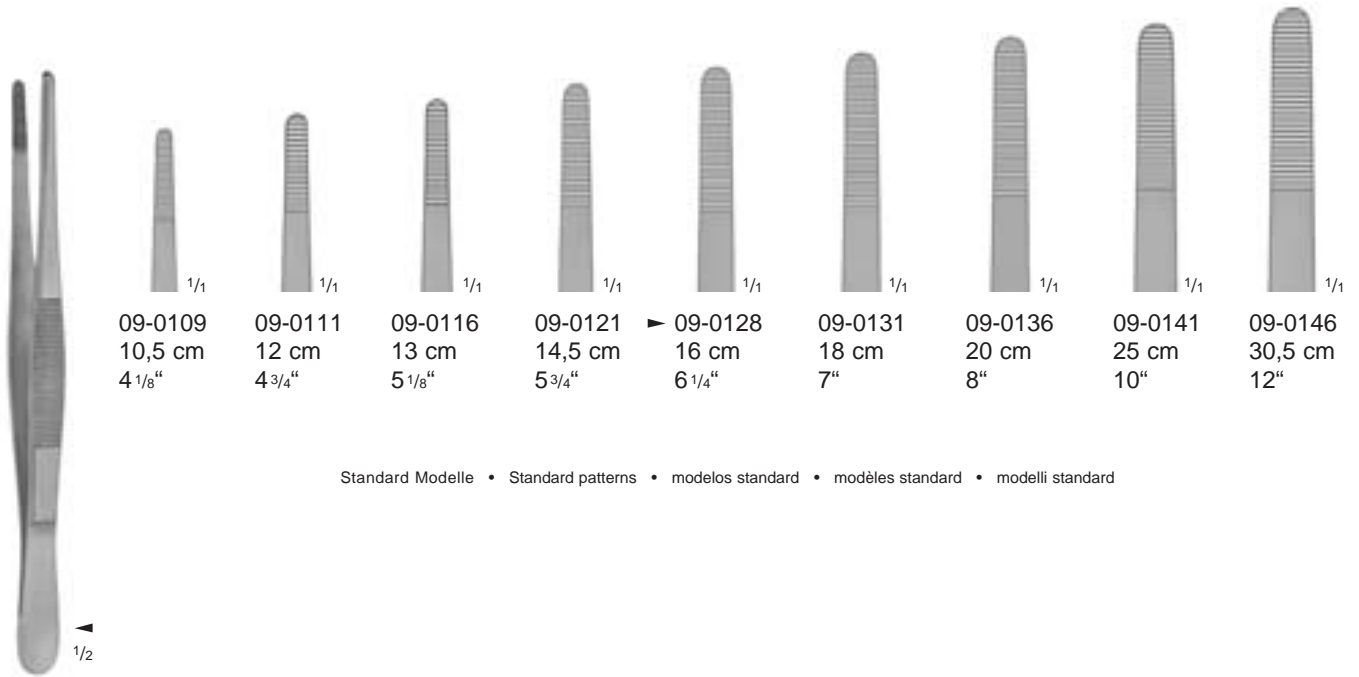

Standard Modelle • Standard patterns • modelos standard • modèles standard • modelli standard

09-0109
- 09-0146

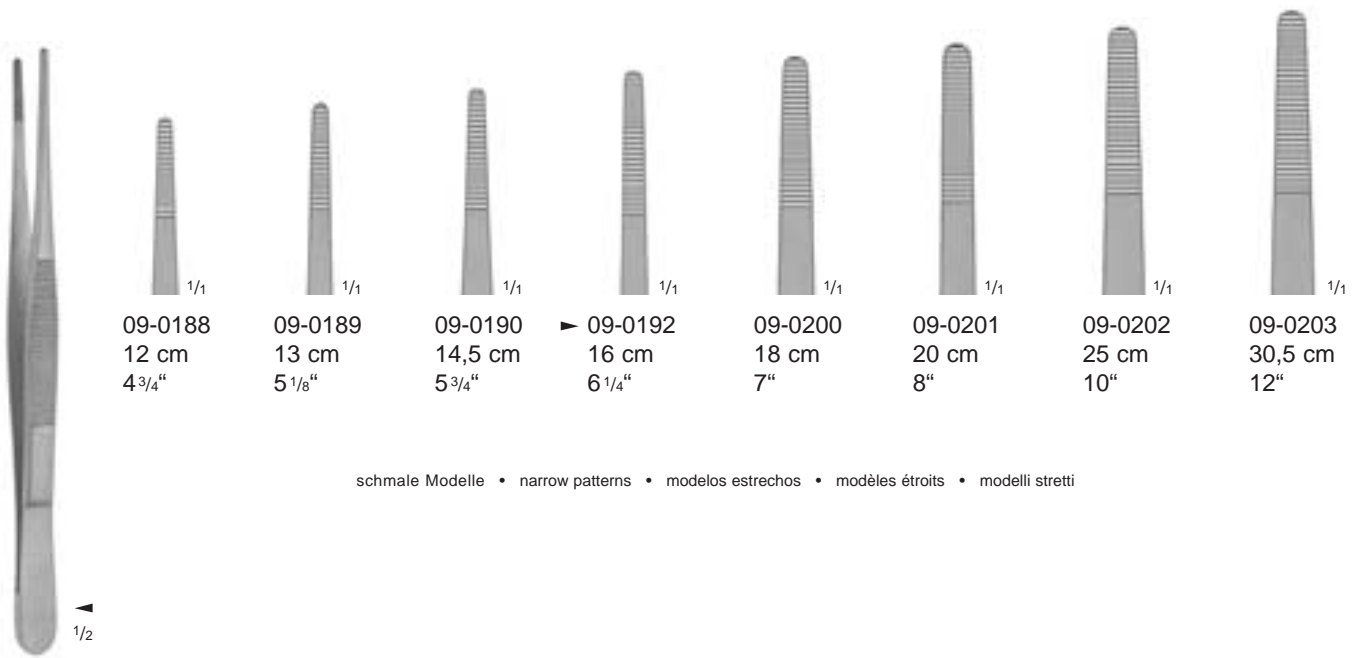

schmale Modelle • narrow patterns • modelos estrechos • modèles étroits • modelli stretti

09-0188
- 09-0203

Anatomische Pinzetten
 Dissecting Forceps
 Pinzas de disección
 Pincès à dissection
 Pinze anatomiche per dissezione

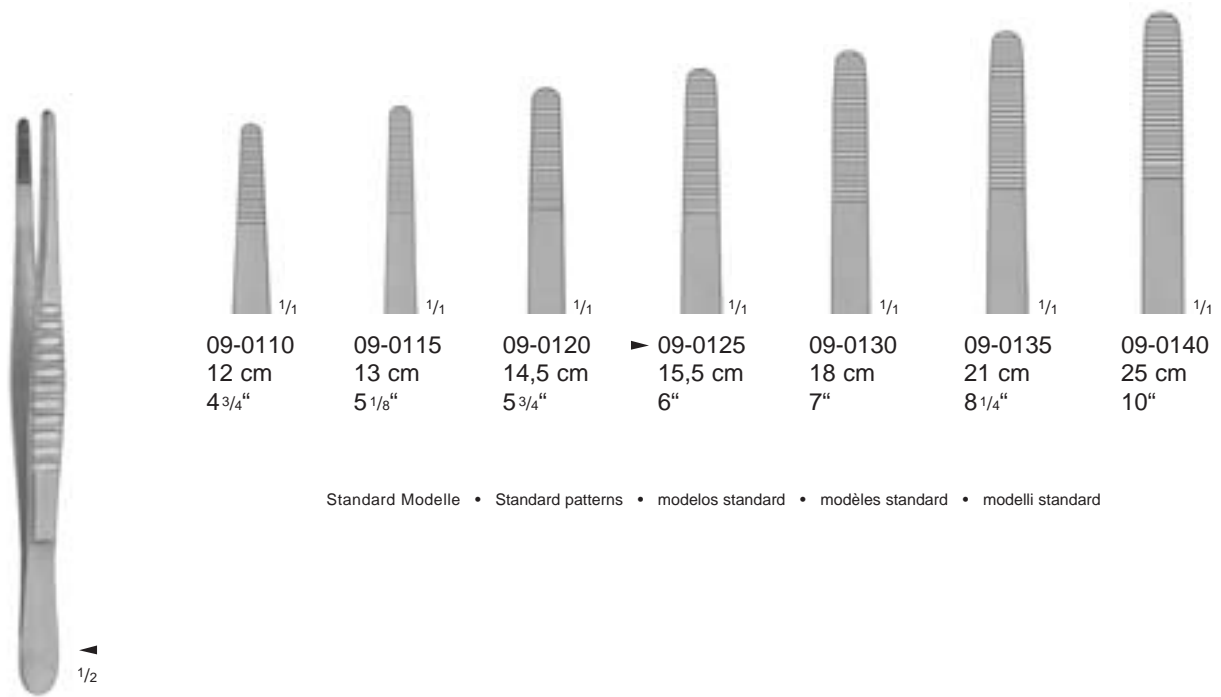

	1/1	1/1	1/1	1/1	1/1	1/1	1/1
09-0110	09-0115	09-0120	▶ 09-0125	09-0130	09-0135	09-0140	
12 cm	13 cm	14,5 cm	15,5 cm	18 cm	21 cm	25 cm	
4 3/4"	5 1/8"	5 3/4"	6"	7"	8 1/4"	10"	

Standard Modelle • Standard patterns • modelos standard • modèles standard • modelli standard

MOD. USA
 09-0110
 - 09-0140

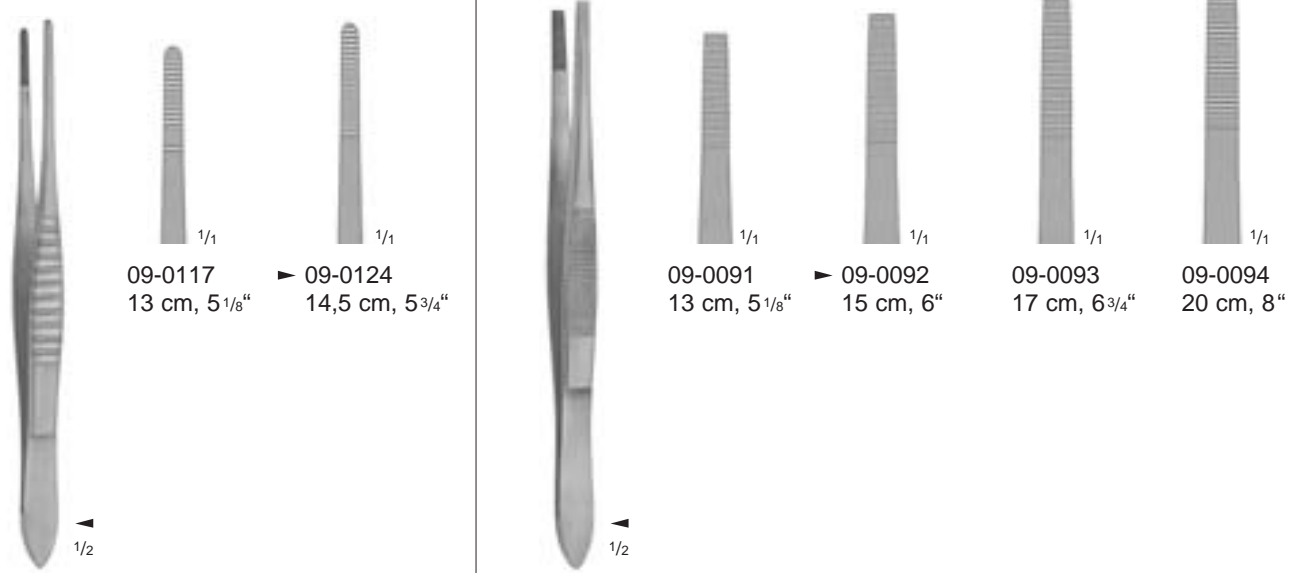

	1/1	1/1					
09-0117	▶ 09-0124	09-0091	▶ 09-0092	09-0093	09-0094		
13 cm, 5 1/8"	14,5 cm, 5 3/4"	13 cm, 5 1/8"	15 cm, 6"	17 cm, 6 3/4"	20 cm, 8"		

MOD. USA
 09-0117
 - 09-0124

09-0091
 - 09-0094

schmale Modelle
 narrow patterns
 modelos estrechos
 modèles étroits
 modelli stretti

schwedische Modelle
 Swedish patterns
 modelos suecos
 modèles suédois
 modelli svedese



Anatomische Pinzetten
 Dissecting Forceps
 Pinzas de disección
 Pinces à dissection
 Pinze anatomiche per dissezione

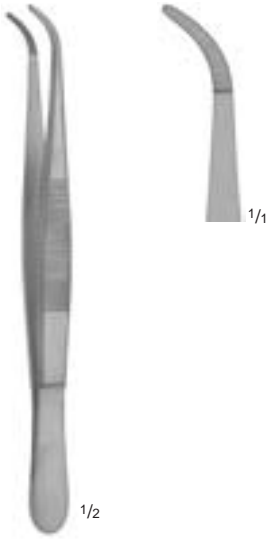

09-0191
 14 cm, 5 1/2"

schmales Modell
 narrow pattern
 modelo estrecho
 modèle étroits
 modello stretto

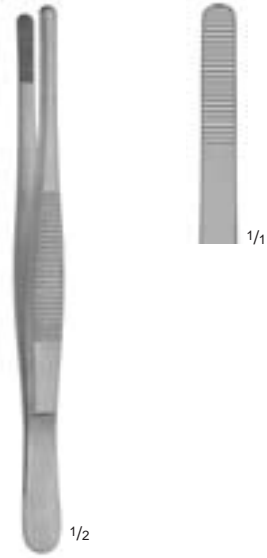

09-0123
 14,5 cm, 5 3/4"

breites Modell
 wide pattern
 modelo ancho
 modèle large
 modello largo

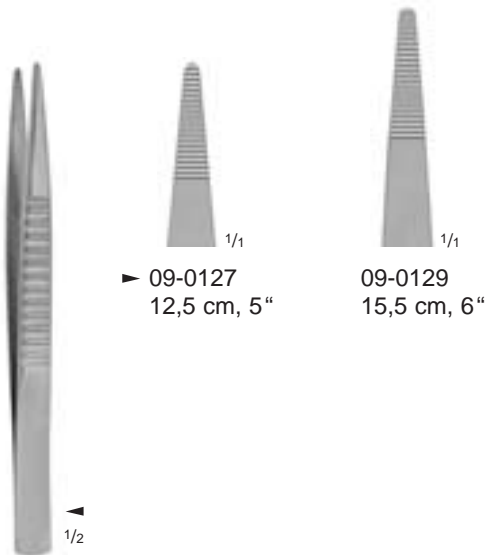

▶ 09-0127
 12,5 cm, 5"

09-0129
 15,5 cm, 6"

09-0127
 - 09-0129
 englische Modelle
 English patterns
 modelos ingleses
 modèles anglais
 modelli inglese

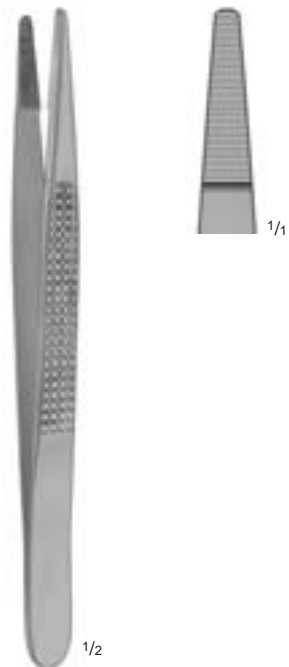

BONNEY
 09-0280
 17 cm, 6 3/4"

ATRAUMATIC-GRIP Gefäßpinzetten mit atraumatischer Riefung
ATRAUMATIC-GRIP Vascular Forceps with non-traumatic serration
ATRAUMATIC-GRIP Pinzas vasculares con bocas atraumáticas
ATRAUMATIC-GRIP Pincers vasculaires avec mors atraumatiques
ATRAUMATIC-GRIP Pinze vascolari con presa atraumatica



1,5 mm

1,5 mm

1,5 mm



1/1

30-0051
15,5 cm, 6"



1/1

30-0061
20 cm, 8"



1/1

30-0071
24 cm, 9 1/2"

2,0 mm

2,0 mm

2,0 mm

2,0 mm



1/1

30-0050
15,5 cm, 6"



1/1

▶ 30-0060
20 cm, 8"



1/1

30-0070
24 cm, 9 1/2"



1/1

30-0010
30,5 cm, 12"



2,0 mm

2,0 mm

2,0 mm

2,7 mm



1/1

30-0055
15 cm, 6"



1/1

30-0065
19,5 cm, 7 3/4"



1/1

30-0075
23,5 cm, 9 1/4"



1/1

30-0024
30 cm, 12"



1/2

DE BAKEY
 30-0010
 - 30-0075

2,7 mm

2,7 mm

2,7 mm

2,7 mm



1/1

30-0020
15,5 cm, 6"



1/1

30-0021
20 cm, 8"



1/1

30-0022
24 cm, 9 1/2"



1/1

30-0023
30,5 cm, 12"

3,5 mm

3,5 mm

3,5 mm

3,5 mm



1/1

30-0030
15,5 cm, 6"



1/1

30-0031
20 cm, 8"



1/1

30-0032
24 cm, 9 1/2"



1/1

30-0033
30,5 cm, 12"



Ohr- und Nasenpinzetten, bajonettförmig
 Ear and Nasal Dressing Forceps, bayonet-shaped
 Pinzas auriculares y nasales, en forma bayoneta
 Pinces auriculaires et nasales, en forme de baïonnette
 Pinze auricolari e nasali, a baionetta



LUCAE
 09-0812
 14 cm, 5 1/2"



JANSEN
 09-0814
 16 cm, 6 1/4"



GRUENWALD (JANSEN)
 09-0818
 19 cm, 7 1/2"



TAYLOR-CUSHING
 09-0710
 18,5 cm, 7 1/4"

mit Dissektor-Ende
 with dissector end
 con cabo disecador
 avec talon dissecteur
 con dissettore



GRUENWALD
 09-0815
 16 cm, 6 1/4"
 1x2 Zähne
 1x2 teeth
 1x2 dientes
 1x2 dents
 1x2 denti



GRUENWALD
 09-0819
 19 cm, 7 1/2"
 1x2 Zähne
 1x2 teeth
 1x2 dientes
 1x2 dents
 1x2 denti



TAYLOR-CUSHING
 09-0715
 18,5 cm, 7 1/4"
 1x2 Zähne
 1x2 teeth
 1x2 dientes
 1x2 dents
 1x2 denti

mit Dissektor-Ende
 with dissector end
 con cabo disecador
 avec talon dissecteur
 con dissettore

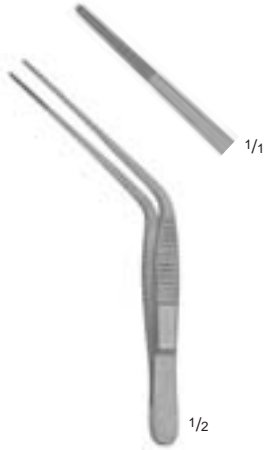

TROELTSCH (WILDE)
 09-0804
 11 cm, 4^{3/8}"



TROELTSCH (WILDE)
 09-0800
 12,5 cm, 5"



TROELTSCH (WILDE)
 09-0806
 13,5 cm, 5^{1/4}"
 selbstschließend
 cross action
 cruzada
 à pression continue
 incrociata



TROELTSCH
 09-0808
 15 cm, 6"

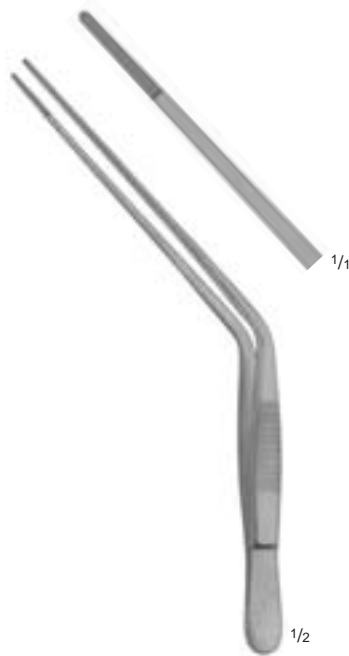

TROELTSCH
 09-0809
 17 cm, 6^{3/4}"



TROELTSCH (WILDE)
 09-0801
 12,5 cm, 5"
 1x2 Zähne
 1x2 teeth
 1x2 dientes
 1x2 dents
 1x2 denti



Feine chirurgische Pinzetten
 Delicate Tissue Forceps
 Pinzas finas quirúrgicas
 Pincas fines quirúrgicas
 Pinze fini per chirurgia

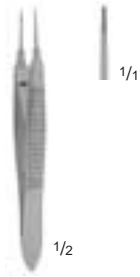

MOD. BONN
62-0255

7 cm, 2 3/4"

mit Fadenplatte
 Zähne 0,12 mm
 with tying platform
 teeth 0.12 mm

con piattaforma
 dientes 0,12 mm

avec méplat
 dents 0,12 mm

con piattaforma
 denti 0,12 mm

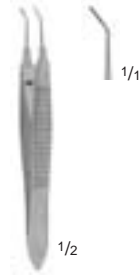

MOD. BONN
62-0254

7 cm, 2 3/4"

mit Fadenplatte
 Zähne 0,12 mm
 with tying platform
 teeth 0.12 mm

con piattaforma
 dientes 0,12 mm

avec méplat
 dents 0,12 mm

con piattaforma
 denti 0,12 mm

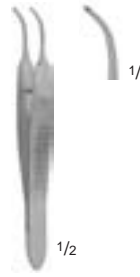

SAUER
62-0561

7 cm, 2 3/4"

ohne Fadenplatte
 Zähne 0,3 mm

without tying platform
 teeth 0.3 mm

sin piattaforma
 dientes 0,3 mm

sans méplat
 dents 0,3 mm

senza piattaforma
 denti 0,3 mm



MOD. BONN
62-0256

9,5 cm, 3 3/4"

mit Fadenplatte
 Zähne 0,12 mm
 with tying platform
 teeth 0.12 mm

con piattaforma
 dientes 0,12 mm

avec méplat
 dents 0,12 mm

con piattaforma
 denti 0,12 mm



CASTROVIEJO

62-0770

- **62-0772**

mit Fadenplatte
 with tying platform
 con piattaforma
 avec méplat
 con piattaforma



62-0772
 10 cm, 4"

Zähne 0,5 mm
 teeth 0.5 mm
 dientes 0.5 mm
 dents 0.5 mm
 denti 0.5 mm



▶ **62-0771**
 10 cm, 4"

Zähne 0,9 mm
 teeth 0.9 mm
 dientes 0.9 mm
 dents 0.9 mm
 denti 0.9 mm



62-0770
 10 cm, 4"

Zähne 1,5 mm
 teeth 1.5 mm
 dientes 1.5 mm
 dents 1.5 mm
 denti 1.5 mm



CASTROVIEJO

62-0749

- **62-0751**

mit Fadenplatte
 with tying platform
 con piattaforma
 avec méplat
 con piattaforma



62-0749
 11 cm, 4 3/8"

Zähne 0,15 mm
 teeth 0.15 mm
 dientes 0.15 mm
 dents 0.15 mm
 denti 0.15 mm



▶ **62-0750**
 11 cm, 4 3/8"

Zähne 0,3 mm
 teeth 0.3 mm
 dientes 0.3 mm
 dents 0.3 mm
 denti 0.3 mm



62-0751
 11 cm, 4 3/8"

Zähne 0,5 mm
 teeth 0.5 mm
 dientes 0.5 mm
 dents 0.5 mm
 denti 0.5 mm



ST. MARTIN
 62-0864
 8 cm, 3 1/8"
 mit Fadenplatte
 with tying platform
 con plataforma
 avec méplat
 con piattaforma



PAUFIQUE
 62-0862
 8,5 cm, 3 3/8"
 mit Fadenplatte
 with tying platform
 con plataforma
 avec méplat
 con piattaforma

0,5 mm



► 09-0026
 10 cm, 4"

1,0 mm



09-0020
 10 cm, 4"

0,5 mm



62-0250
 7 cm, 2 3/4"

0,7 mm



► 62-0280
 7 cm, 2 3/4"

1,0 mm



62-0281
 7 cm, 2 3/4"

0,5 mm



09-0027
 10 cm, 4"

1,0 mm



09-0021
 10 cm, 4"

0,5 mm



62-0252
 7 cm, 2 3/4"

0,7 mm



62-0283
 7 cm, 2 3/4"

1,0 mm



62-0284
 7 cm, 2 3/4"

0,5 mm



09-0029
 9,5 cm, 3 3/4"

1,0 mm



09-0023
 9,5 cm, 3 3/4"



GRAEFE
 62-0250
 - 62-0284
 1x2 Zähne
 1x2 teeth
 1x2 dientes
 1x2 dents
 1x2 denti



09-0020
 - 09-0029
 1x2 Zähne
 1x2 teeth
 1x2 dientes
 1x2 dents
 1x2 denti



Feine chirurgische Pinzetten
Delicate Tissue Forceps
Pinzas finas quirúrgicas
Pincas fines quirúrgicas
Pinze fini per chirurgia

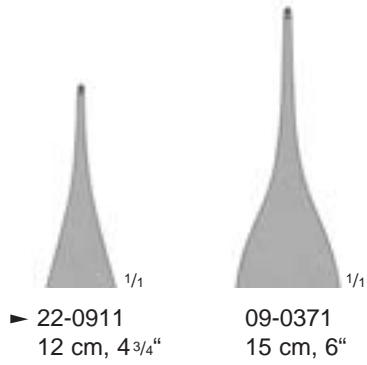

MICRO-ADSON
09-0371
- 22-0911
1x2 Zähne
1x2 teeth
1x2 dientes
1x2 dents
1x2 denti

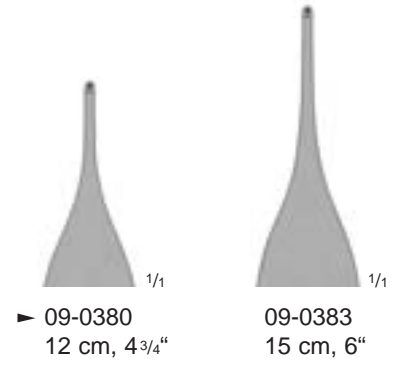

ADSON
09-0380
- 09-0383
1x2 Zähne
1x2 teeth
1x2 dientes
1x2 dents
1x2 denti



EWALD
09-0396
12 cm, 4 3/4"
1x2 Zähne
1x2 teeth
1x2 dientes
1x2 dents
1x2 denti



ADSON
09-0385
12 cm, 4 3/4"
2x3 Zähne
2x3 teeth
2x3 dientes
2x3 dents
2x3 denti

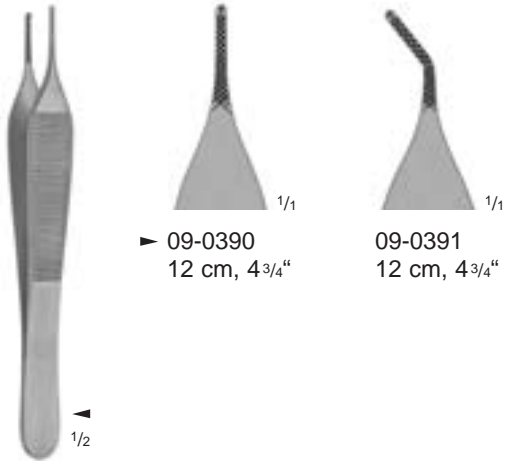

▶ 09-0390
 12 cm, 4^{3/4}"

09-0391
 12 cm, 4^{3/4}"

ADSON
 09-0390
 - 09-0391
 1x2 Zähne
 1x2 teeth
 1x2 dientes
 1x2 dents
 1x2 denti



ADSON-BROWN
 09-0400
 12 cm, 4^{3/4}"
 9x9 Zähne
 9x9 teeth
 9x9 dientes
 9x9 dents
 9x9 denti

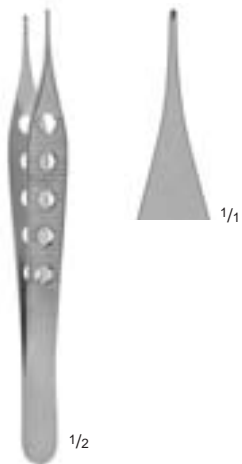

MICRO-ADSON
 09-0397
 12 cm, 4^{3/4}"
 1x2 Zähne
 1x2 teeth
 1x2 dientes
 1x2 dents
 1x2 denti

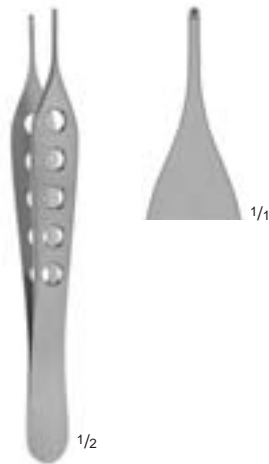

ADSON
 09-0398
 12 cm, 4^{3/4}"
 1x2 Zähne
 1x2 teeth
 1x2 dientes
 1x2 dents
 1x2 denti

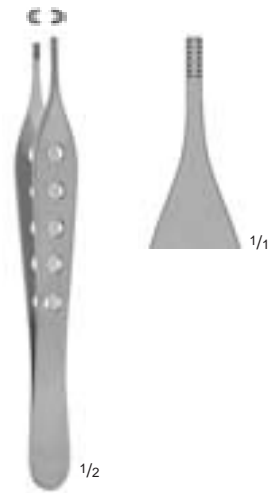

ADSON-BROWN
 09-0399
 12 cm, 4^{3/4}"
 9x9 Zähne
 9x9 teeth
 9x9 dientes
 9x9 dents
 9x9 denti



Feine chirurgische Pinzetten

Delicate Tissue Forceps

Pinzas finas quirúrgicas

Pinces fines chirurgicales

Pinze fini per chirurgia

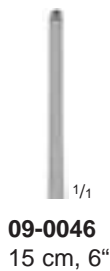
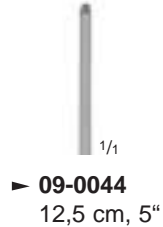

SEMKEN

09-0044

- **09-0046**

1x2 Zähne
1x2 teeth
1x2 dientes
1x2 dents
1x2 denti



GILLIES

09-0425

15 cm, 6"

1x2 Zähne
1x2 teeth
1x2 dientes
1x2 dents
1x2 denti



GERALD

09-0616

- **09-0617**

1x2 Zähne
1x2 teeth
1x2 dientes
1x2 dents
1x2 denti



mit Dissektor-Ende
with dissector end
con cabo disecador
avec talon dissecteur
con dissettore

CUSHING

09-0745

17,5 cm, 7"

1x2 Zähne
1x2 teeth
1x2 dientes
1x2 dents
1x2 denti

Feine chirurgische Pinzetten

Delicate Tissue Forceps

Pinzas finas quirúrgicas

Pinces fines chirurgicales

Pinze fini per chirurgia



1x2 Zähne, mit Dissektor-Ende

1x2 teeth, with dissector end

1x2 dientes, con cabo disecador

1x2 dents, avec talon dissecteur

1x2 denti, con dissettore

TAYLOR-CUSHING
09-0705
17,5 cm, 7"



► **09-0575**
18,5 cm, 7 1/4"

09-0580
21 cm, 8 1/4"

09-0585
24,5 cm, 9 3/4"

09-0587
30,5 cm, 12"

1x2 Zähne • 1x2 teeth • 1x2 dientes • 1x2 dents • 1x2 denti

POTTS-SMITH
09-0575
- 09-0587



BROPHY
09-0286
- 09-0287

► **09-0286**
19,5 cm, 7 3/4"

09-0287
19,5 cm, 7 3/4"

1x2 Zähne
1x2 teeth
1x2 dientes
1x2 dents
1x2 denti



WAUGH
09-0423
20,5 cm, 8"

1x2 Zähne
1x2 teeth
1x2 dientes
1x2 dents
1x2 denti



Chirurgische Pinzetten









Tissue Forceps

Pinzas quirúrgicas

Pinces chirurgicales

Pinze per chirurgia









 1/1	 1/1	 1/1	 1/1	 1/1	 1/1	 1/1	 1/1	 1/1
09-0149 10,5 cm 4 1/8"	09-0151 12 cm 4 3/4"	09-0156 ▶ 13 cm 5 1/8"	09-0161 14,5 cm 5 3/4"	09-0168 16 cm 6 1/4"	09-0171 18 cm 7"	09-0176 20,5 cm 8"	09-0181 25 cm 10"	09-0186 30,5 cm 12"

09-0149
- **09-0186**

Standard Modelle, 1x2 Zähne

Standard patterns, 1x2 teeth
modelos standard, 1x2 dientes
modèles standard, 1x2 dents
modelli standard, 1x2 denti



 1/1	 1/1	 1/1	 1/1	 1/1	 1/1
09-0198 12 cm 4 3/4"	09-0193 13 cm 5 1/8"	▶ 09-0195 14,5 cm 5 3/4"	09-0196 16 cm 6 1/4"	09-0204 18 cm 7"	09-0205 20,5 cm 8"

09-0193
- **09-0205**

schmale Modelle, 1x2 Zähne

narrow patterns, 1x2 teeth
modelos estrechos, 1x2 dientes
modèles étroits, 1x2 dents
modelli stretti, 1x2 denti

Chirurgische Pinzetten

Tissue Forceps

Pinzas quirúrgicas

Pinces chirurgicales

Pinze per chirurgia



09-0150
12 cm
4 3/4"



09-0155
13 cm
5 1/8"



09-0160
14,5 cm
5 3/4"



▶ **09-0165**
15,5 cm
6"

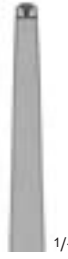

09-0170
18 cm
7"



09-0175
20,5 cm
8"



09-0180
25 cm
10"

MOD. USA

09-0150

- **09-0180**

Standard Modelle, 1x2 Zähne

Standard patterns, 1x2 teeth

modelos standard, 1x2 dientes

modèles standard, 1x2 dents

modelli standard, 1x2 denti



MOD. USA

09-0194

14,5 cm, 5 3/4"

schmales Modell, 1x2 Zähne

narrow pattern, 1x2 teeth

modelo estrecho, 1x2 dientes

modèle étroit, 1x2 dents

modello stretto, 1x2 denti



09-0197

14 cm, 5 1/2"

schmales Modell, 1x2 Zähne

narrow pattern, 1x2 teeth

modelo estrecho, 1x2 dientes

modèle étroit, 1x2 dents

modello stretto, 1x2 denti



Chirurgische Pinzetten

Tissue Forceps

Pinzas quirúrgicas

Pinces chirurgicales

Pinze per chirurgia



1/2

09-0216

- **09-0241**

2x3 Zähne
2x3 teeth
2x3 dientes
2x3 dents
2x3 denti



1/1

09-0216

13 cm, 5 1/8"



1/1

▶ **09-0221**

14,5 cm, 5 3/4"



1/1

09-0226

16 cm, 6 1/4"



1/1

09-0231

18 cm, 7"



1/1

09-0236

20 cm, 8"



1/1

09-0241

25 cm, 10"



1/2

09-0261

- **09-0276**

3x4 Zähne
3x4 teeth
3x4 dientes
3x4 dents
3x4 denti



1/1

▶ **09-0261**

14,5 cm, 5 3/4"



1/1

09-0266

16 cm, 6 1/4"



1/1

09-0276

20 cm, 8"



1/2

09-0277

14,5 cm 5 3/4"

4x5 Zähne
4x5 teeth
4x5 dientes
4x5 dents
4x5 denti

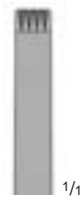

1/1

Chirurgische Pinzetten

Tissue Forceps

Pinzas quirúrgicas

Pinces chirurgicales

Pinze per chirurgia

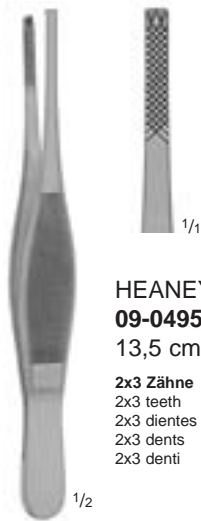

HEANEY
09-0495
13,5 cm, 5 1/4"

2x3 Zähne
2x3 teeth
2x3 dientes
2x3 dents
2x3 denti

1/2



HEANEY
09-0496
19 cm, 7 1/2"

1x2 Zähne
1x2 teeth
1x2 dientes
1x2 dents
1x2 denti

1/2



HEANEY
09-0497
19 cm, 7 1/2"

3x4 Zähne
3x4 teeth
3x4 dientes
3x4 dents
3x4 denti

1/2



CURTIS
09-0499
22,5 cm, 9"

1x2 Zähne
1x2 teeth
1x2 dientes
1x2 dents
1x2 denti

1/2

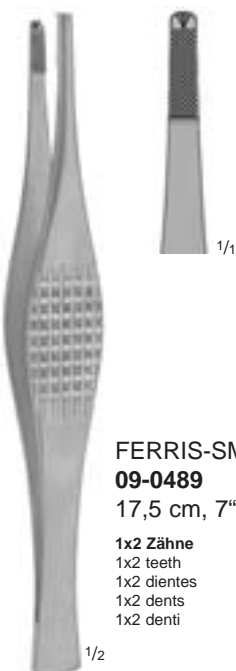

FERRIS-SMITH
09-0489
17,5 cm, 7"

1x2 Zähne
1x2 teeth
1x2 dientes
1x2 dents
1x2 denti

1/2

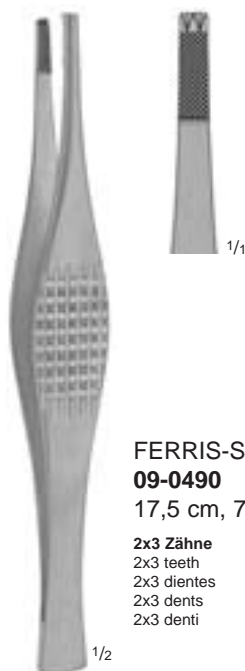

FERRIS-SMITH
09-0490
17,5 cm, 7"

2x3 Zähne
2x3 teeth
2x3 dientes
2x3 dents
2x3 denti

1/2

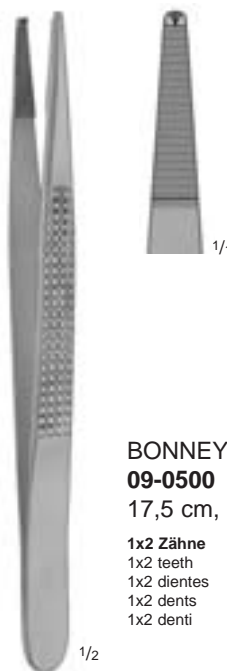

BONNEY
09-0500
17,5 cm, 7"

1x2 Zähne
1x2 teeth
1x2 dientes
1x2 dents
1x2 denti

1/2

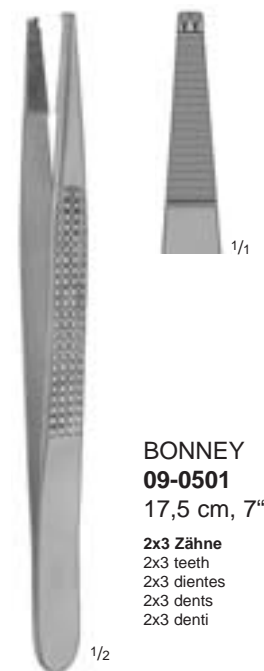

BONNEY
09-0501
17,5 cm, 7"

2x3 Zähne
2x3 teeth
2x3 dientes
2x3 dents
2x3 denti

1/2



Chirurgische Pinzetten

Tissue Forceps

Pinzas quirúrgicas

Pinces chirurgicales

Pinze per chirurgia



1/2

► **09-0410**
15 cm, 6"



1/1

09-0415
20,5 cm, 8"



1/1

09-0420
25 cm, 10"



1/1

BROWN
09-0410
- **09-0420**

Gewebefußpinzetten
Tissue seizing forceps
Pinzas agarre de tejidos
Pinces pour saisir les tissus
Pinze da presa per tessuti



1/2

GRAEFE
09-0351
11 cm, 4 3/8"

5x6 Zähne
5x6 teeth
5x6 dientes
5x6 dents
5x6 denti



1/1



1/2

NELSON
09-0660
23 cm, 9"

6x7 Zähne
6x7 teeth
6x7 dientes
6x7 dents
6x7 denti



1/1



1/2

► **09-0520**
14,5 cm 5 3/4"

4x5 Zähne
4x5 teeth
4x5 dientes
4x5 dents
4x5 denti



1/1

09-0525
20,5 cm 8"

4x5 Zähne
4x5 teeth
4x5 dientes
4x5 dents
4x5 denti



1/1

09-0530
24,5 cm 9 3/4"

6x7 Zähne
6x7 teeth
6x7 dientes
6x7 dents
6x7 denti



1/1

ADLERKREUTZ
09-0520
- **09-0530**

Gefäß- und Tumorpinzetten
Vascular and tumor forceps
Pinzas para vasos y tumores
Pinces pour vaisseaux et tumeurs
Pinza vascolare e per tumori



1/2

► **09-0531**
18 cm, 7"

3x4 Zähne
3x4 teeth
3x4 dientes
3x4 dents
3x4 denti



1/1

09-0532
20 cm, 8"

3x4 Zähne
3x4 teeth
3x4 dientes
3x4 dents
3x4 denti



1/1

09-0533
24,5 cm, 9 3/4"

3x4 Zähne
3x4 teeth
3x4 dientes
3x4 dents
3x4 denti



1/1

STILLE-BARRAYA
09-0531
- **09-0533**

Gefäß- und Tumorpinzetten
Vascular and tumor forceps
Pinzas para vasos y tumores
Pinces pour vaisseaux et tumeurs
Pinza vascolare e per tumori

Faßpinzetten

Grasping Forceps

Pinzas de agarre

Pinces pour saisir les tissus

Pinze per afferrare tessuti

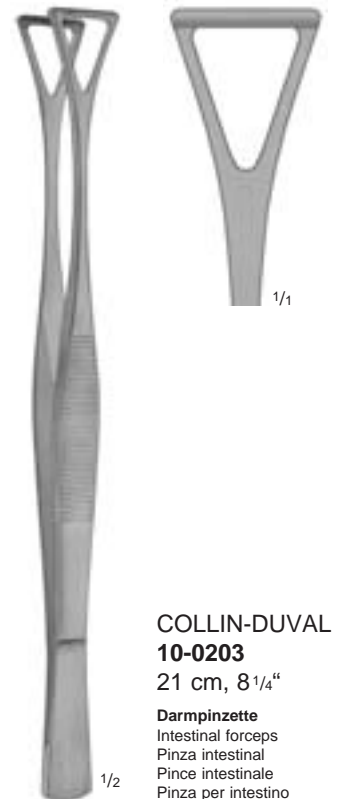
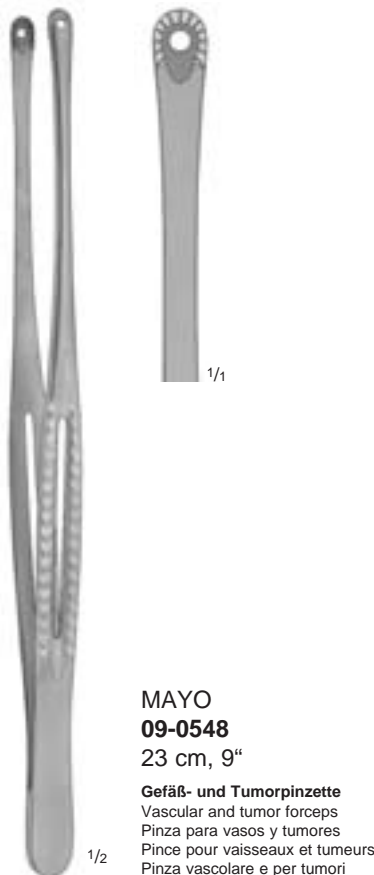
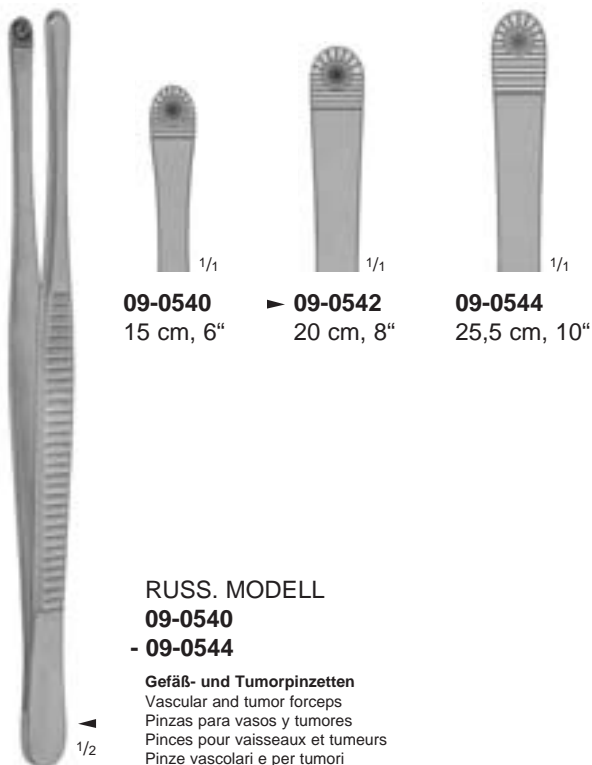
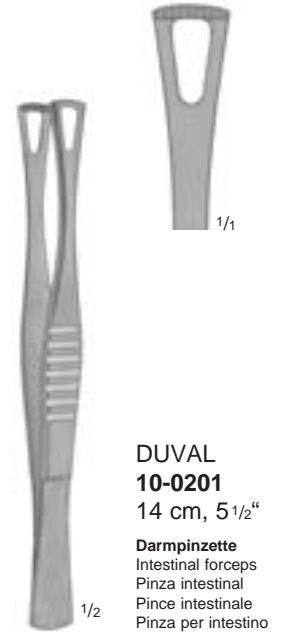
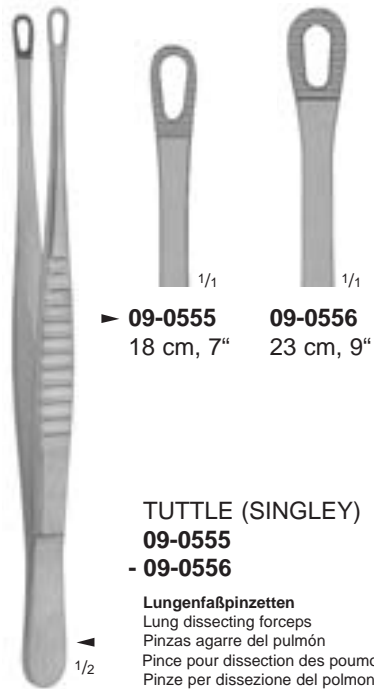
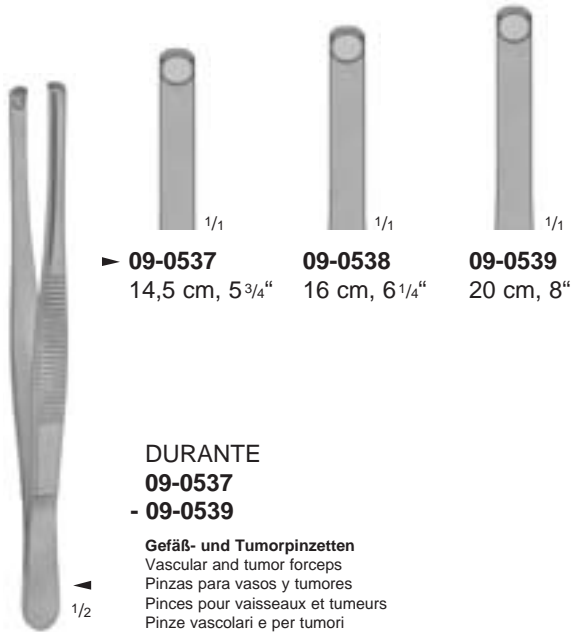



Splitterpinzetten

Splinter Forceps
Pinzas para espinas
Pinces à échardes
Pinze per schegge



► **09-0920**
8,5 cm, 3³/₈"



09-0922
10 cm, 4"



09-0924
12,5 cm, 5"



09-0926
14 cm, 5¹/₂"



09-0921
8,5 cm, 3³/₈"



09-0923
10 cm, 4"



09-0925
12,5 cm, 5"



09-0927
14 cm, 5¹/₂"



09-0920
- **09-0927**



HUNTER
09-0940
- **09-0941**



► **09-0940**
10,5 cm, 4¹/₈"



09-0941
10,5 cm, 4¹/₈"



FEILCHENFELD
09-0830
- **09-0931**



09-0830
8 cm, 3¹/₈"



09-0832
9 cm, 3¹/₂"



► **09-0931**
11,5 cm, 4¹/₂"



FEILCHENFELD
09-0933
13 cm, 5¹/₈"

mit Lupe
with magnifying loupe
con lente de aumento
avec loupe
con lente di ingrandimento

Splitterzangen

Splinter Forceps

Pinzas para espinas

Pinces à échardes

Pinze per schegge

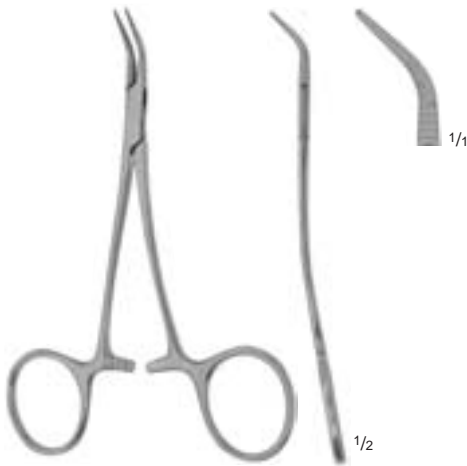

PEET
06-0110
12 cm, 4³/₄"



PEET
09-1880
- **09-1881**

mit Hartmetalleinlagen
with tungsten carbide inserts
con bocas de carburo tungsteno
avec mors en carbure de tungstène
con inserti in carburo di tungsteno

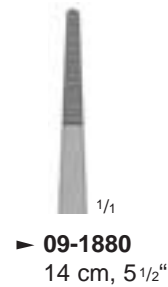

► **09-1880**
14 cm, 5¹/₂"



09-1881
14 cm, 5¹/₂"

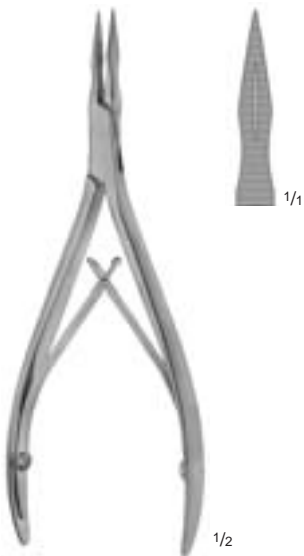

RALKS
(VIRTUS)
09-0980
14,5 cm, 5³/₄"



ARTHUR
09-0988
14 cm, 5¹/₂"

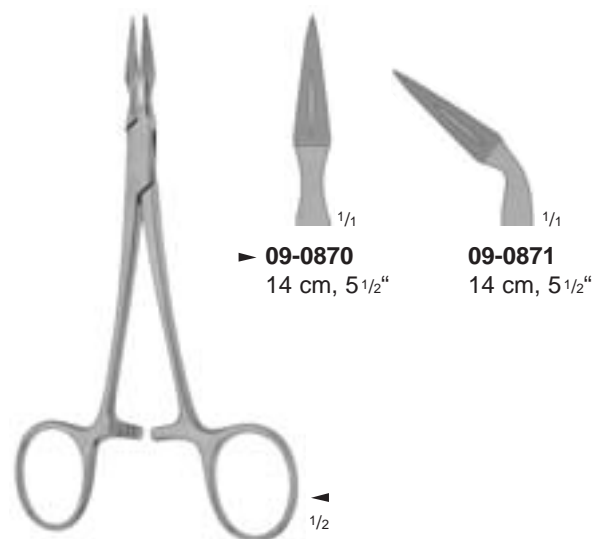

STIEGLITZ
(WILLIAMS)
09-0870
- **09-0871**

► **09-0870**
14 cm, 5¹/₂"

09-0871
14 cm, 5¹/₂"



Cilienpinzetten

Cilia Forceps
Pinzas depilatorias
Pincès à épiler
Pinze per ciglia

Deckglaspinzette

Cover Glass Forceps
Pinza porta-laminillas
Pince porte-laminaires
Pinza con copertura vetrificata

Fadenpinzette

Ligature Forceps
Pinza para ligaduras
Pince pour ligatures
Pinza per legature



SCHAAF
62-1220
9,5 cm, 3 3/4"

Cilienpinzette
Cilia forceps
Pinza depilatoria
Pince à épiler
Pinza per ciglia

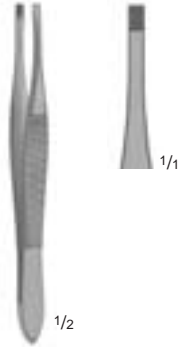

DOUGLAS
62-1400
9 cm, 3 1/2"

Cilienpinzette
Cilia forceps
Pinza depilatoria
Pince à épiler
Pinza per ciglia

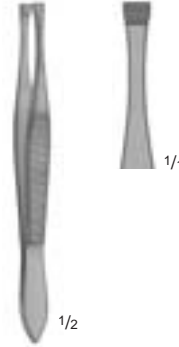

LITTAUER
62-1405
9 cm, 3 1/2"

Cilienpinzette
Cilia forceps
Pinza depilatoria
Pince à épiler
Pinza per ciglia

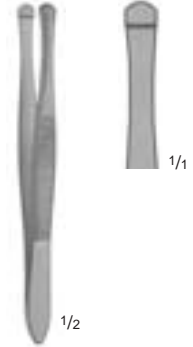

BEER
62-1420
9 cm, 3 1/2"

Cilienpinzette
Cilia forceps
Pinza depilatoria
Pince à épiler
Pinza per ciglia

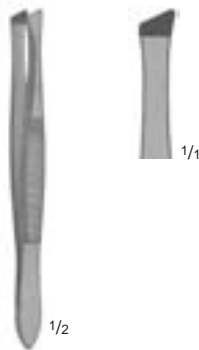

62-1402
9 cm, 3 1/2"

Cilienpinzette
Cilia forceps
Pinza depilatoria
Pince à épiler
Pinza per ciglia

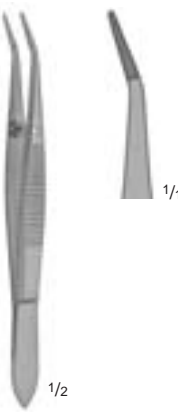

BARRAQUER
62-1460
10,5 cm, 4 1/8"

Cilienpinzette
Cilia forceps
Pinza depilatoria
Pince à épiler
Pinza per ciglia

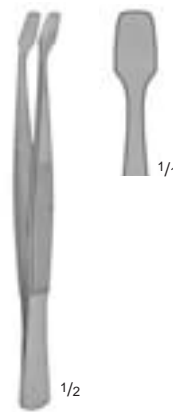

KÜHNE
09-0990
10,5 cm, 4 1/8"

Deckglaspinzette
Cover glass forceps
Pinza porta-laminilla
Pince porte-laminaires
Pinza con copertura vetrificata

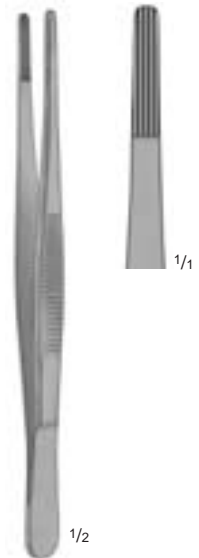

OCHSNER
09-0994
14,5 cm, 5 3/4"

Fadenpinzette
Ligature forceps
Pinza para ligadura
Pince pour ligatures
Pinza per legature



LAWNTON

Medizintechnik



Klemmen, Klemmzangen
Forceps, Clamps Forceps
Pinzas, Pinzas-clamps
Pinces, Pinces-clamps
Pinze, Pinze emostatiche



Gefäßclips für temporären Gebrauch
 Vessel Clips for temporary occlusion
 Clips vasculares para oclusión temporal
 Serre-Fines pour occlusion temporaire
 Pinze per occlusione temporanea



MINI-YASARGIL
 06-0140
 18 cm, 7"



MINI-YASARGIL
 ▶ 06-0141 17 cm, 6³/₄"
 06-0142 21 cm, 8¹/₄"
 06-0143 23 cm, 9"



STANDARD-YASARGIL
 06-0145
 18 cm, 7"



STANDARD-YASARGIL
 ▶ 06-0146 17 cm, 6³/₄"
 06-0147 21 cm, 8¹/₄"
 06-0148 23 cm, 9"

Anlegepinzetten für Gefäßclips 06-0180 - 06-0185
 Applying forceps for vessel clips 06-0180 - 06-0185
 Pinzas para aplicar clips vasculares 06-0180 - 06-0185
 Applicateur pour clips vasculaires 06-0180 - 06-0185
 Applicatore per clips vascolari 06-0180 - 06-0185





Anlegepinzetten für Gefäßclips 06-0190 - 06-0193
 Applying forceps for vessel clips 06-0190 - 06-0193
 Pinzas para aplicar clips vasculares 06-0190 - 06-0193
 Applicateur pour clips vasculaires 06-0190 - 06-0193
 Applicatore per clips vascolari 06-0190 - 06-0193





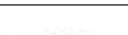
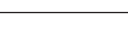

MINI-YASARGIL
 06-0180
 - 06-0185



STANDARD-YASARGIL
 06-0190
 - 06-0193

Maul kreuzgerieft	Kat. Nr.	Maul- öffnung	Maul- länge	Schließ- druck
Cross serrations	Cat. ref.	Opening of jaw	Length of jaw	Occlusion pressure
Boca estriada crucial	Núm. de cat.	Apertura de boca	Longitud de boca	Presión de oclusión
Mors à rainures croisées	No. de cat.	Ouverture des mors	Longueur des mors	Pression d'occlusion
Morsi a zigrinatura incrociata	No di cat.	Apertura dei morsi	Lungh. dei morsi	Pressione occlusiva
 1/1	06-0180	3,3 mm	3 mm	50 gr.
 1/1	06-0181	4,0 mm	5 mm	50 gr.
 1/1	06-0182	3,8 mm	5 mm	50 gr.
 1/1	06-0183	4,6 mm	7 mm	70 gr.
 1/1	▶ 06-0184	4,4 mm	7 mm	70 gr.
 1/1	06-0185	4,0 mm	7 mm	70 gr.

Maul kreuzgerieft	Kat. Nr.	Maul- öffnung	Maul- länge	Schließ- druck
Cross serrations	Cat. ref.	Opening of jaw	Length of jaw	Occlusion pressure
Boca estriada crucial	Núm. de cat.	Apertura de boca	Longitud de boca	Presión de oclusión
Mors à rainures croisées	No. de cat.	Ouverture des mors	Longueur des mors	Pression d'occlusion
Morsi a zigrinatura incrociata	No di cat.	Apertura dei morsi	Lungh. dei morsi	Pressione occlusiva
 1/1	▶ 06-0190	7,0 mm	9 mm	70 gr.
 1/1	06-0191	6,8 mm	9 mm	70 gr.
 1/1	06-0192	6,1 mm	9 mm	70 gr.
 1/1	06-0193	6,5 mm	9 mm	70 gr.

Gefäßclips für temporären Gebrauch
 Vessel Clips for temporary occlusion
 Clips vasculares para oclusión temporal
 Serre-Fines pour occlusion temporaire
 Pinze per occlusioni temporanee



SCHWARTZ
 50-0620
 19,5 cm, 7 3/4"

Anlegezange für Gefäßclips 50-0621 - 50-0623
 Applying forceps for vessel clips 50-0621 - 50-0623
 Pinza para aplicar clips vasculares 50-0621 - 50-0623
 Applicateur pour clips vasculaires 50-0621 - 50-0623
 Applicatore per clips vascolari 50-0621 - 50-0623



1/1

SCHWARTZ
 50-0621
 - 50-0623



Maul glatt
 Smooth jaws
 Boca lisa
 Mors lisses
 Morsi lisci

Kat. Nr.
 Cat. ref.
 Núm. de cat.
 No. de cat.
 No di cat.

Maulöffnung
 Opening of jaw
 Apertura de boca
 Ouverture des mors
 Apertura dei morsi

Maullänge
 Length of jaw
 Longitud de boca
 Longueur des mors
 Lungh. dei morsi

Schließdruck
 Occlusion pressure
 Presión de oclusión
 Pression d'occlusion
 Pressione occlusiva

Maul glatt Smooth jaws Boca lisa Mors lisses Morsi lisci	Kat. Nr. Cat. ref. Núm. de cat. No. de cat. No di cat.	Maulöffnung Opening of jaw Apertura de boca Ouverture des mors Apertura dei morsi	Maullänge Length of jaw Longitud de boca Longueur des mors Lungh. dei morsi	Schließdruck Occlusion pressure Presión de oclusión Pression d'occlusion Pressione occlusiva
 1/1	▶ 50-0621	3 mm	10 mm	720 gr.
 1/1	50-0622	3 mm	10 mm	720 gr.
 1/1	50-0623	3 mm	10 mm	720 gr.



Gefäßclips für temporären Gebrauch
 Vessel Clips for temporary occlusion
 Clips vasculares para oclusión temporal
 Serre-Fines pour occlusion temporaire
 Pinze per occlusioni temporanee



06-0470
 14,5 cm, 5 3/4"

Anlegepinzette ohne Schloß, für Gefäßclips
 06-0475 - 06-0477 und Approximatoren
 06-0480 - 06-0484

Applying forceps without spring catch,
 for vessel clips 06-0475 - 06-0477 and
 approximators 06-0480 - 06-0484

Pinza para aplicar clips vasculares
 06-0475 - 06-0477 y aproximadores
 06-0480 - 06-0484, sin cierre de resorte

Pince pour poser les clips vasculaires
 06-0475 - 06-0477 et approximateurs
 06-0480 - 06-0484 sans fermeture

Applicatore per clips vascolari
 06-0475 - 06-0477 e approssimatori
 06-0480 - 06-0484 senza fermo

1/2



06-0471
 14,5 cm, 5 3/4"

Anlegepinzette mit Schloß, für Gefäßclips
 06-0475 - 06-0477 und Approximatoren
 06-0480 - 06-0484

Applying forceps with spring catch,
 for vessel clips 06-0475 - 06-0477 and
 approximators 06-0480 - 06-0484

Pinza para aplicar clips vasculares
 06-0475 - 06-0477 y aproximadores
 06-0480 - 06-0484, con cierre de resorte

Pince pour poser les clips vasculaires
 06-0475 - 06-0477 et approximateurs
 06-0480 - 06-0484 avec fermeture

Applicatore per clips vascolari
 06-0475 - 06-0477 e approssimatori
 06-0480 - 06-0484 con fermo

1/2



BIEMER
06-0475
 - 06-0477

1/1



Maul schräg gerieft
 Oblique serrations
 Boca estriada al oblicuo
 Mors striés en oblique
 Morsi a zigiratura obliqua

Kat. Nr.
 Cat. ref.
 Núm. de cat.
 No. de cat.
 No di cat.

Maulöffnung
 Opening of jaw
 Apertura de boca
 Ouverture des mors
 Apertura dei morsi

Maullänge
 Length of jaw
 Longitud de boca
 Longueur des mors
 Lungh. dei morsi

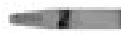
Schließdruck
 Occlusion pressure
 Presión de oclusión
 Pression d'occlusion
 Pressione occlusiva

	Kat. Nr. Cat. ref. Núm. de cat. No. de cat. No di cat.	Maulöffnung Opening of jaw Apertura de boca Ouverture des mors Apertura dei morsi	Maullänge Length of jaw Longitud de boca Longueur des mors Lungh. dei morsi	Schließdruck Occlusion pressure Presión de oclusión Pression d'occlusion Pressione occlusiva
 1/1	▶ 06-0475	4 mm	6 mm	30-40 gr.
 1/1	06-0476	5 mm	9 mm	30-40 gr.
 1/1	06-0477	5 mm	9 mm	20-25 gr.

Approximatoren für Mikro-Gefäßanastomosen im oberflächlichen Bereich

Approximators for micro vessel anastomosis in the superficial range

Aproximadores para anastomosis micro-vascular en la superficie

Approximateurs pour anastomose micro vasculaire superficielle

Approssimatori per anastomosi micro-vascolare in superficie



- Der Abstand zwischen den Gefäßclips ist durch einfaches Verschieben variabel und wird durch Verkantung selbsttätig fixiert.
- Adjustable distance between the vessel clips and automatic fixation by tilting.
- Distancia ajustable de los clips vasculares por inclinación y fijación automática.
- La distance entre les clips vasculaires est réglable et fixation automatique par inclination
- Distanza regolabile tra i clips vascolari e posizionamento automatico



BIEMER-MÜLLER

06-0480

1/1 - 06-0484

Maul schräg gerieft
Oblique serrations
Boca estriada al oblicuo
Mors striés en oblique
Morsi a zigrinatura obliqua

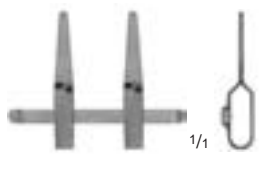
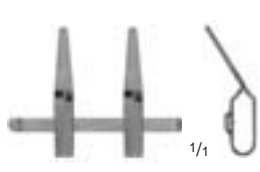
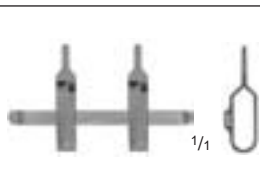
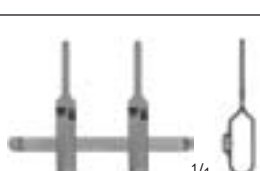
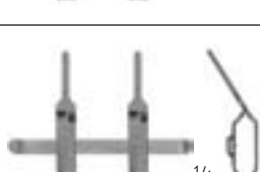
	Kat. Nr. Cat. ref. Núm. de cat. No. de cat. No di cat.	Maulöffnung Opening of jaw Apertura de boca Ouverture des mors Apertura dei morsi	Maullänge Length of jaw Longitud de boca Longueur des mors Lungh. dei morsi	Schließdruck Occlusion pressure Presión de oclusión Pression d'occlusion Pressione occlusiva
	▶ 06-0480	5 mm	9 mm	25-30 gr.
	06-0481	5 mm	9 mm	25-30 gr.
	06-0482	3 mm	4,5 mm	25-30 gr.
	06-0483	5 mm	9 mm	25-30 gr.
	06-0484	5 mm	9 mm	25-30 gr.



Approximatoren mit 3/8 Kreis Maulbogen für feste Rundkörper
Approximators with 3/8 circle jaw parts for rigid round bodies
Approximadores con 3/8 curvatura de boca para cuerpos redondos y rígidos
Approximateurs avec mors 3/8 cercle pour corps ronds rigides
Approssimatori con curvatura della bocca di 3/8 per corpi rotondi e rigidi



06-0470
 14,5 cm, 5 3/4"

Anlegepinzette ohne Schloß, für
 Approximatoren 06-0485 - 06-0488

Applying forceps without spring catch,
 for approximators 06-0485 - 06-0488

Pinza para aplicar aproximadores
 06-0485 - 06-0488, sin cierre de resorte

Pince pour poser les approximateurs
 06-0485 - 06-0488, sans fermeture

Pinza per applicazione approssimatori
 06-0485 - 06-0488, senza fermo

1/2



06-0471
 14,5 cm, 5 3/4"

Anlegepinzette mit Schloß, für
 Approximatoren 06-0485 - 06-0488

Applying forceps with spring catch,
 for approximators 06-0485 - 06-0488

Pinza para aplicar aproximadores
 06-0485 - 06-0488, con cierre de resorte

Pince pour poser les approximateurs
 06-0485 - 06-0488, avec fermeture

Pinza per applicazione approssimatori
 06-0485 - 06-0488, con fermo

1/2



MÜLLER
 06-0485
 - 06-0488

1/1

Maul schräg gerieft
 Oblique serrations
 Boca estriada al oblicuo
 Mors striés en oblique
 Morsi a zigrinatura obliqua

Kat. Nr.
 Cat. ref.
 Núm. de cat.
 No. de cat.
 No di cat.

Durchmesser
 Diameter
 Diámetro
 Diamètre
 Diametro

Schließdruck
 Occlusion pressure
 Presión de oclusión
 Pression d'occlusion
 Pressione occlusiva

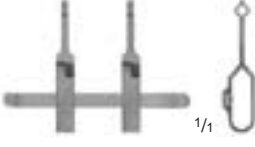
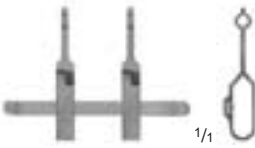
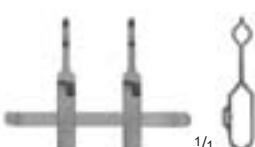
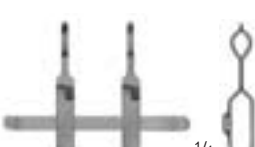
	Kat. Nr. Cat. ref. Núm. de cat. No. de cat. No di cat.	Durchmesser Diameter Diámetro Diamètre Diametro	Schließdruck Occlusion pressure Presión de oclusión Pression d'occlusion Pressione occlusiva
	06-0485	1 mm	25-30 gr.
	▶ 06-0486	2 mm	25-30 gr.
	06-0487	3 mm	25-30 gr.
	06-0488	4 mm	25-30 gr.



- Der Abstand zwischen den Clips ist variabel und wird mit einem Schlüssel fixiert.
- The distance between the clips is variable and fixed with a key.
- La distancia entre los clips es variable y se fija con una llave.
- La distance entre les clips est variable et se fixe avec une clef
- La distanza tra i clips è variabile e bloccata con chiave



06-0489

Approximator mit Schlüssel, für Mikro-Gefäßanastomosen im tieferen Bereich. Schließdruck wird mit dem Schlüssel eingestellt.

Approximator with key, for micro vessel anastomosis in the deeper range. The pressure measure is adjusted with the key.

Aproximador con llave, para anastomosis micro-vascular en la profundidad. Presión de oclusión se ajusta con la llave.

Approximateur avec clef, pour anastomose micro vasculaire en profondeur. Pression de l'occlusion ajustable avec la clef.

Approssimatore con chiave, per anastomosi micro-vascolare in profondità pressione di occlusione regolabile con chiave.

06-0490

Schlüssel allein
 Key only
 Llave suelta
 Clef seule
 Sola chiave

06-0491

Approximator allein
 Approximator only
 Aproximador suelto
 Approximateur seul
 solo approssimatore

- Der Abstand zwischen den Nadeln ist variabel und wird mit einem Schlüssel fixiert.
- The distance between the needles is variable and fixed with a key.
- La distancia entre las agujas es variable y se fija con una llave.
- La distance entre les aiguilles est variable et se fixe avec une clef
- La distanza tra gli aghi è variabile e bloccata con chiave



06-0492

Nerv-Approximator mit Schlüssel, zur sicheren Adaption bei Nervanastomosen. Nadeln mit Schlüssel auswechselbar.

Approximator for nerves with key, for safe adaptation of nerve anastomoses. The needles can be exchanged with the key.

Aproximador para nervios con llave, para asegurar la adaptación de anastomosis de nervios. Las agujas se pueden cambiar con la llave.

Approximateur pour nerfs avec clef, bien adapté à l'anastomose des nerfs. Les aiguilles peuvent être changées avec la clef.

Approssimatore per nervi con chiave, per adattamento sicura a l'anastomose dei nervi. Aghi di ricambio con chiave.

06-0490

Schlüssel allein
 Key only
 Llave suelta
 Clef seule
 Sola chiave

06-0493

Nerv- Approximator allein
 Approximator for nerves, only
 Aproximador para nervios, suelto
 Approximateur pour nerfs, seul
 solo approssimatore per nervi

06-0494

1 Paar Ersatznadeln
 1 Pair of spare needles
 1 par de agujas de repuesto
 1 paire d'aiguilles de rechange
 1 paio di aghi di ricambio



TITAN-LINE Bulldogklemmen aus Titan
 TITAN-LINE Bulldog Clamps, made of Titanium
 TITAN-LINE Clamps Bulldog, de titanio
 TITAN-LINE Clamps Bulldog en Titane
 TITAN-LINE Pinze Bulldog in Titanio



30-0999
 23 cm, 9"

Anlege- und Entfernungszeuge
 für TITAN-LINE Bulldogklemmen
 30-0960 - 30-0997

Applying and removing forceps
 for TITAN-LINE Bulldog clamps
 30-0960 - 30-0997

Pinza para poner y quitar
 TITAN-LINE clamps Bulldog
 30-0960 - 30-0997

Pinze pour poser et retirer les clamps
 Bulldog TITAN-LINE 30-0960 - 30-0997

1/2 Pinze metti-rimuovi clamps Bulldog
 TITAN-LINE 30-0960 - 30-0997

Kennzeichnung bei TITAN-LINE Bulldogklemmen:

Identification on TITAN-LINE Bulldog clamps:

Identificación de TITAN-LINE clamps Bulldog:

Identification des clamps Bulldog TITAN-LINE

Identificazione dei clamps Bulldog TITAN-LINE



V (Vena) = schwacher Druck
 V (Vena) = low pressure
 V (Vena) = Presión floja
 V (Veine) = Pression faible
 V (Vena) = Pressione bassa



A (Arteria) = starker Druck
 A (Arteria) = high pressure
 A (Arteria) = Presión fuerte
 A (Artère) = Pression forte
 A (Arteria) = Pressione alta

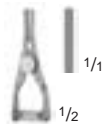

Kennzeichnung Identification Identificación Identification Identificazione	V = Vena	A = Arteria	V = Vena	A = Arteria	V = Vena	A = Arteria	V = Vena	A = Arteria
Kat. Nr. Cat. ref. Núm. de cat. No. de cat. No di cat.	30-0980	30-0960	30-0982	30-0962	30-0984	30-0964	30-0986	30-0966
Länge Length Longitud Longeur Lungh.	30 mm		35 mm		40 mm		50 mm	
Maullänge Length of jaw Longitud de boca Longueur des mors Lungh. dei morsi	9 mm		13 mm		14 mm		23 mm	
Schließdruck Occlusion pressure Presión de oclusión Pression d'occlusion Pressione occlusiva	110 ± 10 gr.	220 ± 10 gr.	110 ± 10 gr.	220 ± 10 gr.	110 ± 10 gr.	220 ± 10 gr.	110 ± 10 gr.	220 ± 10 gr.
Gewicht Weight Peso Poids Peso	1 gr.		1 gr.		1 gr.		1,5 gr.	

TITAN-LINE Bulldogklemmen aus Titan
TITAN-LINE Bulldog Clamps, made of Titanium
TITAN-LINE Clamps Bulldog, de titanio
TITAN-LINE Clamps Bulldog en Titane
TITAN-LINE Pinze Bulldog in Titanio

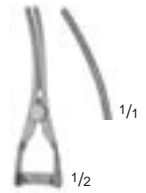
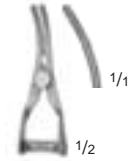
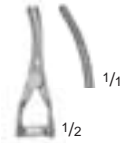
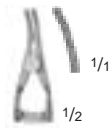

Kennzeichnung Identification Identificación Identification Identificazione	V = Vena	A = Arteria	V = Vena	A = Arteria	V = Vena	A = Arteria	V = Vena	A = Arteria
Kat. Nr. Cat. ref. Núm. de cat. No. de cat. No di cat.	30-0991	30-0971	30-0993	30-0973	30-0995	30-0975	30-0997	30-0977
Länge Length Longitud Longeur Lungh.	30 mm		35 mm		40 mm		48 mm	
Maullänge Length of jaw Longitud de boca Longueur des mors Lungh. dei morsi	9 mm		13 mm		14 mm		22 mm	
Schließdruck Occlusion pressure Presión de oclusión Pression d'occlusion Pressione occlusiva	110 ± 10 gr.	220 ± 10 gr.	110 ± 10 gr.	220 ± 10 gr.	110 ± 10 gr.	220 ± 10 gr.	110 ± 10 gr.	220 ± 10 gr.
Gewicht Weight Peso Poids Peso	1 gr.		1 gr.		1 gr.		1,5 gr.	

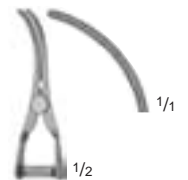
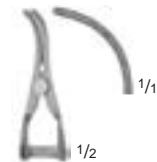

Kennzeichnung Identification Identificación Identification Identificazione	V = Vena	A = Arteria	V = Vena	A = Arteria	V = Vena	A = Arteria	V = Vena	A = Arteria
Kat. Nr. Cat. ref. Núm. de cat. No. de cat. No di cat.	30-0981	30-0961	30-0983	30-0963	30-0985	30-0965	30-0987	30-0967
Länge Length Longitud Longeur Lungh.	30 mm		35 mm		40 mm		45 mm	
Maullänge Length of jaw Longitud de boca Longueur des mors Lungh. dei morsi	10 mm		14 mm		15 mm		21 mm	
Schließdruck Occlusion pressure Presión de oclusión Pression d'occlusion Pressione occlusiva	110 ± 10 gr.	220 ± 10 gr.	110 ± 10 gr.	220 ± 10 gr.	110 ± 10 gr.	220 ± 10 gr.	110 ± 10 gr.	220 ± 10 gr.
Gewicht Weight Peso Poids Peso	1 gr.		1 gr.		1 gr.		1,5 gr.	



Mikro-Bulldogklemmen
 Micro Bulldog Clamps
 Micro-Clamps Bulldog
 Micro Clamps Bulldog
 Micro Pinze Bulldog

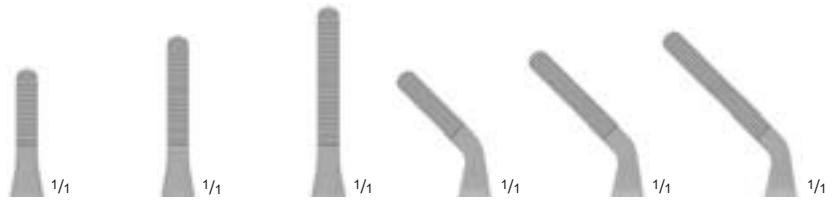

Kat. Nr. Cat. ref. Núm. de cat. No. de cat. No di cat.	06-0064	06-0065	▶ 06-0066	06-0067	06-0068	06-0069
Länge Length Longitud Longeur Lungh.	31 mm	35 mm	39 mm	30 mm	33 mm	36 mm
Maullänge Length of jaw Longitud de boca Longueur des mors Lungh. dei morsi	10 mm	14 mm	18 mm	10 mm	14 mm	18 mm
Schließdruck Occlusion pressure Presión de oclusión Pression d'occlusion Pressione occlusiva	30 ± 5 gr.	30 ± 5 gr.	30 ± 5 gr.	30 ± 5 gr.	30 ± 5 gr.	30 ± 5 gr.
Gewicht Weight Peso Poids Peso	1 gr.	1 gr.	1 gr.	1 gr.	1 gr.	1 gr.



06-0064
- 06-0069

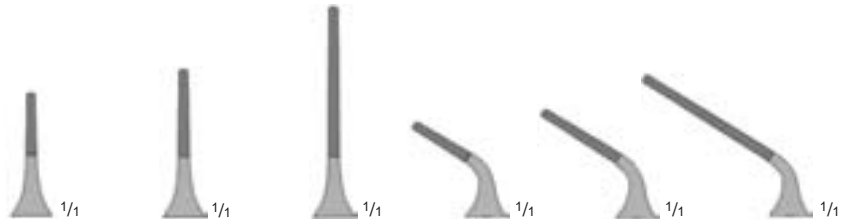

Kat. Nr. Cat. ref. Núm. de cat. No. de cat. No di cat.	06-0070	06-0071	▶ 06-0072	06-0075	06-0076	06-0077
Länge Length Longitud Longeur Lungh.	49 mm	53 mm	59 mm	45 mm	48 mm	53 mm
Maullänge Length of jaw Longitud de boca Longueur des mors Lungh. dei morsi	8 mm	12 mm	20 mm	8 mm	12 mm	20 mm
Schließdruck Occlusion pressure Presión de oclusión Pression d'occlusion Pressione occlusiva	60 ± 5 gr.	60 ± 5 gr.	60 ± 5 gr.	60 ± 5 gr.	60 ± 5 gr.	60 ± 5 gr.
Gewicht Weight Peso Poids Peso	3 gr.	3 gr.	3 gr.	3 gr.	3 gr.	3 gr.



DIETRICH
06-0070
- 06-0077



DIEFFENBACH
 06-0010
 - 06-0015

- ▶ 06-0010 38 mm
- 06-0014 48 mm
- 06-0011 38 mm
- 06-0015 48 mm



DIEFFENBACH
 06-0012
 - 06-0013

- ▶ 06-0012 58 mm
- 06-0013 58 mm



JOHNS-HOPKINS
 06-0020
 - 06-0033

- 06-0020 37 mm
- 06-0022 47 mm
- 06-0024 58 mm
- 06-0026 65 mm
- ▶ 06-0028 70 mm
- 06-0030 76 mm
- 06-0032 91 mm

- 06-0021 37 mm
- 06-0023 47 mm
- 06-0025 58 mm
- 06-0027 65 mm
- 06-0029 70 mm
- 06-0031 76 mm
- 06-0033 91 mm



Feine Arterienklemmen
 Delicate Haemostatic Forceps
 Pinzas hemostáticas finas
 Pincas hémostatiques fines
 Pinze emostatiche fini

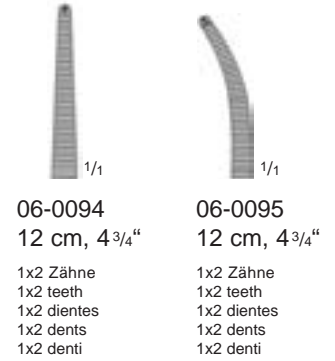
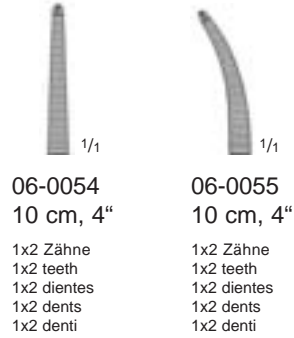
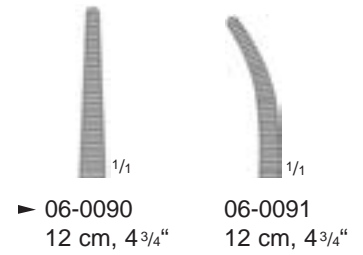
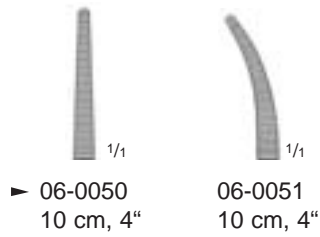

BABY-MOSQUITO
 (HARTMANN)
 06-0050
 - 06-0055

MICRO-HALSTED
 06-0090
 - 06-0095

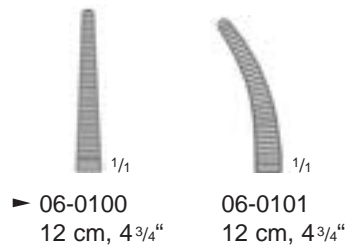

aus TITAN
 made of TITANIUM
 de TITANIO
 en TITANE
 in TITANIO

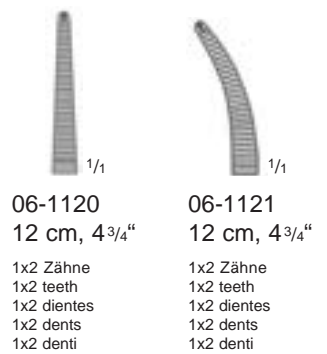
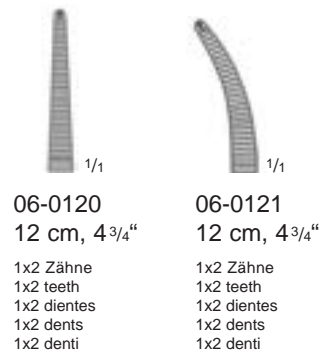
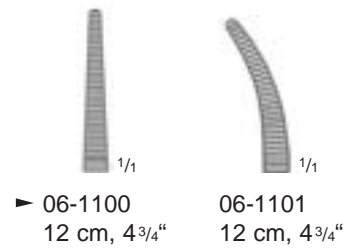

HALSTED-MOSQUITO
 06-0100
 - 06-0121

HALSTED-MOSQUITO
 06-1100
 - 06-1121

Feine Arterienklemmen
 Delicate Haemostatic Forceps
 Pinzas hemostáticas finas
 Pincas hémostatiques fines
 Pinze emostatiche fini



mit atraumatischer Riefung
 with non-traumatic serration
 con bocas atraumáticas
 avec mors atrauma
 con morsi atraumatici

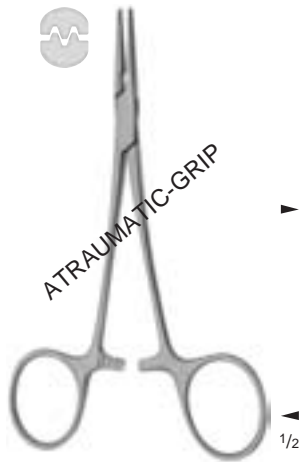

HALSTED-MOSQUITO-DE BAKEY
 06-0122
 - 06-0123

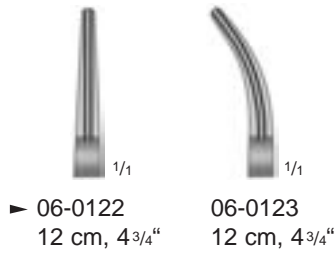

HALSTED-MOSQUITO
 06-0155
 - 06-0158

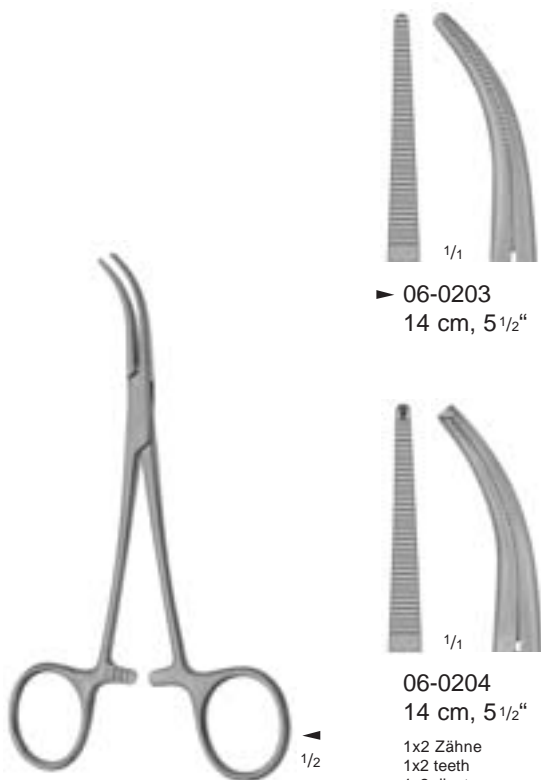
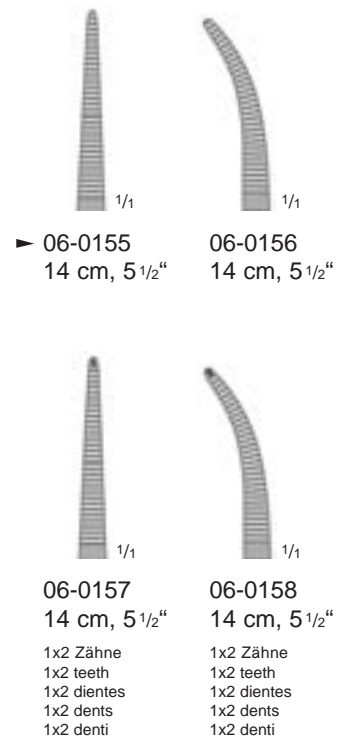

DANDY
 06-0203
 - 06-0204

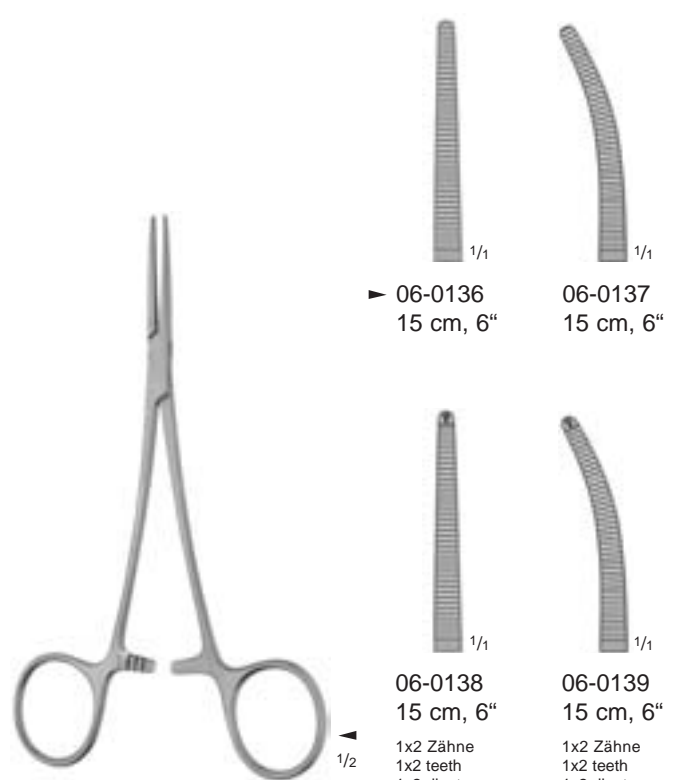

LERICHE
 06-0136
 - 06-0139

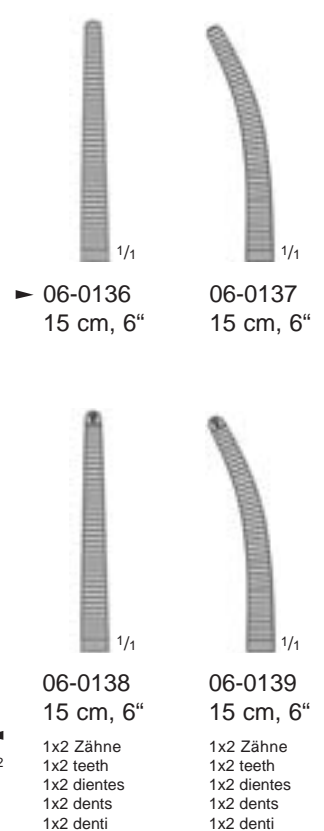



Feine Arterienklemmen
 Delicate Haemostatic Forceps
 Pinzas hemostáticas finas
 Pinces hémostatiques fines
 Pinze emostatiche fini

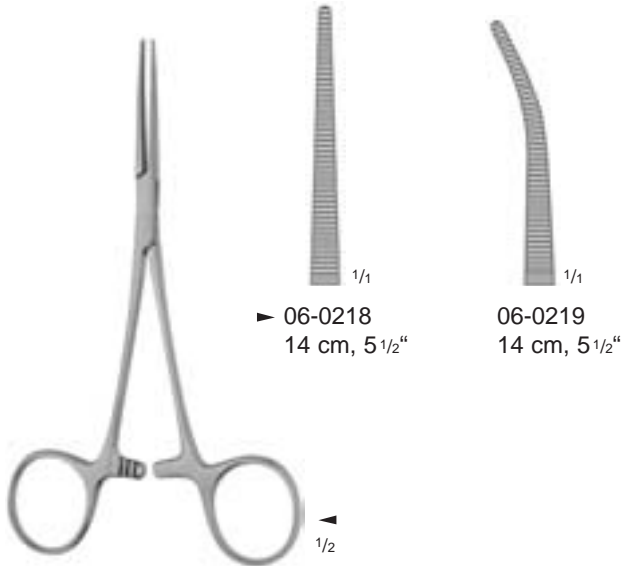

▶ 06-0218
14 cm, 5 1/2"

06-0219
14 cm, 5 1/2"

MICRO-CRILE
 06-0218
 - 06-0219

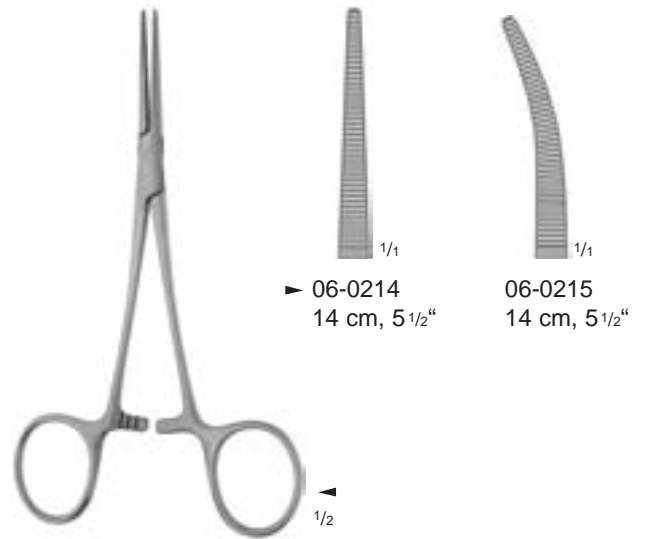

▶ 06-0214
14 cm, 5 1/2"

06-0215
14 cm, 5 1/2"

BABY-CRILE
 06-0214
 - 06-0215

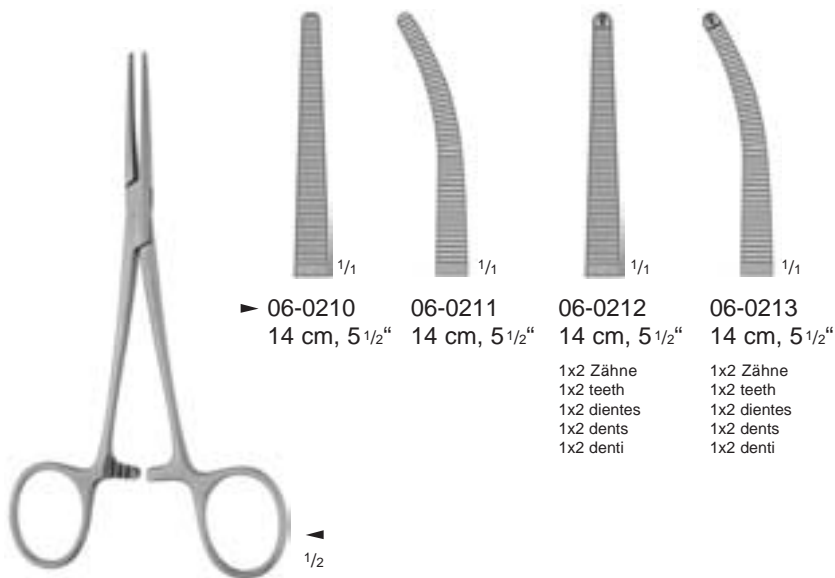

▶ 06-0210
14 cm, 5 1/2"

06-0211
14 cm, 5 1/2"

06-0212
14 cm, 5 1/2"

06-0213
14 cm, 5 1/2"

1x2 Zähne
 1x2 teeth
 1x2 dientes
 1x2 dents
 1x2 denti

1x2 Zähne
 1x2 teeth
 1x2 dientes
 1x2 dents
 1x2 denti

CRILE
 06-0210
 - 06-0213

aus TITAN
 made of TITANIUM
 de TITANIO
 en TITANE
 in TITANIO

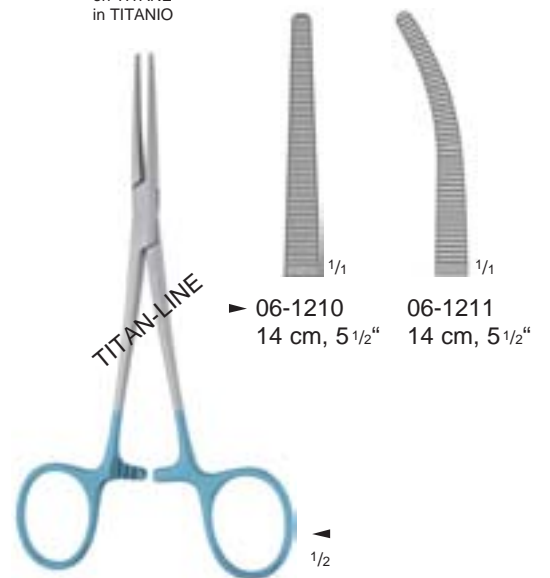

▶ 06-1210
14 cm, 5 1/2"

06-1211
14 cm, 5 1/2"

CRILE
 06-1210
 - 06-1211

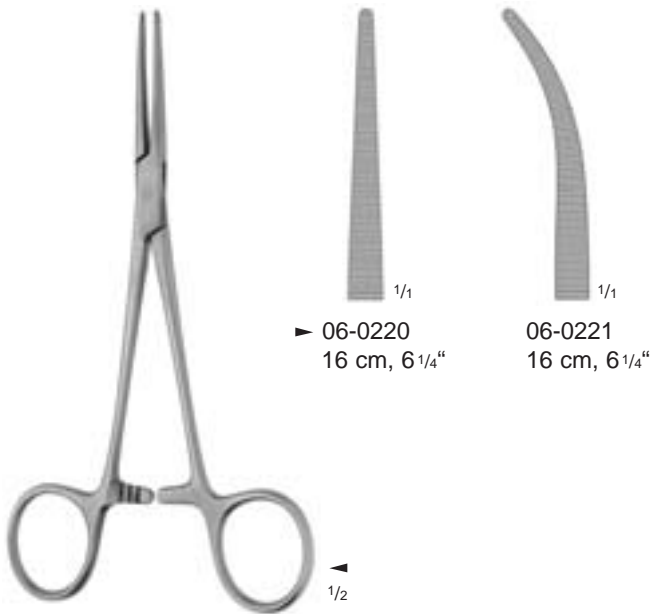

CRILE-RANKIN
 06-0220
 - 06-0221

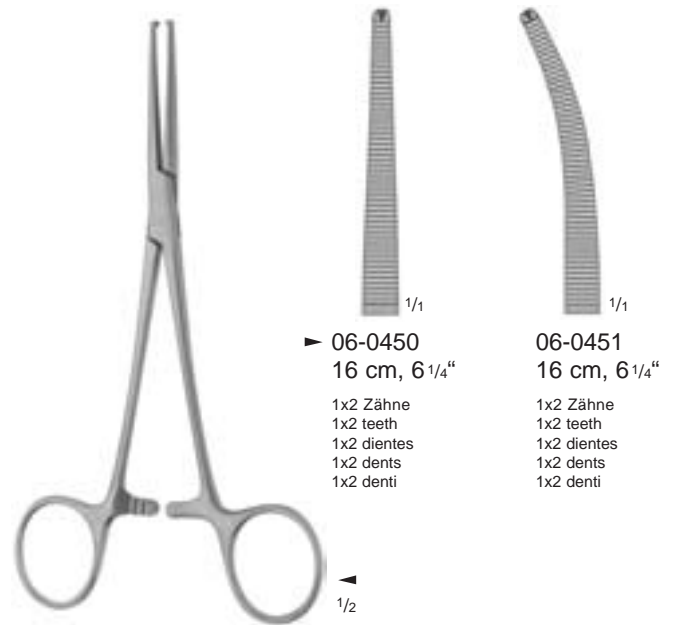

CRILE-RANKIN
 (OCHSNER-DIXON)
 06-0450
 - 06-0451

mit atraumatischer Riefung
 with non-traumatic serration
 con bocas atraumáticas
 avec mors atrauma
 con morsi atraumatici

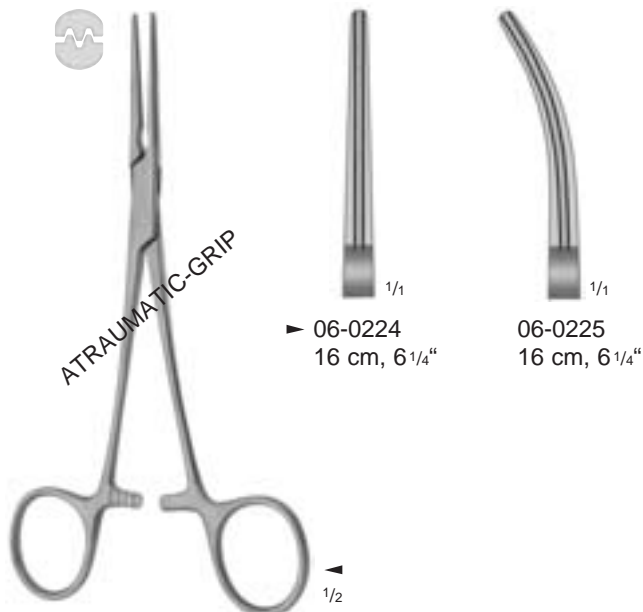

CRILE-RANKIN-DE BAKY
 06-0224
 - 06-0225

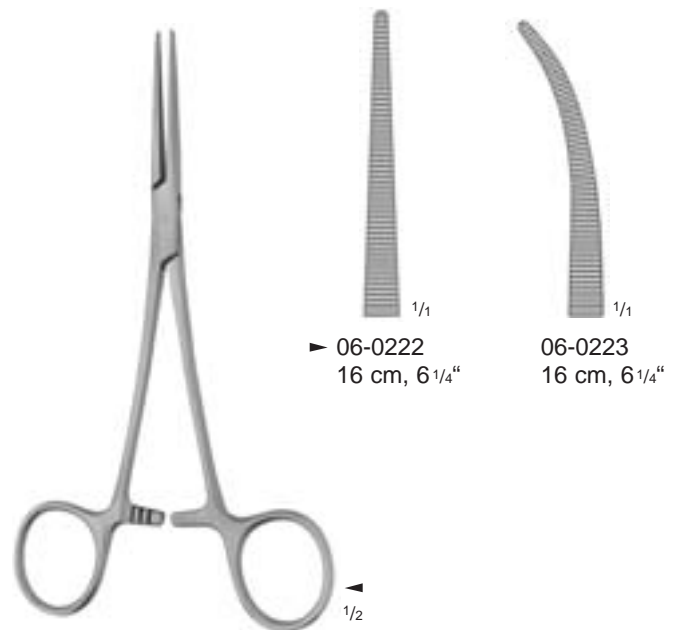

CRILE-COLLER
 06-0222
 - 06-0223



Feine Arterienklemmen
 Delicate Haemostatic Forceps
 Pinzas hemostáticas finas
 Pinces hémostatiques fines
 Pinze emostatiche fini

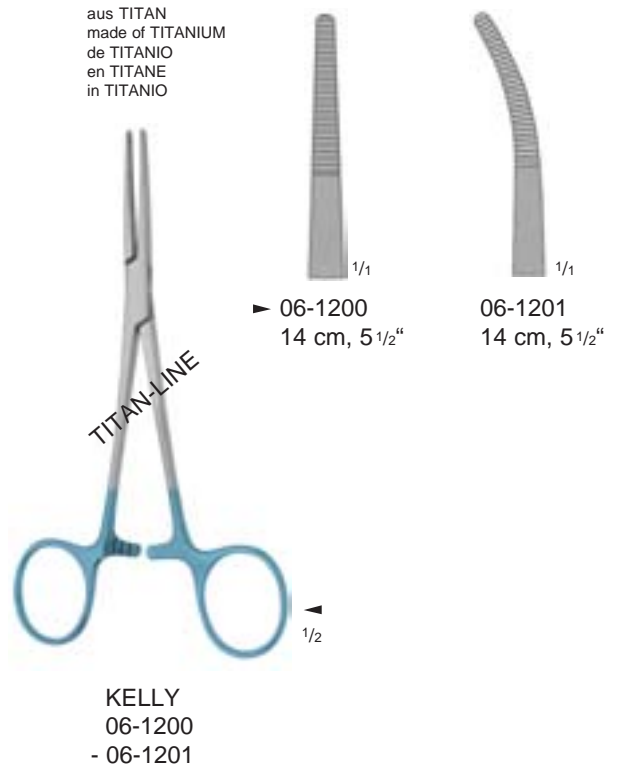
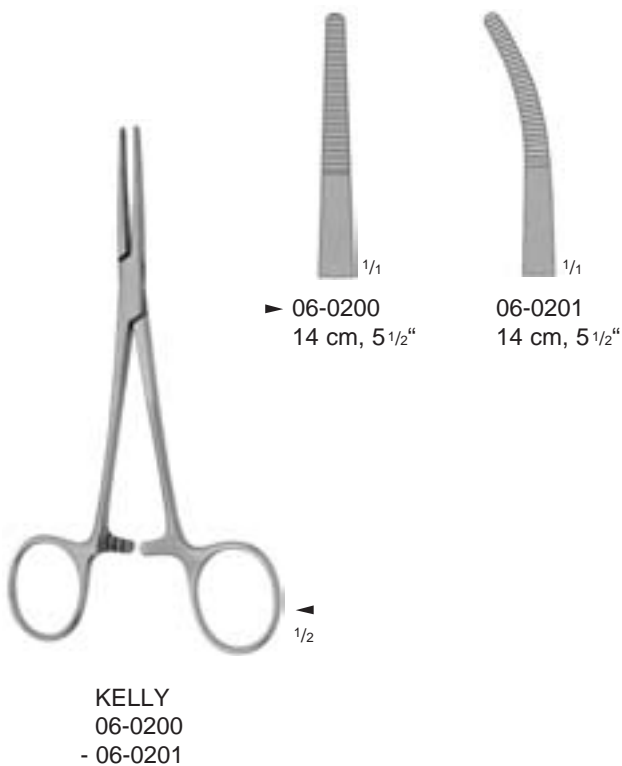
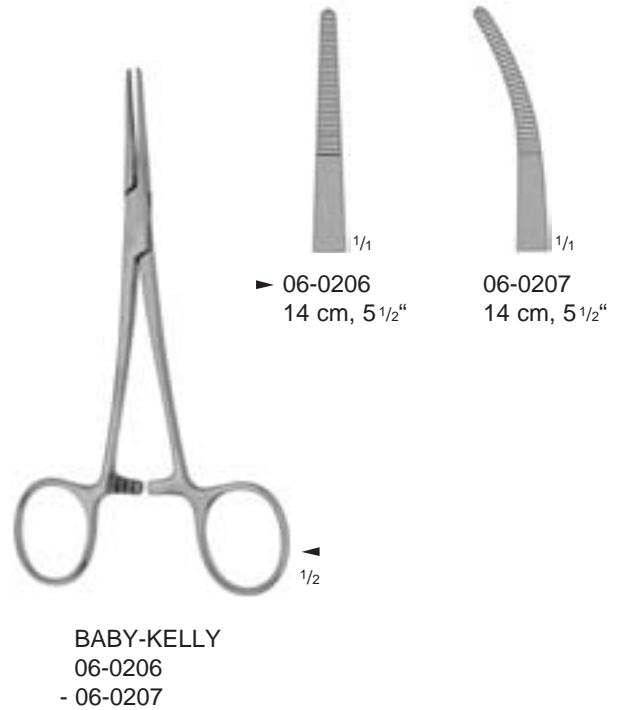
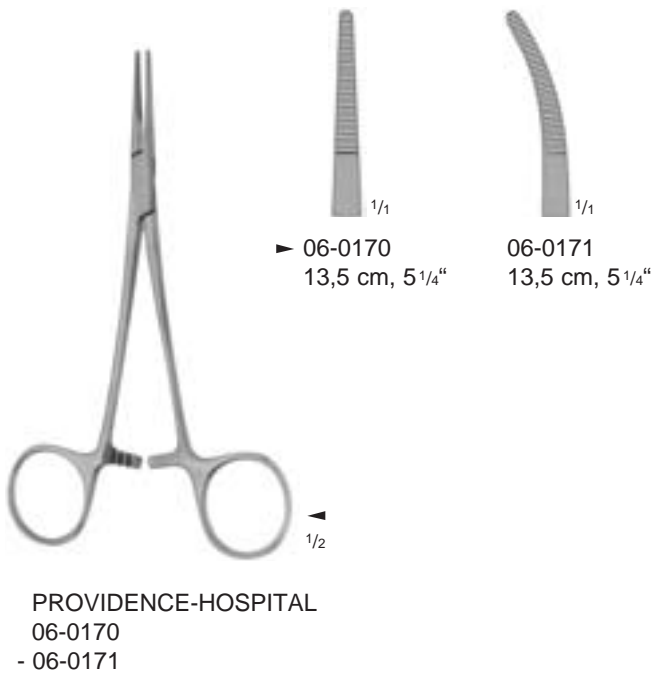

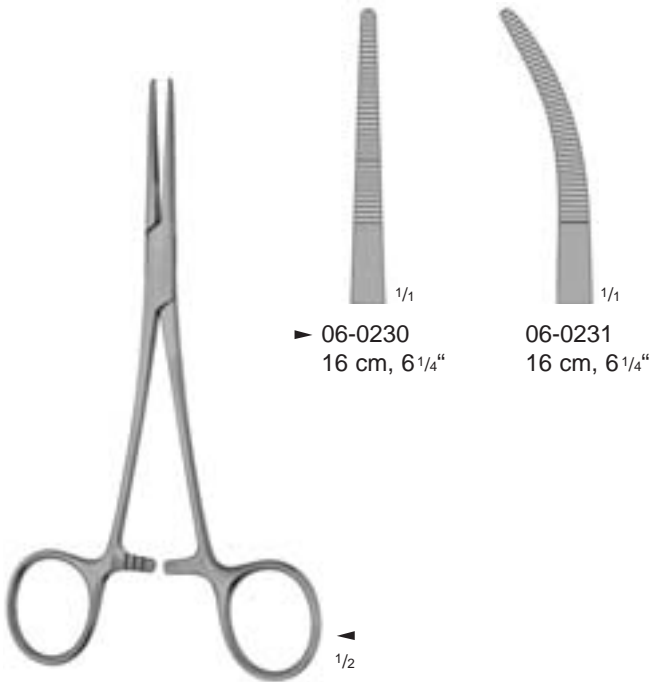

▶ 06-0230
 16 cm, 6 1/4"

06-0231
 16 cm, 6 1/4"

KELLY-RANKIN
 06-0230
 - 06-0231

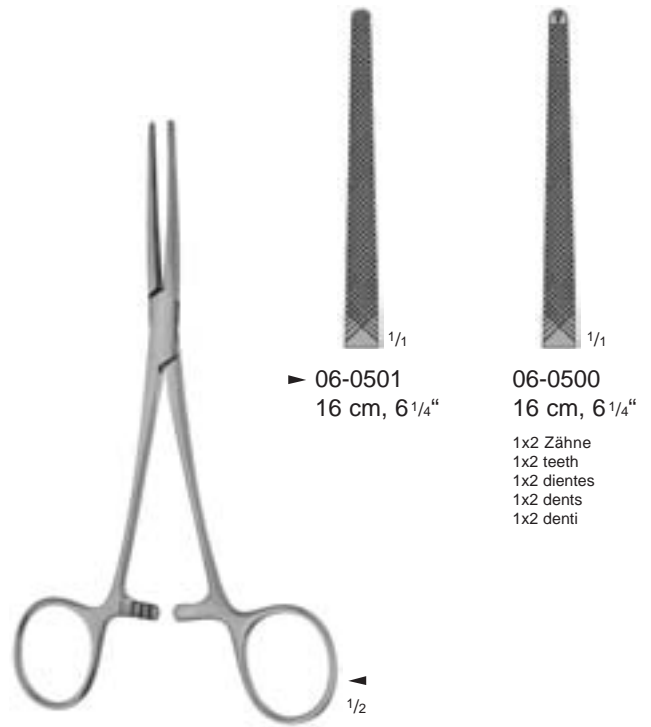

▶ 06-0501
 16 cm, 6 1/4"

06-0500
 16 cm, 6 1/4"

1x2 Zähne
 1x2 teeth
 1x2 dientes
 1x2 dents
 1x2 denti

DIXON-LOVELACE
 06-0500
 - 06-0501



▶ 06-0240
 18,5 cm, 7 1/4"

06-0241
 18,5 cm, 7 1/4"

06-0244
 18,5 cm, 7 1/4"

06-0245
 18,5 cm, 7 1/4"

1x2 Zähne
 1x2 teeth
 1x2 dientes
 1x2 dents
 1x2 denti

1x2 Zähne
 1x2 teeth
 1x2 dientes
 1x2 dents
 1x2 denti

HALSTED
 06-0240
 - 06-0245

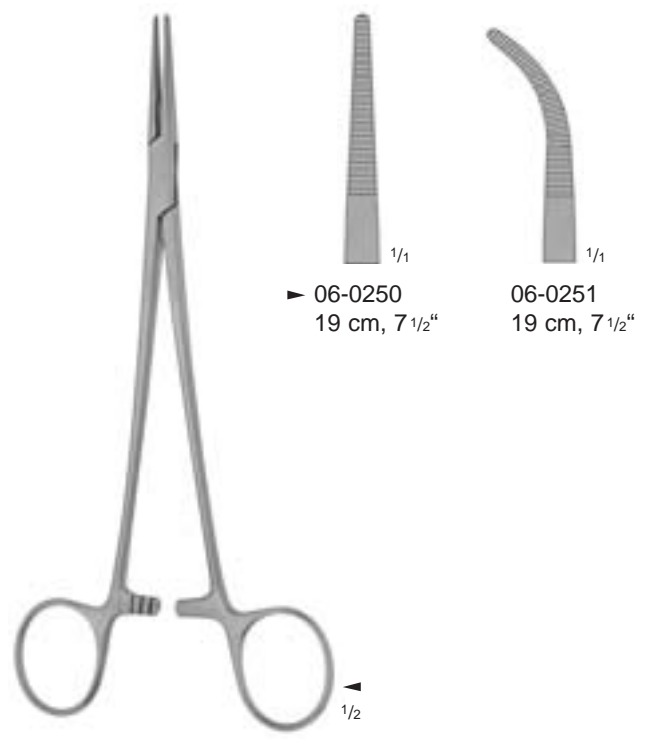

▶ 06-0250
 19 cm, 7 1/2"

06-0251
 19 cm, 7 1/2"

ADSON
 06-0250
 - 06-0251



Feine Arterienklemmen
 Delicate Haemostatic Forceps
 Pinzas hemostáticas finas
 Pinces hémostatiques fines
 Pinze emostatiche fini

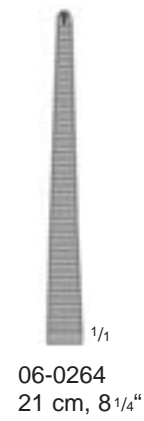
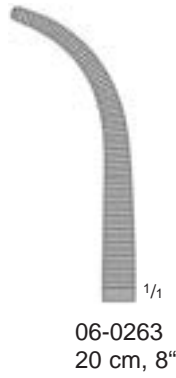

1x2 Zähne
 1x2 teeth
 1x2 dientes
 1x2 dents
 1x2 denti

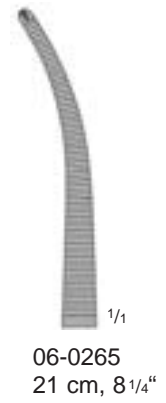

1x2 Zähne
 1x2 teeth
 1x2 dientes
 1x2 dents
 1x2 denti

HEISS (HALSTED-MOSQUITO)
 06-0260
 - 06-0265

1/2



VARCO
 06-0713
 18,5 cm, 7 1/4"



STILLE-CRAFOORD
 06-0276
 18,5 cm, 7 1/4"

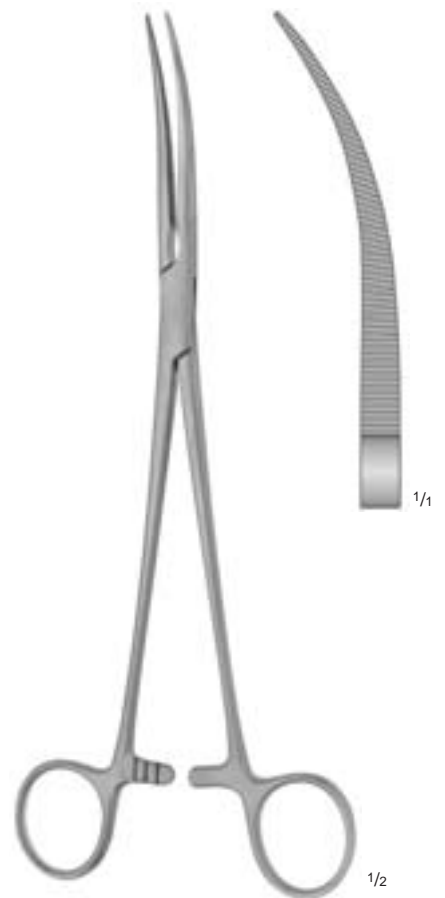

STILLE-CRAFOORD
 06-0277
 23,5 cm, 9 1/4"

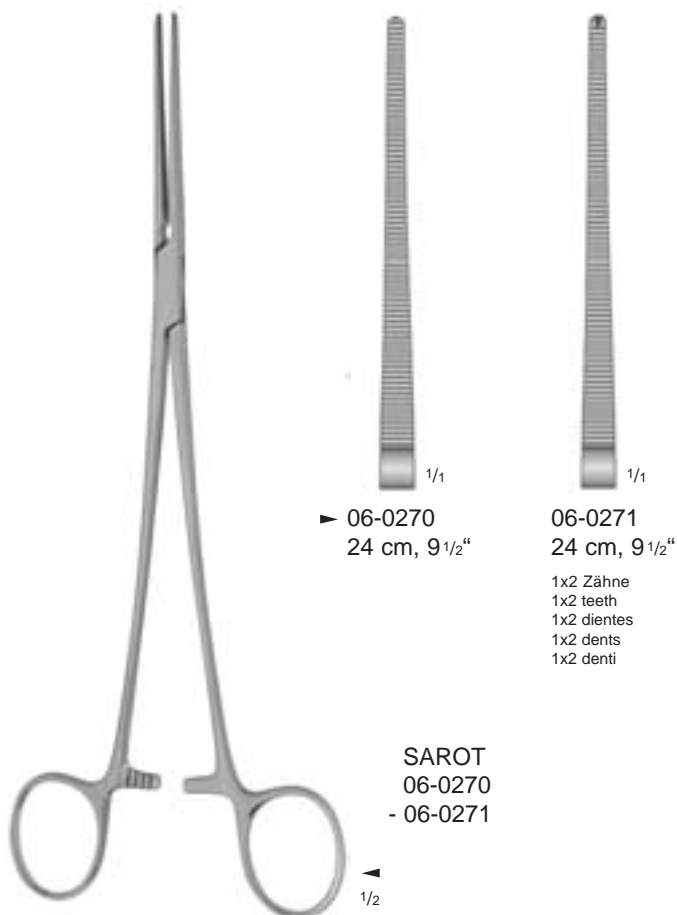
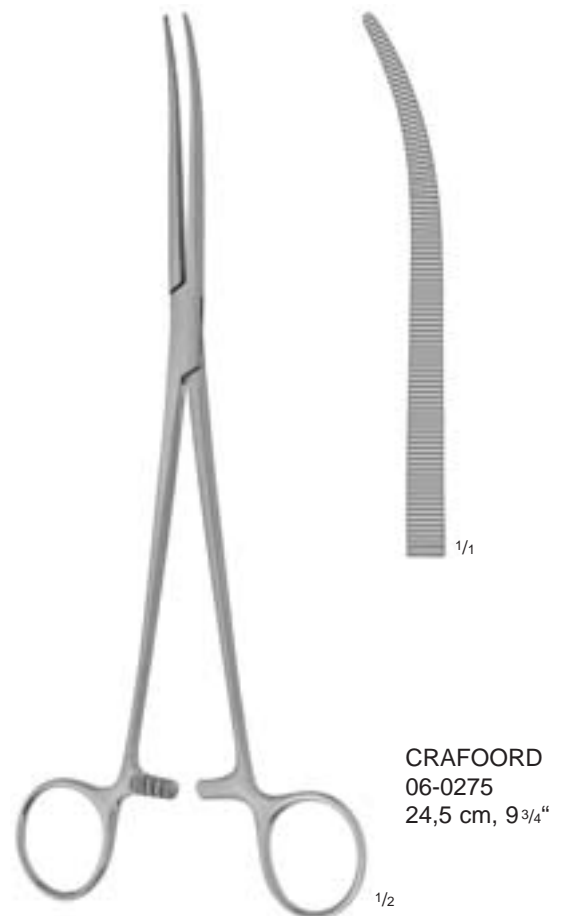
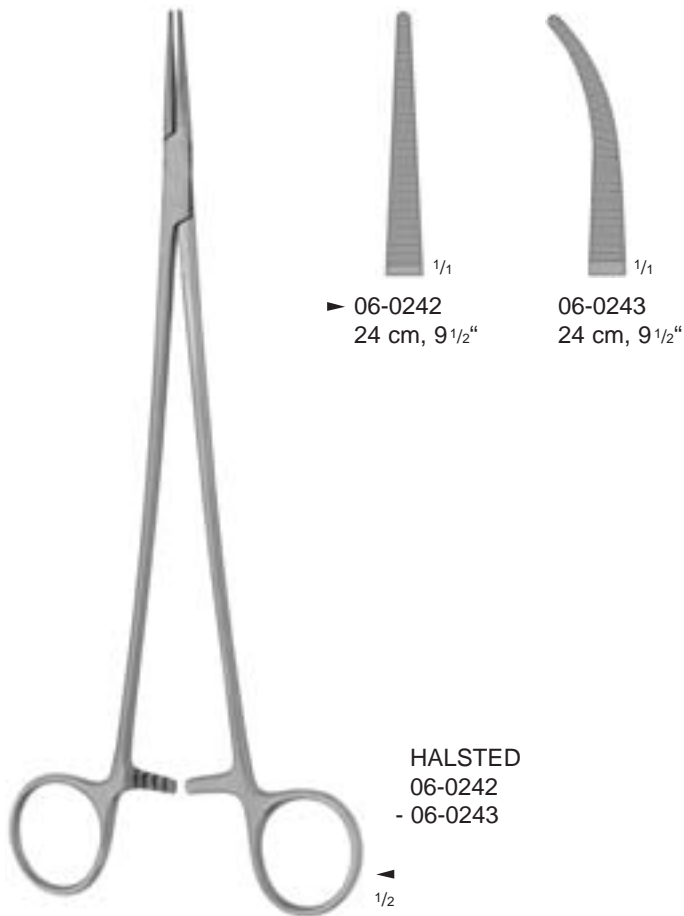



Feine Arterienklemmen
 Delicate Haemostatic Forceps
 Pinzas hemostáticas finas
 Pincès hémostatiques fines
 Pinze emostatiche fini



► 06-0280
 21,5 cm, 8 1/2"



06-0284
 25,5 cm, 10"



06-0281
 21,5 cm, 8 1/2"



06-0285
 25,5 cm, 10"



06-0282
 21,5 cm, 8 1/2"
 1x2 Zähne
 1x2 teeth
 1x2 dientes
 1x2 dents
 1x2 denti



06-0286
 25,5 cm, 10"
 1x2 Zähne
 1x2 teeth
 1x2 dientes
 1x2 dents
 1x2 denti



06-0283
 21,5 cm, 8 1/2"
 1x2 Zähne
 1x2 teeth
 1x2 dientes
 1x2 dents
 1x2 denti



06-0287
 25,5 cm, 10"
 1x2 Zähne
 1x2 teeth
 1x2 dientes
 1x2 dents
 1x2 denti



BENGOLEA
 06-0280
 - 06-0287



KROENLEIN
 06-0680
 12,5 cm, 5"



PEAN
 06-0682
 - 06-0685

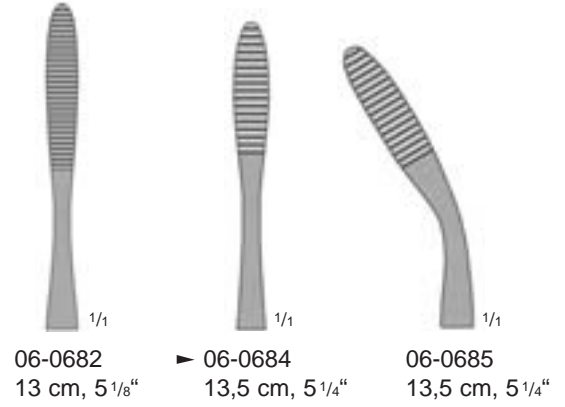

SPENCER-WELLS
 06-0342
 - 06-0354

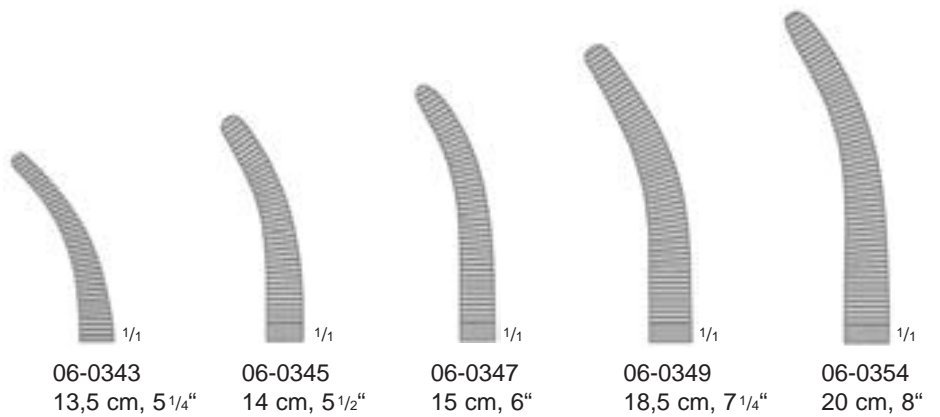
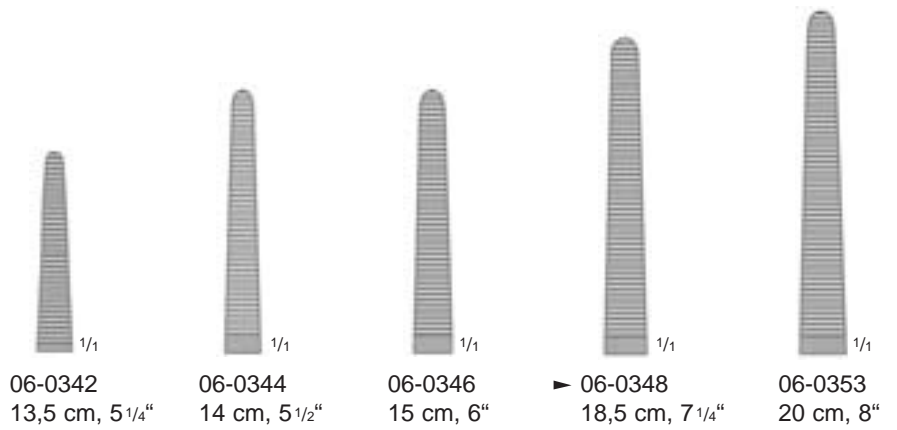



Arterienklemmen
 Haemostatic Forceps
 Pinzas hemostáticas
 Pinces hémostatiques
 Pinze emostatiche

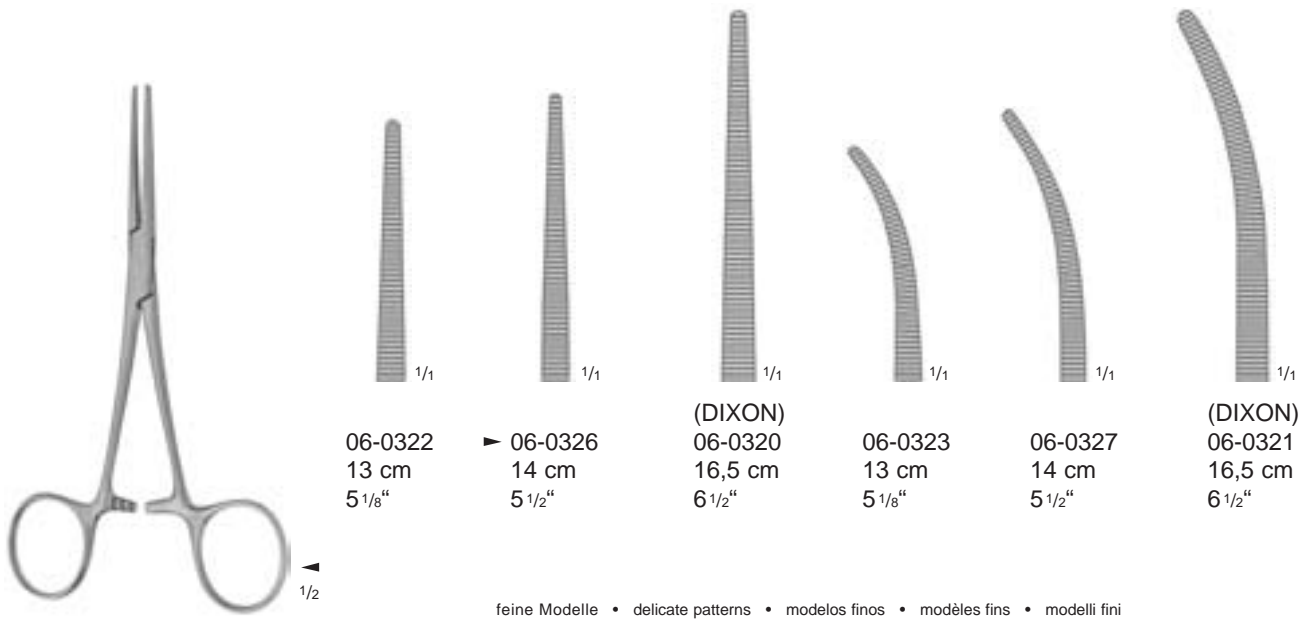

06-0322 13 cm 5 1/8"	▶ 06-0326 14 cm 5 1/2"	(DIXON) 06-0320 16,5 cm 6 1/2"	06-0323 13 cm 5 1/8"	06-0327 14 cm 5 1/2"	(DIXON) 06-0321 16,5 cm 6 1/2"
----------------------------	------------------------------	---	----------------------------	----------------------------	---

feine Modelle • delicate patterns • modelos finos • modèles fins • modelli fini

PEAN
 06-0320
 - 06-0327

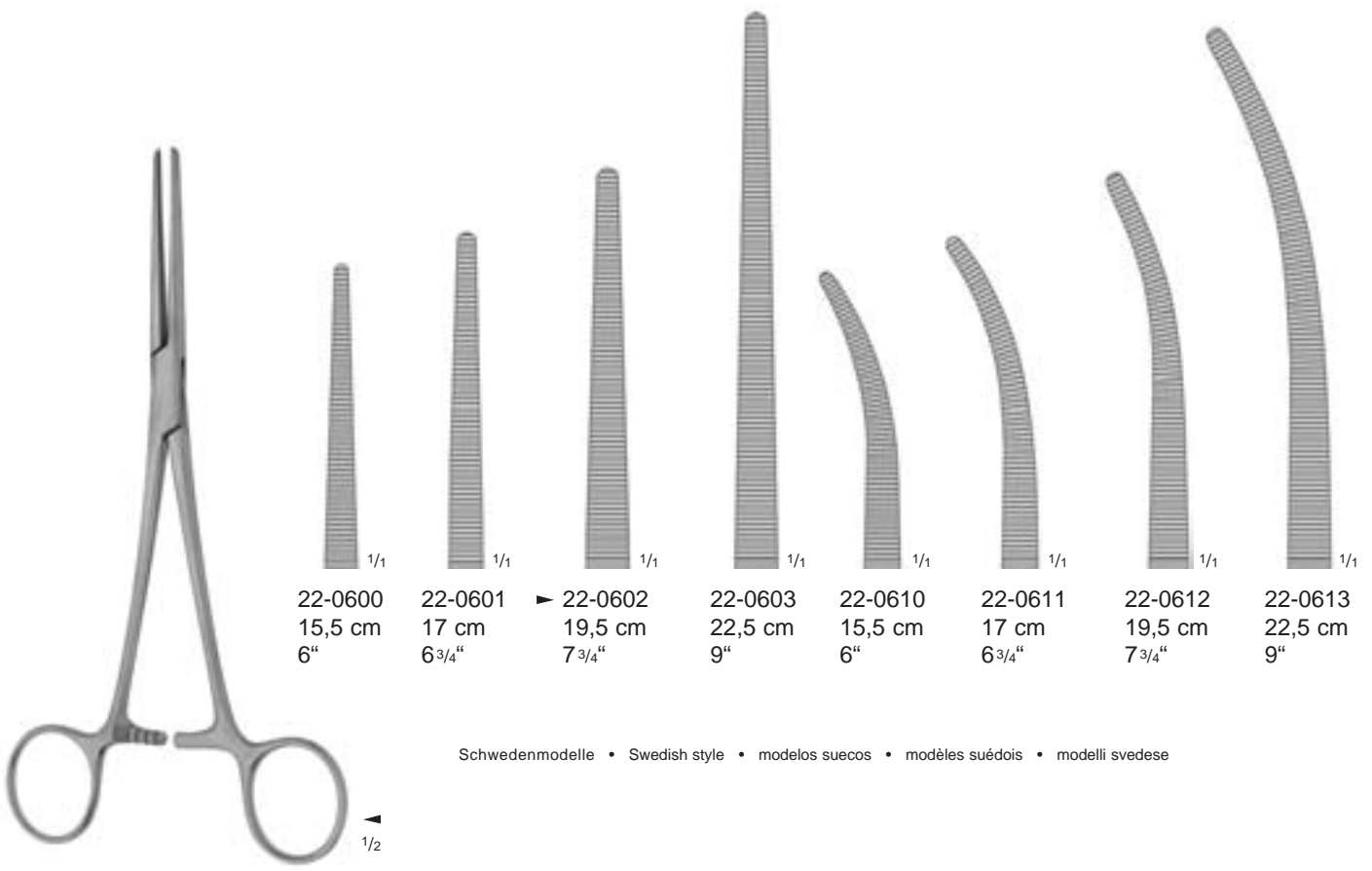

22-0600 15,5 cm 6"	22-0601 17 cm 6 3/4"	▶ 22-0602 19,5 cm 7 3/4"	22-0603 22,5 cm 9"	22-0610 15,5 cm 6"	22-0611 17 cm 6 3/4"	22-0612 19,5 cm 7 3/4"	22-0613 22,5 cm 9"
--------------------------	----------------------------	--------------------------------	--------------------------	--------------------------	----------------------------	------------------------------	--------------------------

Schwedenmodelle • Swedish style • modelos suecos • modèles suédois • modelli svedese

PEAN
 22-0600
 - 22-0613

Arterienklemmen

Haemostatic Forceps
Pinzas hemostáticas
Pincès hémostatiques
Pinze emostatiche

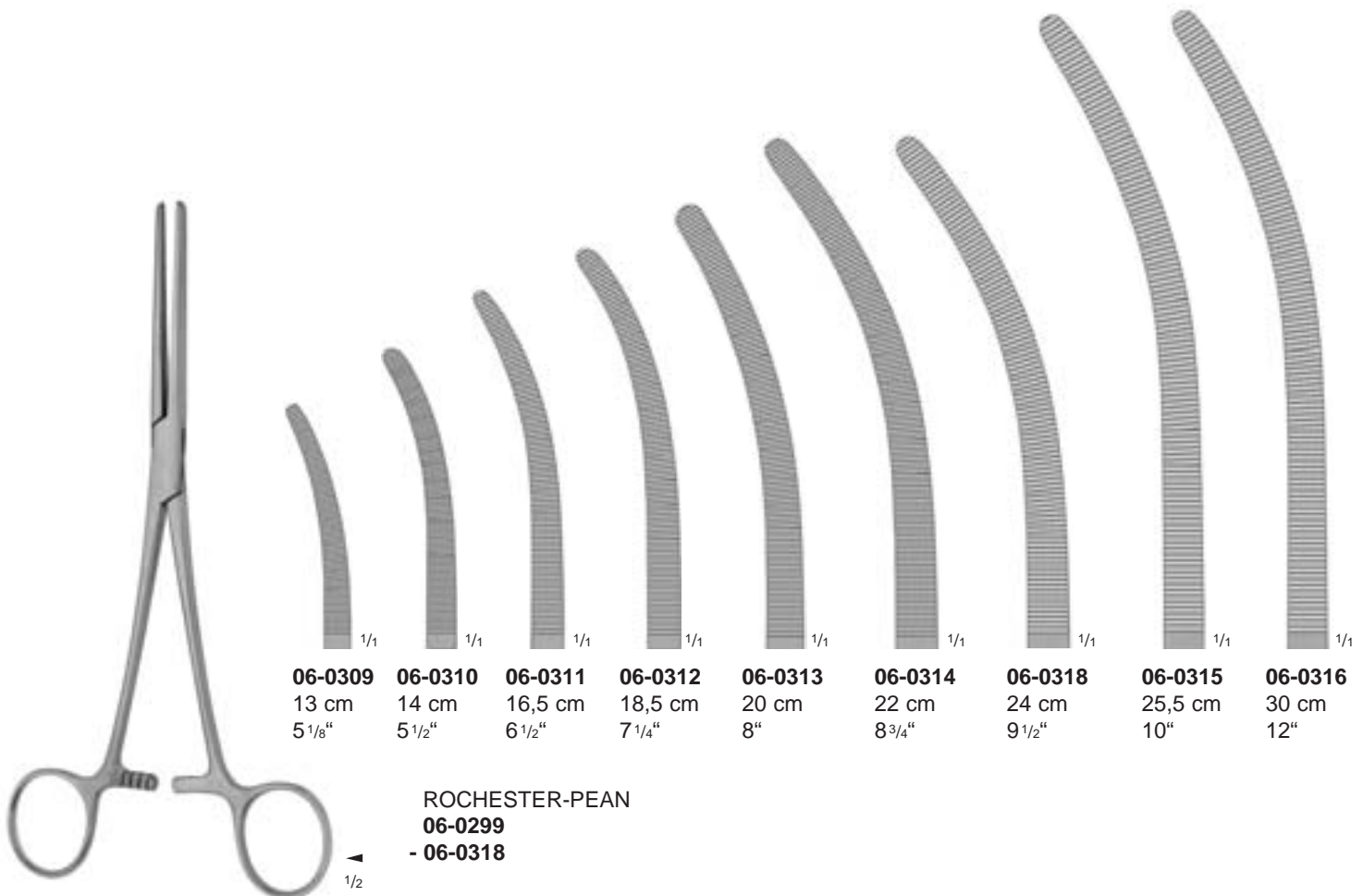
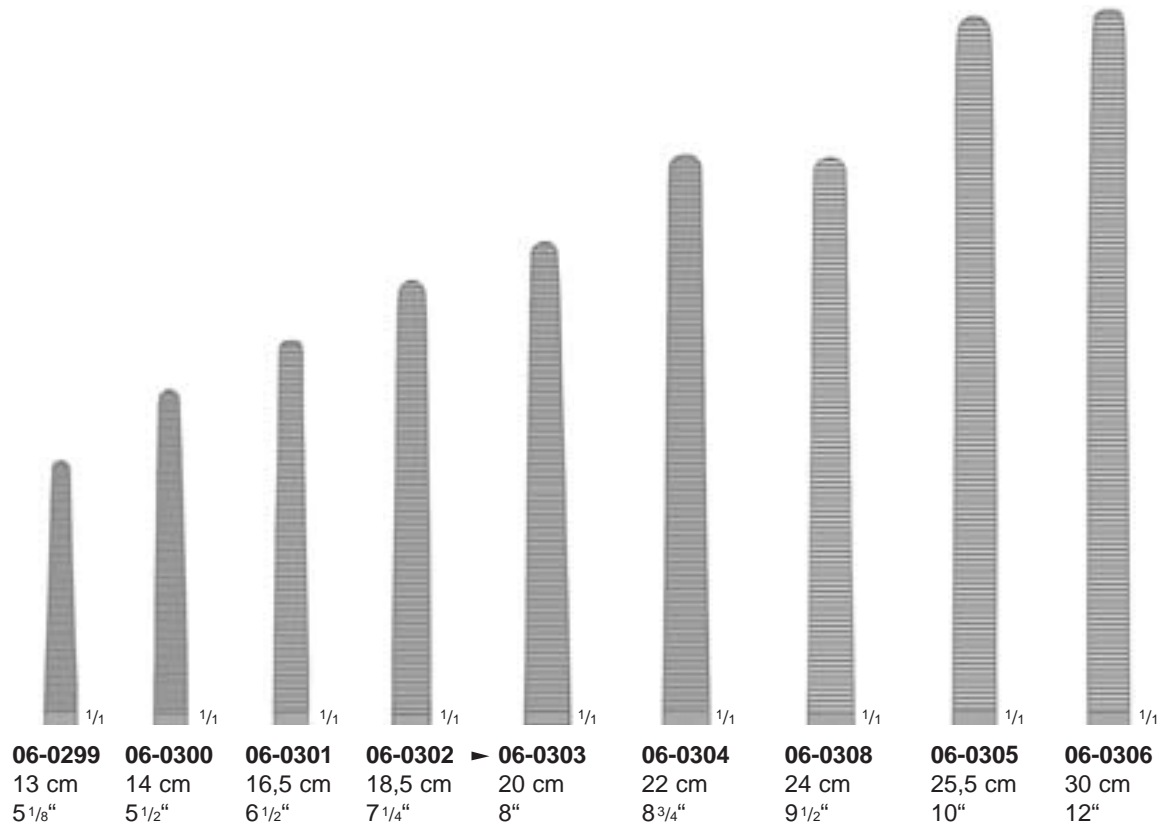









Arterienklemmen
 Haemostatic Forceps
 Pinzas hemostáticas
 Pinces hémostatiques
 Pinze emostatiche







mit atraumatischer Riefung
 with non-traumatic serration
 con bocas atraumáticas
 avec mors atrauma
 con morsi atraumatici



					
06-0420 14 cm 5 1/2"	06-0421 16,5 cm 6 1/2"	06-0422 18,5 cm 7 1/4"	06-0425 14 cm 5 1/2"	06-0426 16,5 cm 6 1/2"	06-0427 18,5 cm 7 1/4"



PEAN-DE BAKEY
06-0420
 - **06-0427**

			
06-0458 13 cm 5 1/8"	06-0216 14 cm 5 1/2"	06-0459 13 cm 5 1/8"	06-0217 14 cm 5 1/2"

feine Modelle, 1x2 Zähne
 delicate patterns, 1x2 teeth
 modelos finos, 1x2 dientes
 modèles fins, 1x2 dents
 modelli fini, 1x2 denti



KOCHER
06-0216
 - **06-0459**

	
06-0460 14 cm 5 1/2"	06-0461 14 cm 5 1/2"

1x2 Zähne
 1x2 teeth
 1x2 dientes
 1x2 dents
 1x2 denti



KOCHER
06-0460
 - **06-0461**

Arterienklemmen

Haemostatic Forceps
Pinzas hemostáticas
Pincas hémostatiques
Pinze emostatiche

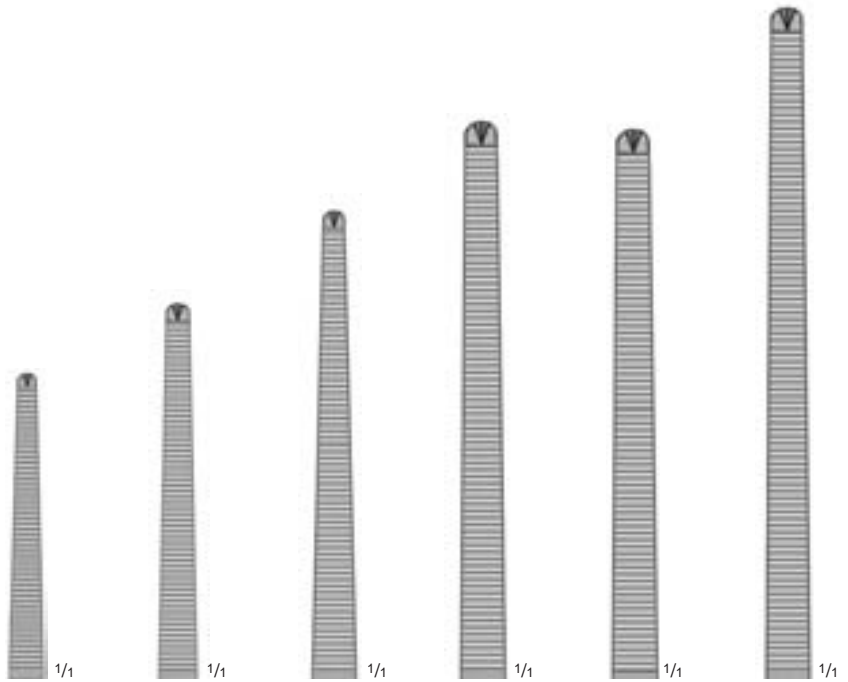

06-0400
16 cm
6 1/4"

06-0401
18,5 cm
7 1/4"

▶ **06-0402**
20 cm
8"

06-0403
22 cm
8 3/4"

06-0406
24 cm
9 1/2"

06-0404
26 cm
10 1/4"

1x2 Zähne • 1x2 teeth • 1x2 dientes • 1x2 dents • 1x2 denti



KOCHER-OCHSNER
06-0400
- **06-0416**

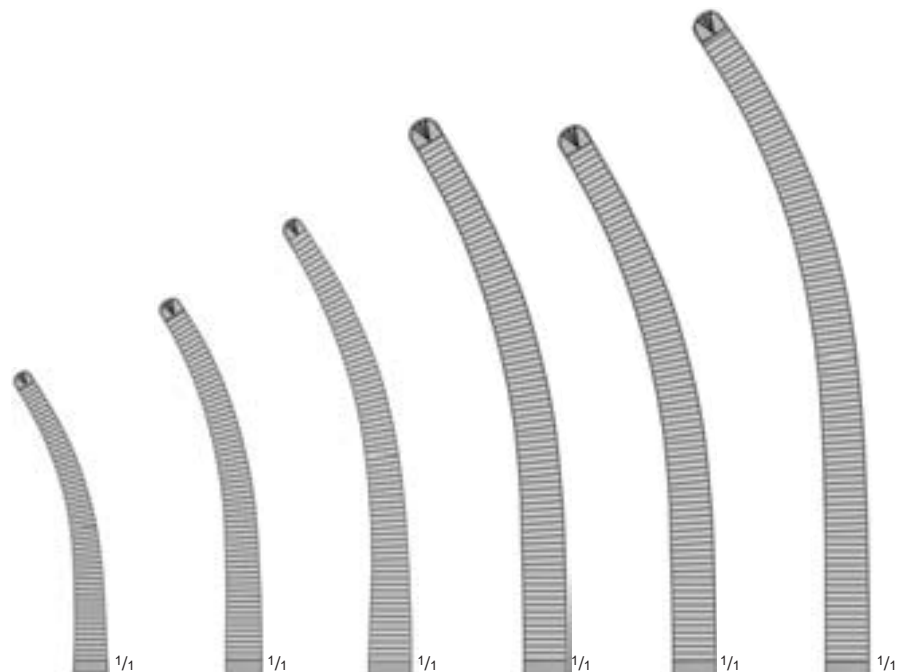

06-0410
16 cm
6 1/4"

06-0411
18,5 cm
7 1/4"

06-0412
20 cm
8"

06-0413
22 cm
8 3/4"

06-0416
24 cm
9 1/2"

06-0414
26 cm
10 1/4"

1x2 Zähne • 1x2 teeth • 1x2 dientes • 1x2 dents • 1x2 denti



Arterienklemmen
 Haemostatic Forceps
 Pinzas hemostáticas
 Pinces hémostatiques
 Pinze emostatiche

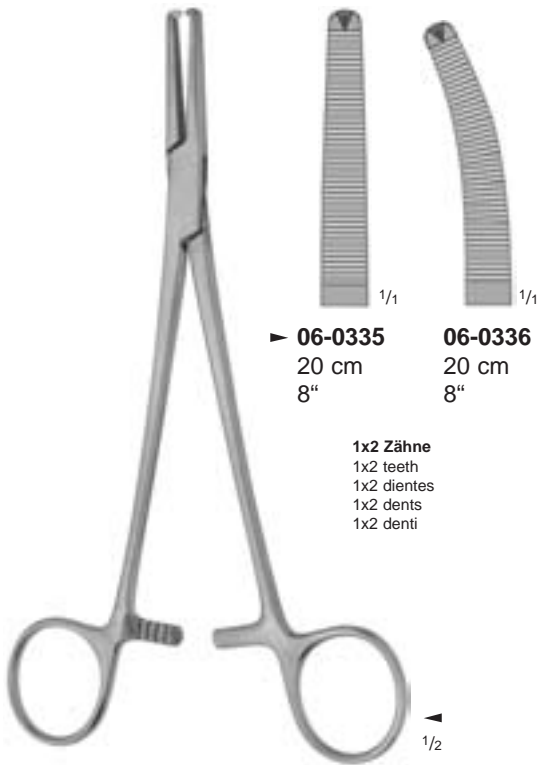

► **06-0335** 20 cm 8"
06-0336 20 cm 8"

1x2 Zähne
 1x2 teeth
 1x2 dientes
 1x2 dents
 1x2 denti

ROCHESTER-OCHSNER
06-0335
 - **06-0336**

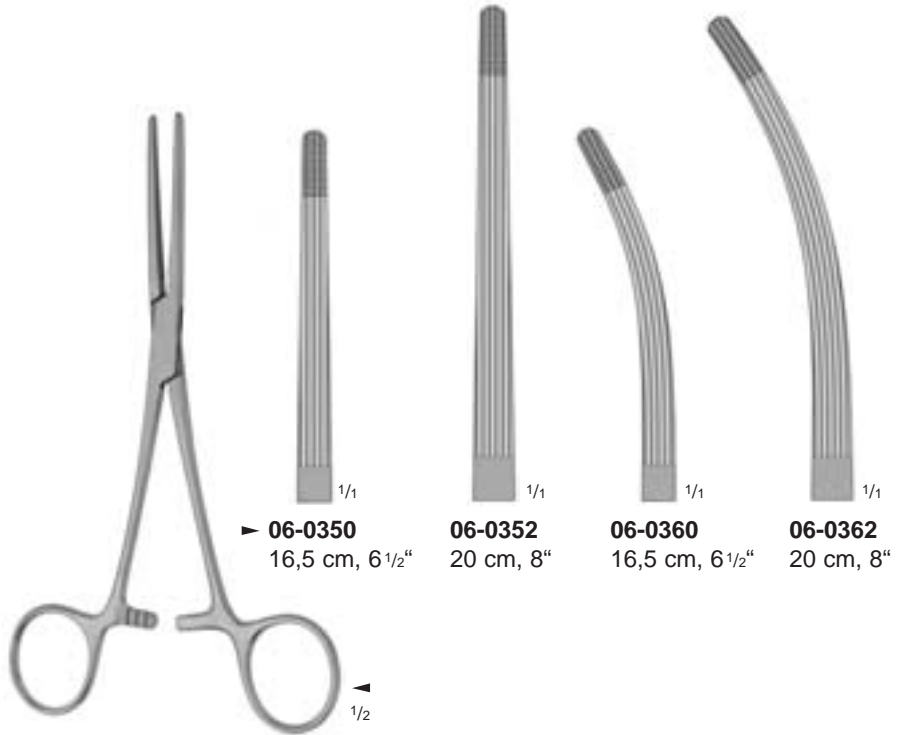

► **06-0350** 16,5 cm, 6 1/2"
06-0352 20 cm, 8"
06-0360 16,5 cm, 6 1/2"
06-0362 20 cm, 8"

ROCHESTER-CARMALT
06-0350
 - **06-0362**

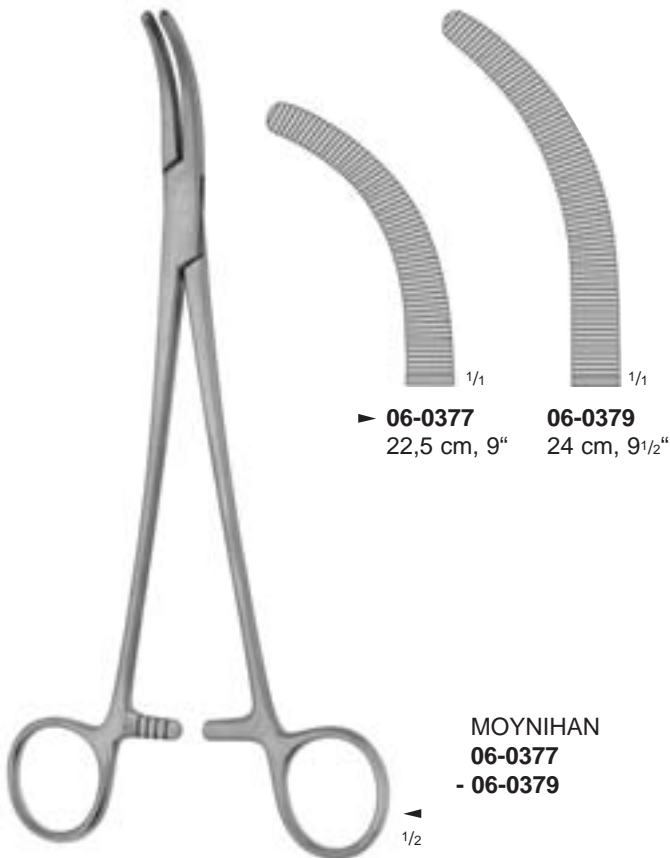

► **06-0377** 22,5 cm, 9"
06-0379 24 cm, 9 1/2"

MOYNIHAN
06-0377
 - **06-0379**

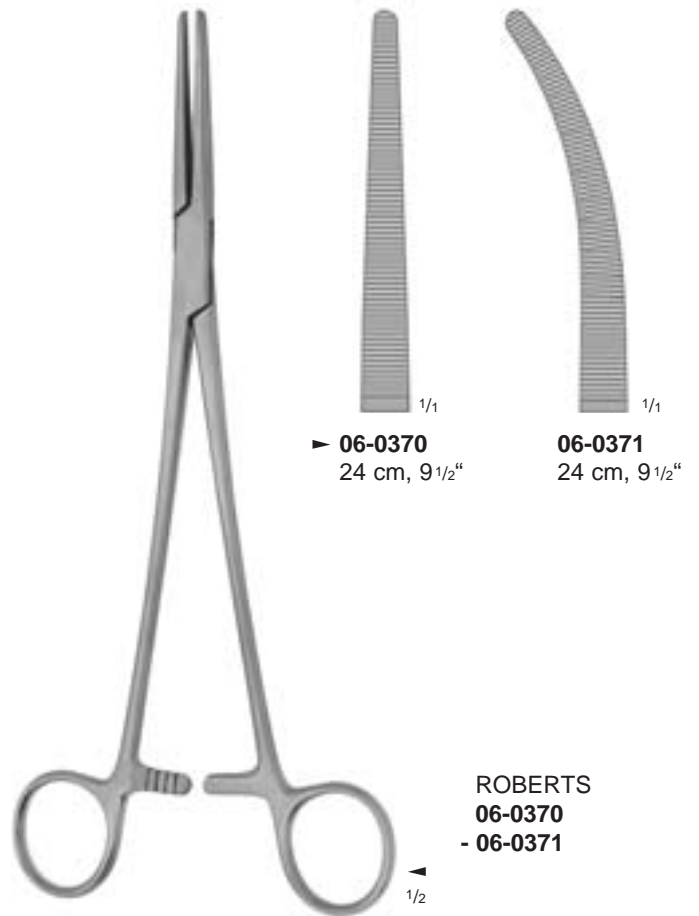

► **06-0370** 24 cm, 9 1/2"
06-0371 24 cm, 9 1/2"

ROBERTS
06-0370
 - **06-0371**

Arterien- und Tonsillenklammen

Haemostatic and Tonsil Forceps

Pinzas hemostáticas y para amígdalas

Pinces hémostatiques et pour amygdales

Pinze emostatiche e per tonsille

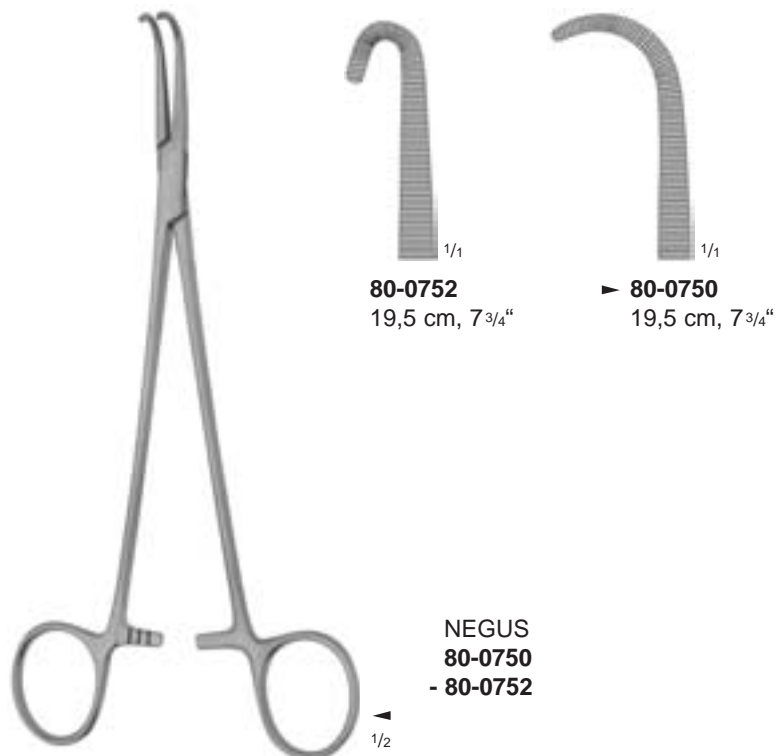
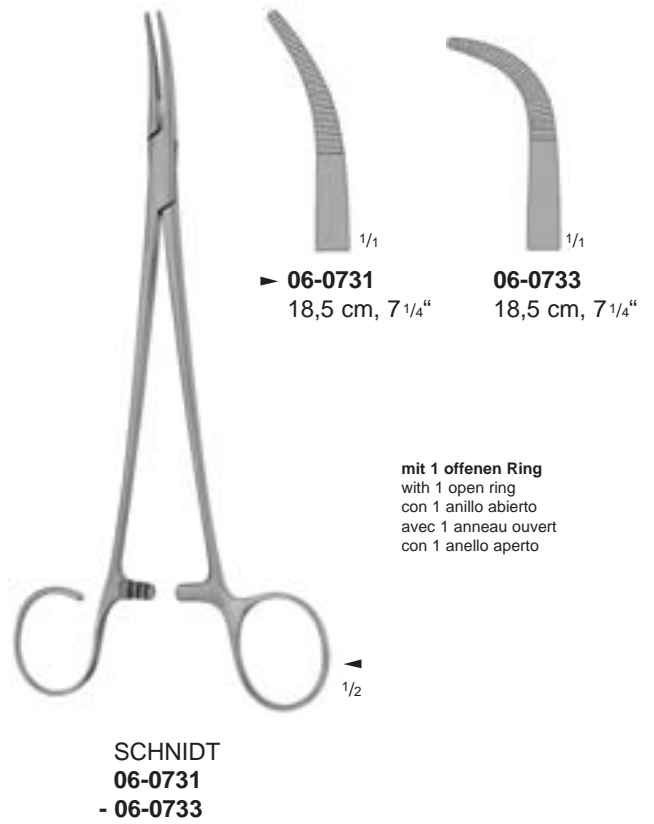
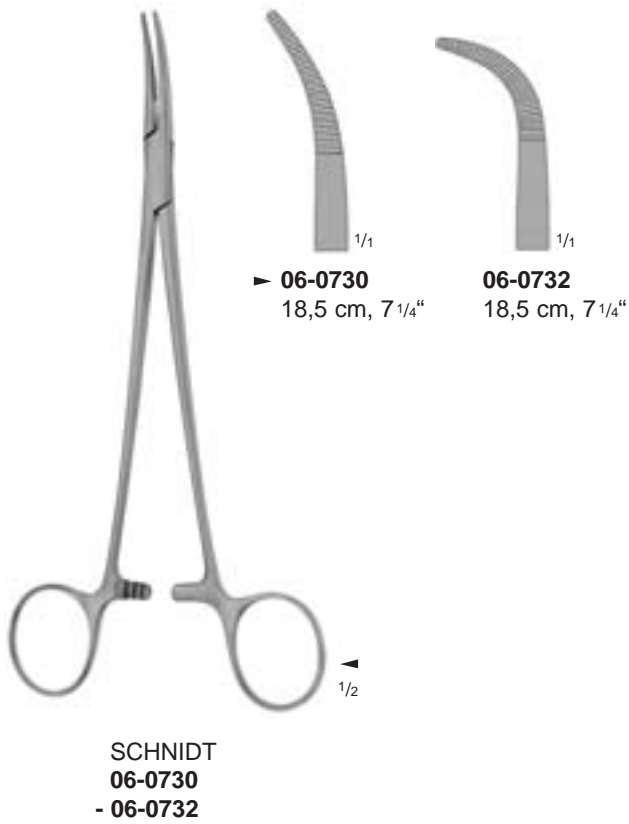



Präparier- und Ligaturklemmen

Dissecting and Ligature Forceps

Pinzas de disección y ligaduras

Pinces à disséquer et à ligatures

Pinze per preparazioni e legature



BABY-ADSON
06-0700
13 cm, 5 1/8"

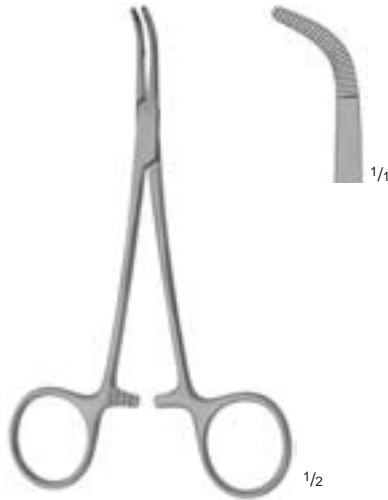

BABY-MIXTER
06-0706
13 cm, 5 1/8"

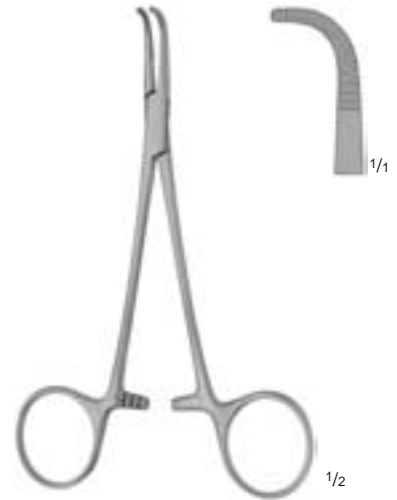

BABY-MEEKER
06-0701
13 cm, 5 1/8"



BABY-ADSON
06-0707
18 cm, 7"



BABY-MIXTER
06-0702
18 cm, 7"



BABY-MEEKER
06-0703
18 cm, 7"

Präparier- und Ligaturklemmen

Dissecting and Ligature Forceps

Pinzas de disección y ligaduras

Pinces à disséquer et à ligatures

Pinze per preparazioni e legature



GEMINI
06-0763
- 06-0766



► 06-0763
18,5 cm, 7 1/4"

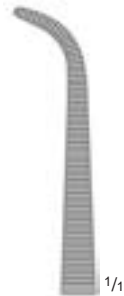

06-0764
22,5 cm, 9"



06-0765
24,5 cm, 9 3/4"

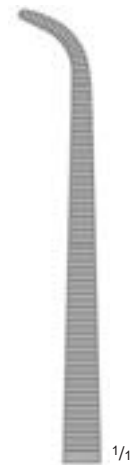

06-0766
28,5 cm, 11 1/4"



GEMINI-MIXTER
06-0767
- 06-0773



06-0767
14 cm, 5 1/2"



06-0768
16 cm, 6 1/4"



► 06-0769
18,5 cm, 7 1/4"

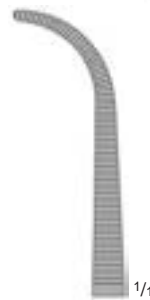

06-0770
20,5 cm, 8"



06-0771
23 cm, 9"

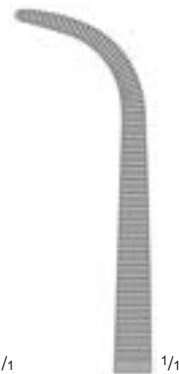

06-0772
25 cm, 10"

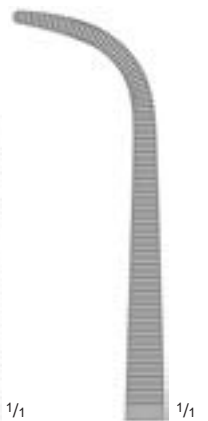

06-0773
28 cm, 11"



Präparier- und Ligaturklemmen

Dissecting and Ligature Forceps

Pinzas de disección y ligaduras

Pinces à disséquer et à ligatures

Pinze per preparazioni e legature

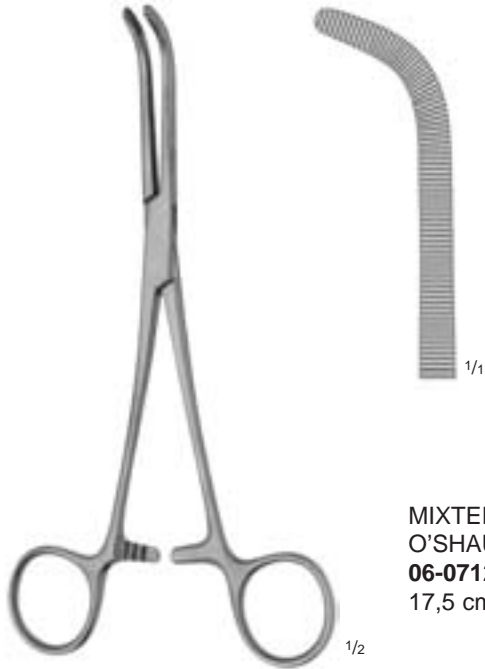

MIXTER-
O'SHAUGHNESSY
06-0712
17,5 cm, 7"

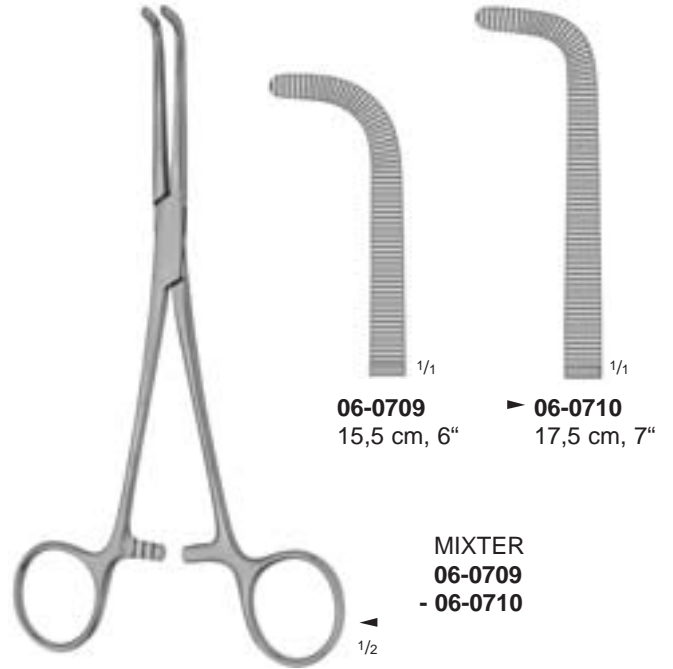

06-0709
15,5 cm, 6"

▶ **06-0710**
17,5 cm, 7"

MIXTER
06-0709
- **06-0710**



MIXTER-PAUL
(HEISS)
06-0711
20 cm, 8"

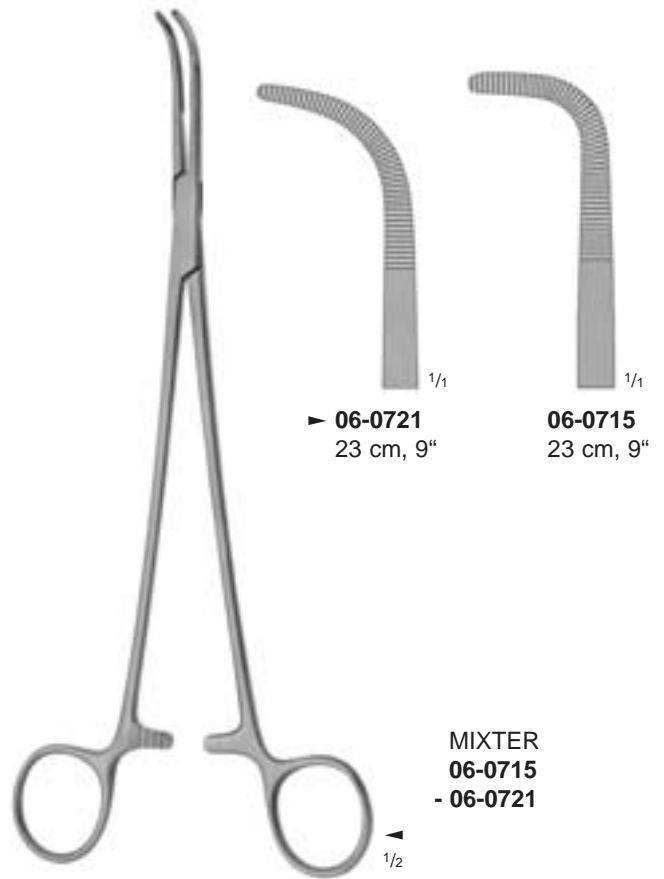

▶ **06-0721**
23 cm, 9"

06-0715
23 cm, 9"

MIXTER
06-0715
- **06-0721**

Präparier- und Ligaturklemmen

Dissecting and Ligature Forceps

Pinzas de disección y ligaduras

Pinces à disséquer et à ligatures

Pinze per preparazioni e legature



BABY-OVERHOLT
06-0705
13,5 cm, 5 1/4"

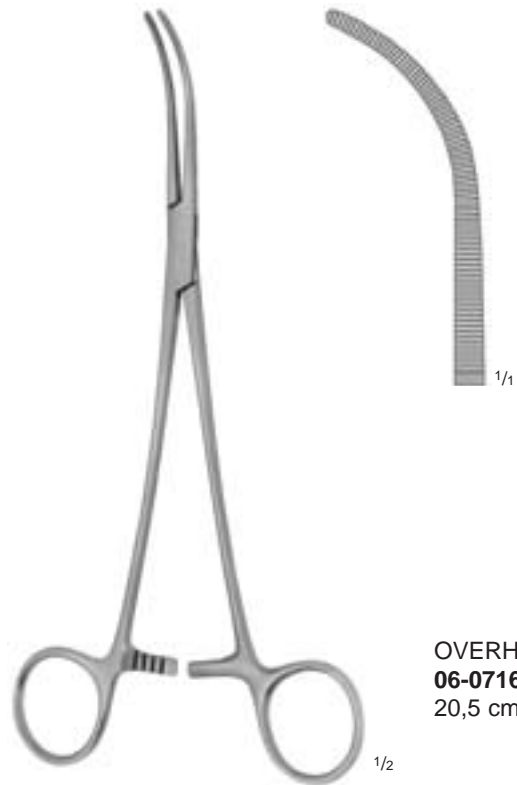

OVERHOLT-MIXTER
06-0716
20,5 cm, 8"

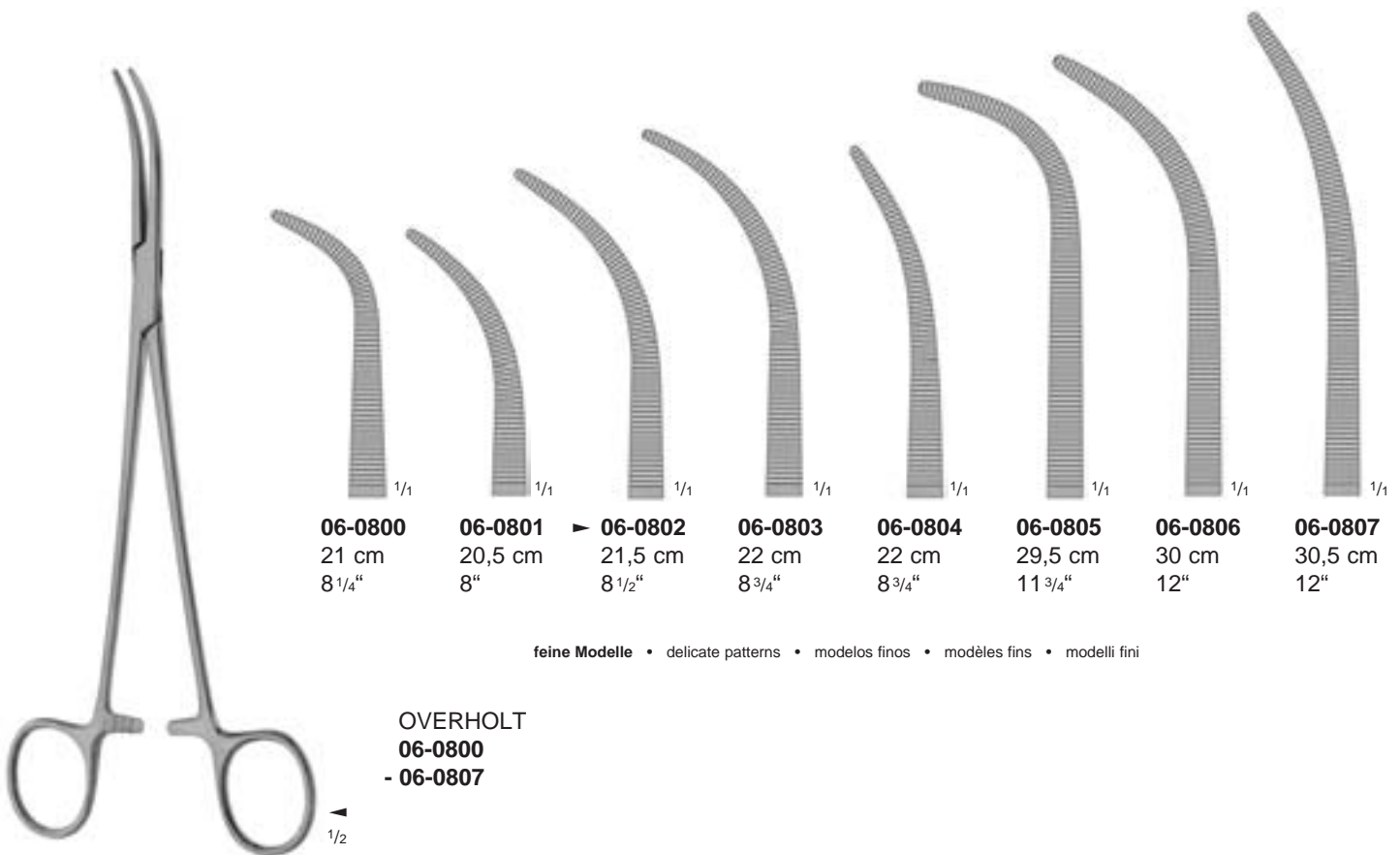

06-0800
21 cm
8 1/4"

06-0801
20,5 cm
8"

06-0802
21,5 cm
8 1/2"

06-0803
22 cm
8 3/4"

06-0804
22 cm
8 3/4"

06-0805
29,5 cm
11 3/4"

06-0806
30 cm
12"

06-0807
30,5 cm
12"

feine Modelle • delicate patterns • modelos finos • modèles fins • modelli fini

OVERHOLT
06-0800
- 06-0807



Präparier- und Ligaturklemmen

Dissecting and Ligature Forceps

Pinzas de disección y ligaduras

Pinces à disséquer et à ligatures

Pinze per preparazioni e legature



1/1	1/1	1/1	1/1	1/1	1/1	1/1
► 06-0740 19,5 cm 7 3/4"	06-0741 19 cm 7 1/2"	06-0742 21 cm 8 1/4"	06-0743 22 cm 8 3/4"	06-0744 21,5 cm 8 1/2"	06-0745 22 cm 8 3/4"	06-0746 22 cm 8 3/4"

OVERHOLT-GEISSENDOERFER
06-0740
 - **06-0746**

1/2

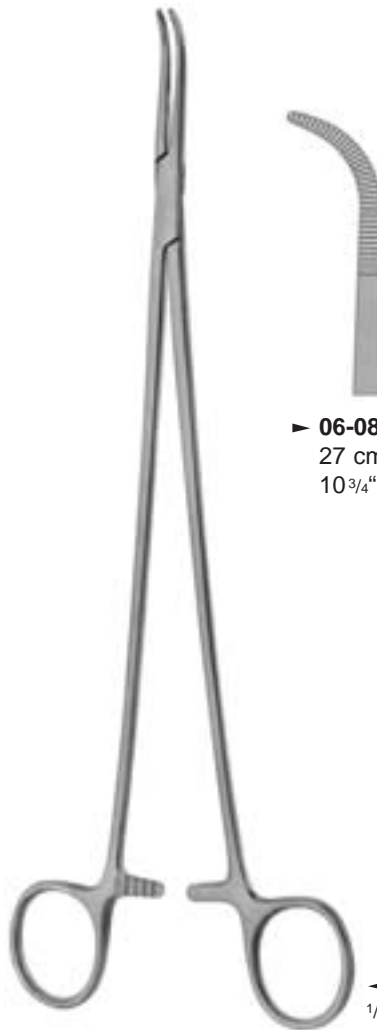

1/1	1/1	1/1	1/1	1/1	1/1	1/1
► 06-0820 27 cm 10 3/4"	06-0821 26 cm 10 1/4"	06-0822 27 cm 10 3/4"	06-0823 27,5 cm 10 3/4"	06-0824 27 cm 10 3/4"	06-0825 28 cm 11"	06-0826 28 cm 11"

OVERHOLT-GEISSENDOERFER
06-0820
 - **06-0826**

1/2

Präparier- und Ligaturklemmen

Dissecting and Ligature Forceps

Pinzas de disección y ligaduras

Pinces à disséquer et à ligatures

Pinze per preparazioni e legature

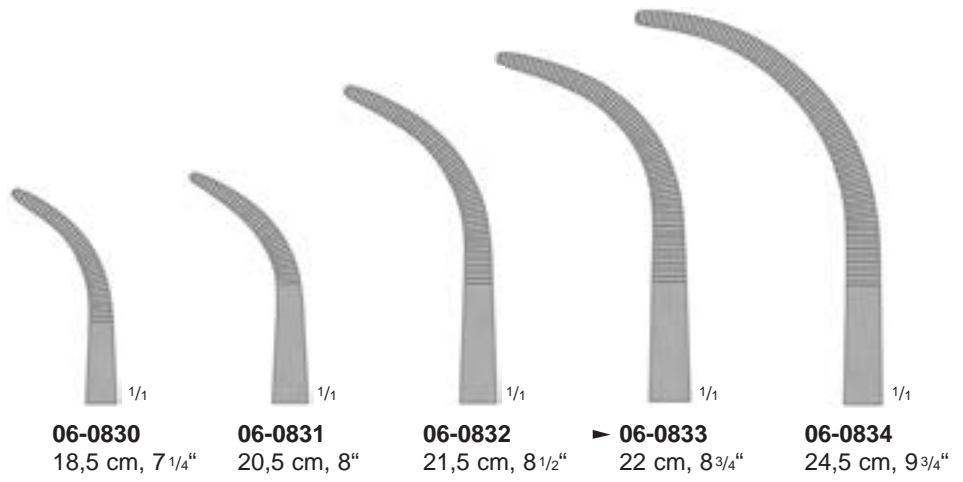

OVERHOLT
06-0830
- 06-0834

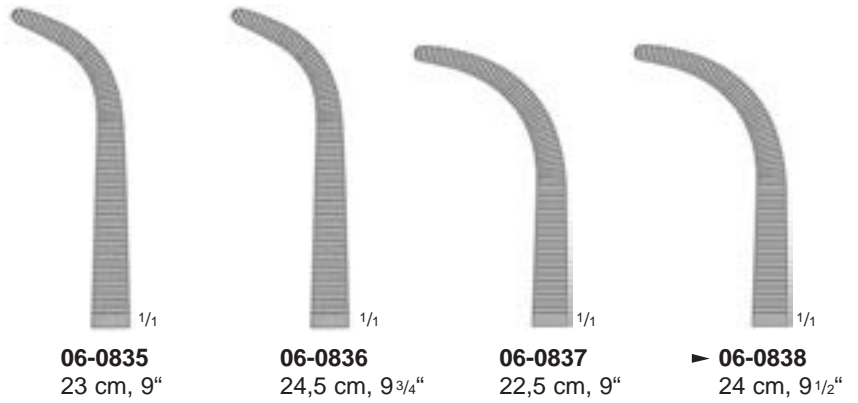

OVERHOLT-MIOTTI
06-0835
- 06-0838



Präparier- und Ligaturklemmen

Dissecting and Ligature Forceps

Pinzas de disección y ligaduras

Pinces à disséquer et à ligatures

Pinze per preparazioni e legature



▶ **36-0321**
24,5 cm, 9³/₄"

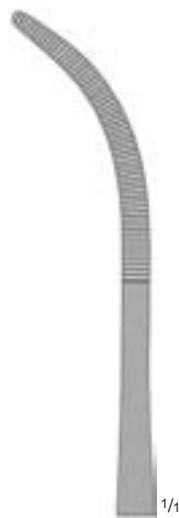

36-0322
24,5 cm, 9³/₄"

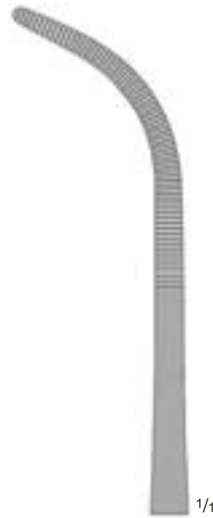

36-0323
24,5 cm, 9³/₄"

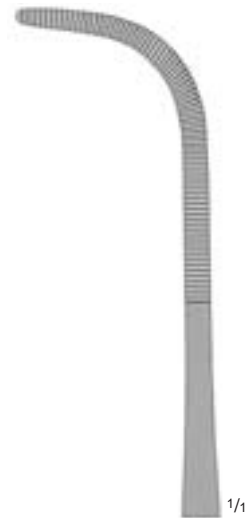

36-0324
24,5 cm, 9³/₄"

RUMEL
36-0321
- **36-0324**

1/2

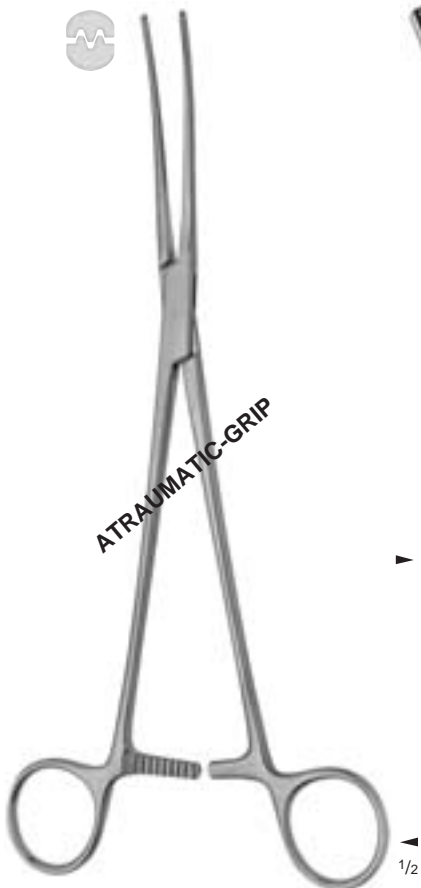

▶ **36-1326**
24,5 cm, 9³/₄"



36-1327
24 cm, 9¹/₂"



36-1328
23,5 cm, 9¹/₄"



36-1329
23 cm, 9"

RUMEL-DE BAKEY
36-1326
- **36-1329**

mit atraumatischer Riefung
with non-traumatic serration
con bocas atraumáticas
avec mors atrauma
con morsi atraumatici

1/2

Präparier- und Ligaturklemmen

Dissecting and Ligature Forceps

Pinzas de disección y ligaduras

Pinces à disséquer et à ligatures

Pinze per preparazioni e legature



BRIDGE
06-0291
28,5 cm, 11 1/4"



LAWRENCE
06-0294
28 cm, 11"



MEEKER
06-0297
28 cm, 11"



Präparier- und Ligaturklemmen

Dissecting and Ligature Forceps

Pinzas de disección y ligaduras

Pinces à disséquer et à ligatures

Pinze per preparazioni e legature



MIXTER
06-0719
28 cm, 11"



ZENKER
06-0761
- **06-0762**

► **06-0761**
31 cm, 12 $\frac{1}{4}$ "

06-0762
30,5 cm, 12"

Präparier- und Ligaturklemmen

Dissecting and Ligature Forceps

Pinzas de disección y ligaduras

Pinces à disséquer et à ligatures

Pinze per preparazioni e legature



LOWER
11-0420
18,5 cm, 7 1/4"

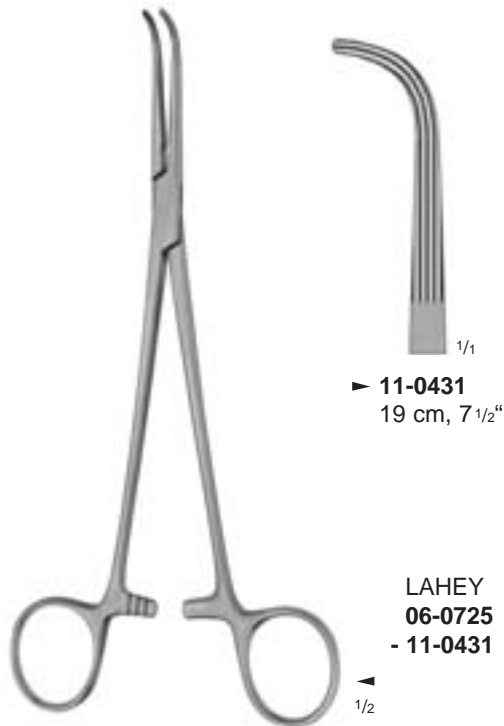

▶ **11-0431**
19 cm, 7 1/2"

06-0725
23 cm, 9"

LAHEY
06-0725
- **11-0431**

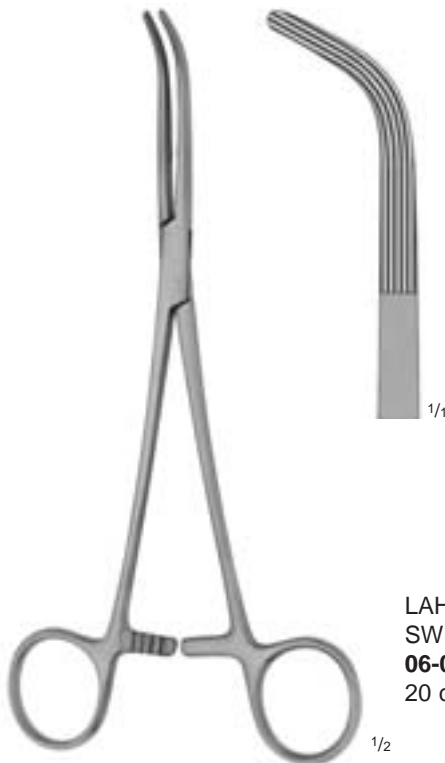

LAHEY-SWEET
06-0723
20 cm, 8"

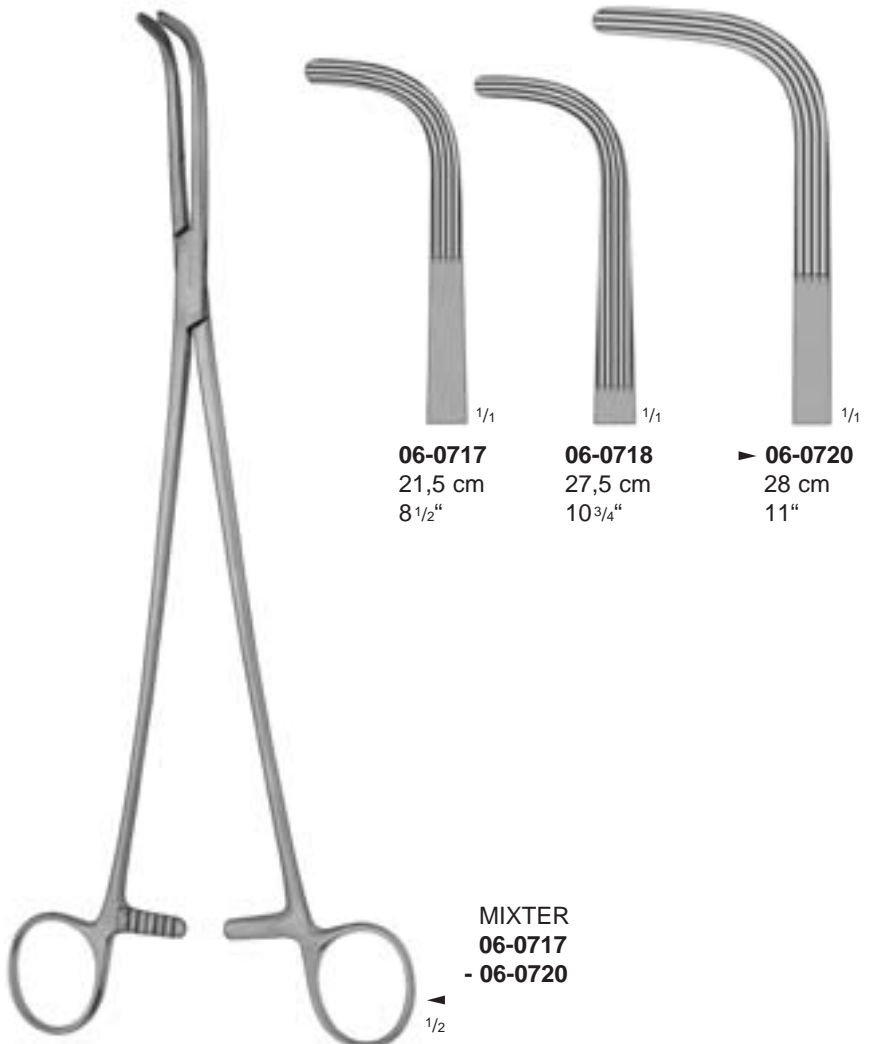

06-0717
21,5 cm
8 1/2"

06-0718
27,5 cm
10 3/4"

▶ **06-0720**
28 cm
11"

MIXTER
06-0717
- **06-0720**



Nierenklemmen

Kidney Clamps
Pinzas-clamps para renal
Clamps rénaux
Pinze-clamps per rene

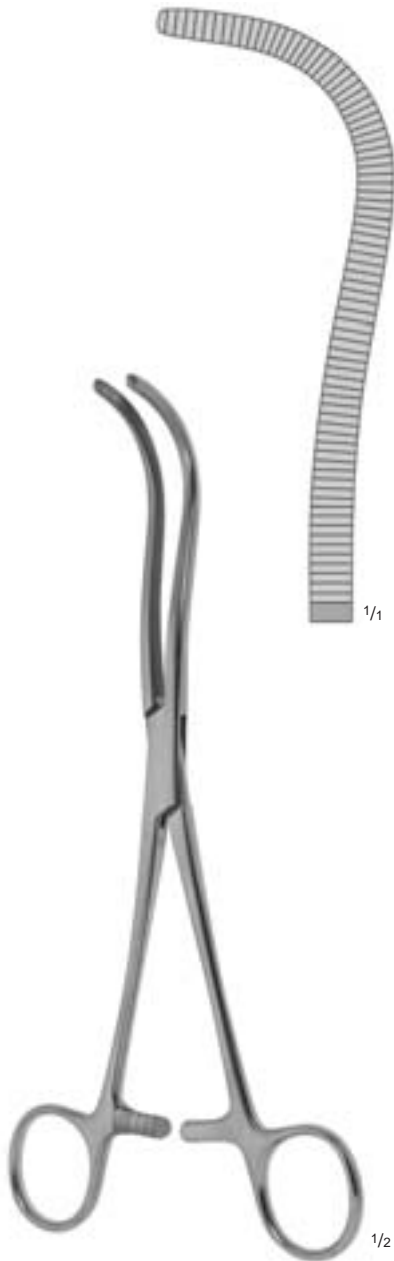

GUYON
92-0550
23,5 cm, 9 1/4"

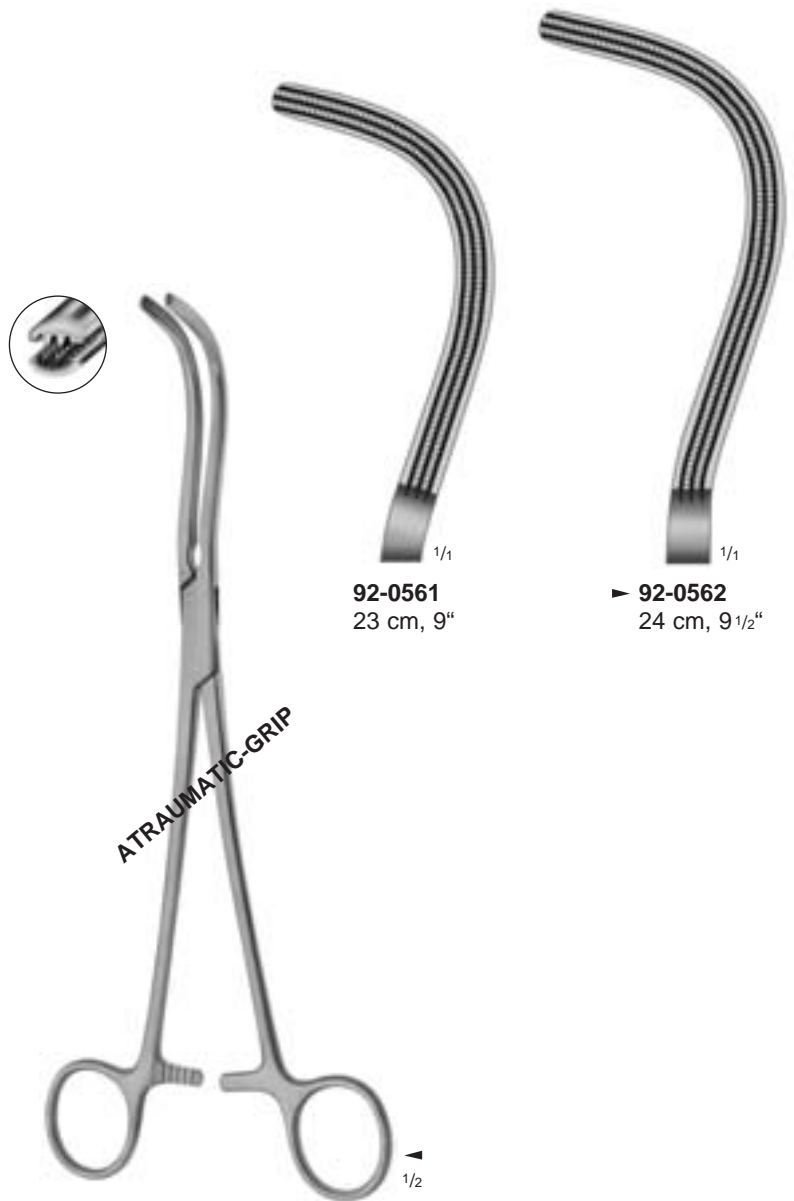

92-0561
23 cm, 9"

▶ 92-0562
24 cm, 9 1/2"

GUYON-DE BAKEY
92-0561
- 92-0562

mit atraumatischer Riefung
with non-traumatic serration
con bocas atraumáticas
avec mors atrauma
con morsi atraumatici

Nierenstielklemmen

Kidney Pedicle Clamps

Pinzas-clamps para pedúnculo renal

Pinces-clamps pour pédicules rénaux

Pinze per peduncoli renali



HERRICK
92-0560
23,5 cm, 9 1/4"



WERTHEIM-CULLEN
92-0580
23 cm, 9"



Peritoneumklemmen

Peritoneum Forceps

Pinzas-clamps para peritoneo

Pinces-clamps pour le péritoine

Pinze per peritoneo

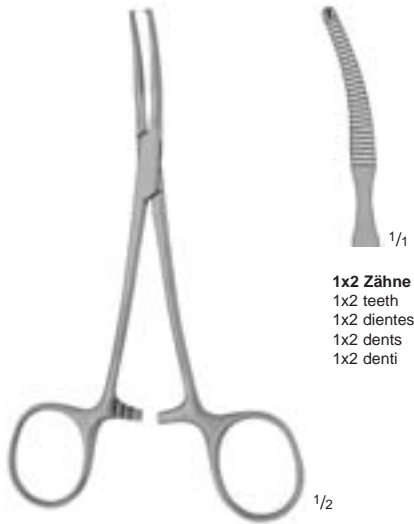

1x2 Zähne
1x2 teeth
1x2 dientes
1x2 dents
1x2 denti

BABY-MIKULICZ
92-0612
14 cm, 5 1/2"

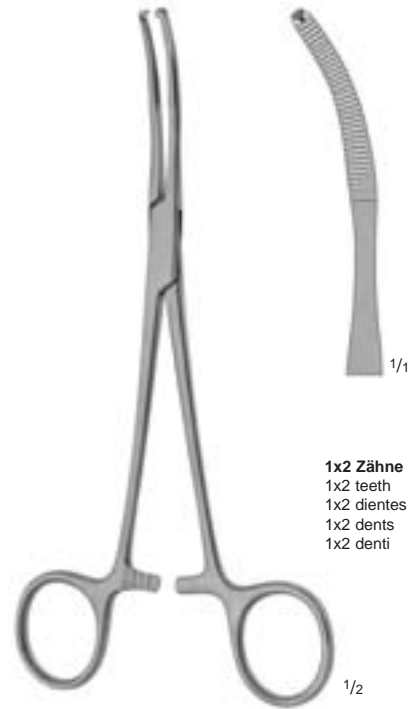

1x2 Zähne
1x2 teeth
1x2 dientes
1x2 dents
1x2 denti

MIKULICZ
92-0613
18,5 cm, 7 1/4"

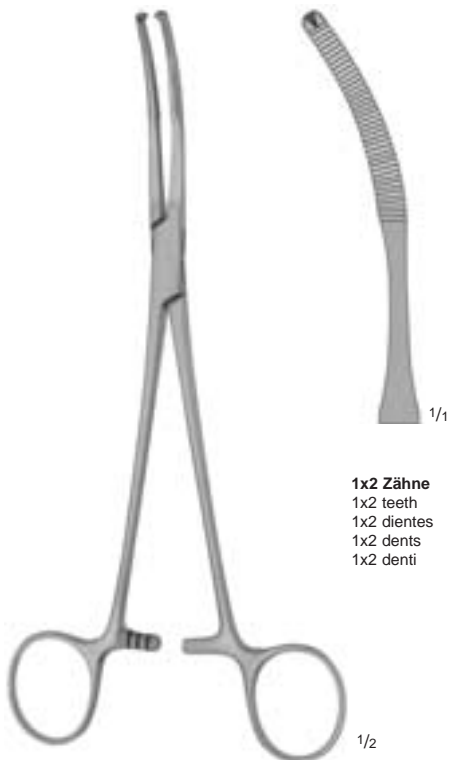

1x2 Zähne
1x2 teeth
1x2 dientes
1x2 dents
1x2 denti

MIKULICZ
92-0625
20 cm, 8"

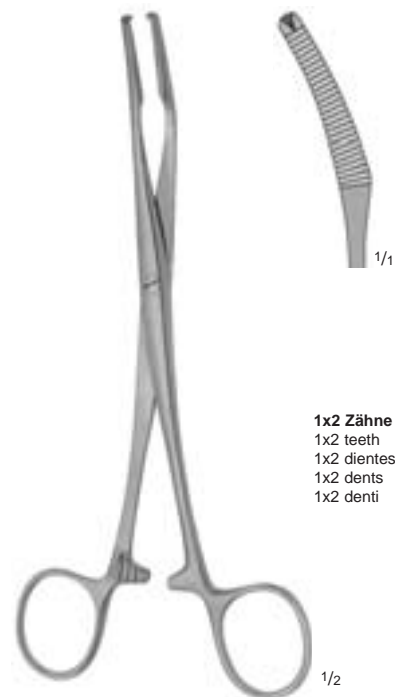

1x2 Zähne
1x2 teeth
1x2 dientes
1x2 dents
1x2 denti

MIKULICZ
92-0615
18 cm, 7"

Peritoneumklemmen

Peritoneum Forceps

Pinzas-clamps para peritoneo

Pinces-clamps pour le péritoine

Pinze per peritoneo

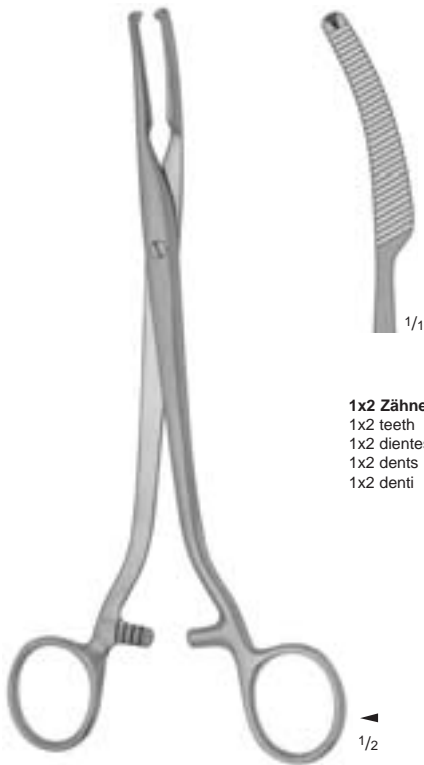

1x2 Zähne
1x2 teeth
1x2 dientes
1x2 dents
1x2 denti

MIKULICZ
92-0620
20 cm, 8"

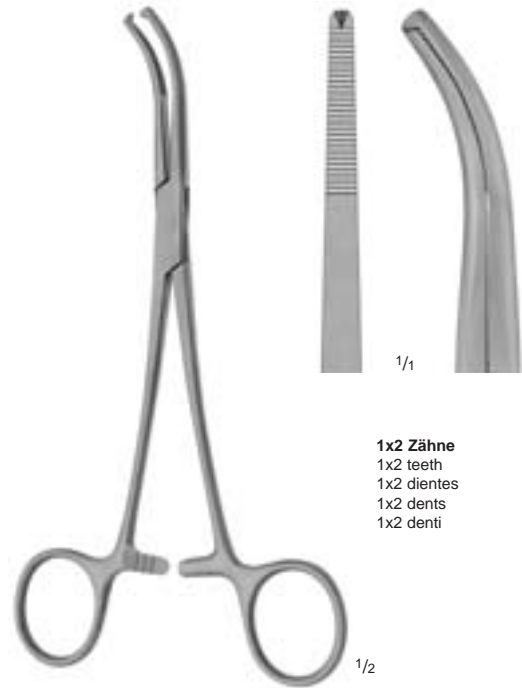

1x2 Zähne
1x2 teeth
1x2 dientes
1x2 dents
1x2 denti

MIKULICZ
92-0624
18,5 cm, 7 1/4"

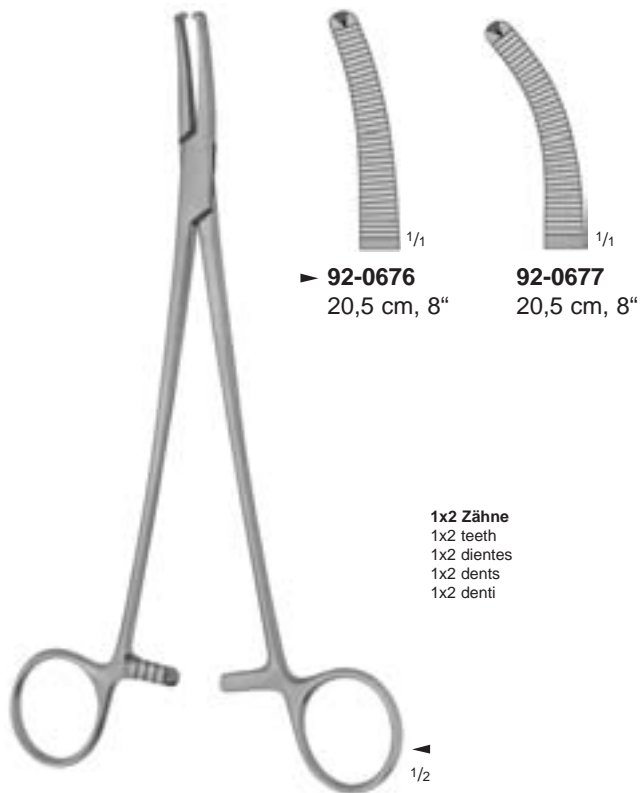

► 92-0676
20,5 cm, 8"

92-0677
20,5 cm, 8"

1x2 Zähne
1x2 teeth
1x2 dientes
1x2 dents
1x2 denti

FAURE
92-0676
- 92-0677

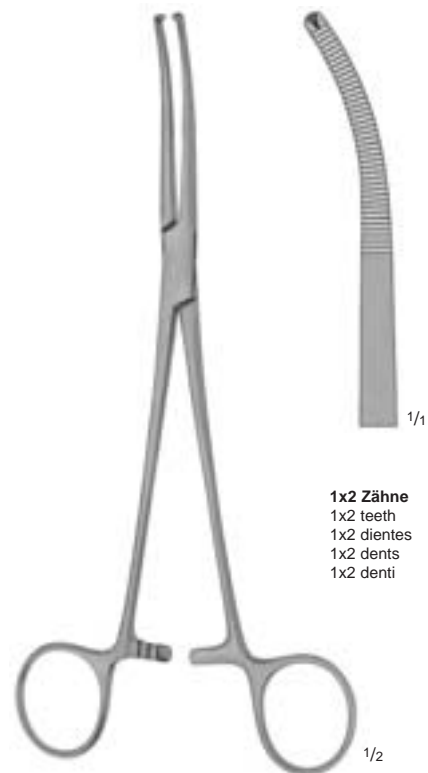

1x2 Zähne
1x2 teeth
1x2 dientes
1x2 dents
1x2 denti

MIKULICZ
80-0735
20 cm, 8"



Hysterektomieklemmen

Hysterectomy Forceps
Pinzas-clamps para histerectomía
Pincès à hystérectomie
Pinze per isterectomia

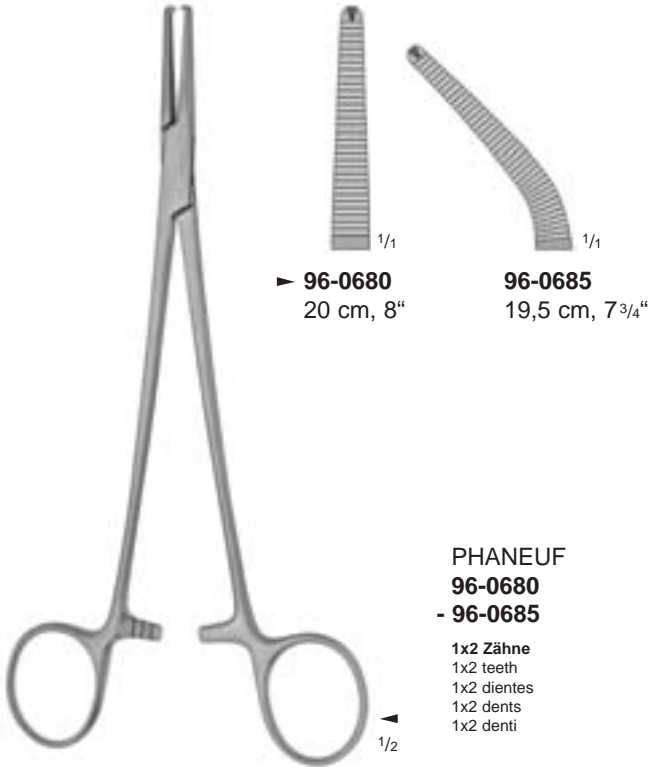

► **96-0680**
20 cm, 8"

96-0685
19,5 cm, 7 3/4"

PHANEUF

96-0680
- **96-0685**

1x2 Zähne
1x2 teeth
1x2 dientes
1x2 dents
1x2 denti

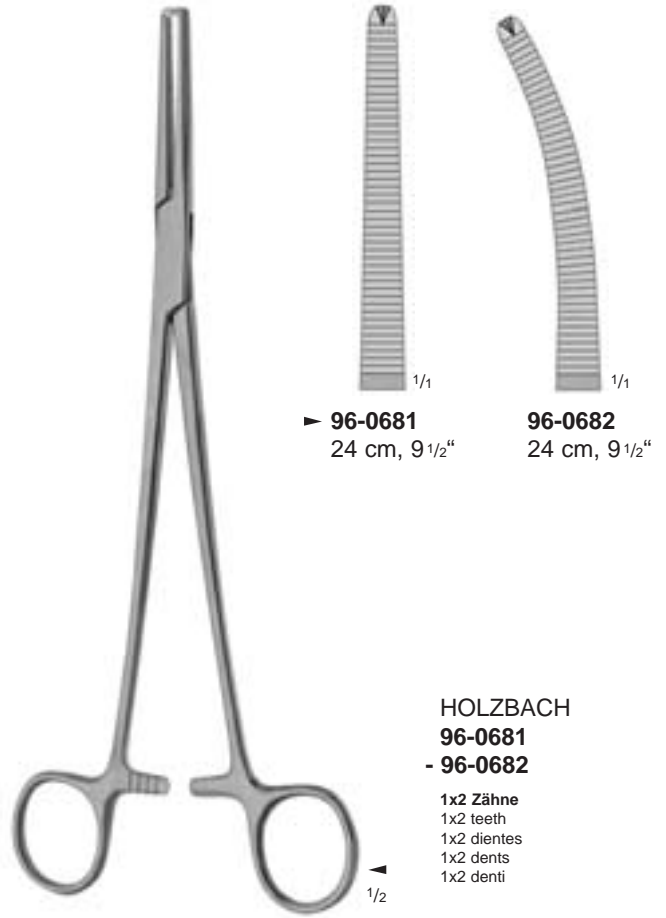

► **96-0681**
24 cm, 9 1/2"

96-0682
24 cm, 9 1/2"

HOLZBACH

96-0681
- **96-0682**

1x2 Zähne
1x2 teeth
1x2 dientes
1x2 dents
1x2 denti



LONG
96-0620
18,5 cm, 7 1/4"

1x2 Zähne
1x2 teeth
1x2 dientes
1x2 dents
1x2 denti

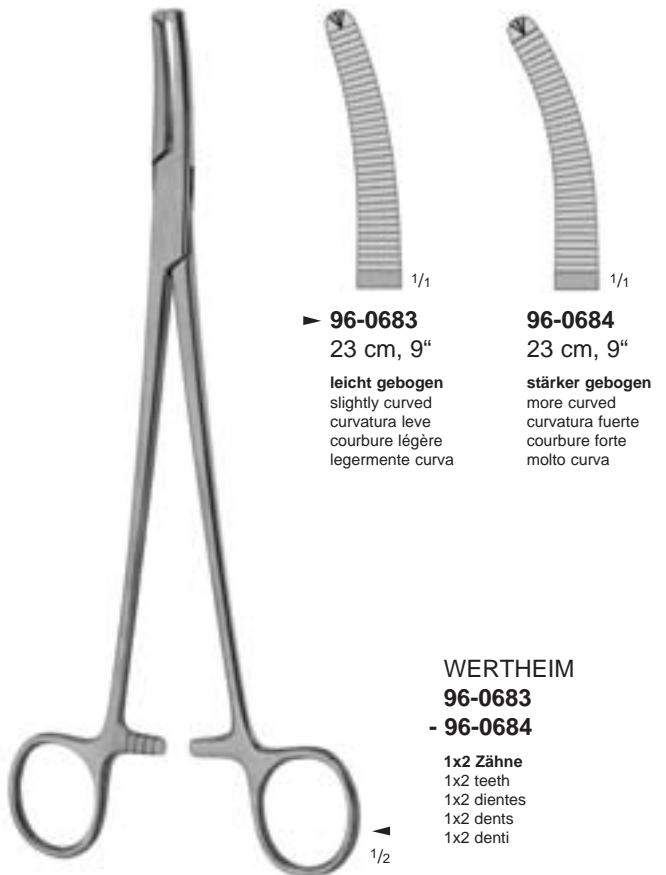

► **96-0683**
23 cm, 9"

leicht gebogen
slightly curved
curvatura leve
courbure légère
legermente curva

96-0684
23 cm, 9"

stärker gebogen
more curved
curvatura fuerte
courbure forte
molto curva

WERTHEIM

96-0683
- **96-0684**

1x2 Zähne
1x2 teeth
1x2 dientes
1x2 dents
1x2 denti

Hysterektomieklemmen

Hysterectomy Forceps

Pinzas-clamps para histerectomía

Pinces à hystérectomie

Pinze per isterectomia



WERTHEIM
92-0590
25 cm, 10"



WERTHEIM
96-0605
25,5 cm, 10"

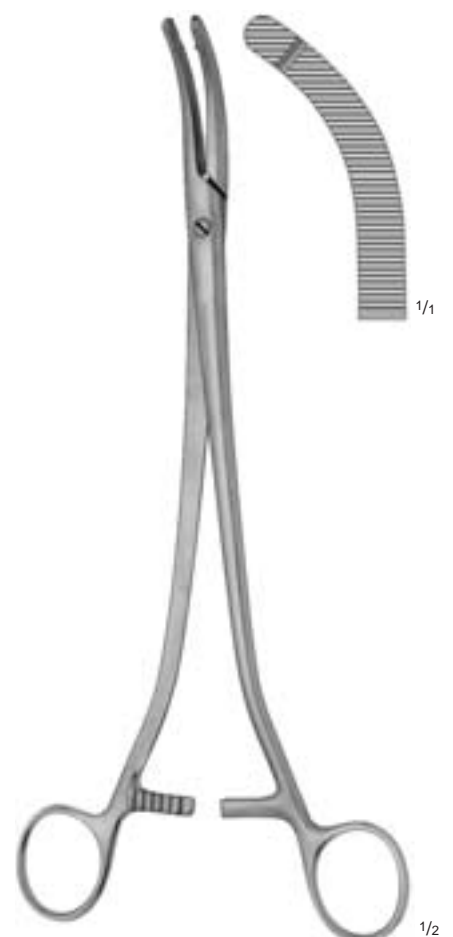

SEGOND
96-0674
24,5 cm, 9³/₄"



Hysterektomieklemmen
Hysterectomy Forceps
Pinzas-clamps para histerectomía
Pincès à hystérectomie
Pinze per isterectomia

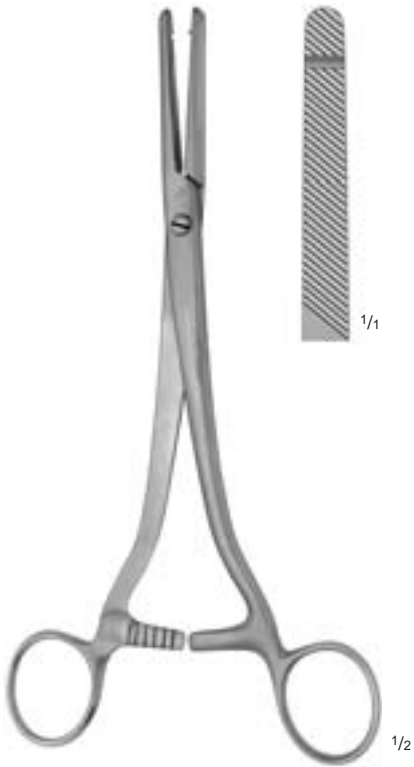

SEGOND
96-0670
20 cm, 8"



HEANEY
96-0600
21 cm, 8 1/4"

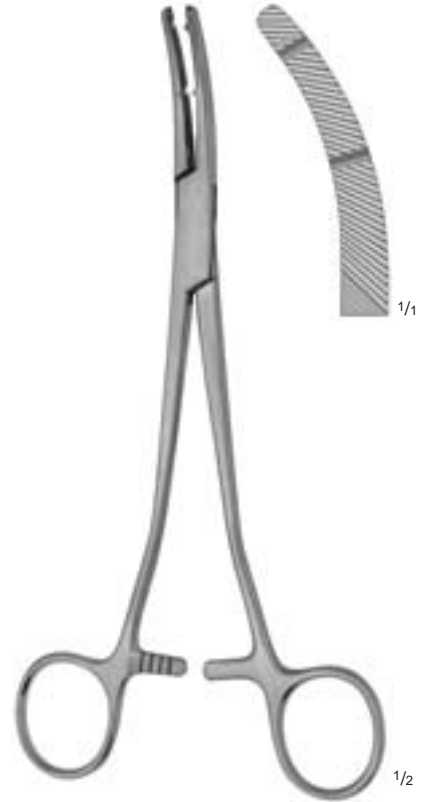

HEANEY
96-0602
21 cm, 8 1/4"

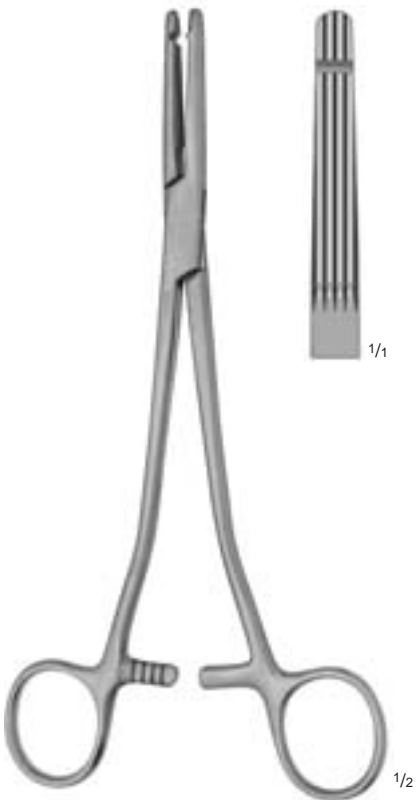

BALLENTINE
96-0630
21,5 cm, 8 1/2"



HEANEY-BALLENTINE
96-0628
21,5 cm, 8 1/2"

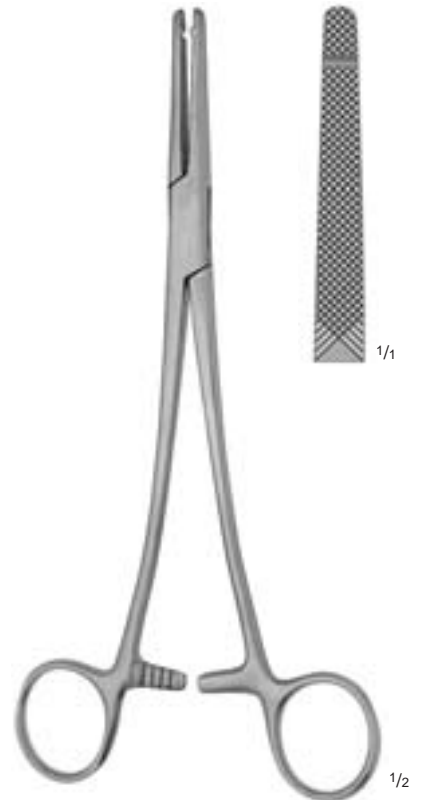

HEANEY-REZEK
96-0625
21,5 cm, 8 1/2"

ATRAUMATIC-GRIP Hysterektomieklemmen mit atraumatischer Riefung
ATRAUMATIC-GRIP Hysterectomy Forceps with non-traumatic serration
ATRAUMATIC-GRIP Pinzas-clamps para histerectomía con bocas atraumáticas
ATRAUMATIC-GRIP Pincès à hystérectomie avec mors atrauma
ATRAUMATIC-GRIP Pinze per isterectomia con morsi atraumatici



HEANEY-DE BAKEY (ROGERS)
96-0580
- 96-0584

1/2

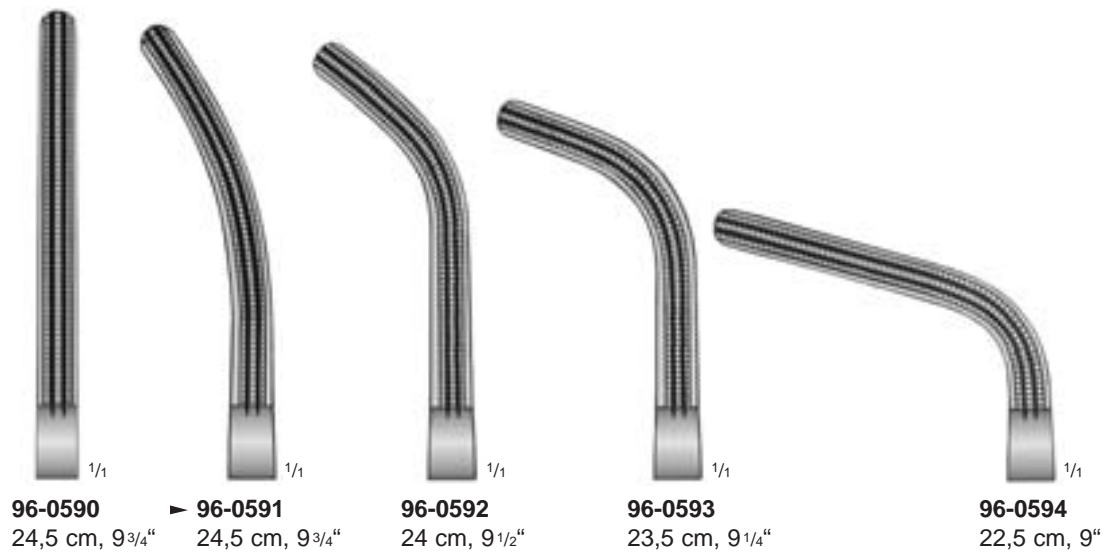

WERTHEIM-DE BAKEY (ROGERS)
96-0590
- 96-0594

Parametriumklemmen
 Parametrium forceps
 Pinzas-clamps parametrium
 Pincès-clamps pour ligaments larges
 Pinze-clamps per parametrio

1/2

**Weitere Klemmen und Klemmzangen**

Further Forceps and Clamps

Más pinzas y pinzas-clamps

D'autres pincés et pincés-clamps

Altre pinze e pinze emostatiche



Polypen- und Ovarienzangen	Seite	23, 457
Polypus and Ovum Forceps	Page	23, 457
Pinzas para pólipos uterinos y ovarios	Página	23, 457
Pincés à polypes et ovaires	Page	23, 457
Pinze per polipi e ovaie	Pagina	23, 457



Darm- und Gewebefazangen	Seite	383 - 389
Intestinal and Tissue Grasping Forceps	Page	383 - 389
Pinzas intestinales y para tejidos	Página	383 - 389
Pincés pour l'intestin et tissu	Page	383 - 389
Pinze intestinali e da presa	Pagina	383 - 389



Darmklemmen	Seite	390 - 403
Intestinal Clamps Forceps	Page	390 - 403
Pinzas-clamps intestinales	Página	390 - 403
Pincés-clamps pour l'intestin	Page	390 - 403
Pinze intestinali	Pagina	390 - 403



ATRAUMATIC-GRIP Gefäßklemmen	Seite	519 - 524, 529 - 562
ATRAUMATIC-GRIP Vascular Clamps	Page	519 - 524, 529 - 562
ATRAUMATIC-GRIP Pinzas-clamps vasculares	Página	519 - 524, 529 - 562
ATRAUMATIC-GRIP Pincés vasculaires	Page	514 - 524, 529 - 562
ATRAUMATIC-GRIP Pinze vascolari	Pagina	519 - 524, 529 - 562



ATRAUMATIC-GRIP Bulldogklemmen	Seite	525 - 528
ATRAUMATIC-GRIP Bulldog Clamps	Page	525 - 528
ATRAUMATIC-GRIP Clamps Bulldog	Página	525 - 528
ATRAUMATIC-GRIP Clamps Bulldog	Page	525 - 528
ATRAUMATIC-GRIP Pinze Bulldog	Pagina	525 - 528



Gefäßklemmen	Seite	563 - 565
Vascular Clamps	Page	563 - 565
Pinzas-clamps vasculares	Página	563 - 565
Pincés vasculaires	Page	563 - 565
Pinze vascolari	Pagina	563 - 565



Bronchusklemmen	Seite	566
Bronchus Forceps	Page	566
Pinzas-clamps bronquiales	Página	566
Pincés-clamps à bronches	Page	566
Pinze per legature	Pagina	566



LAWNTON

Medizintechnik



Tuchklemmen, Schlauchklemmen, Tupferzangen

Towel Clamps, Tubing Clamps, Cotton Swab Forceps

Pinzas de campo, Pinzas para tubos, Pinzas para tampones

Pinces à compresses, Pinces presse-tubes, Pinces à tampons

Pinze per fissare le compresse, Pinze per tubi, Pinze per tamponi



Tuchklemmen
Towel Clamps
Pinzas de campo
Pinces à compresses
Pinze per fissare le compresse



JONES
07-0135
6 cm, 2 3/8"



JONES
07-0130
8,5 cm, 3 3/8"



ENGL. MOD.
07-0138
8,5 cm, 3 3/8"



SCHÄDEL
07-0139
9 cm, 3 1/2"



SCHÄDEL
07-0140
9 cm, 3 1/2"



DOYEN
07-0143
18 cm, 7"



JONES
07-0131
8,5 cm, 3 3/8"
mit Schlauch- oder Kabelhalter
with clip for tubing or cable
con porta-tubo o porta-cable
avec porte-tube ou porte-cordon
d'alimentation
con porta-tubo o porta-cavo



07-0103
11 cm, 4 3/8"
mit Schlauch- oder Kabelhalter
with clip for tubing or cable
con porta-tubo o porta-cable
avec porte-tube ou porte-cordon
d'alimentation
con porta-tubo o porta-cavo



GREEN
07-0111
16,5 cm, 6 1/2"
mit Schlauch- oder Kabelhalter
with clip for tubing or cable
con porta-tubo o porta-cable
avec porte-tube ou porte-cordon
d'alimentation
con porta-tubo o porta-cavo

Tuchklemmen
 Towel Clamps
 Pinzas de campo
 Pincas à compresses
 Pinze per fissare le compresse

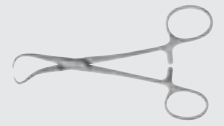

BACKHAUS
 07-0100
 - 07-0109



07-0100
 9 cm, 3 1/2"



07-0102
 11 cm, 4 3/8"



▶ 07-0105
 13,5 cm, 5 1/4"



07-0109
 15,5 cm, 6"



ROEDER
 07-0110
 13,5 cm, 5 1/4"



BERNHARD
 07-0106
 16 cm, 6 1/4"



LANE
 07-0108
 19,5 cm, 7 3/4"

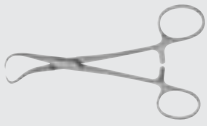

Tuchklemmen
Towel Clamps
Pinzas de campo
Pincas à compresses
Pinze per fissare le compresse

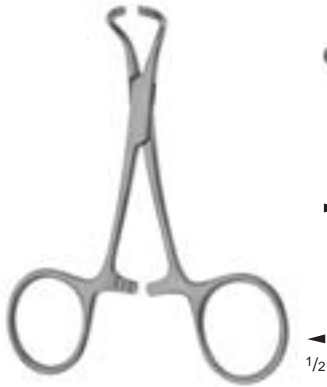

1/2

TOHOKU
07-0126
- 07-0127

für Papiertücher
for paper cloths
para paños de papel
pour champs en papier
per fazzoletti di carta

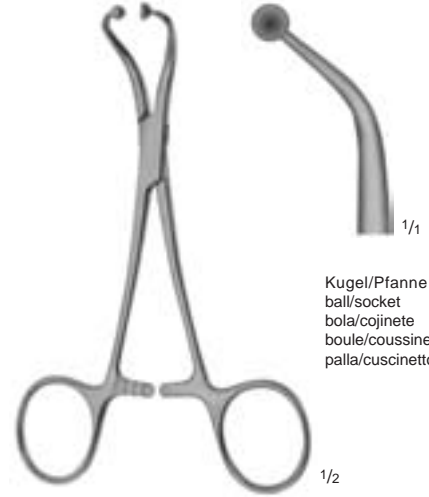

Kugel/Pfanne
ball/socket
bola/cojinete
boule/coussinet
palla/cuscinetto

1/2

07-0120
13,5 cm, 5 1/4"

für Papiertücher
for paper cloths
para paños de papel
pour champs en papier
per fazzoletti di carta

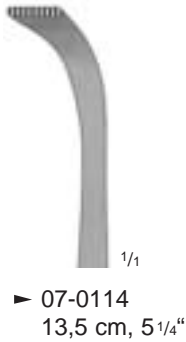
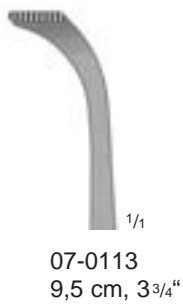

1/2

LORNA
07-0113
- 07-0114

für Papiertücher
for paper cloths
para paños de papel
pour champs en papier
per fazzoletti di carta



1/2

PEERS
07-0112
14,5 cm, 5 3/4"

für Papiertücher
for paper cloths
para paños de papel
pour champs en papier
per fazzoletti di carta

Schlauchklemmen
 Tubing Clamps
 Pinzas para tubos
 Pincas presse-tubes
 Pinze per tubi

Schlauchroller
 Tube Milking Roller
 Rodillo para tubos
 Pincas à traire les drains
 Pinza per pressa tubi con rulli

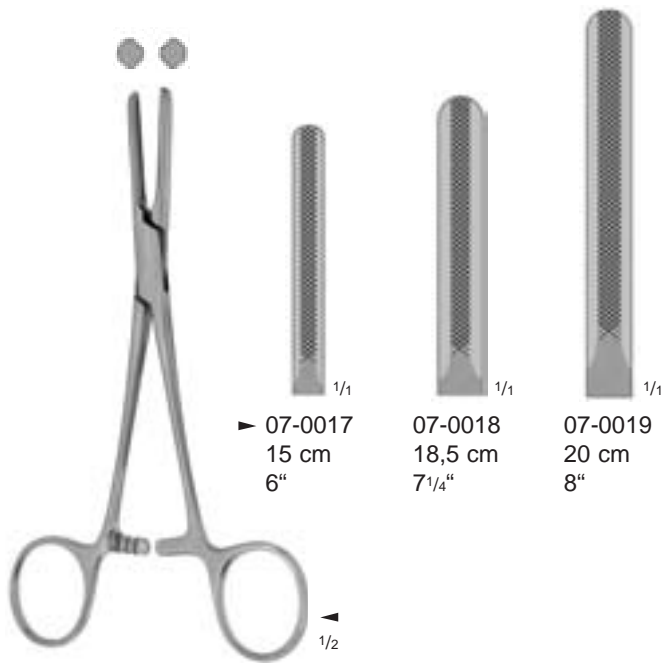

▶ 07-0017
 15 cm
 6"

07-0018
 18,5 cm
 7 1/4"

07-0019
 20 cm
 8"

1/2

07-0017
 - 07-0019

Schlauchklemmen ohne Schutzbügel
 Tubing clamps without safety guard
 Pinzas para tubos, sin estribo de protección
 Pincas presse-tubes sans protection
 Pinze per tubi senza protezione

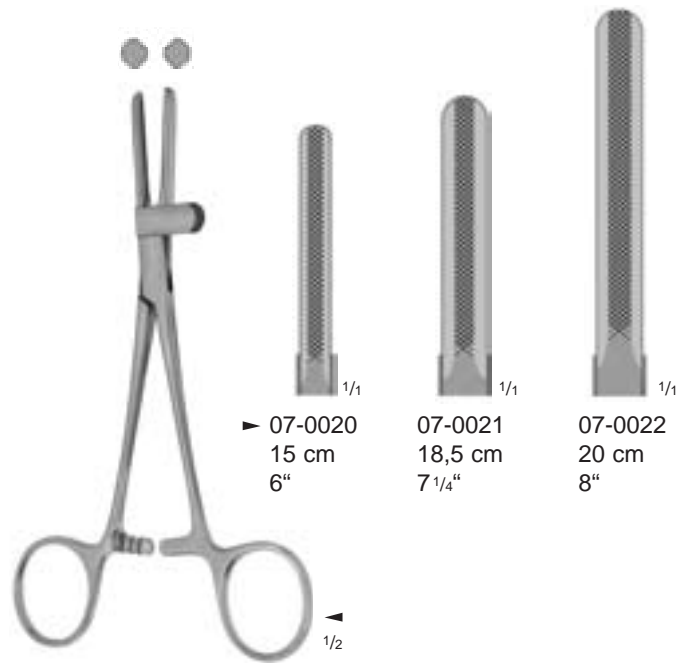

▶ 07-0020
 15 cm
 6"

07-0021
 18,5 cm
 7 1/4"

07-0022
 20 cm
 8"

1/2

07-0020
 - 07-0022

Schlauchklemmen mit Schutzbügel
 Tubing clamps with safety guard
 Pinzas para tubos, con estribo de protección
 Pincas presse-tubes avec protection
 Pinze per tubi con protezione

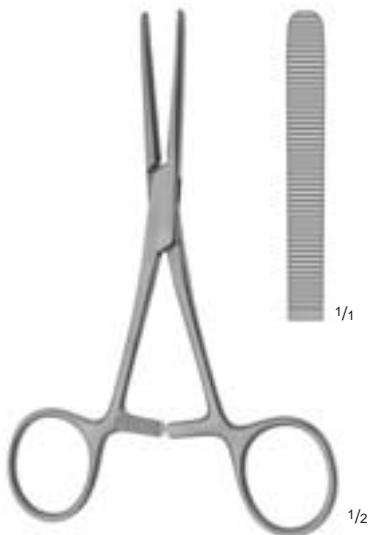

07-0029
 14,5 cm, 5 3/4"

Schlauchklemme
 Tubing clamp
 Pinza para tubos
 Pince presse-tubes
 Pinza per tubi



PRESBYTERIAN
 07-0122
 16,5 cm, 6 1/2"

Schlauchklemme
 Tubing clamp
 Pinza para tubos
 Pince presse-tubes
 Pinza per tubi



GUNNAR-HEY
 07-0030
 18,5 cm, 7 1/4"

Schlauchroller
 Tube milking roller
 Rodillo para tubos
 Pincas à traire les drains
 Pinza pressa tubi con rulli



Korn- und Tupferzangen
 Sponge and Dressing Forceps
 Pinzas para vendajes y torundas
 Pincas à pansements et tampons
 Pinze per medicatura e tamponi



LISTER
 07-0221
 - 07-0227

Sinusklemmen • Sinus forceps • Pinzas para senos • Pincas pour sinus • Pinze per seni

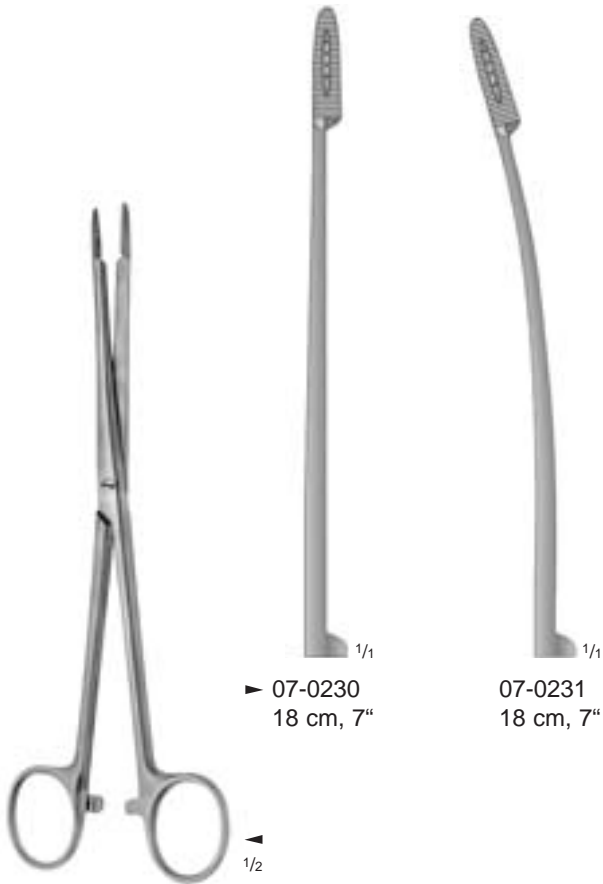

07-0230
 - 07-0231

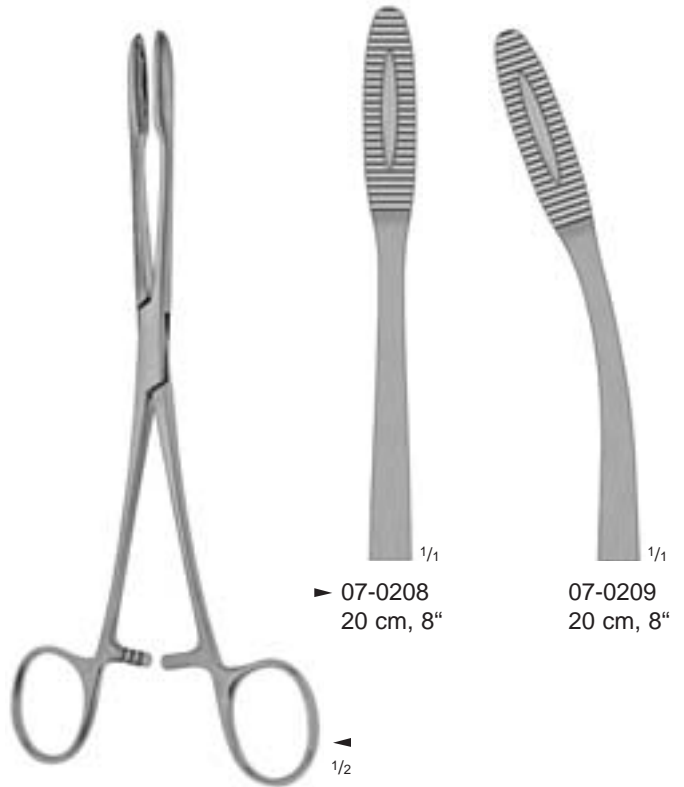

GROSS
 07-0208
 - 07-0209

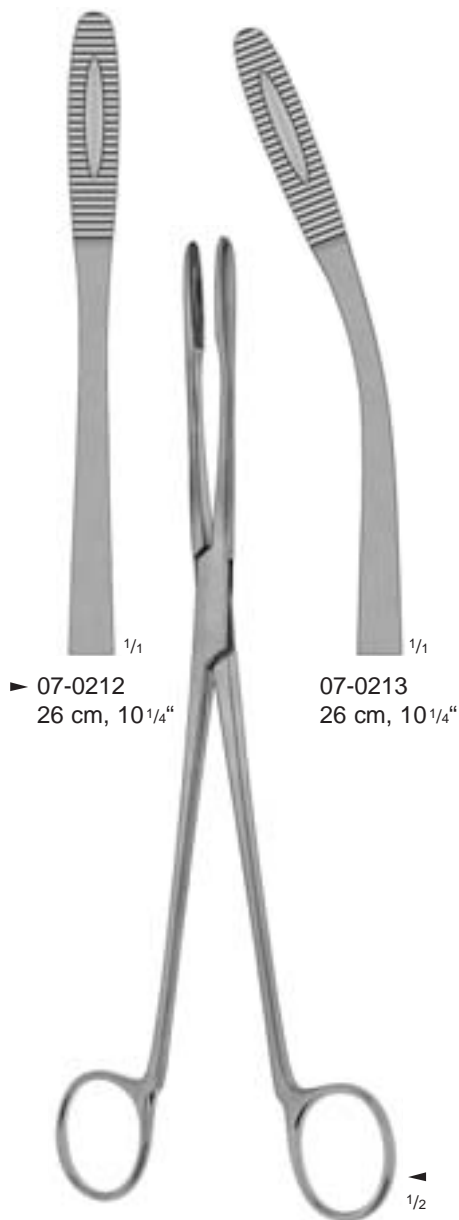

MAIER
 07-0212
 - 07-0213
 ohne Sperre
 without ratchet
 sin cremallera
 sans crémaillère
 senza cremagliera

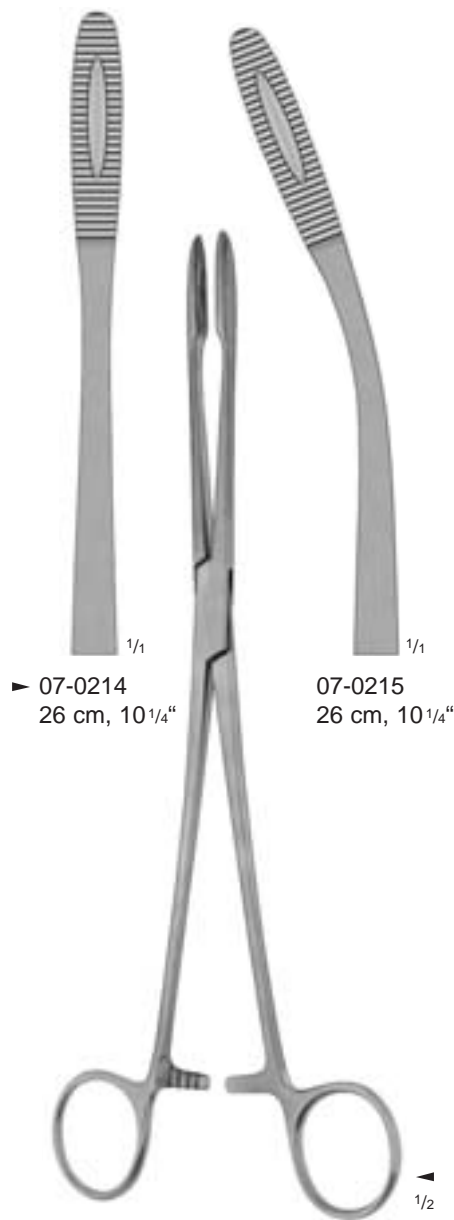

MAIER
 07-0214
 - 07-0215
 mit Sperre
 with ratchet
 con cremallera
 avec crémaillère
 con cremagliera

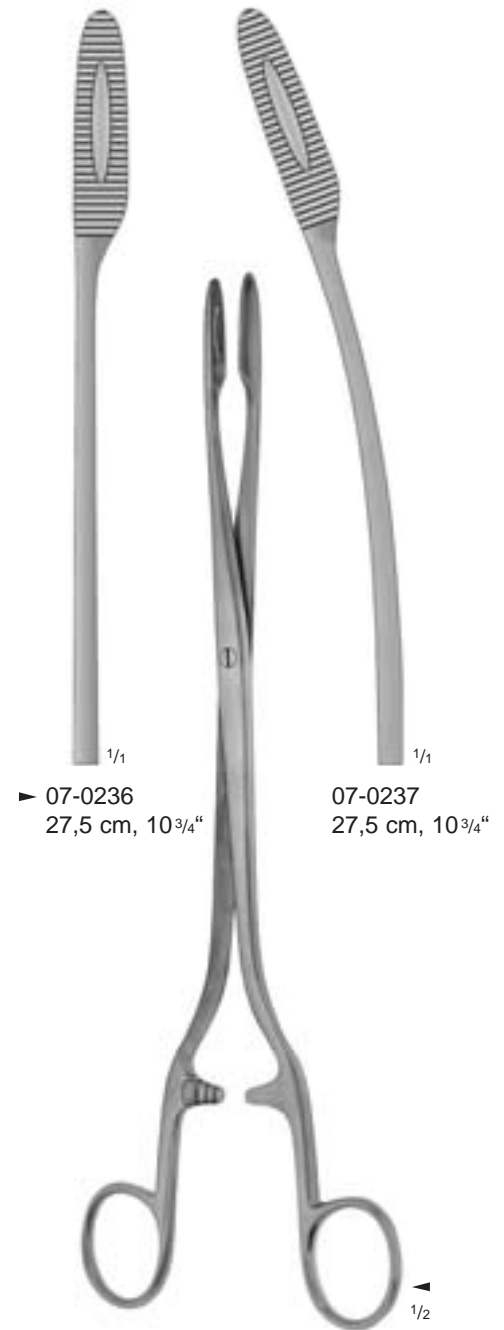

SIMS-MAIER
 07-0236
 - 07-0237
 mit Sperre
 with ratchet
 con cremallera
 avec crémaillère
 con cremagliera



Korn- und Tupferzangen
 Sponge and Dressing Forceps
 Pinzas para vendajes y torundas
 Pincès à pansements et tampons
 Pinze per medicatura e tamponi

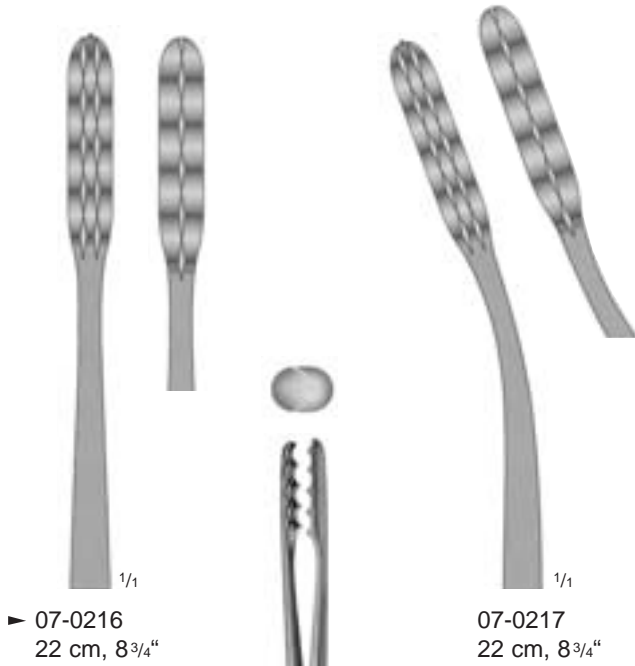

ULRICH
 07-0216
 - 07-0217
 mit Sperre
 with ratchet
 con cremallera
 avec crémaillère
 con cremagliera

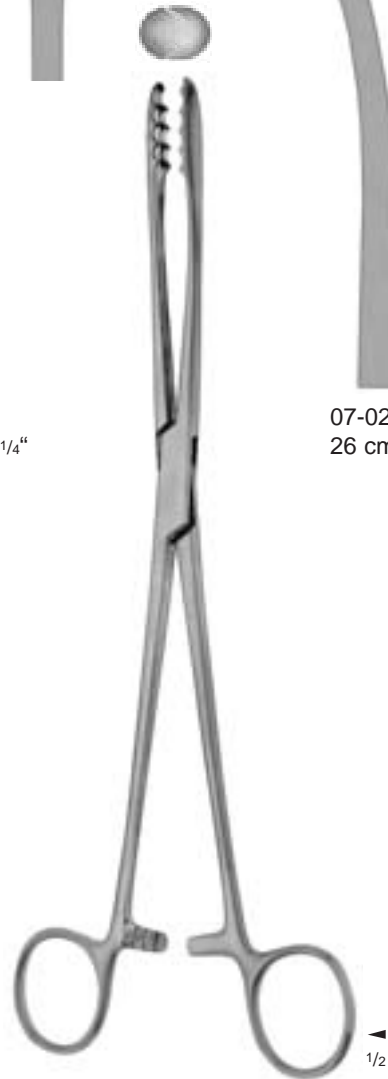
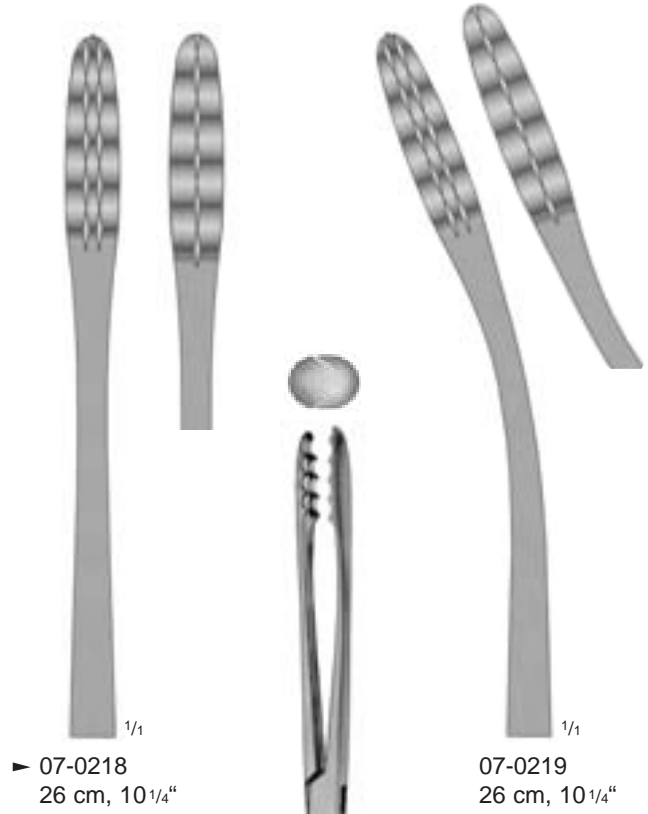

ULRICH
 07-0218
 - 07-0219
 mit Sperre
 with ratchet
 con cremallera
 avec crémaillère
 con cremagliera

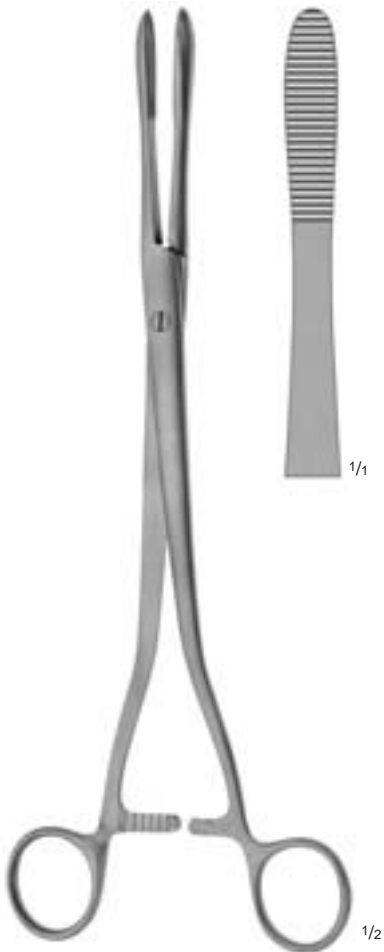

COLLIN
07-0243
25 cm, 10"



CHERON
07-0245
25,5 cm, 10"

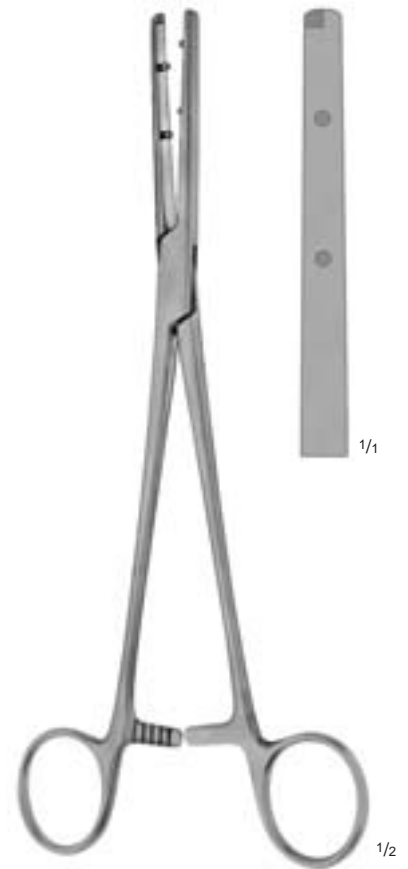

EMMET
07-0248
22,5 cm, 9"

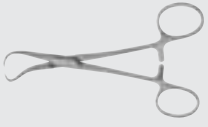

Tamponzangen
Uterine Dressing Forceps
Pinzas para tapones
Pinces à pansements
Pinze per medicature

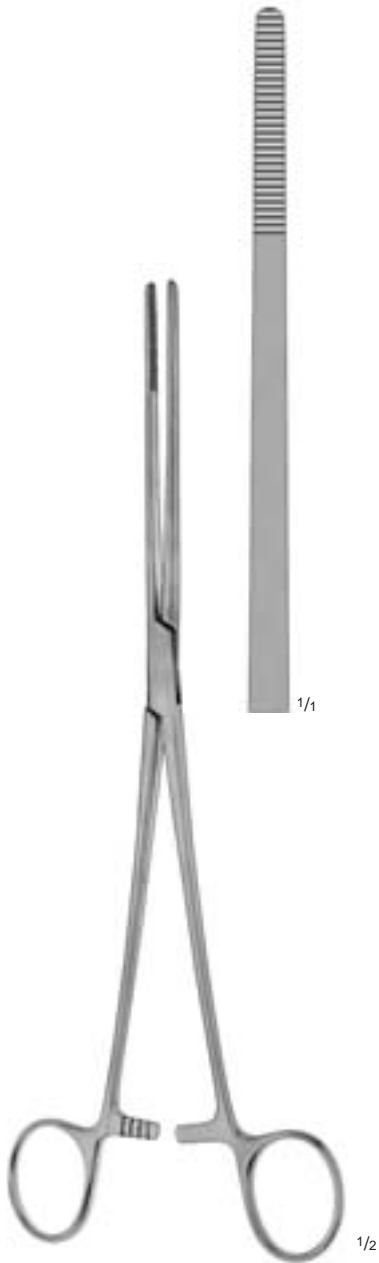

BOZEMANN
96-0110
26 cm, 10 1/4"

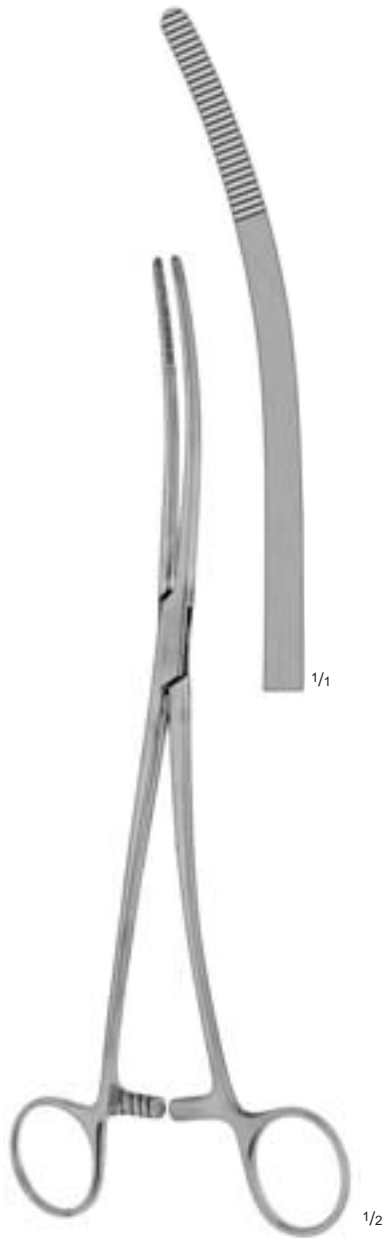

BOZEMANN
96-0105
26 cm, 10 1/4"

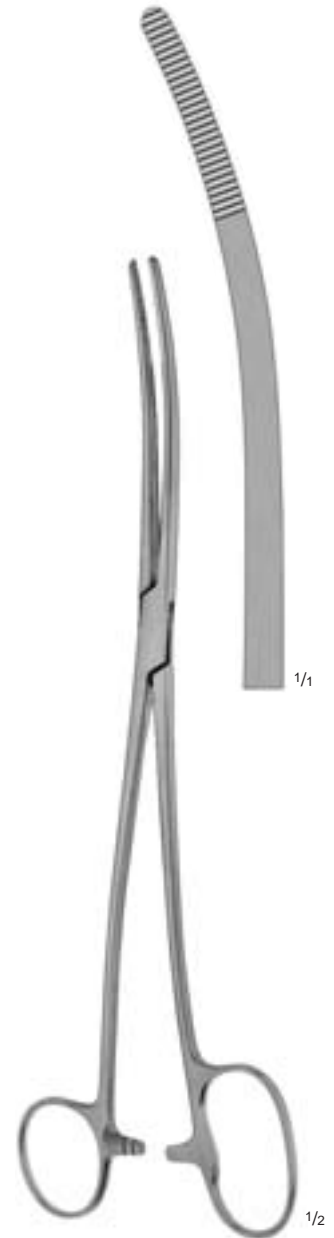

BOZEMANN-DOUGLAS
96-0100
26 cm, 10 1/4"

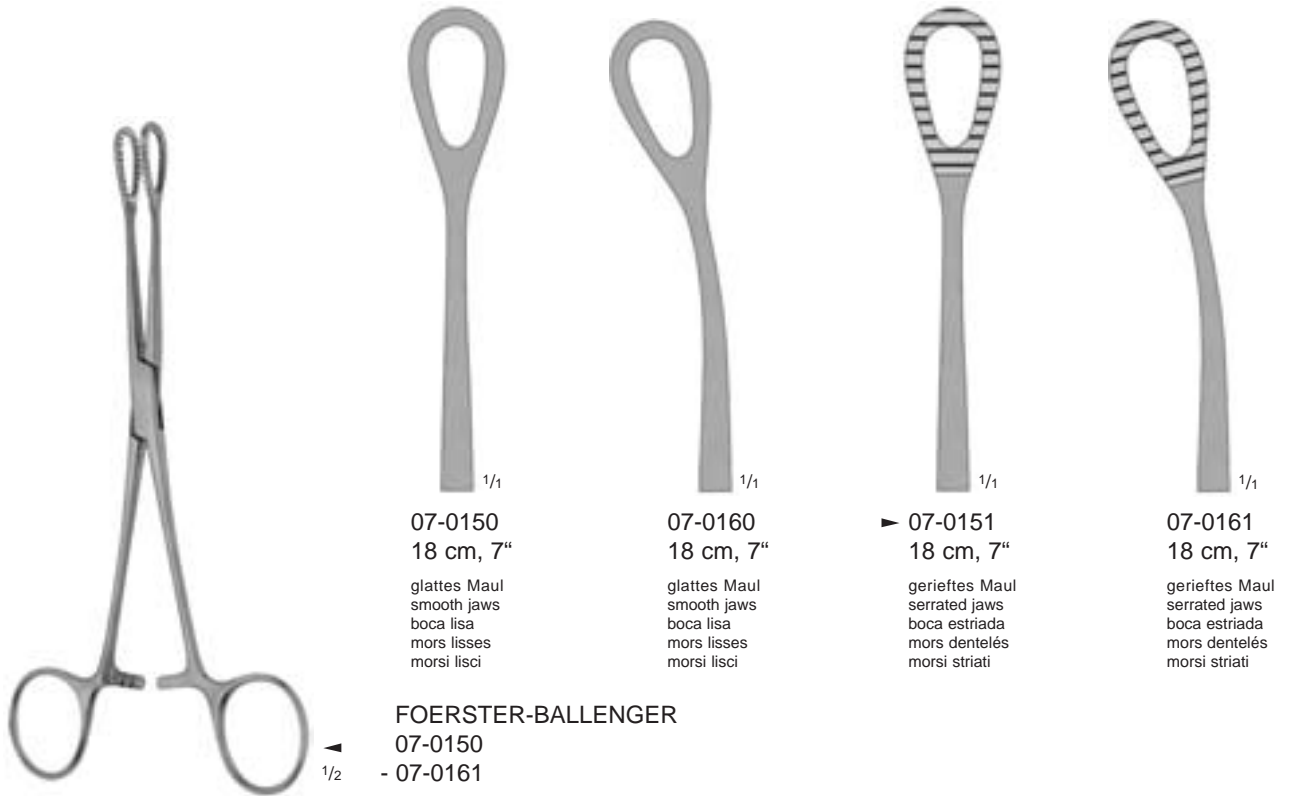

07-0150
 18 cm, 7"
 glattes Maul
 smooth jaws
 boca lisa
 mors lisses
 morsi lisci

07-0160
 18 cm, 7"
 glattes Maul
 smooth jaws
 boca lisa
 mors lisses
 morsi lisci

▶ 07-0151
 18 cm, 7"
 gerieftes Maul
 serrated jaws
 boca estriada
 mors dentelés
 morsi striati

07-0161
 18 cm, 7"
 gerieftes Maul
 serrated jaws
 boca estriada
 mors dentelés
 morsi striati

FOERSTER-BALLENGER
 07-0150
 - 07-0161

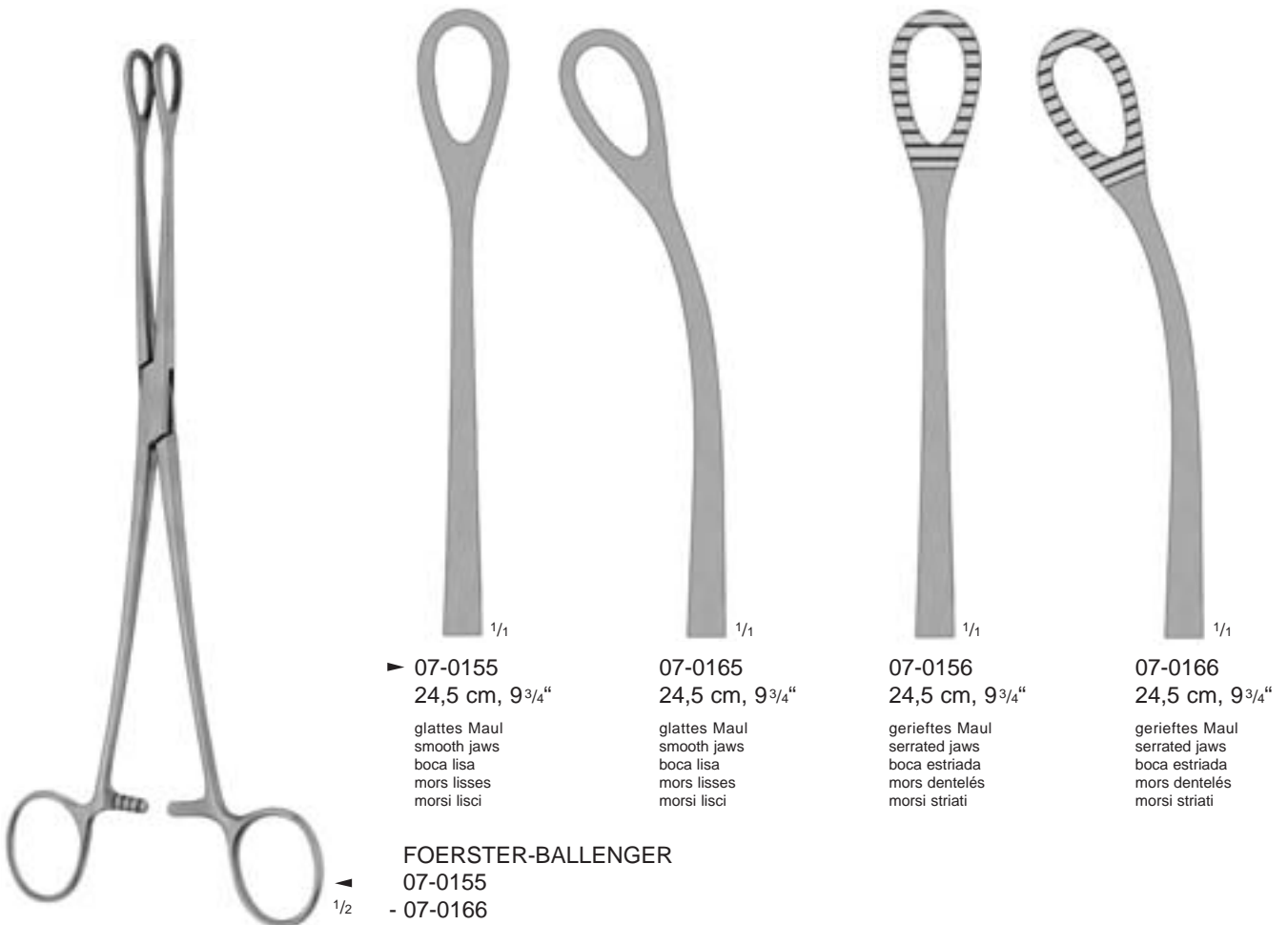

▶ 07-0155
 24,5 cm, 9 3/4"
 glattes Maul
 smooth jaws
 boca lisa
 mors lisses
 morsi lisci

07-0165
 24,5 cm, 9 3/4"
 glattes Maul
 smooth jaws
 boca lisa
 mors lisses
 morsi lisci

07-0156
 24,5 cm, 9 3/4"
 gerieftes Maul
 serrated jaws
 boca estriada
 mors dentelés
 morsi striati

07-0166
 24,5 cm, 9 3/4"
 gerieftes Maul
 serrated jaws
 boca estriada
 mors dentelés
 morsi striati

FOERSTER-BALLENGER
 07-0155
 - 07-0166



Tupfer- und Schwammzangen
Dressing and Sponge Holding Forceps
Pinzas para torundas y esponjas
Pincers à tampons et éponges
Pinze per tamponi e spugne

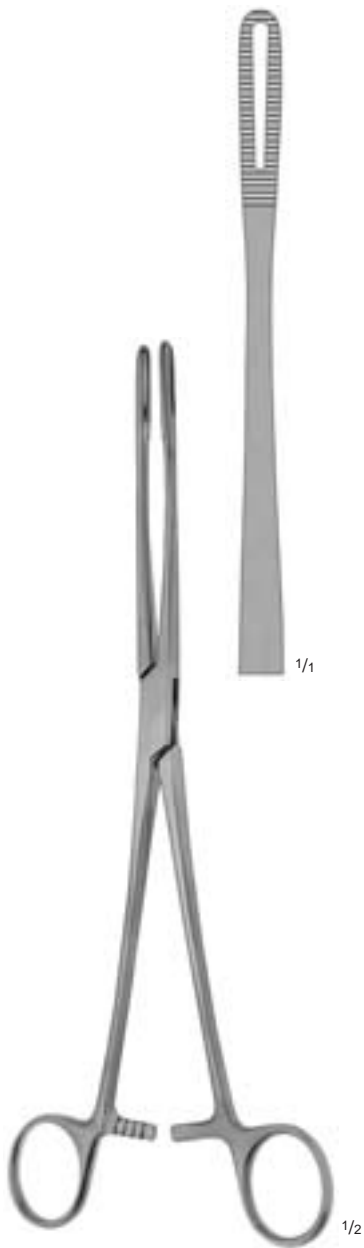

FORBES (FOERSTER)
96-0125
24 cm, 9 1/2"

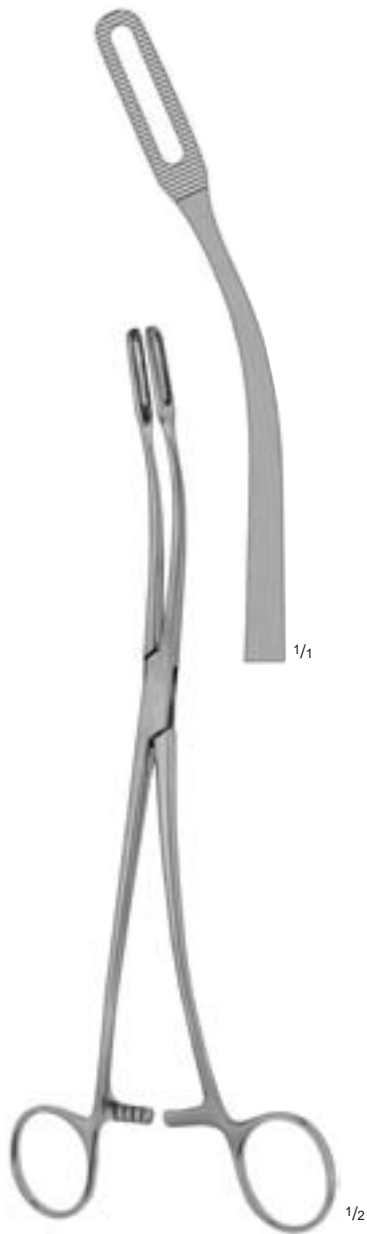

FLETCHER (JAVERTS)
07-0170
24 cm, 9 1/2"

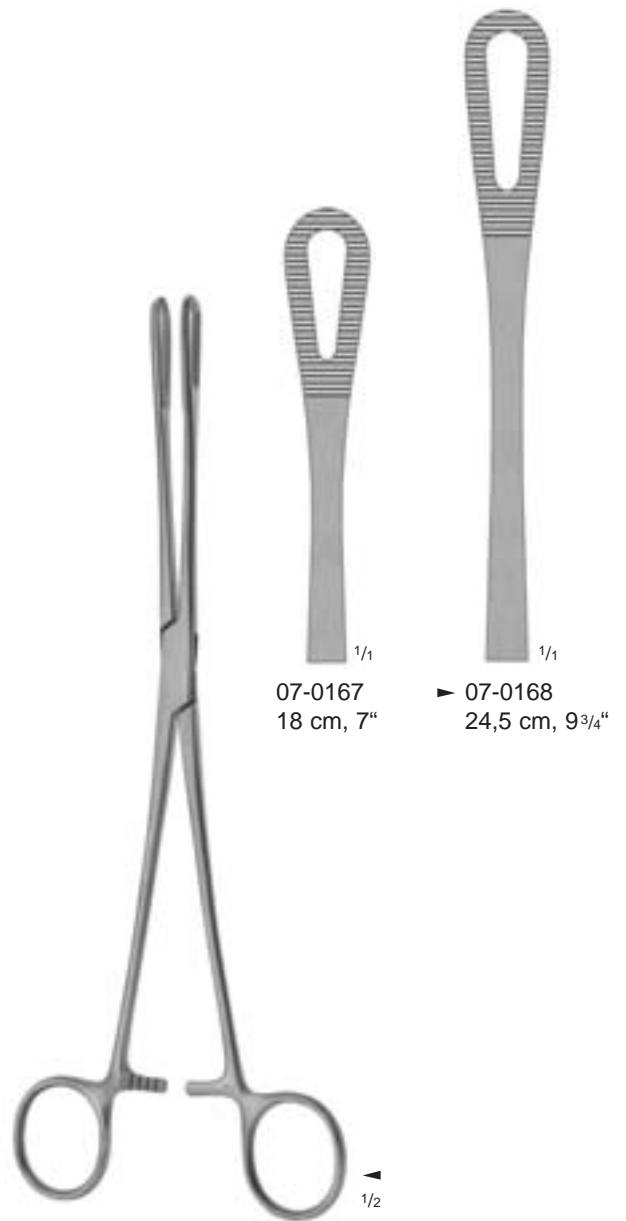

RAMPLEY
07-0167
- 07-0168

07-0167
18 cm, 7"

▶ 07-0168
24,5 cm, 9 3/4"

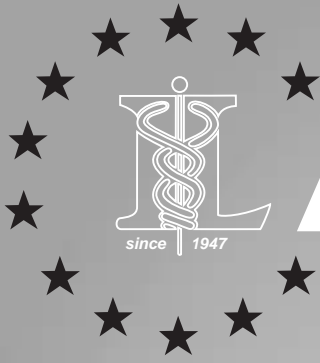

LAWNTON
Medizintechnik



Wundhaken
Retractors
Separadores
Ecarteurs
Divaricatori



Wundhäkchen
Retractors
Separadores
Ecarteurs
Divaricatori



1/2

68-1015
- 68-1028
15,5 cm, 6"

25°



1/1

SHAMBAUGH
68-1020 0,3 mm
68-1021 0,6 mm
▶ 68-1022 1,0 mm

45°



1/1

SHAMBAUGH
68-1023 0,3 mm
68-1024 0,6 mm
▶ 68-1025 1,0 mm

90°



1/1

SHAMBAUGH
68-1026 0,3 mm
68-1027 0,6 mm
▶ 68-1028 1,0 mm



1/1

68-1015 0,5 mm
▶ 68-1017 1,0 mm

Häkchen für die Mikrochirurgie
Hooks for micro surgery
Ganchos para la microcirugía
Crochets à microchirurgie
Crochet per microchirurgia



1/2

57-0860
18,5 cm, 7 1/4"

Durahäkchen
Dura retractor
Ganchito para dura-madre
Crochet pour la dure-mère
Uncino per dura-madre



1/2

FISCH
57-0861
18,5 cm, 7 1/4"

Durahäkchen
Dura retractor
Ganchito para dura-madre
Crochet pour la dure-mère
Uncino per dura-madre

ø 1,8 mm



1/2

57-0866
18 cm, 7"

Doppelkrallen zum Fassen und Anheben
von Haut und Gewebe

Double picks to grasp and lift skin and tissue

Doble garra para agarrar y alzar piel y tejido

Crochets doubles pour saisir et soulever la
peau, les tissus

Crochet doppio per afferrare e sollevare pelle e
tessuti

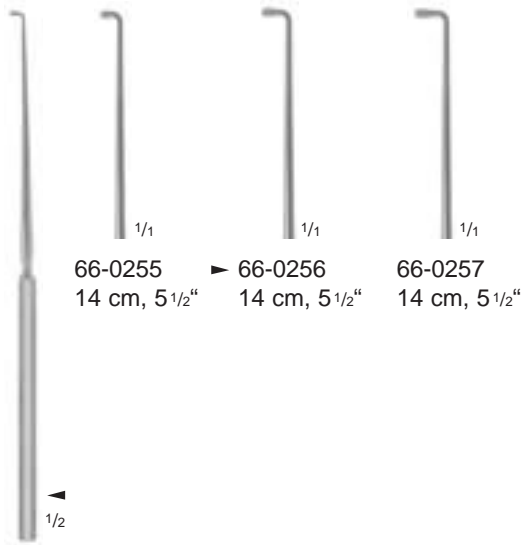

66-0255 14 cm, 5 1/2" ▶ 66-0256 14 cm, 5 1/2" 66-0257 14 cm, 5 1/2"

LUCAE
 66-0255
 - 66-0257

Ohrhäkchen
 Ear hooklets
 Ganchitos auriculares
 Crochets auriculaires
 Crochet auricolare

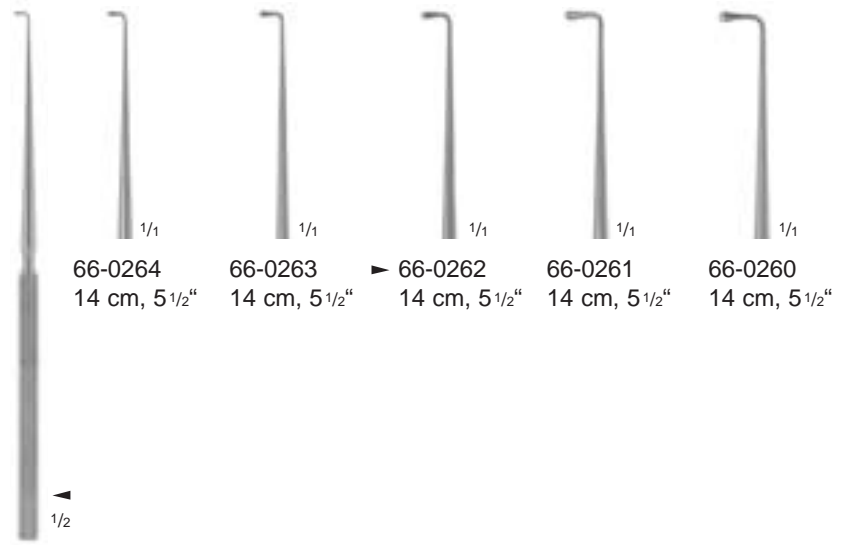

66-0264 14 cm, 5 1/2" 66-0263 14 cm, 5 1/2" ▶ 66-0262 14 cm, 5 1/2" 66-0261 14 cm, 5 1/2" 66-0260 14 cm, 5 1/2"

WAGENER
 66-0260
 - 66-0264

Ohrhäkchen
 Ear hooklets
 Ganchitos auriculares
 Crochets auriculaires
 Crochet auricolare

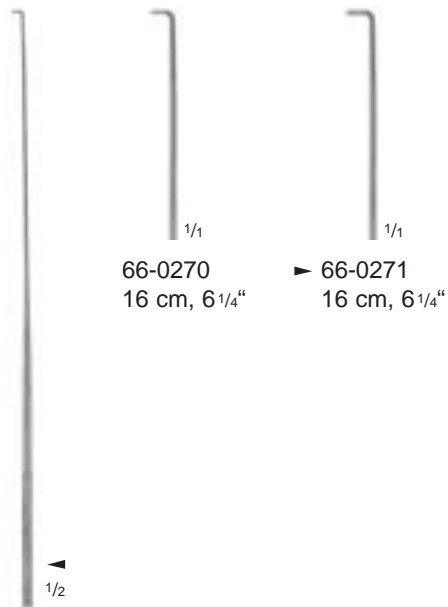

66-0270 16 cm, 6 1/4" ▶ 66-0271 16 cm, 6 1/4"

DAY
 66-0270
 - 66-0271

Ohrhäkchen
 Ear hooklets
 Ganchitos auriculares
 Crochets auriculaires
 Crochet auricolare

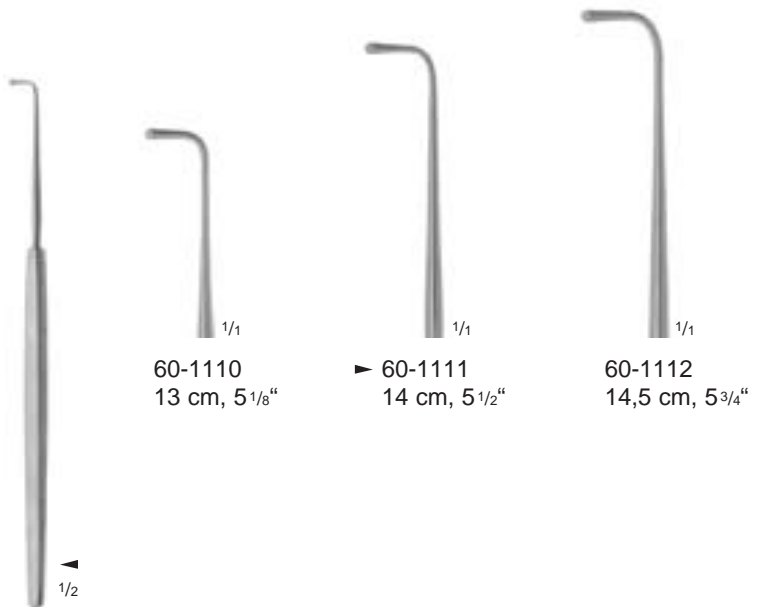

60-1110 13 cm, 5 1/8" ▶ 60-1111 14 cm, 5 1/2" 60-1112 14,5 cm, 5 3/4"

GRAEFE
 60-1110
 - 60-1112

Schielhaken
 Strabismus hooks
 Ganchos para estrabismo
 Crochets à strabisme
 Crochet per strabismo



Nerv- und Gefäßhäkchen
 Nerve and Vessel Hooks
 Ganchos para nervios y vasos
 Crochets à nerfs et à vaisseaux
 Uncini per nervi e vasi



DANDY
 51-0660
 21,5 cm, 8 1/2"
 gerade
 straight
 recto
 droit
 retti



DANDY
 51-0662
 21,5 cm, 8 1/2"
 links
 left
 izquierdo
 à gauche
 sinistro



DANDY
 51-0661
 21,5 cm, 8 1/2"
 rechts
 right
 derecho
 à droite
 destro

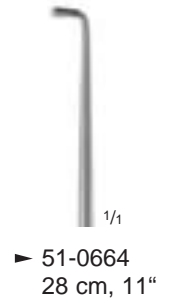

51-0664
 28 cm, 11"

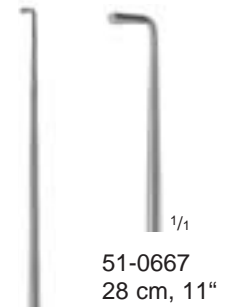

51-0667
 28 cm, 11"

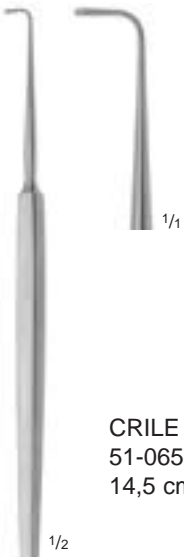

CRILE
 51-0657
 14,5 cm, 5 3/4"

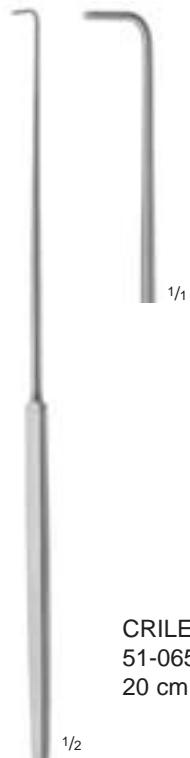

CRILE
 51-0658
 20 cm, 8"

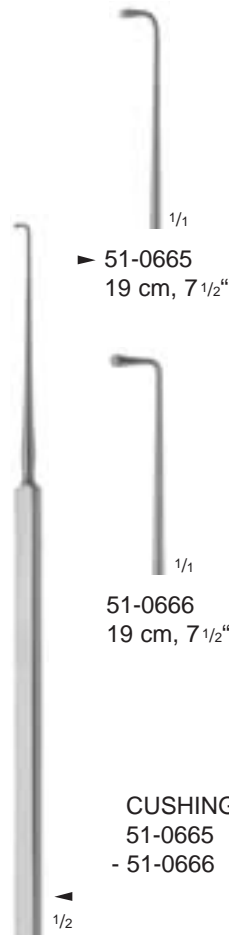

51-0665
 19 cm, 7 1/2"

51-0666
 19 cm, 7 1/2"

CUSHING
 51-0665
 - 51-0666



CUSHING
 51-0664
 - 51-0667

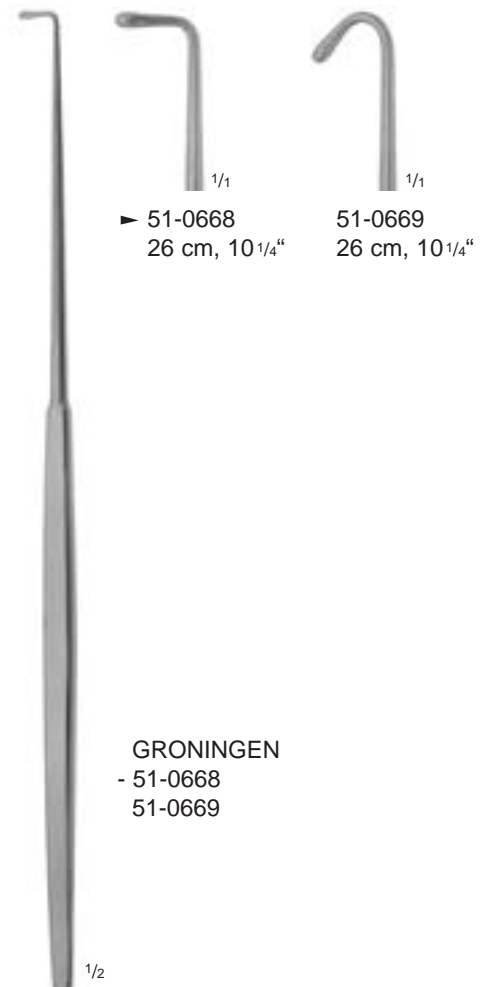
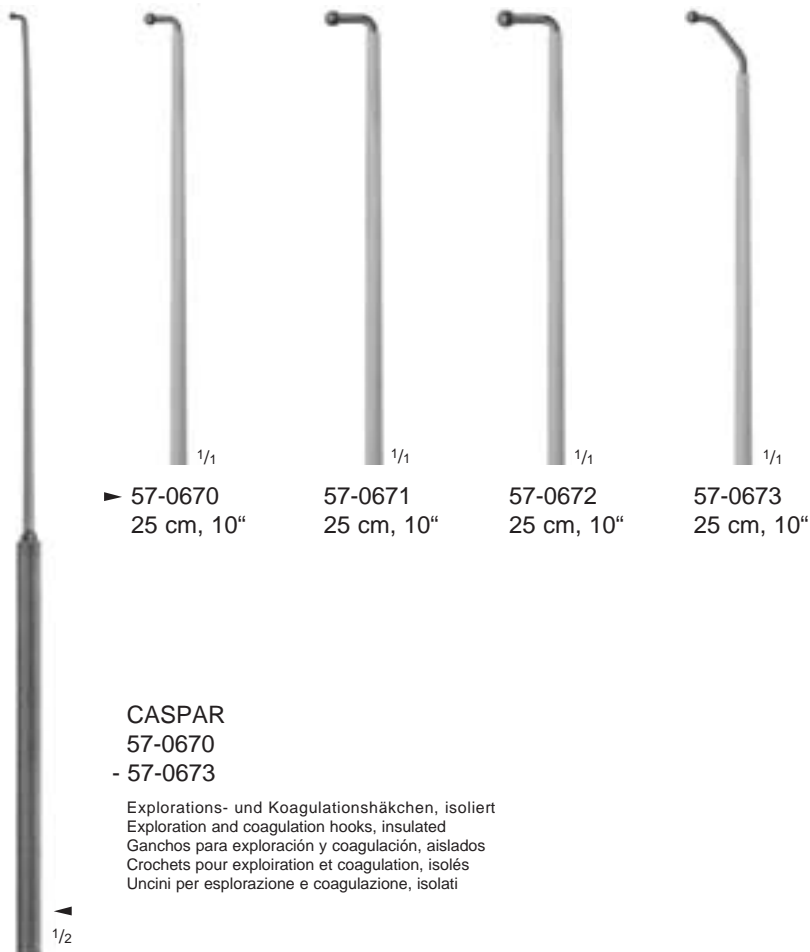
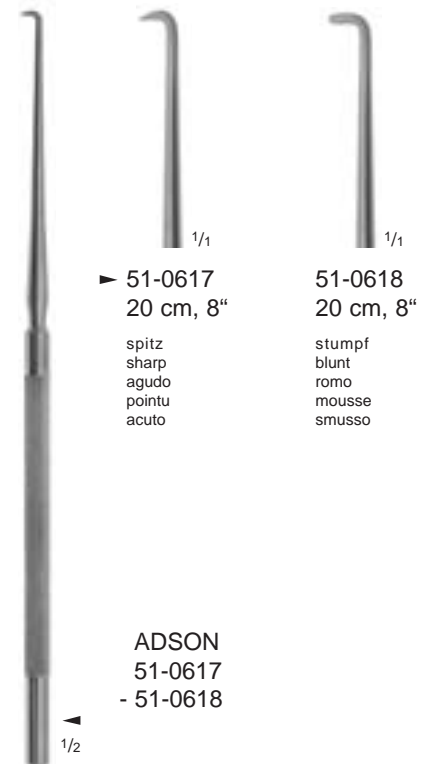
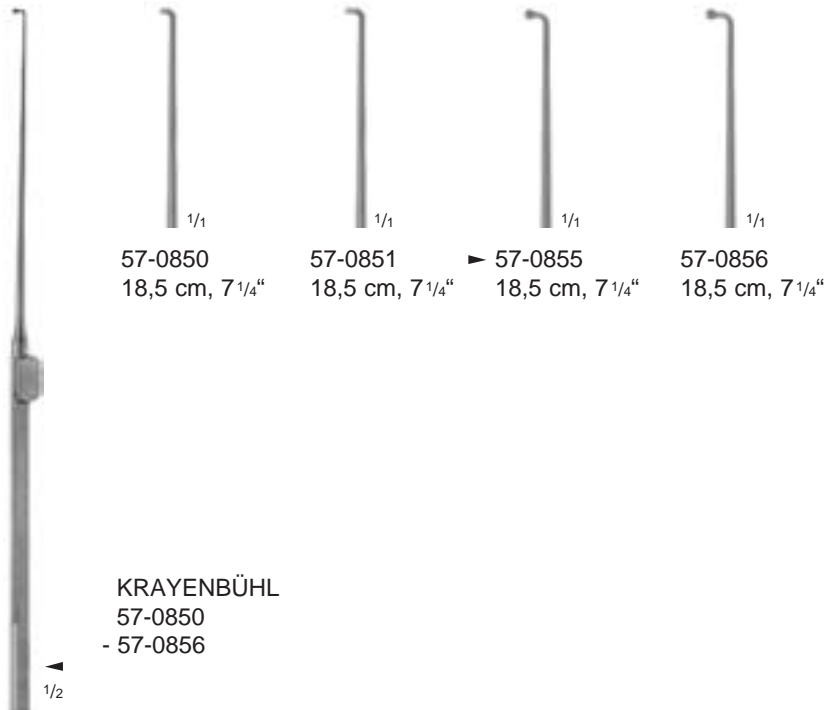



Wundhäkchen
Retractors
Separadores
Ecarteurs
Divaricatori



▶ 60-1215
12 cm, 4³/₄"

spitz
sharp
agudo
pointu
acuto

1/2

GRAEFE (TYRELL)

60-1215

- 60-1216

Hauthäkchen (Irishäkchen)
Skin retractors (iris hooks)
Ganchos para piel (gancho para iris)
Crochets à peau (Iris)
Divaricatori cutaneo (uncini per iride)



1/1



1/1

60-1216
12 cm, 4³/₄"

stumpf
blunt
romo
mousse
smusso



1/2

FRAZIER

51-0615

12,5 cm, 5"

Dura- und Hauthäkchen, spitz
Dura and skin retractor, sharp
Gancho para piel y dura-madre, agudo
Crochet à peau et à dure-mère, pointu
Divaricatore per pelle e dura-madre, acuto



1/1



1/2

KILNER

75-0220

13 cm, 5¹/₈"

Hauthäkchen, spitz
Skin retractor, sharp
Gancho para piel, agudo
Crochet à peau, pointu
Divaricatore cutaneo, acuto



1/1



1/2

KILNER

75-0218

15 cm, 6"

Hauthäkchen, spitz
Skin retractor, sharp
Gancho para piel, agudo
Crochet à peau, pointu
Divaricatore cutaneo, acuto



1/1



1/2

GILLIES

75-0215

18 cm, 7"

Hauthäkchen, spitz
Skin retractor, sharp
Gancho para piel, agudo
Crochet à peau, pointu
Divaricatore cutaneo, acuto



1/1



1/2

GILLIES (CONVERSE)

75-0221

- 75-0222

Dura- und Hauthäkchen, spitz
Dura and skin retractors, sharp
Ganchos para piel y dura-madre, agudo
Crochets à peau et à dure-mère, pointus
Divaricatori per pelle e dura-madre, acuto



1/1

▶ 75-0221
18,5 cm, 7¹/₄"



1/1

75-0222
18,5 cm, 7¹/₄"



MOLDESTAD
 30-0100
 12 cm, 4 3/4"

Venenhaken
 Vein retractor
 Separador para venas
 Ecarteur à veines
 Divaricatore per vene

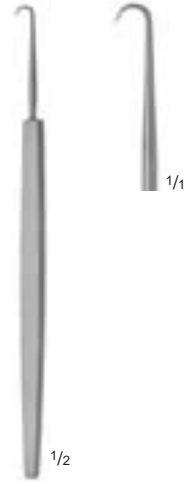

O'CONNOR
 60-1260
 12,5 cm, 5"

Hauthäkchen (Irishäkchen), spitz
 Skin retractor (iris hook), sharp
 Gancho para piel (gancho para iris), agudo
 Crochet à peau (Iris), pointu
 Uncino cutaneo (uncino per iride), acuto

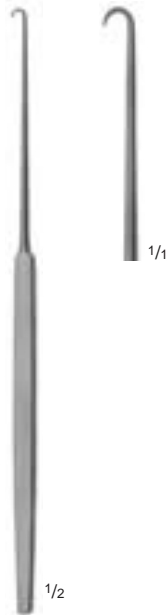

COTTLE
 51-0612
 16 cm, 6 1/4"

Dura- und Hauthäkchen, spitz
 Dura and skin retractor, sharp
 Gancho para piel y dura-madre, agudo
 Crochet à peau et à dure-mère, pointu
 Uncino per pelle e dura-madre, acuto

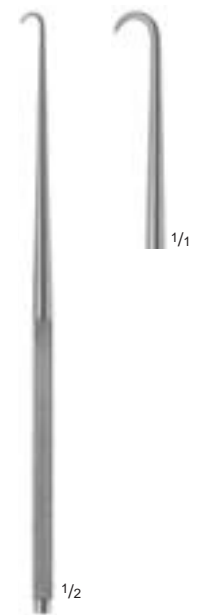

JOSEPH
 75-0330
 16 cm, 6 1/4"

Häkchen für plastische Chirurgie, spitz
 Hook for plastic surgery, sharp
 Gancho para cirugía plástica, agudo
 Crochet pour la chirurgie plastique, pointu
 Uncino per chirurgia plastica, acuto



GRAHAM
 51-0610
 17 cm, 6 3/4"

Durahäkchen, stumpf
 Dura hook, blunt
 Gancho para dura-madre, romo
 Crochet pour la dure-mère, mousse
 Uncino per dura-madre, smusso



SACHS
 51-0613
 18,5 cm, 7 1/4"

Durahäkchen, spitz
 Dura hook, sharp
 Gancho para dura-madre, agudo
 Crochet pour la dure-mère, pointu
 Uncino per dura-madre, acuto



NEWS
 87-0135
 14,5 cm, 5 3/4"

Trachealhäkchen, spitz
 Trachea retractor, sharp
 Separador para la tráquea, agudo
 Ecarteur pour trachéotomie, pointu
 Uncino tracheale, acuto

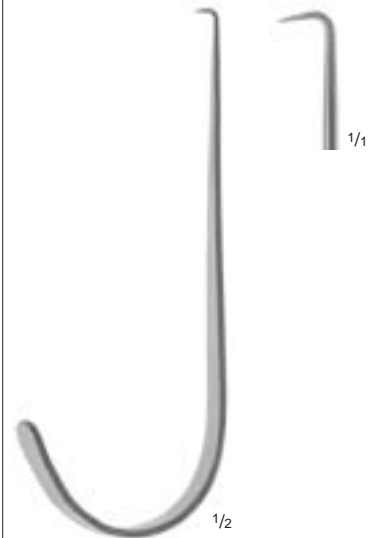

JACKSON
 87-0140
 14 cm, 5 1/2"

Trachealhäkchen, spitz
 Trachea retractor, sharp
 Separador para la tráquea, agudo
 Ecarteur pour trachéotomie, pointu
 Uncino tracheale, acuto



Wundhäkchen
Retractors
Separadores
Ecarteurs
Divaricatori

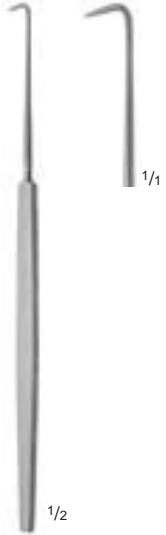

CUSHING
51-0600
14 cm, 5 1/2"

Durahäkchen, spitz
Dura hook, sharp
Gancho para dura-madre, agudo
Crochet pour la dure-mère, pointu
Uncino per dura-madre, acuto



COTTLE
75-0400
17 cm, 6 3/4"

Häkchen für plastische Chirurgie, spitz
Hook for plastic surgery, sharp
Gancho para cirugía plástica, agudo
Crochet pour la chirurgie plastique, pointu
Uncino per chirurgia plastica, acuto

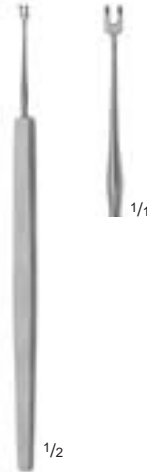

GUTHRIE
60-1221
12,5 cm, 5"

Hauthäkchen (Irishäkchen), spitz
Skin retractor (iris hook), sharp
Gancho para piel (gancho para iris), agudo
Crochet à plaies (Iris), pointu
Divaricatore cutaneo (uncino per iride), acuto

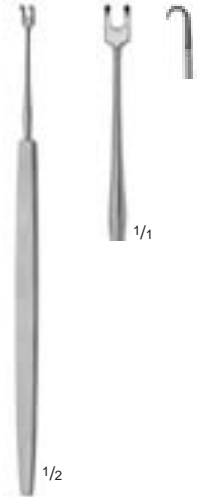

GUTHRIE
60-1220
13 cm, 5 1/8"

Hauthäkchen (Irishäkchen), spitz
Skin retractor (iris hook), sharp
Gancho para piel (gancho para iris), agudo
Crochet à plaies (Iris), pointu
Divaricatore cutaneo (uncino per iride), acuto

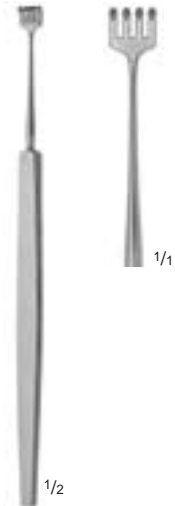

ROLLET
20-0100
13,5 cm, 5 1/4"

spitz
sharp
agudo
pointu
acuto

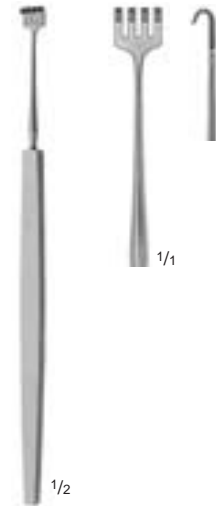

KNAPP
20-0101
13,5 cm, 5 1/4"

stumpf
blunt
romo
mousse
smusso

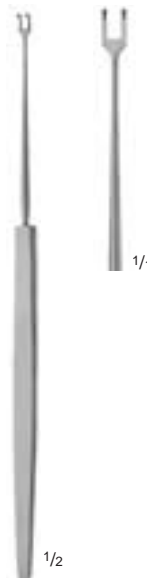

FREER
75-0325
15 cm, 6"

spitz
sharp
agudo
pointu
acuto

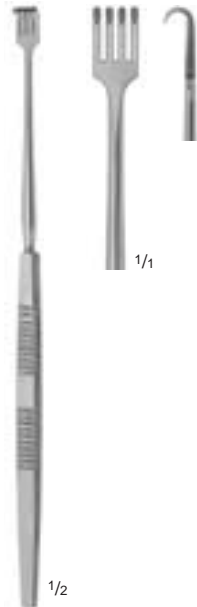

KNAPP
20-0105
16 cm, 6 1/4"

spitz
sharp
agudo
pointu
acuto

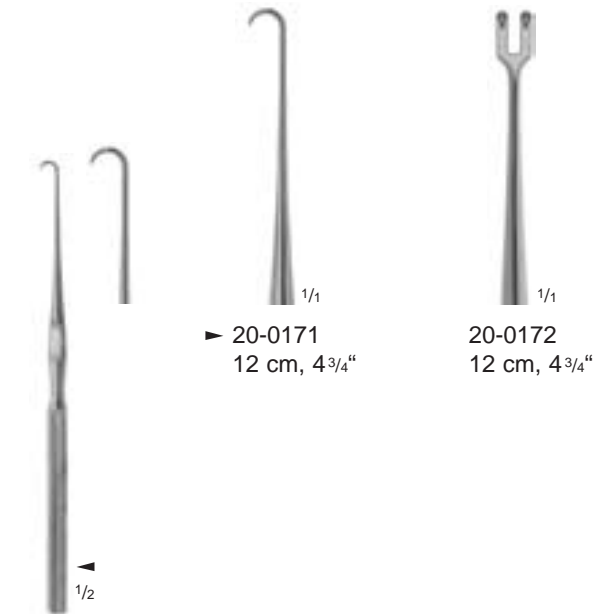

▶ 20-0171
12 cm, 4³/₄"

20-0172
12 cm, 4³/₄"

LAHEY
20-0171
- 20-0172

spitz
sharp
agudo
pointu
acuto

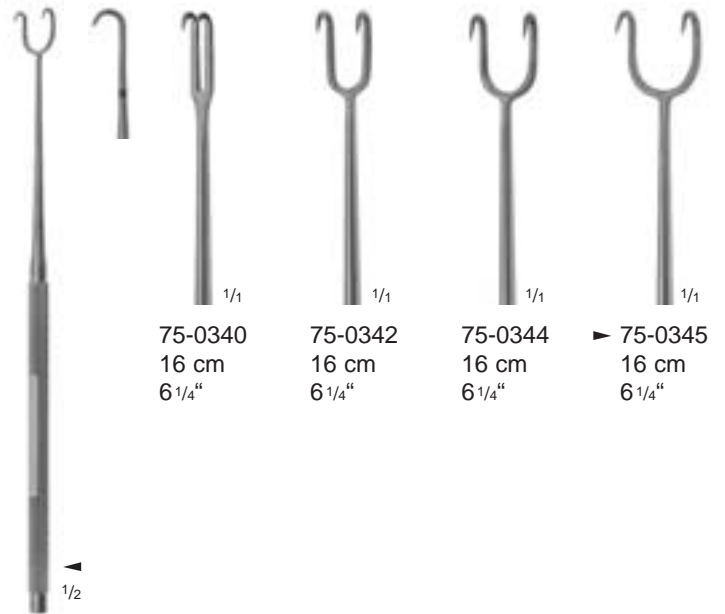

75-0340
16 cm
6¹/₄"

75-0342
16 cm
6¹/₄"

75-0344
16 cm
6¹/₄"

▶ 75-0345
16 cm
6¹/₄"

JOSEPH
75-0340
- 75-0345

Häkchen für plastische Chirurgie, spitz
Hooks for plastic surgery, sharp
Ganchos para cirugía plástica, agudos
Crochets pour la chirurgie plastique, pointu
Uncini per chirurgia plastica, acuti

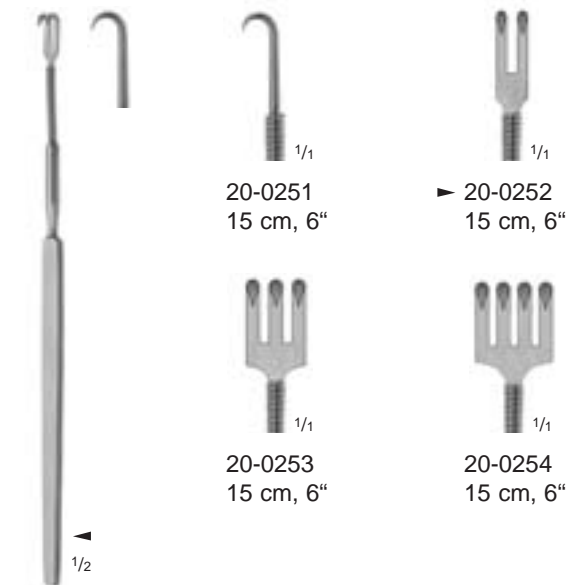

20-0251
15 cm, 6"

▶ 20-0252
15 cm, 6"

20-0253
15 cm, 6"

20-0254
15 cm, 6"

20-0251
- 20-0254

Trachealhäkchen, spitz / flexibel
Trachea retractors, sharp / flexible
Separadores para la tráquea, agudos / flexibles
Ecarteurs pour trachéotomie, pointu / flexible
Uncini tracheali, acuti / flessibili

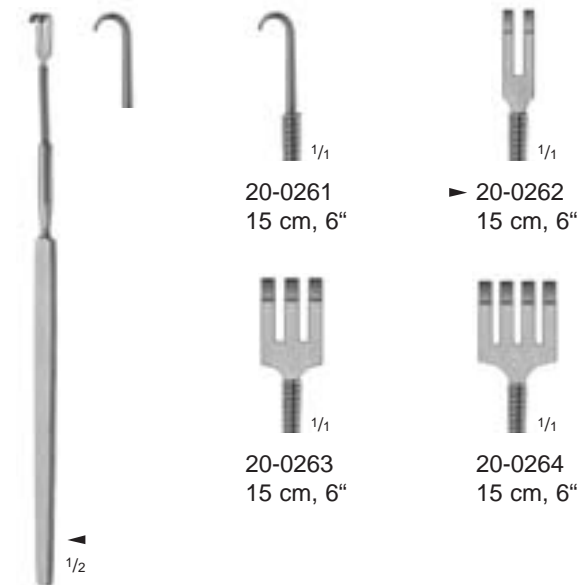

20-0261
15 cm, 6"

▶ 20-0262
15 cm, 6"

20-0263
15 cm, 6"

20-0264
15 cm, 6"

20-0261
- 20-0264

Trachealhäkchen, stumpf / flexibel
Trachea retractors, blunt / flexible
Separadores para la tráquea, romos / flexibles
Ecarteurs pour trachéotomie, mousse / flexible
Uncini tracheali, smussi / flessibili



Wundhäkchen
Retractors
Separadores
Ecarteurs
Divaricatori

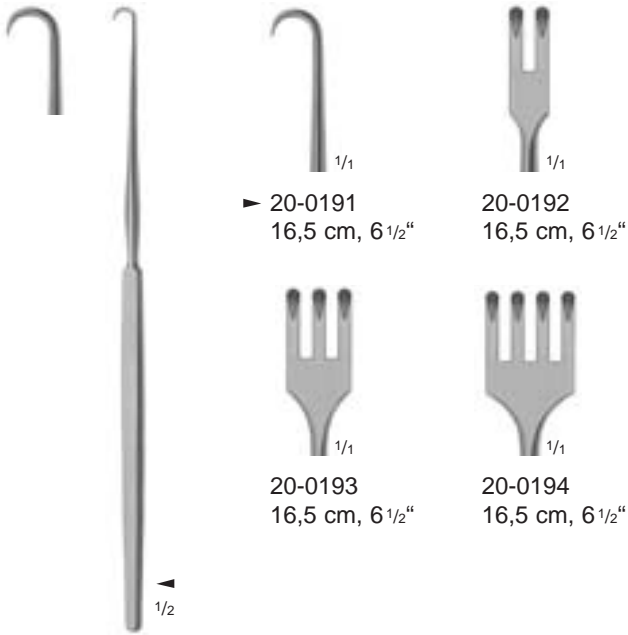

20-0191
- 20-0194

Trachealhäkchen, spitz
Trachea retractors, sharp
Separadores para la tráquea, agudos
Ecarteurs pour trachéotomie, pointu
Uncini tracheali, acuti

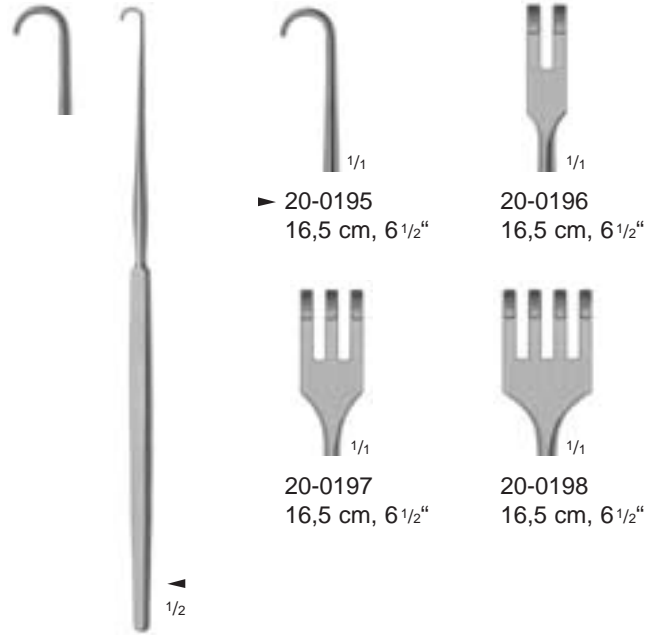

20-0195
- 20-0198

Trachealhäkchen, stumpf
Trachea retractors, blunt
Separadores para la tráquea, romos
Ecarteurs pour trachéotomie, mousse
Uncini tracheali, smussi

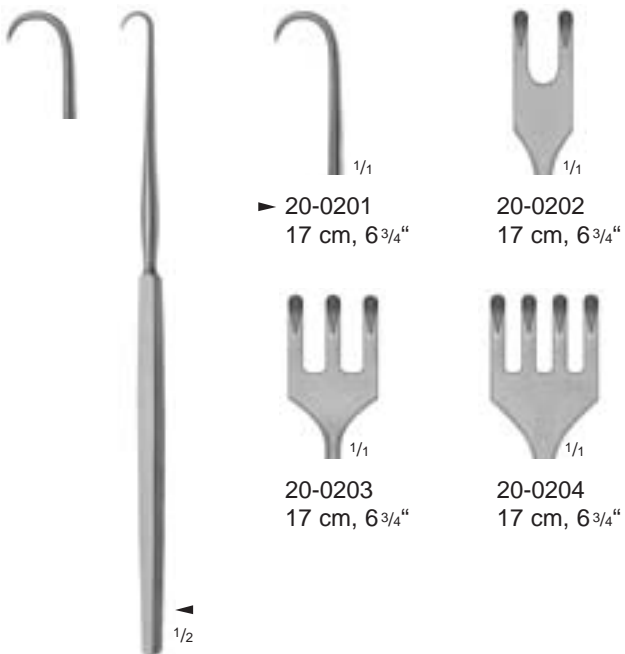

20-0201
- 20-0204

Trachealhäkchen, spitz
Trachea retractors, sharp
Separadores para la tráquea, agudos
Ecarteurs pour trachéotomie, pointu
Uncini tracheali, acuti

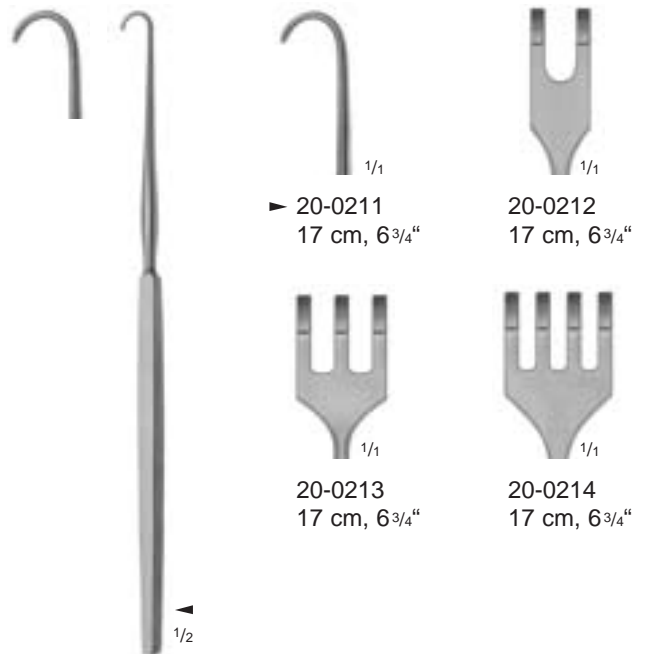

20-0211
- 20-0214

Trachealhäkchen, stumpf
Trachea retractors, blunt
Separadores para la tráquea, romos
Ecarteurs pour trachéotomie, mousse
Uncini tracheali, smussi



SACHS
 51-0650
 21,5 cm, 8 1/2"
 Fistelhaken
 Fistula hook
 Gancho para fistulas
 Crochet pour fistules
 Uncino per fistole



EMMET
 96-0251
 22 cm, 8 3/4"
 Fistelhaken
 Fistula hook
 Gancho para fistulas
 Crochet pour fistules
 Uncino per fistole

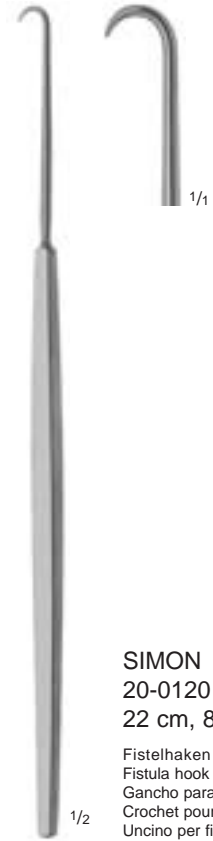

SIMON
 20-0120
 22 cm, 8 3/4"
 Fistelhaken
 Fistula hook
 Gancho para fistulas
 Crochet pour fistules
 Uncino per fistole



FOMON
 75-0430
 16 cm, 6 1/4"
 Choanenhook
 Hook for posterior nares
 Gancho para las coanas
 Crochet nasal
 Uncino per narici posteriori



FOMON
 75-0435
 16 cm, 6 1/4"
 Nasenflügelhaken
 Hook for posterior nares
 Gancho para las coanas
 Crochet nasal
 Uncino per narici posteriori



COTTLE-NEIVERT
 75-0412
 20,5 cm, 8"
 Nasenflügelhaken mit Säge- oder
 Messerführung
 Hook for posterior nares with saw
 or knife guide
 Gancho para las coanas con guía
 para sierra o para cuchillo
 Crochet nasal avec scie ou couteau
 guides
 Uncino per narici posteriori con guida
 per lama o coltello



Wundhaken
Retractors
Separadores
Ecarteurs
Divaricatori

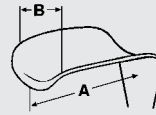

60-1208
4,5 x 8 mm (AxB)



60-1199
9 x 10 mm (AxB)



60-1200
9 x 12 mm (AxB)



60-1201
11 x 14 mm (AxB)



▶ 60-1202
12 x 16 mm (AxB)



60-1203
13 x 18 mm (AxB)



1/2

DESMARRES

60-1199
- 60-1208
14 cm, 5 1/2"

Venenhaken (Lidhalter)
Vein retractors (lid retractors)
Separadores para venas
(separadores para párpados)
Ecarteurs à veines
(releveurs de paupières)
Divaricatori per vene
(Divaricatori palpebra)



30-0040
4,5 x 8 mm (AxB)



30-0041
9 x 10 mm (AxB)



30-0042
9 x 12 mm (AxB)



30-0043
11 x 14 mm (AxB)



▶ 30-0044
12 x 16 mm (AxB)



30-0045
13 x 18 mm (AxB)



1/2

CUSHING

30-0040
- 30-0045
20 cm, 8"

Venenhaken
Vein retractors
Separadores para venas
Ecarteurs à veines
Divaricatori per vene



30-0090
4,5 x 8 mm (AxB)



30-0091
9 x 10 mm (AxB)



30-0092
9 x 12 mm (AxB)



30-0093
11 x 14 mm (AxB)



▶ 30-0094
12 x 16 mm (AxB)



30-0095
13 x 18 mm (AxB)



1/2

CUSHING

30-0090
- 30-0095
24 cm, 9 1/2"

Venenhaken
Vein retractors
Separadores para venas
Ecarteurs à veines
Divaricatori per vene

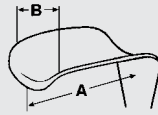

CUSHING
 20-0495
 22,5 cm, 9"

Venenhaken
 Vein retractor
 Separador para venas
 Ecarteur à veines
 Divaricatore per vene



KIRKLIN
 30-0135
 - 30-0139
 13,5 cm, 5 1/4"

Venenhaken , biegsam
 Vein retractors , malleable
 Separadores para venas, maleables
 Ecarteurs à veines, malléables
 Divaricatori per veni, malleabili

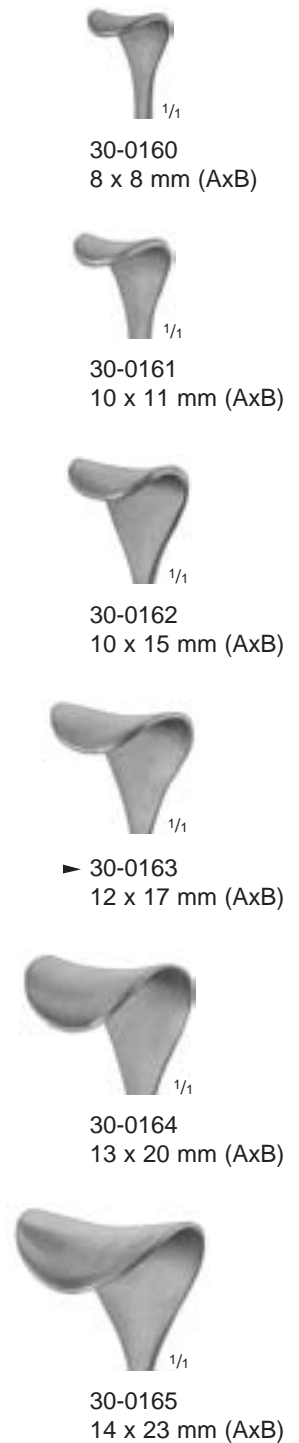

MARBERGER (GIL-VERNET)
 30-0160
 - 30-0165
 24 cm, 9 1/2"

Venen- und Hilushaken, biegsam
 Vein and hilar retractors, malleable
 Separadores para venas y hilaes, maleables
 Ecarteurs à veines et à hile rénal, malléables
 Divaricatori per veni e hilus, malleabili



Wundhaken
Retractors
Separadores
Ecarteurs
Divaricatori

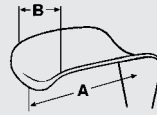

▶ 20-0102
10 x 6 mm (AxB)



20-0103
20 x 6 mm (AxB)

1/2

SENN-GREEN
20-0102
- 20-0103
16 cm, 6 1/4"



▶ 20-0106
10 x 6 mm (AxB)

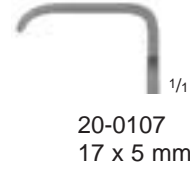

20-0107
17 x 5 mm (AxB)

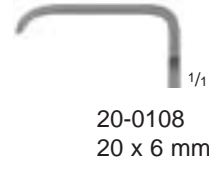

20-0108
20 x 6 mm (AxB)

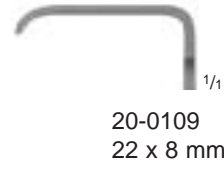

20-0109
22 x 8 mm (AxB)

1/2

MINI-LANGENBECK
20-0106
- 20-0109
16 cm, 6 1/4"



▶ 20-0110
16 x 5 mm (AxB)



20-0111
18 x 5 mm (AxB)



20-0112
25 x 6 mm (AxB)

1/2

MOBERG
20-0110
- 20-0112
17,5 cm, 7"

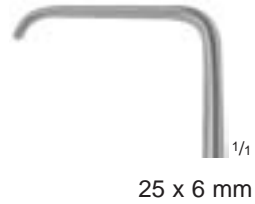

25 x 6 mm (AxB)

1/2

LAHEY
12-0340
20 cm, 8"
Kropfwundhaken
Goitre retractor
Separador para bocio
Ecarteur à goitre
Divaricatore per gozzo

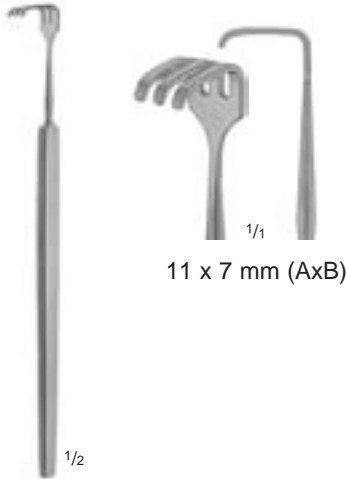
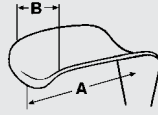

PAUL
 63-2965
 12,5 cm, 5"

Sehnscheidenhaken
 Tendon sheath retractor
 Separador para vainas tendinosas
 Ecarteur à gaines tendineuses
 Divaricatori per guaina tendinea

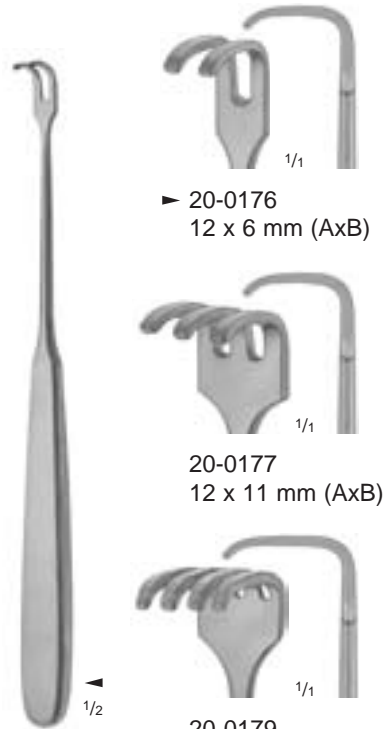

KLAPP
 20-0176
 - 20-0179
 17,5 cm, 7"

Sehnscheidenhaken
 Tendon sheath retractors
 Separadores para vainas tendinosas
 Ecarteurs à gaines tendineuses
 Divaricatori per guaina tendinea

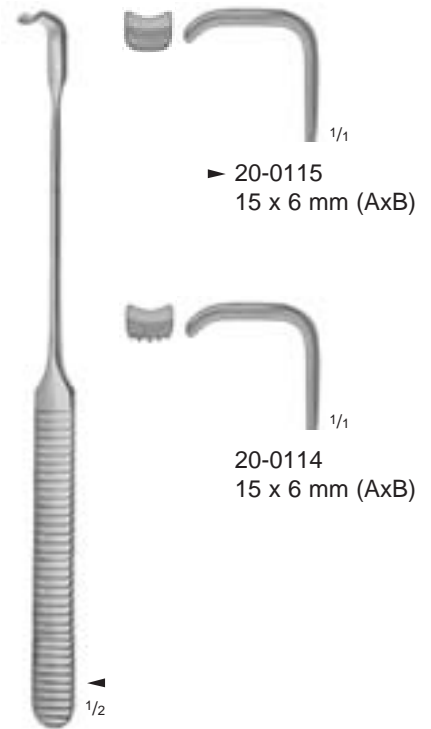

STRANDELL-STILLE
 20-0114
 - 20-0115
 19 cm, 7 1/2"

Sehnscheidenhaken
 Tendon sheath retractors
 Separadores para vainas tendinosas
 Ecarteurs à gaines tendineuses
 Divaricatori per guaina tendinea

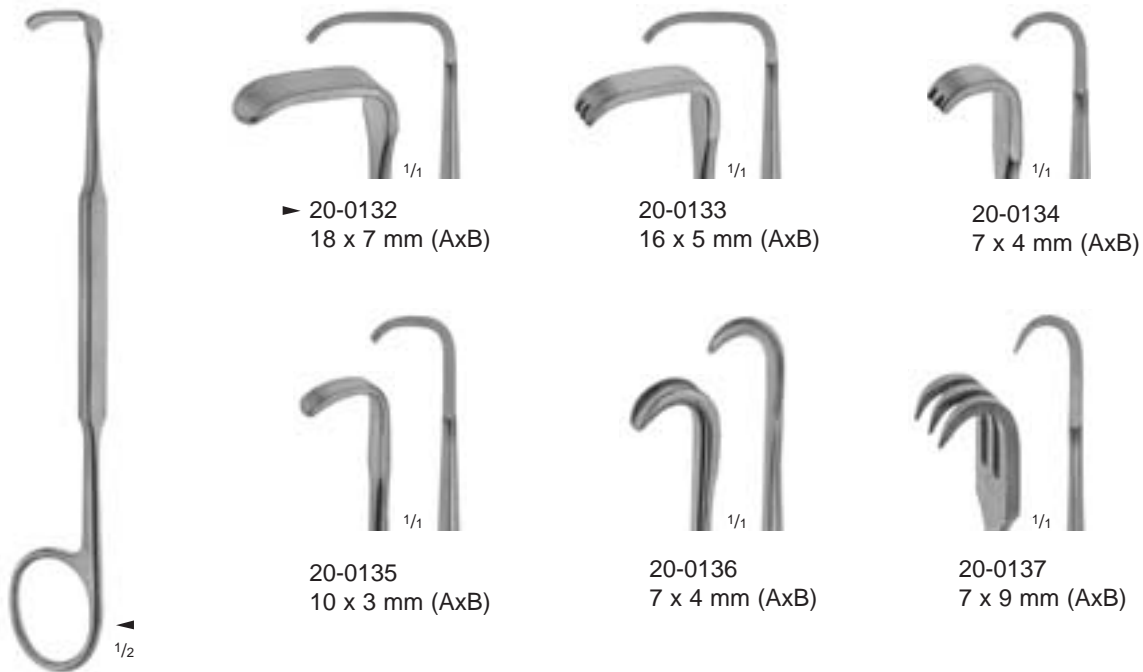

MEYERDING
 20-0132
 - 20-0137
 17,5 cm, 7"



Wundhaken, doppelendig
 Retractors, double-ended
 Separadores, dobles
 Ecarteurs doubles
 Divaricatori, doppi

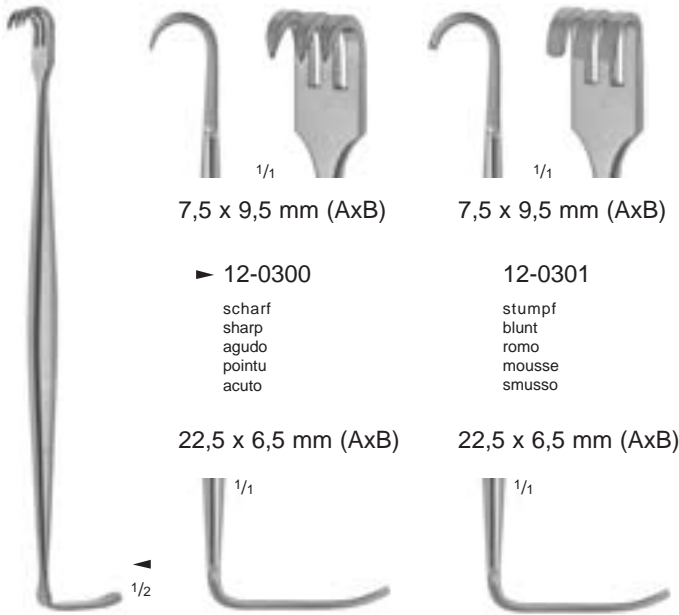
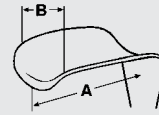

7,5 x 9,5 mm (AxB)

7,5 x 9,5 mm (AxB)

▶ 12-0300

scharf
 sharp
 agudo
 pointu
 acuto

12-0301

stumpf
 blunt
 romo
 mousse
 smusso

22,5 x 6,5 mm (AxB)

22,5 x 6,5 mm (AxB)

SENN-MILLER
 12-0300
 - 12-0301
 16 cm, 6 1/4"

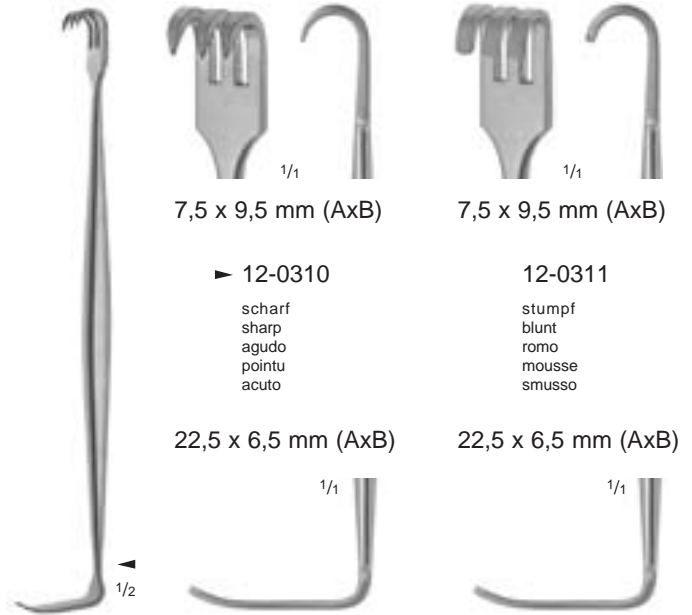

7,5 x 9,5 mm (AxB)

7,5 x 9,5 mm (AxB)

▶ 12-0310

scharf
 sharp
 agudo
 pointu
 acuto

12-0311

stumpf
 blunt
 romo
 mousse
 smusso

22,5 x 6,5 mm (AxB)

22,5 x 6,5 mm (AxB)

MATHIEU
 12-0310
 - 12-0311
 16 cm, 6 1/4"



8 x 3 mm (AxB)

15 x 5 mm (AxB)

RAGNELL-DAVIS
 75-0620
 15 cm, 6"

Haken für plastische Chirurgie
 Hook for plastic surgery
 Gancho para cirugía plástica
 Ecarteur pour la chirurgie plastique
 Divaricatore per chirurgia plastica

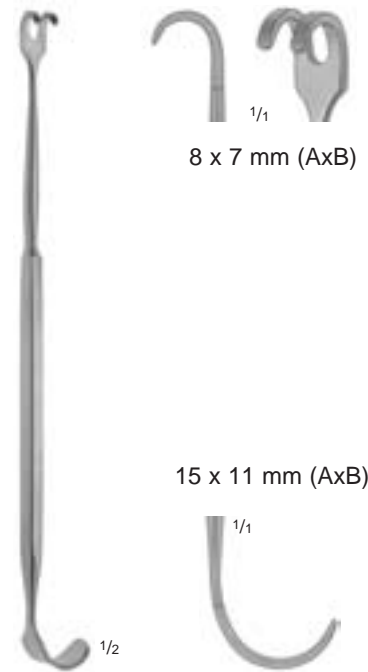

8 x 7 mm (AxB)

15 x 11 mm (AxB)

JACKSON
 87-0200
 17,5 cm, 7"

Tracheal-Haken
 Trachea retractor
 Separador para la tráquea
 Ecarteur pour la trachée
 Divaricatore per trachea

Wundhaken, doppelendig
 Retractors, double-ended
 Separadores, dobles
 Ecarteurs doubles
 Divaricatori, doppi

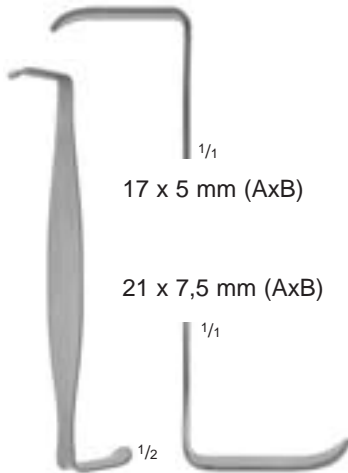
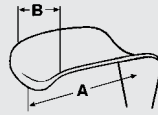

$17 \times 5 \text{ mm (Ax B)}$
 $21 \times 7,5 \text{ mm (Ax B)}$

CRILE
 12-0350
 10,5 cm, 4 1/8"

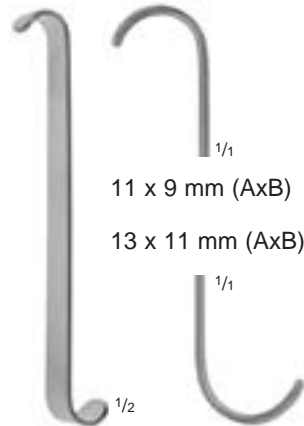

$11 \times 9 \text{ mm (Ax B)}$
 $13 \times 11 \text{ mm (Ax B)}$

LUER
 12-0352
 11 cm, 4 3/8"

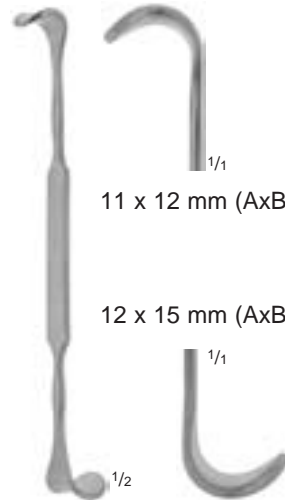

$11 \times 12 \text{ mm (Ax B)}$
 $12 \times 15 \text{ mm (Ax B)}$

ROSE
 12-0354
 13 cm, 5 1/8"

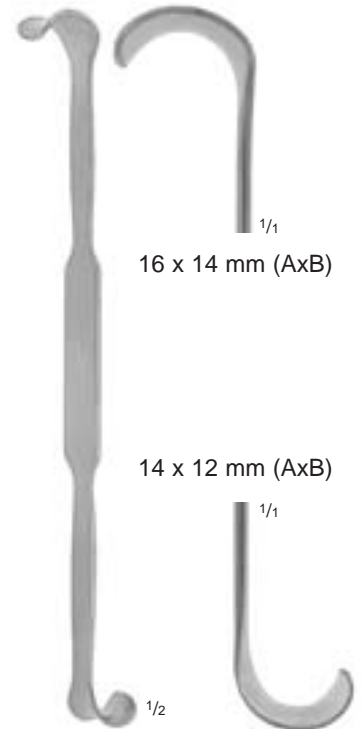

$16 \times 14 \text{ mm (Ax B)}$
 $14 \times 12 \text{ mm (Ax B)}$

ROSE
 12-0355
 19 cm, 7 1/2"

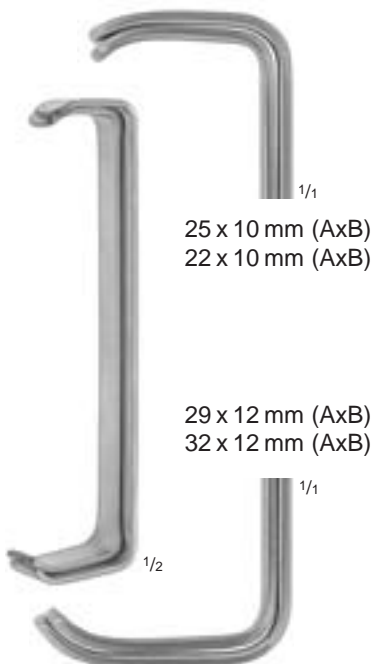

$25 \times 10 \text{ mm (Ax B)}$
 $22 \times 10 \text{ mm (Ax B)}$
 $29 \times 12 \text{ mm (Ax B)}$
 $32 \times 12 \text{ mm (Ax B)}$

FARABEUF
 20-0431
 12,5 cm, 5"
 Satz • Set • Juego • Jeu • Serie

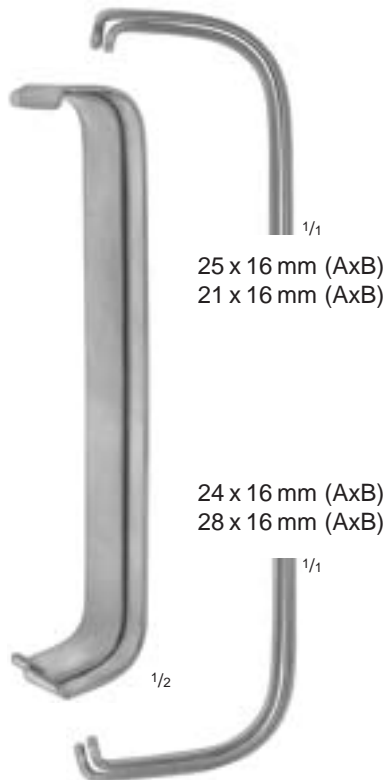

$25 \times 16 \text{ mm (Ax B)}$
 $21 \times 16 \text{ mm (Ax B)}$
 $24 \times 16 \text{ mm (Ax B)}$
 $28 \times 16 \text{ mm (Ax B)}$

FARABEUF
 20-0430
 15,5 cm, 6"
 Satz • Set • Juego • Jeu • Serie

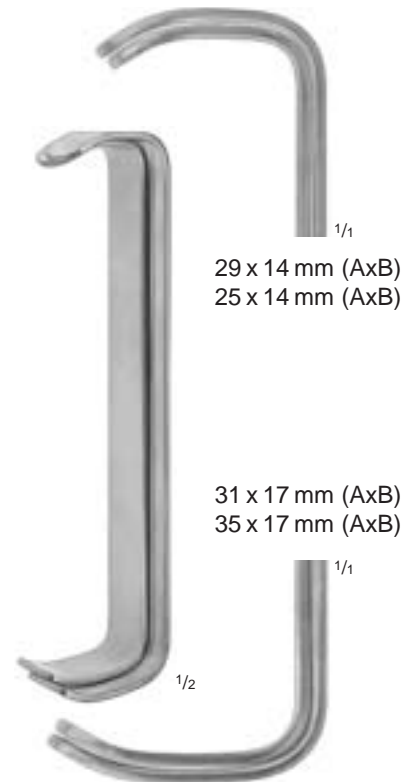

$29 \times 14 \text{ mm (Ax B)}$
 $25 \times 14 \text{ mm (Ax B)}$
 $31 \times 17 \text{ mm (Ax B)}$
 $35 \times 17 \text{ mm (Ax B)}$

COLLIN
 20-0402
 14,5 cm, 5 3/4"
 Satz • Set • Juego • Jeu • Serie



Wundhaken, doppelendig
 Retractors, double-ended
 Separadores, dobles
 Ecarteurs doubles
 Divaricatori, doppi

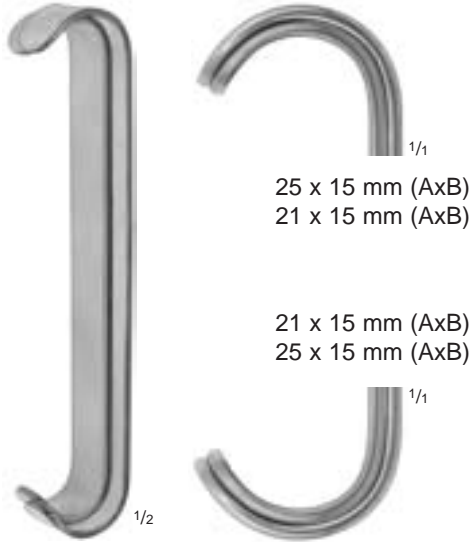
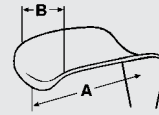

^{1/1}
 25 x 15 mm (AxB)
 21 x 15 mm (AxB)

21 x 15 mm (AxB)
 25 x 15 mm (AxB)

^{1/2}
PARKER
 20-0460
 14 cm, 5 1/2"

Satz • Set • Juego • Jeu • Serie

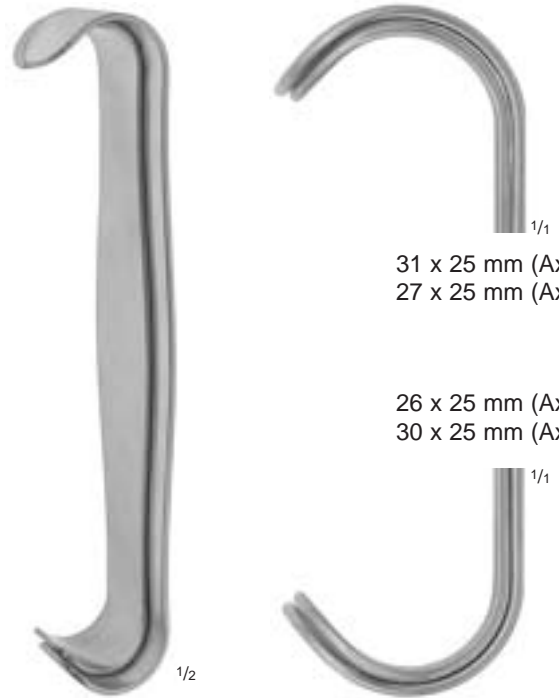

^{1/1}
 31 x 25 mm (AxB)
 27 x 25 mm (AxB)

26 x 25 mm (AxB)
 30 x 25 mm (AxB)

^{1/2}
PARKER
 20-0465
 18 cm, 7"

Satz • Set • Juego • Jeu • Serie

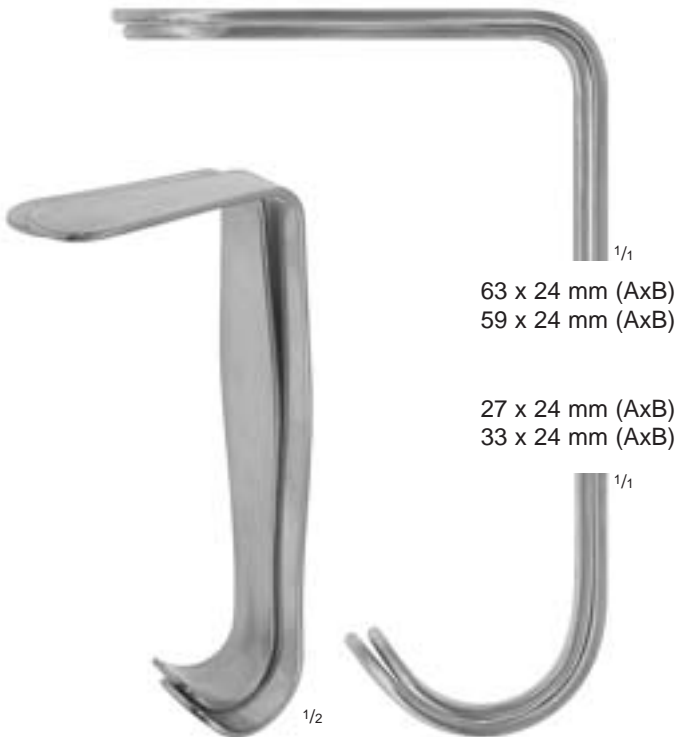

^{1/1}
 63 x 24 mm (AxB)
 59 x 24 mm (AxB)

27 x 24 mm (AxB)
 33 x 24 mm (AxB)

^{1/2}
PARKER-MOTT
 20-0470
 14,5 cm, 5 3/4"

Satz • Set • Juego • Jeu • Serie

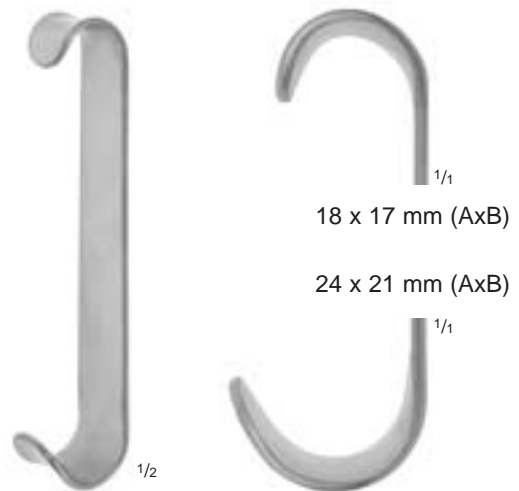

^{1/1}
 18 x 17 mm (AxB)

24 x 21 mm (AxB)

^{1/2}
BABY-ROUX
 20-0415
 12,5 cm, 5"

Wundhaken, doppelendig
 Retractors, double-ended
 Separadores, dobles
 Ecarteurs doubles
 Divaricatori, doppi

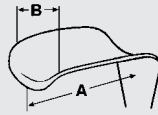

ROUX
 ▶ 20-0410
 17 cm, 6³/₄"

Satz, Fig. 1 - 3 • Set, fig. 1 - 3 • Juego, fig. 1 - 3 • Jeu, fig. 1 - 3 • Serie, fig. 1 - 3



21 x 24 mm (Ax B)

20-0411
 14,5 cm, 5³/₄"

29 x 28 mm (Ax B)



Fig. 1



27 x 26 mm (Ax B)

20-0412
 15,5 cm, 6"

32 x 37 mm (Ax B)



Fig. 2



31 x 30 mm (Ax B)

20-0413
 17 cm, 6³/₄"

36 x 42 mm (Ax B)



Fig. 3

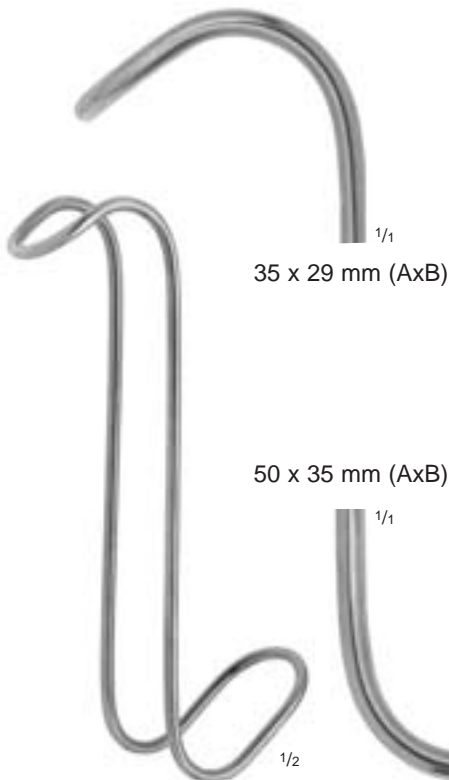

COLLIN - HARTMANN
 20-0406
 15,5 cm, 6"

35 x 29 mm (Ax B)

50 x 35 mm (Ax B)

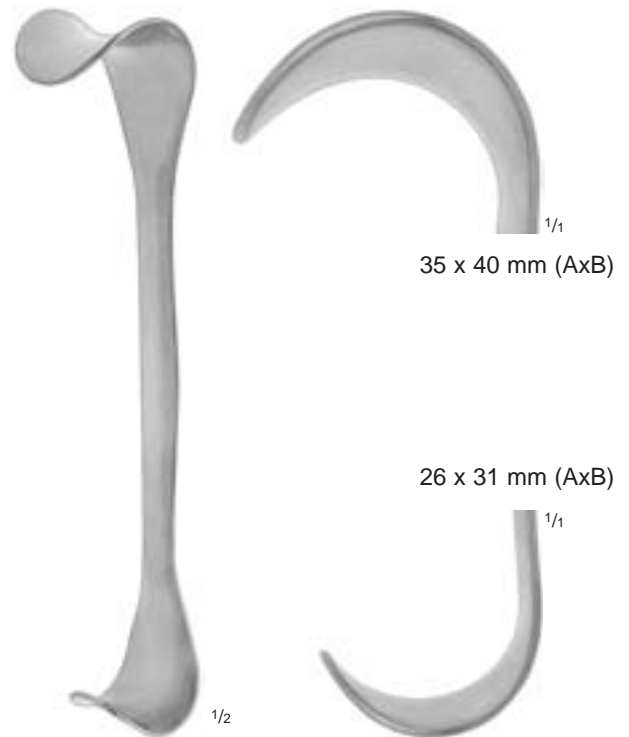

GOELET
 20-0490
 19 cm, 7¹/₂"

35 x 40 mm (Ax B)

26 x 31 mm (Ax B)



Wundhaken, doppelendig
Retractors, double-ended
Separadores, dobles
Ecarteurs doubles
Divaricatori, doppi

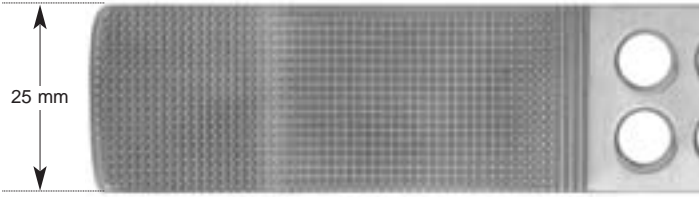

25 mm

20-0440
125 / 175 x 25 mm

1/1

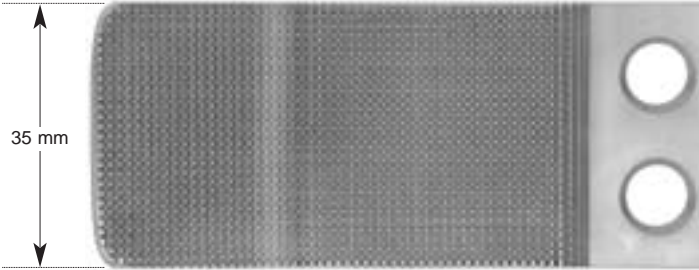

35 mm

▶ 20-0442
125 / 175 x 35 mm

1/1

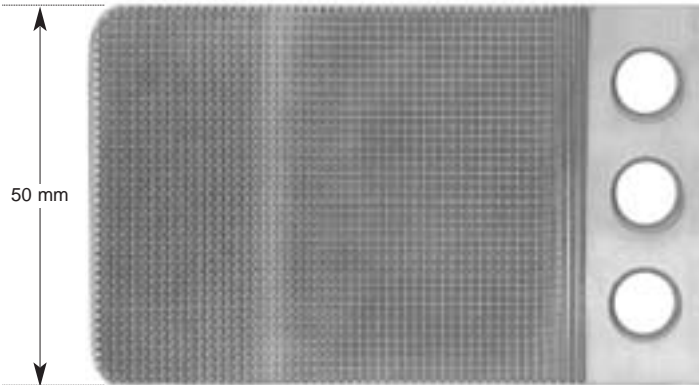

50 mm

20-0444
125 / 175 x 50 mm

1/1

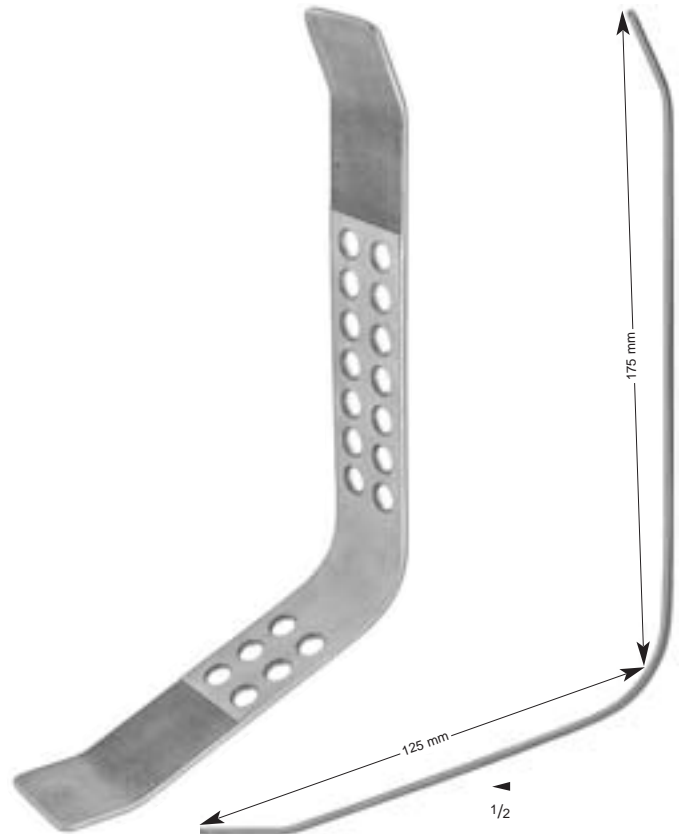

125 mm

175 mm

1/2

THORLAKSON
20-0440
- 20-0444
25 cm, 10"

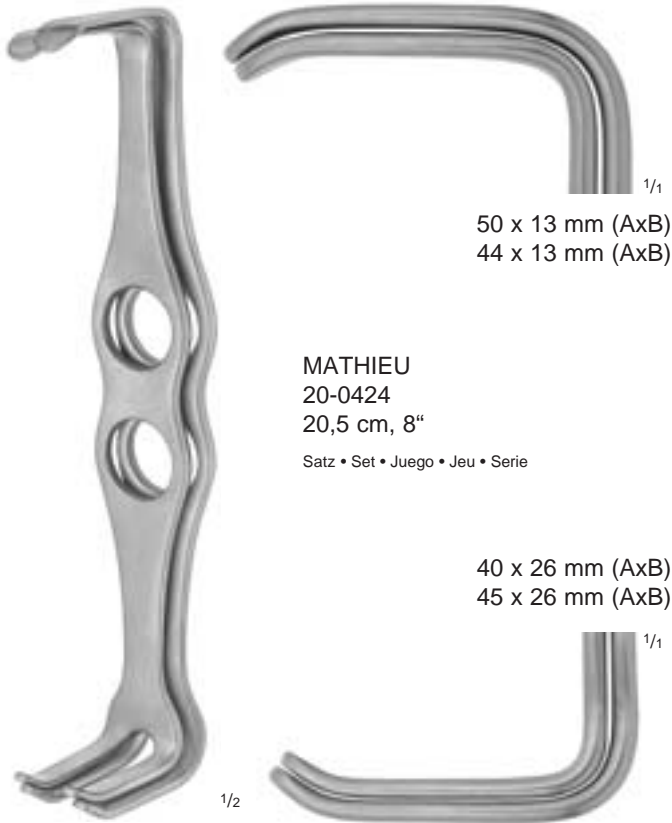
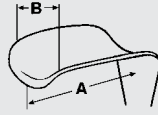

MATHIEU
 20-0424
 20,5 cm, 8"

Satz • Set • Juego • Jeu • Serie

50 x 13 mm (AxB)
 44 x 13 mm (AxB)

40 x 26 mm (AxB)
 45 x 26 mm (AxB)

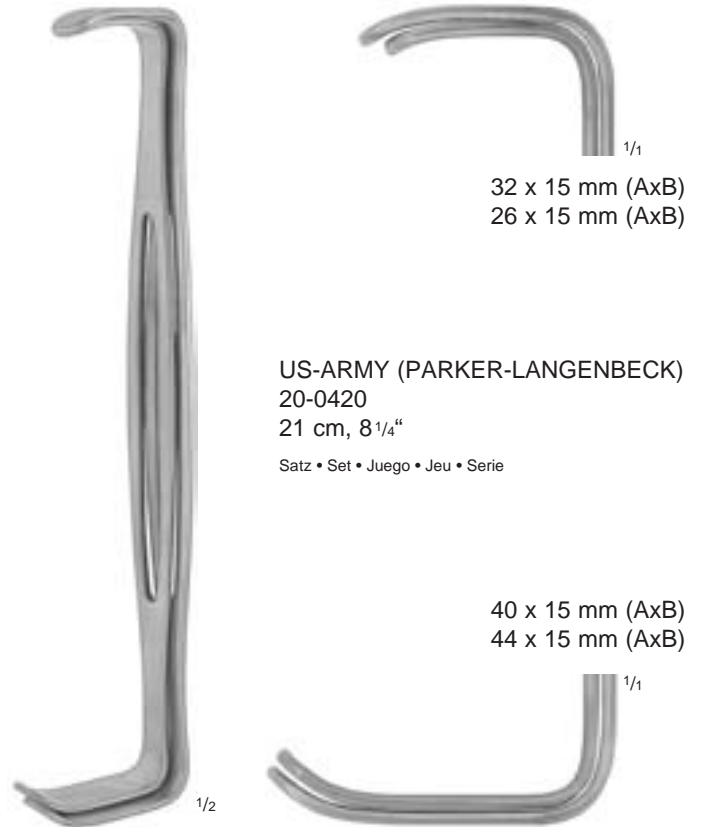

US-ARMY (PARKER-LANGENBECK)
 20-0420
 21 cm, 8 1/4"

Satz • Set • Juego • Jeu • Serie

32 x 15 mm (AxB)
 26 x 15 mm (AxB)

40 x 15 mm (AxB)
 44 x 15 mm (AxB)

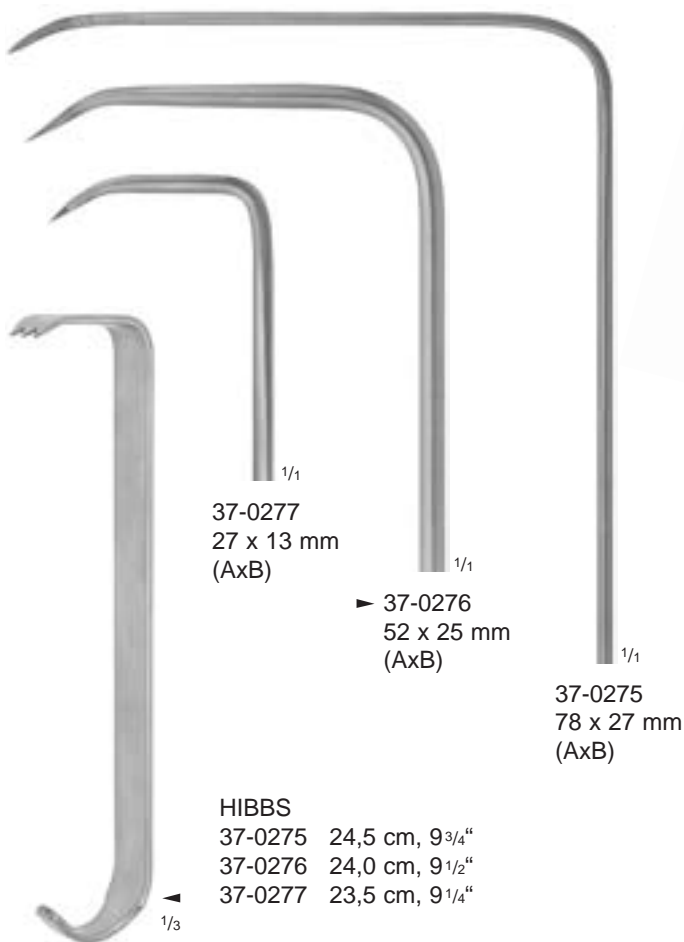

37-0277
 27 x 13 mm
 (AxB)

▶ 37-0276
 52 x 25 mm
 (AxB)

37-0275
 78 x 27 mm
 (AxB)

HIBBS
 37-0275 24,5 cm, 9 3/4"
 37-0276 24,0 cm, 9 1/2"
 37-0277 23,5 cm, 9 1/4"

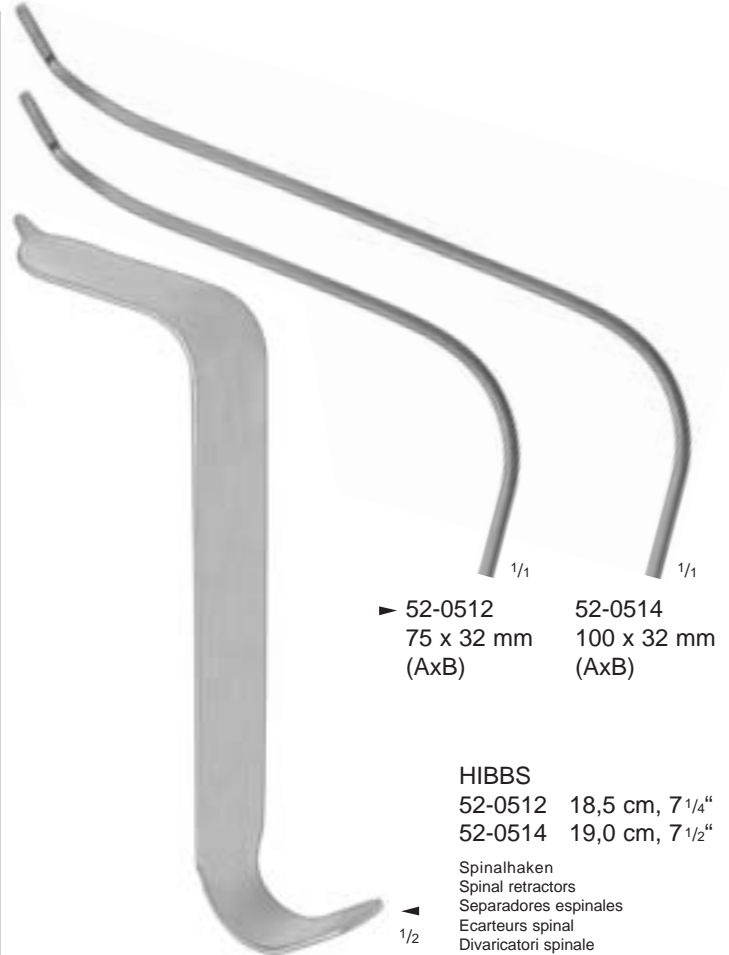

▶ 52-0512
 75 x 32 mm
 (AxB)

52-0514
 100 x 32 mm
 (AxB)

HIBBS
 52-0512 18,5 cm, 7 1/4"
 52-0514 19,0 cm, 7 1/2"

Spinalhaken
 Spinal retractors
 Separadores espinales
 Ecarteurs spinal
 Divaricatori spinale



Wund- und Knochenhaken
 Retractors and Bone Retractors
 Separadores y separadores para huesos
 Ecarteurs et Ecarteurs à os
 Divaricatori e Divaricatori per ossa



1/2

KOCHER
 20-0280
 20 cm, 8"

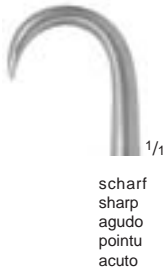

1/1

scharf
 sharp
 agudo
 pointu
 acuto



1/2

KOCHER
 20-0281
 - 20-0290



1/1

▶ **20-0281**
 22 cm, 8^{3/4}"
 scharf
 sharp
 agudo
 pointu
 acuto



1/1

20-0290
 22 cm, 8^{3/4}"
 stumpf
 blunt
 romo
 mousse
 smusso



1/2

VOLKMANN
 20-0300
 - 20-0310



1/1

▶ **20-0300**
 22 cm, 8^{3/4}"
 scharf
 sharp
 agudo
 pointu
 acuto



1/1

20-0310
 22 cm, 8^{3/4}"
 stumpf
 blunt
 romo
 mousse
 smusso



1/2

VOLKMANN
 20-0220
 - 20-0230



1/1

▶ **20-0220**
 22 cm, 8^{3/4}"
 scharf
 sharp
 agudo
 pointu
 acuto



1/1

20-0230
 22 cm, 8^{3/4}"
 stumpf
 blunt
 romo
 mousse
 smusso

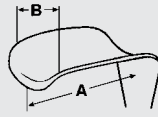

20-0221
 10 x 8 mm (AxB)



20-0231
 10 x 8 mm (AxB)



20-0222
 10 x 13 mm (AxB)



20-0232
 10 x 13 mm (AxB)



VOLKMANN
 20-0221
 - 20-0234
 23 cm, 9"



20-0223
 10 x 18 mm (AxB)



20-0233
 10 x 18 mm (AxB)



▶ 20-0224
 10 x 28 mm (AxB)



20-0234
 10 x 28 mm (AxB)

scharf
 sharp
 agudo
 pointu
 acuto

stumpf
 blunt
 romo
 mousse
 smusso



Wundhaken
 Retractors
 Separadores
 Ecarteurs
 Divaricatori

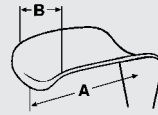

20-0302
 10 x 8 mm (AxB)



20-0352
 10 x 8 mm (AxB)



20-0312
 10 x 8 mm (AxB)



20-0303
 10 x 13 mm (AxB)



20-0353
 10 x 13 mm (AxB)



20-0313
 10 x 13 mm (AxB)



20-0304
 10 x 18 mm (AxB)



20-0354
 10 x 18 mm (AxB)



20-0314
 10 x 18 mm (AxB)



▶ 20-0306
 10 x 28 mm (AxB)



20-0356
 10 x 28 mm (AxB)



20-0316
 10 x 28 mm (AxB)



20-0308
 10 x 40 mm (AxB)



20-0318
 10 x 40 mm (AxB)



VOLKMANN
 20-0302
 - 20-0356
 22,5 cm, 9"

scharf
 sharp
 agudo
 pointu
 acuto

halbscharf
 semi-sharp
 semi-agudo
 semi-pointu
 semi acuto

stumpf
 blunt
 romo
 mousse
 smusso

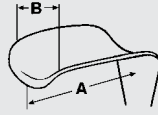

20-0282
15 x 9 mm (AxB)



20-0272
15 x 9 mm (AxB)



20-0292
15 x 9 mm (AxB)



20-0283
15 x 13 mm (AxB)



20-0273
15 x 13 mm (AxB)



20-0293
15 x 13 mm (AxB)



KOCHER
20-0272
- 20-0296
22,5 cm, 9"



20-0284
15 x 18 mm (AxB)



20-0274
15 x 18 mm (AxB)



20-0294
15 x 18 mm (AxB)



▶ 20-0286
15 x 30 mm (AxB)



20-0276
15 x 30 mm (AxB)



20-0296
15 x 30 mm (AxB)

scharf
sharp
agudo
pointu
acuto

halbscharf
semi-sharp
semi-agudo
semi-pointu
semi acuto

stumpf
blunt
romo
mousse
smusso



Wundhaken
Retractors
Separadores
Ecarteurs
Divaricatori

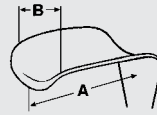

20-0750
26 x 39 mm (AxB)
scharf
sharp
agudo
pointu
acuto

KOERTE
20-0750
- 20-0751
24 cm, 9 1/2"

Griff vertikal zum Blatt
handle vertical to the blade
mango vertical a la hoja
manche vertical à la valve
impugnatura verticale a lama

1/2



20-0751
26 x 39 mm (AxB)
stumpf
blunt
romo
mousse
smusso



25 x 60 mm (AxB)

20-0753
25 cm, 10"
scharf
sharp
agudo
pointu
acuto

1/2



38 x 56 mm (AxB)

OLLIER
20-0760
23 cm, 9"

1/2



46 x 55 mm (AxB)

KOERTE
20-0754
24 cm, 9 1/2"

1/2

Griff vertikal zum Blatt
handle vertical to the blade
mango vertical a la hoja
manche vertical à la valve
impugnatura verticale a lama

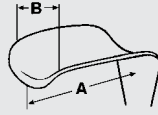

20-0774
 40 x 40 mm (AxB)



▶ 20-0775
 47 x 50 mm (AxB)



20-0776
 53 x 60 mm (AxB)



20-0777
 70 x 70 mm (AxB)

ISRAEL
 20-0774
 - 20-0777
 24,5 cm, 9³/₄"



Wundhaken
Retractors
Separadores
Ecarteurs
Divaricatori

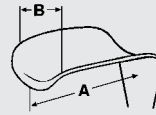

20-0530
30 x 10 mm (AxB)



20-0551
30 x 10 mm (AxB)



▶ 20-0534
30 x 14 mm (AxB)



▶ 20-0552
30 x 14 mm (AxB)



20-0535
30 x 16 mm (AxB)



20-0553
30 x 16 mm (AxB)



20-0531
40 x 10 mm (AxB)



20-0555
40 x 10 mm (AxB)



20-0532
42 x 13 mm (AxB)



20-0561
42 x 13 mm (AxB)



20-0533
40 x 15 mm (AxB)



20-0556
40 x 15 mm (AxB)



20-0536
50 x 11 mm (AxB)



20-0562
50 x 11 mm (AxB)

LANGENBECK
20-0530
- 20-0536
21,5 cm, 8 1/2"

LANGENBECK
20-0551
- 20-0562
21 cm, 8 1/4"

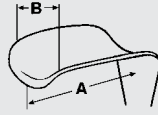

▶ 20-0557
 55 x 20 mm (AxB)



1/1

20-0558
 60 x 20 mm (AxB)



1/1



1/2

LANGENBECK
 20-0557 22,5 cm, 9"
 20-0558 21,5 cm, 8 1/2"

85 x 15 mm (AxB)

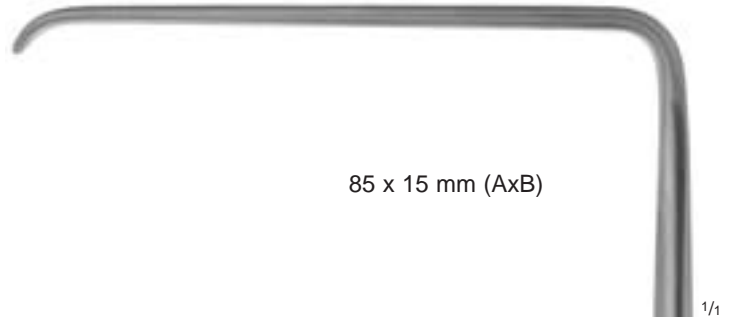

1/1



1/2

LANGENBECK
 20-0559
 21,5 cm, 8 1/2"



Wundhaken
 Retractors
 Separadores
 Ecarteurs
 Divaricatori

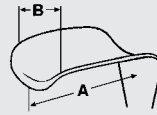

KOCHER-LANGENBECK
 20-0570
 - 20-0583
 21,5 cm, 8 1/2"



20-0570
 25 x 6 mm (AxB)



20-0571
 35 x 8 mm (AxB)



20-0572
 35 x 11 mm (AxB)



20-0583
 35 x 15 mm (AxB)



▶ 20-0581
 40 x 11 mm (AxB)



20-0582
 55 x 11 mm (AxB)



20-0573
 70 x 14 mm (AxB)



20-0574
 80 x 12 mm (AxB)



20-0575
 80 x 16 mm (AxB)

Wundhaken
 Retractors
 Separadores
 Ecarteurs
 Divaricatori

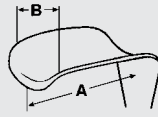

Weichteilhaken
 Soft tissue retractors
 Separadores para tejido blando
 Ecarteurs pour parties molles
 Divaricatori per tessuti molli

OBWEGESER
20-0507
- 20-0512
 22 cm, 8³/₄"

1/2

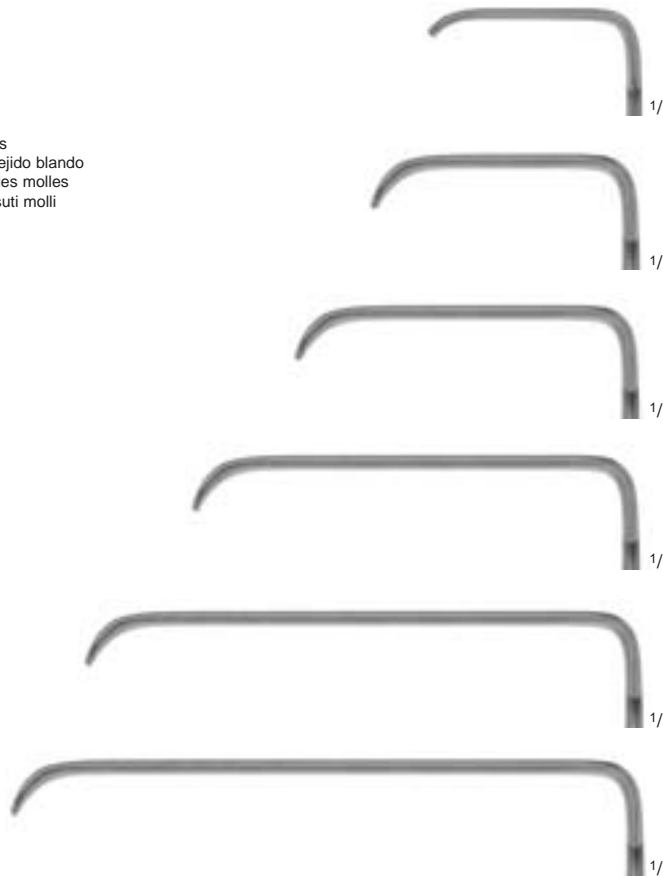

► **20-0507**
 25 x 7 mm (AxB)

1/1

20-0508
 31 x 10 mm (AxB)

1/1

20-0509
 42 x 11 mm (AxB)

1/1

20-0510
 55 x 12 mm (AxB)

1/1

20-0511
 70 x 14 mm (AxB)

1/1

20-0512
 80 x 16 mm (AxB)

1/1



Weichteilhaken
 Soft tissue retractors
 Separadores para tejido blando
 Ecarteurs pour parties molles
 Divaricatori per tessuti molli

OBWEGESER
20-0514
- 20-0519
 22 cm, 8³/₄"

1/2

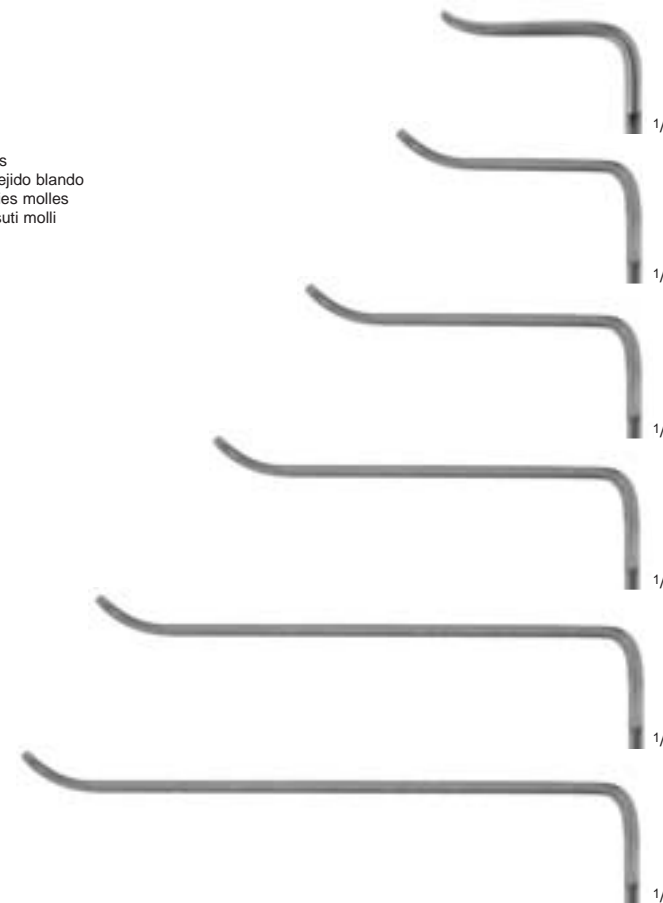

► **20-0514**
 25 x 7 mm (AxB)

1/1

20-0515
 31 x 10 mm (AxB)

1/1

20-0516
 42 x 11 mm (AxB)

1/1

20-0517
 55 x 12 mm (AxB)

1/1

20-0518
 70 x 14 mm (AxB)

1/1

20-0519
 80 x 16 mm (AxB)

1/1



Wundhaken
 Retractors
 Separadores
 Ecarteurs
 Divaricatori

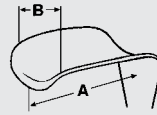

KOCHER
20-0584
 - **20-0589**
 23 cm, 9"

1/2



► **20-0585**
 40 x 18 mm (AxB)

1/1



20-0584
 60 x 20 mm (AxB)

1/1



20-0586
 60 x 25 mm (AxB)

1/1



20-0589
 75 x 30 mm (AxB)

1/1



20-0587
 75 x 40 mm (AxB)

1/1



SAUERBRUCH
20-0641
 - **20-0643**
 23 cm, 9"

1/2



20-0641
 46 x 16 mm (AxB)

1/1



► **20-0642**
 55 x 22 mm (AxB)

1/1



20-0643
 72 x 19 mm (AxB)

1/1

Wundhaken
Retractors
Separadores
Ecarteurs
Divaricatori

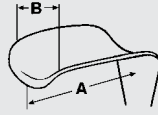

22 X 20 mm (AxB)



GREEN
12-0330
23 cm, 9"

Schilddrüsenhaken
Thyroid gland retractor
Separador para la glándula tiroidea
Ecarteur pour la thyroïde
Divaricatore per la tiroide



▶ **20-0626**
26 x 30 mm (AxB)



20-0625
20 x 22 mm (AxB)



20-0624
15 x 16 mm (AxB)

MIDDELDORPF
20-0624 21,5 cm, 8 1/2"
20-0625 22,5 cm, 9"
20-0626 23,5 cm, 9 1/4"



20-0629
55 x 70 mm (AxB)



▶ **20-0628**
45 x 50 mm (AxB)



20-0627
45 x 45 mm (AxB)

MIDDELDORPF
20-0627
- **20-0629**
27,5 cm, 10 3/4"



Wundhaken
 Retractors
 Separadores
 Ecarteurs
 Divaricatori

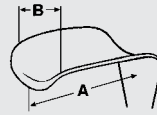

20-0607 19 x 12 mm (AxB)



20-0608 21 x 15 mm (AxB)



▶ **20-0618** 40 x 10 mm (AxB)
20-0619 40 x 15 mm (AxB)
20-0620 40 x 20 mm (AxB)

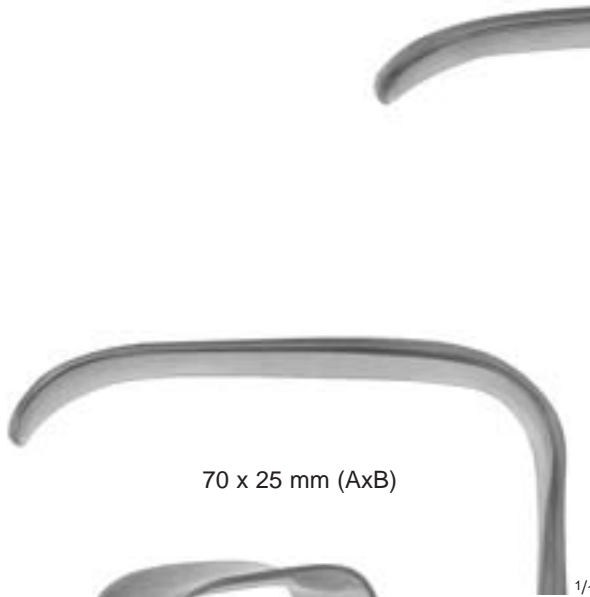

70 x 25 mm (AxB)



▶ **20-0615** 80 x 42 mm (AxB)
20-0616 80 x 50 mm (AxB)
20-0617 80 x 55 mm (AxB)
20-0635 80 x 65 mm (AxB)



KOCHER
20-0607
 - **20-0620**
 22,5 cm, 9"



KOCHER
20-0614
 23 cm, 9"



KOCHER
20-0615
 - **20-0635**
 24,5 cm, 9³/₄"

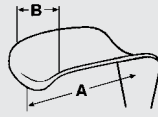

► **20-0636**
40 x 12 mm (AxB)



20-0637
55 x 14 mm (AxB)

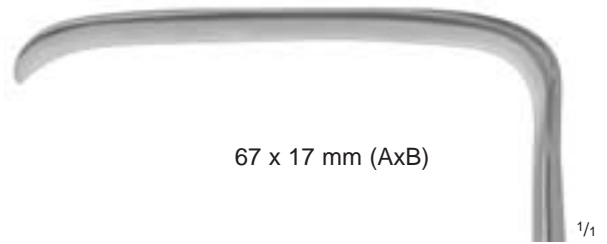

67 x 17 mm (AxB)



DOCKHORN
20-0636
- **20-0637**
21 cm, 8 1/4"



CASPAR
20-0638
22,5 cm, 9"



Wundhaken
Retractors
Separadores
Ecarteurs
Divaricatori

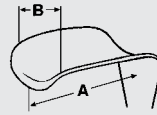

20-0644
60 x 20 mm (AxB)

20-0645
80 x 30 mm (AxB)

20-0646
100 x 30 mm (AxB)

▶ **20-0647**
120 x 30 mm (AxB)

20-0648 140 x 30 mm (AxB)
20-0649 140 x 40 mm (AxB)



HÖSEL
20-0644
- **20-0649**
25 cm, 10"

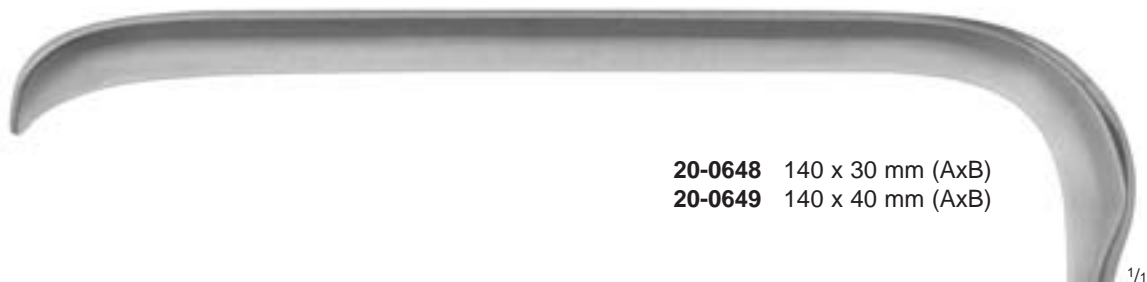

Wundhaken
 Retractors
 Separadores
 Ecarteurs
 Divaricatori

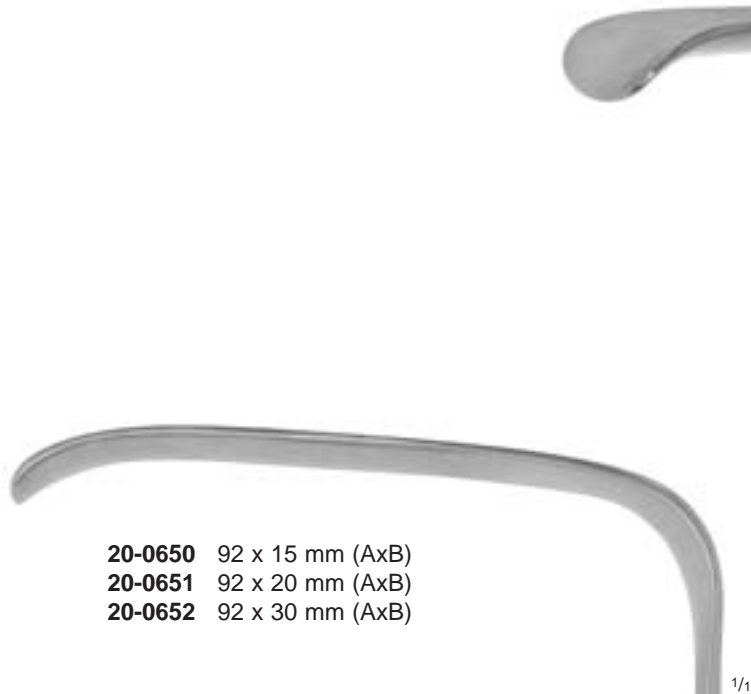
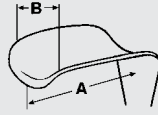

20-0650 92 x 15 mm (AxB)
20-0651 92 x 20 mm (AxB)
20-0652 92 x 30 mm (AxB)

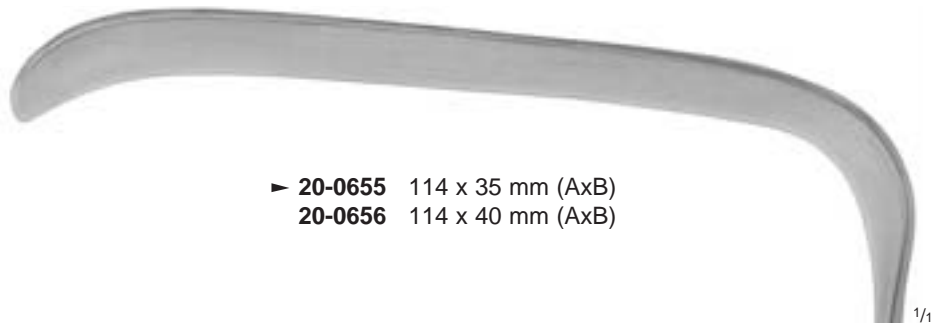

▶ **20-0655** 114 x 35 mm (AxB)
20-0656 114 x 40 mm (AxB)



20-0659 120 x 55 mm (AxB)

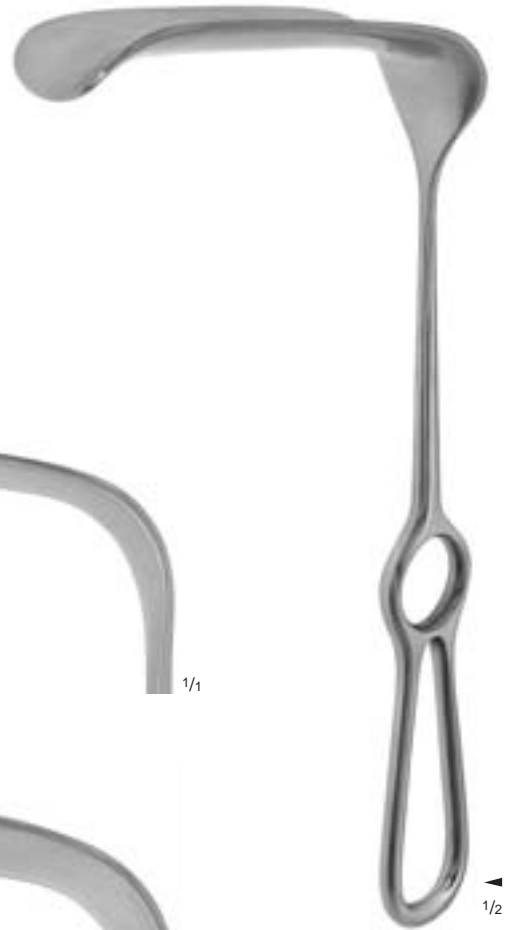

DOYEN-STILLE
20-0650
 - **20-0659**
 24 cm, 9 1/2"

Griff vertikal zum Blatt
 handle vertical to the blade
 mango vertical a la hoja
 manche vertical à la valve
 impugnatura verticale a lama



Wundhaken
Retractors
Separadores
Ecarteurs
Divaricatori

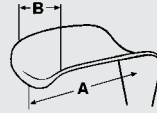

DOYEN
20-0680
- **20-0699**
23 cm, 9"

Bauchdeckenhaken
Abdominal retractors
Separadores abdominales
Ecarteurs intra abdominaux
Divaricatori addominale

- ▶ **20-0680** 55 x 35 mm (AxB)
- 20-0683** 55 x 45 mm (AxB)
- 20-0686** 55 x 60 mm (AxB)

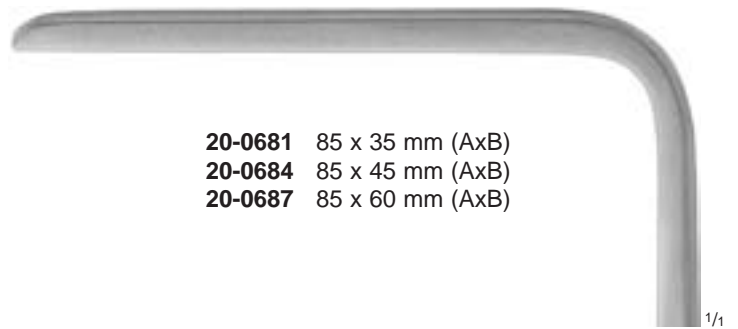

- 20-0681** 85 x 35 mm (AxB)
- 20-0684** 85 x 45 mm (AxB)
- 20-0687** 85 x 60 mm (AxB)

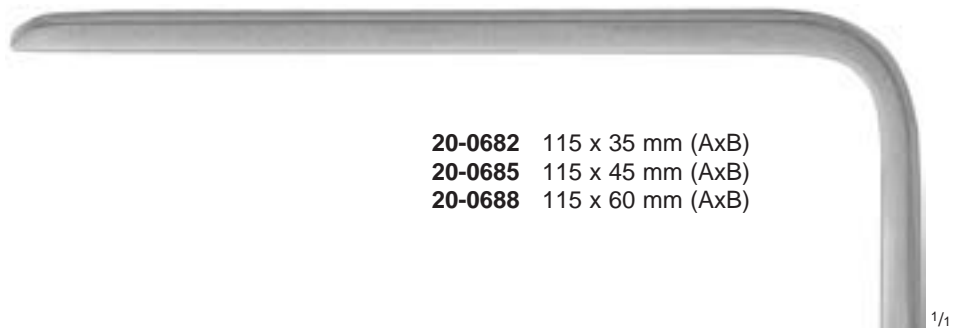

- 20-0682** 115 x 35 mm (AxB)
- 20-0685** 115 x 45 mm (AxB)
- 20-0688** 115 x 60 mm (AxB)

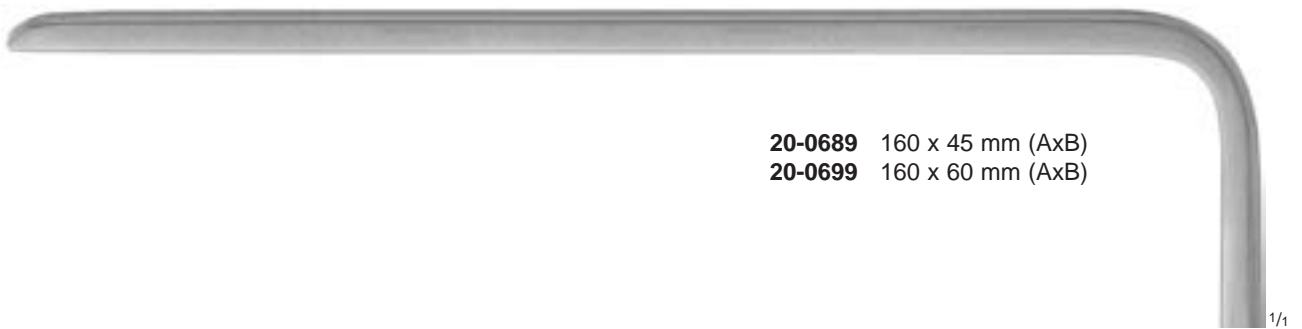

- 20-0689** 160 x 45 mm (AxB)
- 20-0699** 160 x 60 mm (AxB)

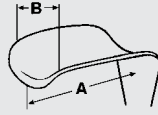

50 x 85 mm (AxB)

1/1



1/2

DOYEN
20-0665
 24 cm, 9 1/2"

Bauchdeckenhaken
 Abdominal retractor
 Separador abdominal
 Ecarteur intra abdominaux
 Divaricatore addominale

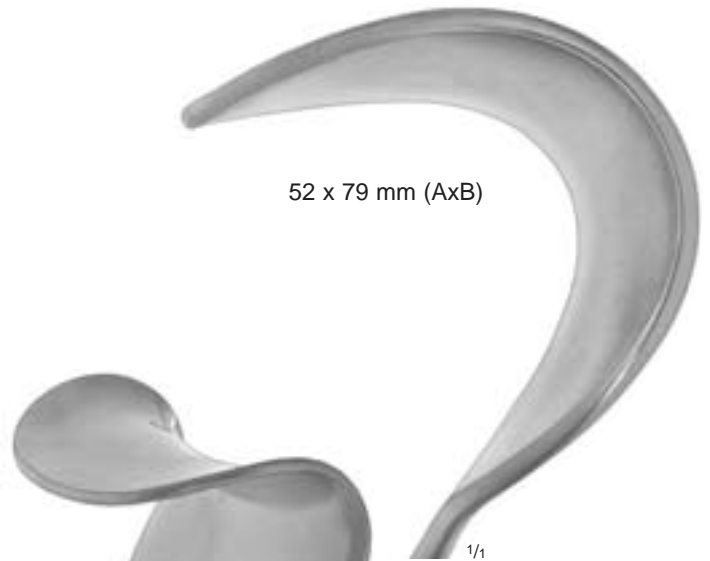

52 x 79 mm (AxB)

1/1



1/2

MAYO
20-1730
 27,5 cm, 10 3/4"

Bauchdeckenhaken
 Abdominal retractor
 Separador abdominal
 Ecarteur intra abdominaux
 Divaricatore addominale



Wundhaken
Retractors
Separadores
Ecarteurs
Divaricatori

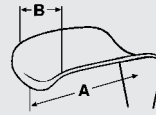

20-0735
60 x 85 mm (AxB)



20-0734
45 x 75 mm (AxB)

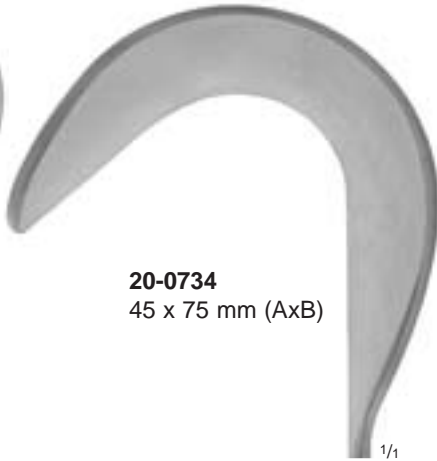

20-0732 40 x 50 mm (AxB)
▶ **20-0733** 40 x 60 mm (AxB)

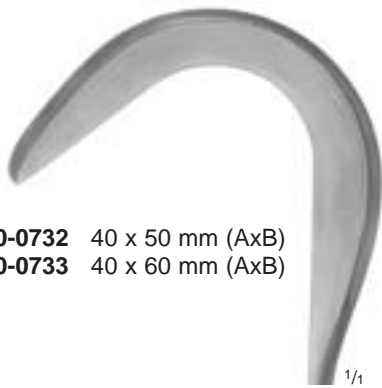

20-0731
35 x 40 mm (AxB)

FRITSCH

- 20-0731** 23,5 cm, 9 1/4"
- 20-0732** 24,5 cm, 9 3/4"
- 20-0733** 24,5 cm, 9 3/4"
- 20-0734** 25,0 cm, 10"
- 20-0735** 26,0 cm, 10 1/4"

Griff vertikal zum Blatt
handle vertical to the blade
mango vertical a la hoja
manche vertical à la valve
impugnatura verticale a lama

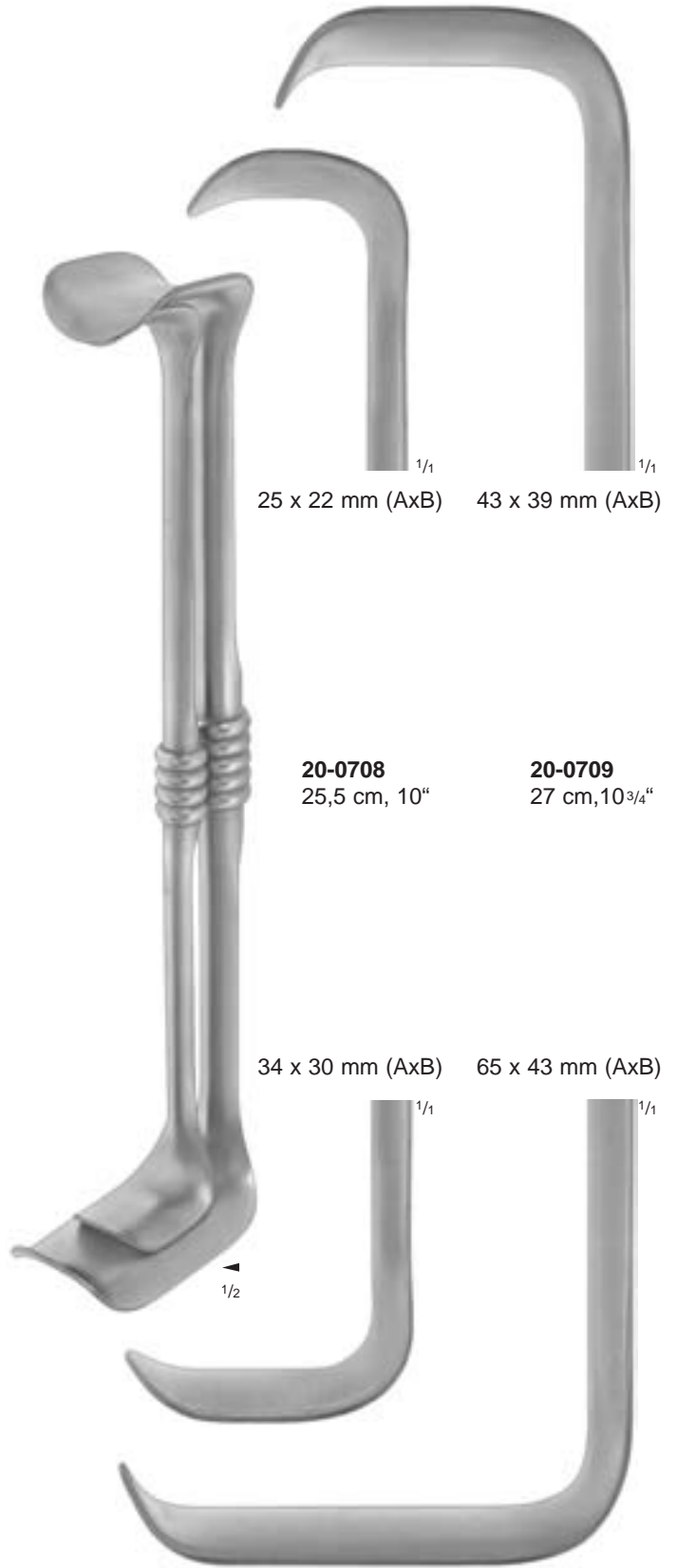

20-0708
25 x 22 mm (AxB)

20-0709
43 x 39 mm (AxB)

20-0708
25,5 cm, 10"

20-0709
27 cm, 10 3/4"

20-0710
34 x 30 mm (AxB)

20-0710
65 x 43 mm (AxB)

RICHARDSON-EASTMAN

▶ **20-0710**
27 cm, 10 3/4"

Satz • Set • Juego • Jeu • Serie

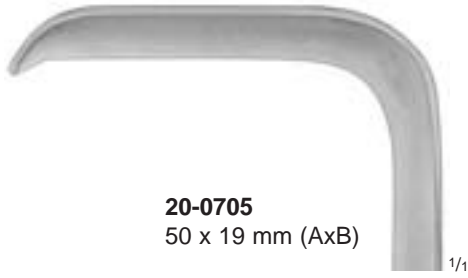
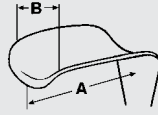

RICHARDSON
20-0705
 - **20-0713**
 24 cm, 9 1/2"



KELLY
20-0721 23,5 cm, 9 1/4"
20-0722 24,0 cm, 9 1/2"
20-0723 25,0 cm, 10"



Wundhaken für Eingriffe in der Tiefe

Retractors for Deep Surgery

Separadores para cirugía profunda

Ecarteurs pour interventions en profondeur

Divaricatori per interventi in profondità

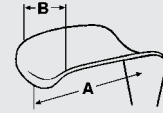

20-0742 180 x 30 mm (AxB)

20-0743 160 x 30 mm (AxB)

20-0744 140 x 30 mm (AxB)

20-0745 130 x 30 mm (AxB)

20-0746 120 x 25 mm (AxB)

20-0747 100 x 25 mm (AxB)

► **20-0748** 80 x 20 mm (AxB)



BRUNNER
20-0742
- **20-0748**
25 cm, 10"

1/2

Wundhaken für Eingriffe in der Tiefe

Retractors for Deep Surgery

Separadores para cirugía profunda

Ecarteurs pour interventions en profondeur

Divaricatori per interventi in profondità

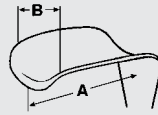

20-0797 180 x 30 mm (AxB)

20-0796 160 x 30 mm (AxB)

20-0795 140 x 25 mm (AxB)

20-0794 120 x 25 mm (AxB)

20-0793 100 x 20 mm (AxB)

► **20-0792** 80 x 20 mm (AxB)



BRUNNER
20-0792
- **20-0797**
25 cm, 10"



Wundhaken für Eingriffe in der Tiefe

Retractors for Deep Surgery

Separadores para cirugía profunda

Ecarteurs pour interventions en profondeur

Divaricatori per interventi in profondità

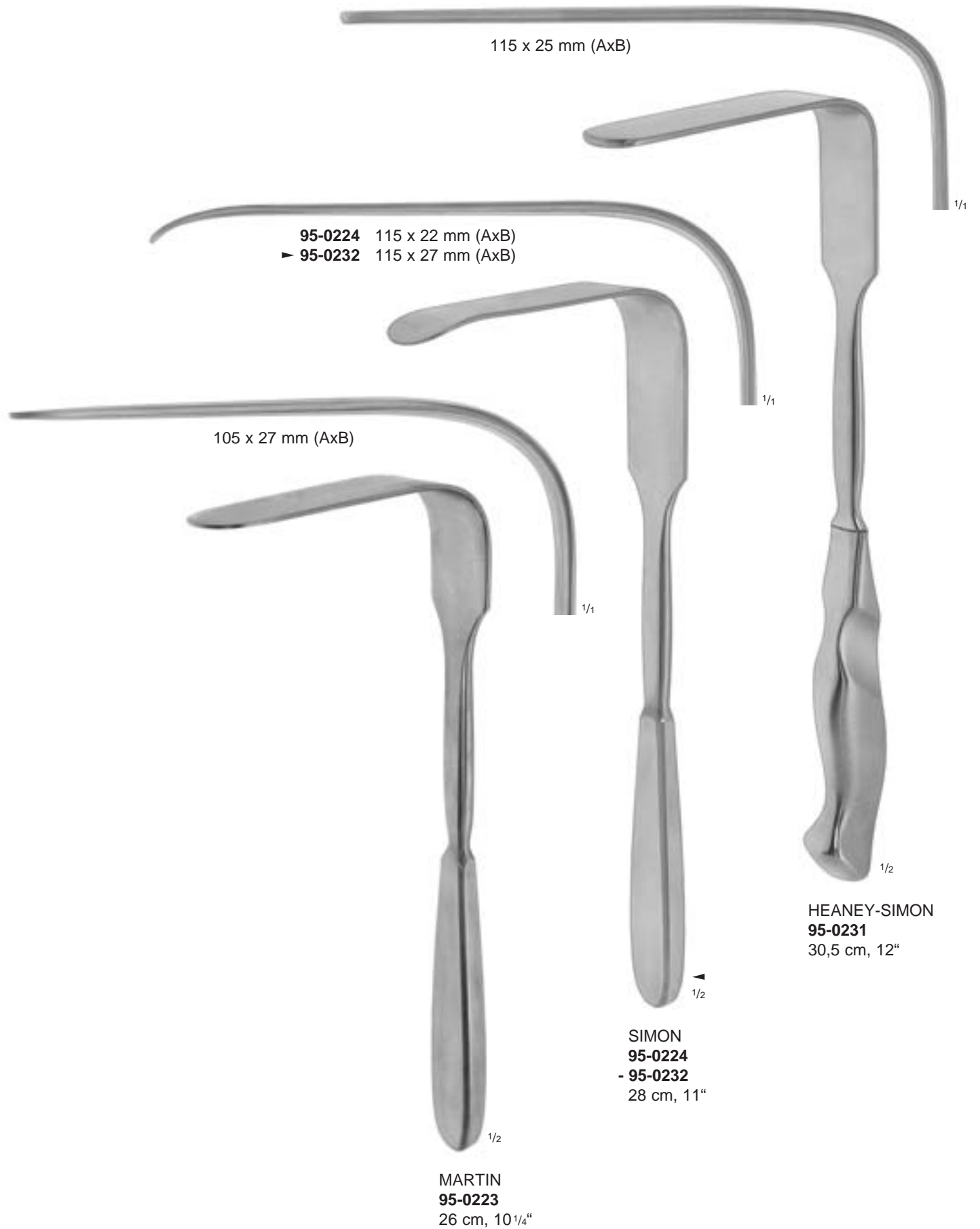
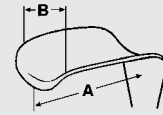

Wundhaken für Eingriffe in der Tiefe

Retractors for Deep Surgery

Separadores para cirugía profunda

Ecarteurs pour interventions en profondeur

Divaricatori per interventi in profondità

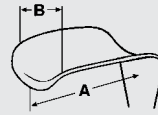

- ▶ **20-0940** 160 x 38 mm (AxB)
- 20-0941** 160 x 57 mm (AxB)

20-0933 155 x 50 mm (AxB)

▶ **20-0932** 125 x 50 mm (AxB)

20-0931 90 x 35 mm (AxB)

85 X 35 mm (AxB)

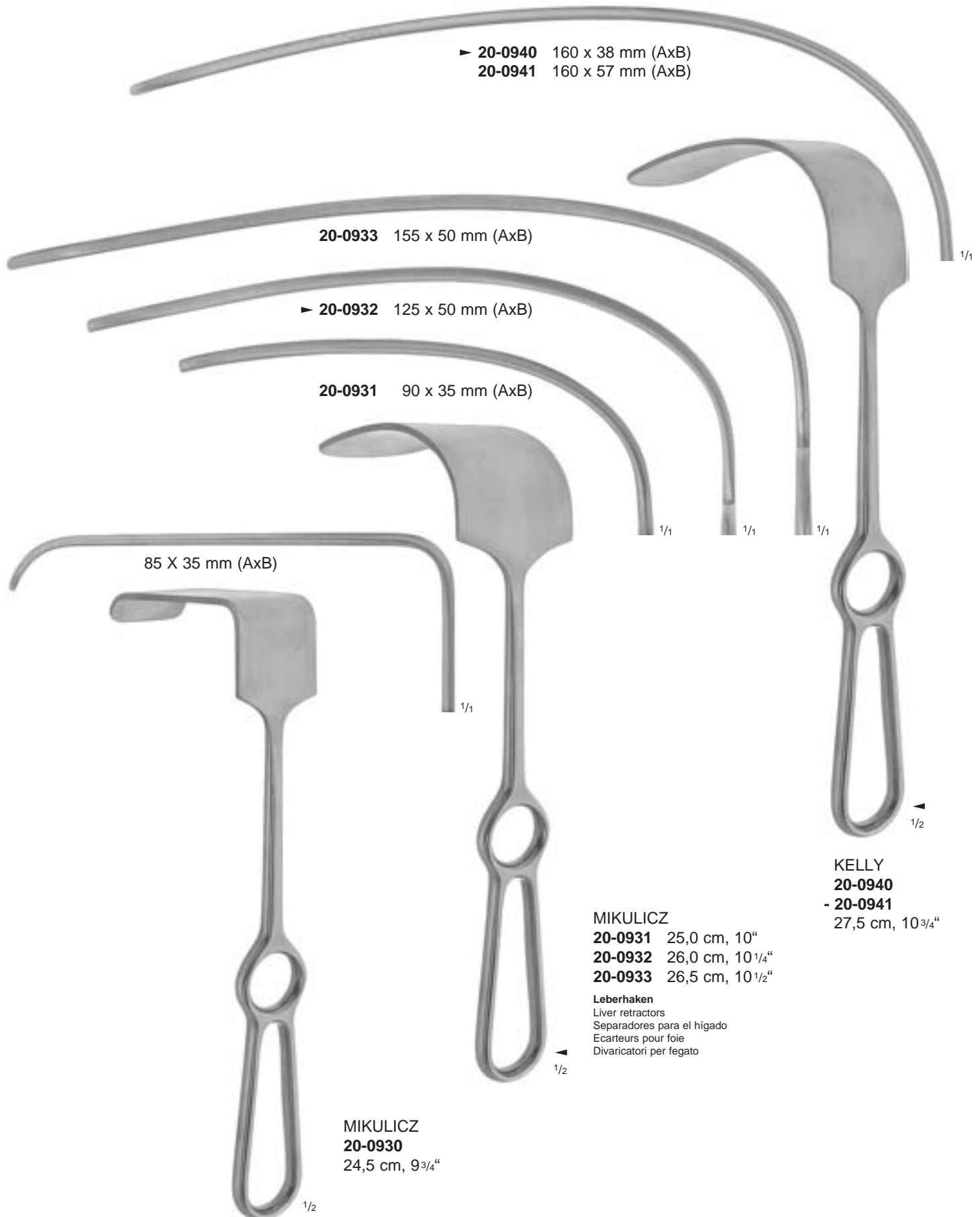

KELLY
20-0940
- **20-0941**
27,5 cm, 10³/₄"

MIKULICZ
20-0931 25,0 cm, 10"
20-0932 26,0 cm, 10¹/₄"
20-0933 26,5 cm, 10¹/₂"

Leberhaken
Liver retractors
Separadores para el hígado
Ecarteurs pour foie
Divaricatori per fegato

MIKULICZ
20-0930
24,5 cm, 9³/₄"



Wundhaken für Eingriffe in der Tiefe

Retractors for Deep Surgery

Separadores para cirugía profunda

Ecarteurs pour interventions en profondeur

Divaricatori per interventi in profondità

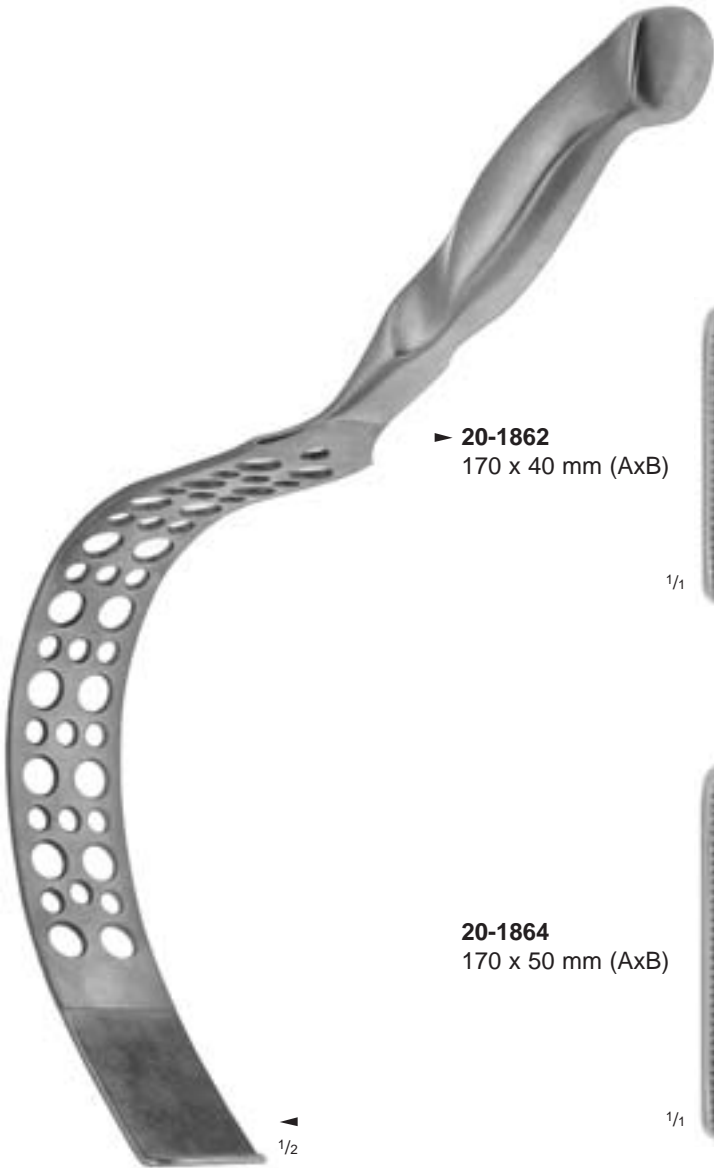
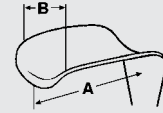

► **20-1862**
170 x 40 mm (AxB)

1/1

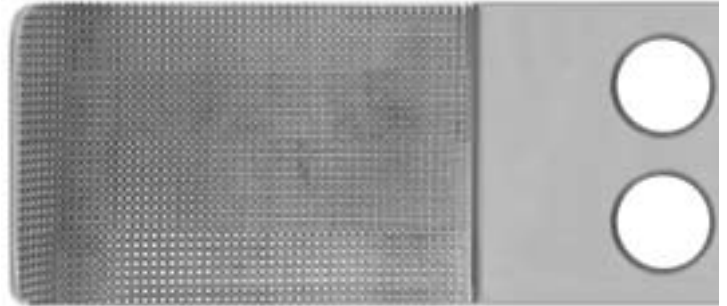

20-1864
170 x 50 mm (AxB)

1/1

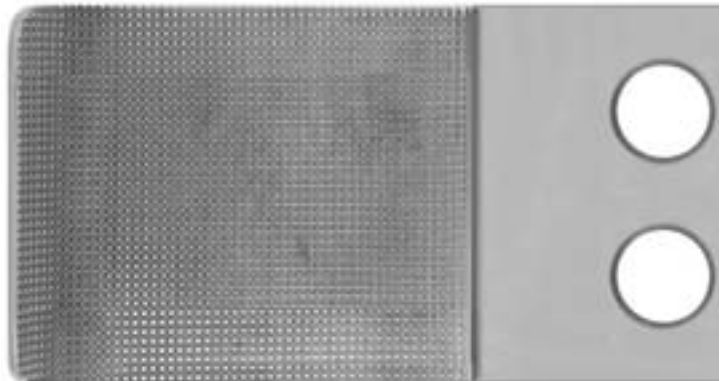

THORLAKSON

20-1862

- **20-1866**

33 cm, 13"

Pelvishaken

Pelvis retractors

Separadores para pelvis

Ecarteurs à pelvis

Divaricatori per pelvis

20-1866
170 x 65 mm (AxB)

1/1

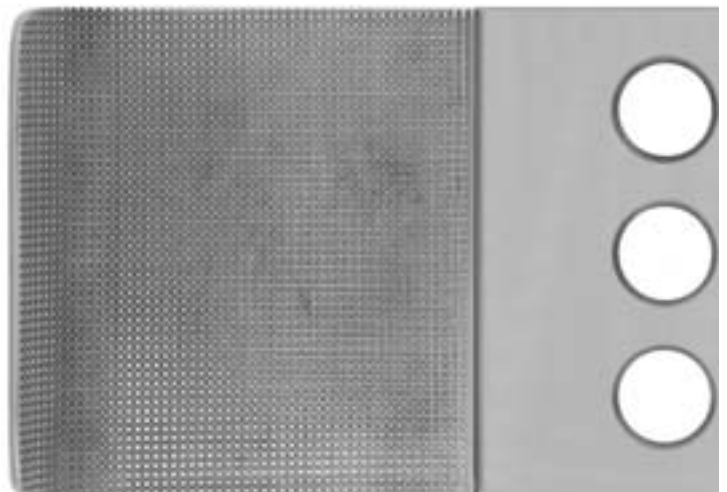

Wundhaken für Eingriffe in der Tiefe

Retractors for Deep Surgery

Separadores para cirugía profunda

Ecarteurs pour interventions en profondeur

Divaricatori per interventi in profondità

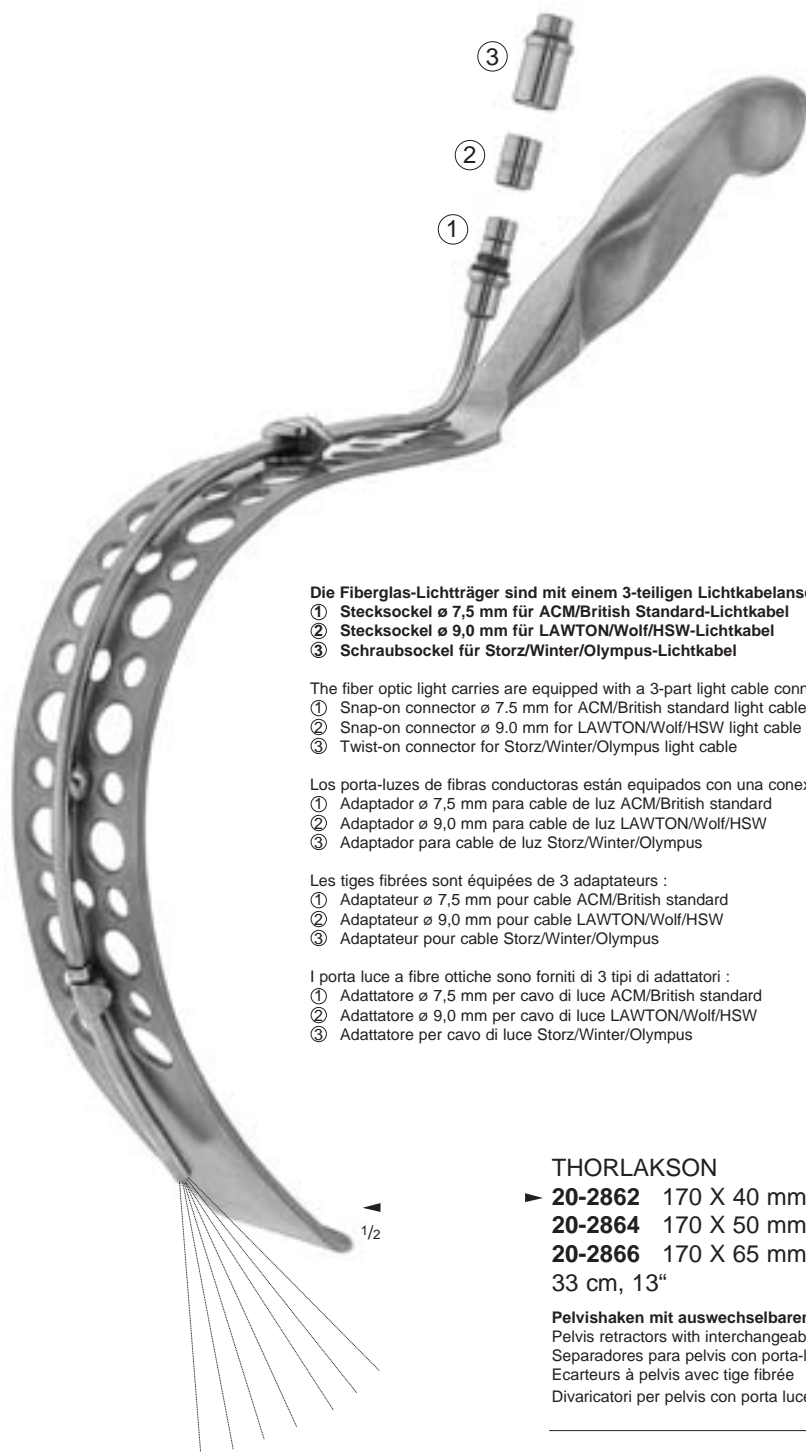
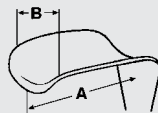

Die Fiberglas-Lichtträger sind mit einem 3-teiligen Lichtkabelanschluß ausgestattet :

- ① Stecksocket ø 7,5 mm für ACM/British Standard-Lichtkabel
- ② Stecksocket ø 9,0 mm für LAWTON/Wolf/HSW-Lichtkabel
- ③ Schraubsocket für Storz/Winter/Olympus-Lichtkabel

The fiber optic light carries are equipped with a 3-part light cable connector :

- ① Snap-on connector ø 7.5 mm for ACM/British standard light cable
- ② Snap-on connector ø 9.0 mm for LAWTON/Wolf/HSW light cable
- ③ Twist-on connector for Storz/Winter/Olympus light cable

Los porta-luzes de fibras conductoras están equipados con una conexión de 3 adaptadores :

- ① Adaptador ø 7,5 mm para cable de luz ACM/British standard
- ② Adaptador ø 9,0 mm para cable de luz LAWTON/Wolf/HSW
- ③ Adaptador para cable de luz Storz/Winter/Olympus

Les tiges fibrées sont équipées de 3 adaptateurs :

- ① Adaptateur ø 7,5 mm pour cable ACM/British standard
- ② Adaptateur ø 9,0 mm pour cable LAWTON/Wolf/HSW
- ③ Adaptateur pour cable Storz/Winter/Olympus

I porta luce a fibre ottiche sono forniti di 3 tipi di adattatori :

- ① Adattatore ø 7,5 mm per cavo di luce ACM/British standard
- ② Adattatore ø 9,0 mm per cavo di luce LAWTON/Wolf/HSW
- ③ Adattatore per cavo di luce Storz/Winter/Olympus

THORLAKSON

- ▶ **20-2862** 170 X 40 mm (AxB)
 - 20-2864** 170 X 50 mm (AxB)
 - 20-2866** 170 X 65 mm (AxB)
- 33 cm, 13"

Pelvishaken mit auswechselbarem Fiberglas-Lichtträger

Pelvis retractors with interchangeable fiber optic light carrier
Separadores para pelvis con porta-luz de fibras conductoras intercambiables
Ecarteurs à pelvis avec tige fibrée
Divaricatori per pelvis con porta luce a fibre ottiche intercambiabile

20-2868

Fiberglas-Lichtträger allein (ohne Halterung)

Fiber optic light carrier only (without fixation devices)
Porta-luz de fibras conductoras, suelto (sin fijación)
Tige porte lampe fibrée (sans fixation)
Solo porta luce a fibre ottiche (senza dispositivo di fissaggio)

20-2869

Halterung allein

Fixation devices only
Fijación, suelta
Fixation seule
Solo dispositivo di fissaggio

• Optimale Ausleuchtung des Operationsfeldes

• Optimal illumination of surgical sites

• Iluminación óptima para el campo de operación

• Eclairage maximal du champ opératoire

• Ottima illuminazione del campo operatorio



Wundhaken für Eingriffe in der Tiefe

Retractors for Deep Surgery

Separadores para cirugía profunda

Ecarteurs pour interventions en profondeur

Divaricatori per interventi in profondità

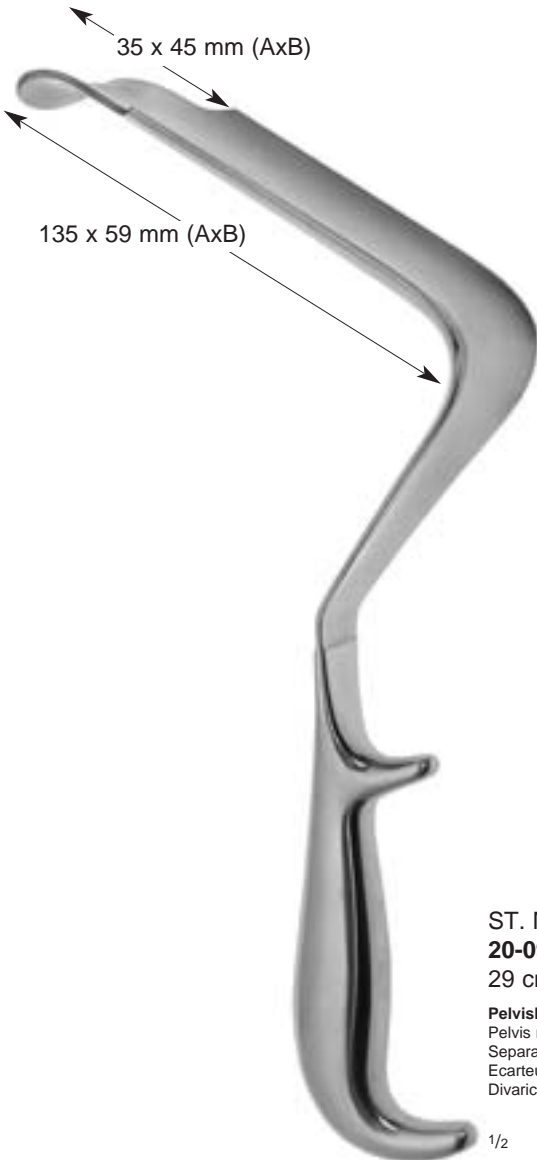
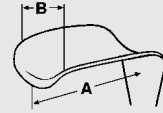

**ST. MARKS
20-0990**
29 cm, 11 1/2"

Pelvishaken
Pelvis retractor
Separador para pelvis
Ecarteur à pelvis
Divaricatore per pelvis

**ST. MARKS
20-0991**
31 cm, 12 1/4"

Pelvishaken
Pelvis retractor
Separador para pelvis
Ecarteur à pelvis
Divaricatore per pelvis

**ST. MARKS
20-0992**
32,5 cm, 12 3/4"

Pelvishaken
Pelvis retractor
Separador para pelvis
Ecarteur à pelvis
Divaricatore per pelvis

Wundhaken für Eingriffe in der Tiefe

Retractors for Deep Surgery

Separadores para cirugía profunda

Ecarteurs pour interventions en profondeur

Divaricatori per interventi in profondità

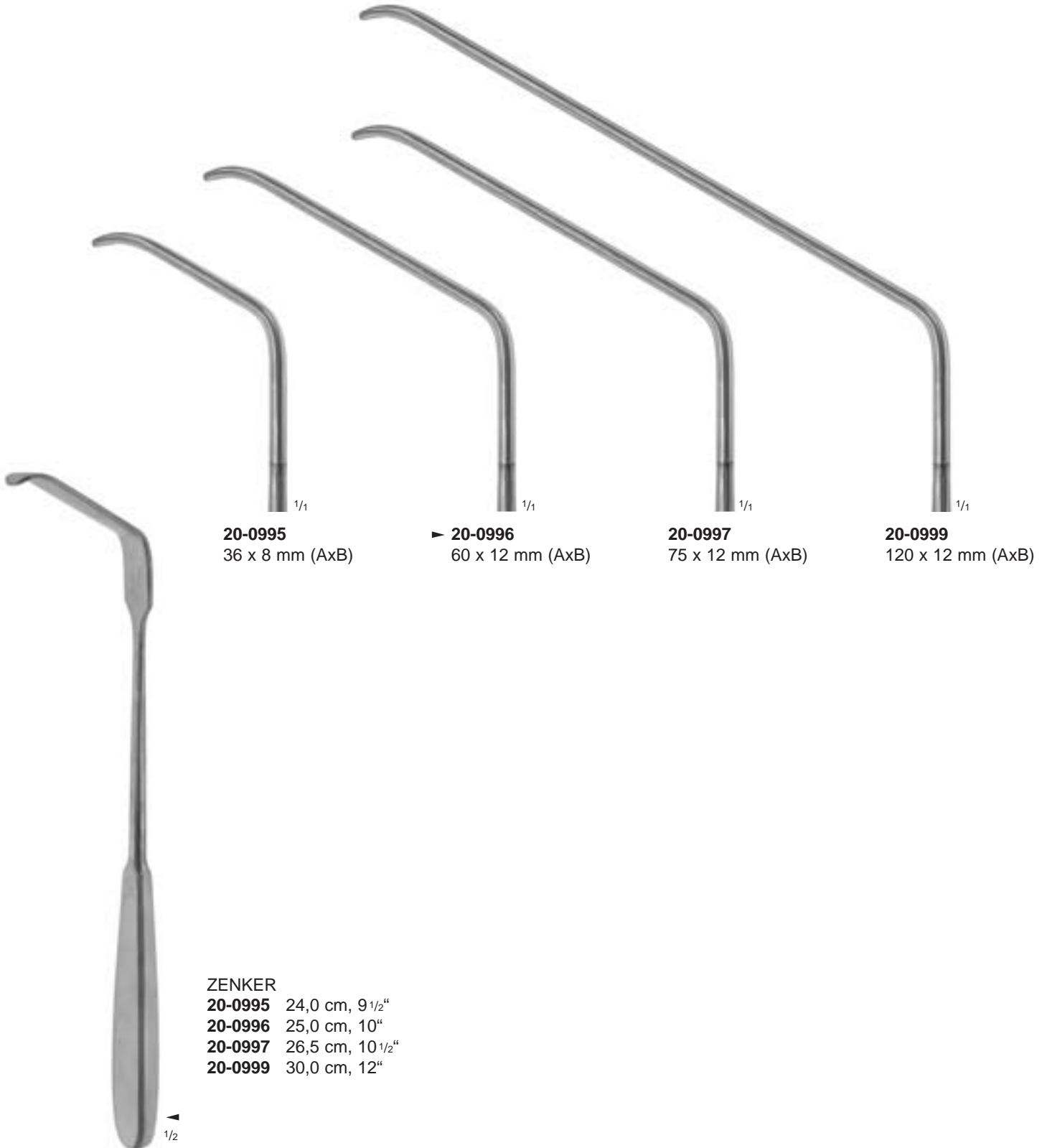
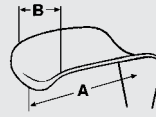

20-0995
36 x 8 mm (AxB)

▶ **20-0996**
60 x 12 mm (AxB)

20-0997
75 x 12 mm (AxB)

20-0999
120 x 12 mm (AxB)

ZENKER
20-0995 24,0 cm, 9 1/2"
20-0996 25,0 cm, 10"
20-0997 26,5 cm, 10 1/2"
20-0999 30,0 cm, 12"

**Scapula-Haken**

Scapula Retractors
 Separadores para scápula
 Ecarteur à scapula
 Divaricatori per scapola

Lungenhaken

Lung Retractors
 Separadores para el pulmón
 Ecarteur à poumons
 Divaricatori per polmone



DAVIDSON
37-0450

22 cm, 8³/₄"

Scapula-Haken
 Scapula retractor
 Separador para scápula
 Ecarteur à scapula
 Dicaricatore per scapola



► **37-0320**
 18 mm



37-0321
 24 mm



SEMB
37-0320
 - **37-0321**
 27,5 cm, 10³/₄"

Lungenhaken
 Lung retractors
 Separadores para el pulmón
 Ecarteurs à poumons
 Divaricatori per polmone



DAVIDSON
37-0455

22 cm, 8³/₄"

Scapula-Haken
 Scapula retractor
 Separador para scápula
 Ecarteur à scapula
 Dicaricatore per scapola



ALLISON
37-0370
 32,5 cm, 12³/₄"

Lungenspatel
 Lung spatula
 Espátula para el pulmón
 Spatule pulmonaire
 Spatole per polmone

Wundhaken und Lungenspatel

Retractors and Lung Spatulas

Separadores y espátulas para el pulmón

Ecarteurs et spatules pulmonaires

Divaricatori e spatole per polmone

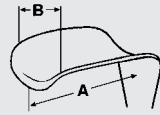

115 x 64 mm (AxB)

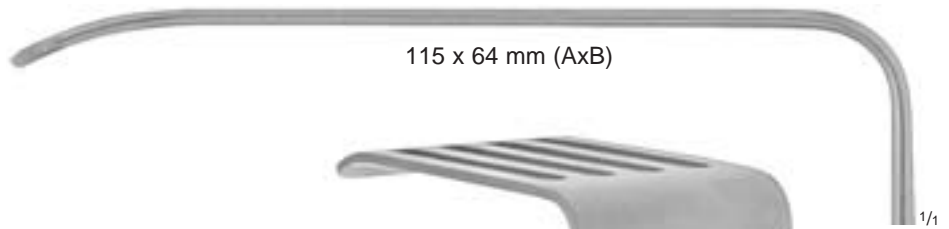

108 x 43 mm (AxB)

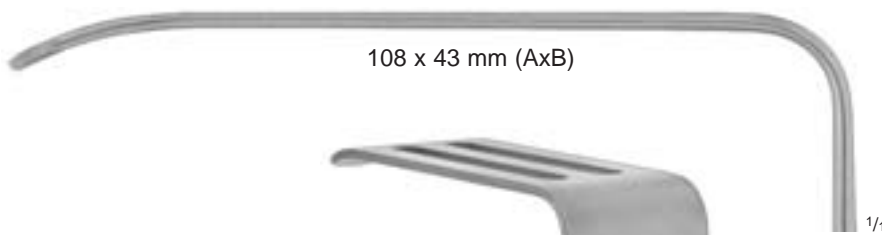

82 x 21 mm (AxB)

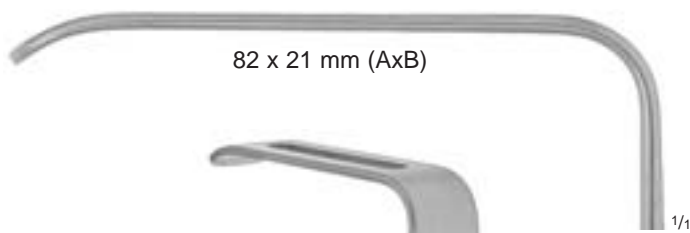

CORYLLOS
37-0447
24,5 cm, 9³/₄"



CORYLLOS
37-0446
24,5 cm, 9³/₄"



CORYLLOS
37-0445
24,5 cm, 9³/₄"





Wundhaken und Lungenspatel

Retractors and Lung Spatulas

Separadores y espátulas para el pulmón

Ecarteurs et spatules pulmonaires

Divaricatori e spatole per polmone

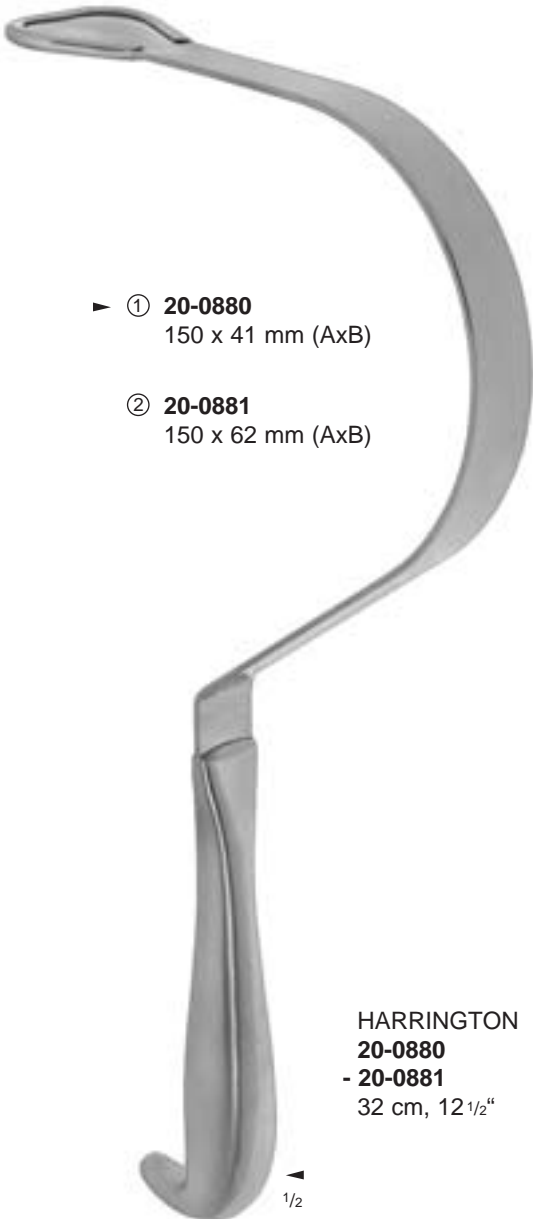
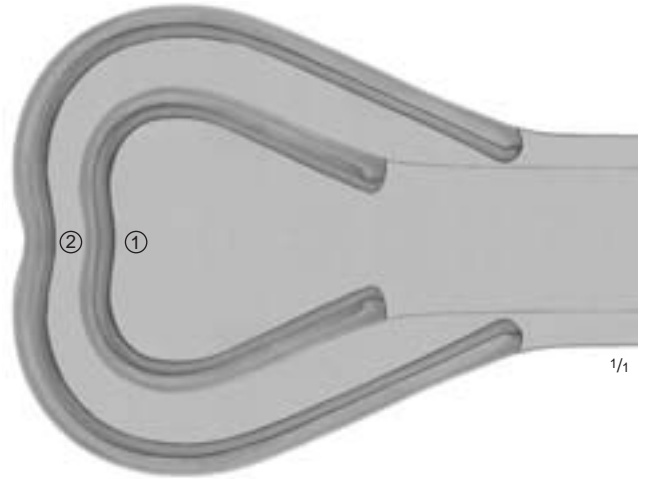
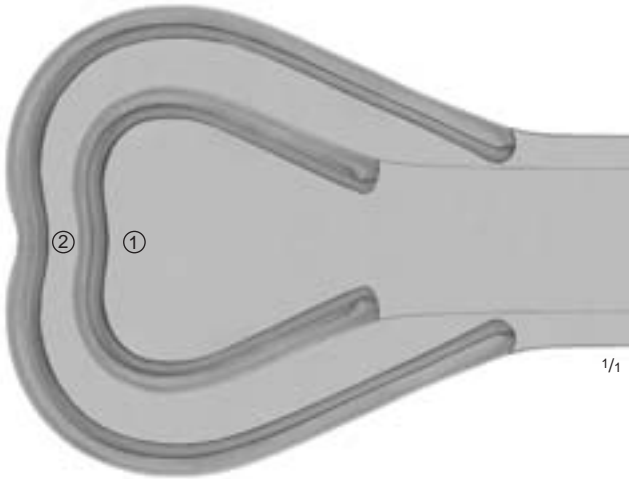
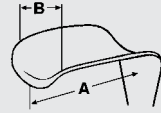

- ▶ ① **20-0880**
150 x 41 mm (AxB)
- ② **20-0881**
150 x 62 mm (AxB)

HARRINGTON
20-0880
- **20-0881**
32 cm, 12 1/2"

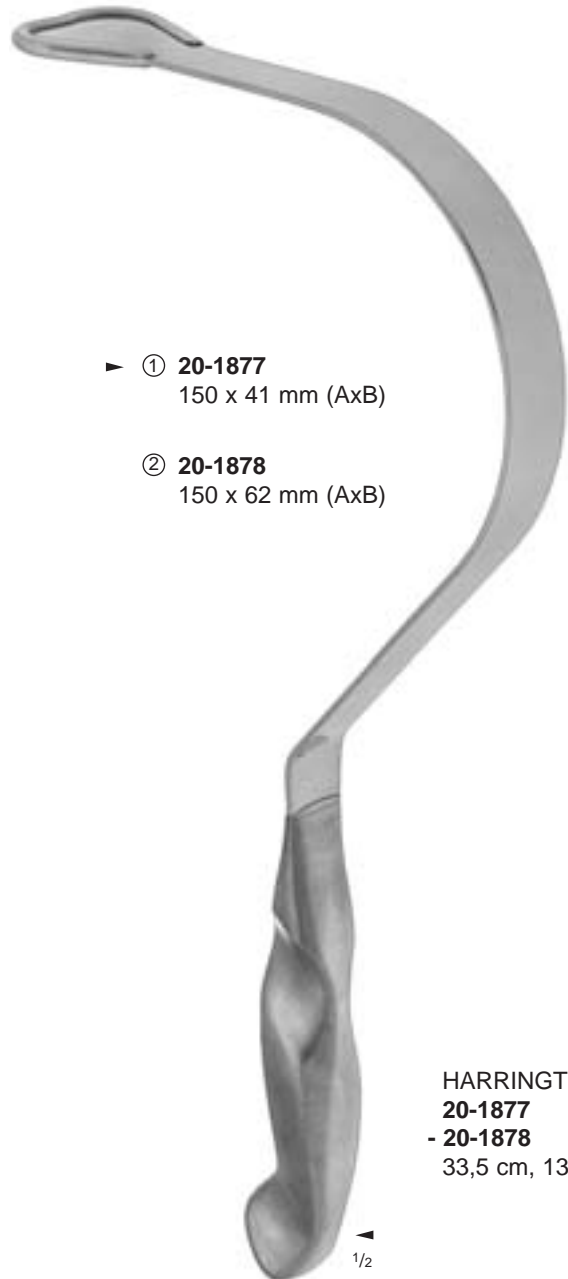

- ▶ ① **20-1877**
150 x 41 mm (AxB)
- ② **20-1878**
150 x 62 mm (AxB)

HARRINGTON
20-1877
- **20-1878**
33,5 cm, 13 1/4"

Wundhaken und Lungenspatel

Retractors and Lung Spatulas

Separadores y espátulas para el pulmón

Ecarteurs et spatules pulmonaires

Divaricatori e spatole per polmone

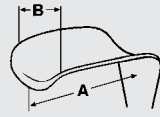

1/1



165 x 50 mm (AxB)

FOSS
20-1872
36,5 cm, 14"

1/2



160 x 50 mm (AxB)

FORD-
DEAVER
20-1792
42 cm, 16 1/2"

1/2



Wundhaken und Lungenspatel

Retractors and Lung Spatulas

Separadores y espátulas para el pulmón

Ecarteurs et spatules pulmonaires

Divaricatori e spatole per polmone

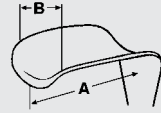

111 x 25 mm (AxB)

DEAVER
20-0803
23 cm, 9"

1/3



40 x 19 mm (AxB)

DEAVER
20-0804
18 cm, 7"

1/3



55 x 22 mm (AxB)

DEAVER
20-0805
22 cm, 8³/₄"

1/3



55 x 25 mm (AxB)

DEAVER
20-0810
23 cm, 9"

1/3



100 x 25 mm (AxB)

DEAVER
20-0806
30 cm, 12"

1/3



100 x 25 mm (AxB)

DEAVER
20-0807
33 cm, 13"

1/3



100 x 25 mm (AxB)

DEAVER
20-0808
36 cm, 14"

1/3

Wundhaken und Lungenspatel

Retractors and Lung Spatulas

Separadores y espátulas para el pulmón

Ecarteurs et spatules pulmonaires

Divaricatori e spatole per polmone

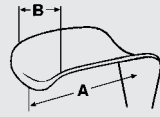

100 x 38 mm (AxB)



DEAVER
20-0809
30 cm, 12"

100 x 50 mm (AxB)



DEAVER
20-0811
30 cm, 12"

100 x 75 mm (AxB)



DEAVER
20-0812
30,5 cm, 12"

100 x 25 mm (AxB)



DEAVER
20-1816
30 cm, 12"

100 x 38 mm (AxB)



DEAVER
20-1831
30 cm, 12"

100 x 50 mm (AxB)



DEAVER
20-1836
30 cm, 12"

100 x 75 mm (AxB)



DEAVER
20-1841
30 cm, 12"



Bauch- und Darmspatel

Abdominal and Intestinal Spatulas
Espátulas abdominales e intestinales
Spatules abdominaux et intestinaux
Spatole addominali e intestinali



1/2

20-0847
170 x 16 mm

biegsam
malleable
maleable
malléable
malleabile



1/2

20-0848
190 x 25 mm

biegsam
malleable
maleable
malléable
malleabile



1/2

▶ **20-0852** 200 x 13 mm
20-0853 200 x 16 mm

biegsam
malleable
maleable
malléable
malleabile



1/2

20-0849 330 x 20 mm
20-0850 330 x 25 mm
20-0855 330 x 30 mm
▶ **20-0860** 330 x 35 mm
20-0861 330 x 40 mm
20-0862 330 x 45 mm
20-0865 330 x 50 mm

biegsam
malleable
maleable
malléable
malleabile

Bauch- und Darmspatel

Abdominal and Intestinal Spatulas
Espátulas abdominales e intestinales
Spatules abdominaux et intestinaux
Spatole addominali e intestinali

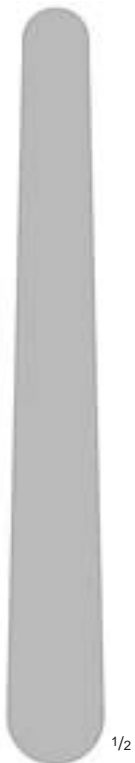

TUFFIER
20-0874
200 x 17/24 mm

biegsam
malleable
maleable
malléable
malleabile



HABERER
20-0873
300 x 40/50 mm

biegsam
malleable
maleable
malléable
malleabile



REVERDIN
20-0871
280 x 41/65 mm

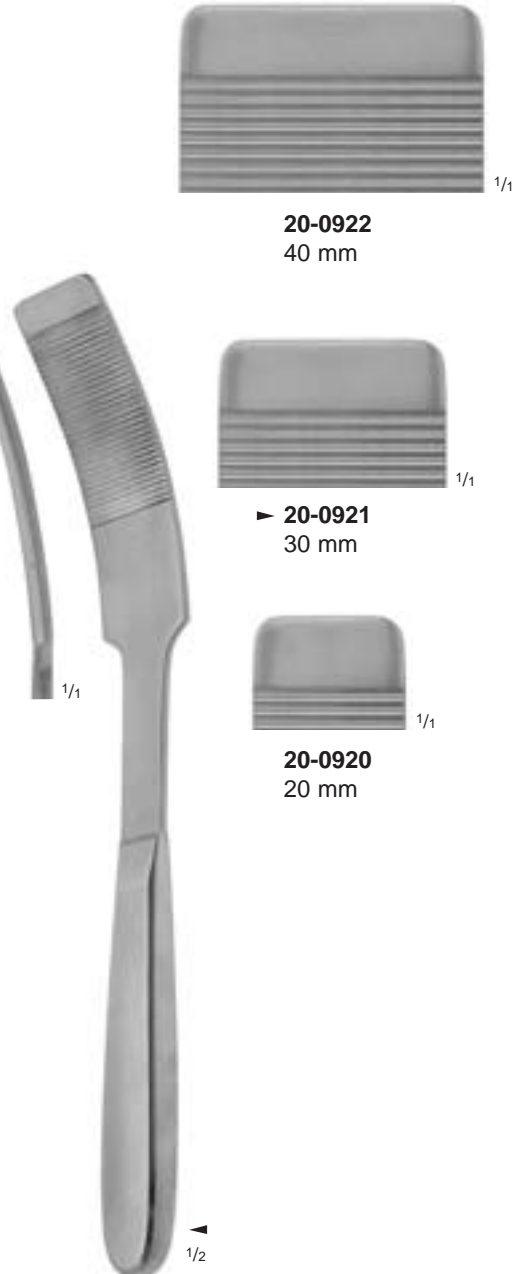

KADER
20-0920
- **20-0922**
26,5 cm, 10 1/2"



Blasenspatel

Bladder Spatulas
Espátulas para la vesícula
Spatules vésicales
Spatole vescicali

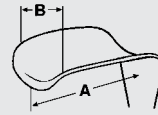

105 x 35 mm (AxB)



LEGUEU
92-0145
27 cm, 10³/₄"

105 x 67 mm (AxB)



KOCHER
92-0150
25 cm, 10"



LAWNTON
Medizintechnik



Wundspreizer (selbsthaltend), Bauchdeckenhalter
Self-Retaining Retractors, Abdominal Retractors
Separadores con retenida automática, Separadores abdominales
Ecarteurs autostatiques, Ecarteurs abdominaux
Divaricatori autostatici, Divaricatori addominali



Wundspreizer, selbsthaltend
 Self-Retaining Retractors
 Separadores con retenida automática
 Ecarteurs autostatiques
 Divaricatori autostatici



► 21-0147
 5 cm, 2"

spitz • sharp • agudo • pointu • acuto



21-0157
 5 cm, 2"

stumpf • blunt • romo • mousse • smusso

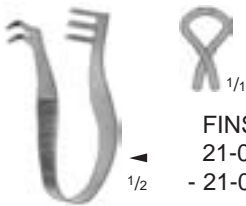

FINSEN
 21-0147
 - 21-0157



► 21-0148
 7 cm, 2 3/4"

spitz • sharp • agudo • pointu • acuto



21-0158
 7 cm, 2 3/4"

stumpf • blunt • romo • mousse • smusso

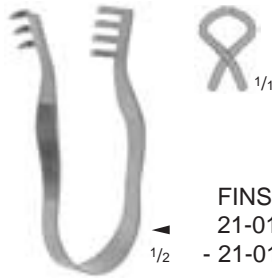

FINSEN
 21-0148
 - 21-0158

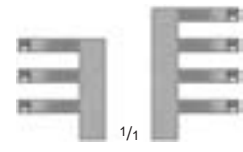

► 21-0149
 7 cm, 2 3/4"

spitz • sharp • agudo • pointu • acuto

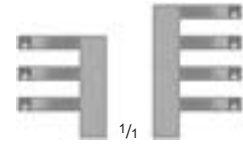

21-0159
 7 cm, 2 3/4"

stumpf • blunt • romo • mousse • smusso

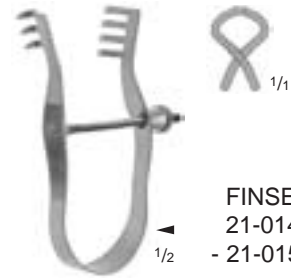

FINSEN
 21-0149
 - 21-0159

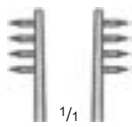

► 21-0150
 7 cm, 2 3/4"

spitz • sharp • agudo • pointu • acuto

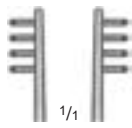

21-0151
 7 cm, 2 3/4"

stumpf • blunt • romo • mousse • smusso



ALM
 21-0150
 - 21-0151

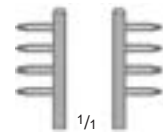

► 21-0152
 10 cm, 4"

spitz • sharp • agudo • pointu • acuto

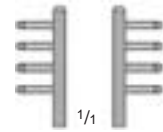

21-0153
 10 cm, 4"

stumpf • blunt • romo • mousse • smusso



ALM
 21-0152
 - 21-0153

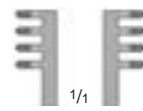

► 21-0155
 10 cm, 4"

spitz • sharp • agudo • pointu • acuto



21-0156
 10 cm, 4"

stumpf • blunt • romo • mousse • smusso



21-0155
 - 21-0156

Wundspreizer, selbsthaltend
 Self-Retaining Retractors
 Separadores con retenida automática
 Ecarteurs autostatiques
 Divaricatori autostatici

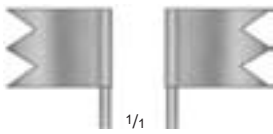

spitz • sharp • agudo • pointu • acuto

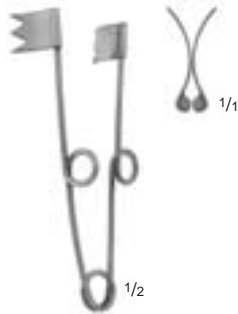

21-0128
 8 cm, 3 1/8"

Wundspreizer, selbsthaltend
 Self-retaining retractor
 Separador con retenida automática
 Ecarteur autostatiques
 Divaricatore autostatici



VICKERS
 21-0170
 4,5 cm, 1 3/4"

Finger-Wundspreizer
 Finger retractor
 Separador para dedos
 Ecarteur pour doigts
 Divaricatore per dita

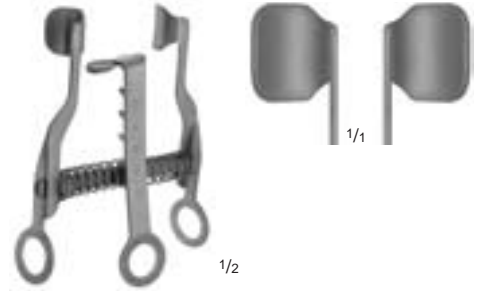

VICKERS
 21-0172
 8 cm, 3 1/8"

Schnellender Finger- und kleiner Schnitt-Wund-
 spreizer, mit Mittelvalve 18 x 10 mm (21-0179)

Trigger finger and small wound retractor, with
 central valve 18 x 10 mm (21-0179)

Separador para dedos y pequeñas heridas, con
 valva central 18 x 10 mm (21-0179)

Ecarteur pour doigts et petites plaies, avec valve
 médiane 18 x 10 mm (21-0179)

Impugnatura a molla per dita e piccolo divaricatore
 per ferite, con valva centrale 18 x 10 mm (21-0179)



stumpf • blunt • romo • mousse • smusso



VICKERS
 21-0174
 9 cm, 3 1/2"

Hand- und Carpal-Tunnel-Wundspreizer, mit Mittelvalve 18 x 10 mm (21-0179)
 Hand and carpal tunnel retractor, with central valve 18 x 10 mm (21-0179)
 Separador de mano y túnel de carpo, con valva central 18 x 10 mm (21-0179)
 Ecarteur pour mains et tunnel carpien, avec valve médiane 18 x 10 mm (21-0179)
 Divaricatore per la mano con condotto carpale, con valva centrale 18 x 10 mm (21-0179)



stumpf • blunt • romo • mousse • smusso

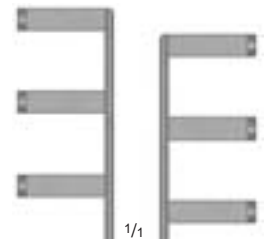

VICKERS
 21-0176
 10 cm, 4"

Hand- und Unterarm-Wundspreizer, mit Mittelvalve 18 x 10 mm (21-0179)
 Deep hand and forearm retractor, with central valve 18 x 10 mm (21-0179)
 Separador profundo para mano y antebrazo, con valva central 18 x 10 mm (21-0179)
 Ecarteur profond pour main et avant bras, avec valve médiane 18 x 10 mm (21-0179)
 Divaricatore per la mano e l'avambraccio, con valva centrale 18 x 10 mm (21-0179)



Wundspreizer, selbsthaltend
 Self-Retaining Retractors
 Separadores con retenida automática
 Ecarteurs autostatiques
 Divaricatori autostatici

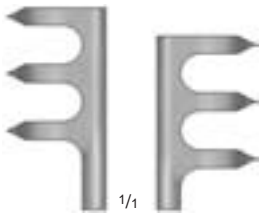

spitz • sharp • agudo • pointu • acuto

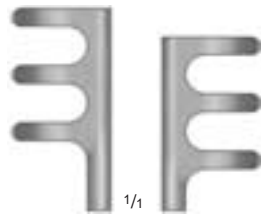

stumpf • blunt • romo • mousse • smusso

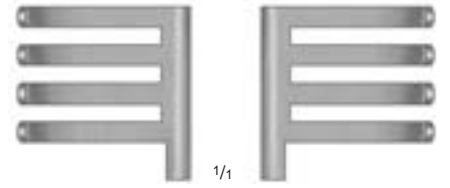

stumpf • blunt • romo • mousse • smusso



JANSEN
 66-0700
 10 cm, 4"



JANSEN
 66-0701
 10 cm, 4"

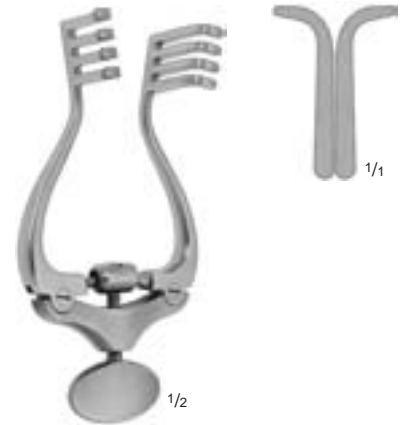

JANSEN
 52-0350
 11 cm, 4 3/8"



► 21-0195
 10,5 cm, 4 1/8"
 spitz • sharp • agudo
 pointu • acuto



21-0196
 10,5 cm, 4 1/8"
 stumpf • blunt • romo
 mousse • smusso



► 21-0200
 13,5 cm, 5 1/4"
 spitz • sharp • agudo
 pointu • acuto

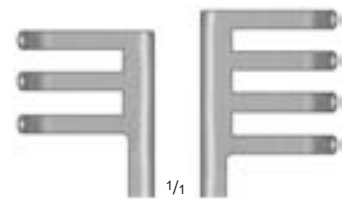

21-0220
 13,5 cm, 5 1/4"
 stumpf • blunt • romo
 mousse • smusso

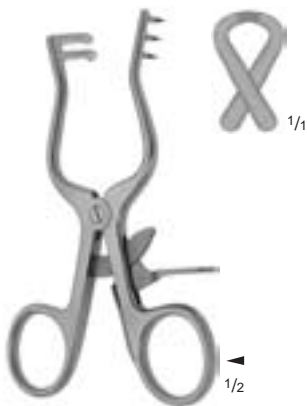

WEITLANER
 21-0195
 - 21-0196

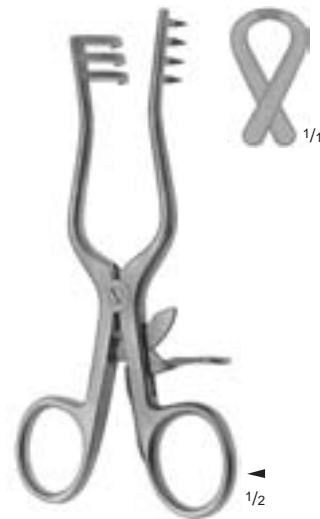

WEITLANER
 21-0200
 - 21-0220



▶ 21-0205
 16,5 cm, 6 1/2"

spitz • sharp • agudo • pointu • acuto



▶ 21-0210
 19,5 cm, 7 3/4"

spitz • sharp • agudo • pointu • acuto

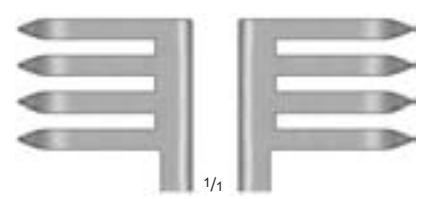

▶ 21-0260
 19,5 cm, 7 3/4"

spitz • sharp • agudo • pointu • acuto



21-0225
 16,5 cm, 6 1/2"

stumpf • blunt • romo • mousse • smusso

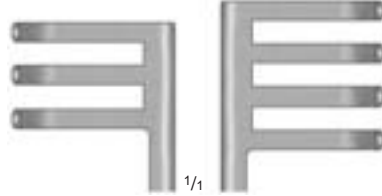

21-0230
 19,5 cm, 7 3/4"

stumpf • blunt • romo • mousse • smusso

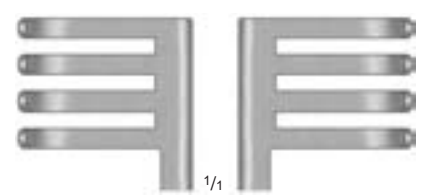

21-0263
 19,5 cm, 7 3/4"

stumpf • blunt • romo • mousse • smusso



WEITLANER
 21-0205
 - 21-0225



WEITLANER
 21-0210
 - 21-0230



ADSON
 21-0260
 - 21-0263



Wundspreizer, selbsthaltend
 Self-Retaining Retractors
 Separadores con retenida automática
 Ecarteurs autostatiques
 Divaricatori autostatici



▶ 21-0215
 25 cm, 10"

spitz • sharp • agudo • pointu • acuto

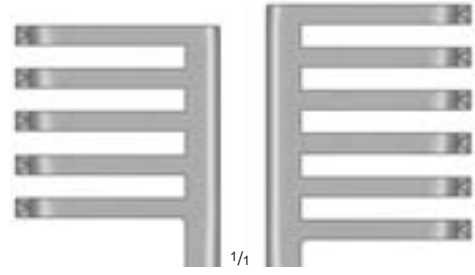

▶ 21-0216
 25,5 cm, 10"

spitz • sharp • agudo • pointu • acuto



21-0235
 25 cm, 10"

stumpf • blunt • romo • mousse • smusso

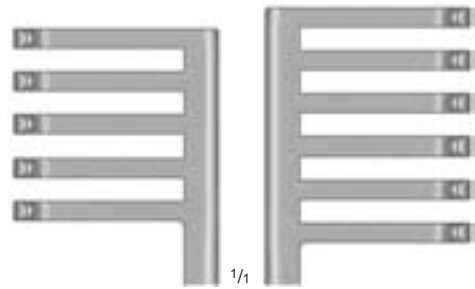

21-0217
 25,5 cm, 10"

stumpf • blunt • romo • mousse • smusso



WEITLANER
 21-0215
 - 21-0235



WEITLANER
 21-0216
 - 21-0217

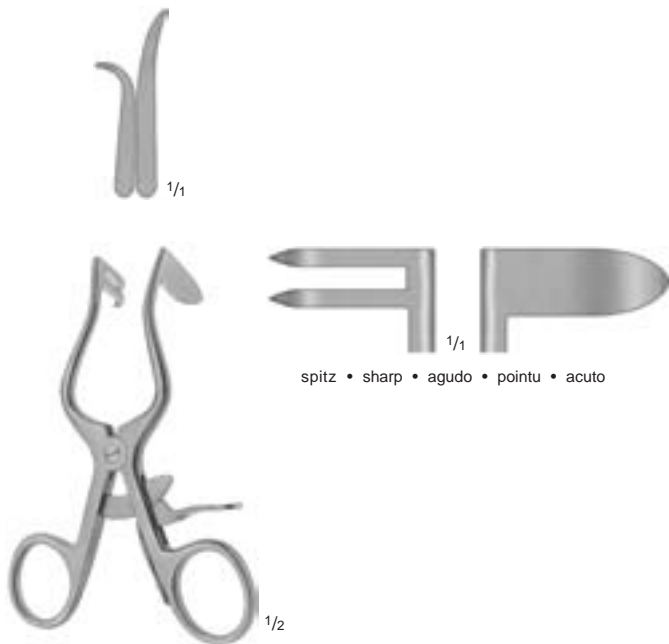

PLESTER
 21-0282
 10,5 cm, 4 1/8"

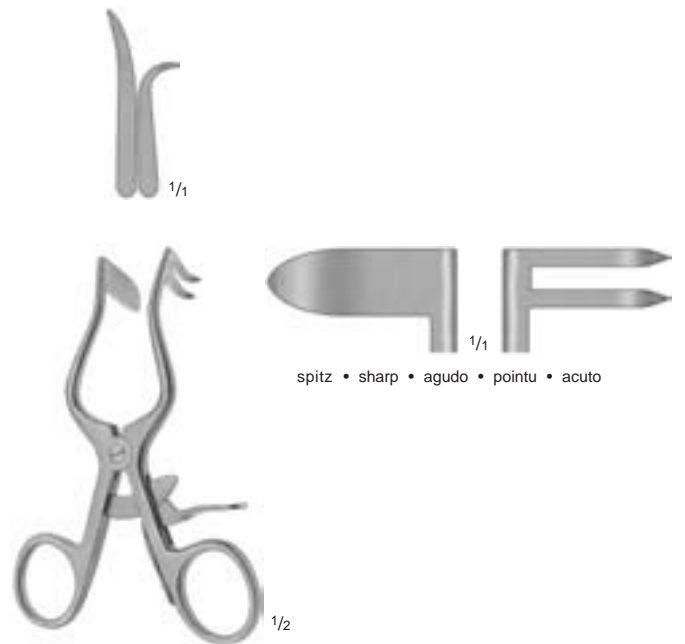

PLESTER
 21-0283
 10,5 cm, 4 1/8"

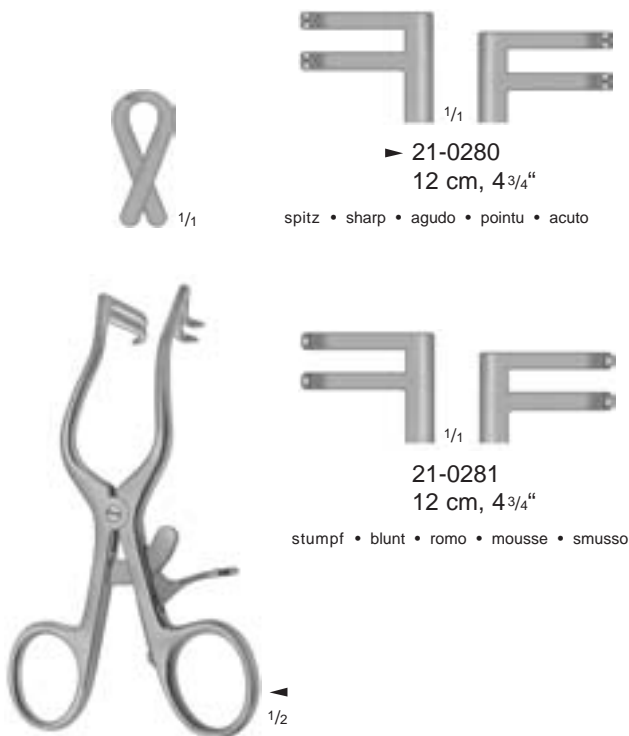

PLESTER
 21-0280
 - 21-0281

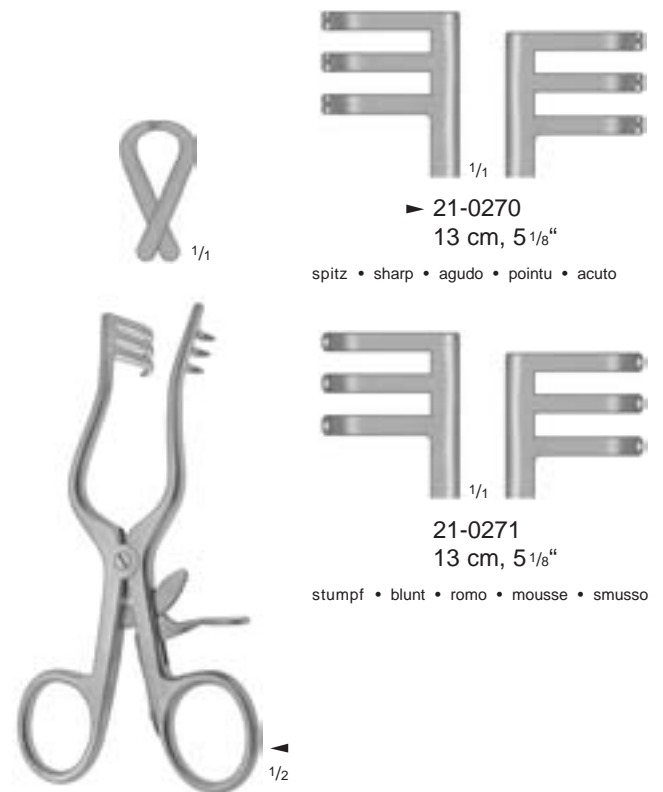

WULLSTEIN
 21-0270
 - 21-0271



Wundspreizer, selbsthaltend
 Self-Retaining Retractors
 Separadores con retenida automática
 Ecarteurs autostatiques
 Divaricatori autostatici



► 52-0394
 13,5 cm, 5 1/4"

spitz • sharp • agudo • pointu • acuto



52-0395
 13,5 cm, 5 1/4"

stumpf • blunt • romo • mousse • smusso



SCALP CONTOUR
 52-0394
 - 52-0395

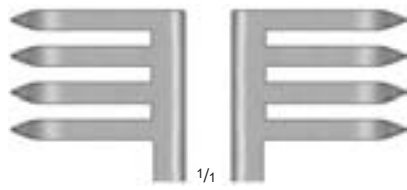

spitz • sharp • agudo • pointu • acuto



ANDERSON-ADSON
 21-0266
 19 cm, 7 1/2"



spitz • sharp • agudo • pointu • acuto



ADSON
 21-0261
 28 cm, 11"

Laminektomie-Wundspreizer
 Laminectomy retractor
 Separador para laminectomia
 Ecarteurs pour laminectomie
 Divaricatori per laminectomia

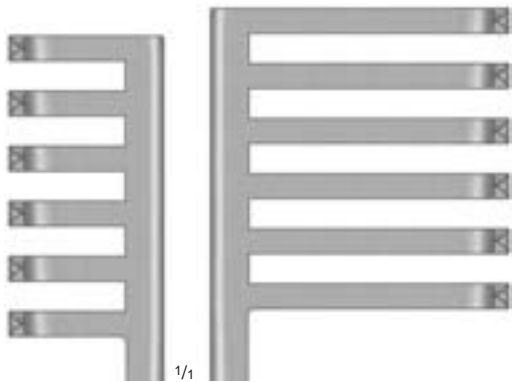

spitz • sharp • agudo • pointu • acuto

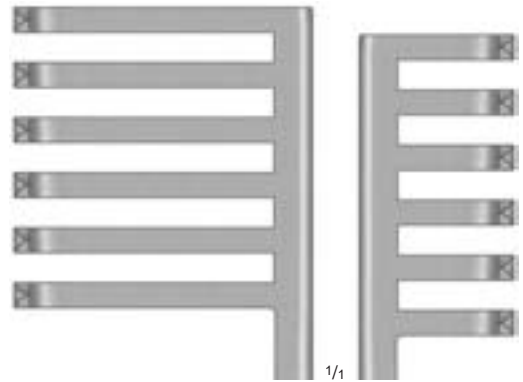

spitz • sharp • agudo • pointu • acuto



ADSON
 21-0267
 28,5 cm, 11 1/4"



ADSON
 21-0268
 28,5 cm, 11 1/4"



Wundspreizer, selbsthaltend
 Self-Retaining Retractors
 Separadores con retenida automática
 Ecarteurs autostatiques
 Divaricatori autostatici



▶ 21-0240
 14 cm, 5 1/2"

spitz • sharp • agudo • pointu • acuto

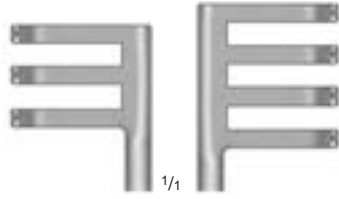

▶ 21-0242
 16 cm, 6 1/4"

spitz • sharp • agudo • pointu • acuto



▶ 21-0245
 21 cm, 8 1/4"

spitz • sharp • agudo • pointu • acuto



21-0241
 14 cm, 5 1/2"

stumpf • blunt • romo • mousse • smusso

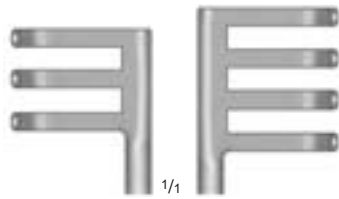

21-0243
 16 cm, 6 1/4"

stumpf • blunt • romo • mousse • smusso

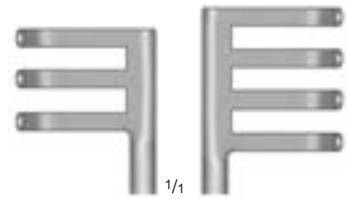

21-0246
 21 cm, 8 1/4"

stumpf • blunt • romo • mousse • smusso

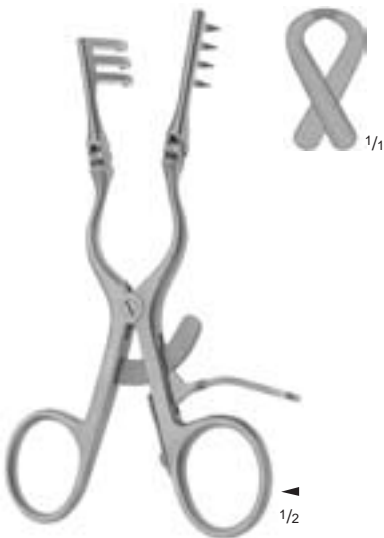

ADSON
 21-0240
 - 21-0241



ADSON
 21-0242
 - 21-0243



ADSON
 21-0245
 - 21-0246

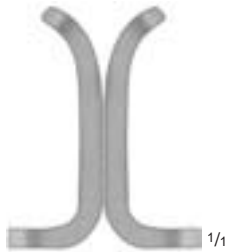

1/1

► 52-0491
 30,5 cm, 12"

spitz • sharp • agudo • pointu • acuto

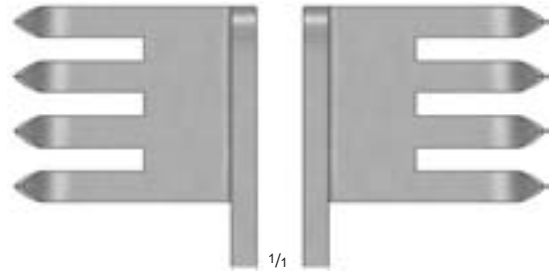

1/1

52-0490
 30,5 cm, 12"

stumpf • blunt • romo • mousse • smusso

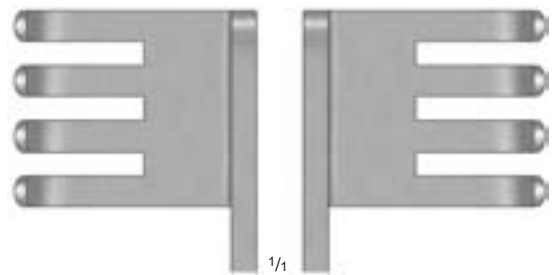

1/1

52-0494
 30,5 cm, 12"

spitz • sharp • agudo • pointu • acuto

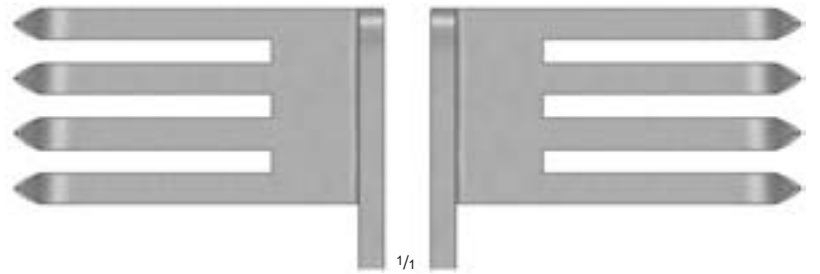

1/1

52-0497
 30,5 cm, 12"

stumpf • blunt • romo • mousse • smusso



1/2

BECKMANN-ADSON
 52-0490
 - 52-0497



Laminektomie-Wundspreizer
 Laminectomy Retractors
 Separadores para laminectomía
 Ecarteurs pour laminectomie
 Divaricatori per laminectomia

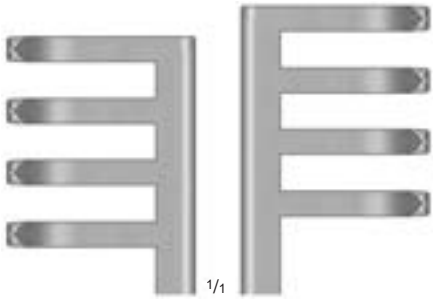

spitz • sharp • agudo • pointu • acuto

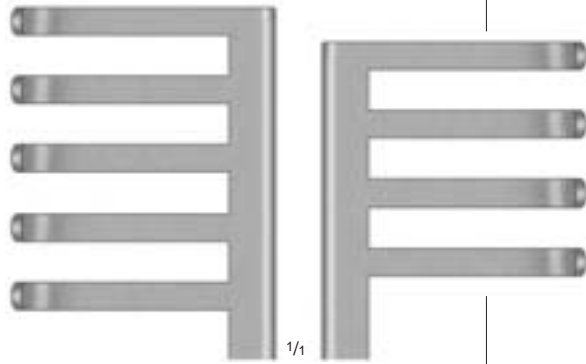

stumpf • blunt • romo • mousse • smusso

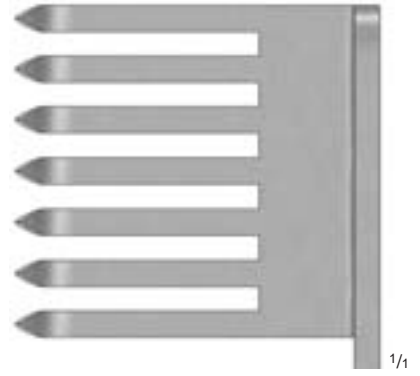

spitz • sharp • agudo • pointu • acuto



BECKMANN
 12-0410
 31,5 cm, 12 1/2"



ADSON
 52-0499
 33 cm, 13"



BECKMANN-EATON
 21-0252
 32 cm, 12 1/2"

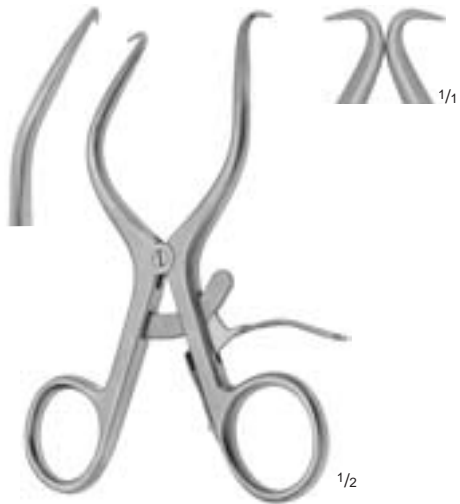

GELPI-BABY
 21-0306
 13 cm, 5 1/8"

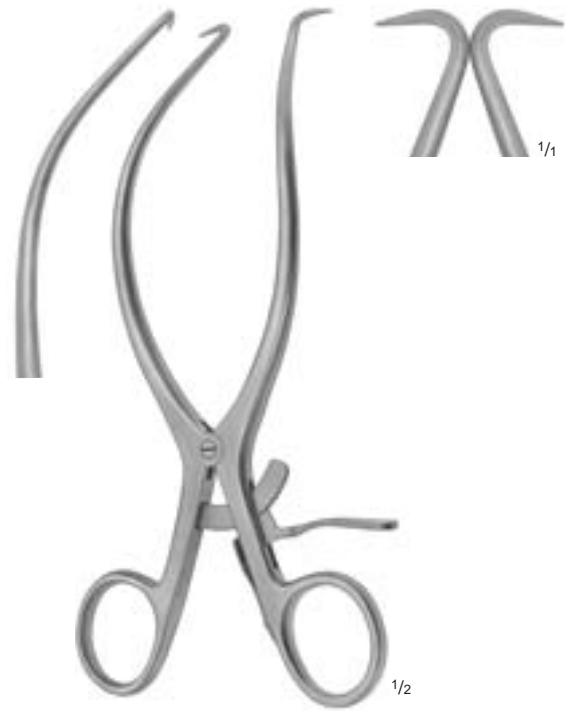

GELPI
 21-0300
 18,5 cm, 7 1/4"

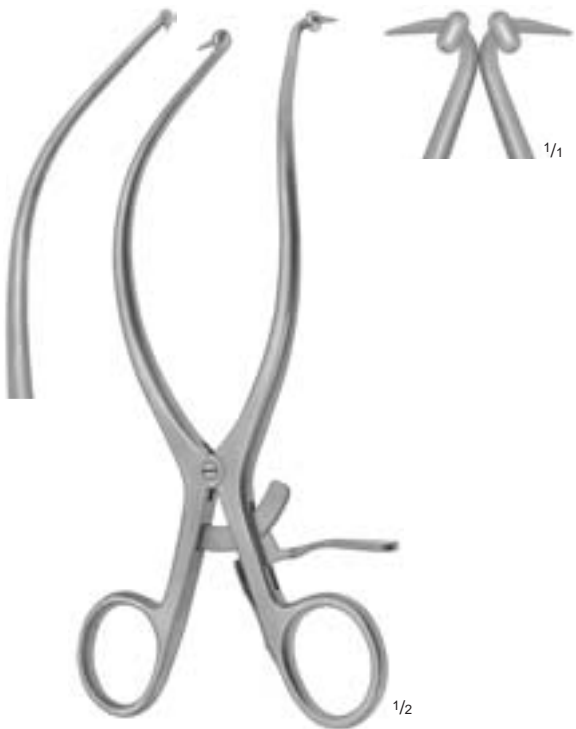

GELPI
 21-0305
 19 cm, 7 1/2"



GELPI-SELETZ
 21-0301
 16 cm, 6 1/4"



Wundspreizer, selbsthaltend
Self-Retaining Retractors
Separadores con retenida automática
Ecarteurs autostatiques
Divaricatori autostatici

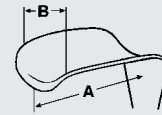

spitz • sharp • agudo • pointu • acuto

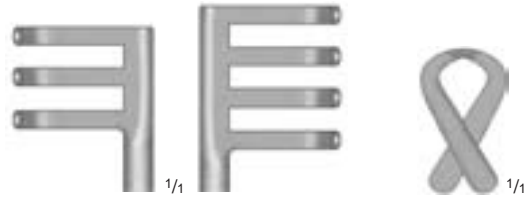

stumpf • blunt • romo • mousse • smusso

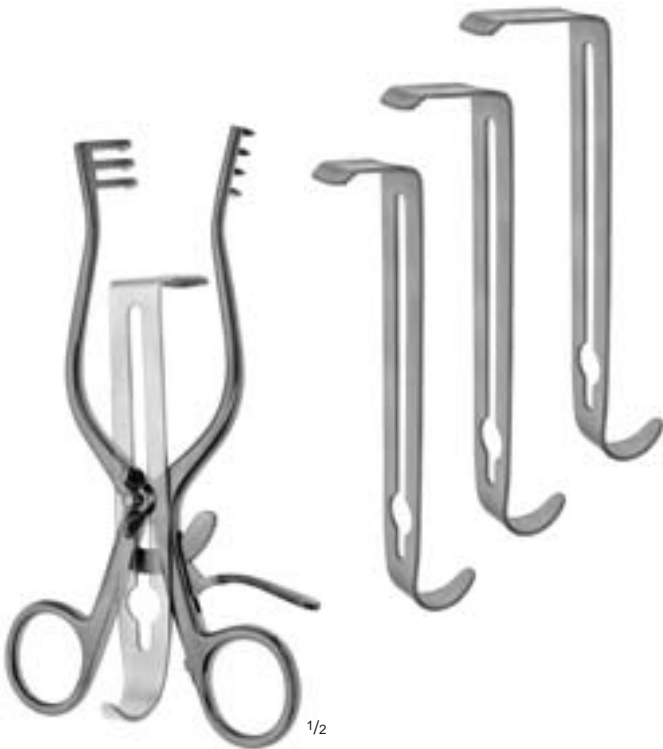

HENLEY

21-0325

16,5 cm, 6 1/2"

Wundspreizer, komplett, bestehend aus:

- 21-0326 1 Sperrer mit Seitenvalven, spitz
- 21-0327 1 gezahnten Mittelvalve 19 x 16 mm (AxB)
- 21-0328 1 gezahnten Mittelvalve 26 x 16 mm (AxB)
- 21-0329 1 gezahnten Mittelvalve 32 x 16 mm (AxB)

Self-retaining retractor, complete, consisting of:

- 21-0326 1 Spreader with lateral valves, sharp
- 21-0327 1 Central valve, serrated, 19 x 16 mm (AxB)
- 21-0328 1 Central valve, serrated, 26 x 16 mm (AxB)
- 21-0329 1 Central valve, serrated, 32 x 16 mm (AxB)

Separador, completo, compuesto de:

- 21-0326 1 Separador con valvas laterales agudas
- 21-0327 1 Valva central, dentada, 19 x 16 mm (AxB)
- 21-0328 1 Valva central, dentada, 26 x 16 mm (AxB)
- 21-0329 1 Valva central, dentada, 32 x 16 mm (AxB)

Ecarteur, complet, composé de:

- 21-0326 1 Ecarteur avec valvas latérales, griffes pointues
- 21-0327 1 Valve centrale, dentellée, 19 x 16 mm (AxB)
- 21-0328 1 Valve centrale, dentellée, 26 x 16 mm (AxB)
- 21-0329 1 Valve centrale, dentellée, 32 x 16 mm (AxB)

Divaricatore, completo, composto da:

- 21-0326 1 Divaricatore con valve laterali, acuto
- 21-0327 1 Valva centrale, dentellata, 19 x 16 mm (AxB)
- 21-0328 1 Valva centrale, dentellata, 26 x 16 mm (AxB)
- 21-0329 1 Valva centrale, dentellata, 32 x 16 mm (AxB)



HENLEY

21-0335

16,5 cm, 6 1/2"

Wundspreizer, komplett, bestehend aus:

- 21-0336 1 Sperrer mit Seitenvalven, stumpf
- 21-0327 1 gezahnten Mittelvalve 19 x 16 mm (AxB)
- 21-0328 1 gezahnten Mittelvalve 26 x 16 mm (AxB)
- 21-0329 1 gezahnten Mittelvalve 32 x 16 mm (AxB)

Self-retaining retractor, complete, consisting of:

- 21-0336 1 Spreader with lateral valves, blunt
- 21-0327 1 Central valve, serrated, 19 x 16 mm (AxB)
- 21-0328 1 Central valve, serrated, 26 x 16 mm (AxB)
- 21-0329 1 Central valve, serrated, 32 x 16 mm (AxB)

Separador, completo, compuesto de:

- 21-0336 1 Separador con valvas laterales romas
- 21-0327 1 Valva central, dentada, 19 x 16 mm (AxB)
- 21-0328 1 Valva central, dentada, 26 x 16 mm (AxB)
- 21-0329 1 Valva central, dentada, 32 x 16 mm (AxB)

Ecarteur, complet, composé de:

- 21-0336 1 Ecarteur avec valvas latérales, griffes mous
- 21-0327 1 Valve centrale, dentellée, 19 x 16 mm (AxB)
- 21-0328 1 Valve centrale, dentellée, 26 x 16 mm (AxB)
- 21-0329 1 Valve centrale, dentellée, 32 x 16 mm (AxB)

Divaricatore, completo, composto da:

- 21-0336 1 Divaricatore con valve laterali, smusso
- 21-0327 1 Valva centrale, dentellata, 19 x 16 mm (AxB)
- 21-0328 1 Valva centrale, dentellata, 26 x 16 mm (AxB)
- 21-0329 1 Valva centrale, dentellata, 32 x 16 mm (AxB)

Wundspreizer, selbsthaltend
 Self-Retaining Retractors
 Separadores con retenida automática
 Ecarteurs autostatiques
 Divaricatori autostatici

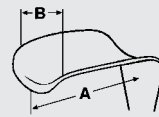

In Peripheral-Chirurgie zu verwenden!
 To be used for peripheral vascular surgery!
 Uso para cirugía periférica!
 Utilise pour la chirurgie vasculaire périphérique!
 Da impiegarsi in interventi vascolari periferici!



21-0327
 19 x 16 mm (Ax B)

21-0328
 26 x 16 mm (Ax B)

21-0329
 32 x 16 mm (Ax B)

21-0374
 76 x 16 mm (Ax B)



HENLEY
 21-0365
 18 cm, 7"

Wundspreizer, komplett, bestehend aus:
 21-0366 1 Sperrer
 21-0327 1 gezahnten Mittelvalve
 19 x 16 mm (Ax B)
 21-0328 1 gezahnten Mittelvalve
 26 x 16 mm (Ax B)
 21-0329 1 gezahnten Mittelvalve
 32 x 16 mm (Ax B)
 21-0374 1 gezahnten Mittelvalve
 76 x 16 mm (Ax B)
 21-0367 1 Paar stumpfen Seiten-
 valven 25 x 23 mm (Ax B)
 21-0368 1 Paar stumpfen Seiten-
 valven 50 x 23 mm (Ax B)
 21-0369 1 Paar stumpfen Seiten-
 valven 75 x 23 mm (Ax B)



21-0367
 25 x 23 mm (Ax B)



21-0368
 50 x 23 mm (Ax B)

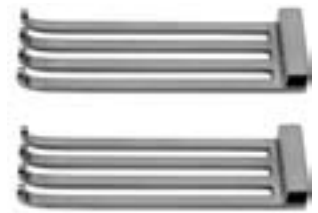

21-0369
 75 x 23 mm (Ax B)

Self-retaining retractor, complete, consisting of:

- 21-0366 1 Spreader
- 21-0327 1 Central valve, serrated,
19 x 16 mm (Ax B)
- 21-0328 1 Central valve, serrated,
26 x 16 mm (Ax B)
- 21-0329 1 Central valve, serrated,
32 x 16 mm (Ax B)
- 21-0374 1 Central valve, serrated,
76 x 16 mm (Ax B)
- 21-0367 1 Pair lateral valves,
blunt, 25 x 23 mm (Ax B)
- 21-0368 1 Pair lateral valves,
blunt, 50 x 23 mm (Ax B)
- 21-0369 1 Pair lateral valves,
blunt, 75 x 23 mm (Ax B)

Ecarteur, complet, composé de:

- 21-0366 1 Ecarteur
- 21-0327 1 Valve centrale, dentelée,
19 x 16 mm (Ax B)
- 21-0328 1 Valve centrale, dentelée,
26 x 16 mm (Ax B)
- 21-0329 1 Valve centrale, dentelée,
32 x 16 mm (Ax B)
- 21-0374 1 Valve centrale, dentelée,
76 x 16 mm (Ax B)
- 21-0367 1 Paire de valves latérales,
mousses, 25 x 23 mm (Ax B)
- 21-0368 1 Paire de valves latérales,
mousses, 50 x 23 mm (Ax B)
- 21-0369 1 Paire de valves latérales,
mousses, 75 x 23 mm (Ax B)

Separador, completo, compuesto de:

- 21-0366 1 Separador
- 21-0327 1 Valva central, dentada,
19 x 16 mm (Ax B)
- 21-0328 1 Valva central, dentada,
26 x 16 mm (Ax B)
- 21-0329 1 Valva central, dentada,
32 x 16 mm (Ax B)
- 21-0374 1 Valva central, dentada,
76 x 16 mm (Ax B)
- 21-0367 1 Par de valvas laterales, romas,
25 x 23 mm (Ax B)
- 21-0368 1 Par de valvas laterales, romas,
50 x 23 mm (Ax B)
- 21-0369 1 Par de valvas laterales, romas,
75 x 23 mm (Ax B)

Divaricatore, completo, composto da:

- 21-0366 1 Divaricatore
- 21-0327 1 Valva centrale, dentellata,
19 x 16 mm (Ax B)
- 21-0328 1 Valva centrale, dentellata,
26 x 16 mm (Ax B)
- 21-0329 1 Valva centrale, dentellata,
32 x 16 mm (Ax B)
- 21-0374 1 Valva centrale, dentellata,
76 x 16 mm (Ax B)
- 21-0367 1 Paio di valve laterali, smusse,
25 x 23 mm (Ax B)
- 21-0368 1 Paio di valve laterali, smusse,
50 x 23 mm (Ax B)
- 21-0369 1 Paio di valve laterali, smusse,
75 x 23 mm (Ax B)



Appendektomie-Wundspreizer
 Appendectomy Retractors
 Separadores para apendectomía
 Ecarteurs pour appendicectomie
 Divaricatori per appendicectomia

Laminektomie-Wundspreizer
 Laminectomy Retractors
 Separadores para laminectomía
 Ecarteurs pour laminectomie
 Divaricatori per laminectomia



MAYO-ADAMS
 21-0320
 17 cm, 6³/₄"

Appendektomie-Wundspreizer, ohne Mittelvalve
 Appendectomy Retractor, without central valve
 Separador para apendectomía, sin valva central
 Ecarteur pour appendicectomie, sans valve médiane
 Divaricatore per appendicectomia, senza valva centrale

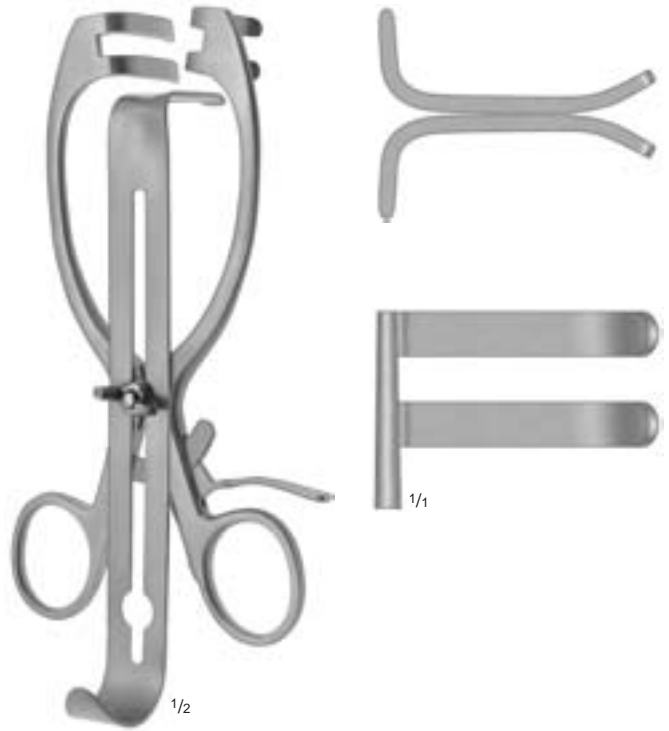

MAYO-ADAMS
 21-0310
 17 cm, 6³/₄"

Appendektomie-Wundspreizer, mit Mittelvalve 42 x 14 mm (21-0311)
 Appendectomy Retractor, with central valve 42 x 14 mm (21-0311)
 Separador para apendectomía, con valva central 42 x 14 mm (21-0311)
 Ecarteur pour appendicectomie, avec valve médiane 42 x 14 mm (21-0311)
 Divaricatore per appendicectomia, con valva centrale 42 x 14 mm (21-0311)

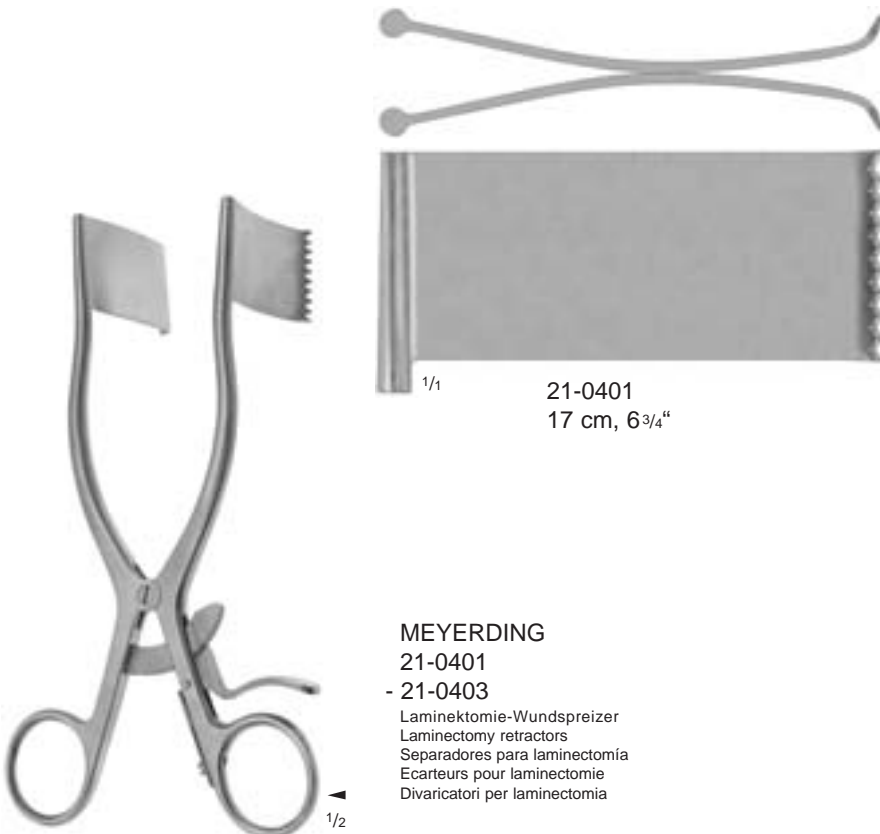

MEYERDING
 21-0401
 - 21-0403
 Laminektomie-Wundspreizer
 Laminectomy retractors
 Separadores para laminectomía
 Ecarteurs pour laminectomie
 Divaricatori per laminectomia

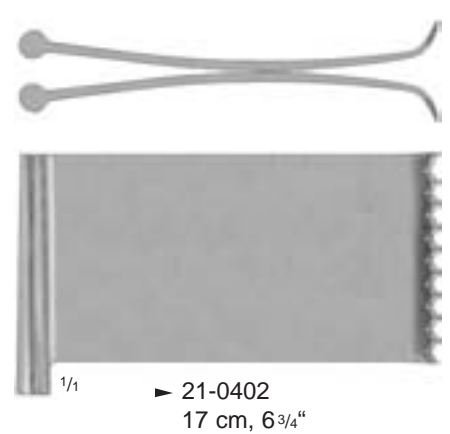

21-0402
 17 cm, 6³/₄"



21-0403
 17 cm, 6³/₄"

Wundspreizer für die cervicale Wirbelsäule
 Retractors for cervical spine
 Separadores para la columna cervical
 Ecarteurs pour colonne cervicale
 Divaricatori per colonna cervicale

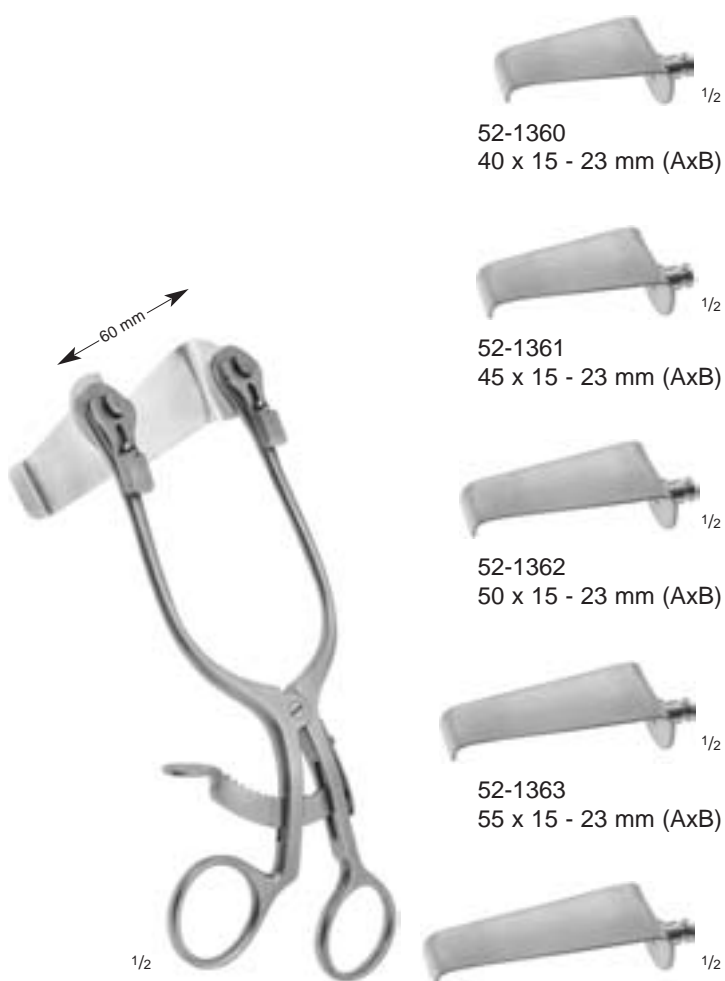
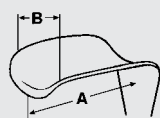

CLOWARD
 52-1355
 17 cm, 6^{3/4}"

52-1364
 60 x 15 - 23 mm (AxB)

Wundspreizer, komplett, bestehend aus:
 52-1356 1 Sperrer
 52-1360 1 stumpfen Seitenvalve 40 x 15 - 23 mm
 52-1361 1 stumpfen Seitenvalve 45 x 15 - 23 mm
 52-1362 1 stumpfen Seitenvalve 50 x 15 - 23 mm
 52-1363 1 stumpfen Seitenvalve 55 x 15 - 23 mm
 52-1364 1 stumpfen Seitenvalve 60 x 15 - 23 mm

Self-retaining retractor, complete, consisting of:
 52-1356 1 Spreader
 52-1360 1 Lateral valve, blunt, 40 x 15 - 23 mm
 52-1361 1 Lateral valve, blunt, 45 x 15 - 23 mm
 52-1362 1 Lateral valve, blunt, 50 x 15 - 23 mm
 52-1363 1 Lateral valve, blunt, 55 x 15 - 23 mm
 52-1364 1 Lateral valve, blunt, 60 x 15 - 23 mm

Separador, completo, compuesto de:
 52-1356 1 Separador
 52-1360 1 Valva lateral, roma, 40 x 15 - 23 mm
 52-1361 1 Valva lateral, roma, 45 x 15 - 23 mm
 52-1362 1 Valva lateral, roma, 50 x 15 - 23 mm
 52-1363 1 Valva lateral, roma, 55 x 15 - 23 mm
 52-1364 1 Valva lateral, roma, 60 x 15 - 23 mm

Ecarteur, complet, composé de:
 52-1356 1 Ecarteur
 52-1360 1 Valve latérale, mousse, 40 x 15 - 23 mm
 52-1361 1 Valve latérale, mousse, 45 x 15 - 23 mm
 52-1362 1 Valve latérale, mousse, 50 x 15 - 23 mm
 52-1363 1 Valve latérale, mousse, 55 x 15 - 23 mm
 52-1364 1 Valve latérale, mousse, 60 x 15 - 23 mm

Divaricatore, completo, composto da:
 52-1356 1 Divaricatore
 52-1360 1 Valva laterale, smussa, 40 x 15 - 23 mm
 52-1361 1 Valva laterale, smussa, 45 x 15 - 23 mm
 52-1362 1 Valva laterale, smussa, 50 x 15 - 23 mm
 52-1363 1 Valva laterale, smussa, 55 x 15 - 23 mm
 52-1364 1 Valva laterale, smussa, 60 x 15 - 23 mm

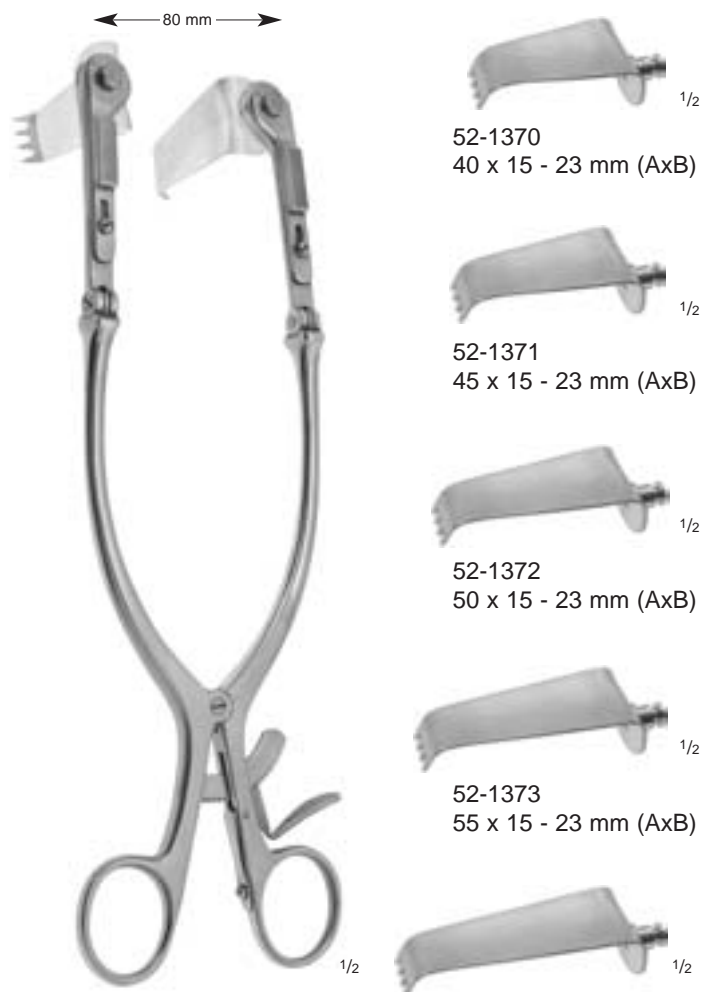

CLOWARD
 52-1345
 25 cm, 10"

52-1374
 60 x 15 - 23 mm (AxB)

Wundspreizer, komplett, bestehend aus:
 52-1346 1 Sperrer
 52-1370 1 gezahnten Seitenvalve 40 x 15 - 23 mm
 52-1371 1 gezahnten Seitenvalve 45 x 15 - 23 mm
 52-1372 1 gezahnten Seitenvalve 50 x 15 - 23 mm
 52-1373 1 gezahnten Seitenvalve 55 x 15 - 23 mm
 52-1374 1 gezahnten Seitenvalve 60 x 15 - 23 mm

Self-retaining retractor, complete, consisting of:
 52-1346 1 Spreader
 52-1370 1 Lateral valve, serrated, 40 x 15 - 23 mm
 52-1371 1 Lateral valve, serrated, 45 x 15 - 23 mm
 52-1372 1 Lateral valve, serrated, 50 x 15 - 23 mm
 52-1373 1 Lateral valve, serrated, 55 x 15 - 23 mm
 52-1374 1 Lateral valve, serrated, 60 x 15 - 23 mm

Separador, completo, compuesto de:
 52-1346 1 Separador
 52-1370 1 Valva lateral, dentada, 40 x 15 - 23 mm
 52-1371 1 Valva lateral, dentada, 45 x 15 - 23 mm
 52-1372 1 Valva lateral, dentada, 50 x 15 - 23 mm
 52-1373 1 Valva lateral, dentada, 55 x 15 - 23 mm
 52-1374 1 Valva lateral, dentada, 60 x 15 - 23 mm

Ecarteur, complet, composé de:
 52-1346 1 Ecarteur
 52-1370 1 Valve latérale, dentelée, 40 x 15 - 23 mm
 52-1371 1 Valve latérale, dentelée, 45 x 15 - 23 mm
 52-1372 1 Valve latérale, dentelée, 50 x 15 - 23 mm
 52-1373 1 Valve latérale, dentelée, 55 x 15 - 23 mm
 52-1374 1 Valve latérale, dentelée, 60 x 15 - 23 mm

Divaricatore, completo, composto da:
 52-1346 1 Divaricatore
 52-1370 1 Valva laterale, dentellata, 40 x 15 - 23 mm
 52-1371 1 Valva laterale, dentellata, 45 x 15 - 23 mm
 52-1372 1 Valva laterale, dentellata, 50 x 15 - 23 mm
 52-1373 1 Valva laterale, dentellata, 55 x 15 - 23 mm
 52-1374 1 Valva laterale, dentellata, 60 x 15 - 23 mm



Laminektomie-Spreizer
Laminectomy Retractors
Separadores para laminectomía
Ecarteurs pour laminectomie
Divaricatori per laminectomia

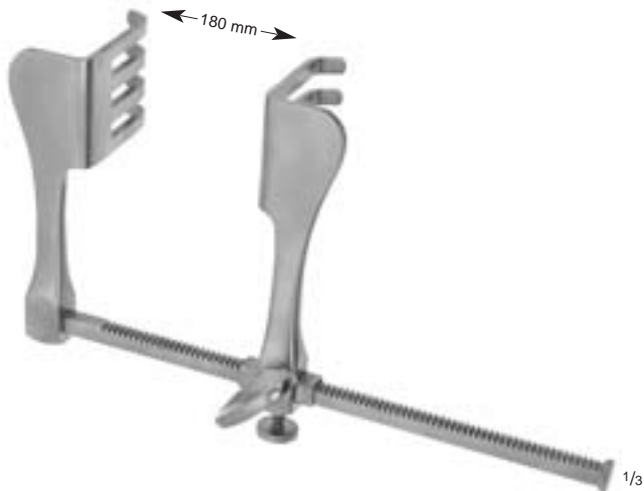
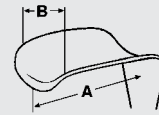

BADGLEY 52-0555

Wundspreizer, Seitenvlaven 52 x 44 mm (AxB)
Self-retaining retractor, lateral valves 52 x 44 mm (AxB)
Separador, valvas laterales 52 x 44 mm (AxB)
Ecarteur, valves latérales 52 x 44 mm (AxB)
Divaricatore, Valve laterali 52 x 44 mm (AxB)

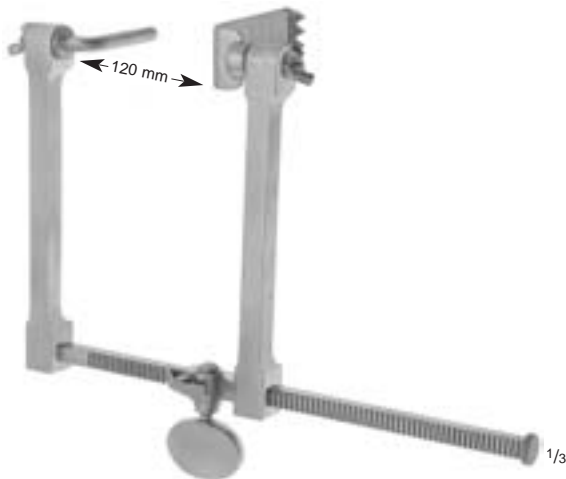

SCOVILLE 52-0583

Wundspreizer, komplett, bestehend aus:
52-0585 1 Rahmen
52-0600 1 Haken 50 mm
52-0610 1 Seitenvalve 63 x 25 mm (AxB)

Self-retaining retractor, complete, consisting of:
52-0585 1 Frame
52-0600 1 Hook 50 mm
52-0610 1 Lateral valve 63 x 25 mm (AxB)

Separador, completo, compuesto de:
52-0585 1 Cuadro
52-0600 1 Gancho 50 mm
52-0610 1 Valva lateral 63 x 25 mm (AxB)

Ecarteur, complet, composé de:
52-0585 1 Cadre
52-0600 1 Crochet 50 mm
52-0610 1 Valve latérale 63 x 25 mm (AxB)

Divaricatore, completo, composto da:
52-0585 1 Telaio
52-0600 1 Divaricatore 50 mm
52-0610 1 Valva laterale 63 x 25 mm (AxB)

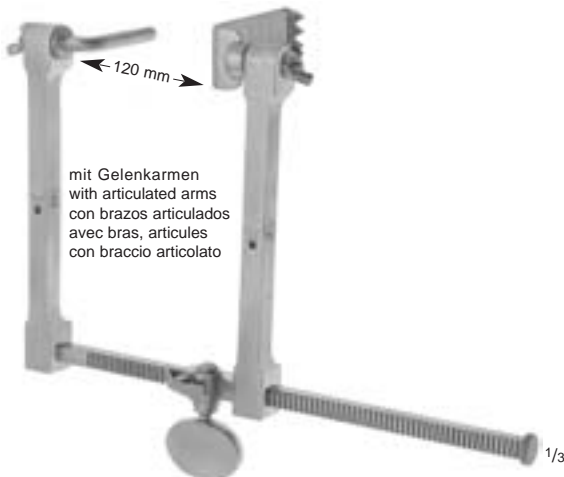

SCOVILLE-HAVERFIELD 52-0588

Wundspreizer, komplett, bestehend aus:
52-0590 1 Rahmen
52-0600 1 Haken 50 mm
52-0610 1 Seitenvalve 63 x 25 mm (AxB)

Self-retaining retractor, complete, consisting of:
52-0590 1 Frame
52-0600 1 Hook 50 mm
52-0610 1 Lateral valve 63 x 25 mm (AxB)

Separador, completo, compuesto de:
52-0590 1 Cuadro
52-0600 1 Gancho 50 mm
52-0610 1 Valva lateral 63 x 25 mm (AxB)

Ecarteur, complet, composé de:
52-0590 1 Cadre
52-0600 1 Crochet 50 mm
52-0610 1 Valve latérale 63 x 25 mm (AxB)

Divaricatore, completo, composto da:
52-0590 1 Telaio
52-0600 1 Divaricatore 50 mm
52-0610 1 Valva laterale 63 x 25 mm (AxB)

Haken
Hooks
Ganchos
Crochets
Ganci

Seitenvalven
Lateral Valves
Valvas laterales
Valves latérales
Valve laterali

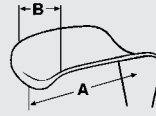

SCOVILLE

- ▶ 52-0600 50 mm
- 52-0601 75 mm

Haken für Wundspreizer
52-0583 und 52-0588

Hooks for self-retaining
retractors 52-0583 and 52-0588

Ganchos para separadores
52-0583 y 52-0588

Crochet pour écarteurs
52-0583 et 52-0588

Gancio per divaricatori
52-0583 e 52-0588



SCOVILLE

- 52-0610 63 x 25 mm (AxB)
- 52-0611 63 x 50 mm (AxB)
- ▶ 52-0613 88 x 25 mm (AxB)

Seitenvalven für Wundspreizer
52-0583 und 52-0588

Lateral valves for self-retaining
retractors 52-0583 and 52-0588

Valvas laterales para separadores
52-0583 y 52-0588

Valves latérales pour écarteurs
52-0583 et 52-0588

Valve laterali per divaricatori
52-0583 e 52-0588



SCOVILLE

- ▶ 52-0620 41 x 38 mm (AxB)
- 52-0621 67 x 44 mm (AxB)

Seitenvalven für Wundspreizer
52-0583 und 52-0588

Lateral valves for self-retaining
retractors 52-0583 and 52-0588

Valvas laterales para separadores
52-0583 y 52-0588

Valves latérales pour écarteurs
52-0583 et 52-0588

Valve laterali per divaricatori
52-0583 e 52-0588



TAYLOR

- 52-0685 48 x 50 mm (AxB)
- ▶ 52-0686 64 x 63 mm (AxB)
- 52-0687 80 x 57 mm (AxB)

Seitenvalven für Wundspreizer
52-0583 und 52-0588

Lateral valves for self-retaining
retractors 52-0583 and 52-0588

Valvas laterales para separadores
52-0583 y 52-0588

Valves latérales pour écarteurs
52-0583 et 52-0588

Valve laterali per divaricatori
52-0583 e 52-0588



Wundspreizer für die Wirbelsäule
 Retractors for vertebral column
 Separadores para la columna vertebral
 Ecarteurs pour colonne vertébrale
 Divaricatori per colonna vertebrale

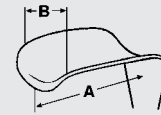

Lumbal, thorakal und cervical einzusetzen!
 For use of lumbar, thoracic and cervical!
 Útil para lumbar, toracal y cervical!
 Pour utilisation lombaire thoracique et cervicale!
 Per impiego lombare, toracico e cervicale

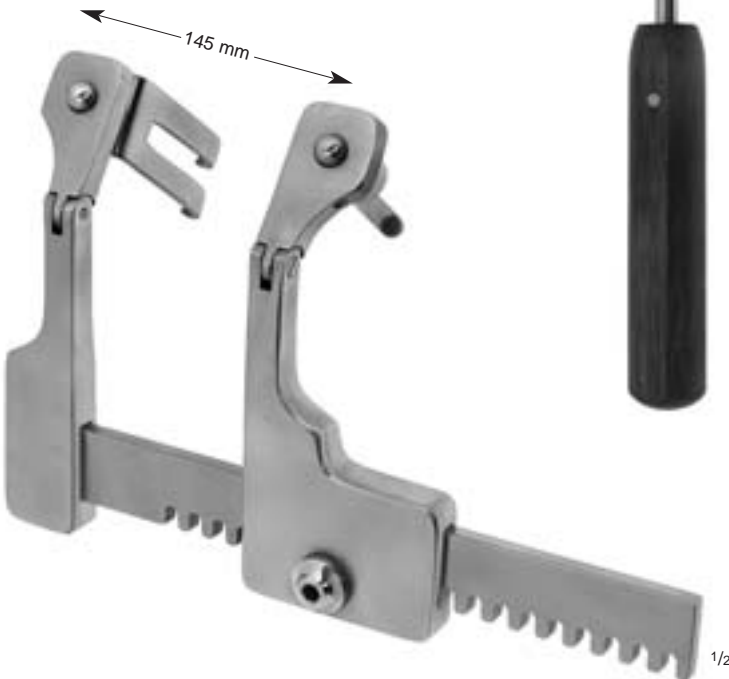

CASPAR
 52-0700

Wundspreizer mit Gelenkarmen und Kugelschnellverschluss, für Laminektomie und Hemi-Laminektomie, komplett, bestehend aus:
 52-0701 1 Rahmen
 52-0702 1 Drehschlüssel
 52-0705 1 Haken 38 mm
 52-0711 1 Seitenvalve 37 x 22 mm
 52-0712 1 Seitenvalve 43 x 22 mm
 52-0713 1 Seitenvalve 47 x 22 mm
 52-0714 1 Seitenvalve 52 x 22 mm
 52-0715 1 Seitenvalve 57 x 22 mm

Self-retaining retractor with articulated arms and ball snap closure, for laminectomy and hemi-laminectomy, complete, consisting of:
 52-0701 1 Frame
 52-0702 1 Key
 52-0705 1 Hook 38 mm
 52-0711 1 Lateral valve 37 x 22 mm
 52-0712 1 Lateral valve 43 x 22 mm
 52-0713 1 Lateral valve 47 x 22 mm
 52-0714 1 Lateral valve 52 x 22 mm
 52-0715 1 Lateral valve 57 x 22 mm

Separador con brazos articulados y cierre rápido esférico, para laminectomía y hemilaminectomía, completo, compuesto de:
 52-0701 1 Cuadro
 52-0702 1 Llave
 52-0705 1 Gancho 38 mm
 52-0711 1 Valva lateral 37 x 22 mm
 52-0712 1 Valva lateral 43 x 22 mm
 52-0713 1 Valva lateral 47 x 22 mm
 52-0714 1 Valva lateral 52 x 22 mm
 52-0715 1 Valva lateral 57 x 22 mm

Ecarteur avec bras articulés, enclenchement à billes, pour laminectomie et hémi-laminectomie, complet composé de:
 52-0701 1 Cadre
 52-0702 1 Clef
 52-0705 1 Crochet 38 mm
 52-0711 1 Valve latérale 37 x 22 mm
 52-0712 1 Valve latérale 43 x 22 mm
 52-0713 1 Valve latérale 47 x 22 mm
 52-0714 1 Valve latérale 52 x 22 mm
 52-0715 1 Valve latérale 57 x 22 mm

Divaricatore con braccio articolato a chiusura istantanea, per laminectomia e emi-laminectomia, completo, composto da:
 52-0701 1 Telaio
 52-0702 1 Chiave
 52-0705 1 Gancio 38 mm
 52-0711 1 Valva laterale 37 x 22 mm
 52-0712 1 Valva laterale 43 x 22 mm
 52-0713 1 Valva laterale 47 x 22 mm
 52-0714 1 Valva laterale 52 x 22 mm
 52-0715 1 Valva laterale 57 x 22 mm



52-0705
 38 mm



52-0711
 37 x 22 mm (AxB)



52-0712
 43 x 22 mm (AxB)



52-0713
 47 x 22 mm (AxB)



52-0714
 52 x 22 mm (AxB)



52-0715
 57 x 22 mm (AxB)

Haken
Hooks
Ganchos
Crochets
Ganci

Seitenvalven
Lateral Valves
Valvas laterales
Valves latérales
Valve laterali

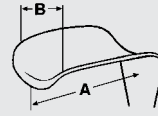

- 52-0705 38 mm
▶ 52-0706 58 mm

Haken mit Kugelschnellverschluss,
für Wundspreizer 52-0700

Hooks with ball snap closure, for
self-retaining retractor 52-0700

Ganchos con cierre rápido esférico
para separador 52-0700

Crochets avec enclenchement à billes
pour écarteur 52-0700

Ganci a chiusura istantanea per
divaricatore 52-0700



- 52-0710 32 x 22 mm (AxB)
52-0711 37 x 22 mm (AxB)
52-0712 43 x 22 mm (AxB)
52-0713 47 x 22 mm (AxB)
52-0714 52 x 22 mm (AxB)
▶ 52-0715 57 x 22 mm (AxB)
52-0716 62 x 22 mm (AxB)
52-0717 67 x 22 mm (AxB)

Seitenvalven mit Kugelschnellverschluss,
für Wundspreizer 52-0700

Lateral valves with ball snap closure, for
self-retaining retractor 52-0700

Valvas laterales con cierre rápido
esférico para separador 52-0700

Valves latérales avec enclenchement à
billes, pour écarteur 52-0700

Valve laterali a chiusura istantanea
per divaricatore 52-0700



- 52-0720 32 x 37 mm (AxB)
52-0721 37 x 37 mm (AxB)
52-0722 43 x 37 mm (AxB)
52-0723 47 x 37 mm (AxB)
52-0724 52 x 37 mm (AxB)
▶ 52-0725 57 x 37 mm (AxB)
52-0726 62 x 37 mm (AxB)
52-0727 67 x 37 mm (AxB)

Seitenvalven mit Kugelschnellverschluss,
für Wundspreizer 52-0700

Lateral valves with ball snap closure, for
self-retaining retractor 52-0700

Valvas laterales con cierre rápido
esférico para separador 52-0700

Valves latérales avec enclenchement à
billes, pour écarteur 52-0700

Valve laterali a chiusura istantanea
per divaricatore 52-0700



- 52-0730 32 x 52 mm (AxB)
52-0731 37 x 52 mm (AxB)
52-0732 43 x 52 mm (AxB)
52-0733 47 x 52 mm (AxB)
52-0734 52 x 52 mm (AxB)
▶ 52-0735 57 x 52 mm (AxB)
52-0736 62 x 52 mm (AxB)
52-0737 67 x 52 mm (AxB)

Seitenvalven mit Kugelschnellverschluss,
für Wundspreizer 52-0700

Lateral valves with ball snap closure, for
self-retaining retractor 52-0700

Valvas laterales con cierre rápido
esférico para separador 52-0700

Valves latérales avec enclenchement à
billes, pour écarteur 52-0700

Valve laterali a chiusura istantanea
per divaricatore 52-0700



- 52-0739
11,5 cm, 4 1/2"

Pinzette zum Valvenwechsel bei
Kugelschnellverschluss-System

Valve ejector for changing the valves
with ball snap closure system

Pinza para el cambio de valvas con el
sistema de cierre rápido esférico

Pince pour changer les valves avec
système à billes

Pinza per il cambio delle valve a
chiusura istantanea



Wundspreizer für die cervicale Wirbelsäule
 Retractors for cervical vertebral column
 Separadores para la columna cervical
 Ecarteurs pour colonne vertébrale
 Divaricatori per colonna cervicale

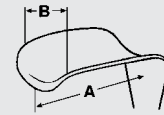

In Wirbelsäulen-Längsachse zu verwenden!
 To be used for up and down retraction!
 Útil para el eje longitudinal de la columna vertebral!
 Utilisé du haut en bas de la colonne vertébrale!
 Da impiegarsi per la trazione e la compressione della colonna!

← 90 mm →



CASPAR
 52-0740
 16,5 cm, 6 1/2"

Wundspreizer mit Gelenkarmen und Kugelschnellverschluss, komplett, bestehend aus:
 52-0742 1 Sperrer
 52-0780 1 stumpfen Valve 45 x 23 mm
 52-0781 1 stumpfen Valve 50 x 23 mm
 52-0782 1 stumpfen Valve 55 x 23 mm
 52-0783 1 stumpfen Valve 60 x 23 mm
 52-0784 1 stumpfen Valve 65 x 23 mm

Self-retaining retractor with articulated arms and ball snap closure, complete, consisting of:
 52-0742 1 Spreader
 52-0780 1 Blunt valve 45 x 23 mm
 52-0781 1 Blunt valve 50 x 23 mm
 52-0782 1 Blunt valve 55 x 23 mm
 52-0783 1 Blunt valve 60 x 23 mm
 52-0784 1 Blunt valve 65 x 23 mm

Separador con brazos articulados y cierre rápido esférico, completo, compuesto de:
 52-0742 1 Separador
 52-0780 1 Valva roma 45 x 23 mm
 52-0781 1 Valva roma 50 x 23 mm
 52-0782 1 Valva roma 55 x 23 mm
 52-0783 1 Valva roma 60 x 23 mm
 52-0784 1 Valva roma 65 x 23 mm

Ecarteur avec bras articulés, enclenchement à billes, complet composé de:
 52-0742 1 Ecarteur
 52-0780 1 Valve, mousse 45 x 23 mm
 52-0781 1 Valve, mousse 50 x 23 mm
 52-0782 1 Valve, mousse 55 x 23 mm
 52-0783 1 Valve, mousse 60 x 23 mm
 52-0784 1 Valve, mousse 65 x 23 mm

Divaricatore con braccio articolato a chiusura istantanea, completo, composto da:
 52-0742 1 Divaricatore
 52-0780 1 Valva, smussa 45 x 23 mm
 52-0781 1 Valva, smussa 50 x 23 mm
 52-0782 1 Valva, smussa 55 x 23 mm
 52-0783 1 Valva, smussa 60 x 23 mm
 52-0784 1 Valva, smussa 65 x 23 mm



52-0780
 45 x 23 mm (AxB)



52-0781
 50 x 23 mm (AxB)



52-0782
 55 x 23 mm (AxB)



52-0783
 60 x 23 mm (AxB)



52-0784
 65 x 23 mm (AxB)

Wundspreizer für die cervicale Wirbelsäule
 Retractors for cervical vertebral column
 Separadores para la columna cervical
 Ecarteurs pour colonne vertébrale
 Divaricatori per colonna cervicale

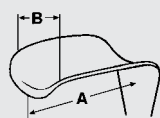

In Wirbelsäulen-Längsachse zu verwenden!
 To be used for up and down retraction!
 Útil para el eje longitudinal de la columna vertebral!
 Utilisé du haut en bas de la colonne vertébrale!
 Da impiegarsi per la trazione e la compressione della colonna!



52-0780
 45 x 23 mm (AxB)



52-0781
 50 x 23 mm (AxB)



52-0782
 55 x 23 mm (AxB)



52-0783
 60 x 23 mm (AxB)



52-0784
 65 x 23 mm (AxB)

← 85 mm →



CASPAR
 52-0745
 10,5 cm, 4 1/8"

Wundspreizer mit Gelenkarmen und Kugelschnellverschluss, komplett, bestehend aus:
 52-0746 1 Sperrer
 52-0780 1 stumpfen Valve 45 x 23 mm
 52-0781 1 stumpfen Valve 50 x 23 mm
 52-0782 1 stumpfen Valve 55 x 23 mm
 52-0783 1 stumpfen Valve 60 x 23 mm
 52-0784 1 stumpfen Valve 65 x 23 mm

Self-retaining retractor with articulated arms and ball snap closure, complete, consisting of:
 52-0746 1 Spreader
 52-0780 1 Blunt valve 45 x 23 mm
 52-0781 1 Blunt valve 50 x 23 mm
 52-0782 1 Blunt valve 55 x 23 mm
 52-0783 1 Blunt valve 60 x 23 mm
 52-0784 1 Blunt valve 65 x 23 mm

Separador con brazos articulados y cierre rápido esférico, completo, compuesto de:
 52-0746 1 Separador
 52-0780 1 Valva roma 45 x 23 mm
 52-0781 1 Valva roma 50 x 23 mm
 52-0782 1 Valva roma 55 x 23 mm
 52-0783 1 Valva roma 60 x 23 mm
 52-0784 1 Valva roma 65 x 23 mm

Ecarteur avec bras articulés, enclenchement à billes, complet composé de:
 52-0746 1 Ecarteur
 52-0780 1 Valve, mousse 45 x 23 mm
 52-0781 1 Valve, mousse 50 x 23 mm
 52-0782 1 Valve, mousse 55 x 23 mm
 52-0783 1 Valve, mousse 60 x 23 mm
 52-0784 1 Valve, mousse 65 x 23 mm

Divaricatore con braccio articolato a chiusura istantanea, completo, composto da:
 52-0746 1 Divaricatore
 52-0780 1 Valva, smussa 45 x 23 mm
 52-0781 1 Valva, smussa 50 x 23 mm
 52-0782 1 Valva, smussa 55 x 23 mm
 52-0783 1 Valva, smussa 60 x 23 mm
 52-0784 1 Valva, smussa 65 x 23 mm



Wundspreizer für die cervicale Wirbelsäule
 Retractors for cervical vertebral column
 Separadores para la columna cervical
 Ecarteurs pour colonne vertébrale
 Divaricatori per colonna cervicale

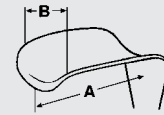

52-0770
40 x 23 mm (AxB)



52-0775
40 x 23 mm (AxB)



52-0771
45 x 23 mm (AxB)



52-0776
45 x 23 mm (AxB)



52-0772
50 x 23 mm (AxB)



52-0777
50 x 23 mm (AxB)



52-0773
55 x 23 mm (AxB)



52-0778
55 x 23 mm (AxB)



52-0774
60 x 23 mm (AxB)



52-0779
60 x 23 mm (AxB)



CASPAR
52-0750

Wundspreizer mit Gelenkarmen und Kugelschnellverschluss, komplett, bestehend aus:

- 52-0751 1 Rahmen
- 52-0770 1 medialen Valve 40 x 23 mm
- 52-0771 1 medialen Valve 45 x 23 mm
- 52-0772 1 medialen Valve 50 x 23 mm
- 52-0773 1 medialen Valve 55 x 23 mm
- 52-0774 1 medialen Valve 60 x 23 mm
- 52-0775 1 lateralen Valve 40 x 23 mm
- 52-0776 1 lateralen Valve 45 x 23 mm
- 52-0777 1 lateralen Valve 50 x 23 mm
- 52-0778 1 lateralen Valve 55 x 23 mm
- 52-0779 1 lateralen Valve 60 x 23 mm

Self-retaining retractor with articulated arms and ball snap closure, complete, consisting of:

- 52-0751 1 Frame
- 52-0770 1 Medial valve 40 x 23 mm
- 52-0771 1 Medial valve 45 x 23 mm
- 52-0772 1 Medial valve 50 x 23 mm
- 52-0773 1 Medial valve 55 x 23 mm
- 52-0774 1 Medial valve 60 x 23 mm
- 52-0775 1 Lateral valve 40 x 23 mm
- 52-0776 1 Lateral valve 45 x 23 mm
- 52-0777 1 Lateral valve 50 x 23 mm
- 52-0778 1 Lateral valve 55 x 23 mm
- 52-0779 1 Lateral valve 60 x 23 mm

Separador con brazos articulados y cierre rápido esférico, completo, compuesto de:

- 52-0751 1 Cuadro
- 52-0770 1 Valva mediana 40 x 23 mm
- 52-0771 1 Valva mediana 45 x 23 mm
- 52-0772 1 Valva mediana 50 x 23 mm
- 52-0773 1 Valva mediana 55 x 23 mm
- 52-0774 1 Valva mediana 60 x 23 mm
- 52-0775 1 Valva lateral 40 x 23 mm
- 52-0776 1 Valva lateral 45 x 23 mm
- 52-0777 1 Valva lateral 50 x 23 mm
- 52-0778 1 Valva lateral 55 x 23 mm
- 52-0779 1 Valva lateral 60 x 23 mm

Ecarteur avec bras articulés, enclenchement à billes, complet composé de:

- 52-0751 1 Cadre
- 52-0770 1 Valve médiane 40 x 23 mm
- 52-0771 1 Valve médiane 45 x 23 mm
- 52-0772 1 Valve médiane 50 x 23 mm
- 52-0773 1 Valve médiane 55 x 23 mm
- 52-0774 1 Valve médiane 60 x 23 mm
- 52-0775 1 Valve latérale 40 x 23 mm
- 52-0776 1 Valve latérale 45 x 23 mm
- 52-0777 1 Valve latérale 50 x 23 mm
- 52-0778 1 Valve latérale 55 x 23 mm
- 52-0779 1 Valve latérale 60 x 23 mm

Divaricatore con braccio articolato a chiusura istantanea, completo, composto da:

- 52-0751 1 Telaio
- 52-0770 1 Valva media 40 x 23 mm
- 52-0771 1 Valva media 45 x 23 mm
- 52-0772 1 Valva media 50 x 23 mm
- 52-0773 1 Valva media 55 x 23 mm
- 52-0774 1 Valva media 60 x 23 mm
- 52-0775 1 Valva laterale 40 x 23 mm
- 52-0776 1 Valva laterale 45 x 23 mm
- 52-0777 1 Valva laterale 50 x 23 mm
- 52-0778 1 Valva laterale 55 x 23 mm
- 52-0779 1 Valva laterale 60 x 23 mm

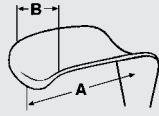

- 52-0770 40 x 23 mm (AxB)
- 52-0771 45 x 23 mm (AxB)
- ▶ 52-0772 50 x 23 mm (AxB)
- 52-0773 55 x 23 mm (AxB)
- 52-0774 60 x 23 mm (AxB)

Mediale Valven mit Kugelschnellverschluss, für Wundspreizer
52-0740 / 52-0745 / 52-0750

Medial valves with ball snap closure, for self-retaining retractors
52-0740 / 52-0745 / 52-0750

Valvas medianas con cierre rápido esférico, para separadores
52-0740 / 52-0745 / 52-0750

Valves médianes avec enclenchement à bille, pour écarteurs
52-0740 / 52-0745 / 52-0750

Valve medie a chiusura istantanea, per divaricatori
52-0740 / 52-0745 / 52-0750



- 52-0775 40 x 23 mm (AxB)
- 52-0776 45 x 23 mm (AxB)
- ▶ 52-0777 50 x 23 mm (AxB)
- 52-0778 55 x 23 mm (AxB)
- 52-0779 60 x 23 mm (AxB)

Laterale Valven mit Kugelschnellverschluss, für Wundspreizer
52-0740 / 52-0745 / 52-0750

Lateral valves with ball snap closure, for self-retaining retractors
52-0740 / 52-0745 / 52-0750

Valvas laterales con cierre rápido esférico, para separadores
52-0740 / 52-0745 / 52-0750

Valves latérales avec enclenchement à bille, pour écarteurs
52-0740 / 52-0745 / 52-0750

Valve laterali a chiusura istantanea, per divaricatori
52-0740 / 52-0745 / 52-0750



- 52-0780 45 x 23 mm (AxB)
- 52-0781 50 x 23 mm (AxB)
- ▶ 52-0782 55 x 23 mm (AxB)
- 52-0783 60 x 23 mm (AxB)
- 52-0784 65 x 23 mm (AxB)

Stumpfe Valven mit Kugelschnellverschluss, für Wundspreizer
52-0740 / 52-0745 / 52-0750

Blunt valves with ball snap closure, for self-retaining retractors
52-0740 / 52-0745 / 52-0750

Valvas romas con cierre rápido esférico, para separadores
52-0740 / 52-0745 / 52-0750

Valves mousses avec enclenchement à bille, pour écarteurs
52-0740 / 52-0745 / 52-0750

Valve smusse a chiusura istantanea, per divaricatori
52-0740 / 52-0745 / 52-0750



- ▶ 52-0785 50 x 25 mm (AxB)
- 52-0786 60 x 25 mm (AxB)

Stumpfe Valven mit Kugelschnellverschluss zur Spanentnahme am Beckenkamm, für Wundspreizer
52-0740 / 52-0745 / 52-0750

Blunt valves with ball snap closure, for harvesting of the fusion graft from the iliac crest, for self-retaining retractors
52-0740 / 52-0745 / 52-0750

Valvas romas con cierre rápido esférico, para separadores
52-0740 / 52-0745 / 52-0750

Valves mousses avec enclenchement à bille, pour écarteurs
52-0740 / 52-0745 / 52-0750

Valve smusse a chiusura istantanea, per osso iliaco, per divaricatori
52-0740 / 52-0745 / 52-0750



- 52-0790 40 x 25 mm (AxB)
- 52-0791 45 x 25 mm (AxB)
- ▶ 52-0792 50 x 25 mm (AxB)
- 52-0793 55 x 25 mm (AxB)
- 52-0794 60 x 25 mm (AxB)

Mediale Valven aus TITAN, mit Kugelschnellverschluss, für Wundspreizer
52-0740 / 52-0745 / 52-0750

Medial valves of TITANIUM, with ball snap closure, for self-retaining retractors
52-0740 / 52-0745 / 52-0750

Valvas medianas de TITANIO, con cierre rápido esférico, para separadores
52-0740 / 52-0745 / 52-0750

Valves medianes TITANE avec enclenchement à bille, pour écarteurs
52-0740 / 52-0745 / 52-0750

Valve medie in TITANO a chiusura istantanea, per divaricatori
52-0740 / 52-0745 / 52-0750



- 52-0795 40 x 25 mm (AxB)
- 52-0796 45 x 25 mm (AxB)
- ▶ 52-0797 50 x 25 mm (AxB)
- 52-0798 55 x 25 mm (AxB)
- 52-0799 60 x 25 mm (AxB)

Laterale Valven aus TITAN, mit Kugelschnellverschluss, für Wundspreizer
52-0740 / 52-0745 / 52-0750

Lateral valves of TITANIUM, with ball snap closure, for self-retaining retractors
52-0740 / 52-0745 / 52-0750

Valvas laterales de TITANIO, con cierre rápido esférico, para separadores
52-0740 / 52-0745 / 52-0750

Valves latérales TITANE avec enclenchement à bille, pour écarteurs
52-0740 / 52-0745 / 52-0750

Valve laterali in TITANO, a chiusura istantanea, per divaricatori
52-0740 / 52-0745 / 52-0750



Wundspreizer für die lumbale Wirbelsäule
 Retractors for lumbar vertebral column
 Separadores para la cirugía lumbar vertebral
 Ecarteurs pour chirurgie lombaire
 Divaricatori per colonna lombo vertebrale

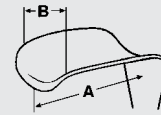

Oberfläche geschwärzt
 Surface black-finish
 Superficie negra
 Surface noire
 Superficie nera

← 60 mm →



CASPAR
52-0800

Wundspreizer mit Gelenkarmen und Kugelschnellverschluß, komplett, bestehend aus:
 52-0801 1 Rahmen
 52-0802 1 Seitenvalve 40 x 12 mm
 52-0803 1 Seitenvalve 46 x 13 mm
 52-0804 1 Seitenvalve 50 x 13 mm
 52-0805 1 Seitenvalve 56 x 14 mm
 52-0806 1 Seitenvalve 63 x 14 mm
 52-0807 1 Seitenvalve 66 x 15 mm

Ecarteur avec bras articulés, enclenchement à billes, complet composé de:
 52-0801 1 Cadre
 52-0802 1 Valve latérale 40 x 12 mm
 52-0803 1 Valve latérale 46 x 13 mm
 52-0804 1 Valve latérale 50 x 13 mm
 52-0805 1 Valve latérale 56 x 14 mm
 52-0806 1 Valve latérale 63 x 14 mm
 52-0807 1 Valve latérale 66 x 15 mm

Self-retaining retractor with articulated arms and ball snap closure, complete, consisting of:
 52-0801 1 Frame
 52-0802 1 Lateral valve 40 x 12 mm
 52-0803 1 Lateral valve 46 x 13 mm
 52-0804 1 Lateral valve 50 x 13 mm
 52-0805 1 Lateral valve 56 x 14 mm
 52-0806 1 Lateral valve 63 x 14 mm
 52-0807 1 Lateral valve 66 x 15 mm

Divaricatore con braccio articolato a chiusura istantanea, completo, composto da:
 52-0801 1 Telaio
 52-0802 1 Valva laterale 40 x 12 mm
 52-0803 1 Valva laterale 46 x 13 mm
 52-0804 1 Valva laterale 50 x 13 mm
 52-0805 1 Valva laterale 56 x 14 mm
 52-0806 1 Valva laterale 63 x 14 mm
 52-0807 1 Valva laterale 66 x 15 mm



52-0802
 40 x 12 mm (AxB)



52-0803
 46 x 13 mm (AxB)



52-0804
 50 x 13 mm (AxB)



52-0805
 56 x 14 mm (AxB)



52-0806
 63 x 14 mm (AxB)



52-0807
 66 x 15 mm (AxB)

Spekula für lumbale Bandscheibenoperationen
 Specula for lumbar vertebral operations
 Espéculos para la cirugía lumbar vertebral
 Spéculums pour chirurgie lombaire
 Speculi per chirurgia lombo vertebrale

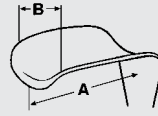

▶ 52-0810
40 x 18 mm (AxB)

1/1



52-0812
45 x 18 mm (AxB)

1/1



52-0814
50 x 18 mm (AxB)

1/1



52-0816
55 x 18 mm (AxB)

1/1



52-0818
60 x 18 mm (AxB)

1/1



1/2

CASPAR
52-0810
- 52-0818
15 cm, 6"

Oberfläche geschwärzt
 Surface black-finish
 Superficie negra
 Surface noire
 Superficie nera



Wirbelkörperspreizer
 Lamina Spreaders
 Separadores para cuerpos vertebrales
 Ecarteurs pour corps vertébraux
 Separatori per vertebre



CLOWARD
 52-1301
 16 cm, 6 1/4"
 Spreizweite 18 mm
 Blade opening 18 mm
 Abertura de la hoja 18 mm
 Écartement 18 mm
 Apertura lame 18 mm



INGE
 52-0517
 16 cm, 6 1/4"
 Spreizweite 34 mm
 Blade opening 34 mm
 Abertura de la hoja 34 mm
 Écartement 34 mm
 Apertura lame 34 mm

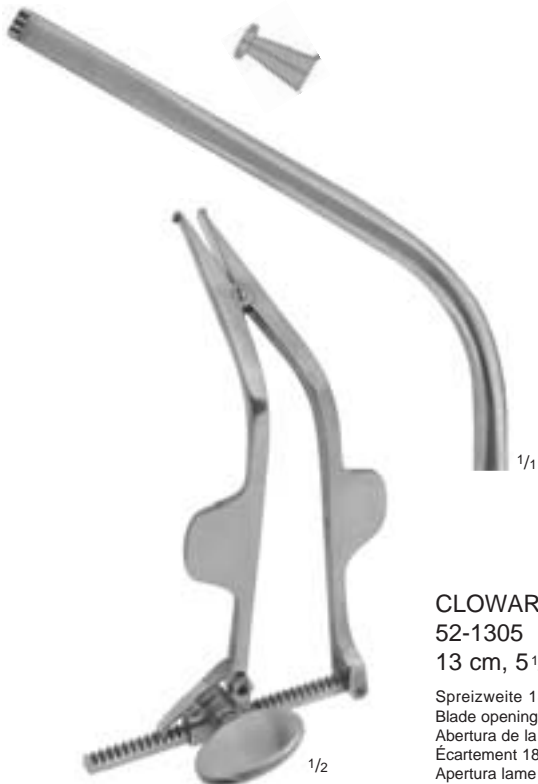

CLOWARD
 52-1305
 13 cm, 5 1/8"
 Spreizweite 18 mm
 Blade opening 18 mm
 Abertura de la hoja 18 mm
 Écartement 18 mm
 Apertura lame 18 mm



INGE
 52-0516
 26,5 cm, 10 1/2"
 Spreizweite 63 mm
 Blade opening 63 mm
 Abertura de la hoja 63 mm
 Écartement 63 mm
 Apertura lame 63 mm



BABY-COLLIN
21-0340
18 cm, 7"

Bauchdeckenhalter, komplett,
bestehend aus:

- 21-0341 1 Sperrer
- 21-0345 1 Paar Seitenvalven
18 x 40 mm (AxB)
- 21-0346 1 Paar Seitenvalven
28 x 40 mm (AxB)

Abdominal retractor, complete,
consisting of:

- 21-0341 1 Spreader
- 21-0345 1 Pair lateral valves
18 x 40 mm (AxB)
- 21-0346 1 Pair lateral valves
28 x 40 mm (AxB)

Separador abdominal, completo,
compuesto de:

- 21-0341 1 Separador
- 21-0345 1 Par de valvas laterales
18 x 40 mm (AxB)
- 21-0346 1 Par de valvas laterales
28 x 40 mm (AxB)

Ecarteur abdominal, complet,
composé de:

- 21-0341 1 Ecarteur
- 21-0345 1 Paire de valves latérales
18 x 40 mm (AxB)
- 21-0346 1 Paire de valves latérales
28 x 40 mm (AxB)

Divaricatore addominale, completo,
composto da:

- 21-0341 1 Divaricatore
- 21-0345 1 Paio di valve laterali
18 x 40 mm (AxB)
- 21-0346 1 Paio di valve laterali
28 x 40 mm (AxB)



COLLIN
21-0350
23 cm, 9"

Bauchdeckenhalter, komplett,
bestehend aus:

- 21-0351 1 Sperrer
- 21-0352 1 Paar Seitenvalven
40 x 63 mm (AxB)

Abdominal retractor, complete,
consisting of:

- 21-0351 1 Spreader
- 21-0352 1 Pair lateral valves
40 x 63 mm (AxB)

Separador abdominal, completo,
compuesto de:

- 21-0351 1 Separador
- 21-0352 1 Par de valvas laterales
40 x 63 mm (AxB)

Ecarteur abdominal, complet,
composé de:

- 21-0351 1 Ecarteur
- 21-0352 1 Paire de valves latérales
40 x 63 mm (AxB)

Divaricatore addominale, completo,
composto da:

- 21-0351 1 Divaricatore
- 21-0352 1 Paio di valve laterali
40 x 63 mm (AxB)



COLLIN
21-0356
24 cm, 9 1/2"

Bauchdeckenhalter, komplett,
bestehend aus:

- 21-0358 1 Sperrer
- 21-0378 1 Paar Seitenvalven
40 x 80 mm (AxB)
- 21-0379 1 Mittelvalve
54 x 65 mm (AxB)

Abdominal retractor, complete,
consisting of:

- 21-0358 1 Spreader
- 21-0378 1 Pair lateral valves
40 x 80 mm (AxB)
- 21-0379 1 Central valve
54 x 65 mm (AxB)

Separador abdominal, completo,
compuesto de:

- 21-0358 1 Separador
- 21-0378 1 Par de valvas laterales
40 x 80 mm (AxB)
- 21-0379 1 Valva central
54 x 65 mm (AxB)

Ecarteur abdominal, complet,
composé de:

- 21-0358 1 Ecarteur
- 21-0378 1 Paire de valves latérales
40 x 80 mm (AxB)
- 21-0379 1 Valve centrale
54 x 65 mm (AxB)

Divaricatore addominale, completo,
composto da:

- 21-0341 1 Divaricatore
- 21-0345 1 Paio di valve laterali
40 x 80 mm (AxB)
- 21-0346 1 Valva centrale
54 x 65 mm (AxB)



COLLIN
21-0357
25 cm, 10"

Bauchdeckenhalter, komplett,
bestehend aus:

- 21-0358 1 Sperrer
- 21-0382 1 Paar Seitenvalven
40 x 100 mm (AxB)
- 21-0383 1 Mittelvalve
54 x 76 mm (AxB)

Abdominal retractor, complete,
consisting of:

- 21-0358 1 Spreader
- 21-0382 1 Pair lateral valves
40 x 100 mm (AxB)
- 21-0383 1 Central valve
54 x 76 mm (AxB)

Separador abdominal, completo,
compuesto de:

- 21-0358 1 Separador
- 21-0382 1 Par de valvas laterales
40 x 100 mm (AxB)
- 21-0383 1 Valva central
54 x 76 mm (AxB)

Ecarteur abdominal, complet,
composé de:

- 21-0358 1 Ecarteur
- 21-0382 1 Paire de valves latérales
40 x 100 mm (AxB)
- 21-0383 1 Valve centrale
54 x 76 mm (AxB)

Divaricatore addominale, completo,
composto da:

- 21-0358 1 Divaricatore
- 21-0382 1 Paio di valve laterali
40 x 100 mm (AxB)
- 21-0383 1 Valva centrale
54 x 76 mm (AxB)



Bauchdeckenhalter
Abdominal Retractors
Separadores abdominales
Ecarteurs abdominaux
Divaricatori addominali

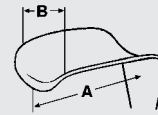

COLLIN
21-0361
32 cm, 12 1/2"

Bauchdeckenhalter, komplett, bestehend aus:
21-0362 1 Sperrer
21-0388 1 Paar Seitenvalven 58 x 80 mm (AxB)
21-0387 1 Mittelvalve 63 x 73 mm (AxB)

Abdominal retractor, complete, consisting of:
21-0362 1 Spreader
21-0388 1 Pair lateral valves 58 x 80 mm (AxB)
21-0387 1 Central valve 63 x 73 mm (AxB)

Separador abdominal, completo, compuesto de:
21-0362 1 Separador
21-0388 1 Par de valvas laterales 58 x 80 mm (AxB)
21-0387 1 Valva central 63 x 73 mm (AxB)

Ecarteur abdominal, complet, composé de:
21-0362 1 Ecarteur
21-0388 1 Paire de valves latérales 58 x 80 mm (AxB)
21-0387 1 Valve centrale 63 x 73 mm (AxB)

Divaricatore addominale, completo, composto da:
21-0362 1 Divaricatore
21-0388 1 Paio di valve laterali 58 x 80 mm (AxB)
21-0387 1 Valva centrale 63 x 73 mm (AxB)



RICARD
21-0380

Bauchdeckenhalter, komplett, bestehend aus:
21-0384 1 Sperrer
21-0396 1 Paar Seitenvalven 58 x 80 mm (AxB)
21-0397 1 Mittelvalve 54 x 70 mm (AxB)

Abdominal retractor, complete, consisting of:
21-0384 1 Spreader
21-0396 1 Pair lateral valves 58 x 80 mm (AxB)
21-0397 1 Central valve 54 x 70 mm (AxB)

Separador abdominal, completo, compuesto de:
21-0384 1 Separador
21-0396 1 Par de valvas laterales 58 x 80 mm (AxB)
21-0397 1 Valva central 54 x 70 mm (AxB)

Ecarteur abdominal, complet, composé de:
21-0384 1 Ecarteur
21-0396 1 Paire de valves latérales 58 x 80 mm (AxB)
21-0397 1 Valve centrale 54 x 70 mm (AxB)

Divaricatore addominale, completo, composto da:
21-0384 1 Divaricatore
21-0396 1 Paio di valve laterali 58 x 80 mm (AxB)
21-0397 1 Valva centrale 54 x 70 mm (AxB)



RICARD
21-0381

Bauchdeckenhalter, komplett, bestehend aus:
21-0389 1 Sperrer
21-0398 1 Paar Seitenvalven 72 x 85 mm (AxB)
21-0399 1 Mittelvalve 72 x 90 mm (AxB)

Abdominal retractor, complete, consisting of:
21-0389 1 Spreader
21-0398 1 Pair lateral valves 72 x 85 mm (AxB)
21-0399 1 Central valve 72 x 90 mm (AxB)

Separador abdominal, completo, compuesto de:
21-0389 1 Separador
21-0398 1 Par de valvas laterales 72 x 85 mm (AxB)
21-0399 1 Valva central 72 x 90 mm (AxB)

Ecarteur abdominal, complet, composé de:
21-0389 1 Ecarteur
21-0398 1 Paire de valves latérales 72 x 85 mm (AxB)
21-0399 1 Valve centrale 72 x 90 mm (AxB)

Divaricatore addominale, completo, composto da:
21-0389 1 Divaricatore
21-0398 1 Paio di valve laterali 72 x 85 mm (AxB)
21-0399 1 Valva centrale 72 x 90 mm (AxB)

Bauchdeckenhalter
Abdominal Retractors
Separadores abdominales
Ecarteurs abdominaux
Divaricatori addominali

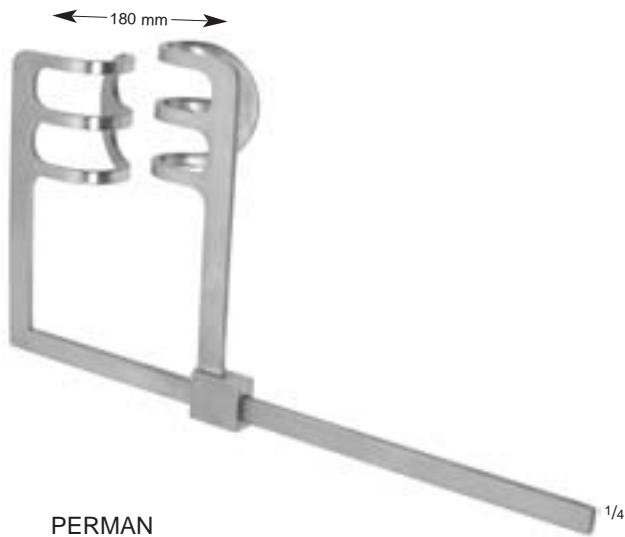
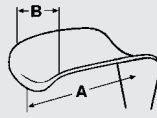

PERMAN
21-0465

Bauchdeckenhalter, Seitenventilen
60 x 60 mm (AxB)

Abdominal retractor, lateral valves
60 x 60 mm (AxB)

Separador abdominal, valvas laterales
60 x 60 mm (AxB)

Ecarteur abdominal, valves latérales
60 x 60 mm (AxB)

Divaricatore addominale, valve laterali
60 x 60 mm (AxB)

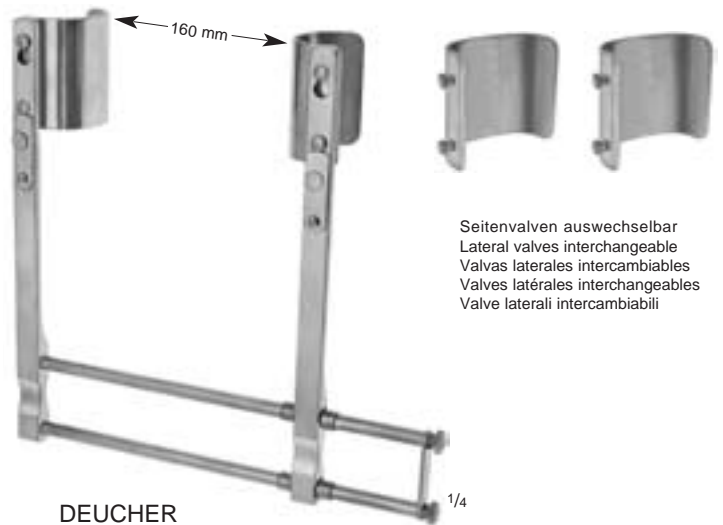

DEUCHER
21-0470

Bauchdeckenhalter, komplett, bestehend aus:
21-0471 1 Rahmen
21-0472 1 Paar Seitenventilen 52 x 60 mm (AxB)
21-0473 1 Paar Seitenventilen 64 x 60 mm (AxB)

Abdominal retractor, complete, consisting of:
21-0471 1 Frame
21-0472 1 Pair lateral valves 52 x 60 mm (AxB)
21-0473 1 Pair lateral valves 64 x 60 mm (AxB)

Separador abdominal, completo, compuesto de:
21-0471 1 Cuadro
21-0472 1 Par de valvas laterales 52 x 60 mm (AxB)
21-0473 1 Par de valvas laterales 64 x 60 mm (AxB)

Ecarteur abdominal, complet, composé de:
21-0471 1 Cadre
21-0472 1 Paire de valves latérales 52 x 60 mm (AxB)
21-0473 1 Paire de valves latérales 64 x 60 mm (AxB)

Divaricatore addominale, completo, composto da:
21-0471 1 Telaio
21-0472 1 Paio di valve laterali 52 x 60 mm (AxB)
21-0473 1 Paio di valve laterali 64 x 60 mm (AxB)

Seitenventilen auswechselbar
Lateral valves interchangeable
Valvas laterales intercambiables
Valves latérales interchangeables
Valve laterali intercambiabili

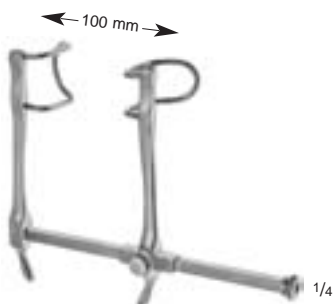

GOSSET-BABY
21-0420

Bauchdeckenhalter, Seitenventilen 38 x 23 mm (AxB)
und 38 x 31 mm (AxB)

Abdominal retractor, lateral valves 38 x 23 mm (AxB)
and 38 x 31 mm (AxB)

Separador abdominal, valvas laterales 38 x 23 mm (AxB)
y 38 x 31 mm (AxB)

Ecarteur abdominal, valves latérales 38 x 23 mm (AxB)
et 38 x 31 mm (AxB)

Divaricatore addominale, valve laterali 38 x 23 mm (AxB)
e 38 x 31 mm (AxB)

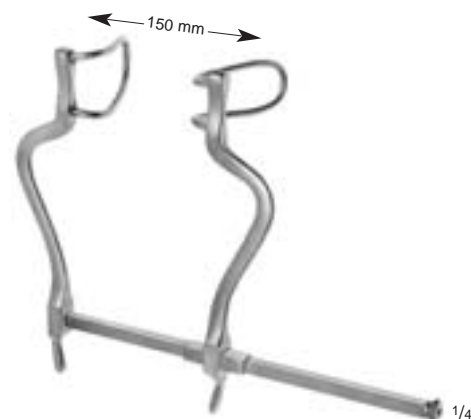

GOSSET
21-0425

Bauchdeckenhalter, Seitenventilen 63 x 29 mm (AxB)
und 63 x 36 mm (AxB)

Abdominal retractor, lateral valves 63 x 29 mm (AxB)
and 63 x 36 mm (AxB)

Separador abdominal, valvas laterales 63 x 29 mm (AxB)
y 63 x 36 mm (AxB)

Ecarteur abdominal, valves latérales 63 x 29 mm (AxB)
et 63 x 36 mm (AxB)

Divaricatore addominale, valve laterali 63 x 29 mm (AxB)
e 63 x 36 mm (AxB)



Bauchdeckenhalter
Abdominal Retractors
Separadores abdominales
Ecarteurs abdominaux
Divaricatori addominali

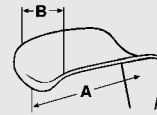

GOSSET
21-0426

Bauchdeckenhalter, Seitenvalven 63 x 29 mm (AxB) und 63 x 36 mm (AxB), mit Mittelvalve 59 x 57 mm (21-0429)

Abdominal retractor, lateral valves 63 x 29 mm (AxB) and 63 x 36 mm (AxB), with central valve 59 x 57 mm (21-0429)

Separador abdominal, valvas laterales 63 x 29 mm (AxB) y 63 x 36 mm (AxB), con valva central 59 x 57 mm (21-0429)

Ecarteur abdominal, valves latérales 63 x 29 mm (AxB) et 63 x 36 mm (AxB), avec valve centrale 59 x 57 mm (21-0429)

Divaricatore addominale, valve laterali 63 x 29 mm (AxB) e 63 x 36 mm (AxB), con valva centrale 59 x 57 mm (21-0429)



BALFOUR-BABY
21-0427

Bauchdeckenhalter, Seitenvalven 27 x 23 mm (AxB) und 27 x 28 mm (AxB), mit Mittelvalve 22 x 24 mm (21-0428)

Abdominal retractor, lateral valves 27 x 23 mm (AxB) and 27 x 28 mm (AxB), with central valve 22 x 24 mm (21-0428)

Separador abdominal, valvas laterales 27 x 23 mm (AxB) y 27 x 28 mm (AxB), con valva central 22 x 24 mm (21-0428)

Ecarteur abdominal, valves latérales 27 x 23 mm (AxB) et 27 x 28 mm (AxB), avec valve centrale 22 x 24 mm (21-0428)

Divaricatore addominale, valve laterali 27 x 23 mm (AxB) e 27 x 28 mm (AxB), con valva centrale 22 x 24 mm (21-0428)



BALFOUR
21-0500

Bauchdeckenhalter, Seitenvalven 48 x 28 mm (AxB) und 48 x 39 mm (AxB), mit Mittelvalve 48 x 78 mm (21-0507)

Abdominal retractor, lateral valves 48 x 28 mm (AxB) and 48 x 39 mm (AxB), with central valve 48 x 78 mm (21-0507)

Separador abdominal, valvas laterales 48 x 28 mm (AxB) y 48 x 39 mm (AxB), con valva central 48 x 78 mm (21-0507)

Ecarteur abdominal, valves latérales 48 x 28 mm (AxB) et 48 x 39 mm (AxB), avec valve centrale 48 x 78 mm (21-0507)

Divaricatore addominale, valve laterali 48 x 28 mm (AxB) e 48 x 39 mm (AxB), con valva centrale 48 x 78 mm (21-0507)



BALFOUR
21-0501

Bauchdeckenhalter, Seitenvalven 60 x 32 mm (AxB) und 60 x 38 mm (AxB), mit Mittelvalve 48 x 78 mm (21-0507)

Abdominal retractor, lateral valves 60 x 32 mm (AxB) and 60 x 38 mm (AxB), with central valve 48 x 78 mm (21-0507)

Separador abdominal, valvas laterales 60 x 32 mm (AxB) y 60 x 38 mm (AxB), con valva central 48 x 78 mm (21-0507)

Ecarteur abdominal, valves latérales 60 x 32 mm (AxB) et 60 x 38 mm (AxB), avec valve centrale 48 x 78 mm (21-0507)

Divaricatore addominale, valve laterali 60 x 32 mm (AxB) e 60 x 38 mm (AxB), con valva centrale 48 x 78 mm (21-0507)

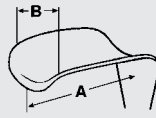

BALFOUR
 21-0502

Bauchdeckenhalter, Seitenvalven 100 x 32 mm (AxB) und 100 x 38 mm (AxB), mit Mittelvalve 80 x 80 mm (21-0509)
 Abdominal retractor, lateral valves 100 x 32 mm (AxB) and 100 x 38 mm (AxB), with central valve 80 x 80 mm (21-0509)
 Separador abdominal, valvas laterales 100 x 32 mm (AxB) y 100 x 38 mm (AxB), con valva central 80 x 80 mm (21-0509)
 Ecarteur abdominal, valves latérales 100 x 32 mm (AxB) et 100 x 38 mm (AxB), avec valve centrale 80 x 80 mm (21-0509)
 Divaricatore addominale, valve laterali 100 x 32 mm (AxB) e 100 x 38 mm (AxB), con valva centrale 80 x 80 mm (21-0509)



BALFOUR
 21-0505

Bauchdeckenhalter, Seitenvalven 60 x 36 mm (AxB), mit Mittelvalve 48 x 78 mm (21-0507)
 Abdominal retractor, lateral valves 60 x 36 mm (AxB), with central valve 48 x 78 mm (21-0507)
 Separador abdominal, valvas laterales 60 x 36 mm (AxB), con valva central 48 x 78 mm (21-0507)
 Ecarteur abdominal, valves latérales 60 x 36 mm (AxB), avec valve centrale 48 x 78 mm (21-0507)
 Divaricatore addominale, valve laterali 60 x 36 mm (AxB), con valva centrale 48 x 78 mm (21-0507)



BALFOUR
 21-0503

Bauchdeckenhalter, Seitenvalven 60 x 36 mm (AxB), mit Mittelvalve 48 x 78 mm (21-0507)
 Abdominal retractor, lateral valves 60 x 36 mm (AxB), with central valve 48 x 78 mm (21-0507)
 Separador abdominal, valvas laterales 60 x 36 mm (AxB), con valva central 48 x 78 mm (21-0507)
 Ecarteur abdominal, valves latérales 60 x 36 mm (AxB), avec valve centrale 48 x 78 mm (21-0507)
 Divaricatore addominale, valve laterali 60 x 36 mm (AxB), con valva centrale 48 x 78 mm (21-0507)



BALFOUR
 21-0510

Bauchdeckenhalter, Seitenvalven 100 x 32 mm (AxB) und 100 x 38 mm (AxB), mit Mittelvalve 100 x 64 mm (21-0512)
 Abdominal retractor, lateral valves 100 x 32 mm (AxB) and 100 x 38 mm (AxB), with central valve 100 x 64 mm (21-0512)
 Separador abdominal, valvas laterales 100 x 32 mm (AxB) y 100 x 38 mm (AxB), con valva central 100 x 64 mm (21-0512)
 Ecarteur abdominal, valves latérales 100 x 32 mm (AxB) et 100 x 38 mm (AxB), avec valve centrale 100 x 64 mm (21-0512)
 Divaricatore addominale, valve laterali 100 x 32 mm (AxB) e 100 x 38 mm (AxB), con valva centrale 100 x 64 mm (21-0512)



Bauchdeckenhalter
Abdominal Retractors
Separadores abdominales
Ecarteurs abdominaux
Divaricatori addominali

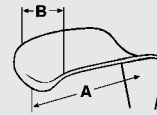

mit Sperre
with ratchet
con cremallera
avec crémaillère
con cremagliera

1/4

**BALFOUR modif.
21-0430**

Bauchdeckenhalter, Seitenvalven 64 x 45 mm (AxB), mit Mittelvalve 70 x 66 mm (21-0444)

Abdominal retractor, lateral valves 64 x 45 mm (AxB), with central valve 70 x 66 mm (21-0444)

Separador abdominal, valvas laterales 64 x 45 mm (AxB), con valva central 70 x 66 mm (21-0444)

Ecarteur abdominal, valves latérales 64 x 45 mm (AxB), avec valve centrale 70 x 66 mm (21-0444)

Divaricatore addominale, valve laterali 64 x 45 mm (AxB), con valva centrale 70 x 66 mm (21-0444)



mit Sperre
with ratchet
con cremallera
avec crémaillère
con cremagliera

1/4



Seitenvalven auswechselbar
Lateral valves interchangeable
Valvas laterales intercambiables
Valves latérales interchangeables
Valve laterali intercambiabili

**BALFOUR modif.
21-0431**

Bauchdeckenhalter, komplett, bestehend aus:
21-0432 1 Rahmen
21-0441 1 Paar Seitenvalven 64 x 45 mm (AxB)
21-0442 1 Paar Seitenvalven 89 x 45 mm (AxB)
21-0444 1 Mittelvalve 70 x 66 mm (AxB)

Abdominal retractor, complete, consisting of:
21-0432 1 Frame
21-0441 1 Pair lateral valves 64 x 45 mm (AxB)
21-0442 1 Pair lateral valves 89 x 45 mm (AxB)
21-0444 1 Central valve 70 x 66 mm (AxB)

Separador abdominal, completo, compuesto de:
21-0432 1 Cuadro
21-0441 1 Par de valvas laterales 64 x 45 mm (AxB)
21-0442 1 Par de valvas laterales 89 x 45 mm (AxB)
21-0444 1 Valva central 70 x 66 mm (AxB)

Ecarteur abdominal, complet, composé de:
21-0432 1 Cadre
21-0441 1 Paire de valves latérales 64 x 45 mm (AxB)
21-0442 1 Paire de valves latérales 89 x 45 mm (AxB)
21-0444 1 Valve centrale 70 x 66 mm (AxB)

Divaricatore addominale, completo, composto da:
21-0432 1 Telaio
21-0441 1 Paio di valve laterali 64 x 45 mm (AxB)
21-0442 1 Paio di valve laterali 89 x 45 mm (AxB)
21-0444 1 Valva centrale 70 x 66 mm (AxB)

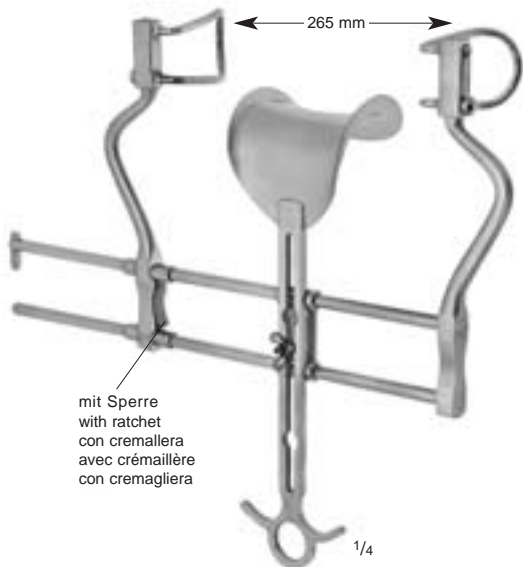

mit Sperre
with ratchet
con cremallera
avec crémaillère
con cremagliera

1/4



Seitenvalven auswechselbar
Lateral valves interchangeable
Valvas laterales intercambiables
Valves latérales interchangeables
Valve laterali intercambiabili

**BALFOUR modif.
21-0435**

Bauchdeckenhalter, komplett, bestehend aus:
21-0436 1 Rahmen
21-0441 1 Paar Seitenvalven 64 x 45 mm (AxB)
21-0442 1 Paar Seitenvalven 89 x 45 mm (AxB)
21-0445 1 Mittelvalve 65 x 84 mm (AxB)

Abdominal retractor, complete, consisting of:
21-0436 1 Frame
21-0441 1 Pair lateral valves 64 x 45 mm (AxB)
21-0442 1 Pair lateral valves 89 x 45 mm (AxB)
21-0445 1 Central valve 65 x 84 mm (AxB)

Separador abdominal, completo, compuesto de:
21-0436 1 Cuadro
21-0441 1 Par de valvas laterales 64 x 45 mm (AxB)
21-0442 1 Par de valvas laterales 89 x 45 mm (AxB)
21-0445 1 Valva central 65 x 84 mm (AxB)

Ecarteur abdominal, complet, composé de:
21-0436 1 Cadre
21-0441 1 Paire de valves latérales 64 x 45 mm (AxB)
21-0442 1 Paire de valves latérales 89 x 45 mm (AxB)
21-0445 1 Valve centrale 65 x 84 mm (AxB)

Divaricatore addominale, completo, composto da:
21-0436 1 Telaio
21-0441 1 Paio di valve laterali 64 x 45 mm (AxB)
21-0442 1 Paio di valve laterali 89 x 45 mm (AxB)
21-0445 1 Valva centrale 65 x 84 mm (AxB)

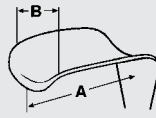

BALFOUR

- 21-0441 64 x 45 mm (AxB)
- 21-0442 89 x 45 mm (AxB)
- ▶ 21-0443 103 x 45 mm (AxB)

Seitenvalven, 1 Paar, für Bauchdeckenhalter
 21-0430 / 21-0431 / 21-0435

Lateral valves, 1 pair, for abdominal retractors
 21-0430 / 21-0431 / 21-0435

Valvas laterales, 1 par, para separadores
 abdominales 21-0430 / 21-0431 / 21-0435

Valves latérales, 1 paire, pour écarteurs
 abdominaux 21-0430 / 21-0431 / 21-0435

Valve laterali, 1 paio, per divaricatori addominali
 21-0430 / 21-0431 / 21-0435



BALFOUR

- 21-0444 70 x 66 mm (AxB)
- 21-0445 65 x 84 mm (AxB)
- ▶ 21-0446 45 x 93 mm (AxB)

Mittelvalven für Bauchdeckenhalter
 21-0430 / 21-0431 / 21-0435

Central valves, for abdominal retractors
 21-0430 / 21-0431 / 21-0435

Valvas centrales, para separadores
 abdominales 21-0430 / 21-0431 / 21-0435

Valves centrales, pour écarteurs
 abdominaux 21-0430 / 21-0431 / 21-0435

Valve centrali, per divaricatori addominali
 21-0430 / 21-0431 / 21-0435



HORGAN

- 21-0447
- 183 x 51 mm (AxB)

Mittelvalve, biegsam, für Bauchdeckenhalter
 21-0430 / 21-0431 / 21-0435

Central valve, malleable, for abdominal
 retractors 21-0430 / 21-0431 / 21-0435

Valva central, maleable, para separadores
 abdominales 21-0430 / 21-0431 / 21-0435

Valve centrale, malléable, pour écarteurs
 abdominaux 21-0430 / 21-0431 / 21-0435

Valva centrale, malleabile, per divaricatori
 addominali 21-0430 / 21-0431 / 21-0435



BALFOUR

- ▶ 21-0448 rechts • right • derecho • à droite • destra
- 21-0449 links • left • izquierdo • à gauche • sinistra

Seitenarme für Bauchdeckenhalter 21-0430 / 21-0431 / 21-0435

Side-arms for abdominal retractors 21-0430 / 21-0431 / 21-0435

Brazos laterales para separadores abdominales 21-0430 / 21-0431 / 21-0435

Bras latéraux pour écarteurs abdominaux 21-0430 / 21-0431 / 21-0435

Braccio laterale per divaricatori addominali 21-0430 / 21-0431 / 21-0435



Bauchdeckenhalter
Abdominal Retractors
Separadores abdominales
Ecarteurs abdominaux
Divaricatori addominali

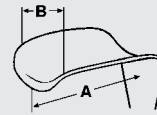

O'SULLIVAN-O'CONNOR
21-0550

Bauchdeckenhalter, komplett, bestehend aus:
21-0554 1 Rahmen mit 2 Seitenvalven 62 x 25 mm (AxB)
21-0552 2 Valven 81 x 46 mm (AxB)
21-0553 1 Valve 110 x 72 mm (AxB)

Abdominal retractor, complete, consisting of:
21-0554 1 Frame with 2 lateral valves 62 x 25 mm (AxB)
21-0552 2 Valves 81 x 46 mm (AxB)
21-0553 1 Valve 110 x 72 mm (AxB)

Separador abdominal, completo, compuesto de:
21-0554 1 Cuadro con 2 valvas laterales 62 x 25 mm (AxB)
21-0552 2 Valvas 81 x 46 mm (AxB)
21-0553 1 Valva 110 x 72 mm (AxB)

Ecarteur abdominal, complet, composé de:
21-0554 1 Cadre avec 2 valves latérales 62 x 25 mm (AxB)
21-0552 2 Valves 81 x 46 mm (AxB)
21-0553 1 Valve 110 x 72 mm (AxB)

Divaricatore addominale, completo, composto da:
21-0554 1 Telaio con valve laterali 62 x 25 mm (AxB)
21-0552 2 Valve 81 x 46 mm (AxB)
21-0553 1 Valva 110 x 72 mm (AxB)

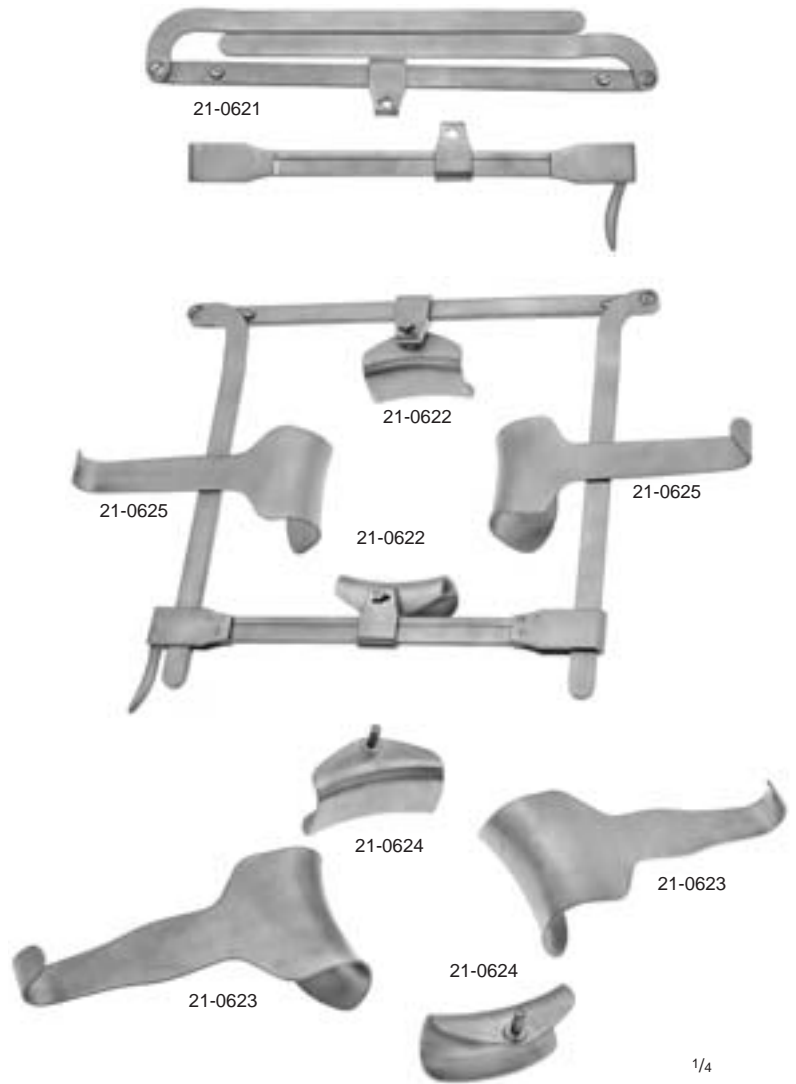

FRANZ
21-0620

Bauchdeckenhalter, komplett, bestehend aus:
21-0621 1 zusammenlegbarer Rahmen 220 x 220 mm
21-0622 2 Valven 40 x 62 mm (AxB)
21-0624 2 Valven 43 x 80 mm (AxB)
21-0625 2 Valven 48 x 65 mm (AxB)
21-0623 2 Valven 46 x 91 mm (AxB)

Abdominal retractor, complete, consisting of:
21-0621 1 Folding frame 220 x 220 mm
21-0622 2 Valves 40 x 62 mm (AxB)
21-0624 2 Valves 43 x 80 mm (AxB)
21-0625 2 Valves 48 x 65 mm (AxB)
21-0623 2 Valves 46 x 91 mm (AxB)

Separador abdominal, completo, compuesto de:
21-0621 1 Cuadro plegable 220 x 220 mm
21-0622 2 Valvas 40 x 62 mm (AxB)
21-0624 2 Valvas 43 x 80 mm (AxB)
21-0625 2 Valvas 48 x 65 mm (AxB)
21-0623 2 Valvas 46 x 91 mm (AxB)

Ecarteur abdominal, complet, composé de:
21-0621 1 Cadre pliant 220 x 220 mm
21-0622 2 Valves 40 x 62 mm (AxB)
21-0624 2 Valves 43 x 80 mm (AxB)
21-0625 2 Valves 48 x 65 mm (AxB)
21-0623 2 Valves 46 x 91 mm (AxB)

Divaricatore addominale, completo, composto da:
21-0621 1 Telaio piegabile 220 x 220 mm
21-0622 2 Valve 40 x 62 mm (AxB)
21-0624 2 Valve 43 x 80 mm (AxB)
21-0625 2 Valve 48 x 65 mm (AxB)

Bauchdeckenhalter
Abdominal Retractors
Separadores abdominales
Ecarteurs abdominaux
Divaricatori addominali

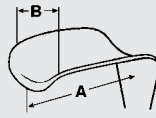

DENIS-BROWNE

21-0556

Bauchdeckenhalter, komplett, bestehend aus:
21-0557 1 Rahmen 180 x 150 mm
21-0558 2 Valven 40 x 30 mm (AxB)
21-0559 2 Valven 40 x 40 mm (AxB)

Abdominal retractor, complete, consisting of:
21-0557 1 Frame 180 x 150 mm
21-0558 2 Valves 40 x 30 mm (AxB)
21-0559 2 Valves 40 x 40 mm (AxB)

Separador abdominal, completo, compuesto de:
21-0557 1 Cuadro 180 x 150 mm
21-0558 2 Valvas 40 x 30 mm (AxB)
21-0559 2 Valvas 40 x 40 mm (AxB)

Ecarteur abdominal, complet, composé de:
21-0557 1 Cadre 180 x 150 mm
21-0558 2 Valves 40 x 30 mm (AxB)
21-0559 2 Valves 40 x 40 mm (AxB)

Divaricatore addominale, completo, composto da:
21-0557 1 Telaio 180 x 150 mm
21-0558 2 Valve 40 x 30 mm (AxB)
21-0559 2 Valve 40 x 40 mm (AxB)

21-0557 180 x 150 mm

21-0560 255 x 180 mm

Rahmen
Frames
Cuadros
Cadres
Telaio



für die Gynäkologie
for gynecology
para ginecología
pour gynécologie
per ginecologia

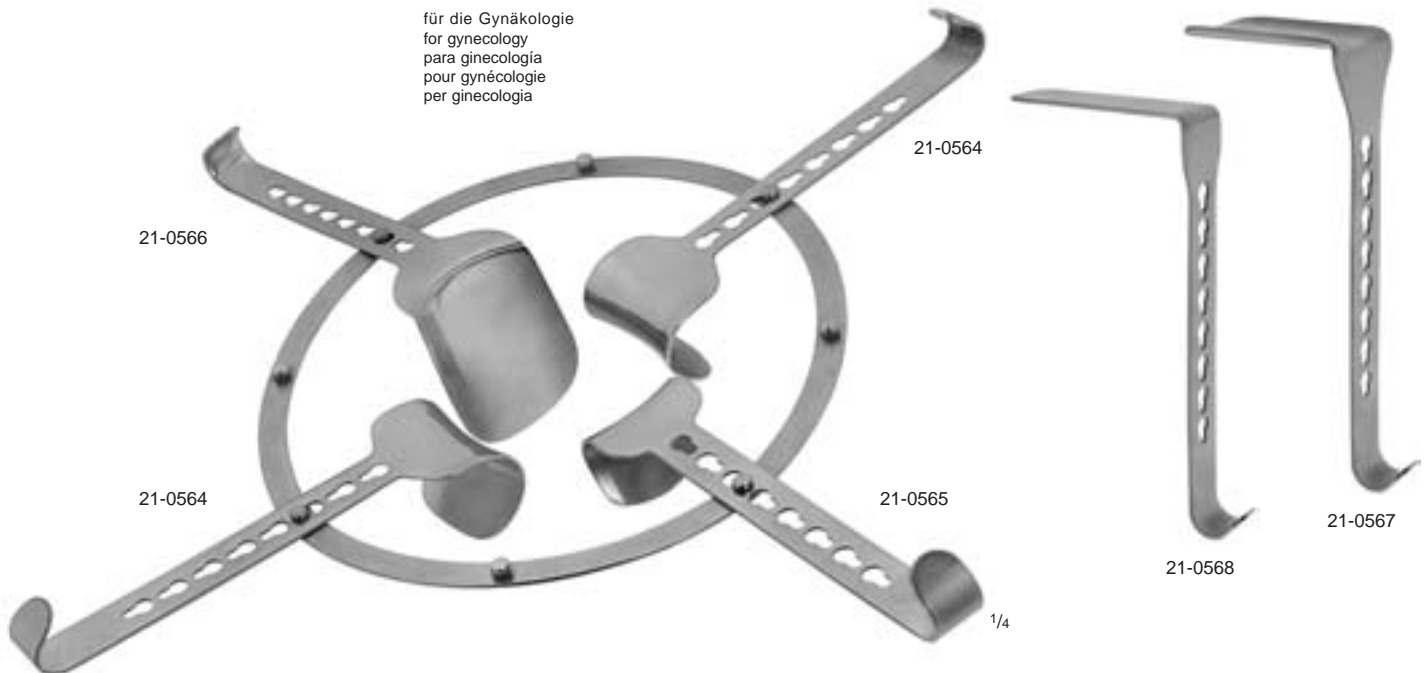

SEMM
21-0562

Bauchdeckenhalter, komplett, bestehend aus:
21-0563 1 Rahmen 275 x 250 mm
21-0564 2 Valven 47 x 65 mm (AxB)
21-0565 1 Valve für die Blase 50 x 54 mm (AxB)
21-0566 1 Valve für den Darm 76 x 98 mm (AxB)
21-0567 1 Valve für den Darm 98 x 52 mm (AxB)
21-0568 1 Valve 105 x 35 mm (AxB)

Ecarteur abdominal, complet, composé de:
21-0563 1 Cadre 275 x 250 mm
21-0564 2 Valves 47 x 65 mm (AxB)
21-0565 1 Valve pour vessie 50 x 54 mm (AxB)
21-0566 1 Valve pour intestin 76 x 98 mm (AxB)
21-0567 1 Valve pour intestin 98 x 52 mm (AxB)
21-0568 1 Valve 105 x 35 mm (AxB)

Abdominal retractor, complete, consisting of:
21-0563 1 Frame 275 x 250 mm
21-0564 2 Valves 47 x 65 mm (AxB)
21-0565 1 Valve for bladder 50 x 54 mm (AxB)
21-0566 1 Valve for intestine 76 x 98 mm (AxB)
21-0567 1 Valve for intestine 98 x 52 mm (AxB)
21-0568 1 Valve 105 x 35 mm (AxB)

Divaricatore addominale, completo, composto da:
21-0563 1 Telaio 275 x 250 mm
21-0564 2 Valve 47 x 65 mm (AxB)
21-0565 1 Valva per vescica 50 x 54 mm (AxB)
21-0566 1 Valva per intestino 76 x 98 mm (AxB)
21-0567 1 Valva per intestino 98 x 52 mm (AxB)
21-0568 1 Valva 105 x 35 mm (AxB)

Separador abdominal, completo, compuesto de:
21-0563 1 Cuadro 275 x 250 mm
21-0564 2 Valvas 47 x 65 mm (AxB)
21-0565 1 Valva para vejiga 50 x 54 mm (AxB)
21-0566 1 Valva para intestino 76 x 98 mm (AxB)
21-0567 1 Valva para intestino 98 x 52 mm (AxB)
21-0568 1 Valva 105 x 35 mm (AxB)



Bauchdeckenhalter
Abdominal Retractors
Separadores abdominales
Ecarteurs abdominaux
Divaricatori addominali

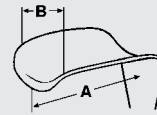

KIRSCHNER

► 21-0570

Bauchdeckenhalter, komplett, bestehend aus:

21-0575 1 starrer Rahmen 250 x 250 mm
21-0571 2 Valven 43 x 55 mm (AxB)
21-0572 2 Valven 48 x 65 mm (AxB)

Abdominal retractor, complete, consisting of:

21-0575 1 Fixed frame 250 x 250 mm
21-0571 2 Valves 43 x 55 mm (AxB)
21-0572 2 Valves 48 x 65 mm (AxB)

Separador abdominal, completo, compuesto de:

21-0575 1 Cuadro fijo 250 x 250 mm
21-0571 2 Valvas 43 x 55 mm (AxB)
21-0572 2 Valvas 48 x 65 mm (AxB)

Ecarteur abdominal, complet, composé de:

21-0575 1 Cadre fixe 250 x 250 mm
21-0571 2 Valves 43 x 55 mm (AxB)
21-0572 2 Valves 48 x 65 mm (AxB)

Divaricatore addominale, completo, composto da:

21-0575 1 Telaio fisso 250 x 250 mm
21-0571 2 Valve 43 x 55 mm (AxB)
21-0572 2 Valve 48 x 65 mm (AxB)

21-0575 250 x 250 mm
21-0584 300 x 320 mm
21-0585 300 x 380 mm

Starre Rahmen
Fixed frames
Cuadros fijos
Cadres fixe
Telaio fisso

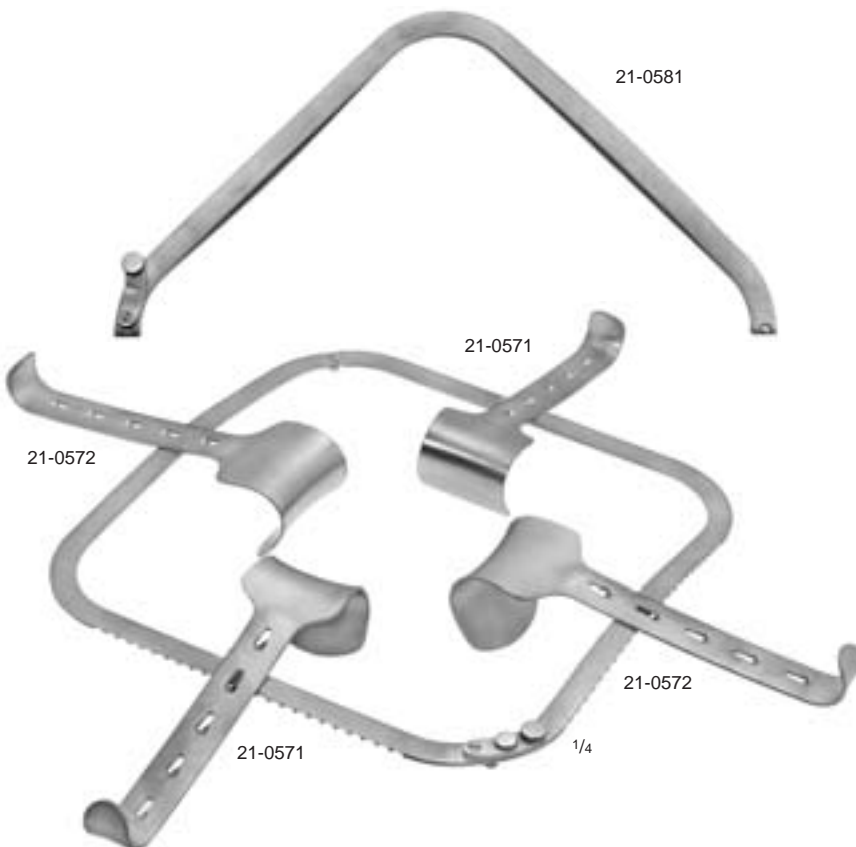
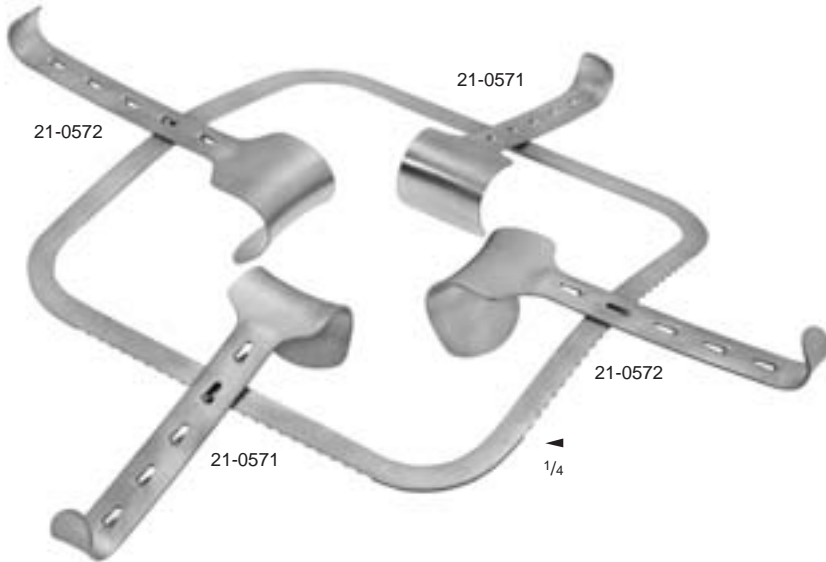

KIRSCHNER

21-0579

Bauchdeckenhalter, komplett, bestehend aus:

21-0581 1 zusammenlegbarer Rahmen 255 x 255 mm
21-0571 2 Valven 43 x 55 mm (AxB)
21-0572 2 Valven 48 x 65 mm (AxB)

Abdominal retractor, complete, consisting of:

21-0581 1 Folding frame 255 x 255 mm
21-0571 2 Valves 43 x 55 mm (AxB)
21-0572 2 Valves 48 x 65 mm (AxB)

Separador abdominal, completo, compuesto de:

21-0581 1 Cuadro plegable 255 x 255 mm
21-0571 2 Valvas 43 x 55 mm (AxB)
21-0572 2 Valvas 48 x 65 mm (AxB)

Ecarteur abdominal, complet, composé de:

21-0581 1 Cadre pliant 255 x 255 mm
21-0571 2 Valves 43 x 55 mm (AxB)
21-0572 2 Valves 48 x 65 mm (AxB)

Divaricatore addominale, completo, composto da:

21-0581 1 Telaio pieghevole 255 x 255 mm
21-0571 2 Valve 43 x 55 mm (AxB)
21-0572 2 Valve 48 x 65 mm (AxB)

Valven für KIRSCHNER Bauchdeckenhalter
 Valves for KIRSCHNER Abdominal Retractors
 Valvas para separadores abdominales KIRSCHNER
 Valves pour écarteurs abdominaux KIRSCHNER
 Valve per divaricatori addominali KIRSCHNER

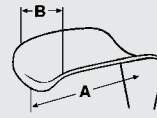

KIRSCHNER
 21-0571 43 x 55 mm (AxB)
 ► 21-0572 48 x 65 mm (AxB)
 21-0578 80 x 90 mm (AxB)
 21-0573 90 x 65 mm (AxB)
 21-0574 98 x 95 mm (AxB)



KIRSCHNER-BALFOUR
 21-0577
 83 x 82 mm (AxB)



KIRSCHNER
 21-0576
 60 x 82 mm (AxB)



KIRSCHNER
 21-0587 98 x 51 mm (AxB)
 ► 21-0588 105 x 38 mm (AxB)



Bauchdeckenhalter
Abdominal Retractors
Separadores abdominales
Ecarteurs abdominaux
Divaricatori addominali

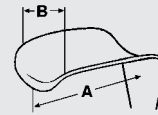

1/4

FOERSTER 21-0650

Bauchdeckenhalter aus NYLON, röntgendurchlässig, sterilisierbar nur im Autoklav bei 2 bar Überdruck (134°C), komplett, bestehend aus:
21-0651 1 Rahmen 255 x 255 mm
21-0652 4 Valven 51 x 64 mm (AxB)

Abdominal retractor, made of NYLON, transparent to X-ray, sterilizable only in the autoclave at 2 bar overpressure (134°C), complete, consisting of:

21-0651 1 Frame 255 x 255 mm
21-0652 4 Valves 51 x 64 mm (AxB)

Separador abdominal, de NILON, transparente a los rayos-x, esterilizable solamente en autoclave a 2 bar sobrepresión (134°C), completo, compuesto de:

21-0651 1 Cuadro 255 x 255 mm
21-0652 4 Valvas 51 x 64 mm (AxB)

Ecarteur abdominal, en VINYL, transparent aux rayons X stérilisable en autoclave à 2 bar (134°C) seulement, complet, composé de:

21-0651 1 Cadre 255 x 255 mm
21-0652 4 Valves 51 x 64 mm (AxB)

Divaricatore addominale, in NYLON, radiotrasparente, sterilizzabile solo in autoclave a 2 bar (134°C), completo, composta da:

21-0651 1 Telaio 255 x 255 mm
21-0652 4 Valve 51 x 64 mm (AxB)



1/4

FOERSTER 21-0652 51 x 64 mm (AxB)

Valve aus NYLON, für Bauchdeckenhalter 21-0650

Valve, made of NYLON, for abdominal retractor 21-0650

Valva, de NILON, para separador abdominal 21-0650

Valve VINYL, pour écarteur abdominal 21-0650

Valva, in NYLON, per divaricatore addominale 21-0650



1/4

FOERSTER 21-0653 78 x 65 mm (AxB)

Valve aus NYLON, für Bauchdeckenhalter 21-0650

Valve, made of NYLON, for abdominal retractor 21-0650

Valva, de NILON, para separador abdominal 21-0650

Valve VINYL, pour écarteur abdominal 21-0650

Valva, in NYLON, per divaricatore addominale 21-0650



1/2

FOERSTER 21-0654

Ersatzknopf aus NYLON, für Rahmen 21-0651

Spare button, made of NYLON, for frame 21-0651

Botón de repuesto, de NILON, para cuadro 21-0651

Bouton VINYL, pour cadre 21-0651

Bottone di ricambio, in NYLON, per telaio 21-0651

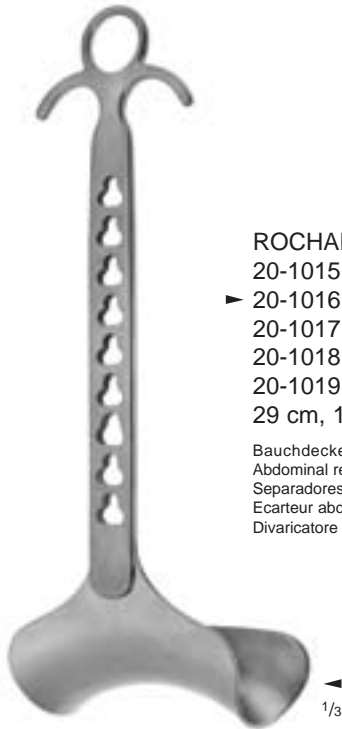
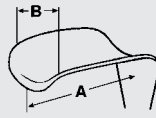

ROCHARD
 20-1015 50 x 90 mm (AxB)
 ▶ 20-1016 50 x 105 mm (AxB)
 20-1017 50 x 120 mm (AxB)
 20-1018 50 x 135 mm (AxB)
 20-1019 50 x 155 mm (AxB)
 29 cm, 11 1/2"

Bauchdeckenhaken
 Abdominal retractors
 Separadores abdominales
 Ecarteur abdominal
 Divaricatore addominale

1/3



1/3

ROCHARD
 20-1011
 19,5 cm, 7 3/4"

Fixiervorrichtung für 20-1015 - 20-1019
 Fixation device for 20-1015 - 20-1019
 Dispositivo de fijación para 20-1015 - 20-1019
 Compas articulé pour 20-1015 - 20-1019
 Dispositivo di fissaggio per 20-1015 - 20-1019



ROCHARD
 20-1010

Befestigungsgestell zur Fixierung an den Seitenschiene
 25 x 10 mm der OP-Tische, zur Sterilisation zerlegbar

Mounting frame for fastening to the lateral bars 25 x 10 mm
 of the operating tables, can be dismantled for sterilization

Bastidor para la fijación a las barras laterales 25 x 10 mm
 de las mesas de operación, plegable para la esterilización

Cadre se fixant aux barres latérales 25 x 10 mm de la table
 d'opération, pliable pour stérilisation

Telaio di supporto per il fissaggio alla barra laterale 25 x 10 mm
 del tavolo operatorio può essere smontato per la sterilizzazione

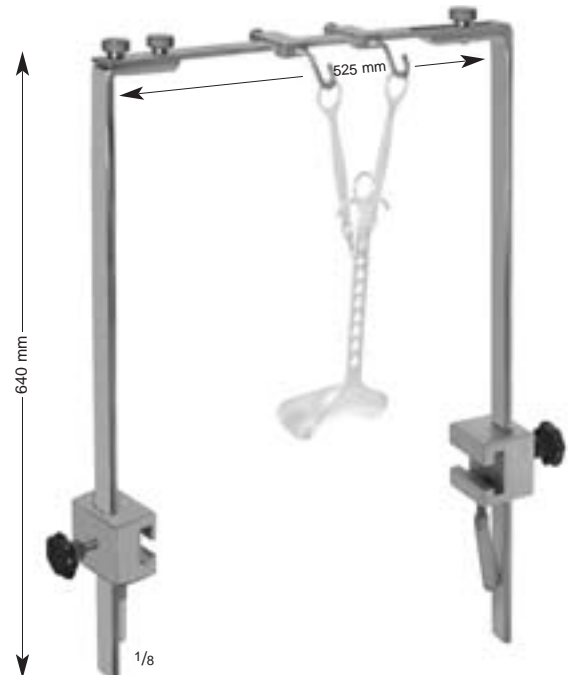

ROCHARD
 20-1013

Befestigungsgestell mit beidseitiger Fixierung an den Seitenschiene
 25 x 10 mm der OP-Tische, zur Sterilisation zerlegbar

Mounting frame for fastening to both sides of the lateral bars 25 x 10 mm
 of the operating table, can be dismantled for sterilization

Bastidor para la fijación a las ambas barras laterales 25 x 10 mm
 de las mesas de operación, plegable para la esterilización

Cadre se fixant aux barres latérales 25 x 10 mm de chaque côté de la
 table d'opération, pliable pour stérilisation

Telaio di supporto per il fissaggio alla barra laterali 25 x 10 mm del
 tavolo operatorio può essere smontato per la sterilizzazione



Blasenwundspreizer
Bladder Retractors
Separadores para la vejiga
Ecarteurs vésicaux
Divaricatori vescicali

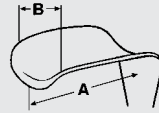

MILLIN
92-0130
21,5 cm, 8 1/2"

Blasenwundspreizer, komplett, bestehend aus:
92-0136 1 Spreizer
92-0137 1 Paar Seitenvalven 57 x 25 mm (AxB)
92-0138 1 Paar Seitenvalven 80 x 25 mm (AxB)
92-0139 1 Mittelvalve 120 x 45 mm (AxB)

Bladder retractor, complete, consisting of:
92-0136 1 Spreader
92-0137 1 Pair lateral valves 57 x 25 mm (AxB)
92-0138 1 Pair lateral valves 80 x 25 mm (AxB)
92-0139 1 Central valve 120 x 45 mm (AxB)

Separador para la vejiga, completo, compuesto de:
92-0136 1 Separador
92-0137 1 Par de valvas laterales 57 x 25 mm (AxB)
92-0138 1 Par de valvas laterales 80 x 25 mm (AxB)
92-0139 1 Valva central 120 x 45 mm (AxB)

Ecarteur vésical, complet, composé de:
92-0136 1 Ecarteur
92-0137 1 Paire de valves latérales 57 x 25 mm (AxB)
92-0138 1 Paire de valves latérales 80 x 25 mm (AxB)
92-0139 1 Valve centrale 120 x 45 mm (AxB)

Divaricatore vescicale, completo, composto da:
92-0136 1 Divaricatore
92-0137 1 Paio di valve laterali 57 x 25 mm (AxB)
92-0138 1 Paio di valve laterali 80 x 25 mm (AxB)
92-0139 1 Valva centrale 120 x 45 mm (AxB)



**JUDD-
MASSON**
92-0105

Blasenwundspreizer für suprapubische Prostatektomie, komplett, bestehend aus:
92-0106 1 Rahmen mit 2 Seitenvalven 70 x 25 mm (AxB)
92-0104 1 Mittelvalve 84 x 24 mm (AxB)

Bladder and suprapubic retractor, complete, consisting of:
92-0106 1 Frame with 2 lateral valves 70 x 25 mm (AxB)
92-0104 1 Central valve 84 x 24 mm (AxB)

Separador para la vejiga y la prostatectomía suprapubica, completo, compuesto de:
92-0106 1 Cuadro con 2 valvas laterales 70 x 25 mm (AxB)
92-0104 1 Valva central 84 x 24 mm (AxB)

Ecarteur pour la vessie et prostatectomie, complet, composé de:
92-0106 1 Cadre avec 2 valves latérales 70 x 25 mm (AxB)
92-0104 1 Valve centrale 84 x 24 mm (AxB)

Divaricatore per la vescica e la prostatectomia sovrapubica, completo, composta da:
92-0106 1 Telaio con 2 valve laterali 70 x 25 mm (AxB)
92-0104 1 Valva centrale 84 x 24 mm (AxB)

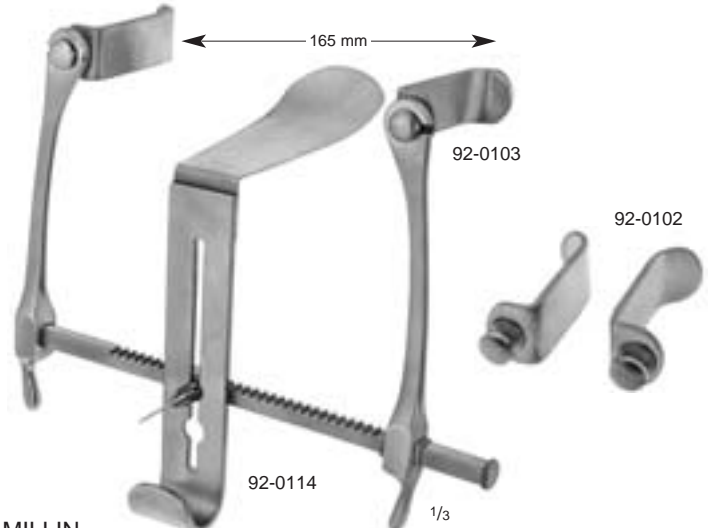

MILLIN
92-0108

Blasenwundspreizer, komplett, bestehend aus:
92-0101 1 Rahmen
92-0102 1 Paar Seitenvalven 50 x 22 mm (AxB)
92-0103 1 Paar Seitenvalven 63 x 22 mm (AxB)
92-0114 1 Mittelvalve 120 x 52 mm (AxB)

Bladder retractor, complete, consisting of:
92-0101 1 Frame
92-0102 1 Pair lateral valves 50 x 22 mm (AxB)
92-0103 1 Pair lateral valves 63 x 22 mm (AxB)
92-0114 1 Central valve 120 x 52 mm (AxB)

Separador para la vejiga, completo, compuesto de:
92-0101 1 Cuadro
92-0102 1 Par de valvas laterales 50 x 22 mm (AxB)
92-0103 1 Par de valvas laterales 63 x 22 mm (AxB)
92-0114 1 Valva central 120 x 52 mm (AxB)

Ecarteur vésical, complet, composé de:
92-0101 1 Cadre
92-0102 1 Paire de valves latérales 50 x 22 mm (AxB)
92-0103 1 Paire de valves latérales 63 x 22 mm (AxB)
92-0114 1 Valve centrale 120 x 52 mm (AxB)

Divaricatore per la vescica, completo, composto da:
92-0101 1 Telaio
92-0102 1 Paio di valve laterali 50 x 22 mm (AxB)
92-0103 1 Paio di valve laterali 63 x 22 mm (AxB)
92-0114 1 Valva centrale 120 x 52 mm (AxB)

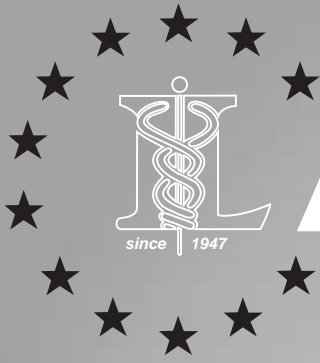

LAWNTON

Medizintechnik



Sonden, Trokare, Saugrohre, Spritzen
Probes, Trocars, Suction Tubes, Syringes
Sondas, Trócares, Tubos de aspiración, Jeringas
Sondes, Trocarts, Canules d'aspiration, Seringues
Sonde, Trequarti, Tubi aspirazione, Siringhe

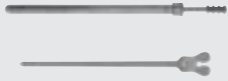

Sonden
Probes
Sondas
Stylets
Sonde



13 cm, 5 1/8"

Fig.	ø mm	Silber Silver Plata Argent Argento	Neusilber German silver Plata meneses Argent blanc Argento bianco
0000/000	0,4 / 0,6	63-2200	63-2230
00/0	0,7 / 0,8	63-2201	63-2231
1/2	0,9 / 1,1	63-2202	63-2233
3/4	1,3 / 1,4	▶ 63-2203	63-2235
5/6	1,5 / 1,6	63-2204	63-2237
7/8	1,8 / 1,9	63-2205	63-2239

Tränenkanalsonden, zylindrisch / zylindrisch
Lachrymal probes, cylindrical / cylindrical
Estiletes para el canal lacrimal, cilíndricos / cilíndricos
Stylets pour le canal lacrymal, cylindriques / cylindriques
Stiletti per canale lacrimale, cilindrici / cilindrici



13 cm, 5 1/8"

Fig.	ø mm	Silber Silver Plata Argent Argento	Neusilber German silver Plata meneses Argent blanc Argento bianco
0000/000	0,4 / 0,6	63-2225	63-2240
00/0	0,7 / 0,8	63-2220	63-2241
1/2	0,9 / 1,1	63-2221	63-2243
3/4	1,3 / 1,4	▶ 63-2222	63-2245
5/6	1,5 / 1,6	63-2223	63-2247
7/8	1,8 / 1,9	63-2224	63-2249

Tränenkanalsonden, geknöpft / geknöpft
Lachrymal probes, buttoned / buttoned
Estiletes para el canal lacrimal, abotonados / abotonados
Stylets pour le canal lacrymal, boutonnés / boutonnés
Stiletti per canale lacrimale, bottonuti / bottonuti



- 15-0315 13,0 cm, 5 1/8"
- 15-0316 14,5 cm, 5 3/4"
- ▶ 15-0317 16,0 cm, 6 1/4"
- 15-0318 18,0 cm, 7"
- 15-0319 20,0 cm, 8"

Knopfsonden ø 1 mm
Buttoned probes, ø 1 mm
Sondas abotonadas, ø 1 mm
Sondes boutonnées, ø 1 mm
Sonde bottonute, ø 1 mm



- 15-0335 13,0 cm, 5 1/8"
- 15-0336 14,5 cm, 5 3/4"
- ▶ 15-0337 16,0 cm, 6 1/4"
- 15-0338 18,0 cm, 7"
- 15-0339 20,0 cm, 8"
- 15-0340 25,0 cm, 10"

Knopfsonden ø 1,5 mm
Buttoned probes, ø 1,5 mm
Sondas abotonadas, ø 1,5 mm
Sondes boutonnées, ø 1,5 mm
Sonde bottonute, ø 1,5 mm



- 15-0344 13,0 cm, 5 1/8"
- 15-0345 14,5 cm, 5 3/4"
- ▶ 15-0346 16,0 cm, 6 1/4"
- 15-0347 18,0 cm, 7"
- 15-0348 20,0 cm, 8"
- 15-0349 25,0 cm, 10"
- 15-0350 30,0 cm, 12"

Knopfsonden ø 2 mm
Buttoned probes, ø 2 mm
Sondas abotonadas, ø 2 mm
Sondes boutonnées, ø 2 mm
Sonde bottonute, ø 2 mm

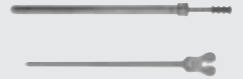

- 15-0304 13,0 cm, 5 1/8"
- ▶ 15-0305 14,5 cm, 5 3/4"
- 15-0306 16,0 cm, 6 1/4"
- 15-0307 18,0 cm, 7"
- 15-0308 20,0 cm, 8"
- 15-0310 25,0 cm, 10"

Öhrsonden ø 2 mm,
rostfrei

Probes with eye, ø 2 mm,
stainless steel

Sondas con ojete, ø 2 mm,
de acero inoxidable

Stylet aiguillé, ø 2 mm,
inoxydable

sonde con occhiello, ø 2 mm,
acciaio inox



- 15-0504 13,0 cm, 5 1/8"
- ▶ 15-0505 14,5 cm, 5 3/4"
- 15-0506 16,0 cm, 6 1/4"
- 15-0507 18,0 cm, 7"
- 15-0508 20,0 cm, 8"

Öhrsonden ø 2 mm,
Silber

Probes with eye, ø 2 mm,
silver

Sondas con ojete ø 2 mm,
de plata

Stylet aiguillé, ø 2 mm,
argent

sonde con occhiello ø 2 mm,
argento



- 15-0575 13,0 cm, 5 1/8"
- 15-0576 14,5 cm, 5 3/4"
- ▶ 15-0577 16,0 cm, 6 1/4"
- 15-0578 18,0 cm, 7"
- 15-0579 20,0 cm, 8"

Myrtenblattsonden
ø 2 mm

Myrtle leaf probes,
ø 2 mm

Sondas forma mirto,
ø 2 mm

Stylet feuille de sauge,
ø 2 mm

sonde a foglia di mirto,
ø 2 mm



STACKE

- 15-0560
11,5 cm, 4 1/2"

Knopfsonde ø 0,8 mm, Silber
Buttoned probe, ø 0.8 mm, silver
Sonda abotonada, ø 0,8 mm, plata
Sonde boutonée, ø 0,8 mm, argent
Sonda bottonuta, 0,8 mm, argento



FLUHRER

- ▶ 15-0555 ø 3,5 mm x 250 mm
- 15-0557 ø 3,5 mm x 400 mm

Knopfsonden, biegsam, Zinn
Buttoned probes, malleable, tin
Sondas abotonadas, maleable, estaño
Sondes boutonées, malléables, étain
Sonda bottonute, malleabili, stagno



- ▶ 15-0550 ø 1,5 mm x 300 mm
- ▶ 15-0551 ø 2,0 mm x 300 mm
- ▶ 15-0552 ø 2,5 mm x 300 mm

Knopfsonden
Buttoned probes
Sondas abotonadas
Sondes boutonée
Sonda bottonute

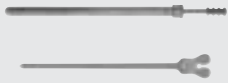

Sonden
Probes
Sondas
Sondes
Sonde



15-0203 11,5 cm, 4 1/2"
15-0204 13,0 cm, 5 1/8"
▶ 15-0205 14,5 cm, 5 3/4"
15-0206 16,0 cm, 6 1/4"

Hohlsonden
Directors
Sondas acanaladas
Sondes cannelées
Sonde scanalate



DOYEN
15-0223
14,5 cm, 5 3/4"

Hohlsonde
Director
Sonda acanalada
Sonde cannelée
Sonda scanalata



15-0214 13,0 cm, 5 1/8"
▶ 15-0215 14,5 cm, 5 3/4"
15-0216 16,0 cm, 6 1/4"

Hohlsonden mit Knopf
Directors with button
Sondas acanaladas con boton
Sondes boutonnées cannelées
Sonde bottonute scanalate



NELATON
15-0225
16 cm, 6 1/4"

Hohlsonde mit Knopf
Director with button
Sonda acanalada con boton
Sonde boutonnée cannelée
Sonda bottonuta scanalata



LOCKHART-MUMMERY
15-0230
16,5 cm, 6 1/2"

Fistelsonde
Fistula probe
Sonda para fistula
Sonde pour fistules
Sonda per fistole

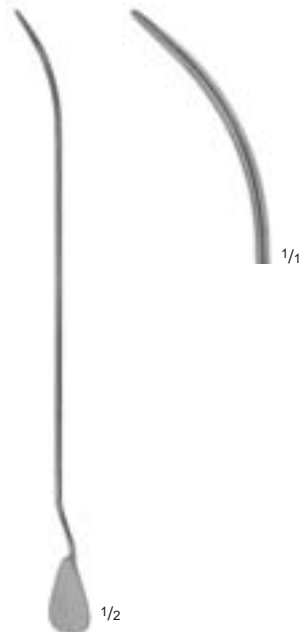

LOCKHART-MUMMERY
15-0231
16,5 cm, 6 1/2"

Fistelsonde
Fistula probe
Sonda para fistula
Sonde pour fistules
Sonda per fistole

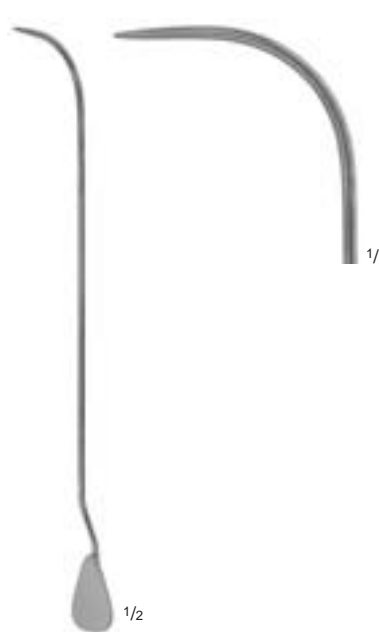

LOCKHART-MUMMERY
15-0232
16,5 cm, 6 1/2"

Fistelsonde
Fistula probe
Sonda para fistula
Sonde pour fistules
Sonda per fistole

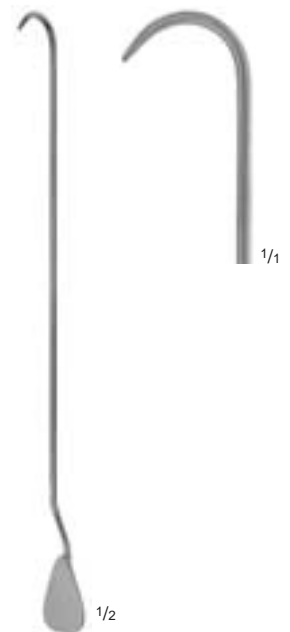

LOCKHART-MUMMERY
15-0233
16,5 cm, 6 1/2"

Fistelsonde
Fistula probe
Sonda para fistula
Sonde pour fistules
Sonda per fistole

Venenstripper
 Vein Strippers
 Sondas para várices
 Strippers à varices
 Sonde per vene

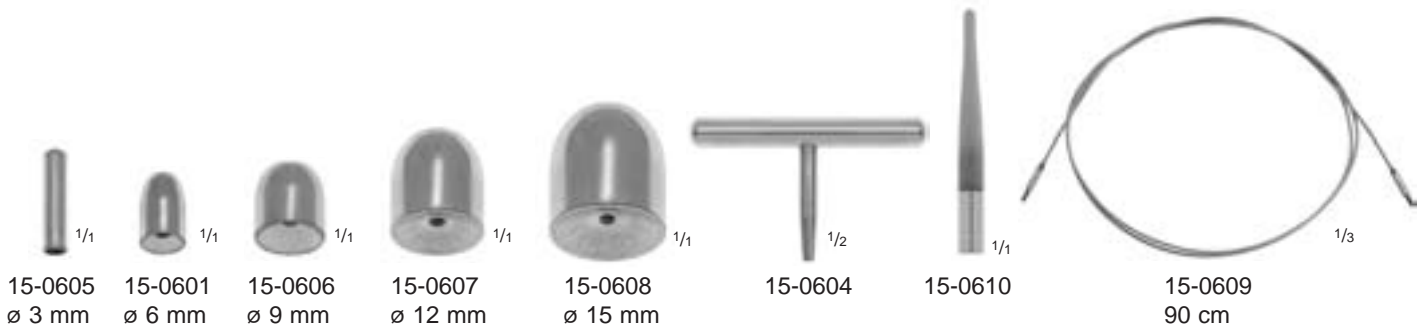
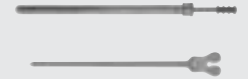

15-0605 ø 3 mm 15-0601 ø 6 mm 15-0606 ø 9 mm 15-0607 ø 12 mm 15-0608 ø 15 mm 15-0604 15-0610 15-0609 90 cm



1/4

NABATOFF
 15-0602

Krampfader-Besteck, komplett, bestehend aus:

- 15-0603 1 Metalletui 135 x 100 x 25 mm
- 15-0604 1 Handgriff
- 15-0605 1 Metall-Sondenspitze ø 3 mm
- 15-0610 1 Kunststoff-Sondenspitze
- 15-0601 1 Metalloolive ø 6 mm
- 15-0606 1 Metalloolive ø 9 mm
- 15-0607 1 Metalloolive ø 12 mm
- 15-0609 1 Zugseil, 90 cm lang

Varicose vein probe set, complete, consisting of:

- 15-0603 1 Metal case 135 x 100 x 25 mm
- 15-0604 1 Handle
- 15-0605 1 Metal probe tip, ø 3 mm
- 15-0610 1 Plastic probe tip
- 15-0601 1 Metal olive, ø 6 mm
- 15-0606 1 Metal olive, ø 9 mm
- 15-0607 1 Metal olive, ø 12 mm
- 15-0609 1 Flexible cable, 90 cm

Juego para várices, completo, compuesto de:

- 15-0603 1 Estuche de metal 135 x 100 x 25 mm
- 15-0604 1 Mango
- 15-0605 1 Extremidad de sonda de metal, ø 3 mm
- 15-0610 1 Extremidad de sonda de plástico
- 15-0601 1 Oliva de metal, ø 6 mm
- 15-0606 1 Oliva de metal, ø 9 mm
- 15-0607 1 Oliva de metal, ø 12 mm
- 15-0609 1 Cable de tracción, 90 cm

Astuccio per varici, completo, compsto da:

- 15-0603 1 Scatola in metallo 135 x 100 x 25 mm
- 15-0604 1 Manico
- 15-0605 1 Punta in materia metallo, ø 3 mm
- 15-0610 1 Punta in materia plastica
- 15-0601 1 Oliva in metallo, ø 6 mm
- 15-0606 1 Oliva in metallo, ø 9 mm
- 15-0607 1 Oliva in metallo, ø 12 mm
- 15-0609 1 Fune di trazione, flessibile, 90 cm

Trousse à varices, complète, composée de:

- 15-0603 1 Boîte métal 135 x 100 x 25 mm
- 15-0604 1 Manche
- 15-0605 1 Pointe métallique, ø 3 mm
- 15-0610 1 Pointe plastique
- 15-0601 1 Olive métallique, ø 6 mm
- 15-0606 1 Olive métallique, ø 9 mm
- 15-0607 1 Olive métallique, ø 12 mm
- 15-0609 1 Cable tracteur, flexible, 90 cm

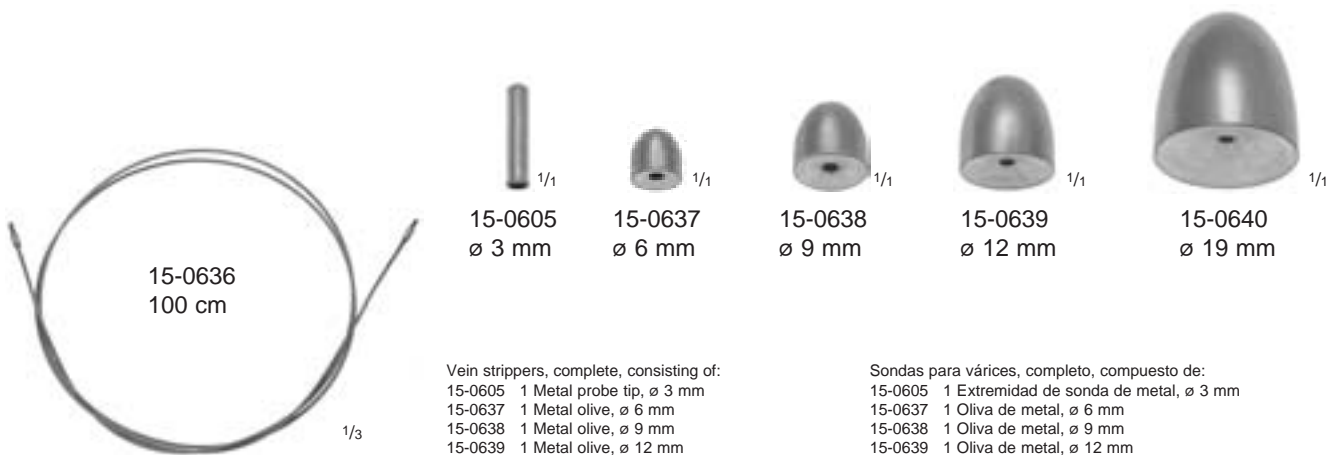

15-0636 100 cm

15-0605 ø 3 mm 15-0637 ø 6 mm 15-0638 ø 9 mm 15-0639 ø 12 mm 15-0640 ø 19 mm

MYERS
 15-0635

Venenstripper, komplett, bestehend aus:

- 15-0605 1 Metall-Sondenspitze ø 3 mm
- 15-0637 1 Metalloolive ø 6 mm
- 15-0638 1 Metalloolive ø 9 mm
- 15-0639 1 Metalloolive ø 12 mm
- 15-0640 1 Metalloolive ø 19 mm
- 15-0636 1 Zugseil, 100 cm lang

Vein strippers, complete, consisting of:

- 15-0605 1 Metal probe tip, ø 3 mm
- 15-0637 1 Metal olive, ø 6 mm
- 15-0638 1 Metal olive, ø 9 mm
- 15-0639 1 Metal olive, ø 12 mm
- 15-0640 1 Metal olive, ø 19 mm
- 15-0636 1 Flexible cable, 100 cm

Sondas para várices, completo, compuesto de:

- 15-0605 1 Extremidad de sonda de metal, ø 3 mm
- 15-0637 1 Oliva de metal, ø 6 mm
- 15-0638 1 Oliva de metal, ø 9 mm
- 15-0639 1 Oliva de metal, ø 12 mm
- 15-0640 1 Oliva de metal, ø 19 mm
- 15-0636 1 Cable de tracción, 100 cm

Stripper à varices, complet, composé de:

- 15-0605 1 Pointe métallique, ø 3 mm
- 15-0637 1 Olive métallique, ø 6 mm
- 15-0638 1 Olive métallique, ø 9 mm
- 15-0639 1 Olive métallique, ø 12 mm
- 15-0640 1 Olive métallique, ø 19 mm
- 15-0636 1 Cable tracteur, flexible, 100 cm

Sonde per vene, completo, composto da:

- 15-0605 1 Punta in materia metallo, ø 3 mm
- 15-0637 1 Oliva in metallo, ø 6 mm
- 15-0638 1 Oliva in metallo, ø 9 mm
- 15-0639 1 Oliva in metallo, ø 12 mm
- 15-0640 1 Oliva in metallo, ø 19 mm
- 15-0636 1 Fune di trazione, flessibile, 100 cm

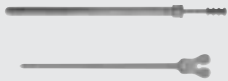

Watteträger
Cotton Applicators
Porta-algodones
Porte-cotons
Portacotone

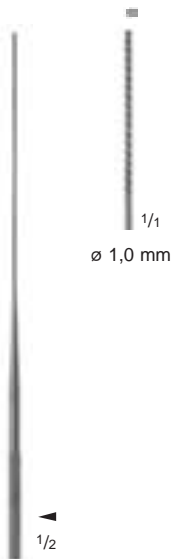

- FROHN**
66-0308 12 cm, 4 3/4"
▶ 66-0309 14 cm, 5 1/2"
66-0307 16 cm, 6 1/4"

spiralförmig gerieft
rough, spiral end
estriadura espiral
striures en spirale
zigrinatura spiraliforme

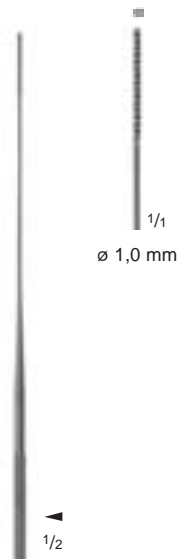

- FROHN**
66-0310 12 cm, 4 3/4"
▶ 66-0311 14 cm, 5 1/2"
66-0318 16 cm, 6 1/4"

rund kreuzgerieft
round, cross serrated end
estriadura redonda
rainures croisées
zigrinatura incrociata

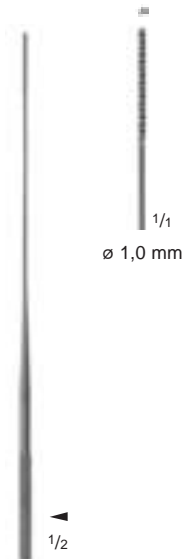

- FROHN**
66-0312 12 cm, 4 3/4"
▶ 66-0313 14 cm, 5 1/2"
66-0319 16 cm, 6 1/4"

dreikant gerieft
triangular serrated end
estriadura triangular
striures triangulaires
zigrinatura triangolare

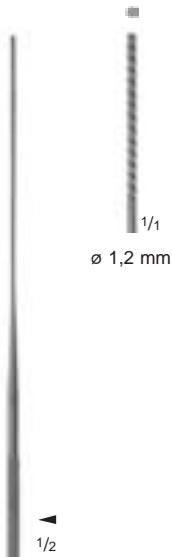

- LATHBURY (FARRELL)**
66-0320 12 cm, 4 3/4"
▶ 66-0321 14 cm, 5 1/2"
66-0322 16 cm, 6 1/4"

spiralförmig gerieft
rough, spiral end
estriadura espiral
striures en spirale
zigrinatura spiraliforme

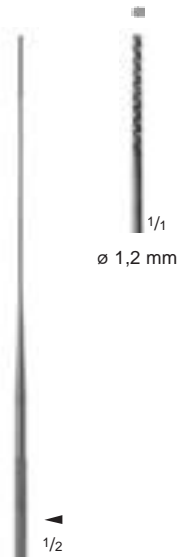

- LATHBURY (FARRELL)**
66-0325 12 cm, 4 3/4"
▶ 66-0326 14 cm, 5 1/2"
66-0327 16 cm, 6 1/4"

rund kreuzgerieft
round, cross serrated end
estriadura redonda
rainures croisées
zigrinatura incrociata

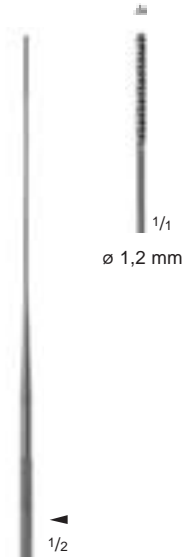

- LATHBURY (FARRELL)**
66-0330 12 cm, 4 3/4"
▶ 66-0331 14 cm, 5 1/2"
66-0332 16 cm, 6 1/4"

dreikant gerieft
triangular serrated end
estriadura triangular
striures triangulaires
zigrinatura triangolare

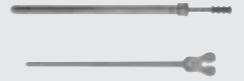

UCKERMANN
 65-0431
 16 cm, 6 1/4"

spiralförmig gerieft
 rough, spiral end
 estriadura espiral
 striures en spirale
 zigrinatura spiraliforme



JOBSON-HORNE
 65-0432
 18 cm, 7"

gerieft
 serrated end
 estriadura
 strié
 zigrinatura



PELTESON
 15-0792
 21,5 cm, 8 1/2"

spiralförmig gerieft
 rough, spiral end
 estriadura espiral
 striures en spirale
 zigrinatura spiraliforme



FEIN
 15-0793
 28 cm, 11"

spiralförmig gerieft
 rough, spiral end
 estriadura espiral
 striures en spirale
 zigrinatura spiraliforme

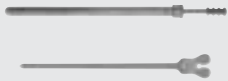

Trokare
Trocars
Trócares
Trocarts
Trequarti

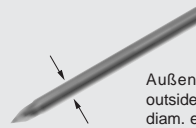

Außendurchmesser
outside diam.
diam. exterior
diamètre extérieur
diámetro externo

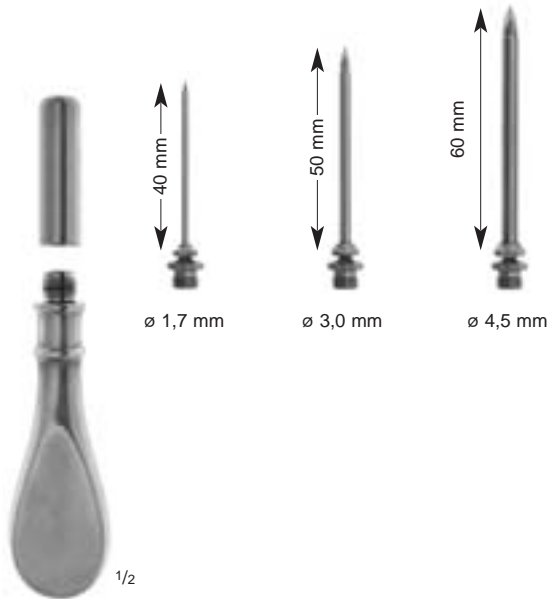

UNIVERSAL
17-0115

Trokar mit 3 Aufsätzen
Trocar with 3 tips
Trócar con 3 puntas
Trocarts avec 3 embouts
Trequarti con 3 punte

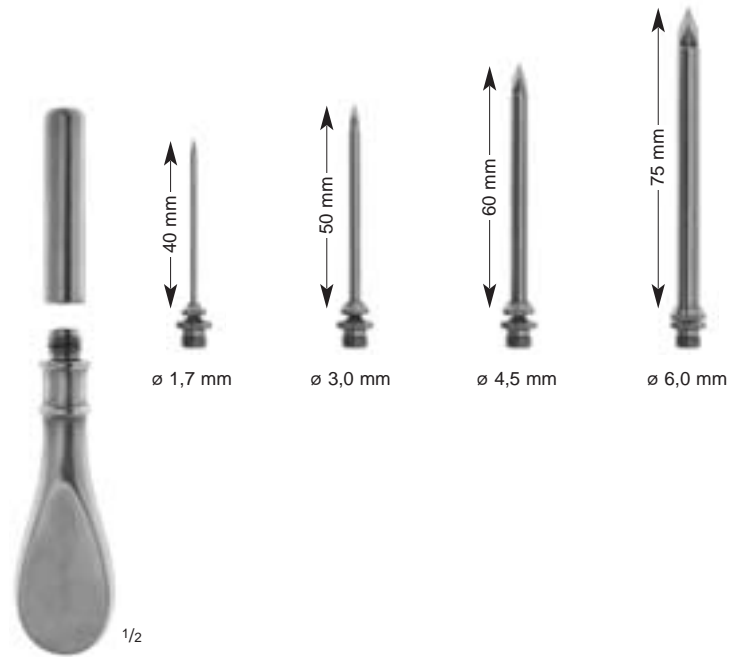

UNIVERSAL
17-0110

Trokar mit 4 Aufsätzen
Trocar with 4 tips
Trócar con 4 puntas
Trocarts avec 4 embouts
Trequarti con 4 punte

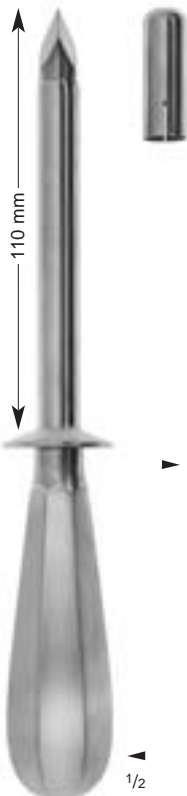

NELSON
39-0523 ø 10 mm
▶ 39-0524 ø 11 mm
21 cm, 8 1/4"

Trokare für Hydrozele
und Bauchstich
Trocars for hydrocele
and abdominal puncture
Trócares para hidrocele y
punción abdominal
Trocarts pour hydrozèle et
ponction abdominale
Trequarti per idrocele e
puntura addominale

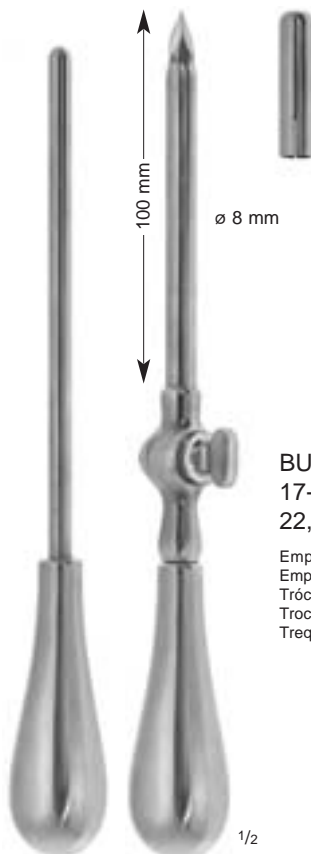

BUELAU
17-0170
22,5 cm, 9"

Empyema-Trokar
Empyema trocar
Trócar para punción torácica
Trocarts pour ponction thoracique
Trequarti per empiema

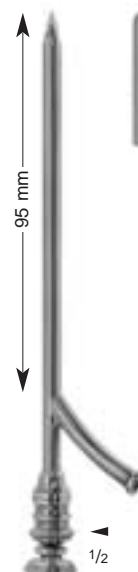

OCHSNER
11-0610 ø 3,5 mm
11-0612 ø 4,5 mm
▶ 11-0614 ø 5,0 mm
11-0616 ø 5,5 mm
11-0618 ø 6,0 mm
15 cm, 6"

Gallenblasentrokare
Gall bladder trocars
Trócares para vesícula biliar
Trocarts pour vésicule biliaire
Trequarti per vescica biliare

Kieferhöhlentrokare
 Antrum Trocars
 Trócares para el seno maxilar
 Trocarts pour le sinus maxillaire
 Trequarti per puntura del seno mascellare

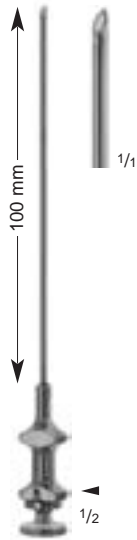
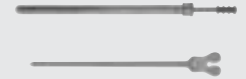

LICHTWITZ
 70-0787 ø 1,5 mm
 ▶ 70-0788 ø 1,8 mm
 70-0789 ø 2,0 mm

Kieferhöhlenpunktionskanülen
 mit LUER-Ansatz
 Antrum trocar needles with
 LUER connection
 Cánula para punción del seno
 maxilar con montura LUER-LOCK
 Trocarts pour ponction du sinus
 maxillaire avec embout LUER-LOCK
 Trequarti per puntura del seno
 mascellare con attacco LUER-LOCK

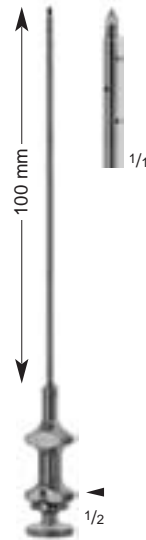

LICHTWITZ V. EICKEN
 70-0794 ø 1,5 mm
 ▶ 70-0795 ø 1,8 mm
 70-0796 ø 2,0 mm

Kieferhöhlenpunktionskanülen
 mit LUER-Ansatz
 Antrum trocar needles with
 LUER connection
 Cánula para punción del seno
 maxilar con montura LUER-LOCK
 Trocarts pour ponction du sinus
 maxillaire avec embout LUER-LOCK
 Trequarti per puntura del seno
 mascellare con attacco LUER-LOCK

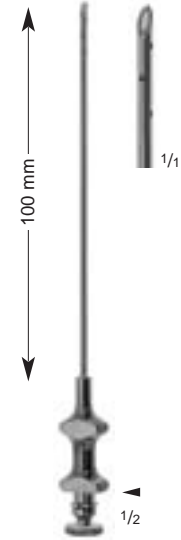

VOGEL
 70-0804 ø 1,5 mm
 ▶ 70-0805 ø 1,8 mm
 70-0806 ø 2,0 mm

Kieferhöhlenpunktionskanülen
 mit LUER-Ansatz
 Antrum trocar needles with
 LUER connection
 Cánula para punción del seno
 maxilar con montura LUER-LOCK
 Trocarts pour ponction du sinus
 maxillaire avec embout LUER-LOCK
 Trequarti per puntura del seno
 mascellare con attacco LUER-LOCK



COAKLEY
 70-0850
 15,5 cm, 6"

Kieferhöhlentrokar
 Antrum trocar
 Cánula para punción del seno maxilar
 Trocart pour le sinus maxillaire
 Trequarti per puntura del seno mascellare

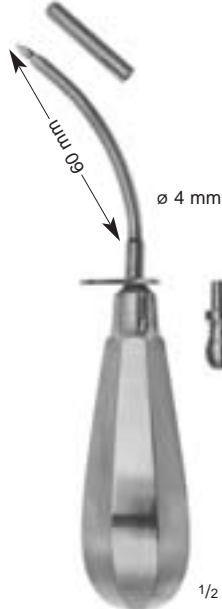

PIERCE
 70-0860
 15 cm, 6"

Kieferhöhlentrokar
 Antrum trocar
 Cánula para punción del seno maxilar
 Trocart pour le sinus maxillaire
 Trequarti per puntura del seno mascellare

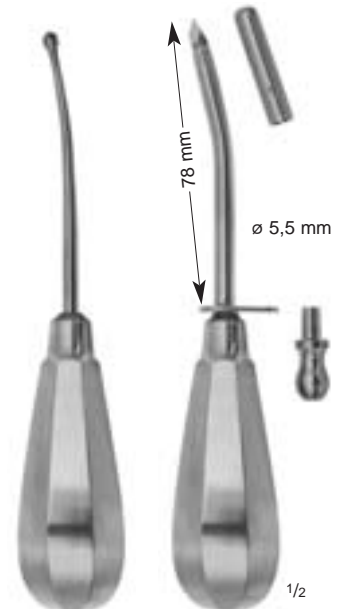

KRAUSE
 70-0865
 16 cm, 6 1/4"

Kieferhöhlentrokar
 Antrum trocar
 Cánula para punción del seno maxilar
 Trocart pour le sinus maxillaire
 Trequarti per puntura del seno mascellare

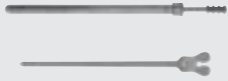

Kieferhöhlentrokare
Antrum Trocars
Trócares para el seno maxilar
Trocarts pour le sinus maxillaire
Trequarti per puntura del seno mascellare

Saugkanülen
Suction Cannulae
Cánulas para aspiración
Canules d'aspiration
Cannule per aspirazione

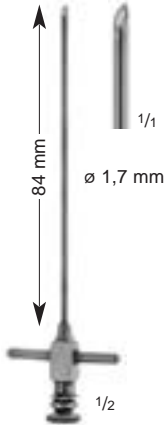

LICHTWITZ
70-0810
11 cm, 4 3/8"

Kieferhöhlentrokare
Antrum trocar
Cánula para punción del seno maxilar
Trocarts pour le sinus maxillaire
Trequarti per puntura del seno mascellare

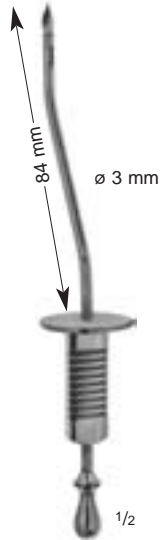

DOUGLAS
70-0840
14 cm, 5 1/2"

Kieferhöhlentrokare
Antrum trocar
Cánula para punción del seno maxilar
Trocarts pour le sinus maxillaire
Trequarti per puntura del seno mascellare



LICHTWITZ
▶ 70-0870 ø 1,8 mm
70-0871 ø 2,5 mm
18,5 cm, 7 1/4"

Kieferhöhlentrokare
Antrum trocars
Cánula para punción del seno maxilar
Trocarts pour le sinus maxillaire
Trequarti per puntura del seno mascellare



ROSEN
68-1480 ø 0,7 mm
68-1481 ø 0,9 mm
▶ 68-1482 ø 1,2 mm
10,5 cm, 8 1/8"

Saugkanülen mit LUER-LOCK Ansatz

Suction cannulae with LUER-LOCK connection

Cánulas para aspiración con montura LUER-LOCK

Canules d'aspiration avec embout LUER-LOCK

Cannule per aspirazione con attacco LUER-LOCK



ROSEN
68-1484 ø 0,7 mm
68-1485 ø 0,9 mm
▶ 68-1486 ø 1,2 mm
10,5 cm, 8 1/8"

Saugkanülen mit LUER-LOCK Ansatz

Suction cannulae with LUER-LOCK connection

Cánulas para aspiración con montura LUER-LOCK

Canules d'aspiration avec embout LUER-LOCK

Cannule per aspirazione con attacco LUER-LOCK



68-1489
6 cm, 2 3/8"

Schlauchverbindungsstück mit LUER-Konus und Unterbrecher, für 68-1480 bis 68-1486

Suction adapter with LUER cone and finger cut-off, for 68-1480 - 68-1486

Enchufe de conexión, con cono LUER y interruptor, para 68-1480 - 68-1486

Adaptateur avec cône LUER et interrupteur à doigt pour 68-1480 - 68-1486

Adattatore aspirazione con cono LUER e interruttore per 68-1480 - 68-1486



68-1488
11 cm, 4 3/8"

Saughandgriff mit LUER-Konus und Unterbrecher, für 68-1480 bis 68-1486

Suction handle with LUER cone and finger cut-off, for 68-1480 - 68-1486

Mano para aspiración, con cono LUER y interruptor, para 68-1480 - 68-1486

Manche pour aspiraton avec cône LUER et interrupteur à doigt pour 68-1480 - 68-1486

Manico per aspirazione con cono LUER e interruttore per 68-1480 - 68-1486

Saugkanülen
Suction Cannulae
Cánulas para aspiración
Canules d'aspiration
Cannule per aspirazione

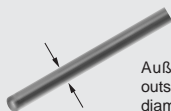

Außendurchmesser
outside diam.
diam. exterior
diamètre extérieur
diametro esterno

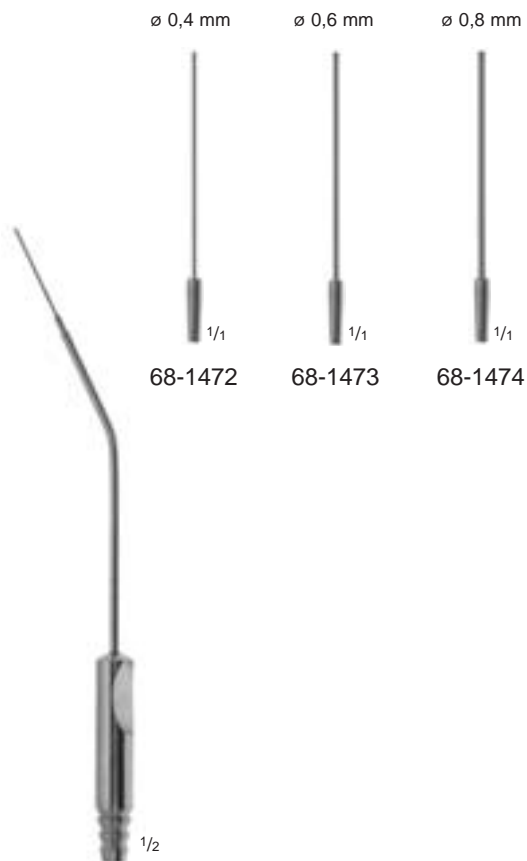
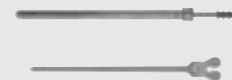

WULLSTEIN
68-1470
17 cm, 6 3/4"

Mikro-Absaugrohr, komplett, bestehend aus:
68-1471 1 Absaugrohr mit LUER-Bohrung
68-1472 1 Mikro-Saugkanüle ø 0,4 mm
68-1473 1 Mikro-Saugkanüle ø 0,6 mm
68-1474 1 Mikro-Saugkanüle ø 0,8 mm

Micro suction tube, complete, consisting of:
68-1471 1 Suction tube with LUER hub
68-1472 1 Micro suction cannula, ø 0.4 mm
68-1473 1 Micro suction cannula, ø 0.6 mm
68-1474 1 Micro suction cannula, ø 0.8 mm

Aspirador micro, completo, compuesto de:
68-1471 1 Tubo de aspiración, con cono LUER
68-1472 1 Cánula para aspiración micro ø 0,4 mm
68-1473 1 Cánula para aspiración micro ø 0,6 mm
68-1474 1 Cánula para aspiración micro ø 0,8 mm

Micro-canule d'aspiration, complète, composée de:
68-1471 1 Tube d'aspiration avec cône LUER
68-1472 1 Micro-canule d'aspiration, ø 0,4 mm
68-1473 1 Micro-canule d'aspiration, ø 0,6 mm
68-1474 1 Micro-canule d'aspiration, ø 0,8 mm

Mirco-tubo aspirazione, completo, composto da:
68-1471 1 Tubo aspirazione con perforazione LUER
68-1472 1 Micro-cannula per aspirazione ø 0,4 mm
68-1473 1 Micro-cannula per aspirazione ø 0,6 mm
68-1474 1 Micro-cannula per aspirazione ø 0,8 mm



ZOELLNER
68-1440
18 cm, 7"

Mikro-Absaugrohr mit Saugkanüle ø 0,6 mm (68-1441), Olive mit LUER-Bohrung

Micro suction tube with suction cannula ø 0.6 mm (68-1441), olive with LUER hub

Aspirador micro con cánula para aspiración ø 0,6 mm (68-1441), oliva con cono LUER

Micro-canule d'aspiration avec embout d'aspiration ø 0,6 mm (68-1441), olive avec cône LUER

Micro-tubo aspirazione con cannula per aspirazione ø 0,6 mm (68-1441), oliva con perforazione LUER



BARNES
70-0725
16 cm, 6 1/4"

Saugkanüle mit LUER-Bohrung und Unterbrecher

Suction cannula with LUER hub and finger cut-off

Cánula para aspiración con cono LUER y interruptor

Canule d'aspiration avec cône LUER et interrupteur à doigt

Cannula per aspirazione con perforazione LUER e interruttore

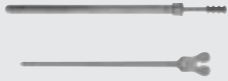

Saugkanülen
Suction Cannulae
Cánulas para aspiración
Canules d'aspiration
Cannule per aspirazione

Spülkanülen
Irrigation Cannulae
Cánulas para irrigación
Canules d'irrigation
Cannule per irrigazione

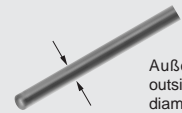

Außendurchmesser
outside diam.
diam. exterior
diamètre extérieur
diametro esterno



WULLSTEIN
68-1410
16 cm, 6 1/4"

Saugkanüle aus Silber, konisch,
Olive mit LUER-Bohrung

Suction cannula, silver, conical,
olive with LUER hub

Cánula para aspiración de plata,
cónica, oliva con cono LUER

Canule d'aspiration, en argent, cône,
olive avec cône LUER

Cannula per aspirazione, in argento,
conica, oliva con perforazione LUER



HARTMANN
65-0301 ø 2,5 mm
▶ 65-0302 ø 3,0 mm
65-0303 ø 3,5 mm
14,5 cm, 5 3/4"

Ohrkatheter
Eustachian catheters
Cateter de eustaquio
Sondes auriculaires
Sonde auricolari



EICKEN-KILLIAN
70-0670 ø 1,5 mm
▶ 70-0671 ø 2,5 mm
70-0673 ø 3,0 mm
14 cm, 5 1/2"

Kieferhöhlenspülkanülen mit LUER-Bohrung

Antrum wash cannulae with LUER hub

Cánulas para irrigación del senos maxilar con
cono LUER

Canules d'irrigation du sinus maxillaire avec
cône LUER

Cannule per irrigazione del seno mascellare
con perforazione LUER

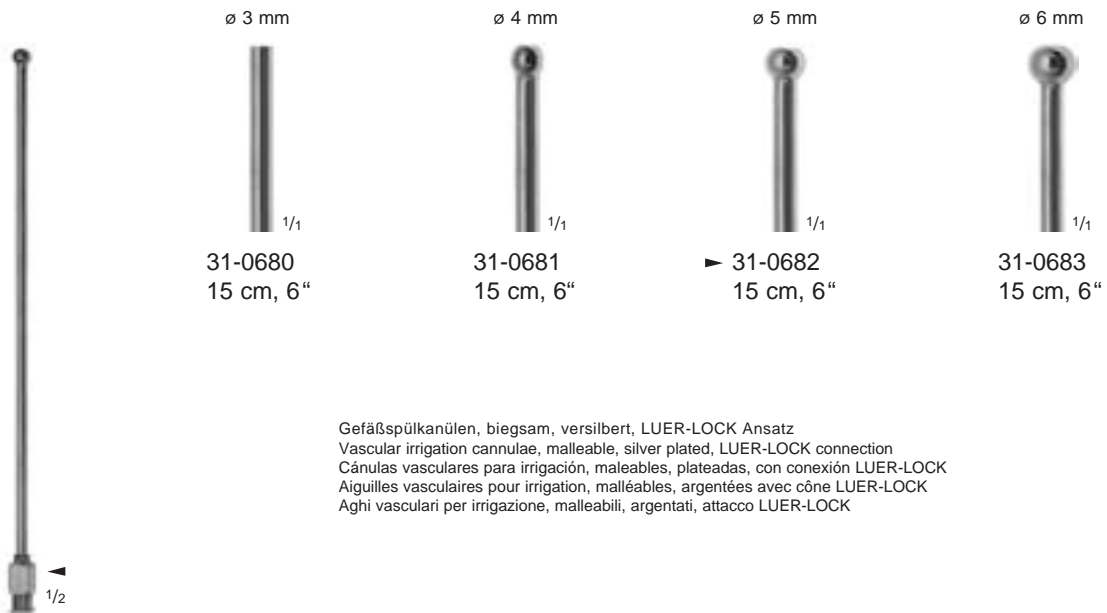

SCHMID
31-0680
- 31-0683

Gefäßspülkanülen, biegsam, versilbert, LUER-LOCK Ansatz
Vascular irrigation cannulae, malleable, silver plated, LUER-LOCK connection
Cánulas vasculares para irrigación, maleables, plateadas, con conexión LUER-LOCK
Aiguilles vasculaires pour irrigation, malléables, argentées avec cône LUER-LOCK
Aghi vascolari per irrigazione, malleabili, argentati, attacco LUER-LOCK

Saugkanülen mit Unterbrecher und Mandrin
 Suction Cannulae with finger cut-off and stylet
 Cánulas para aspiración con interruptor y estilete
 Canules d'aspiration avec interrupteur à doigt
 Cannule per aspirazione con interruttore e stiletto

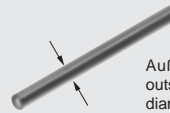

Außendurchmesser
 outside diam.
 diam. exterior
 diamètre extérieur
 diametro esterno



ADSON
 ▶ 51-0802 ø 4 mm
 51-0803 ø 5 mm
 21 cm, 8 1/4"



ADSON
 ▶ 51-0800 ø 4 mm
 51-0801 ø 5 mm
 21 cm, 8 1/4"



FRAZIER
 51-0866 ø 2,0 mm
 51-0867 ø 2,3 mm
 51-0868 ø 2,7 mm
 51-0870 ø 3,3 mm
 ▶ 51-0871 ø 3,7 mm
 20 cm, 8"



FRAZIER (FERGUSON)
 51-0806 ø 2,0 mm
 51-0807 ø 2,3 mm
 51-0808 ø 2,7 mm
 51-0810 ø 3,3 mm
 ▶ 51-0811 ø 3,7 mm
 51-0812 ø 4,0 mm
 51-0818 ø 5,0 mm
 18,5 cm, 7 1/4"



FRAZIER (FERGUSON)
 51-0828 ø 2,0 mm
 51-0829 ø 2,3 mm
 51-0830 ø 2,7 mm
 51-0832 ø 3,3 mm
 ▶ 51-0833 ø 3,7 mm
 51-0834 ø 4,0 mm
 51-0835 ø 5,0 mm
 14 cm, 5 1/2"

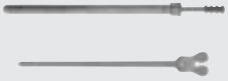

Saugrohre
Suction Tubes
Tubos para aspiración
Canules d'aspiration
Tubi aspirazione

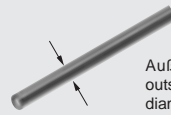

Außendurchmesser
outside diam.
diam. exterior
diamètre extérieur
diametro esterno

ø 3,0 x 6,5 mm



16-0200
15,5 cm, 6"

Nasensaugrohr mit LUER-Bohrung

Nasal suction tube with LUER hub

Tubo nasal para aspiración con cono de LUER

Canule d'aspiration nasale avec cône LUER

Tubo per aspirazione nasale con perforazione LUER



▶ 16-0202 ø 4,5 mm
16-0204 ø 5,5 mm
18,5 cm, 7 1/4"

Nasensaugrohre mit LUER-Bohrung

Nasal suction tubes with LUER hub

Tubos nasales para aspiración con cono de LUER

Canules d'aspiration nasale avec cône LUER

Tubi per aspirazione nasale con perforazione LUER



YASARGIL

16-0210 ø 1,5 mm

16-0212 ø 2,0 mm

▶ 16-0214 ø 2,5 mm

16-0216 ø 3,5 mm

22 cm, 8 3/4"

Saugrohre mit LUER-Bohrung
Suction tubes with LUER hub

Tubos para aspiración con cono de LUER

Canules d'aspiration avec cône LUER

Tubi aspirazione con perforazione LUER

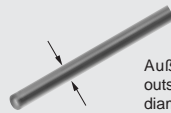

Außerdurchmesser
outside diam.
diam. exterior
diamètre extérieur
diametro esterno



ø 10 mm



POOLE
16-0250
23,5 cm, 9 1/4"

ø 5,5 mm



POOLE
16-0265
19,5 cm, 7 3/4"

ø 8 mm



POOLE
16-0255
25 cm, 10"

ø 6 mm



ANDREW-PYNCHON
16-0274
23 cm, 9"

16-0276

Saugkopf allein
Suction basket only
Cabezal para aspiración, suelto
Embout d'aspiration seul
Solo cestello aspirazione

▼
ø 10 mm



YANKAUER
16-0275
29 cm, 11 1/2"

16-0284

Saugkopf allein
Suction basket only
Cabezal para aspiración, suelto
Embout d'aspiration seul
Solo cestello aspirazione

▼
ø 9 mm



DE BAKEY
16-0279
28 cm, 11"

mit abschraubbarem Außenrohr
with outer tube to be screwed off
con tubo exterior desentoscable
avec canule extérieure démontable
con tubo esterno svitabile

mit seitlichen Schlitzen
with lateral slots
con ranuras laterales
avec tube cannelé
con scanalature laterali

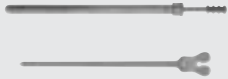

Saugrohre
Suction Tubes
Tubos para aspiración
Canules d'aspiration
Tubi aspirazione

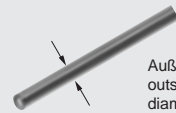

Außendurchmesser
outside diam.
diam. exterior
diamètre extérieur
diametro esterno

ø 2,6 mm



Fig. 0
16-0291

ø 3,3 mm



Fig. 1
16-0292

ø 4,8 mm



Fig. 2
16-0293

ø 10 mm



Fig. 3
16-0294

16-0276

Saugkopf allein
Suction basket only
Cabezal para aspiración, suelto
Embout d'aspiration seul
Solo cestello aspirazione

16-0276

Saugkopf allein
Suction basket only
Cabezal para aspiración, suelto
Embout d'aspiration seul
Solo cestello aspirazione

ø 10 mm



16-0296

YANKAUER
16-0289
27 cm, 10³/₄"

Saugrohr, komplett, bestehend aus:
16-0291 1 Saugkanülen-Aufsatz
16-0292 1 Saugkanülen-Aufsatz
16-0293 1 Saugkanülen-Aufsatz
16-0294 1 Saugkanülen-Aufsatz
16-0296 1 Griff

Suction tube, complete, consisting of:
16-0291 1 Tip, suction cannula
16-0292 1 Tip, suction cannula
16-0293 1 Tip, suction cannula
16-0294 1 Tip, suction cannula
16-0296 1 Handle

Tubo para aspiración, completo, compuesto de:
16-0291 1 Punta, cánula para aspiración
16-0292 1 Punta, cánula para aspiración
16-0293 1 Punta, cánula para aspiración
16-0294 1 Punta, cánula para aspiración
16-0296 1 Mango

Canule d'aspiration, complète, composée de:
16-0291 1 tige canule d'aspiration
16-0292 1 tige canule d'aspiration
16-0293 1 tige canule d'aspiration
16-0294 1 tige canule d'aspiration
16-0296 1 Manche

Tubo aspirazione, completo, composto di:
16-0291 1 punta cannula per aspirazione
16-0292 1 punta cannula per aspirazione
16-0293 1 punta cannula per aspirazione
16-0294 1 punta cannula per aspirazione
16-0296 1 Manico

YANKAUER
16-0277
32 cm, 12¹/₂"

mit Absperrventil und
abschraubbarem Rohr
with stopcock and tube
to be screwed off
con interruptor y tubo
desenroscable
avec robinet et canule
extérieure démontable
con interruttore e tubo
svitabile

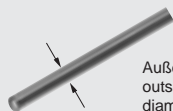

Außendurchmesser
outside diam.
diam. exterior
diamètre extérieur
diametro esterno

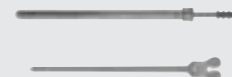

ø 8 mm



COOLEY
16-0267
36 cm, 14"

Saugrohr
Suction tube
Tubo para aspiración
Canule d'aspiration
Tubo aspirazione

16-0271

Saugkopf allein
Suction basket only
Cabezal para aspiración, suelto
Embout d'aspiration seul
Solo cestello aspirazione



ø 7 mm



COOLEY
16-0268
31 cm, 12 1/4"

Gefäßsaugrohr
Vascular suction tube
Tubo para aspiración
vascular
Canule d'aspiration
vasculaire
Tubo aspirazione
vascolare

16-0272

Saugkopf allein
Suction basket only
Cabezal para aspiración, suelto
Embout d'aspiration seul
Solo cestello aspirazione



ø 10 mm



COOLEY
16-0269
31 cm, 12 1/4"

Intracardiac Saugrohr
Intracardiac suction tube
Tubo para aspiración
intracardiaco
Canule d'aspiration
intra-cardiaque
Tubo aspirazione
intracardiaca

ø 8 mm

16-0273

Saugkopf allein
Suction basket only
Cabezal para aspiración, suelto
Embout d'aspiration seul
Solo cestello aspirazione



COOLEY
16-0270
35 cm, 13 3/4"

Saugrohr für linken Ventrikel,
mit abschraubbarem Rohr
Left ventricular sump suction tube,
with tube to be screwed off
Tubo para aspiración, para el ventrículo
izquierdo, con tubo desenroscable
Canule d'aspiration, pour ventricule
gauche avec tige démontable
Tubo aspirazione, ventricolare
sinistra con tubo svitabile

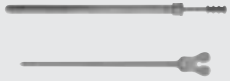

Spezialkanülen
Special Needles
Agujas especiales
Aiguilles spéciales
Aghi speciali

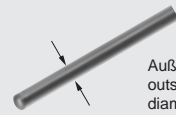

Außendurchmesser
outside diam.
diam. exterior
diamètre extérieur
diametro esterno



- TUOHY**
18-0407 ø 1,2 mm x 76 mm
▶ 18-0408 ø 1,4 mm x 76 mm
18-0409 ø 1,6 mm x 76 mm

Kanülen zur Lumbalpunktion
Lumbar puncture needles
Agujas para punción lumbar
Aiguilles pour ponction lombaire
Aghi per punture lombari



- QUINKE**
18-0422 ø 0,7 mm x 50 mm
18-0423 ø 0,7 mm x 76 mm
18-0424 ø 0,7 mm x 89 mm
18-0425 ø 1,0 mm x 76 mm
18-0426 ø 1,0 mm x 89 mm
18-0427 ø 1,2 mm x 76 mm
▶ 18-0428 ø 1,2 mm x 89 mm

Kanülen zur Lumbalpunktion
Lumbar puncture needles
Agujas para punción lumbar
Aiguilles pour ponction lombaire
Aghi per punture lombari



77-0685
ø 0,8 mm

Tonsillenkanüle
Tonsil needle
Aguja para amígdala
Aiguille pour amygdales
Ago per tonsille



77-0686
ø 0,8 mm

Tonsillenkanüle
Tonsil needle
Aguja para amígdala
Aiguille pour amygdales
Ago per tonsille



77-0687
ø 0,8 mm

Septumkanüle
Septum needle
Aguja para el tabique nasal
Aiguille pour la cloison nasale
Ago per setto nasale



77-0688
ø 0,8 mm

Septumkanüle
Septum needle
Aguja para el tabique nasal
Aiguille pour la cloison nasale
Ago per setto nasale

Biopsiekanülen
Biopsy Needles
Agujas para biopsia
Aiguilles à biopsie
Aghi per biopsia

Peritoneal-Pneu-Kanülen
Pneumoperitoneum Needles
Agujas para el neumoperitoneo
Aiguilles pour le pneumopéritoine
Aghi per il pneumo-peritoneo

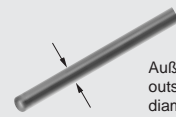

Außendurchmesser
outside diam.
diam. exterior
diamètre extérieur
diametro esterno

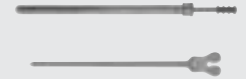

- MENGHINI**
- 18-0481 ø 1,0 mm x 35 mm
 - 18-0482 ø 1,0 mm x 70 mm
 - 18-0483 ø 1,2 mm x 70 mm
 - 18-0484 ø 1,2 mm x 100 mm
 - 18-0485 ø 1,4 mm x 70 mm
 - ▶ 18-0486 ø 1,4 mm x 100 mm
 - 18-0487 ø 1,6 mm x 70 mm
 - 18-0488 ø 1,8 mm x 100 mm

Kanülen für die Leberblindpunktion
Liver blind puncture needles
Agujas para la punción ciega del hígado
Aiguilles pour la ponction aveugle du foie
Aghi per la puntura cieca del fegato

1/2

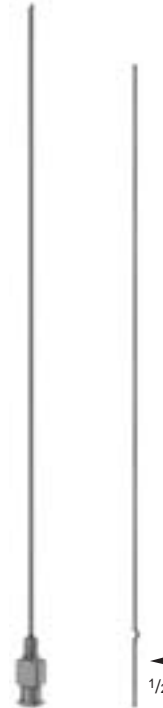

- MENGHINI**
- ▶ 18-0490 ø 1,4 mm x 168 mm
 - 18-0491 ø 1,8 mm x 168 mm

Kanülen zur gezielten Leberpunktion
Needles for controlled liver puncture
Agujas para la punción del hígado bajo el control laparoscópico
Aiguilles pour la ponction contrôlée du foie
Aghi per la puntura controllata del fegato

1/2



- KLIMA-ROSEGGER**
- 18-0421 ø 1,2 mm x 35 mm
 - ▶ 18-0420 ø 1,8 mm x 35 mm

Kanülen zur Sternalpunktion
Sternum puncture needles
Agujas para la punción del esternón
Aiguilles pour la ponction sternale
Aghi per la puntura dello sterno

1/2



- ABRAMS**
- 39-0500
 - ø 4 mm x 90 mm

Kanüle zur Brustfellpunktion
Pleura puncture needle
Aguja para la punción de la pleura
Aiguille pour la ponction de la plèvre
Ago per la puntura della pleura

1/2



- VERESS**
- 49-4260 ø 2,5 mm x 100 mm
 - ▶ 49-4262 ø 2,5 mm x 120 mm
 - 49-4264 ø 2,5 mm x 140 mm

Peritoneal-Pneu-Kanülen
Pneumoperitoneum needles
Agujas para el neumoperitoneo
Aiguilles pour le pneumopéritoine
Aghi per il pneumo-peritoneo

1/2

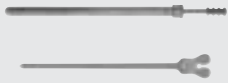

Spritzen
Syringes
Jeringas
Seringues
Siringhe



1/2

- 77-0607 1 ml (40)
- ▶ 77-0608 2 ml (80)

Insulin-Spritzen mit LUER-Konus
Insuline syringes with LUER cone
Jeringas para insulina con cono LUER
Seringues pour insuline avec cône LUER
Siringhe da insulina cono LUER



1/2

- 77-0610
1 ml (100)

Tuberkulin-Spritze mit LUER-Konus
Tuberkuline syringe with LUER cone
Jeringa para tuberculina con cono LUER
Seringue pour tuberculine avec cône LUER
Siringa da tuberculina cono LUER



1/2

- 77-0650 1 ml
- 77-0651 2 ml
- ▶ 77-0652 5 ml
- 77-0653 10 ml
- 77-0654 20 ml
- 77-0655 50 ml

Spritzen mit LUER-Konus
Syringes with LUER cone
Jeringas con cono LUER
Seringues avec cône LUER
Siringhe cono LUER



1/2

- 77-0670 1 ml
- 77-0671 2 ml
- ▶ 77-0672 5 ml
- 77-0673 10 ml
- 77-0674 20 ml
- 77-0675 50 ml

Spritzen mit LUER-LOCK-Ansatz
Syringes with LUER-LOCK connection
Jeringas con conexión LUER-LOCK
Seringues avec verrou LUER-LOCK
Siringhe con attacco LUER-LOCK



1/2

- 77-1607 1 ml (40)
- ▶ 77-1608 2 ml (80)

Zylinder mit LUER-Konus
Barrels with LUER cone
Cilindros con cono LUER
Cylindres avec cône LUER
Cilindri con cono LUER



1/2

- 77-1610
1 ml (100)

Zylinder mit LUER-Konus
Barrel with LUER cone
Cilindros con cono LUER
Cylindre avec cône LUER
Cilindro con cono LUER



1/2

- 77-1650 1 ml
- 77-1651 2 ml
- ▶ 77-1652 5 ml
- 77-1653 10 ml
- 77-1654 20 ml
- 77-1655 50 ml

Zylinder mit LUER-Konus
Barrels with LUER cone
Cilindros con cono LUER
Cylindres avec cône LUER
Cilindri con cono LUER



1/2

- 77-1670 1 ml
- 77-1671 2 ml
- ▶ 77-1672 5 ml
- 77-1673 10 ml
- 77-1674 20 ml
- 77-1675 50 ml

Zylinder mit LUER-LOCK-Ansatz
Barrels with LUER-LOCK connection
Cilindros con conexión LUER-LOCK
Cylindres avec verrou LUER-LOCK
Cilindri con attacco LUER-LOCK

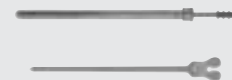

- 77-0680 2 ml
- ▶ 77-0682 5 ml
- 77-0684 10 ml

Spritzen mit LUER-LOCK-Ansatz und drehbaren Ringen

Syringes with LUER-LOCK connection and revolving rings

Jeringas con conexión LUER-LOCK y anillos girables

Seringues avec verrou LUER-LOCK et anneaux revolver

Siringhe con attacco LUER-LOCK e anelli girevoli



- 77-1680 2 ml
- ▶ 77-1682 5 ml
- 77-1684 10 ml

Zylinder mit LUER-LOCK-Ansatz
 Barrels with LUER-LOCK connection
 Cilindros con conexión LUER-LOCK
 Cylindres avec verrou LUER-LOCK
 Cilindri con attacco LUER-LOCK



77-0698

77-0699



- JANET
- 77-0690 50 ml
 - ▶ 77-0691 100 ml
 - 77-0692 150 ml
 - 77-0693 200 ml

Wund- und Blasenspritzen mit 1 konischen (77-0698) und 1 olivenförmigen Ansatz (77-0699)

Wound and bladder syringes with 1 conical tip (77-0698) and 1 bulbous tip (77-0699)

Jeringas para enjuagar la vejiga y heridas con 1 punta cónica (77-0698) y 1 punta forma oliva (77-0699)

Seringues vésicales avec 1 embout conique (77-0698) et 1 embout olivaire (77-0699)

Siringhe per ferite e vescica con 1 punta conica (77-0698) e 1 punta a oliva (77-0699)



- JANET
- 77-1690 50 ml
 - ▶ 77-1691 100 ml
 - 77-1692 150 ml
 - 77-1693 200 ml

Zylinder
 Barrels
 Cilindros
 Cylindres
 Cilindri

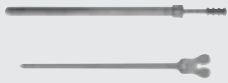

Spritzen
Syringes
Jeringas
Seringues
Siringhe

65-0361
10 ml

- Selbstfüller-Ohrspritze, komplett, bestehend aus:
 65-0362 1 Spritze, mit LUER-LOCK-Ansatz
 65-0363 1 Ventil-System, mit LUER-LOCK-Ansatz
 65-0388 1 Schutzsteller
 65-0366 1 Ohr-Olive
 65-0386 1 Ansatz, konisch
 65-0387 1 Ansatz, olivenförmig
 65-0368 1 Katheter-Ansatz
 65-0369 1 Saugfuß
 65-0370 1 Saug-Schlauch, 45 cm
 65-0371 1 O-Ring für Spritzen-Kolben
 65-0372 1 Kunststofftasche

- Self-filling ear syringe, complete, consisting of:
 65-0362 1 Syringe, with LUER-LOCK connection
 65-0363 1 Valve attachment, with LL connection
 65-0388 1 Protecting disc
 65-0366 1 Ear olive
 65-0386 1 Conical tip
 65-0387 1 Bulbous tip
 65-0368 1 Catheter tip
 65-0369 1 Suction piece
 65-0370 1 Rubber tube, 45 cm
 65-0371 1 O-ring for piston
 65-0372 1 Plastic bag

- Jeringa auricular, auto-rellena, completa, compuesta de:
 65-0362 1 Jeringa con cono LUER-LOCK
 65-0363 1 Valvula de conexión con cono LUER-LOCK
 65-0388 1 Disco protector
 65-0366 1 Oliva para los oídos
 65-0386 1 Punta cónica
 65-0387 1 Punta forma oliva
 65-0368 1 Sonda
 65-0369 1 Pieza para aspiración
 65-0370 1 Tubo de goma para aspiración, 45 cm
 65-0371 1 Anillo-O para pistón
 65-0372 1 Bolsa de plástico

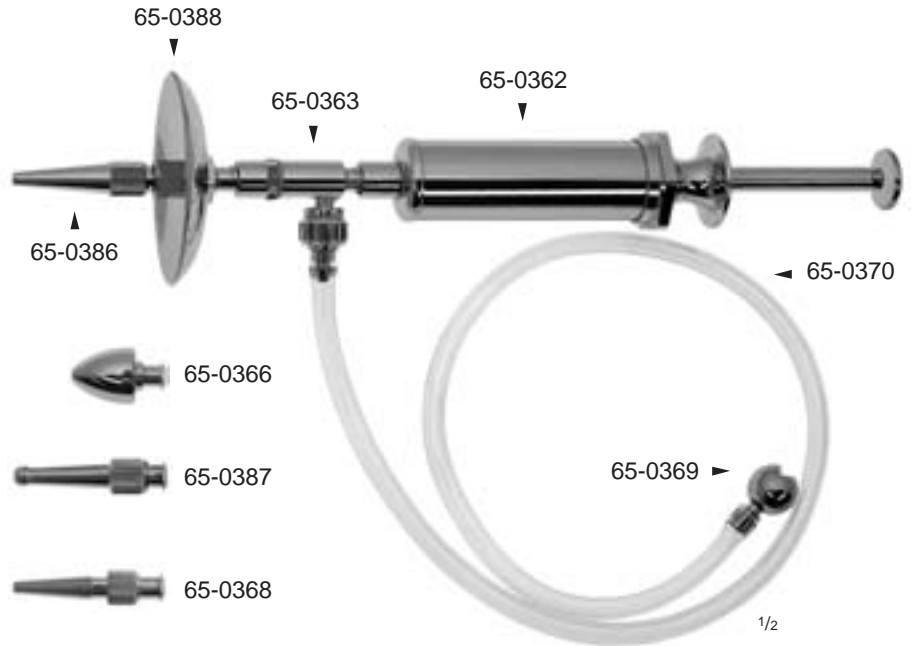

- Seringue auriculaire à remplissage automatique, complète, composée de:
 65-0362 1 Seringue cône LUER-LOCK
 65-0363 1 Raccord LUER-LOCK
 65-0388 1 Disque protecteur
 65-0366 1 Embout olivaire
 65-0386 1 Embout conique
 65-0387 1 Embout à fistule
 65-0368 1 Embout pour catheter
 65-0369 1 Embout aspiration
 65-0370 1 tube, 45 cm
 65-0371 1 Joint pour piston
 65-0372 1 Etui en plastique

- Siringa per orecchio ad autorimpimento, completa, composta da:
 65-0362 1 Siringa cono LUER-LOCK
 65-0363 1 Valvola di connessione
 65-0388 1 Disco protettore
 65-0366 1 Oliva
 65-0386 1 Punta conica
 65-0387 1 Punta a oliva
 65-0368 1 Sonda
 65-0369 1 Aspiratore
 65-0370 1 Tubo in gomma da 45 cm
 65-0371 1 Anello O per pistone
 65-0372 1 Borsa in plastica

▶ 65-0379
50 ml

- Ohrspritze, komplett, bestehend aus:
 65-0389 1 Spritze, mit LUER-LOCK-Ansatz
 65-0386 1 Ansatz, konisch
 65-0387 1 Ansatz, olivenförmig
 65-0388 1 Schutzsteller

- Ear syringe, complete, consisting of:
 65-0389 1 Syringe, with LUER-LOCK connection
 65-0386 1 Conical tip
 65-0387 1 Bulbous tip
 65-0388 1 Protecting disc

- Jeringa auricular, completa, compuesta de:
 65-0389 1 Jeringa con cono LUER-LOCK
 65-0386 1 Punta cónica
 65-0387 1 Punta forma oliva
 65-0388 1 Disco protector

- Seringue auriculaire, complète, composée de:
 65-0389 1 Seringue avec cône LUER-LOCK
 65-0386 1 Embout conique
 65-0387 1 Embout à fistule
 65-0388 1 Disque protecteur

- Siringa per orecchio completa, composta da:
 65-0389 1 Siringa con attacco LUER-LOCK
 65-0386 1 Punta conica
 65-0387 1 Punta a oliva
 65-0388 1 Disco protettore



- 65-0380
dito, jedoch 75 ml
ditto, but 75 ml
idem, 75 ml
idem, 75 ml

- 65-0382
dito, jedoch 100 ml
ditto, but 100 ml
idem, 100 ml
idem, 100 ml

- 65-0384
dito, jedoch 150 ml
ditto, but 150 ml
idem, 150 ml
idem, 150 ml

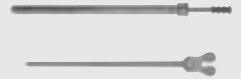

77-0877

Zwischenstück,
LUER-LOCK weiblich,
Schlaucholive für
3/16" - Schlauch

Connecting piece,
LUER-LOCK female,
olive for 3/16" tubings

Pieza de conexión,
LUER-LOCK hembra,
oliva para tubos de 3/16"

Raccord, LUER-LOCK femelle,
olive au tuyau pour tubes
de 3/16"

Raccordo, LUER-LOCK
femmina, oliva di collegamento
per tubo 3/16"



77-0878

Zwischenstück,
LUER-LOCK männlich,
Schlaucholive für
6 mm Schlauch

Connecting piece,
LUER-LOCK male,
olive for 6 mm tubings

Pieza de conexión,
LUER-LOCK masculino,
oliva para tubos de 6 mm

Raccord, LUER-LOCK
mâle, au tuyau pour tubes
de 6 mm

Raccordo, LUER-LOCK
maschio, oliva di collegamento
per tubo da 6 mm



65-0366

Zwischenstück,
LUER-LOCK weiblich,
Harnröhren-Olive

Connecting piece,
LUER-LOCK female,
urethral olive

Pieza de conexión,
LUER-LOCK hembra,
oliva uretral

Raccord, LUER-LOCK
femelle, olive urétrale

Raccordo, LUER-LOCK
femmina, oliva uretrale



65-0368 \varnothing 2,5 - 6,5 mm

Zwischenstück,
LUER-LOCK weiblich, konischer
Schlauch- und Katheteransatz

Connecting piece,
LUER-LOCK female, conical tubing
and catheter fitting

Pieza de conexión,
LUER-LOCK hembra, cónica
cono para tubo y catéter

Raccord, LUER-LOCK femelle,
pour tubes cône et cathéters

Raccordo, LUER-LOCK femmina,
cono per tubo e catetere



77-0883

Durchflußhahn,
LUER-LOCK weiblich,
LUER-LOCK männlich

Stopcock,
LUER-LOCK female,
LUER-LOCK male

Llave,
LUER-LOCK hembra,
LUER-LOCK masculino

Robinet,
LUER-LOCK femelle,
LUER-LOCK mâle

Rubinetto,
LUER-LOCK femmina,
LUER-LOCK maschio



77-0884

Dreiweghahn,
2 x LUER-LOCK weiblich,
1 x LUER-LOCK männlich

Three-way-stopcock,
2 x LUER-LOCK female,
1 x LUER-LOCK male

Llave de 3 vías,
2 x LUER-LOCK hembra,
1 x LUER-LOCK masculino

Robinet à trois voies,
2 x LUER-LOCK femelle,
1 x LUER-LOCK mâle

Rubinetto a tre vie,
2 x LUER-LOCK femmina,
1 x LUER-LOCK maschio

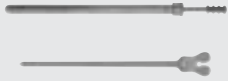

Führungsnadeln
 Guide Needles
 Aguja de guía
 Aiguilles guides
 Aghi per introduzione



REDON

- 18-0520 ø 2,5 mm
- 18-0521 ø 3,5 mm
- ▶ 18-0522 ø 4,0 mm
- 18-0523 ø 4,5 mm
- 18-0524 ø 5,5 mm
- 18-0525 ø 6,0 mm
- 19,5 cm, 7^{3/4}"

mit Lanzettenspitze
 with lancet tip
 con punta lanceolar
 avec pointe lancéolaire
 con lancetta



REDON

- 18-0530 ø 2,5 mm
- 18-0531 ø 3,5 mm
- ▶ 18-0532 ø 4,0 mm
- 18-0533 ø 4,5 mm
- 18-0534 ø 5,5 mm
- 18-0535 ø 6,0 mm
- 19,5 cm, 7^{3/4}"

mit Messerschneide
 with knife-edge
 con filo de cuchillo
 avec pointe effilée
 con bordo tagliente



REDON

- 18-0540 ø 2,5 mm
- 18-0541 ø 3,5 mm
- ▶ 18-0542 ø 4,0 mm
- 18-0543 ø 4,5 mm
- 18-0544 ø 5,5 mm
- 18-0545 ø 6,0 mm
- 16 cm, 6^{1/4}"

mit Messerschneide
 with knife-edge
 con filo de cuchillo
 avec pointe effilée
 con bordo tagliente

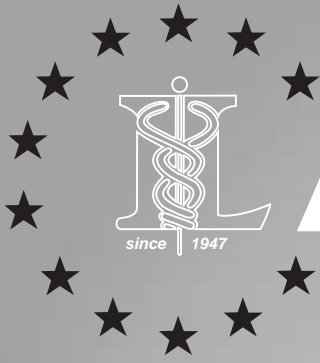

LAWNTON

Medizintechnik

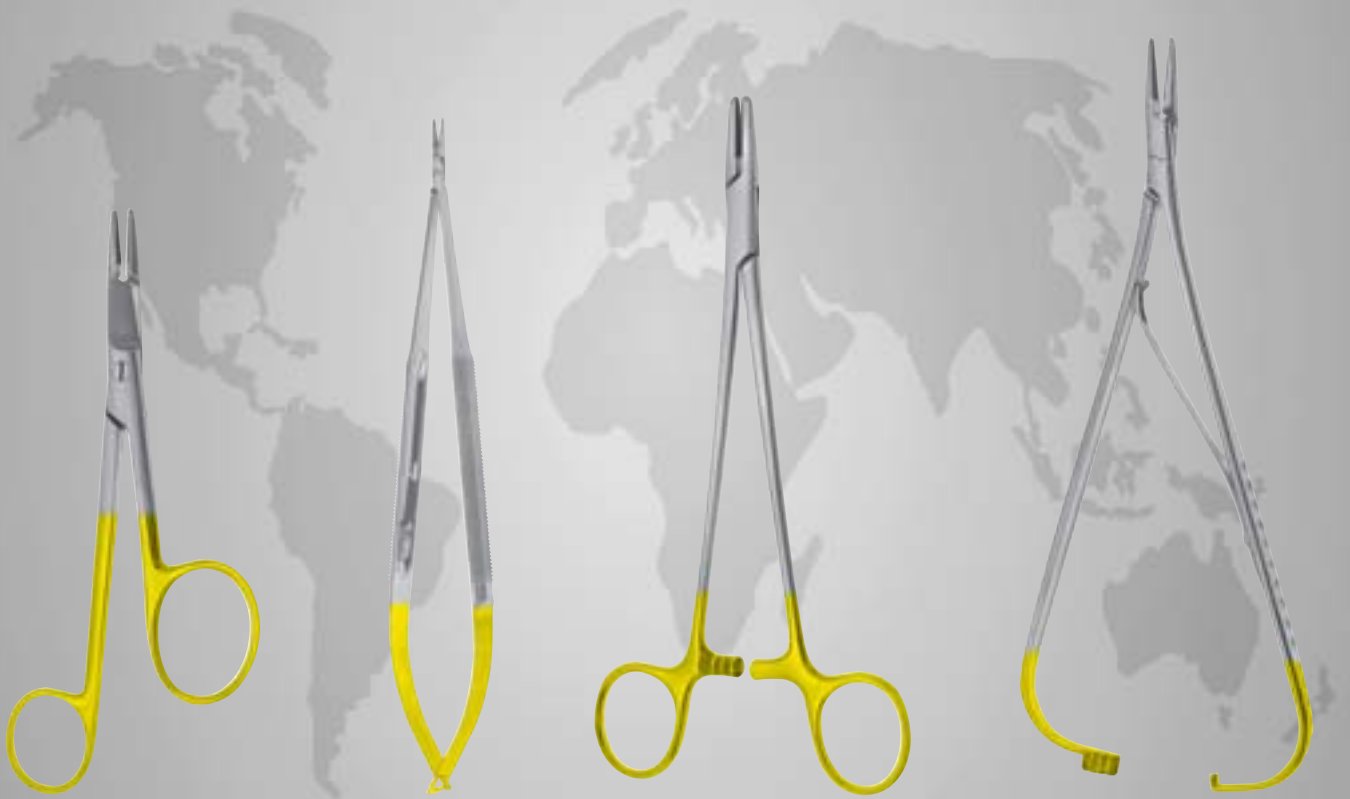

TITE GRIP® Nadelhalter
TITE GRIP® Needle Holders
TITE GRIP® Porta-agujas
TITE GRIP® Porte-aiguilles
TITE GRIP® Portaghi

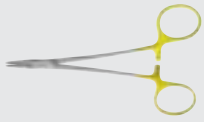

TITE GRIP® Nadelhalter mit Hartmetalleinlagen
TITE GRIP® Needle Holders with tungsten carbide inserts
TITE GRIP® Porta-agujas con bocas de carburo tungsteno
TITE GRIP® Porte-aiguilles avec mors en tungstène
TITE GRIP® Portaghi con morsi in carburo di tungsteno

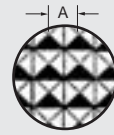

Riefung
Serration
Estradadura
Structure
Struttura



- Hartmetalleinlagen mit präzis gearbeitetem Pyramidenprofil garantieren einen sicheren Halt der Nadel.
Gebrochene Kanten verhindern ein Verfangen des Nahtmaterials.
Leichtgängige Sperre ermöglicht eine sichere Arbeitsweise.
Vergoldete Griffe als leichte Kennzeichnung.
- Tungsten carbide inserts with precisely worked out structure guarantee to grip the needle securely.
Bevelled edges to prevent catching of suture material.
Soft working catch provides safe handling.
Gold-plated handles for easy identification.
- Capas intermedias de carburo tungsteno con perfil amoldado piramidal que garantiza un sujeto seguro de la aguja.
Bordes quebrados evitan que se enredare el material de sutura.
El cierre suave facilita un manejo seguro.
Identificación: Mangos dorados.
- Les inserts en carbure de tungstène avec structure pyramidale usinée avec précision garantissent un maintien sûr de l'aiguille.
Les bords carrés empêchent le matériel de suture de s'embrouiller.
Un blocage souple permet de travailler de manière sûre.
Les branches plaquées or, un signe distinctif éloquent
- Inserti in carburo di tungsteno che garantiscono una perfetta tenuta dell'ago
I bordi squadrati evitano che si impiglino i fili di sutura
Il bloccaggio leggero e preciso facilita un uso sicuro
L'impugnatura dorata permette una facile identificazione

TITE GRIP® Nadelhalter mit Hartmetalleinlagen
 TITE GRIP® Needle Holders with tungsten carbide inserts
 TITE GRIP® Porta-agujas con bocas de carburo tungsteno
 TITE GRIP® Porte-aiguilles avec mors en tungstène
 TITE GRIP® Portaghi con morsi in carburo di tungsteno

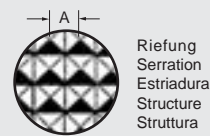

Je nach Anwendungsgebiet stehen für TITE GRIP® Nadelhalter unterschiedliche Hartmetalleinlagen zur Verfügung:

According to the field of application, there are various types of tungsten carbide inserts for TITE GRIP® needle holders:

Según campo de aplicación, disponemos de TITE GRIP® porta-agujas con varias capas intermedias:

Selon le domaine d'application, différents inserts en carbure de tungstène sont disponibles pour les porte-aiguilles TITE GRIP®:

A seconda delle necessità disponiamo di TITE GRIP® portaghi con varie capacità intermedie:

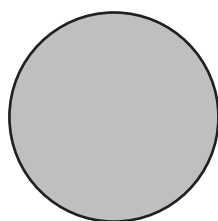

10x



1/1

GLATT • SMOOTH • LISO • LISSES • LISCIE:

Zum Halten von extrem feinem Nahtmaterial.

For holding the smallest suture sizes.

Para sujetar suturas muy finas.

Pour maintenir un matériel de suture extrêmement fin.

Per lavorare con suture sottilissime

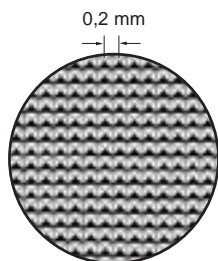

10x



0,2

RIEFUNG 0,2 MM • SERRATION 0.2 MM • ESTRIADURA 0,2 MM
 STRUCTURE 0,2 MM • STRUTTURA 0,2 MM:

Zum Halten von feinem Nahtmaterial der Stärken 7/0 bis 10/0.

For holding the delicate suture sizes from 7/0 to 10/0.

Para sujetar suturas finas de 7/0 hasta 10/0 de gruesas.

Pour maintenir un matériel de suture fin de 7/0 à 10/0.

Per lavorare con suture sottili da 7/0 a 10/0

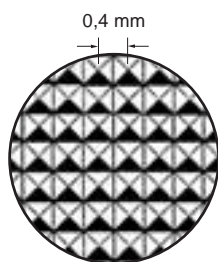

10x



0,4

RIEFUNG 0,4 MM • SERRATION 0.4 MM • ESTRIADURA 0,4 MM
 STRUCTURE 0,4 MM • STRUTTURA 0,4 MM:

Zum Halten von Nahtmaterial der Stärken 4/0 bis 6/0.

For holding the suture sizes from 4/0 to 6/0.

Para sujetar sutura de 4/0 hasta 6/0 de gruesas.

Pour maintenir un matériel de suture de 4/0 à 6/0 épaisseur.

Per lavorare con suture da 4/0 a 6/0

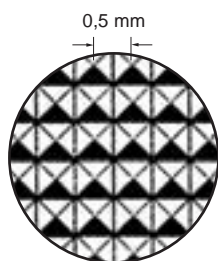

10x



0,5

RIEFUNG 0,5 MM • SERRATION 0.5 MM • ESTRIADURA 0,5 MM
 STRUCTURE 0,5 MM • STRUTTURA 0,5 MM:

Zum Halten von Nahtmaterial der Stärke 3/0 und kräftiger.

For holding the suture size 3/0 and larger.

Para sujetar sutura de 3/0 y más gruesas.

Pour maintenir un matériel de suture de 3/0 et plus.

Per lavorare con suture da 3/0 in poi

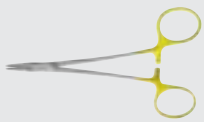

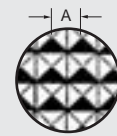

TITE GRIP® Mikro-Nadelhalter mit Hartmetalleinlagen
TITE GRIP® Micro Needle Holders with tungsten carbide inserts
TITE GRIP® Micro-Porta-agujas con bocas de carburo tungsteno
TITE GRIP® Micro-Porte-aiguilles avec mors en tungstène
TITE GRIP® Micro-Portaghi con morsi in carburo di tungsteno





Riefung
Serration
Estradatura
Structure
Struttura



 1/1
glatt • smooth
liso • lisses
liscie
▶ 08-0043
14 cm, 5 1/2"
 1/1
glatt • smooth
liso • lisses
liscie
▶ 08-0044
14 cm, 5 1/2"



CASTROVIEJO
08-0043
- 08-0044



 1/1
0,2 mm (A)
▶ 08-0096
14 cm, 5 1/2"
 1/1
0,2 mm (A)
▶ 08-0097
14 cm, 5 1/2"



CASTROVIEJO
08-0096
- 08-0097



 1/1
glatt • smooth
liso • lisses
liscie
▶ 25-0294
18 cm, 7"
 1/1
glatt • smooth
liso • lisses
liscie
▶ 25-0297
21 cm, 8 1/4"

JACOBSON
25-0294
- 25-0297



 1/1
0,2 mm (A)
▶ 25-0296
18 cm, 7"
 1/1
0,2 mm (A)
▶ 25-0299
21 cm, 8 1/4"

JACOBSON
25-0296
- 25-0299

TITE GRIP® Mikro-Nadelhalter mit Hartmetalleinlagen
 TITE GRIP® Micro Needle Holders with tungsten carbide inserts
 TITE GRIP® Micro-Porta-agujas con bocas de carburo tungsteno
 TITE GRIP® Micro-Porte-aiguilles avec mors en tungstène
 TITE GRIP® Micro-Portaghi con morsi in carburo di tungsteno

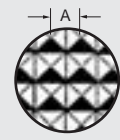

Riefung
 Serration
 Estriadura
 Structure
 Struttura

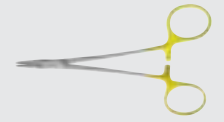

25-0275
 - 25-0278

 0,2 mm (A) 25-0275 15 cm, 6"	 0,2 mm (A) ▶ 25-0276 18 cm, 7"
 0,2 mm (A) 25-0277 21 cm, 8 1/4"	 0,2 mm (A) 25-0278 23 cm, 9"



CASTROVIEJO
 08-0049
 13 cm, 5 1/8"

glatt
 smooth
 liso
 lisses
 liscie



DIETRICH
 08-0001
 - 08-0005

 0,2 mm (A) ▶ 08-0001 16 cm, 6 1/4"	 0,2 mm (A) 08-0002 18 cm, 7"	 0,2 mm (A) 08-0003 20 cm, 8"	 0,2 mm (A) 08-0004 23 cm, 9"	 0,2 mm (A) 08-0005 26 cm, 10 1/4"
--	--	--	--	---



TITE GRIP® Nadelhalter mit Hartmetalleinlagen
 TITE GRIP® Needle Holders with tungsten carbide inserts
 TITE GRIP® Porta-agujas con bocas de carburo tungsteno
 TITE GRIP® Porte-aiguilles avec mors en tungstène
 TITE GRIP® Portaghi con morsi in carburo di tungsteno

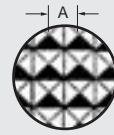

Riefung
 Serration
 Estradatura
 Structure
 Struttura



0,2 mm (A)
 08-0080
 13 cm, 5 1/8"



0,2 mm (A)
 08-0081
 15 cm, 6"



0,4 mm (A)
 08-0057
 14,5 cm 5 3/4"



0,4 mm (A)
 ▶ 08-0058
 17,5 cm 7"



0,5 mm (A)
 08-0221
 16 cm 6 1/4"



0,5 mm (A)
 ▶ 08-0223
 18,5 cm 7 1/4"



0,2 mm (A)
 ▶ 08-0084
 18,5 cm 7 1/4"



0,2 mm (A)
 08-0085
 20 cm, 8"



0,4 mm (A)
 08-0051
 20 cm, 8"



0,4 mm (A)
 08-0059
 23 cm, 9"



0,5 mm (A)
 08-0225
 20,5 cm 8"



0,5 mm (A)
 08-0227
 23 cm, 9"



0,2 mm (A)
 08-0087
 23 cm, 9"



RYDER-VASCULAR
 08-0080
 - 08-0087



RYDER
 08-0051
 - 08-0059



FRENCH EYE
 08-0221
 - 08-0227

TITE GRIP® Nadelhalter für Linkshänder mit Hartmetalleinlagen
 TITE GRIP® Needle Holders for Left-Hander with tungsten carbide inserts
 TITE GRIP® Porta-agujas para zurdos con bocas de carburo tungsteno
 TITE GRIP® Porte-aiguilles pour gauchers avec mors en tungstène
 TITE GRIP® Portaghi per mancini con morsi in carburo di tungsteno

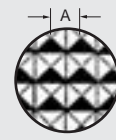

Riefung
 Serration
 Estriadura
 Structure
 Struttura



HALSEY
 08-2011
 13 cm, 5 1/8"



CRILE-WOOD
 08-2065
 15 cm, 6"



CRILE-WOOD
 08-2068
 18 cm, 7"



MAYO-HEGAR
 08-2181
 16 cm, 6 1/4"



MAYO-HEGAR
 08-2183
 18,5 cm, 7 1/4"



TITE GRIP® Nadelhalter mit Hartmetalleinlagen
 TITE GRIP® Needle Holders with tungsten carbide inserts
 TITE GRIP® Porta-agujas con bocas de carburo tungsteno
 TITE GRIP® Porte-aiguilles avec mors en tungstène
 TITE GRIP® Portaghi con morsi in carburo di tungsteno

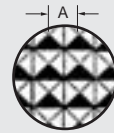

Riefung
 Serration
 Estradadura
 Structure
 Strutturata

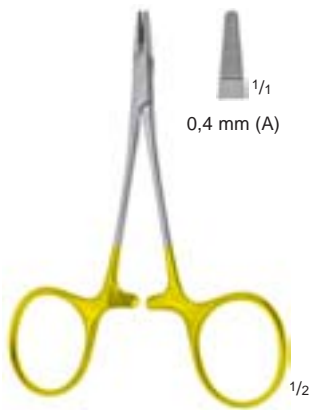

1/1
 0,4 mm (A)

CONVERSE
 08-0027
 10,5 cm, 4 1/8"

mit großen Ringen
 with big sized rings
 con anillos grandes
 à gros anneaux
 con anelli grandi

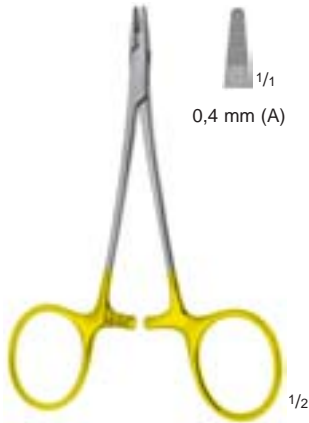

1/1
 0,4 mm (A)

DERF
 08-0015
 11 cm, 4 3/8"

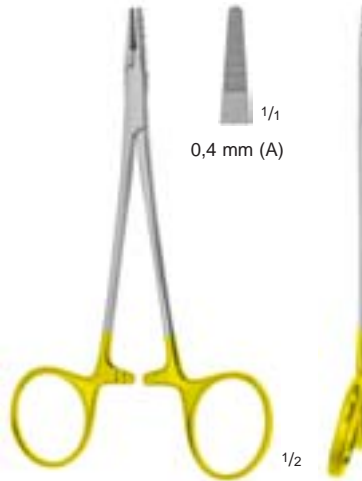

1/1
 0,4 mm (A)

NEIVERT
 08-0025
 12,5 cm, 5"

mit aufgebogenem Daumenring
 with offset ring
 con anillo acodado
 à anneau décalé
 con anelli sfalsati

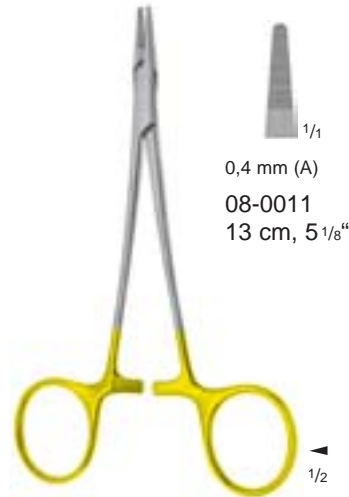

1/1
 0,4 mm (A)

HALSEY
 08-0011
 - 08-0012

► 08-0012
 13 cm, 5 1/8"

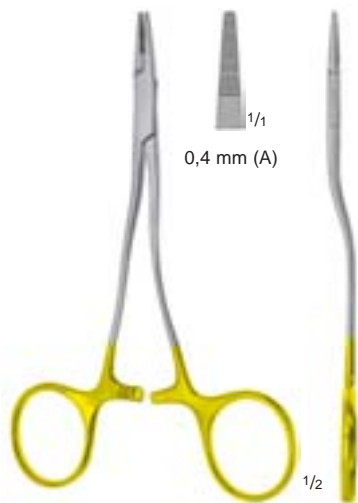
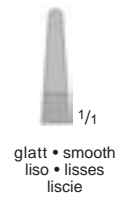

1/1
 0,4 mm (A)

KILNER
 08-0022
 13 cm, 5 1/8"



1/1
 glatt
 smooth
 liso
 lisses
 liscie

WEBSTER
 08-0013
 13 cm, 5 1/8"

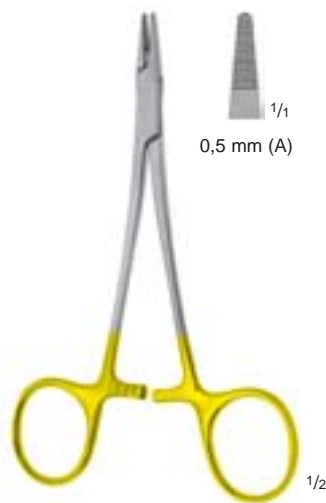

1/1
 0,5 mm (A)

BAUMGARTNER
 08-0017
 13 cm, 5 1/8"



1/1
 0,5 mm (A)



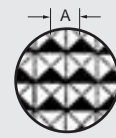

HEGAR-BAUMGARTNER
 08-0021
 14 cm, 5 1/2"

TITE GRIP® Nadelhalter mit Hartmetalleinlagen
 TITE GRIP® Needle Holders with tungsten carbide inserts
 TITE GRIP® Porta-agujas con bocas de carburo tungsteno
 TITE GRIP® Porte-aiguilles avec mors en tungstène
 TITE GRIP® Portaghi con morsi in carburo di tungsteno

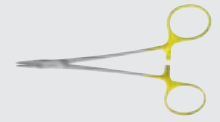







Riefung
 Serration
 Estriadura
 Structure
 Struttura



				
1/1	1/1	1/1	1/1	1/1
glatt • smooth liso • lisses liscie	0,4 mm (A)	0,4 mm (A)	0,4 mm (A)	0,4 mm (A)
08-0066 15 cm, 6"	08-0065 15 cm, 6"	▶ 08-0068 18 cm, 7"	08-0072 20,5 cm, 8"	08-0076 23 cm, 9"

CRILE-WOOD
 08-0065
 - 08-0076

					
1/1	1/1	1/1	1/1	1/1	1/1
0,4 mm (A)	0,4 mm (A)	0,4 mm (A)	0,4 mm (A)	0,5 mm (A)	0,5 mm (A)
08-0054 15 cm, 6"	▶ 08-0100 18 cm, 7"	08-0056 20,5 cm, 8"	08-0101 23 cm, 9"	08-0102 26,5 cm, 10 1/2"	08-0103 30,5 cm, 12"

DE-BAKEY
 08-0054
 - 08-0103



TITE GRIP® Nadelhalter mit Hartmetalleinlagen
 TITE GRIP® Needle Holders with tungsten carbide inserts
 TITE GRIP® Porta-agujas con bocas de carburo tungsteno
 TITE GRIP® Porte-aiguilles avec mors en tungstène
 TITE GRIP® Portaghi con morsi in carburo di tungsteno

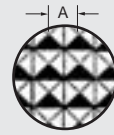

Riefung
 Serration
 Estradadura
 Structure
 Struttura



glatt • smooth
 liso • lisses
 lisce

1/1

glatt • smooth
 liso • lisses
 lisce

1/1

glatt • smooth
 liso • lisses
 lisce

1/1

08-0073 15 cm, 6"
 ▶ 08-0074 17,5 cm, 7"
 08-0077 20 cm, 8"

EUFRATE PASQUE
 08-0073
 - 08-0077



0,2 mm (A)

1/1

0,2 mm (A)

1/1

0,2 mm (A)

1/1

08-0158 15 cm, 6"
 ▶ 08-0159 17,5 cm, 7"
 08-0160 20 cm, 8"

EUFRATE PASQUE
 08-0158
 - 08-0160



1/1

0,4 mm (A)

SAROT
 08-0247
 18 cm, 7"



1/1

0,4 mm (A)

CARROLL
 08-0173
 16 cm, 6 1/4"



1/1

0,5 mm (A)

NEW ORLEANS
 08-0175
 17,5 cm, 7"



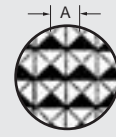

TITE GRIP® Nadelhalter mit Hartmetalleinlagen
 TITE GRIP® Needle Holders with tungsten carbide inserts
 TITE GRIP® Porta-agujas con bocas de carburo tungsteno
 TITE GRIP® Porte-aiguilles avec mors en tungstène
 TITE GRIP® Portaghi con morsi in carburo di tungsteno

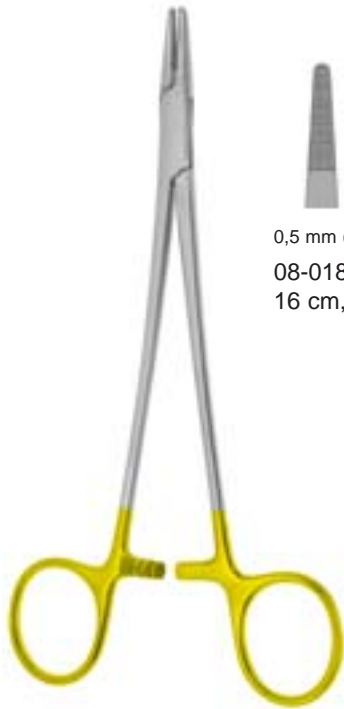

Riefung
 Serration
 Estriadura
 Structure
 Struttura



MAYO-HEGAR
 08-0181
 - 08-0197







				
0,5 mm (A) 08-0181 16 cm, 6 1/4"	0,5 mm (A) ▶ 08-0183 18,5 cm, 7 1/4"	0,5 mm (A) 08-0185 20,5 cm, 8"	0,5 mm (A) 08-0195 24 cm, 9 1/2"	0,5 mm (A) 08-0197 27 cm, 10 3/4"

leichte Modelle • light patterns • modelos ligeros • modèles légers • modelli leggeri

1/2



MAYO-HEGAR
 08-0179
 - 08-0198

						
0,5 mm (A) 08-0179 16 cm, 6 1/4"	0,5 mm (A) ▶ 08-0186 18,5 cm, 7 1/4"	0,5 mm (A) 08-0187 20,5 cm, 8"	0,5 mm (A) 08-0188 24 cm, 9 1/2"	0,5 mm (A) 08-0196 27 cm, 10 3/4"	0,5 mm (A) 08-0189 30,5 cm, 12"	0,5 mm (A) 08-0198 37 cm, 14 1/2"

kräftige Modelle • heavy patterns • modelos robustos • modèles forts • modelli robusti

1/2



TITE GRIP® Nadelhalter mit Hartmetalleinlagen
 TITE GRIP® Needle Holders with tungsten carbide inserts
 TITE GRIP® Porta-agujas con bocas de carburo tungsteno
 TITE GRIP® Porte-aiguilles avec mors en tungstène
 TITE GRIP® Portaghi con morsi in carburo di tungsteno

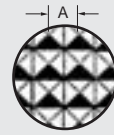

Riefung
 Serration
 Estradatura
 Structure
 Struttura

0,5 mm (A) ^{1/1}
 ▶ 08-0287 20,5 cm, 8"
 0,5 mm (A) ^{1/1}
 08-0288 26,5 cm, 10 1/2"

HEANEY
 08-0287
 - 08-0288

0,5 mm (A) ^{1/1}
 ▶ 08-0255 20,5 cm, 8"
 0,5 mm (A) ^{1/1}
 08-0257 26,5 cm, 10 1/2"

FINOCHIETTO
 08-0255
 - 08-0257

0,5 mm (A) ^{1/1}
 ▶ 08-0230 20 cm, 8"
 0,5 mm (A) ^{1/1}
 08-0231 24 cm, 9 1/2"
 0,5 mm (A) ^{1/1}
 08-0232 26 cm, 10 1/4"

BOZEMANN (WERTHEIM)
 08-0230
 - 08-0232

TITE GRIP® Nadelhalter mit Hartmetalleinlagen
 TITE GRIP® Needle Holders with tungsten carbide inserts
 TITE GRIP® Porta-agujas con bocas de carburo tungsteno
 TITE GRIP® Porte-aiguilles avec mors en tungstène
 TITE GRIP® Portaghi con morsi in carburo di tungsteno

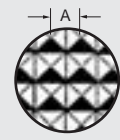

Riefung
 Serration
 Estriadura
 Structure
 Struttura



STRATTE
 08-0263
 22,5 cm, 9"

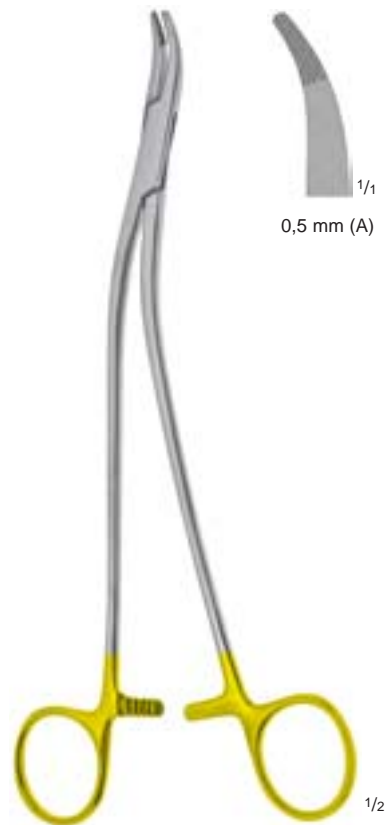

STRATTE
 08-0261
 22,5 cm, 9"



MASSON
 08-0241
 26,5 cm, 10¹/₂"



WANGENSTEEN
 08-0245
 27 cm, 10³/₄"



TITE GRIP® Nadelhalter mit Schere
 TITE GRIP® Needle Holders with scissors
 TITE GRIP® Porta-agujas con tijera
 TITE GRIP® Porte-aiguilles avec ciseaux
 TITE GRIP® Portaghi con forbici

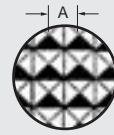

Riefung
 Serration
 Estradadura
 Structure
 Strutturata



BABY-OLSEN-HEGAR
 08-0111
 12 cm, 4 3/4"



OLSEN-HEGAR
 08-0113
 13,5 cm, 5 1/4"



OLSEN-HEGAR
 08-0115
 17 cm, 6 3/4"



OLSEN-HEGAR
 08-0117
 18,5 cm, 7 1/4"



BABY-GILLIES
 08-0132
 15 cm, 6"



GILLIES
 08-0118
 15,5 cm, 6"



GILLIES
 08-0119
 15,5 cm, 6"





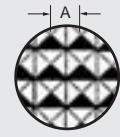

GILLIES
 08-0144
 15,5 cm, 6"

TITE GRIP® Nadelhalter mit Hartmetalleinlagen
 TITE GRIP® Needle Holders with tungsten carbide inserts
 TITE GRIP® Porta-agujas con bocas de carburo tungsteno
 TITE GRIP® Porte-aiguilles avec mors en tungstène
 TITE GRIP® Portaghi con morsi in carburo di tungsteno



Riefung
 Serration
 Estriadura
 Structure
 Struttura



			
0,5 mm (A)	0,5 mm (A)	0,5 mm (A)	0,5 mm (A)
08-0127	▶ 08-0128	08-0129	08-0124
14 cm, 5 1/2"	17,5 cm, 7"	20 cm, 8"	24 cm, 9 1/2"

MATHIEU
 08-0124
 - 08-0129



 0,4 mm (A)
 elastisches Modell
 elastic pattern
 modelo elástico
 modèle souple
 modello elastico

LAWTON-MATHIEU
 08-0190
 16 cm, 6 1/4"



 0,4 mm (A)
 elastisches Modell
 elastic pattern
 modelo elástico
 modèle souple
 modello elastico

LICHTENBERG
 08-0136
 20 cm, 8"



 0,5 mm (A)

ZWEIFEL
 08-0145
 20 cm, 8"





 0,5 mm (A)

LAWTON
 08-0147
 20 cm, 8"

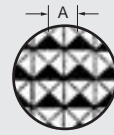

TITE GRIP® Nadelhalter mit Hartmetalleinlagen
 TITE GRIP® Needle Holders with tungsten carbide inserts
 TITE GRIP® Porta-agujas con bocas de carburo tungsteno
 TITE GRIP® Porte-aiguilles avec mors en tungstène
 TITE GRIP® Portaghi con morsi in carburo di tungsteno



Riefung
 Serration
 Estradatura
 Structure
 Struttura

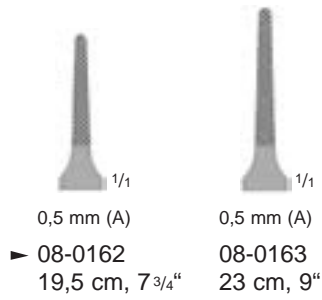

LANGENBECK-RYDER
 08-0162
 - 08-0163

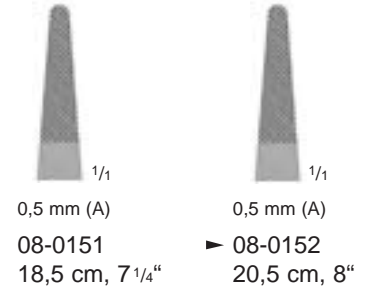

LANGENBECK
 08-0151
 - 08-0152

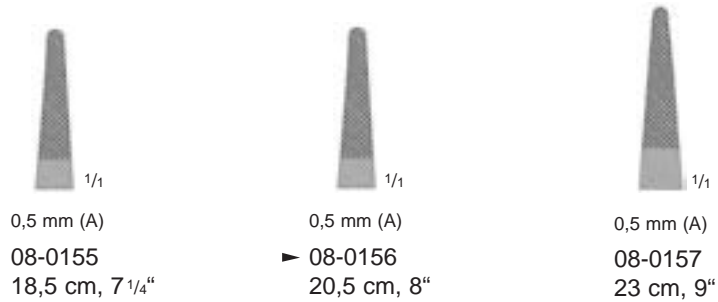

TOENNIS
 08-0155
 - 08-0157

elastische Modelle • elastic patterns • modelos elásticos • modèles souples • modelli elastico



LAWNTON
Medizintechnik

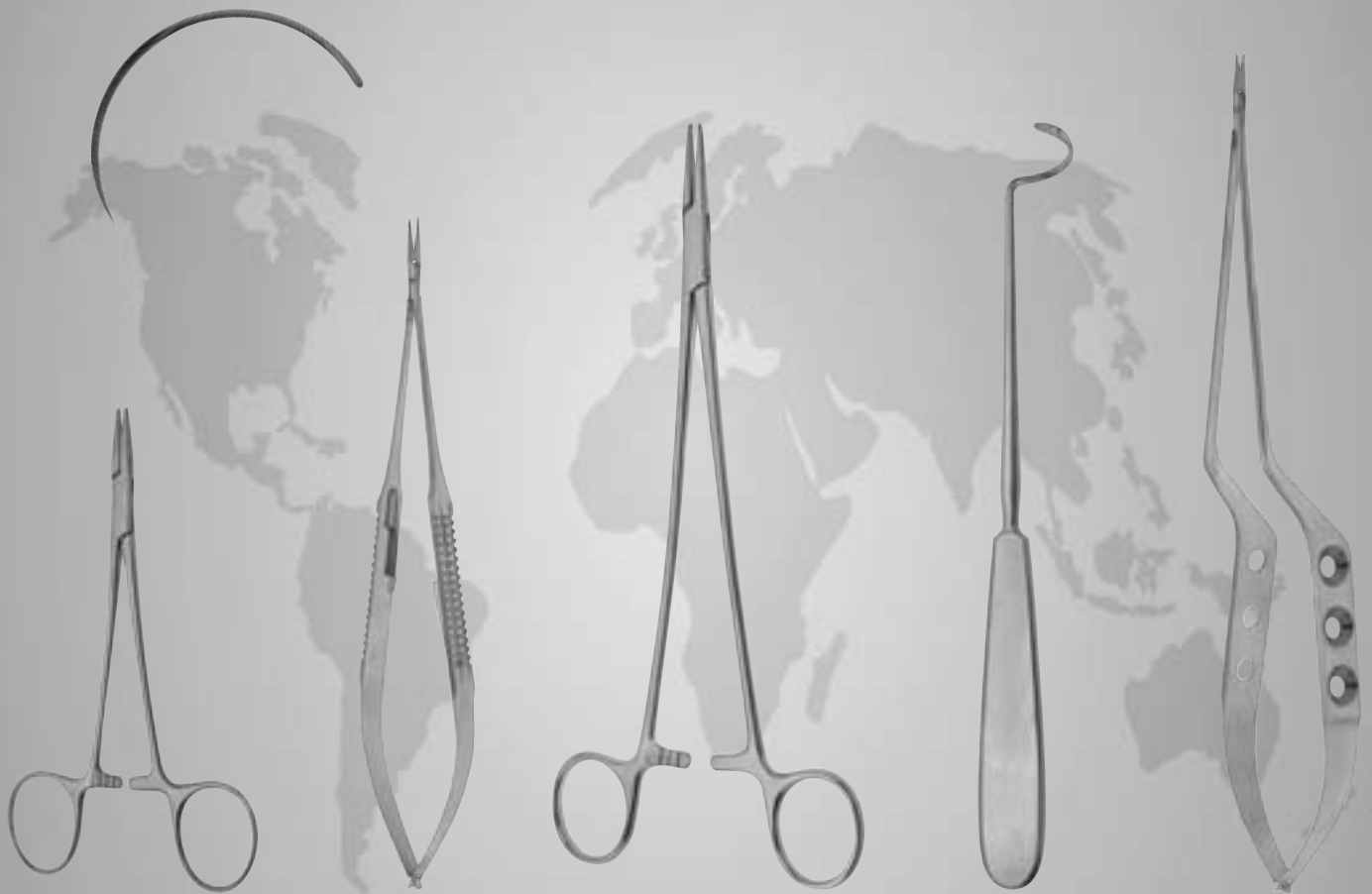

Nahtinstrumente
Suture Instruments
Instrumentos para sutura
Instruments à suture
Strumenti per sutura

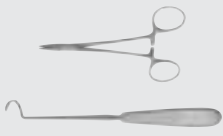

Ligaturscheren, Fadenscheren
 Ligature Scissors
 Tijeras para ligaduras
 Ciseaux à ligatures
 Forbici per legature

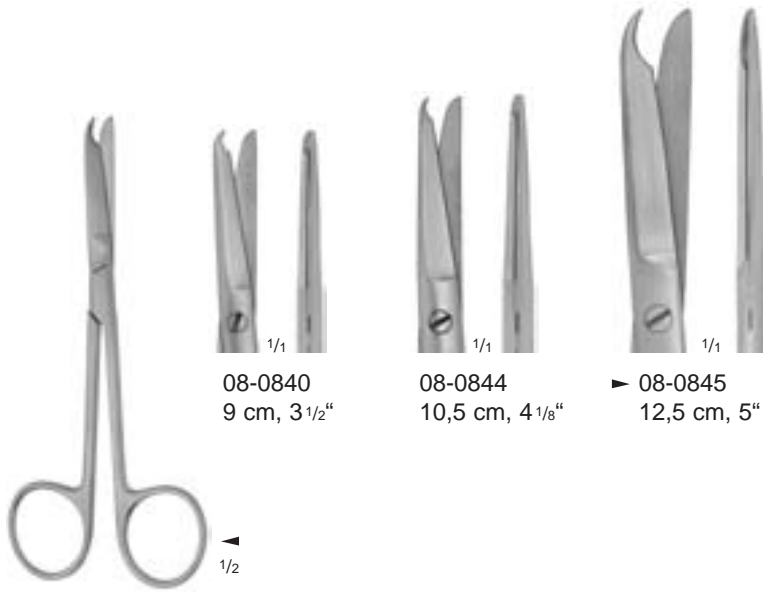

08-0840
9 cm, 3 1/2"

08-0844
10,5 cm, 4 1/8"

▶ 08-0845
12,5 cm, 5"

SPENCER
08-0840
- 08-0845



08-0847
9 cm, 3 1/2"

▶ 08-0846
12,5 cm, 5"

SPENCER (NORTHBENT)
08-0846
- 08-0847

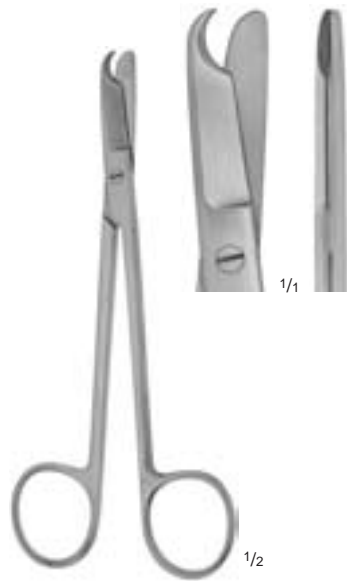

LITTAUER
08-0875
14 cm, 5 1/2"



O'BRIEN
08-0848
9,5 cm, 3 3/4"



EISELSBERG
08-0850
11,5 cm, 4 1/2"

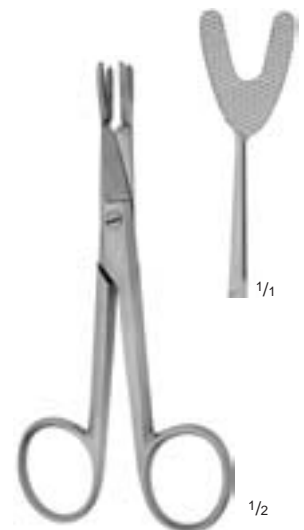

SCHOEMAKER-LOTH
08-0851
12,5 cm, 5"

Ligaturscheren mit Hartmetallschneiden
 Ligature Scissors with tungsten carbide edges
 Tijeras para ligaduras con filos de carburo tungsteno
 Ciseaux à ligatures avec des lames en tungstène
 Forbici per legature con lame in carburo di tungsteno

Nähmaterial
 Suture Material
 Material para sutura
 Matériel à suture
 Suture

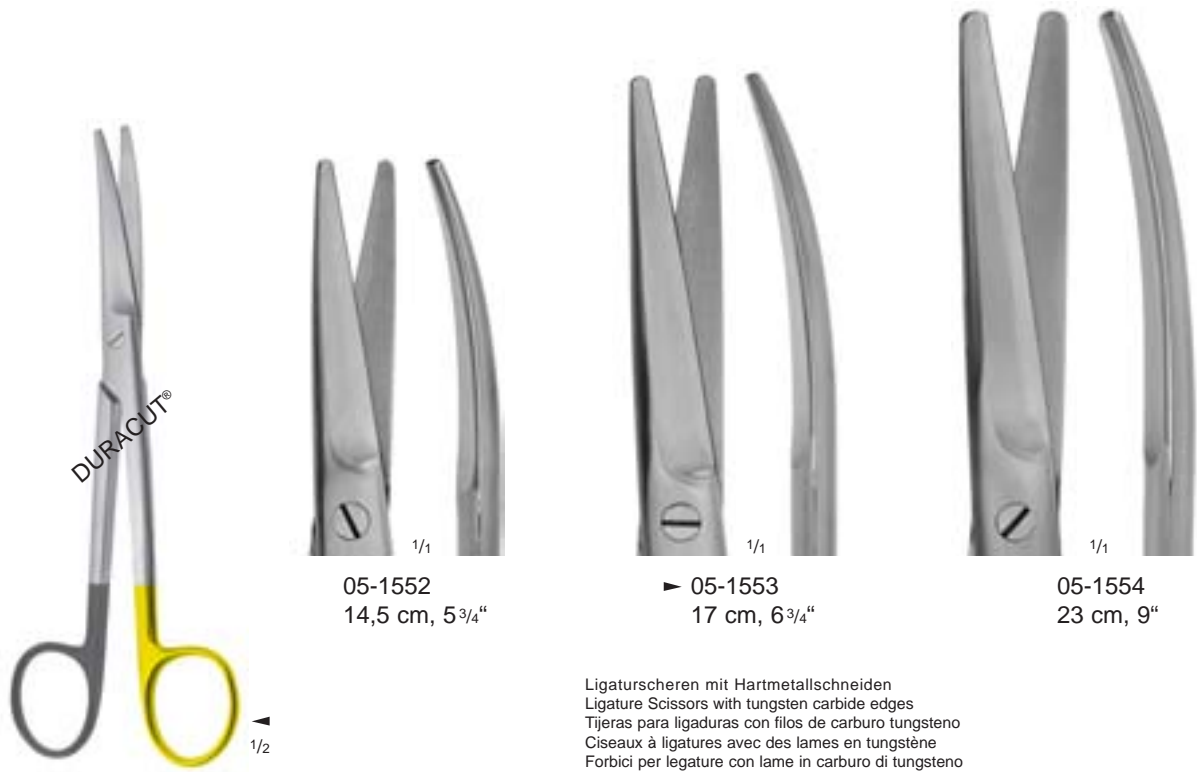
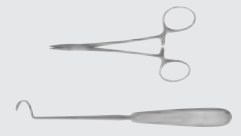

05-1552
 - 05-1554

05-1552
 14,5 cm, 5³/₄"

▶ 05-1553
 17 cm, 6³/₄"

05-1554
 23 cm, 9"

Ligaturscheren mit Hartmetallschneiden
 Ligature Scissors with tungsten carbide edges
 Tijeras para ligaduras con filos de carburo tungsteno
 Ciseaux à ligatures avec des lames en tungstène
 Forbici per legature con lame in carburo di tungsteno



08-1665
 Stärke/No. 2

Catgut, Strang zu 2,5 m, steril, in Glasflacon
 Catgut, hank of 2.5 meters, sterilized, in glass flacon
 Catgut, madeja de 2,5 m, estéril, en frasquito de vidrio
 Catgut, fil de 2,5 mètres, stérile en flacon verre
 Catgut da 2,5 m sterilizzabile in flacon vetro



08-1669 Stärke/No. 0
 ▶ 08-1670 Stärke/No. 1
 08-1671 Stärke/No. 2

Nähseide, gedreht, Strang zu 0,5 g., steril, in Glasflacon
 Suture silk, twisted, hank of 0.5 gramme, sterilized, in glass flacon
 Seda para sutura, hilado, madeja de 0,5 gr., estéril, en frasquito de vidrio
 Soie à suture, torsadée, fil de 0,5 gramme, stérile en flacon verre
 Seta intrecciata 0,5 gr. sterilizzabile in flacon vetro

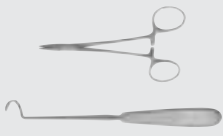

Chirurgische Nähnadeln
Surgical Suture Needles
Agujas quirúrgicas para sutura
Aiguilles à sutures
Aghi chirurgici per sutura

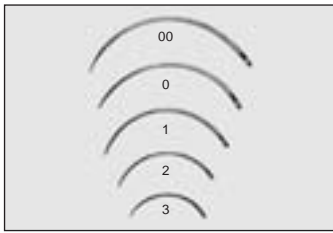

1/1



KALT

- 08-1489 Fig. 00
- 08-1490 Fig. 0
- 08-1491 Fig. 1
- 08-1492 Fig. 2
- 08-1493 Fig. 3

Gefäßnadeln, gebogen $\frac{3}{8}$ Kreis,
in Packungen zu 12 Stück

Vascular suture needles, curved
 $\frac{3}{8}$ circle, in packages of 12 pieces

Agujas vasculares, curvas $\frac{3}{8}$
círculo, cajecita de 12 piezas

Aiguilles vasculaires, $\frac{3}{8}$ de cercle,
paquet de 12.

Aghi per sutura vascolare curvi $\frac{3}{8}$ di
cerchio, in confezione da 12 pz.

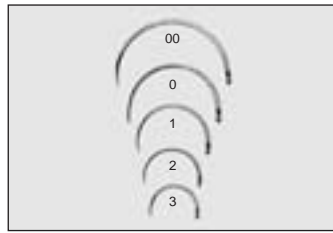

1/1



PAYR

- 08-1509 Fig. 00
- 08-1510 Fig. 0
- 08-1511 Fig. 1
- 08-1512 Fig. 2
- 08-1513 Fig. 3

Gefäßnadeln, gebogen $\frac{1}{2}$ Kreis,
in Packungen zu 12 Stück

Vascular suture needles, curved
 $\frac{1}{2}$ circle, in packages of 12 pieces

Agujas vasculares, curvas $\frac{1}{2}$
círculo, cajecita de 12 piezas

Aiguilles vasculaires, $\frac{1}{2}$ de cercle,
paquet de 12.

Aghi per sutura vascolare curvi $\frac{1}{2}$ di
cerchio, in confezione da 12 pz.

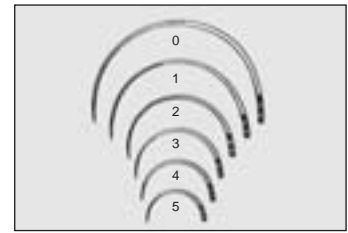

1/1



Og

- 08-1410 Fig. 0
- 08-1411 Fig. 1
- 08-1412 Fig. 2
- 08-1413 Fig. 3
- 08-1414 Fig. 4
- 08-1415 Fig. 5

Augennadeln, gebogen $\frac{1}{2}$ Kreis,
in Packungen zu 12 Stück

Eye needles, curved $\frac{1}{2}$ circle,
in packages of 12 pieces

Agujas para suturas oculares, curvas $\frac{1}{2}$
círculo, cajecita de 12 piezas

Aiguilles pour ophtalmologie, $\frac{1}{2}$ de
cercle, paquet de 12.

Aghi per oftalmologia, curvi $\frac{1}{2}$ di
cerchio, in confezione da 12 pz.

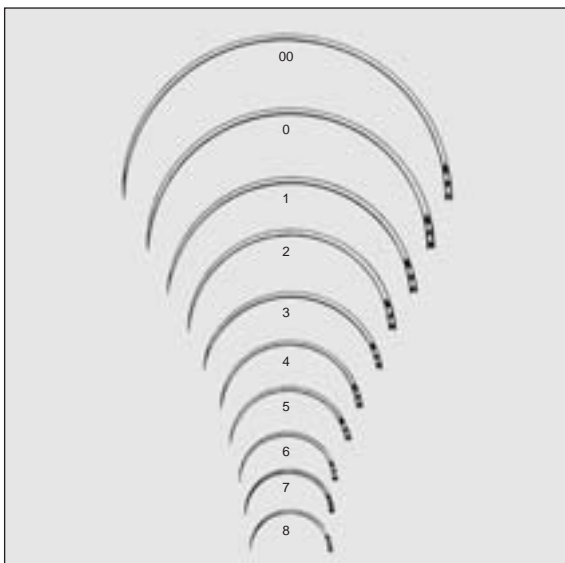

1/1



Pb

- 08-1309 Fig. 00
- 08-1310 Fig. 0
- 08-1311 Fig. 1
- 08-1312 Fig. 2
- 08-1313 Fig. 3
- 08-1314 Fig. 4
- 08-1315 Fig. 5
- 08-1316 Fig. 6
- 08-1317 Fig. 7
- 08-1318 Fig. 8

Darmnadeln, gebogen $\frac{1}{2}$ Kreis,
in Packungen zu 12 Stück

Intestinal needles, curved $\frac{1}{2}$
circle, in packages of 12 pieces

Agujas para suturas intestinales, curvas
 $\frac{1}{2}$ círculo, cajecita de 12 piezas

Aiguilles intestinales, $\frac{1}{2}$ de cercle,
paquet de 12.

Aghi per sutura intestinale curvi $\frac{1}{2}$ di
cerchio, in confezione da 12 pz.

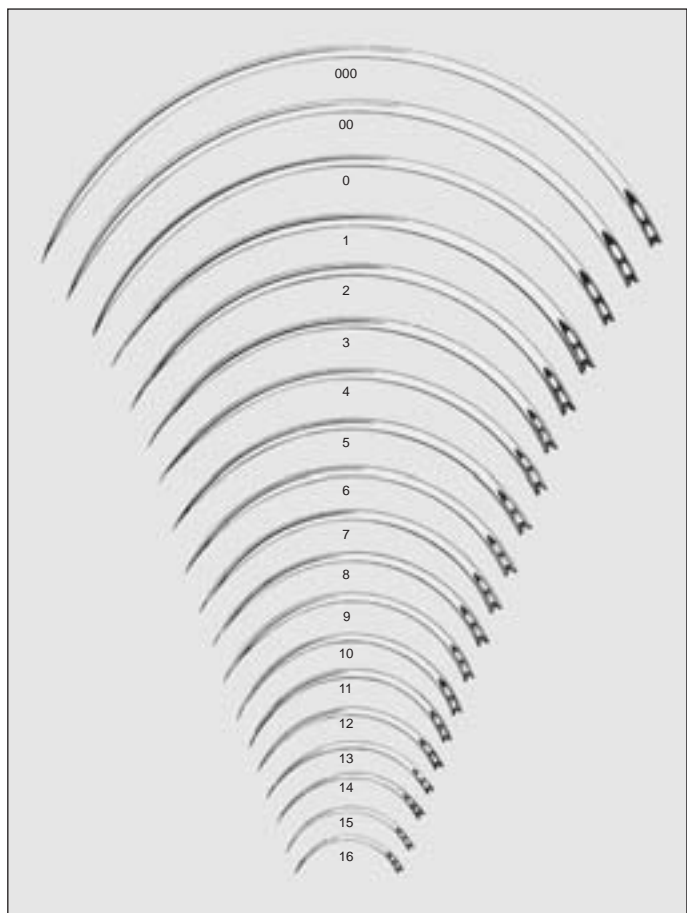
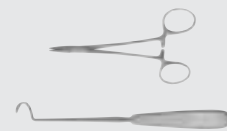

1/1



- B**
- 08-1198 Fig. 000
 - 08-1199 Fig. 00
 - 08-1200 Fig. 0
 - 08-1201 Fig. 1
 - 08-1202 Fig. 2
 - 08-1203 Fig. 3
 - 08-1204 Fig. 4
 - 08-1205 Fig. 5
 - 08-1206 Fig. 6
 - 08-1207 Fig. 7
 - 08-1208 Fig. 8
 - 08-1209 Fig. 9
 - 08-1210 Fig. 10
 - 08-1211 Fig. 11
 - 08-1212 Fig. 12
 - 08-1213 Fig. 13
 - 08-1214 Fig. 14
 - 08-1215 Fig. 15
 - 08-1216 Fig. 16

gebogen $\frac{3}{8}$ Kreis, in Packungen zu 12 Stück
 curved $\frac{3}{8}$ circle, in packages of 12 pieces
 curvas $\frac{3}{8}$ círculo, cajecita de 12 piezas
 courbure $\frac{3}{8}$ cercle, paquet de 12
 curvi $\frac{3}{8}$ di cerchio, in confezione da 12 pz.

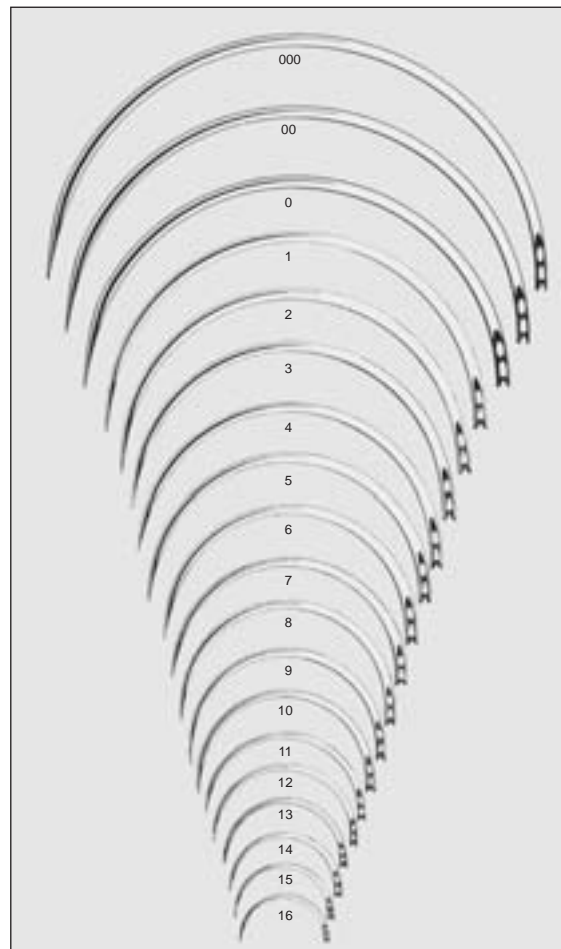

1/1



- G**
- 08-1218 Fig. 000
 - 08-1219 Fig. 00
 - 08-1220 Fig. 0
 - 08-1221 Fig. 1
 - 08-1222 Fig. 2
 - 08-1223 Fig. 3
 - 08-1224 Fig. 4
 - 08-1225 Fig. 5
 - 08-1226 Fig. 6
 - 08-1227 Fig. 7
 - 08-1228 Fig. 8
 - 08-1229 Fig. 9
 - 08-1230 Fig. 10
 - 08-1231 Fig. 11
 - 08-1232 Fig. 12
 - 08-1233 Fig. 13
 - 08-1234 Fig. 14
 - 08-1235 Fig. 15
 - 08-1236 Fig. 16

gebogen $\frac{1}{2}$ Kreis, in Packungen zu 12 Stück
 curved $\frac{1}{2}$ circle, in packages of 12 pieces
 curvas $\frac{1}{2}$ círculo, cajecita de 12 piezas
 courbure $\frac{1}{2}$ cercle, paquet de 12
 curvi $\frac{1}{2}$ di cerchio, in confezione da 12 pz.

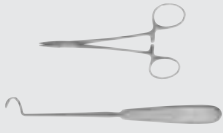

Chirurgische Nähnadeln
 Surgical Suture Needles
 Aguja quirúrgicas para sutura
 Aiguilles à sutures
 Aghi chirurgici per sutura

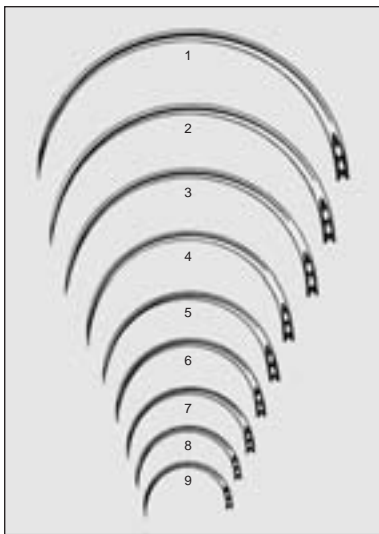

1/1



Ga

- 08-1131 Fig. 1
- 08-1132 Fig. 2
- 08-1133 Fig. 3
- 08-1134 Fig. 4
- 08-1135 Fig. 5
- 08-1136 Fig. 6
- 08-1137 Fig. 7
- 08-1138 Fig. 8
- 08-1139 Fig. 9

gebogen 1/2 Kreis, in Packungen zu 12 Stück
 curved 1/2 circle, in packages of 12 pieces
 curvas 1/2 círculo, cajecita de 12 piezas
 courbure 1/2 cercle, paquet de 12
 curvi 1/2 di cerchio, in confezione da 12 pz.

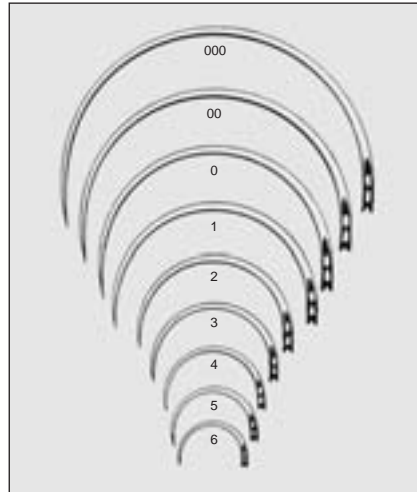

1/1



E

- 08-1258 Fig. 000
- 08-1259 Fig. 00
- 08-1260 Fig. 0
- 08-1261 Fig. 1
- 08-1262 Fig. 2
- 08-1263 Fig. 3
- 08-1264 Fig. 4
- 08-1265 Fig. 5
- 08-1266 Fig. 6

gebogen 1/2 Kreis, in Packungen zu 12 Stück
 curved 1/2 circle, in packages of 12 pieces
 curvas 1/2 círculo, cajecita de 12 piezas
 courbure 1/2 cercle, paquet de 12
 curvi 1/2 di cerchio, in confezione da 12 pz.

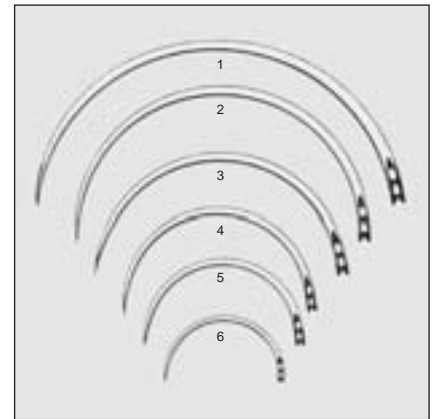

1/1



FERGUSON

- 08-1341 Fig. 1
- 08-1342 Fig. 2
- 08-1343 Fig. 3
- 08-1344 Fig. 4
- 08-1345 Fig. 5
- 08-1346 Fig. 6

gebogen 1/2 Kreis, in Packungen zu 12 Stück
 curved 1/2 circle, in packages of 12 pieces
 curvas 1/2 círculo, cajecita de 12 piezas
 courbure 1/2 cercle, paquet de 12
 curvi 1/2 di cerchio, in confezione da 12 pz.

Weitere chirurgische Nähnadeln auf Anfrage lieferbar !
 Further surgical suture needles can be delivered on request !
 Más agujas quirúrgicas para sutura entregables según demanda !
 Autres aiguilles à sutures livrées sur commandes !
 Altri aghi chirurgici per sutura possono essere ordinati su richiesta !

Nadel-Sterilisierdosen
 Needle Sterilizing Boxes
 Estuches para esterilizar agujas
 Boîtes pour stériliser des aiguilles de suture
 Scatole per sterilizzare aghi da sutura

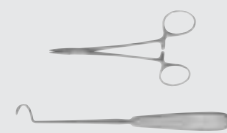

- 08-1660 50 x 25 x 4,5 mm
- 08-1659 65 x 42 x 8,0 mm
- ▶ 08-1662 77 x 25 x 5,5 mm



- 08-1641
150 x 95 x 13 mm



- SAUERBRUCH
08-1643
210 x 125 x 17 mm



- SAUERBRUCH
08-1644
210 x 125 x 17 mm



- ▶ 08-1650
65 x 15 mm
Außen- und Innendose
Exterior and interior box
Caja exterior e interior
Boîte extérieure et intérieure
Scatola esterna ed interiore

- 08-1651
62 x 13 mm
Innendose allein
Interior box only
Caja interior, suelta
Boîte intérieure seule
Scatola interiore sola

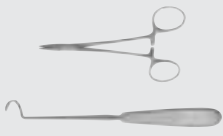

Mikro-Nadelhalter mit flachen Federgriffen
 Micro Needle Holders with flat spring type handles
 Micro-Porta-agujas con mangos de resortes planos
 Micro porte-aiguilles avec manches à ressorts plats
 Micro portaghi con manici a molla piatta



PERFECT-GRIP

PERFECT-GRIP Nadelhalter mit spezialbeschichteten Maulteilen garantieren ein rutschesicheres und schonendes Fassen von feinsten Wundnadeln und Nahtmaterial (siehe Seiten 359, 361-362, 364-365).

PERFECT-GRIP Needle holders with specially coated jaws ensure a non-slip and gentle grasping of most delicate wound needles and sutures (see pages 359, 361-362, 364-365).

PERFECT-GRIP Porta-agujas con las bocas cubiertas especiales garantizan un sujeto antideslizante y cuidadoso para agujas de sutura muy finas y materiales de sutura (veán paginas 359, 361-362, 364-365).

PERFECT-GRIP Porte-aiguilles avec les mors recouverts d'une couche spéciale garantissent une excellente préhension des aiguilles à suture les plus fines (voir pages 359, 361-362, 364-365).

PERFECT-GRIP Portaghi con morso rivestito da un materiale speciale che garantisce il non sivolamento e la presa delicata ma sicura anche con le suture più sottili (da vedere pagine 359, 361-362, 364-365).

 1/1
 ▶ 62-3742
 9 cm, 3 1/2"

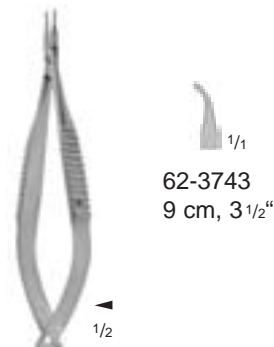

 1/1
 62-3743
 9 cm, 3 1/2"

MICRO-CASTROVIEJO
 62-3742
 - 62-3743

mit glatten Maulteilen / ohne Sperre
 with smooth jaws / without catch
 con bocas lisas / sin cremallera
 avec mors lisses / sans verrou
 con punta liscia / senza cremagliera

 1/1
 ▶ 62-3744
 9 cm, 3 1/2"

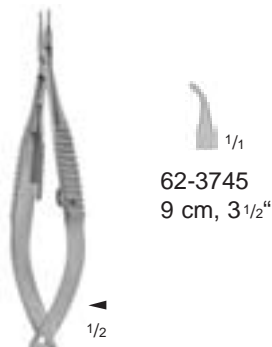



 1/1
 62-3745
 9 cm, 3 1/2"

MICRO-CASTROVIEJO
 62-3744
 - 62-3745

mit glatten Maulteilen / mit Sperre
 with smooth jaws / with catch
 con bocas lisas / con cremallera
 avec mors lisses / à verrou
 con punta liscia / con cremagliera

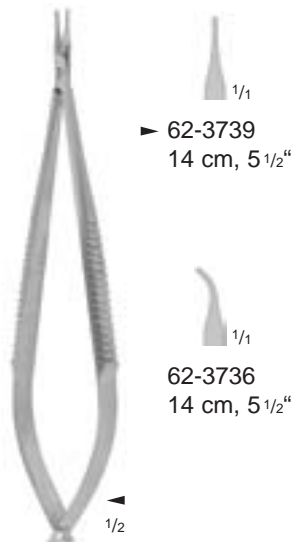
 1/1
 ▶ 62-3739
 14 cm, 5 1/2"





 1/1
 62-3736
 14 cm, 5 1/2"

MICRO-CASTROVIEJO
 62-3736
 - 62-3739

mit glatten Maulteilen / ohne Sperre
 with smooth jaws / without catch
 con bocas lisas / sin cremallera
 avec mors lisses / sans verrou
 con punta liscia / senza cremagliera

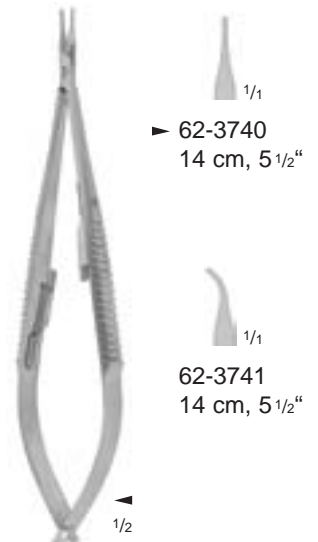
 1/1
 ▶ 62-3740
 14 cm, 5 1/2"



 1/1
 62-3741
 14 cm, 5 1/2"

MICRO-CASTROVIEJO
 62-3740
 - 62-3741

mit glatten Maulteilen / mit Sperre
 with smooth jaws / with catch
 con bocas lisas / con cremallera
 avec mors lisses / à verrou
 con punta liscia / con cremagliera

Mikro-Nadelhalter mit flachen Federgriffen
 Micro Needle Holders with flat spring type handles
 Micro-Porta-agujas con mangos de resortes planos
 Micro porte-aiguilles avec manches à ressorts plats
 Micro portaghi con manici a molla piatta

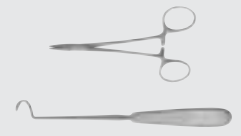

▶ 25-0210
18 cm, 7"

▶ 25-0211
21 cm, 8 1/4"

▶ 25-0212
18 cm, 7"

▶ 25-0213
21 cm, 8 1/4"

mit spezialbeschichteten Maulteilen / ohne Sperre
 with specially coated jaws / without catch
 con bocas cubiertas especiales / sin cremallera
 avec mors recouverts d'une couche spéciale / sans verrou
 con copertura speciale della punta / senza cremagliera

1/2

JACOBSON
 25-0210
 - 25-0213

▶ 25-0216
18 cm, 7"

▶ 25-0217
21 cm, 8 1/4"

▶ 25-0218
18 cm, 7"

▶ 25-0219
21 cm, 8 1/4"

mit spezialbeschichteten Maulteilen / mit Sperre
 with specially coated jaws / with catch
 con bocas cubiertas especiales / con cremallera
 avec mors recouverts d'une couche spéciale / à verrou
 con copertura speciale della punta / con cremagliera

1/2

JACOBSON
 25-0216
 - 25-0219

▶ 25-0320
16 cm, 6 1/4"

▶ 25-0321
18,5 cm, 7 1/4"

▶ 25-0322
16 cm, 6 1/4"

▶ 25-0323
18,5 cm, 7 1/4"

mit spezialbeschichteten Maulteilen / ohne Sperre
 with specially coated jaws / without catch
 con bocas cubiertas especiales / sin cremallera
 avec mors recouverts d'une couche spéciale / sans verrou
 con copertura speciale della punta / senza cremagliera

1/2

25-0320
 - 25-0323

▶ 25-0326
16 cm, 6 1/4"

▶ 25-0327
18,5 cm, 7 1/4"

▶ 25-0328
16 cm, 6 1/4"

▶ 25-0329
18,5 cm, 7 1/4"

mit spezialbeschichteten Maulteilen / mit Sperre
 with specially coated jaws / with catch
 con bocas cubiertas especiales / con cremallera
 avec mors recouverts d'une couche spéciale / à verrou
 con copertura speciale della punta / con cremagliera

1/2

25-0326
 - 25-0329

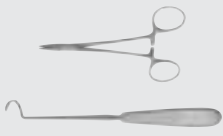

Mikro-Nadelhalter mit runden Federgriffen
 Micro Needle Holders with round spring type handles
 Micro-Porta-agujas con mangos de resortes redondos
 Micro porte-aiguilles avec manches à ressorts ronds
 Micro portaghi con manici a molla rotonda



▶ 62-3765
9,5 cm, 3³/₄"

62-3763
9,5 cm, 3³/₄"

BARRAQUER-TROUTMAN
 62-3763
 - 62-3765

mit glatten Maulteilen / ohne Sperre
 with smooth jaws / without catch
 con bocas lisas / sin cremallera
 avec mors lisses / sans verrou
 con punta liscia / senza cremagliera



▶ 62-3764
9,5 cm, 3³/₄"

62-3762
9,5 cm, 3³/₄"

BARRAQUER-TROUTMAN
 62-3762
 - 62-3764

mit glatten Maulteilen / mit Sperre
 with smooth jaws / with catch
 con bocas lisas / con cremallera
 avec mors lisses / à verrou
 con punta liscia / con cremagliera



62-3768
11,5 cm, 4¹/₂"

62-3769
13,5 cm, 5¹/₄"

62-3755
11,5 cm, 4¹/₂"

▶ 62-3760
13,5 cm, 5¹/₄"

BARRAQUER
 62-3755
 - 62-3769

mit glatten Maulteilen / ohne Sperre
 with smooth jaws / without catch
 con bocas lisas / sin cremallera
 avec mors lisses / sans verrou
 con punta liscia / senza cremagliera



62-3778
11,5 cm, 4¹/₂"

62-3779
13,5 cm, 5¹/₄"

62-3756
11,5 cm, 4¹/₂"

▶ 62-3761
13,5 cm, 5¹/₄"







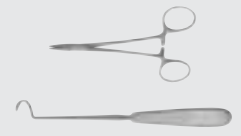



BARRAQUER
 62-3756
 - 62-3779

mit glatten Maulteilen / mit Sperre
 with smooth jaws / with catch
 con bocas lisas / con cremallera
 avec mors lisses / à verrou
 con punta liscia / con cremagliera

Mikro-Nadelhalter mit runden Federgriffen
 Micro Needle Holders with round spring type handles
 Micro-Porta-agujas con mangos de resortes redondos
 Micro porte-aiguilles avec manches à ressorts ronds
 Micro portaghi con manici a molla rotonda













25-0420
 - 25-0429

				
25-0420 12 cm, 4 3/4"	25-0421 15 cm, 6"	▶ 25-0422 18 cm, 7"	25-0423 21 cm, 8 1/4"	25-0424 23 cm, 9"
				
25-0425 12 cm, 4 3/4"	25-0426 15 cm, 6"	25-0427 18 cm, 7"	25-0428 21 cm, 8 1/4"	25-0429 23 cm, 9"

mit spezialbeschichteten Maulteilen / ohne Sperre
 with specially coated jaws / without catch
 con bocas cubiertas especiales / sin cremallera
 avec mors recouverts d'une couche spéciale / sans verrou
 con copertura speciale della punta / senza cremagliera



25-0430
 - 25-0439

				
25-0430 12 cm, 4 3/4"	25-0431 15 cm, 6"	▶ 25-0432 18 cm, 7"	25-0433 21 cm, 8 1/4"	25-0434 23 cm, 9"
				
25-0435 12 cm, 4 3/4"	25-0436 15 cm, 6"	25-0437 18 cm, 7"	25-0438 21 cm, 8 1/4"	25-0439 23 cm, 9"

mit spezialbeschichteten Maulteilen / mit Sperre
 with specially coated jaws / with catch
 con bocas cubiertas especiales / con cremallera
 avec mors recouverts d'une couche spéciale / à verrou
 con copertura speciale della punta / con cremagliera

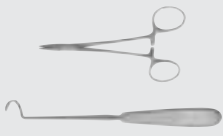

Mikro-Nadelhalter
 Micro Needle Holders
 Micro-Porta-agujas
 Micro porte-aiguilles
 Micro portaghi

25-0461 15 cm, 6"
 25-0462 18 cm, 7"
 25-0463 21 cm, 8 1/4"
 25-0466 15 cm, 6"
 25-0467 18 cm, 7"
 25-0468 21 cm, 8 1/4"

aus TITAN gefertigt, mit spezialbeschichteten Maulteilen / ohne Sperre
 made of TITANIUM, with specially coated jaws / without catch
 fabricados de TITANIO, con bocas cubiertas especiales / sin cremallera
 en TITANE, recouverts d'une couche spéciale / sans verrou
 in TITANIO, con copertura speciale della punta / senza cremagliera

25-0461
 - 25-0468

25-0471 15 cm, 6"
 25-0472 18 cm, 7"
 25-0473 21 cm, 8 1/4"
 25-0476 15 cm, 6"
 25-0477 18 cm, 7"
 25-0478 21 cm, 8 1/4"

aus TITAN gefertigt, mit spezialbeschichteten Maulteilen / mit Sperre
 made of TITANIUM, with specially coated jaws / with catch
 fabricados de TITANIO, con bocas cubiertas especiales / con cremallera
 en TITANE, recouverts d'une couche spéciale / à verrou
 in TITANIO, con copertura speciale della punta / con cremagliera

25-0471
 - 25-0478

57-1095 20 cm, 8"
 57-1096 20 cm, 8"

YASARGIL
 57-1095
 - 57-1096

mit spezialbeschichteten Maulteilen / ohne Sperre
 with specially coated jaws / without catch
 con bocas cubiertas especiales / sin cremallera
 avec mors recouverts d'une couche spéciale / sans verrou
 con copertura speciale della punta / senza cremagliera

57-1097 22,5 cm, 9"
 57-1098 22,5 cm, 9"
 57-1099 24,5 cm, 9 3/4"

YASARGIL
 57-1097
 - 57-1099

mit spezialbeschichteten Maulteilen / ohne Sperre
 with specially coated jaws / without catch
 con bocas cubiertas especiales / sin cremallera
 avec mors recouverts d'une couche spéciale / sans verrou
 con copertura speciale della punta / con cremagliera

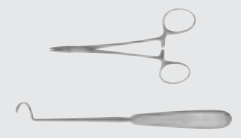

CASTROVIEJO
62-3750
13 cm, 5 1/8"

glattes Maul
smooth jaws
bocas lisas
mors lisses
morso liscio



KALT
08-0036
13,5 cm, 5 1/4"

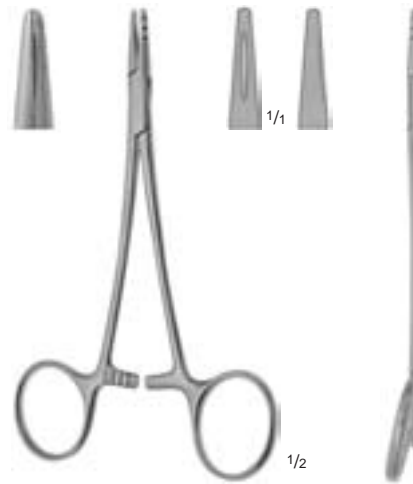

NEIVERT
08-0016
12,5 cm, 5"

glattes Maul mit Spezialkehle
smooth jaws, with special groove
bocas lisas, con acanaladura especial
mors lisses, rainurés
morso liscio con scanalatura speciale



DERF
08-0030
12 cm, 4 3/4"

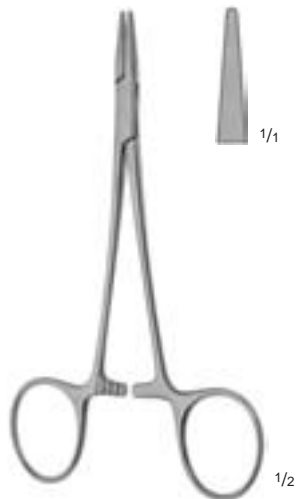

HALSEY
08-0010
13 cm, 5 1/8"

glattes Maul
smooth jaws
bocas lisas
mors lisses
morso liscio

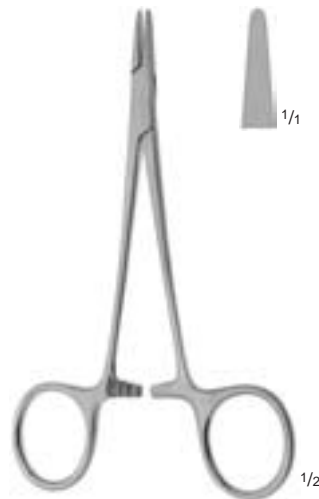

WEBSTER
08-0024
13 cm, 5 1/8"

glattes Maul
smooth jaws
bocas lisas
mors lisses
morso liscio



COLLIER
08-0020
13 cm, 5 1/8"

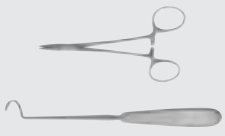

Nadelhalter
Needle Holders
Porta-agujas
Porte-aiguilles
Portaghi

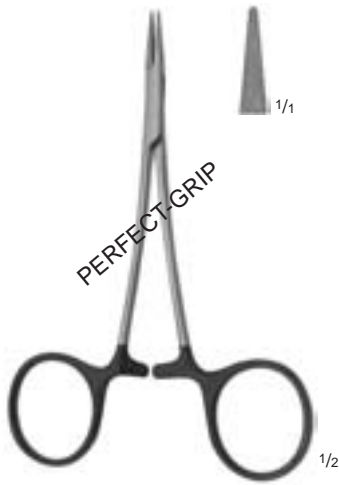

VASCULAR
08-1020
12,5 cm, 5"

mit spezialbeschichteten Maulteilen
with specially coated jaws
con bocas cubiertas especiales
avec mors recouverts d'une couche spéciale
con copertura speciale della punta



VASCULAR
08-1022
14,5 cm, 5³/₄"

mit spezialbeschichteten Maulteilen
with specially coated jaws
con bocas cubiertas especiales
avec mors recouverts d'une couche spéciale
con copertura speciale della punta



VASCULAR
08-1024
17,5 cm, 7"

mit spezialbeschichteten Maulteilen
with specially coated jaws
con bocas cubiertas especiales
avec mors recouverts d'une couche spéciale
con copertura speciale della punta



VASCULAR
08-1026
19,5 cm, 7³/₄"

mit spezialbeschichteten Maulteilen
with specially coated jaws
con bocas cubiertas especiales
avec mors recouverts d'une couche spéciale
con copertura speciale della punta



VASCULAR
08-1028
22,5 cm, 9"

mit spezialbeschichteten Maulteilen
with specially coated jaws
con bocas cubiertas especiales
avec mors recouverts d'une couche spéciale
con copertura speciale della punta

TITAN-LINE Nadelhalter aus TITAN gefertigt
 TITAN-LINE Needle Holders made of TITANIUM
 TITAN-LINE Porta-agujas fabricados de TITANIO
 TITAN-LINE Porte-aiguilles en TITANE
 TITAN-LINE Portaghi in TITANIO

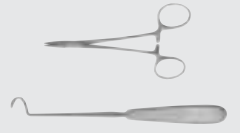

VASCULAR
 08-1030
 12,5 cm, 5"

mit spezialbeschichteten Maulteilen
 with specially coated jaws
 con bocas cubiertas especiales
 avec mors recouverts d'une couche spéciale
 con copertura speciale della punta



VASCULAR
 08-1032
 14,5 cm, 5 3/4"

mit spezialbeschichteten Maulteilen
 with specially coated jaws
 con bocas cubiertas especiales
 avec mors recouverts d'une couche spéciale
 con copertura speciale della punta



VASCULAR
 08-1034
 17,5 cm, 7"

mit spezialbeschichteten Maulteilen
 with specially coated jaws
 con bocas cubiertas especiales
 avec mors recouverts d'une couche spéciale
 con copertura speciale della punta



VASCULAR
 08-1036
 19,5 cm, 7 3/4"

mit spezialbeschichteten Maulteilen
 with specially coated jaws
 con bocas cubiertas especiales
 avec mors recouverts d'une couche spéciale
 con copertura speciale della punta



VASCULAR
 08-1038
 22,5 cm, 9"

mit spezialbeschichteten Maulteilen
 with specially coated jaws
 con bocas cubiertas especiales
 avec mors recouverts d'une couche spéciale
 con copertura speciale della punta

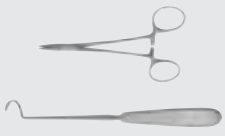

Nadelhalter
Needle Holders
Porta-agujas
Porte-aiguilles
Portaghi



BROWN
78-0320
13 cm, 5 1/8"

mit konvexen Maulteilen
with convex jaws
con bocas convexas
avec mors convexes
con morso diagonale

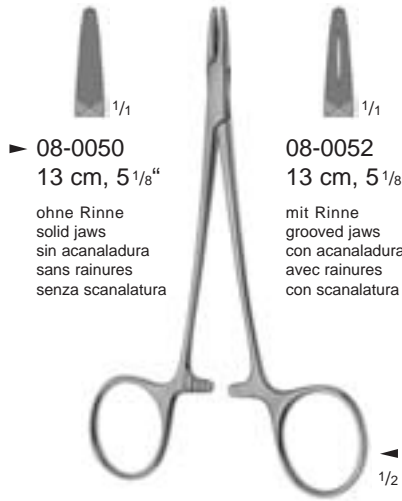

▶ 08-0050
13 cm, 5 1/8"

ohne Rinne
solid jaws
sin acanaladura
sans rainures
senza scanalatura

BAUMGARTNER
08-0050
- 08-0052

leichte Modelle
light patterns
modelos ligeros
modèles légers
modelli leggeri

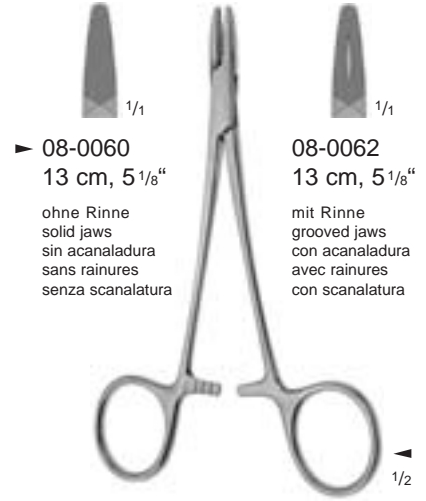

▶ 08-0060
13 cm, 5 1/8"

ohne Rinne
solid jaws
sin acanaladura
sans rainures
senza scanalatura

BAUMGARTNER
08-0060
- 08-0062

kräftige Modelle
heavy patterns
modelos robustos
modèles forts
modelli robusti



CRILE-MURRAY
08-0014
15 cm, 6"



CRILE-WOOD
08-0064
15 cm, 6"



CARROLL
08-0082
16 cm, 6 1/4"

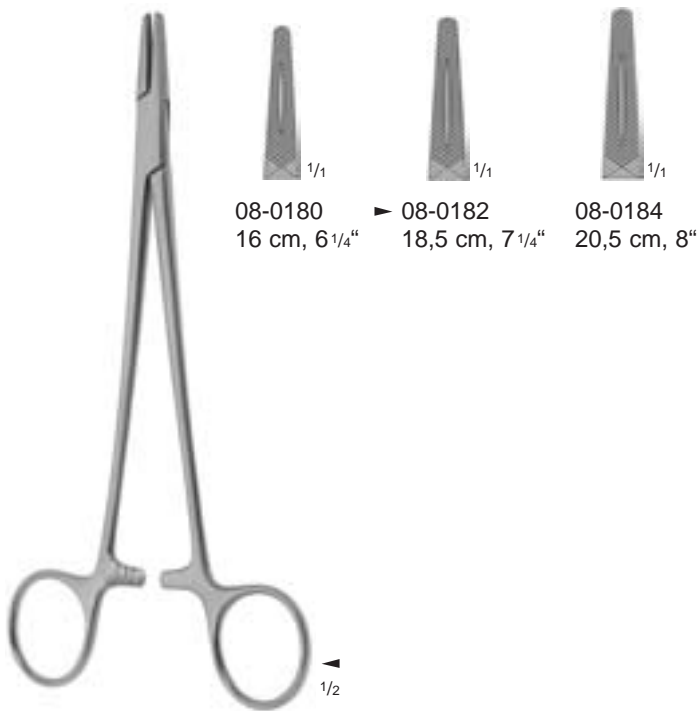
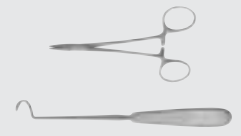

08-0180 16 cm, 6 1/4" ▶ 08-0182 18,5 cm, 7 1/4" 08-0184 20,5 cm, 8"

MAYO-HEGAR
 08-0180
 - 08-0184

leichte Modelle
 light patterns
 modelos ligeros
 modèles légers
 modelli leggeri

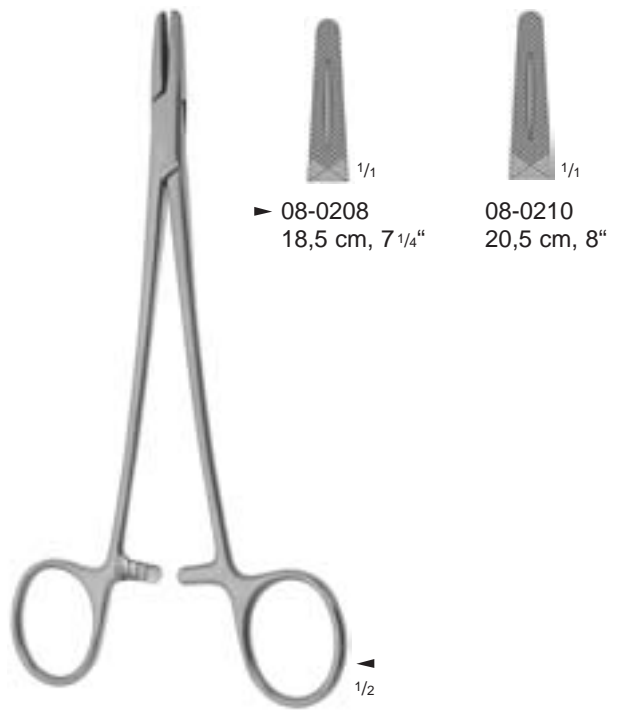

▶ 08-0208 18,5 cm, 7 1/4" 08-0210 20,5 cm, 8"

MAYO-HEGAR
 08-0208
 - 08-0210

kräftige Modelle
 heavy patterns
 modelos robustos
 modèles forts
 modelli robusti



NEW ORLEANS
 08-0040
 17,5 cm, 7"



ADSON
 08-0090
 18 cm, 7"

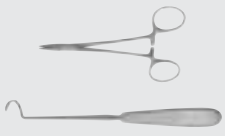

Nadelhalter
Needle Holders
Porta-agujas
Porte-aiguilles
Portaghi



CRILE-WOOD
08-0071
20,5 cm, 8"



JAMESON
08-0075
23 cm, 9"



MASSON
08-0340
26,5 cm, 10 1/2"

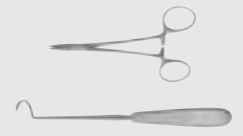

WANGENSTEEN
08-0364
27 cm, 10³/₄"



HEANEY
08-0350
20,5 cm, 8"



FINOCHIETTO
08-0356
26,5 cm, 10¹/₂"

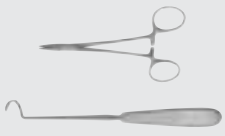

Nadelhalter mit Schere
 Needle Holders with Scissors
 Porta-agujas con tijera
 Porte-aiguilles avec ciseaux
 Portaghi con forbici



OLSEN-HEGAR
 08-0112
 13,5 cm, 5 1/4"



OLSEN-HEGAR
 08-0114
 17 cm, 6 3/4"



OLSEN-HEGAR
 08-0116
 18,5 cm, 7 1/4"

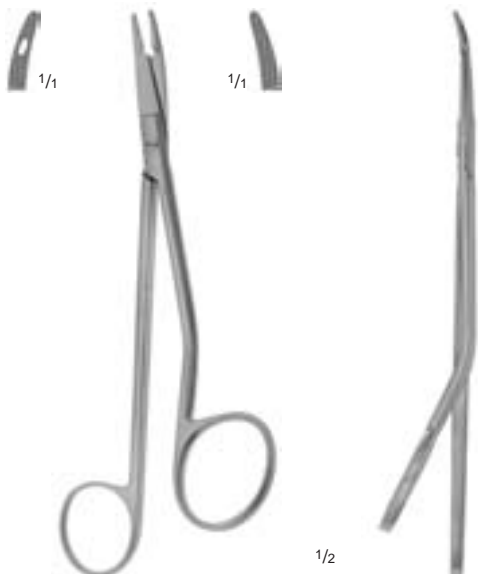

BABY-GILLIES
 08-0176
 15 cm, 6"

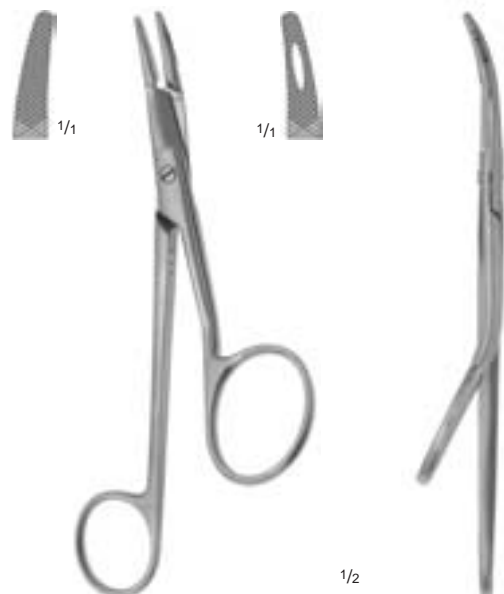

GILLIES
 08-0179
 15,5 cm, 6"

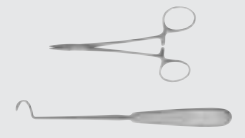

MATHIEU
 08-0337
 - 08-0339



08-0337
 14 cm, 5 1/2"



▶ 08-0338
 16,5 cm, 6 1/2"



08-0339
 20 cm, 8"



CRILE
 08-0092
 15 cm, 6"



elastisches Modell
 elastic pattern
 modelo elástico
 modèle souple
 modello elastico

TOENNIS
 08-0342
 18,5 cm, 7 1/4"

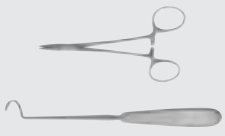

Bumerang-Nadelhalter
Boomerang Needle Holders
Porta-agujas de bumerang
Porte-aiguilles boomerangs
Portaghi a boomerang



1/2

YOUNG-MILLIN
92-0340
21,5 cm, 8 1/2"

Bumerang-Nadelhalter
mit 1 Nadel 92-0341
Boomerang needle holder
with 1 needle 92-0341
Porta-aguja de bumerang
con 1 aguja 92-0341
Porte-aiguilles boomerang
avec 1 aiguille 92-0341
Portaghi a boomerang con
1 ago 92-0341



1/2

YOUNG-HRYNTSCHAK
92-0338
26 cm, 10 1/4"

Bumerang-Nadelhalter
mit 1 Nadel 92-0341
Boomerang needle holder
with 1 needle 92-0341
Porta-aguja de bumerang
con 1 aguja 92-0341
Porte-aiguilles boomerang avec 1
aiguille 92-0341
Portaghi a boomerang con
1 ago 92-0341



1/1

92-0341



1/1

92-0342



1/1

92-0343

92-0341
- 92-0343

Ersatznadeln
Spare needles
Agujas de repuesto
Aiguilles de rechange
Aghi di ricambio

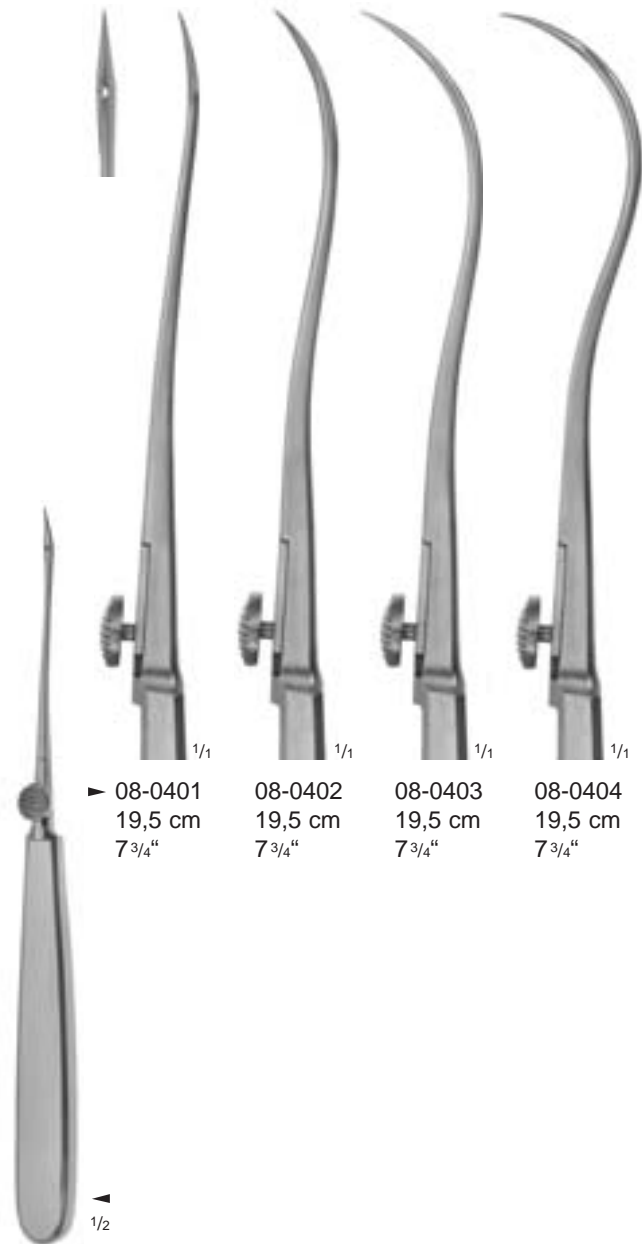
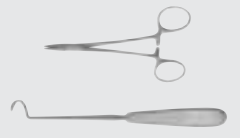

▶ 08-0401	08-0402	08-0403	08-0404
19,5 cm	19,5 cm	19,5 cm	19,5 cm
7 3/4"	7 3/4"	7 3/4"	7 3/4"

REVERDIN
 08-0401
 - 08-0404

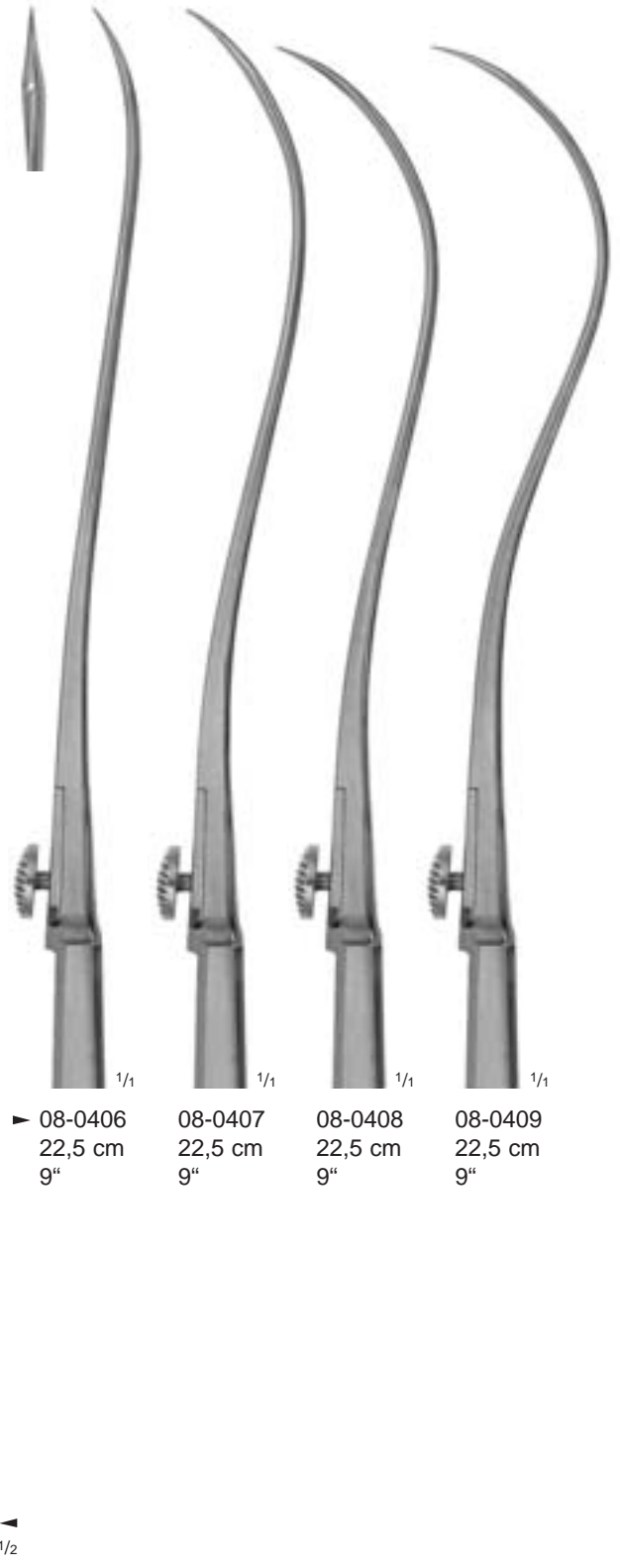

▶ 08-0406	08-0407	08-0408	08-0409
22,5 cm	22,5 cm	22,5 cm	22,5 cm
9"	9"	9"	9"

REVERDIN
 08-0406
 - 08-0409

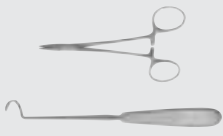

Unterbindungsadeln
 Ligature Needles
 Agujas para ligaduras
 Aiguilles à ligatures
 Aghi per legatura

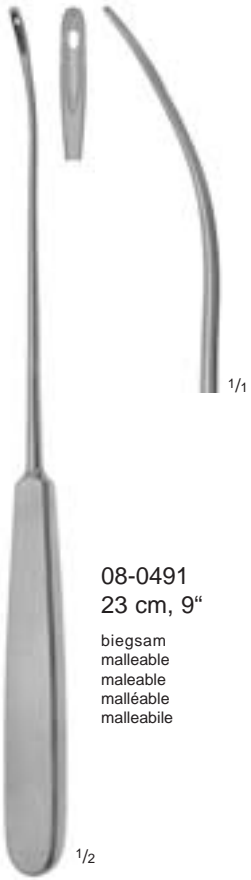

08-0491
23 cm, 9"

biegsam
malleable
maleable
malléable
malleabile

1/2



KRONECKER
08-0413
15 cm, 6"

für die rechte
Hand, stumpf
for the right
hand, blunt
para la mano
derecha, roma
pour la main
droite, mousse
per la mano
destra, smusso

1/2

KRONECKER
08-0412
15 cm, 6"

für die linke
Hand, stumpf
for the left
hand, blunt
para la mano
izquierda, roma
pour la main
gauche, mousse
per la mano
sinistra, smusso



HURD
81-0308
22,5 cm, 9"

für die rechte
Hand, scharf
for the right
hand, sharp
para la mano
derecha, aguda
pour la main
droite, pointue
per la mano
destra, acuto

1/2

HURD
81-0309
22,5 cm, 9"

für die linke
Hand, scharf
for the left
hand, sharp
para la mano
izquierda, aguda
pour la main
gauche, pointue
per la mano
sinistra, acuto



COOPER
08-0484
19 cm, 7 1/2"

1/2

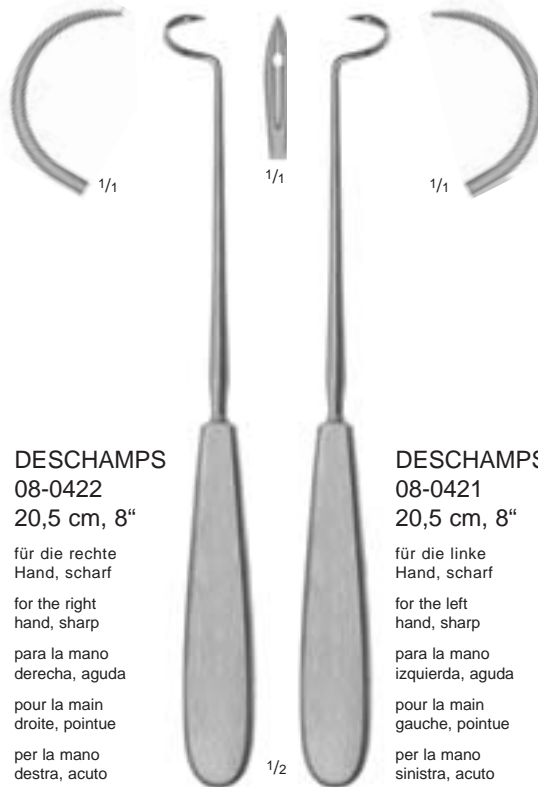

DESCHAMPS
08-0422
20,5 cm, 8"

für die rechte
Hand, scharf
for the right
hand, sharp
para la mano
derecha, aguda
pour la main
droite, pointue
per la mano
destra, acuto

1/2

DESCHAMPS
08-0421
20,5 cm, 8"

für die linke
Hand, scharf
for the left
hand, sharp
para la mano
izquierda, aguda
pour la main
gauche, pointue
per la mano
sinistra, acuto

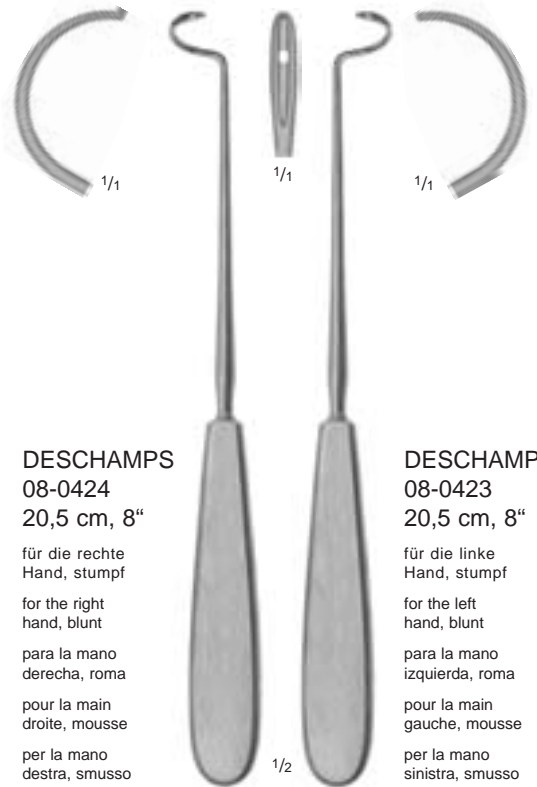

DESCHAMPS
08-0424
20,5 cm, 8"

für die rechte
Hand, stumpf
for the right
hand, blunt
para la mano
derecha, roma
pour la main
droite, mousse
per la mano
destra, smusso

1/2

DESCHAMPS
08-0423
20,5 cm, 8"

für die linke
Hand, stumpf
for the left
hand, blunt
para la mano
izquierda, roma
pour la main
gauche, mousse
per la mano
sinistra, smusso

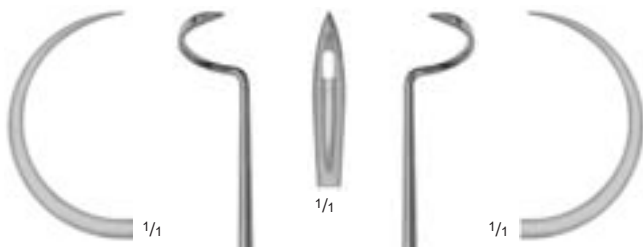
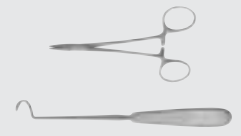

DESCHAMPS
 08-0426
 20,5 cm, 8"

für die rechte
 Hand, scharf
 for the right
 hand, sharp
 para la mano
 derecha, aguda
 pour la main
 droite, pointue
 per la mano
 destra, acuto

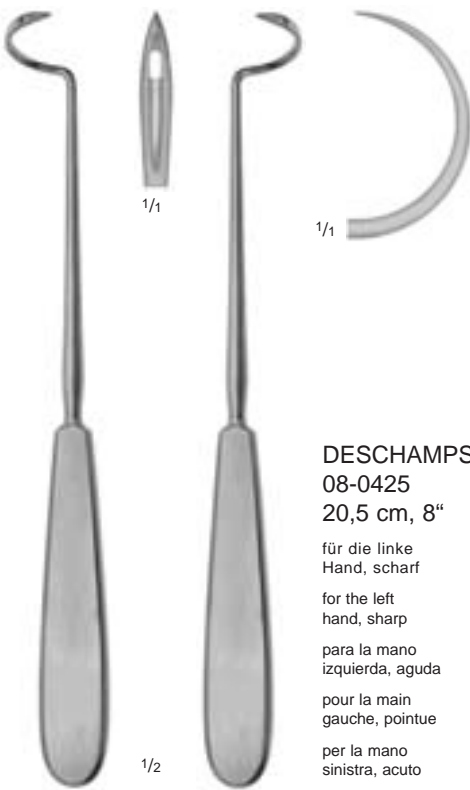

DESCHAMPS
 08-0425
 20,5 cm, 8"

für die linke
 Hand, scharf
 for the left
 hand, sharp
 para la mano
 izquierda, aguda
 pour la main
 gauche, pointue
 per la mano
 sinistra, acuto

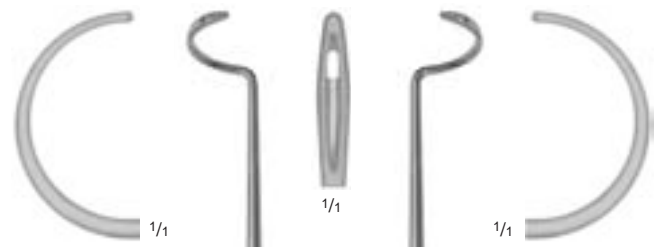

DESCHAMPS
 08-0428
 20,5 cm, 8"

für die rechte
 Hand, stumpf
 for the right
 hand, blunt
 para la mano
 derecha, roma
 pour la main
 droite, mousse
 per la mano
 destra, smusso

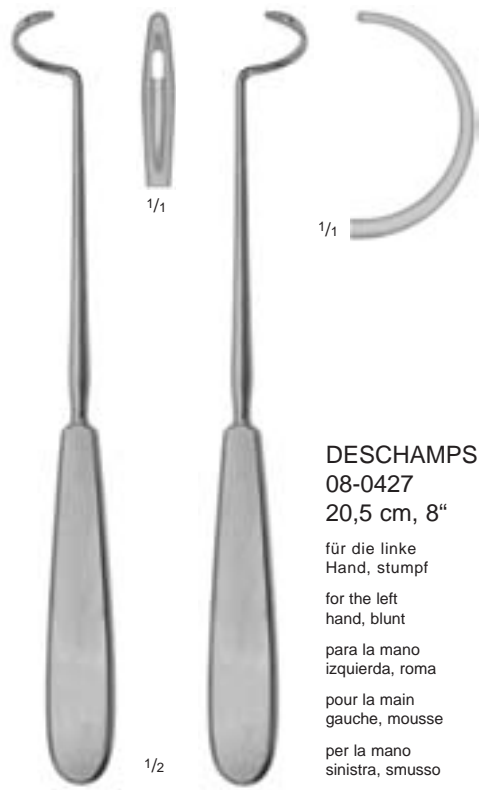

DESCHAMPS
 08-0427
 20,5 cm, 8"

für die linke
 Hand, stumpf
 for the left
 hand, blunt
 para la mano
 izquierda, roma
 pour la main
 gauche, mousse
 per la mano
 sinistra, smusso

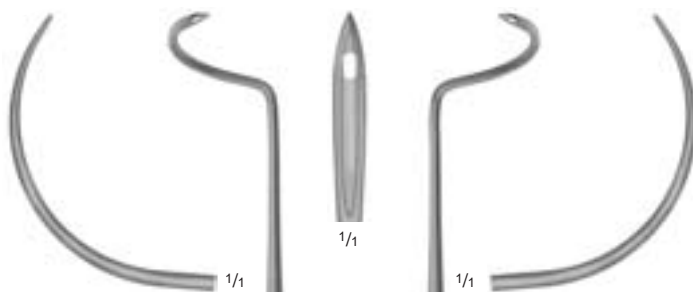

DESCHAMPS
 08-0438
 24 cm, 9 1/2"

für die rechte
 Hand, scharf
 for the right
 hand, sharp
 para la mano
 derecha, aguda
 pour la main
 droite, pointue
 per la mano
 destra, acuto

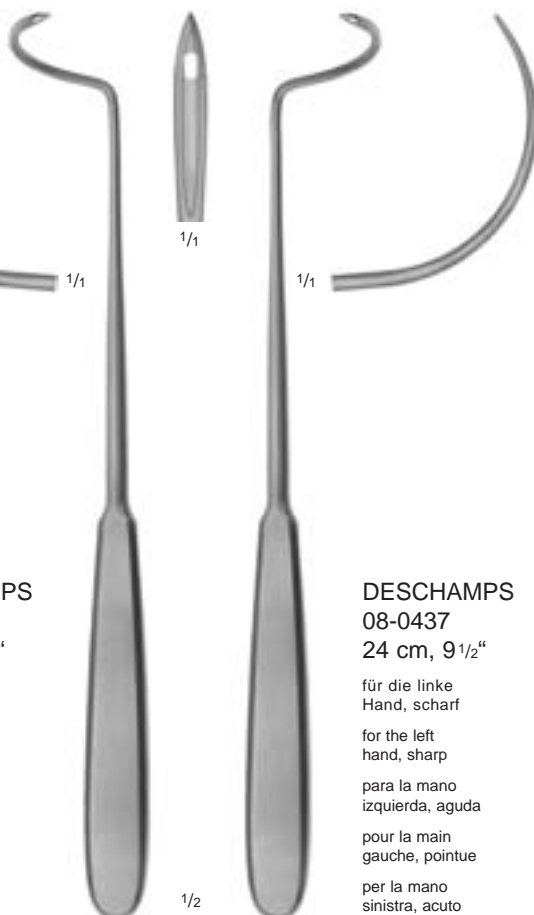

DESCHAMPS
 08-0437
 24 cm, 9 1/2"

für die linke
 Hand, scharf
 for the left
 hand, sharp
 para la mano
 izquierda, aguda
 pour la main
 gauche, pointue
 per la mano
 sinistra, acuto

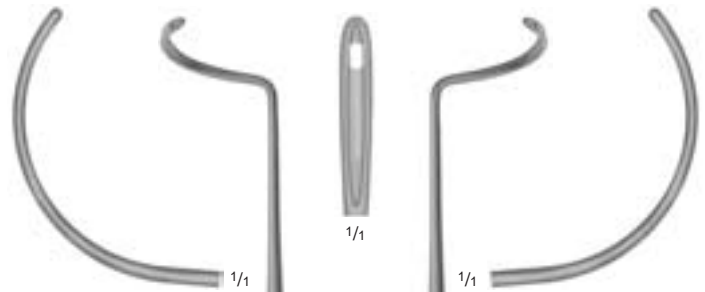

DESCHAMPS
 08-0465
 24 cm, 9 1/2"

für die rechte
 Hand, stumpf
 for the right
 hand, blunt
 para la mano
 derecha, roma
 pour la main
 droite, mousse
 per la mano
 destra, smusso

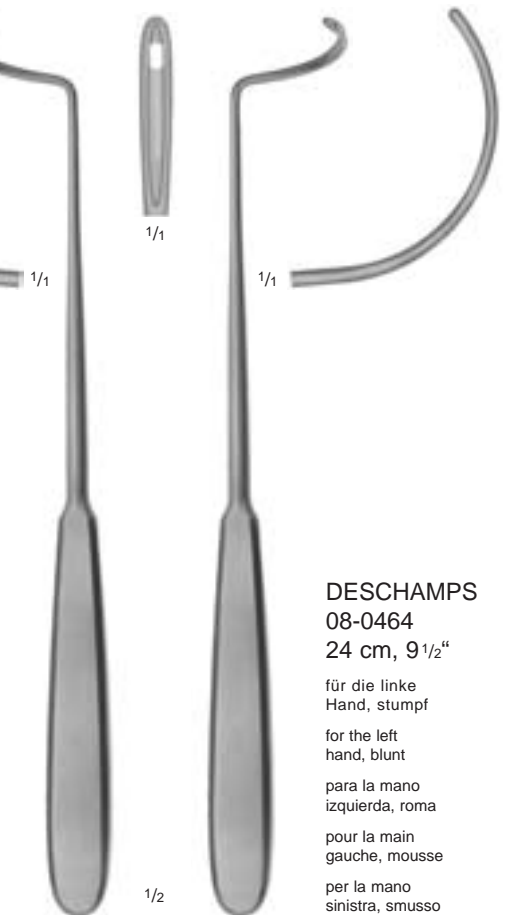

DESCHAMPS
 08-0464
 24 cm, 9 1/2"

für die linke
 Hand, stumpf
 for the left
 hand, blunt
 para la mano
 izquierda, roma
 pour la main
 gauche, mousse
 per la mano
 sinistra, smusso

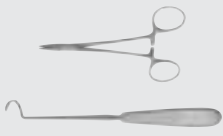

Unterbindungsadeln
Ligature Needles
Agujas para ligaduras
Aiguilles à ligatures
Aghi per legatura

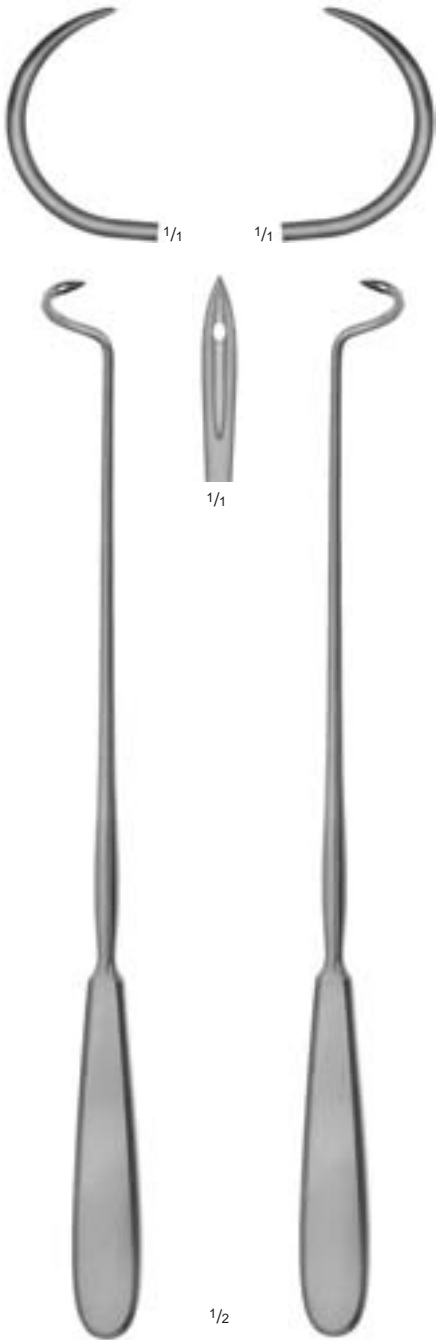

DESCHAMPS
08-0477
28 cm, 11"

für die rechte
Hand, scharf

for the right
hand, sharp

para la mano
derecha, aguda

pour la main
droite, pointue

per la mano
destra, acuto

DESCHAMPS
08-0476
28 cm, 11"

für die linke
Hand, scharf

for the left
hand, sharp

para la mano
izquierda, aguda

pour la main
gauche, pointue

per la mano
sinistra, acuto

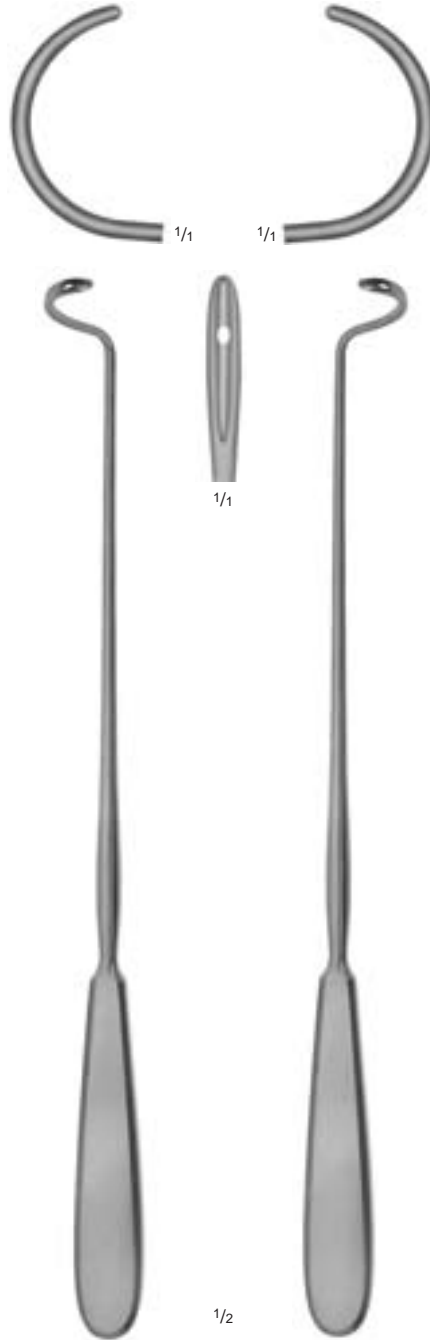

DESCHAMPS
08-0479
28 cm, 11"

für die rechte
Hand, stumpf

for the right
hand, blunt

para la mano
derecha, roma

pour la main
droite, mousse

per la mano
destra, smusso

DESCHAMPS
08-0478
28 cm, 11"

für die linke
Hand, stumpf

for the left
hand, blunt

para la mano
izquierda, roma

pour la main
gauche, mousse

per la mano
sinistra, smusso

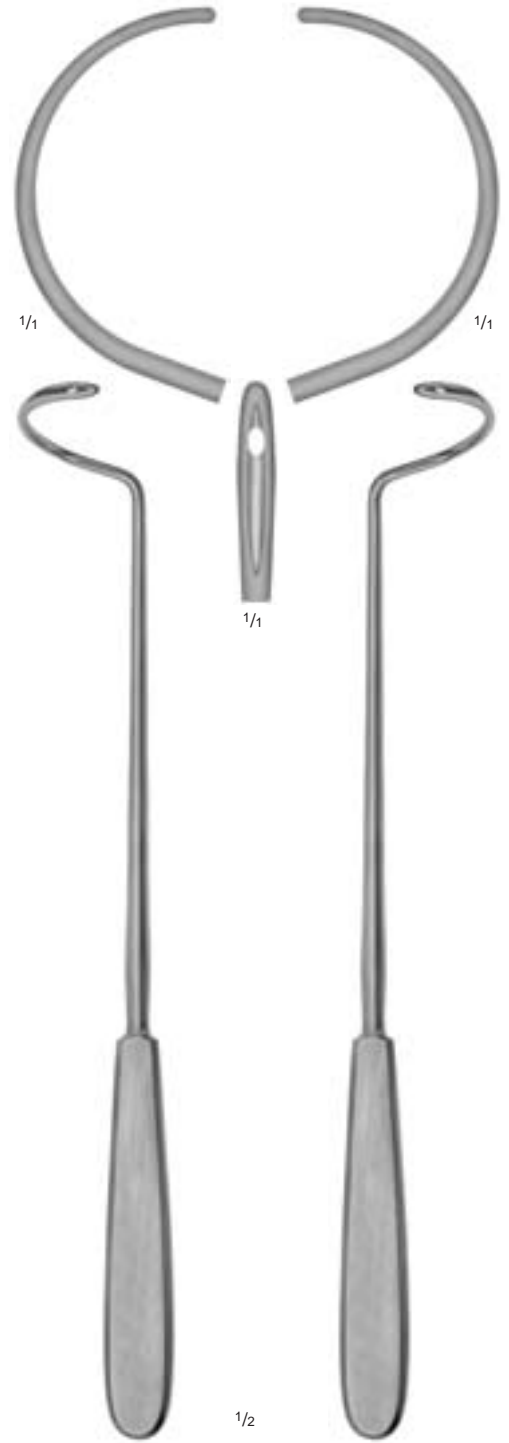

DESCHAMPS
08-0463
28 cm, 11"

für die rechte
Hand, stumpf

for the right
hand, blunt

para la mano
derecha, roma

pour la main
droite, mousse

per la mano
destra, smusso

DESCHAMPS
08-0462
28 cm, 11"

für die linke
Hand, stumpf

for the left
hand, blunt

para la mano
izquierda, roma

pour la main
gauche, mousse

per la mano
sinistra, smusso

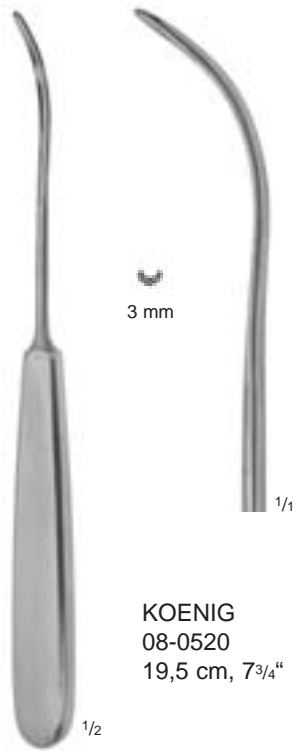
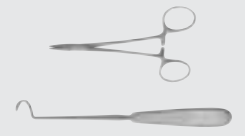

KOENIG
 08-0520
 19,5 cm, 7³/₄"

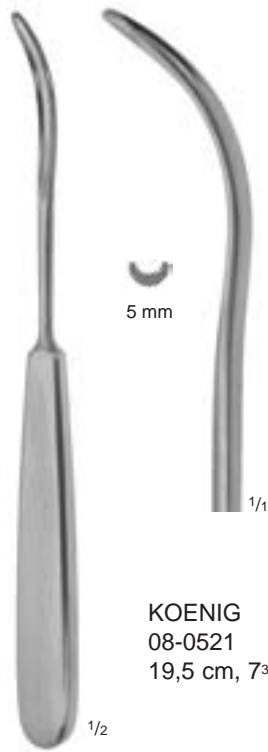

KOENIG
 08-0521
 19,5 cm, 7³/₄"

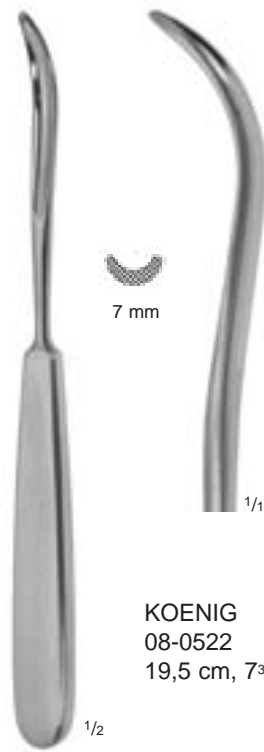

KOENIG
 08-0522
 19,5 cm, 7³/₄"



KIRSCHNER
 08-0548
 25,5 cm, 10"

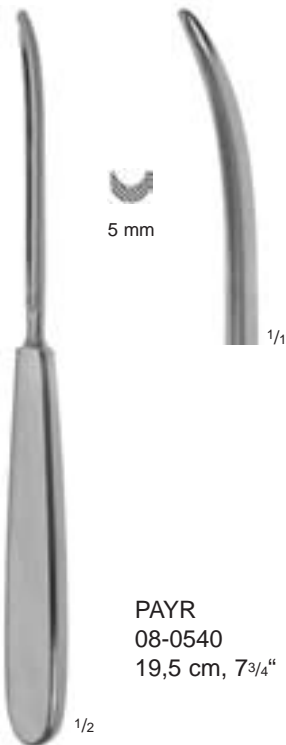

PAYR
 08-0540
 19,5 cm, 7³/₄"

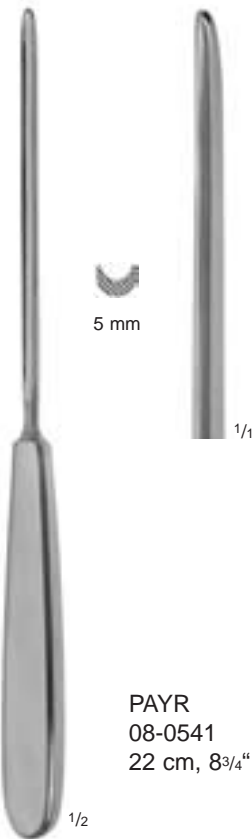

PAYR
 08-0541
 22 cm, 8³/₄"

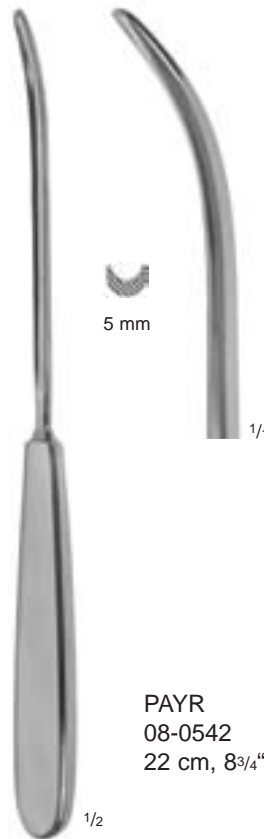

PAYR
 08-0542
 22 cm, 8³/₄"

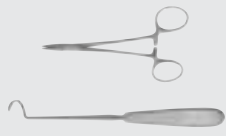

Führungshohlsonden
Ligature Conductors
Sondas conductoras
Spatules conductrices
Sonda conduttrici

Nahtinstrumente
Suture Instruments
Instrumentos para sutura
Instruments à suture
Strumenti per sutura

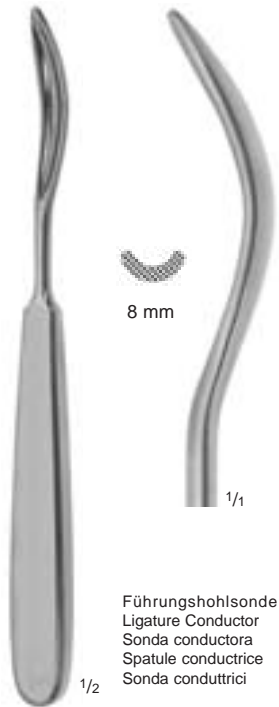

8 mm

1/1

Führungshohlsonde
Ligature Conductor
Sonda conductora
Spatule conductrice
Sonda conduttrici

SCHMIEDEN
08-0525
18,5 cm, 7 1/4"

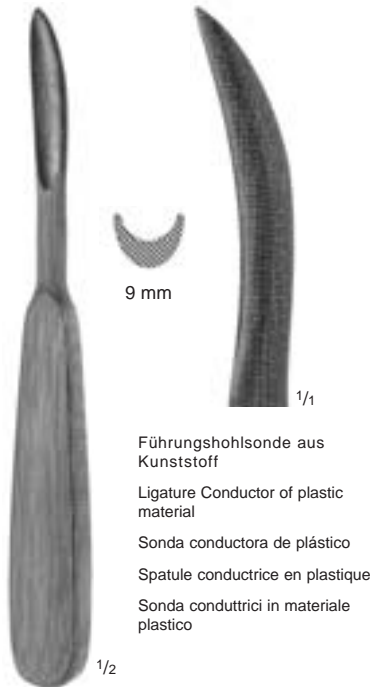

9 mm

1/1

Führungshohlsonde aus
Kunststoff
Ligature Conductor of plastic
material
Sonda conductora de plástico
Spatule conductrice en plastique
Sonda conduttrici in materiale
plastico

08-0552
18 cm, 7"

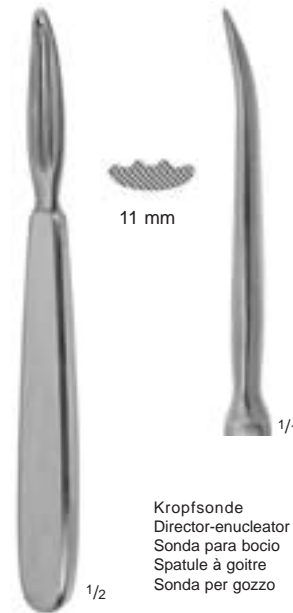

11 mm

1/1

Kropfsonde
Director-enucleator
Sonda para bocio
Spatule à goitre
Sonda per gozzo

KOCHER
12-0200
16 cm, 6 1/4"



12 mm

1/1

Kropfsonde
Director-enucleator
Sonda para bocio
Spatule à goitre
Sonda per gozzo

KOCHER
12-0201
17 cm, 6 3/4"



CHILDE
08-0772
17 cm, 6 3/4"

Wundnahtpinzette
ohne Klammerhalter
Approximation forceps
without clip holder

Pinza aproximadora
sin porta-clips

Pince à affronter sans
porte agrafes

Pinza senza porta clips

1/2



CHILDE
08-0775
17 cm, 6 3/4"

Wundnahtpinzette
mit Klammerhalter
Approximation forceps
with clip holder

Pinza aproximadora
con porta-clips

Pince à affronter avec
porte agrafes

Pinza con porta clips

1/2

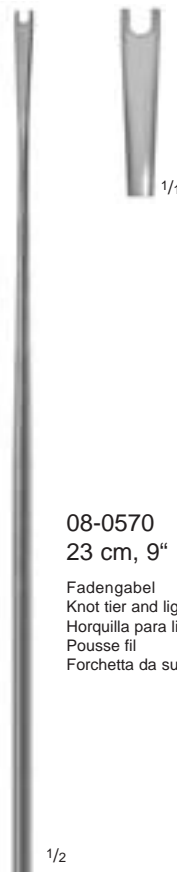

1/1

08-0570
23 cm, 9"

Fadengabel
Knot tier and ligature adjuster
Horquilla para ligadura
Pousse fil
Forchetta da sutura

1/2



1/1

WIENER MOD.
08-0572
23,5 cm, 9 1/4"

Fadenfänger
Suture catcher
Porta ligadura
Porte-ligature
Portalegature

1/2

Wundklammern
Suture Clips
Agrafes (Grapas)
Agrafes
Agrafes

Klammeranlege- und Entfernungsanzgen
Clip Applying and Removing Forceps
Pinzas para poner y quitar agrafes
Pincas à poser et retirer les agrafes
Pinze metti e togli clips

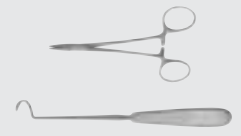

	08-0611	11 x 2,0 mm
	08-0612	12 x 2,5 mm
	08-0614	14 x 3,0 mm
	08-0616	16 x 3,0 mm
	08-0618	18 x 3,0 mm
	08-0620	20 x 3,0 mm
	08-0622	22 x 3,0 mm

MICHEL
08-0611
- 08-0622

Wundklammern aus nichtrostendem Stahl, in Packungen zu 100 Stück
Suture clips of stainless steel, in packages of 100 pieces
Agrafes (grapas) de acero inoxidable, paquete de 100 piezas
Agrafes acier inoxydable, paquet de 100
Agrafes clips da sutura in acciaio inox in conf. 100 pz.



MICHEL
08-0600
12 cm, 4³/₄"

Klammeranlegepinzette
Clip applying forceps
Pinza para poner agrafes
Pince à poser les agrafes
Pinza per mettere clips



HEGENBARTH
08-0605
12 cm, 4³/₄"

Klammeranlegepinzette
Clip applying forceps
Pinza para poner agrafes
Pince à poser les agrafes
Pinza per mettere clips



MICHEL
08-0610
12,5 cm, 5"

Klammeranlege- und Entfernungsanzge
Clip applying and removing forceps
Pinza para poner y quitar agrafes
Pince à poser et retirer les agrafes
Pinca per mettere e togliere clips



COLLIN
08-0652
13,5 cm, 5¹/₄"

Klammerentfernungsanzge
Clip removing forceps
Pinza para quitar agrafes
Pince à retirer les agrafes
Pinca per togliere clips



RICHTER-HEATH
08-0650
13,5 cm, 5¹/₄"

Klammerentfernungsanzge
Clip removing forceps
Pinza para quitar agrafes
Pince à retirer les agrafes
Pinca per togliere clips

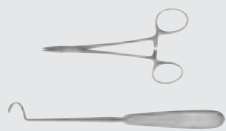

Wundnahtbesteck
Suturing Instrument Set
Estuche para sutura
Necessaire à sutures
Set per sutura



1/3

08-0910

Wundnahtbesteck, komplett, bestehend aus:

- 04-1023 3 Sterile Skalpellklingen Fig. 23
- 04-1055 1 Skalpellgriff No. 4
- 05-0111 1 Schere, spitz/stumpf, gerade, 13 cm, 5¹/₈"
- 09-0040 1 SEMKEN Anatomische Pinzette 12 cm, 4³/₄"
- 08-1670 1 Nähseide No. 1, gedreht, Strang zu 0,5 g., steril, im Glasflacon
- 08-1212 1 Chirurgische Nähnaedel B, Fig. 12
- 08-1231 1 Chirurgische Nähnaedel G, Fig. 11
- 08-1235 1 Chirurgische Nähnaedel G, Fig. 15
- 08-1660 1 Nadel-Sterilisierdose 50 x 25 x 4,5 mm
- 08-0337 1 MATHIEU Nadelhalter 14 cm, 5¹/₂"
- 08-0610 1 MICHEL Klammeranlege- und Entfernungszange 12,5 cm, 5"
- 08-0616 25 MICHEL Wundklammern 16 x 3 mm
- 08-1632 1 Metall-Etui 165 x 90 x 23 mm

Suturing instrument set, complete, consisting of:

- 04-1023 3 Sterile scalpel blades No. 23
- 04-1055 1 Scalpel handle No. 4
- 05-0111 1 Scissors, blunt/sharp, straight, 13 cm, 5¹/₈"
- 09-0040 1 SEMKEN Dissecting forceps, 12 cm, 4³/₄"
- 08-1670 1 Suture silk No. 1, twisted, hank of 0.5 gramme, sterilized, in glass flacon
- 08-1212 1 Surgical suture needle B, fig. 12
- 08-1231 1 Surgical suture needle G, fig. 11
- 08-1235 1 Surgical suture needle G, fig. 15
- 08-1660 1 Needle sterilizing box, 50 x 25 x 4.5 mm
- 08-0337 1 MATHIEU Needle holder, 14 cm, 5¹/₂"
- 08-0610 1 MICHEL Clip applying and removing forceps, 12.5 cm, 5"
- 08-0616 25 MICHEL Suture clips, 16 x 3 mm
- 08-1632 1 Metal case, 165 x 90 x 23 mm

Estuche para sutura, completo, compuesto de:

- 04-1023 3 Hojas de bisturíes núm. 23, estériles
- 04-1055 1 Mango de bisturí núm. 4
- 05-0111 1 Tijera, roma/aguda, recta, 13 cm, 5¹/₈"
- 09-0040 1 Pinza de disección de SEMKEN, 12 cm, 4³/₄"
- 08-1670 1 Seda para sutura, núm. 1, hilado, madeja de 0,5 gr., estéril, en frasquito de vidrio
- 08-1212 1 Aguja para sutura cirugía B, núm. 12
- 08-1231 1 Aguja para sutura cirugía G, núm. 11
- 08-1235 1 Aguja para sutura cirugía G, núm. 15
- 08-1660 1 Estuche para esterilizar agujas, 50 x 25 x 4,5 mm
- 08-0337 1 Porta-agujas de MATHIEU, 14 cm, 5¹/₂"
- 08-0610 1 Pinza para poner y quitar agrafes de MICHEL, 12,5 cm, 5"
- 08-0616 25 Agrafes (grapas) de MICHEL, 16 x 3 mm
- 08-1632 1 Estuche de metal, 165 x 90 x 23 mm

Necessaire à suture, complet, composé de:

- 04-1023 3 Paquets de lames No. 23
- 04-1055 1 Manche No. 4
- 05-0111 1 Ciseaux, pointu/mousse, droits, 13 cm, 5¹/₈"
- 09-0040 1 Pince à dissection de SEMKEN, 12 cm, 4³/₄"
- 08-1670 1 Soie à suture No.1, torsadée, fil de 0,5 g, stérile en flacon verre
- 08-1212 1 Aiguilles à sutures B, fig. 12
- 08-1231 1 Aiguilles à sutures G, fig. 11
- 08-1235 1 Aiguilles à sutures G, fig. 15
- 08-1660 1 Boîte à stériliser les aiguilles, 50 x 25 x 4,5 mm
- 08-0337 1 Porte-aiguille de MATHIEU, 14 cm, 5¹/₂"
- 08-0610 1 Pince à poser et retirer les agrafes de MICHEL, 12,5 cm, 5"
- 08-0616 25 Agrafes de MICHEL, 16 x 3 mm
- 08-1632 1 Boîte métal, 165 x 90 x 23 mm

Set per sutura, completo, composto da:

- 04-1023 3 lame per bisturi fig. 23
- 04-1055 1 Bisturi a lame No. 4
- 05-0111 1 Forbice, acuta/smussa, retta, 13 cm, 5¹/₈"
- 09-0040 1 Pinza anatomica SEMKEN, 12 cm, 4³/₄"
- 08-1670 1 Seta intrecciata, No. 1, 0,5 g, sterilizzabile in flacon vetro
- 08-1212 1 Ago chirurgica per sutura B, fig. 12
- 08-1231 1 Ago chirurgica per sutura G, fig. 11
- 08-1235 1 Ago chirurgica per sutura G, fig. 15
- 08-1660 1 Scatola per sterilizzazione per aghi, 50 x 25 x 4,5 mm
- 08-0337 1 Portaghi MATHIEU, 14 cm, 5¹/₂"
- 08-0610 1 Pinza MICHEL per mettere e togliere clips, 12,5 cm, 5"
- 08-0616 25 Agrafes MICHEL, 16 x 3 mm
- 08-1632 1 Scatola metallica, 165 x 90 x 23 mm

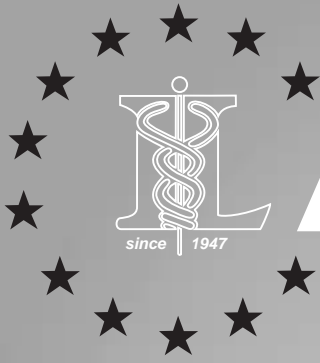

LAWNTON

Medizintechnik



Darm, Magen, Mastdarm
Intestines, Stomach, Rectum
Intestino, Estómago, Recto
Intestins, Estomac, Rectum
Intestino, Stomaco, Retto



Instrumente für Darm, Magen und Mastdarm
 Instruments for Intestines, Stomach and Rectum
 Instrumentos para intestino, estómago y recto
 Instruments pour intestin, estomac, rectum
 Strumenti per intestino, stomaco, retto



Darm- und Gewebefaßzangen	Seite	23
Intestinal and Tissue Grasping Forceps	Page	23
Pinzas intestinales y para tejidos	Página	23
Pinces à préhension de l'intestin	Page	23
Pinze da presa per intestino e tessuti	Pagina	23



Rektumscheren	Seite	59, 99
Rectal Scissors	Page	59, 99
Tijeras rectales	Página	59, 99
Ciseaux pour rectum	Page	59, 99
Forbici per retto	Pagina	59, 99



Darm- und Gewebefaßpinzetten	Seite	115, 135, 148 - 149
Intestinal and Tissue Grasping Forceps	Page	115, 135, 148 - 149
Pinzas intestinales y para tejidos	Página	115, 135, 148 - 149
Pinces à préhension de l'intestin	Page	115, 135, 148 - 149
Pinze anatomiche da presa per intestino e tessuti	Pagina	115, 135, 148 - 149



Pelvishaken	Seite	256 - 258
Pelvis Retractors	Page	256 - 258
Separadores para pelvis	Página	256 - 258
Ecarteurs à pelviens	Page	256 - 258
Divaricatori per pelvi	Pagina	256 - 258



Appendektomie-Wundspreizer	Seite	284
Appendectomy Retractors	Page	284
Separadores para apendectomía	Página	284
Ecarteurs pour appendectomie	Page	284
Divaricatori per appendicectomia	Pagina	284



Analsonden	Seite	314
Rectal Probes	Page	314
Sondas para el recto	Página	314
Sondes rectales	Page	314
Sonde rettali	Pagina	314

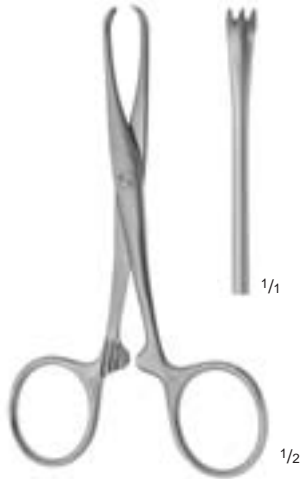

CHAPUT
 10-0102
 12,5 cm, 5"

2x3 Zähne
 2x3 teeth
 2x3 dientes
 2x3 dents
 2x3 denti

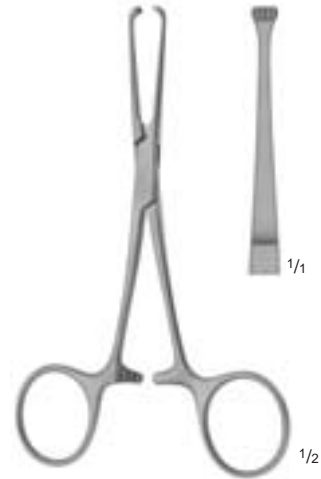

BABY-ALLIS
 10-0106
 12 cm, 4 3/4"

4x5 Zähne
 4x5 teeth
 4x5 dientes
 4x5 dents
 4x5 denti

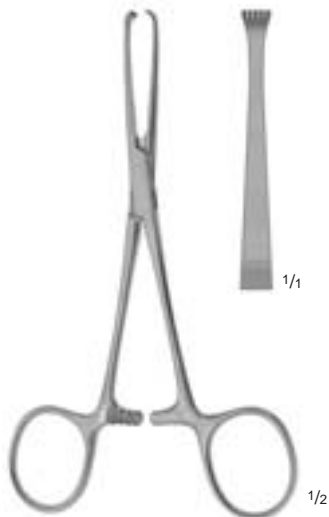

OCHSNER-ALLIS
 10-0105
 13,5 cm, 5 1/4"

4x5 Zähne
 4x5 teeth
 4x5 dientes
 4x5 dents
 4x5 denti

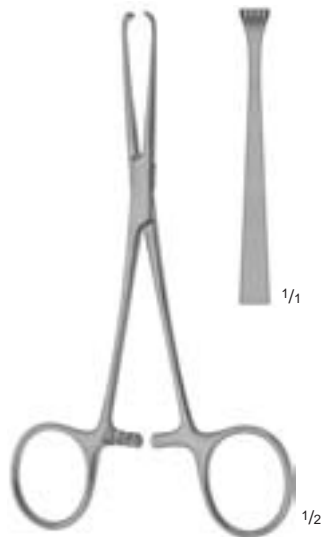

BABY-ALLIS
 10-0127
 14 cm, 5 1/2"

4x5 Zähne
 4x5 teeth
 4x5 dientes
 4x5 dents
 4x5 denti

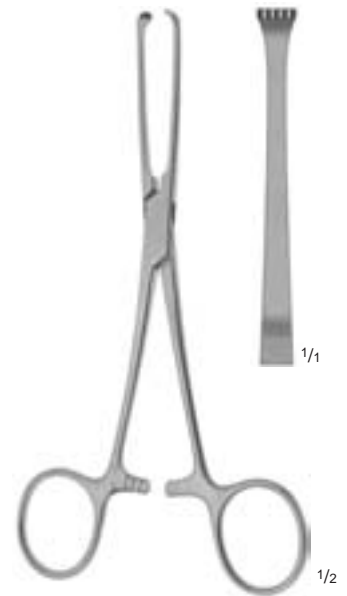

ALLIS
 10-0120
 15,5 cm, 6"

4x5 Zähne
 4x5 teeth
 4x5 dientes
 4x5 dents
 4x5 denti



Darm- und Gewebefaßzangen
Intestinal and Tissue Grasping Forceps
Pinzas intestinales y para tejidos
Pinces à préhension de l'intestin
Pinze da presa per intestino e tessuti

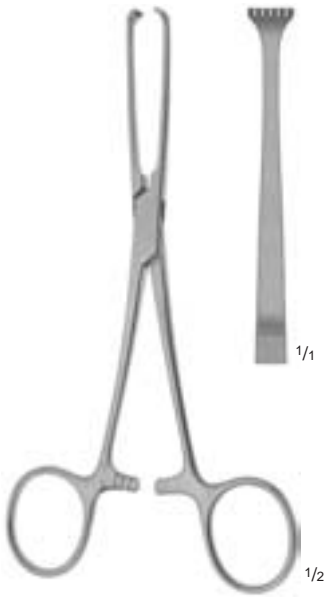

ALLIS
10-0125
15,5 cm, 6"

5x6 Zähne
5x6 teeth
5x6 dientes
5x6 dents
5x6 denti

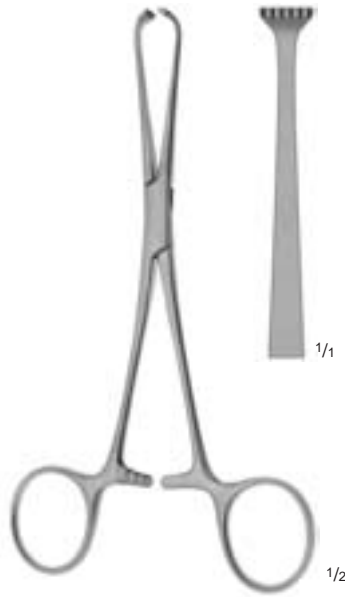

BOYS-ALLIS
10-0166
15,5 cm, 6"

5x6 Zähne
5x6 teeth
5x6 dientes
5x6 dents
5x6 denti

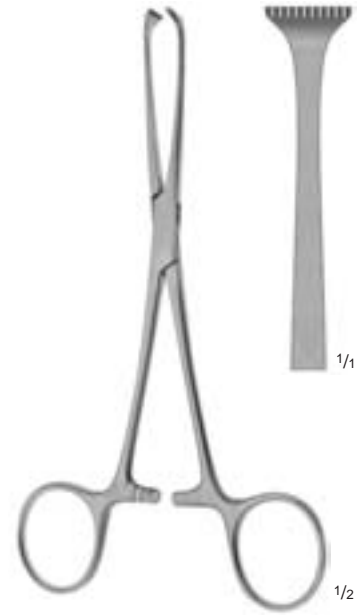

ADAIR-ALLIS
10-0140
16 cm, 6 1/4"

10x11 Zähne
10x11 teeth
10x11 dientes
10x11 dents
10x11 denti

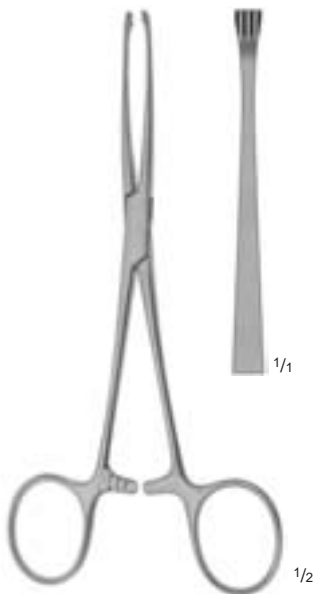

JUDD-ALLIS
10-0110
15,5 cm, 6"

3x4 Zähne
3x4 teeth
3x4 dientes
3x4 dents
3x4 denti

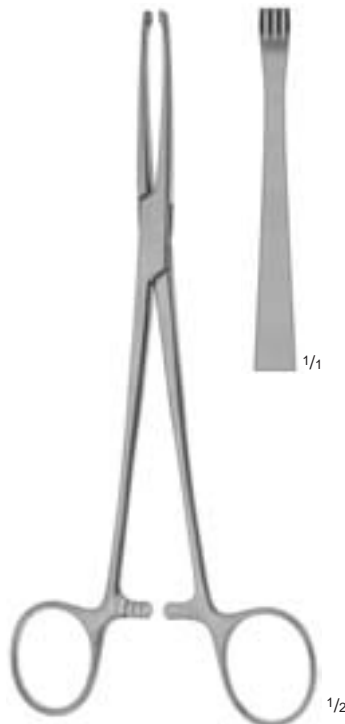

JUDD-ALLIS
10-0115
19 cm, 7 1/2"

3x4 Zähne
3x4 teeth
3x4 dientes
3x4 dents
3x4 denti

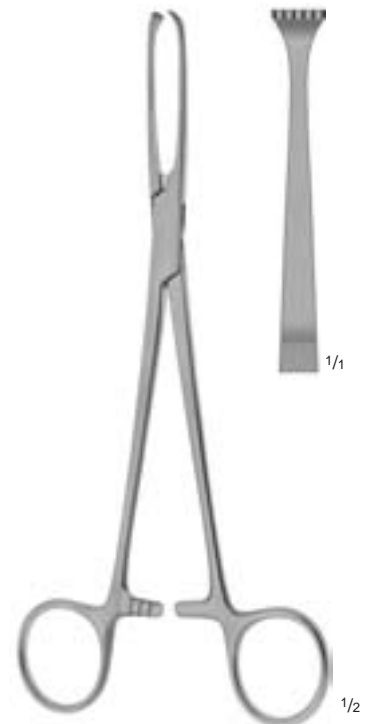

ALLIS
10-0130
19 cm, 7 1/2"

5x6 Zähne
5x6 teeth
5x6 dientes
5x6 dents
5x6 denti



8x9 Zähne
 8x9 teeth
 8x9 dientes
 8x9 dents
 8x9 denti

THOMS-ALLIS
 10-0135
 20,5 cm, 8"



5x6 Zähne
 5x6 teeth
 5x6 dientes
 5x6 dents
 5x6 denti

ALLIS
 10-0132
 22,5 cm, 9"



5x6 Zähne
 5x6 teeth
 5x6 dientes
 5x6 dents
 5x6 denti

ALLIS
 10-0138
 25 cm, 10"



BABCOCK
 10-0143
 - 10-0160



10-0143
 14,5 cm, 5 3/4"



▶ 10-0145
 16 cm, 6 1/4"



10-0150
 17 cm, 6 3/4"



10-0155
 20,5 cm, 8"



10-0160
 23,5 cm, 9 1/4"



Darm- und Gewebefaßzangen
Intestinal and Tissue Grasping Forceps
Pinzas intestinales y para tejidos
Pinces à préhension de l'intestin
Pinze da presa per intestino e tessuti

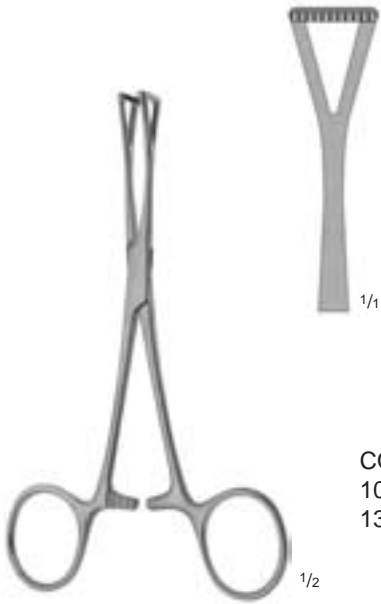

COLLIN
10-0193
13,5 cm, 5 1/4"

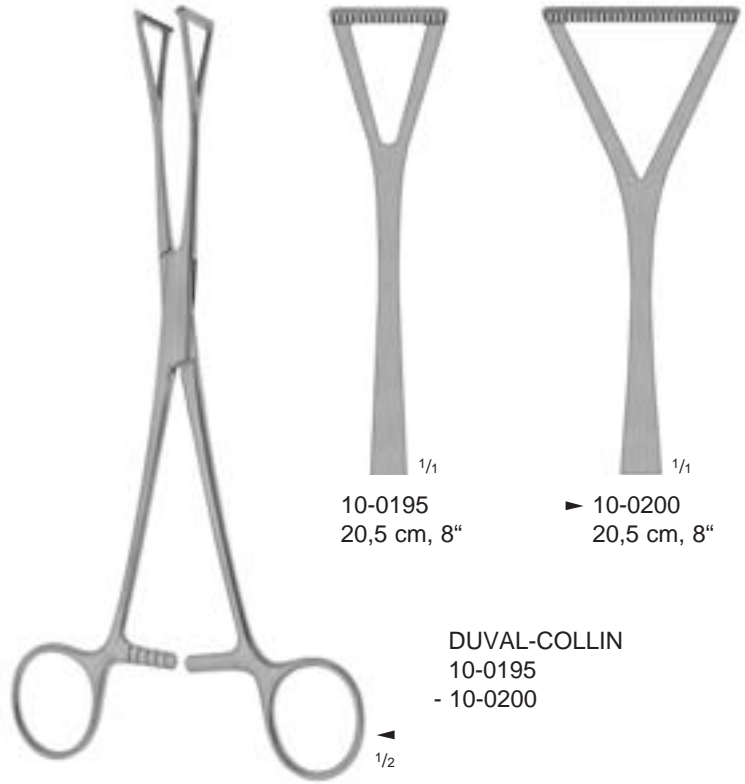

10-0195
20,5 cm, 8"

▶ 10-0200
20,5 cm, 8"

DUVAL-COLLIN
10-0195
- 10-0200

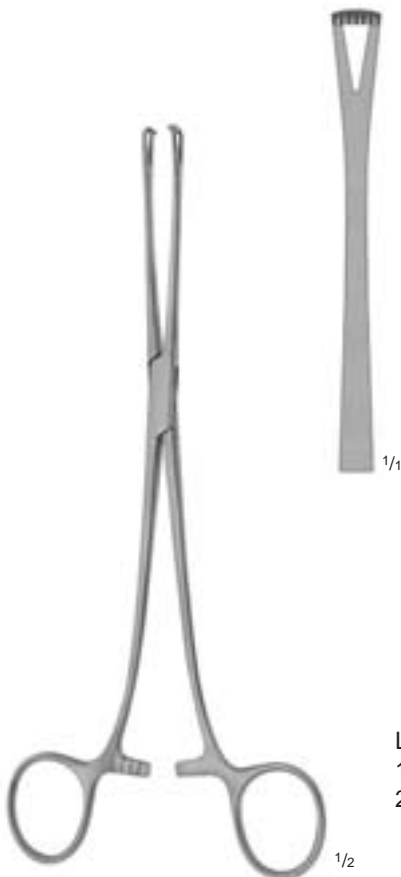

LOCKWOOD
10-0190
20 cm, 8"

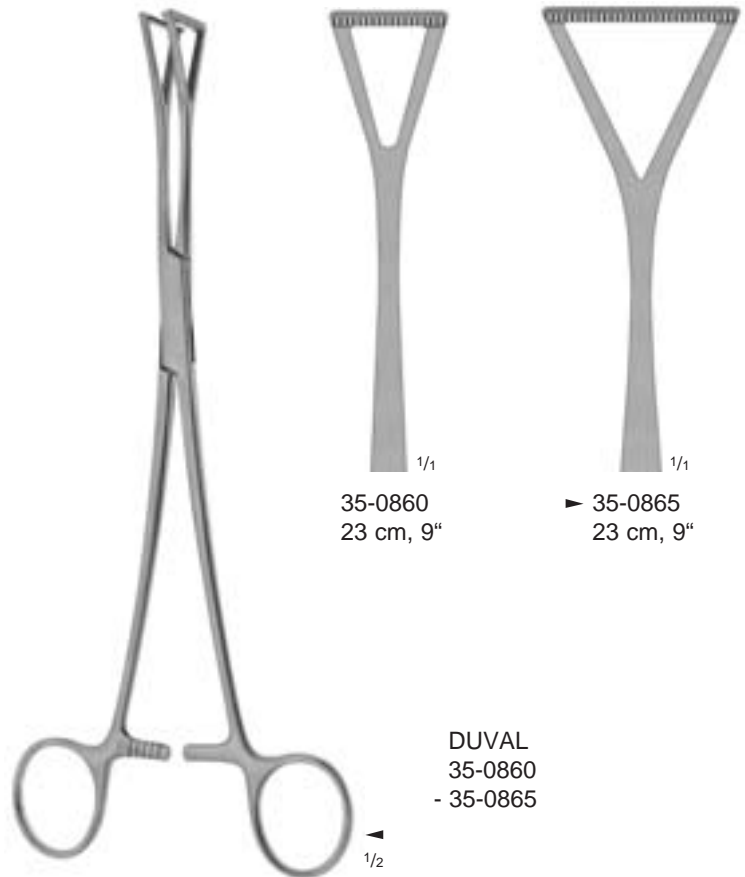

35-0860
23 cm, 9"

▶ 35-0865
23 cm, 9"

DUVAL
35-0860
- 35-0865



PENNINGTON
 06-0620
 15 cm, 6"

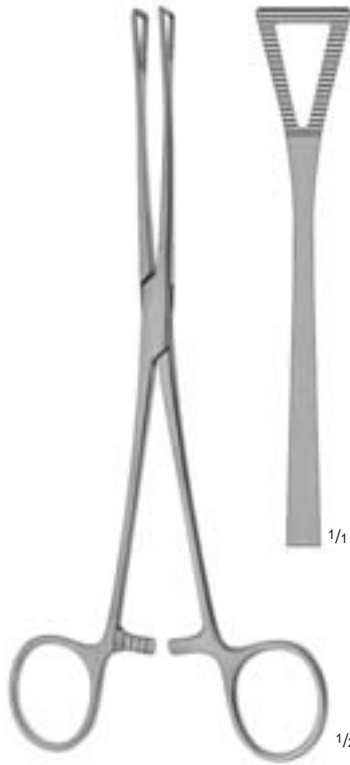

PENNINGTON
 35-0720
 20 cm, 8"

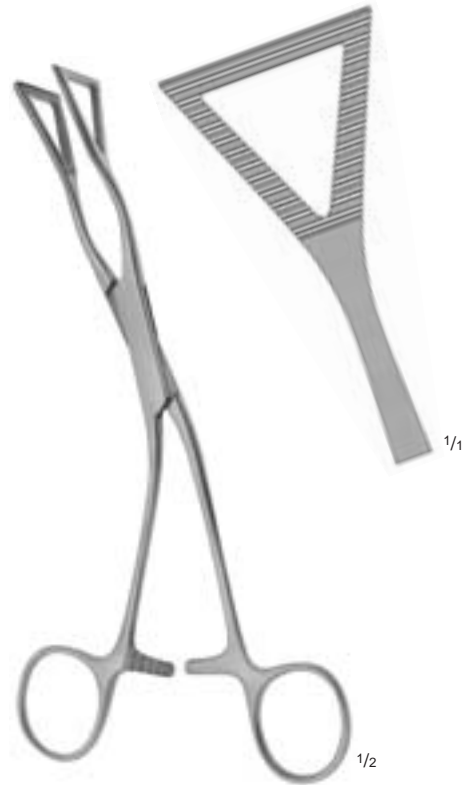

LOVELACE
 11-0480
 19 cm, 7 1/2"

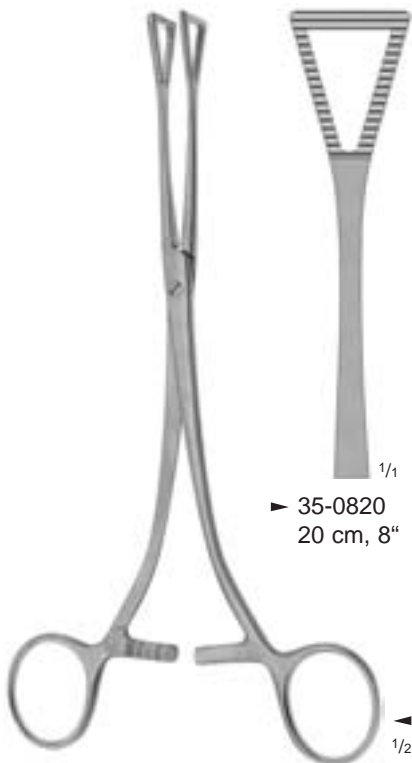

▶ 35-0820
 20 cm, 8"



35-0825
 20 cm, 8"

DUVAL
 35-0820
 - 35-0825

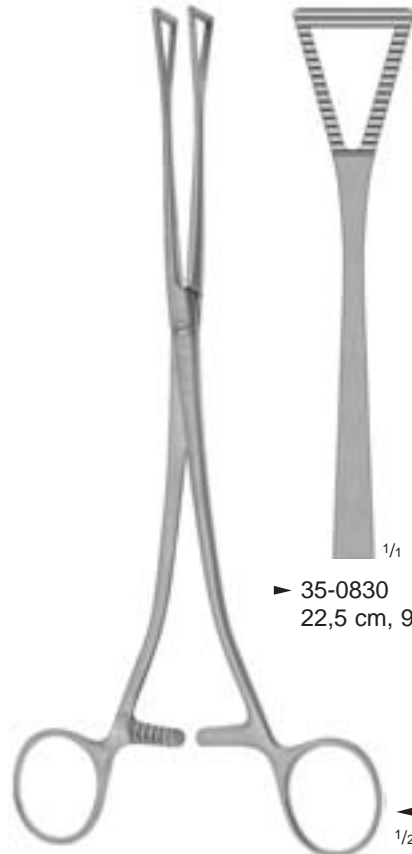

▶ 35-0830
 22,5 cm, 9"



35-0835
 22,5 cm, 9"

DUVAL
 35-0830
 - 35-0835



Darm- und Gewebefaßzangen
 Intestinal and Tissue Grasping Forceps
 Pinzas intestinales y para tejidos
 Pinces à préhension de l'intestin
 Pinze da presa per intestino e tessuti



WILLIAMS
 10-0170
 16 cm, 6 1/4"



DUVAL
 10-1195
 20,5 cm, 8"

mit Hartmetalleinlagen
 with tungsten carbide inserts
 con bocas de carburo tungsteno
 avec mors en tungstène
 con morsi in carburo di tungsteno



10-1146
 16 cm, 6 1/4"



10-1151
 17,5 cm, 7"



▶ 10-1156
 20,5 cm, 8"

BABCOCK
 10-1146
 - 10-1156

mit Hartmetalleinlagen
 with tungsten carbide inserts
 con bocas de carburo tungsteno
 avec mors en tungstène
 con morsi in carburo di tungsteno

ATRAUMATIC-GRIP Darm- und Gewebefaßzangen mit atraumatischer Riefung
 ATRAUMATIC-GRIP Intestinal and Tissue Grasping Forceps with non-traumatic serration
 ATRAUMATIC-GRIP Pinzas intestinales y para tejidos con bocas atraumáticas
 ATRAUMATIC-GRIP Pincès à préhension de l'intestin avec mors atraumatiques
 ATRAUMATIC-GRIP Pinze da presa per intestino e tessuti con presa atraumatica

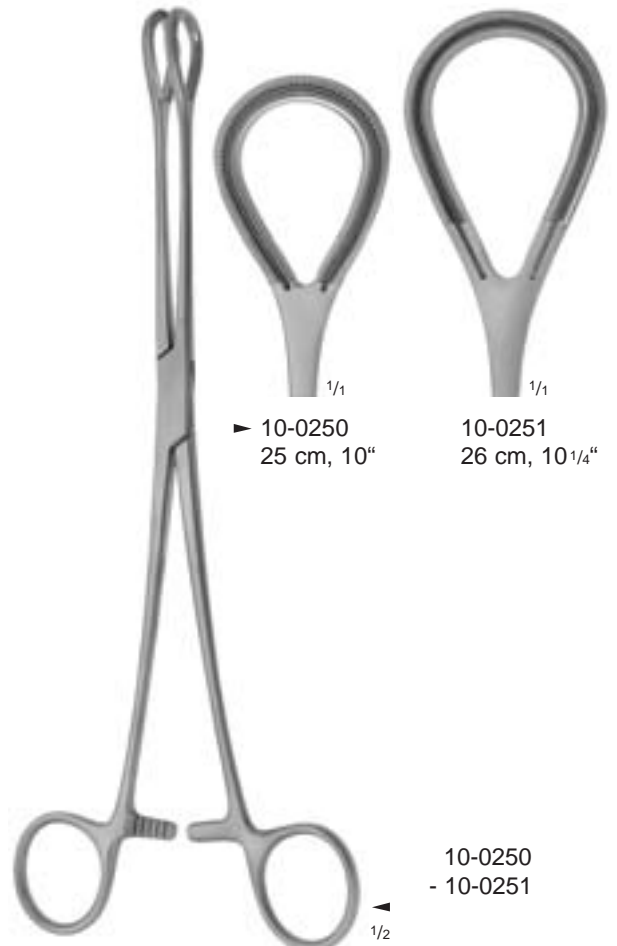
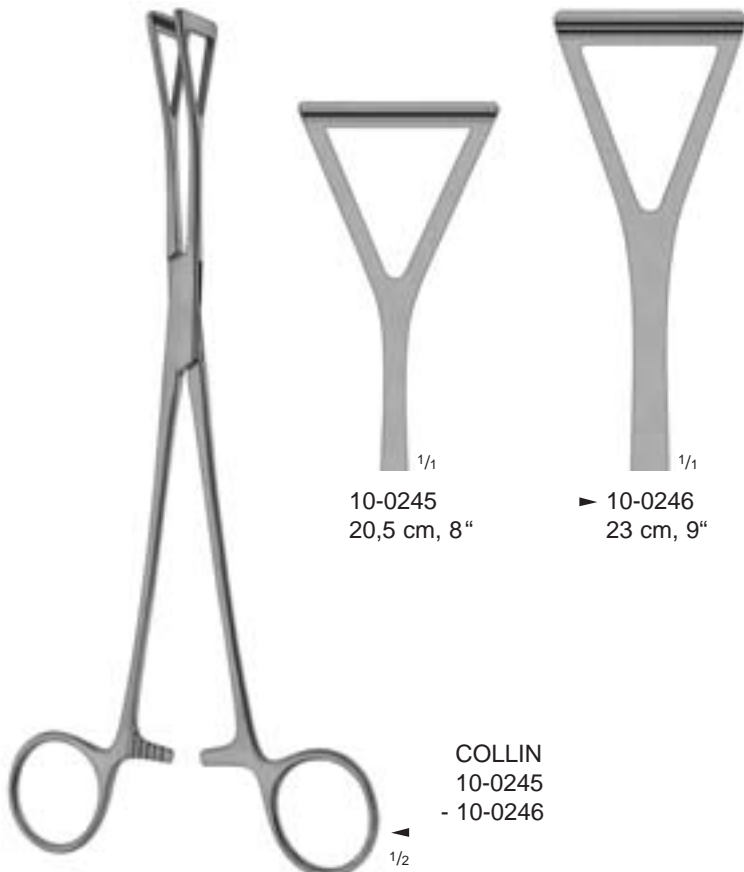
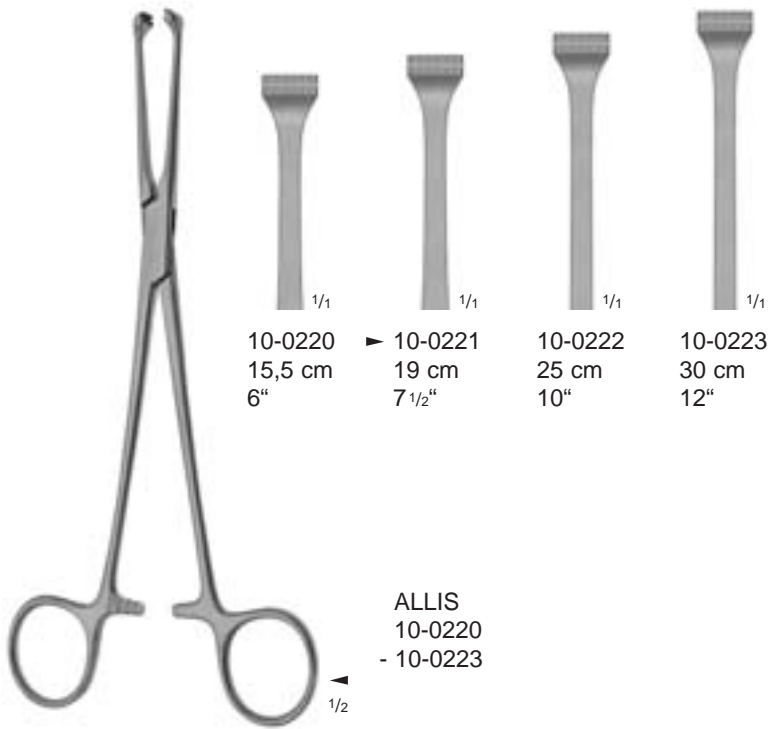



Darmklemmen
 Intestinal Clamp Forceps
 Pinzas-clamps intestinales
 Pincas-clamps intestinales
 Pinze intestinali

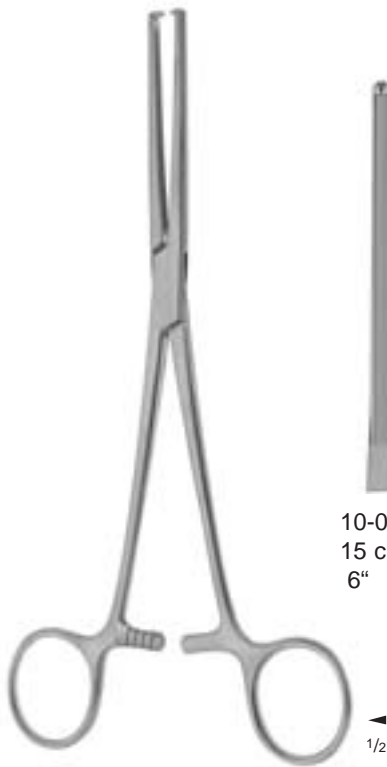

ALLEN
 10-0438
 - 10-0440
 1x2 Zähne
 1x2 teeth
 1x2 dientes
 1x2 dents
 1x2 denti

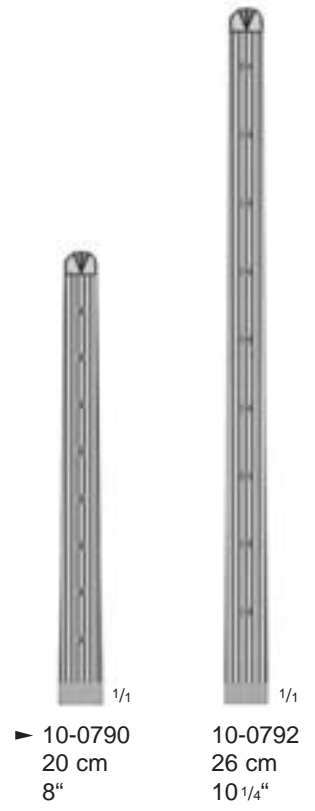

REDO
 10-0790
 - 10-0792
 1x2 Zähne
 1x2 teeth
 1x2 dientes
 1x2 dents
 1x2 denti

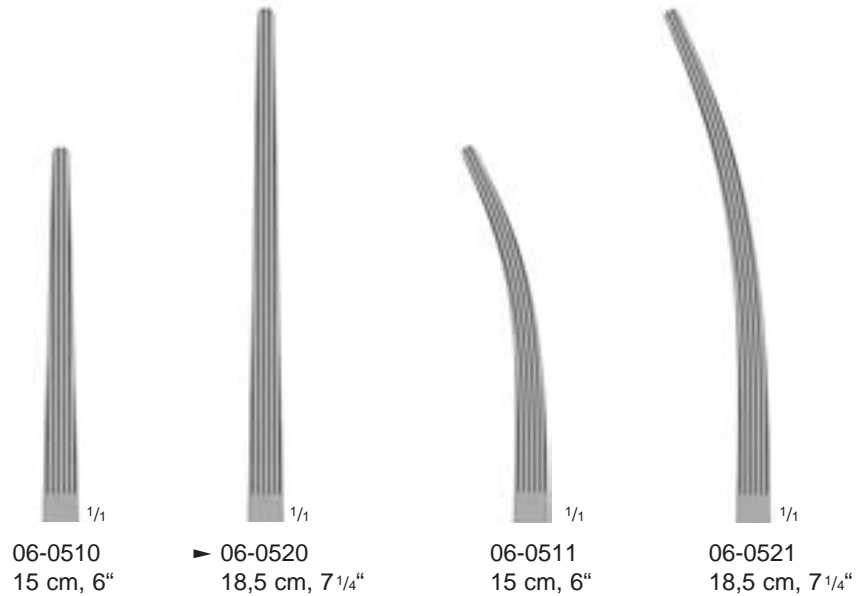

BAINBRIDGE
 06-0510
 - 06-0521

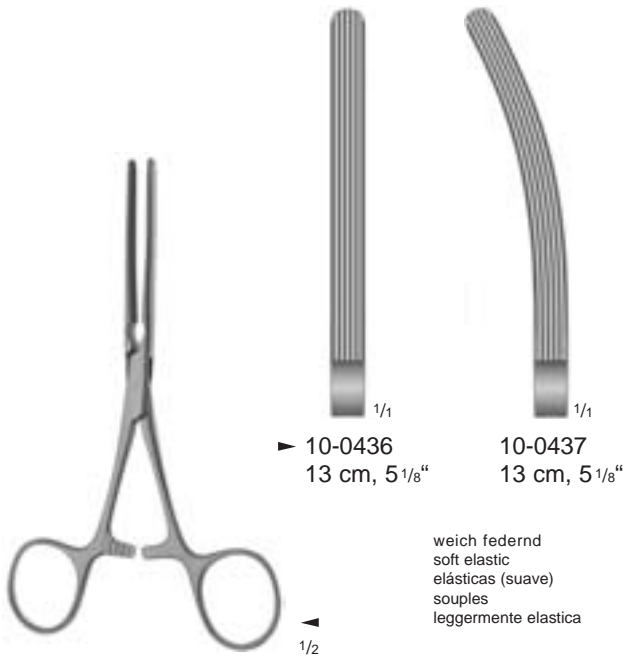

▶ 10-0436 13 cm, 5 1/8"
 10-0437 13 cm, 5 1/8"

weich federnd
 soft elastic
 elásticas (suave)
 souples
 leggermente elastica

BABY-KOCHER
 10-0436
 - 10-0437

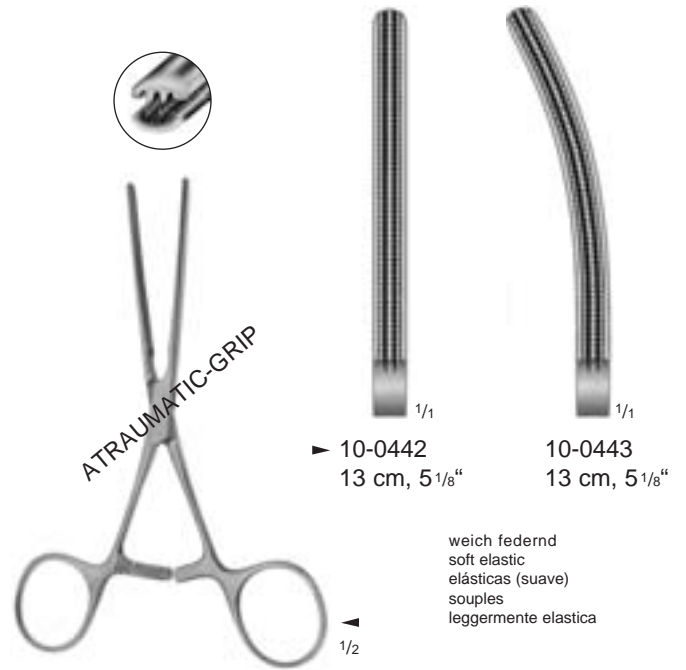

▶ 10-0442 13 cm, 5 1/8"
 10-0443 13 cm, 5 1/8"

weich federnd
 soft elastic
 elásticas (suave)
 souples
 leggermente elastica

BABY-KOCHER
 10-0442
 - 10-0443

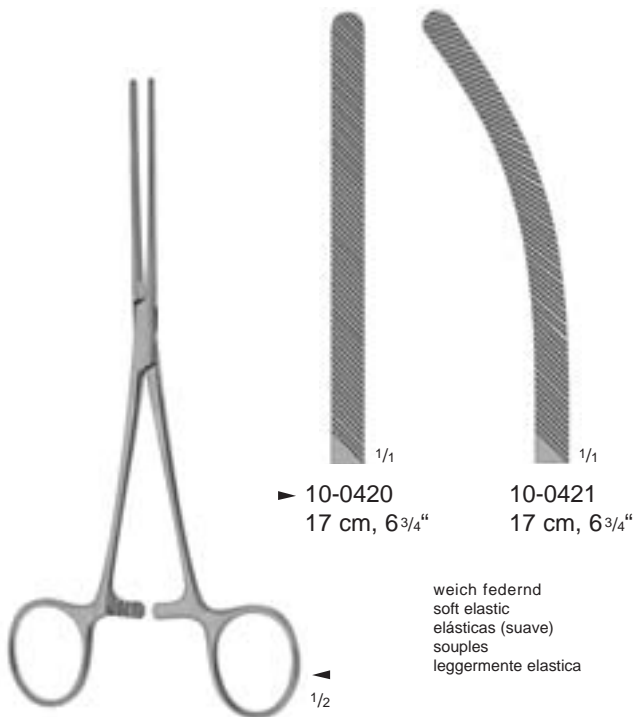

▶ 10-0420 17 cm, 6 3/4"
 10-0421 17 cm, 6 3/4"

weich federnd
 soft elastic
 elásticas (suave)
 souples
 leggermente elastica

BABY-DOYEN
 10-0420
 - 10-0421

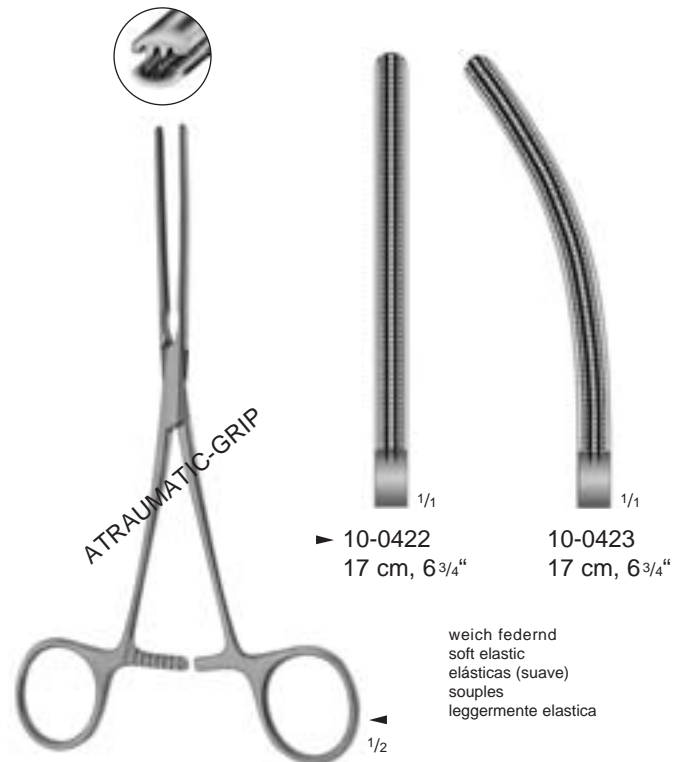

▶ 10-0422 17 cm, 6 3/4"
 10-0423 17 cm, 6 3/4"

weich federnd
 soft elastic
 elásticas (suave)
 souples
 leggermente elastica

BABY-DOYEN
 10-0422
 - 10-0423



Darmklemmen
 Intestinal Clamp Forceps
 Pinzas-clamps intestinales
 Pincas-clamps intestinales
 Pinze intestinali

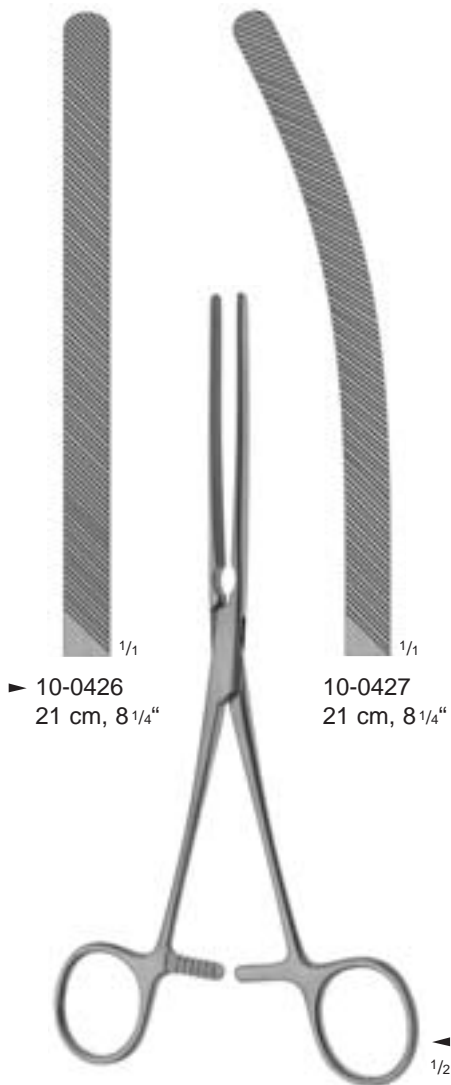

► 10-0426
21 cm, 8 1/4"

10-0427
21 cm, 8 1/4"

DOYEN
 10-0426
 - 10-0427

weich federnd
 soft elastic
 elásticas (suave)
 souples
 leggermente elastica

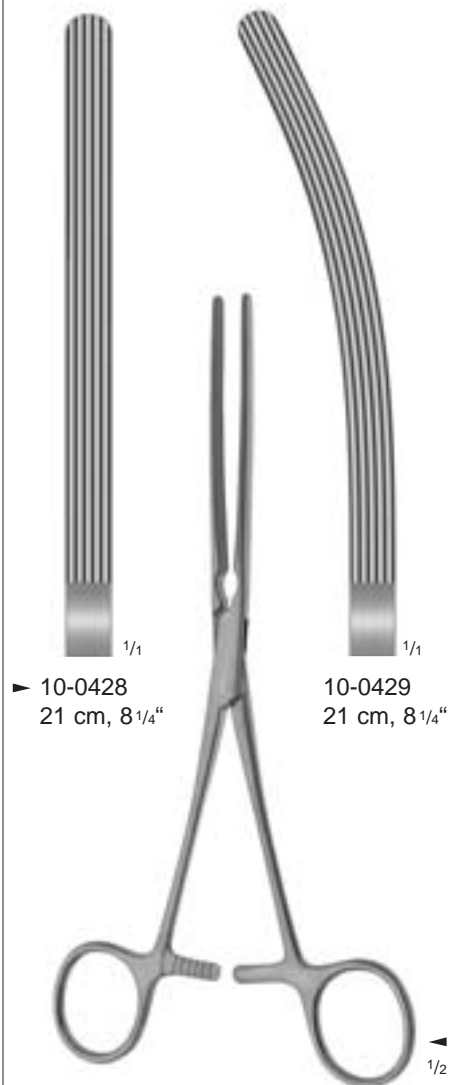

► 10-0428
21 cm, 8 1/4"

10-0429
21 cm, 8 1/4"

KOCHER
 10-0428
 - 10-0429

weich federnd
 soft elastic
 elásticas (suave)
 souples
 leggermente elastica

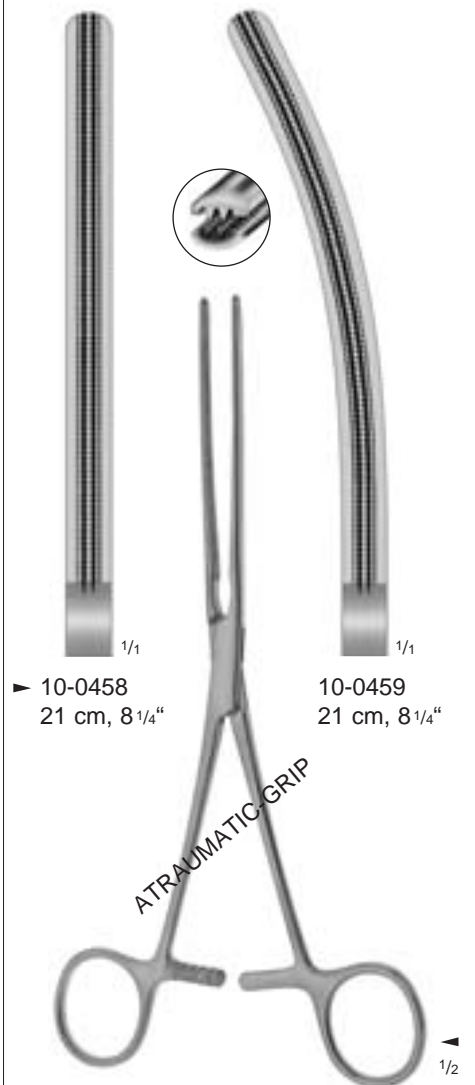

► 10-0458
21 cm, 8 1/4"

10-0459
21 cm, 8 1/4"

DOYEN
 10-0458
 - 10-0459

weich federnd
 soft elastic
 elásticas (suave)
 souples
 leggermente elastica

mit atraumatischer Riefung
 with non-traumatic serration
 con bocas atraumáticas
 avec mors atrauma
 con morsi atraumatici

ATRAUMATIC GRIP

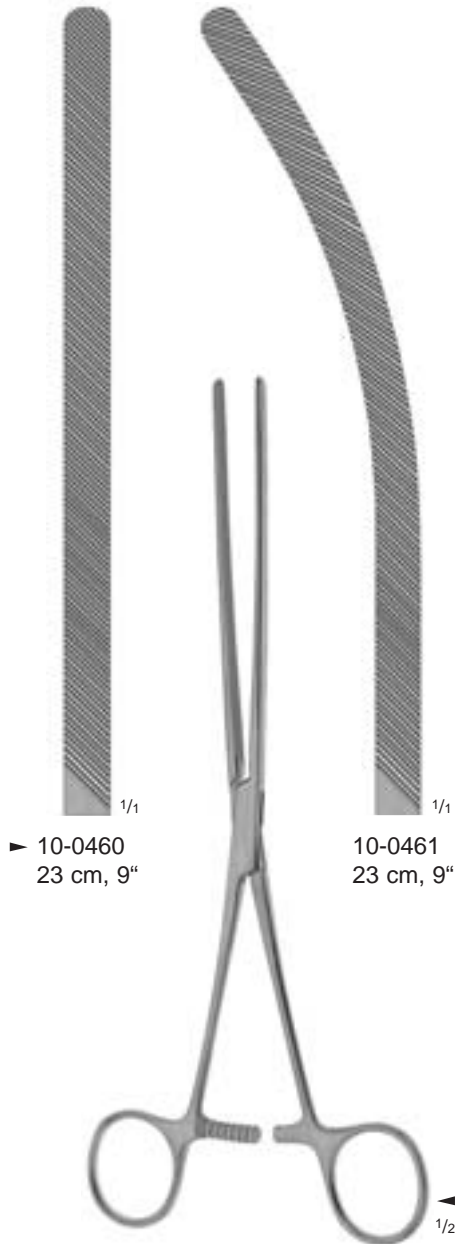

▶ 10-0460
23 cm, 9"

▶ 10-0461
23 cm, 9"

DOYEN
10-0460
- 10-0461

weich federnd
soft elastic
elásticas (suave)
souples
leggermente elastica

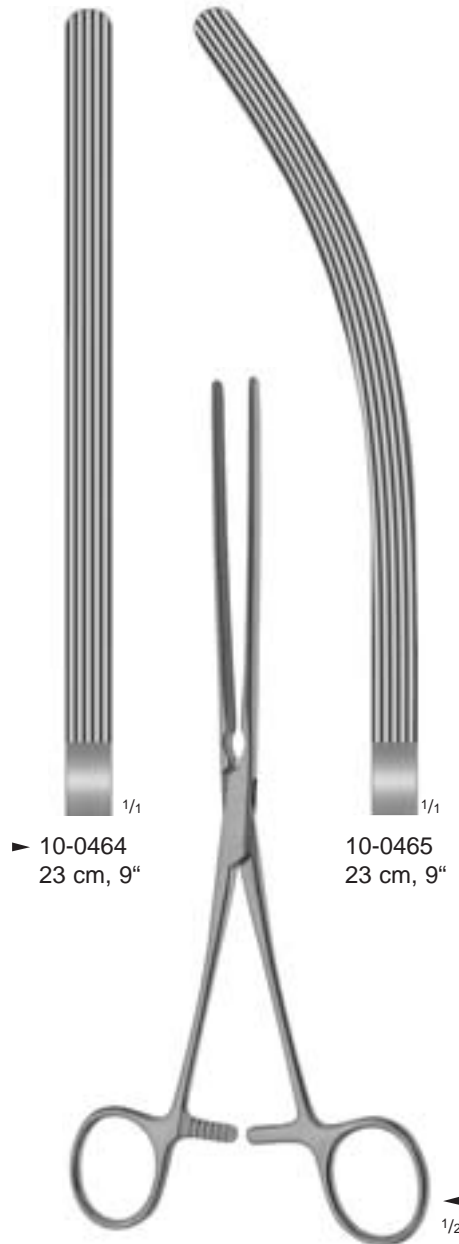

▶ 10-0464
23 cm, 9"

▶ 10-0465
23 cm, 9"

KOCHER
10-0464
- 10-0465

weich federnd
soft elastic
elásticas (suave)
souples
leggermente elastica

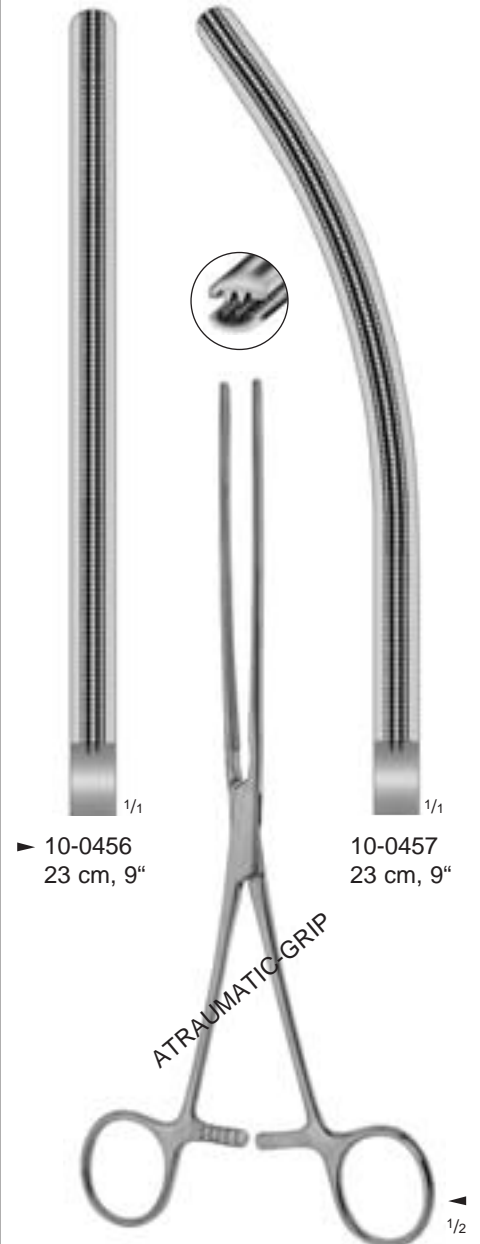

mit atraumatischer Riefung
with non-traumatic serration
con bocas atraumáticas
avec mors atrauma
con morsi atraumatici

▶ 10-0456
23 cm, 9"

▶ 10-0457
23 cm, 9"

ATRAUMATIC GRIP

DOYEN
10-0456
- 10-0457

weich federnd
soft elastic
elásticas (suave)
souples
leggermente elastica



Darmklemmen
Intestinal Clamp Forceps
Pinzas-clamps intestinales
Pinces-clamps intestinales
Pinze intestinali

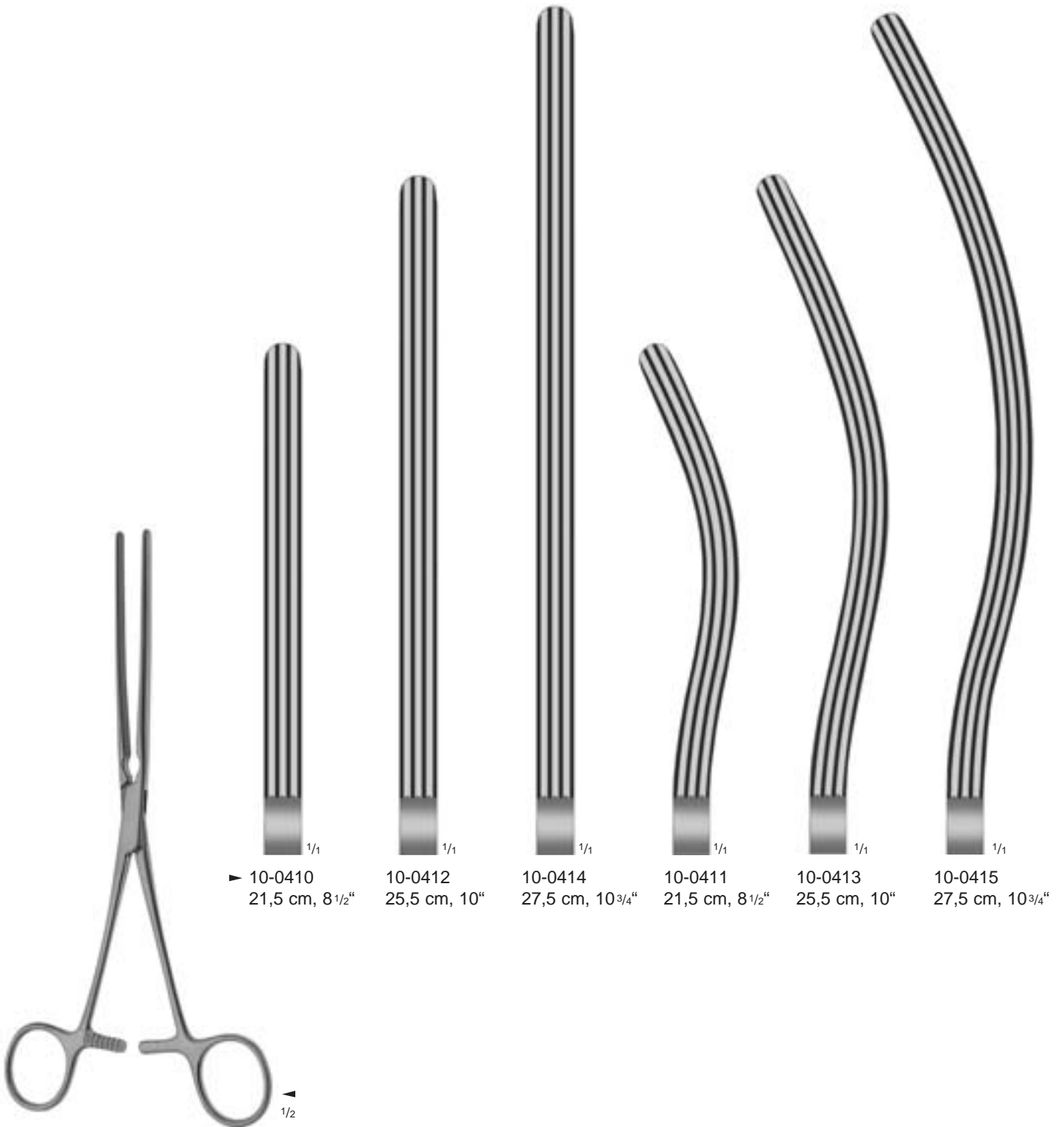

KOCHER
10-0410
- 10-0415

weich federnd
soft elastic
elásticas (suave)
souples
leggermente elastica

ATRAUMATIC-GRIP Darmklemmen mit atraumatischer Riefung
 ATRAUMATIC-GRIP Intestinal Clamp Forceps with non-traumatic serration
 ATRAUMATIC-GRIP Pinzas-clamps intestinales con bocas atraumáticas
 ATRAUMATIC-GRIP Pincas-clamps intestinales avec mors atraumatiques
 ATRAUMATIC-GRIP Pinze intestinali con presa atraumatica

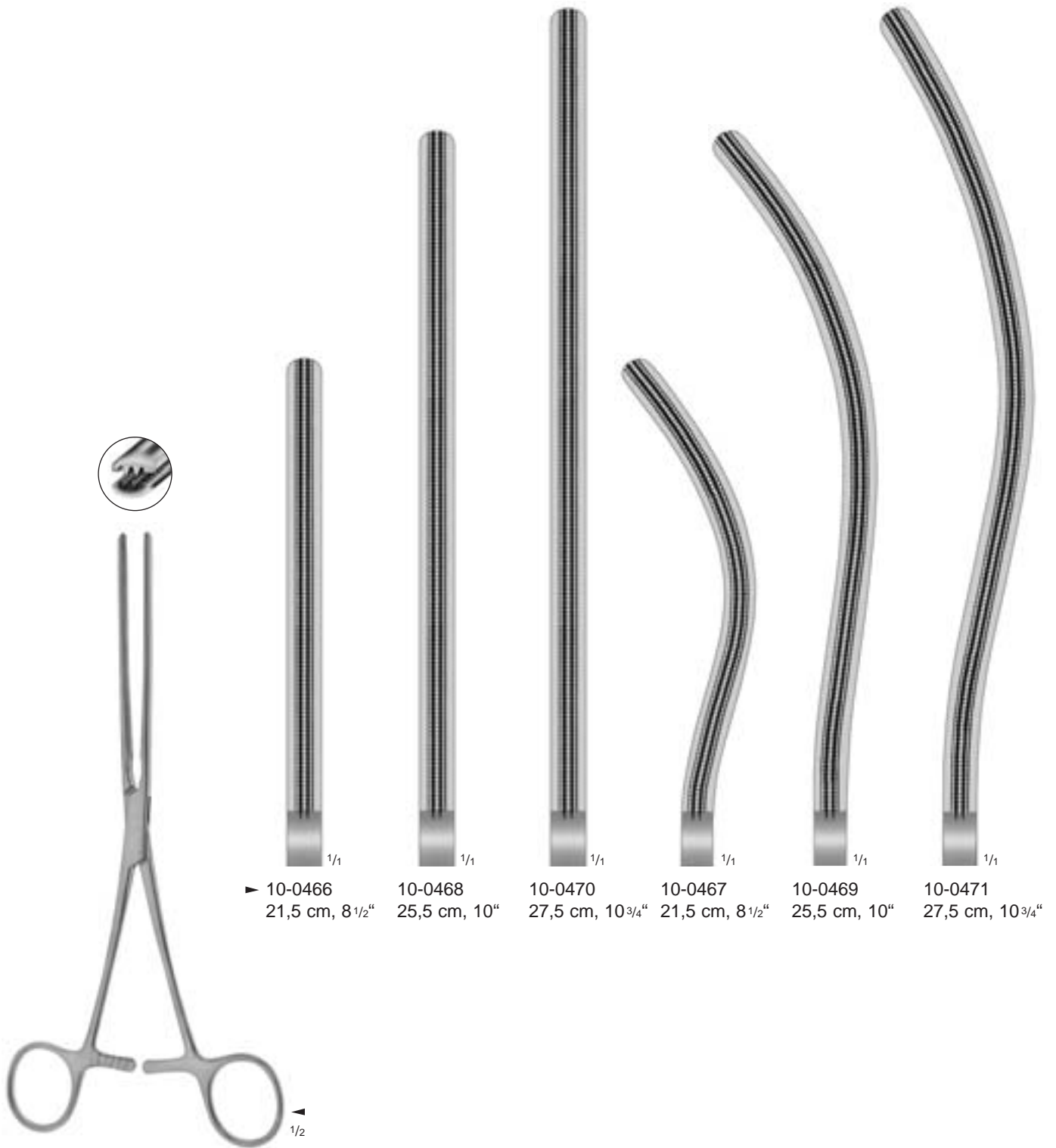

▶ 10-0466	10-0468	10-0470	10-0467	10-0469	10-0471
21,5 cm, 8 1/2"	25,5 cm, 10"	27,5 cm, 10 3/4"	21,5 cm, 8 1/2"	25,5 cm, 10"	27,5 cm, 10 3/4"

KOCHER
 10-0466
 - 10-0471

weich federnd
 soft elastic
 elásticas (suave)
 souples
 leggermente elastica



Darmklemmen
Intestinal Clamp Forceps
Pinzas-clamps intestinales
Pincas-clamps intestinales
Pinze intestinali

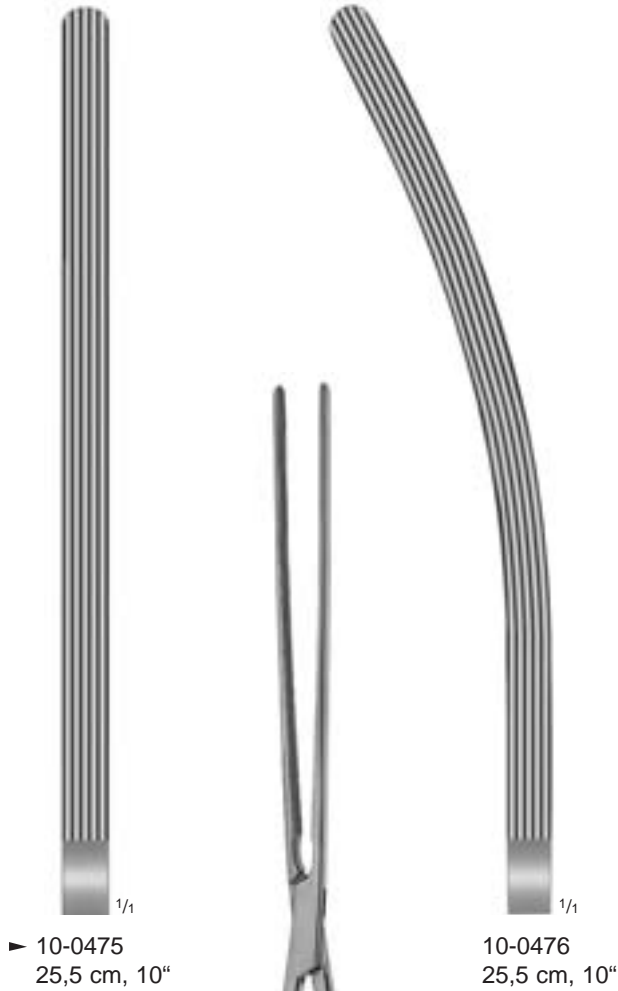

MAYO-ROBSON
10-0475
- 10-0476

hart federnd
hard elastic
elásticas (duro)
fermes
elastica duro



MAYO-ROBSON
10-0482
- 10-0483

hart federnd, mit atraumatischer Riefung
hard elastic, with non-traumatic serration
elásticas (duro), con bocas atraumáticas
fermes, avec mors atrauma
elastica duro, con morsi atraumatici

ATRAUMATIC-GRIP Magenklammern mit atraumatischer Riefung
 ATRAUMATIC-GRIP Stomach Clamp Forceps with non-traumatic serration
 ATRAUMATIC-GRIP Pinzas-clamps estomacales con bocas atraumáticas
 ATRAUMATIC-GRIP Pincers-clamps stomacales avec mors atraumatiques
 ATRAUMATIC-GRIP Pinze per stomaco con presa atraumatica



▶ 10-0488
 33 cm, 13"

10-0489
 33 cm, 13"

SCUDDER
 10-0488
 - 10-0489



- ATRAUMATIC-GRIP Obere Verschlussklemme mit atraumatischer Riefung
- ATRAUMATIC-GRIP Upper Occlusive Clamp with non-traumatic serration
- ATRAUMATIC-GRIP Pinza-clamp oclusiva superior con bocas atraumáticas
- ATRAUMATIC-GRIP Pincés-clamps à occlusion avec mors atraumatiques
- ATRAUMATIC-GRIP Pinza-clamp per occlusione superiore del retto con presa atraumatica

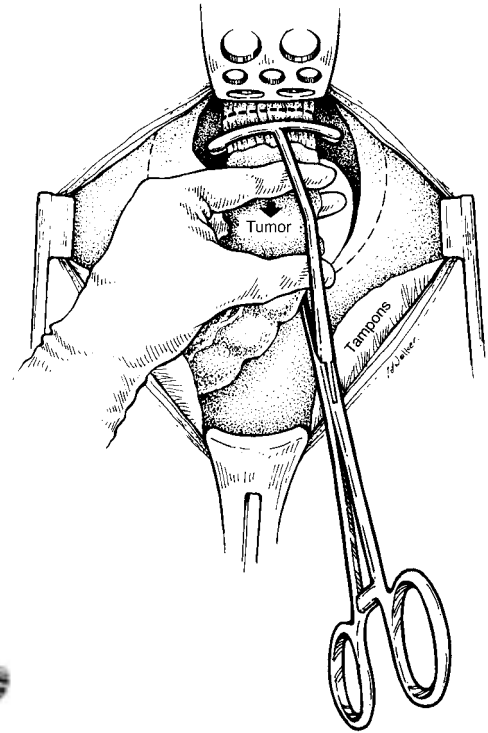

THORLAKSON
10-0660
29 cm, 11 1/2"

zur Verwendung bei der vorderen Rektumresektion
for use in anterior resection of the rectum
para el uso de la resección anterior del recto
utilisé pour la résection antérieure du rectum
per la resezione anteriore del retto

ATRAUMATIC-GRIP Untere Verschlussklemmen mit atraumatischer Riefung
 ATRAUMATIC-GRIP Lower Occlusive Clamps with non-traumatic serration
 ATRAUMATIC-GRIP Pinzas-clamps oclusiva inferior con bocas atraumáticas
 ATRAUMATIC-GRIP Pincas-clamps à occlusion avec mors atraumatiques
 ATRAUMATIC-GRIP Pinza-clamp per occlusione inferiore del retto con presa atraumatica

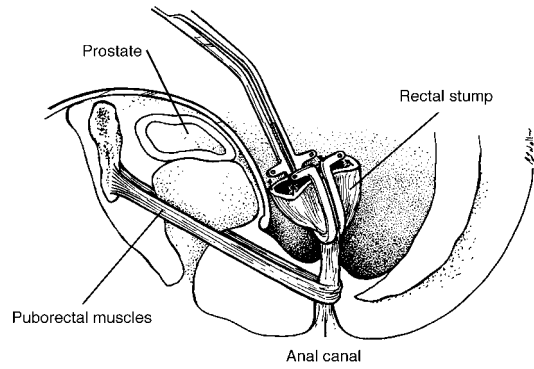
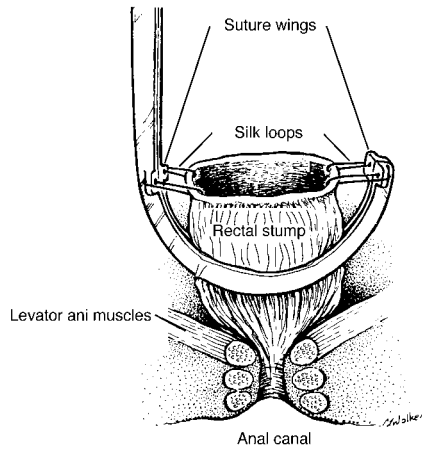

THORLAKSON
 10-0670
 29 cm, 11 1/2"

zur Verwendung bei der vorderen
Rektumresektion am weiblichen
Patienten

for use in anterior resection of the
rectum on the female patient

para el uso de la resección anterior
del recto de la mujer

utilisé pour la résection antérieure du
rectum chez la femme

per la resezione anteriore del retto in
paziente femmina

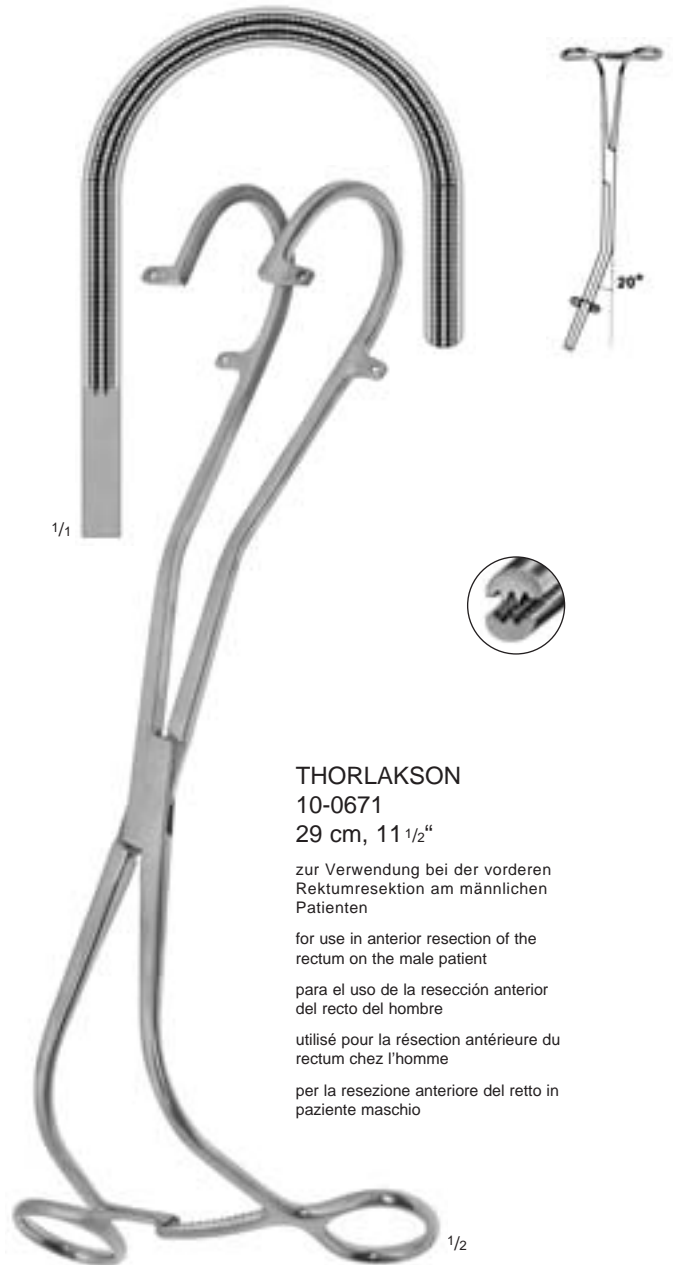

THORLAKSON
 10-0671
 29 cm, 11 1/2"

zur Verwendung bei der vorderen
Rektumresektion am männlichen
Patienten

for use in anterior resection of the
rectum on the male patient

para el uso de la resección anterior
del recto del hombre

utilisé pour la résection antérieure du
rectum chez l'homme

per la resezione anteriore del retto in
paziente maschio



Rektum-Anastomosenklemmen
Sigmoid Anastomosis Forceps
Pinzas para anastomosis del recto
Pinces-clamps à anastomose du rectum
Pinze per anastomosi del retto

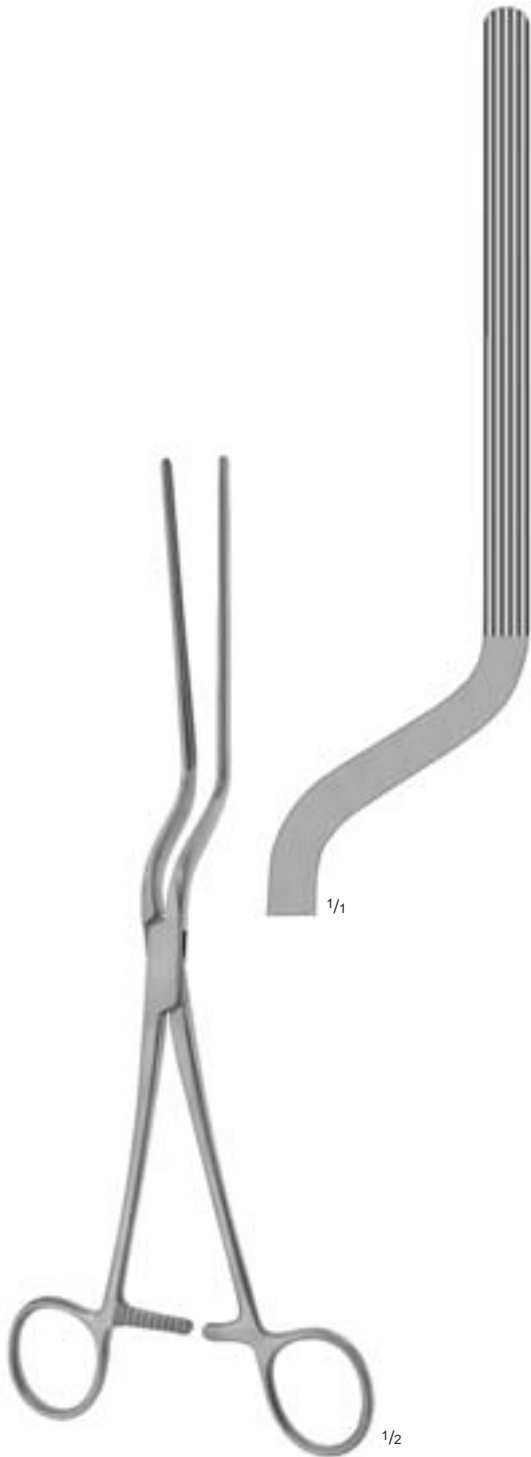

BRUNNER
10-0490
26,5 cm, 10 1/2"

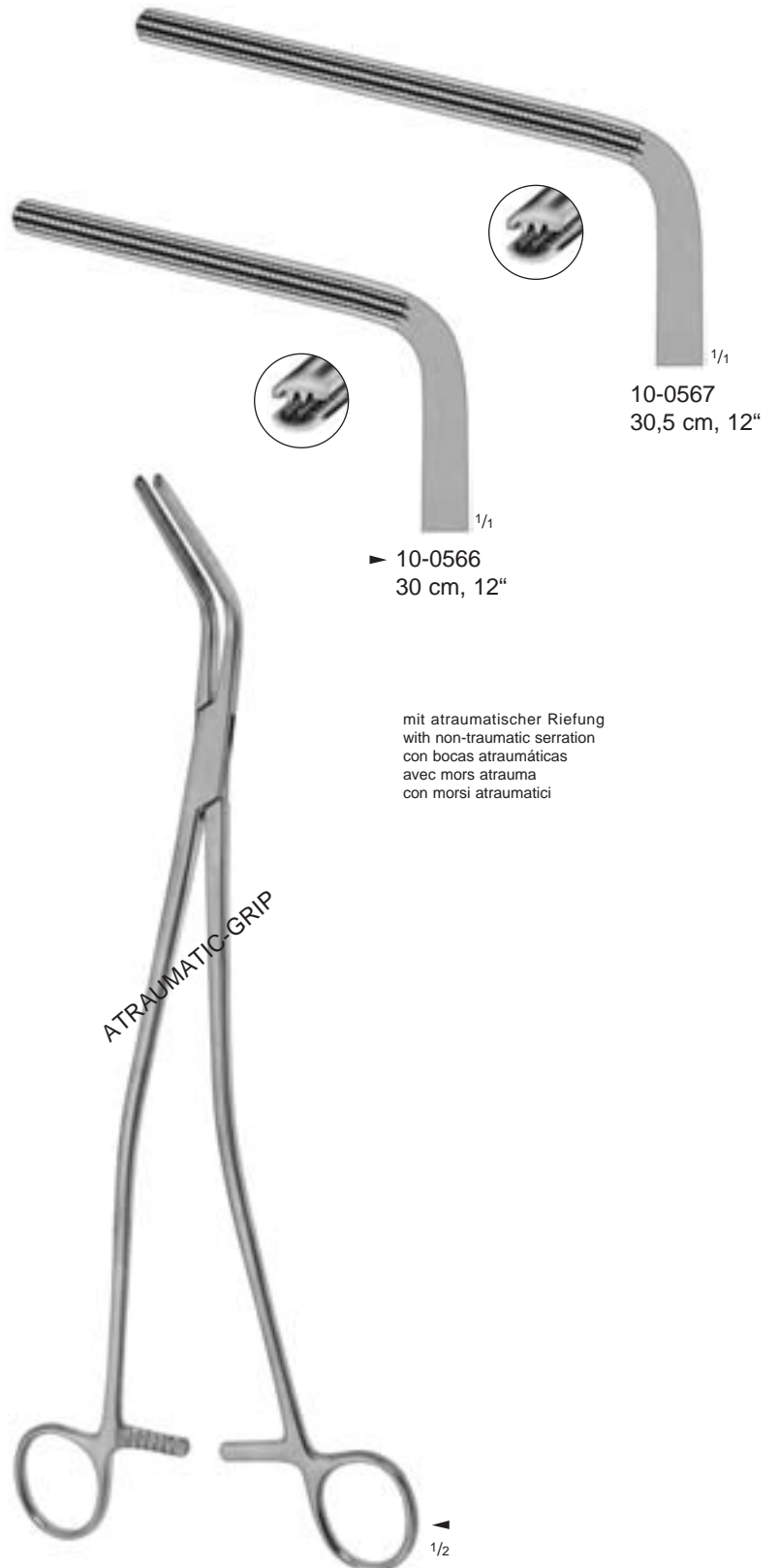

HAYES
10-0566
- 10-0567

▶ 10-0566
30 cm, 12"

10-0567
30,5 cm, 12"

mit atraumatischer Riefung
with non-traumatic serration
con bocas atraumáticas
avec mors atrauma
con morsi atraumatici

ATRAUMATIC-GRIP Rektum-Anastomosenklemmen mit atraumatischer Riefung
 ATRAUMATIC-GRIP Sigmoid Anastomosis Forceps with non-traumatic serration
 ATRAUMATIC-GRIP Pinzas para anastomosis de recto con bocas atraumáticas
 ATRAUMATIC-GRIP Pincers clamps à anastomose du rectum avec mors atraumatiques
 ATRAUMATIC-GRIP Pinze per anastomosi de retto con presa atraumatica

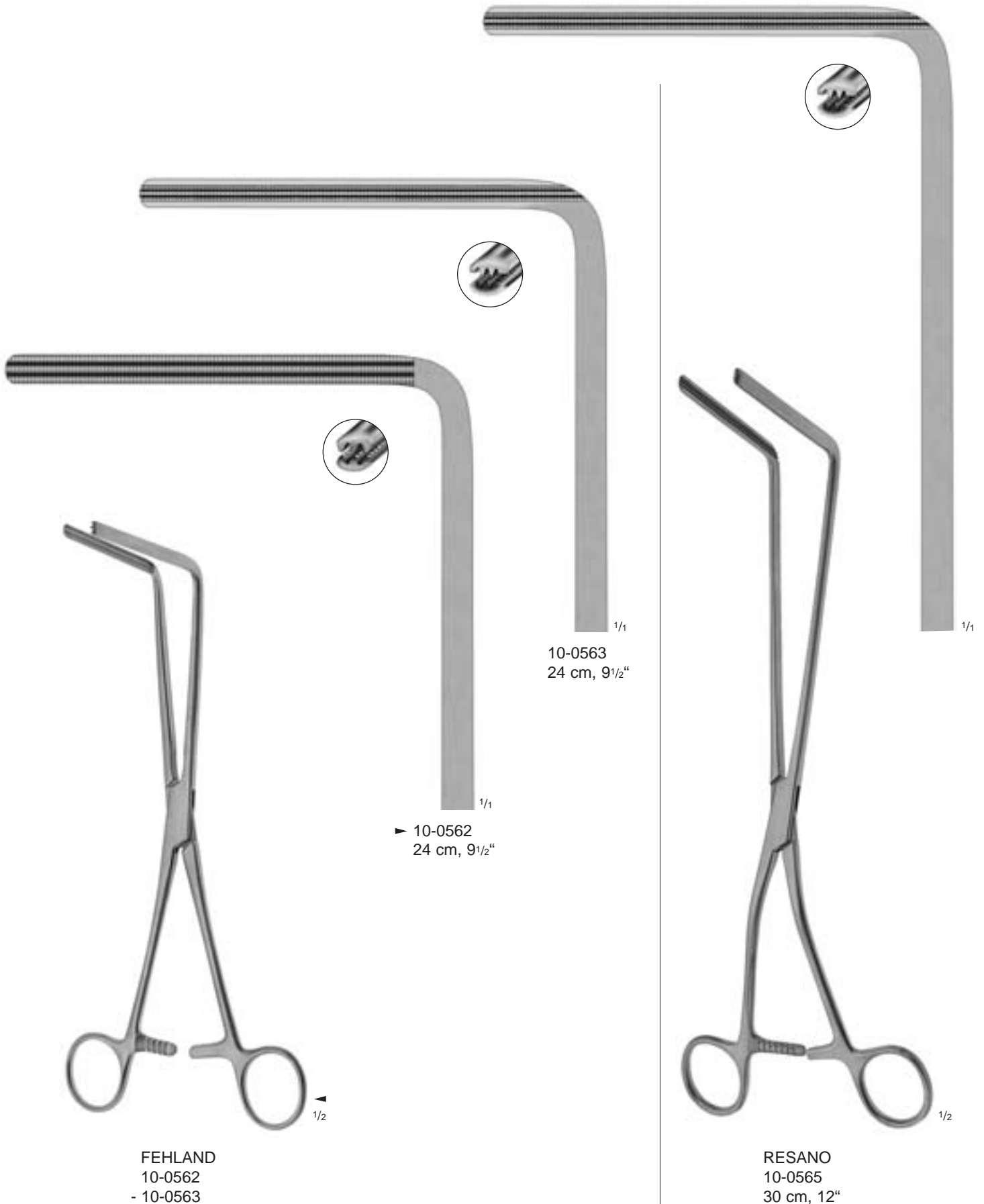

10-0563
 24 cm, 9 1/2"

► 10-0562
 24 cm, 9 1/2"

FEHLAND
 10-0562
 - 10-0563

RESANO
 10-0565
 30 cm, 12"



Darm- und Anastomosenklemmen
 Intestinal and Anastomosis Clamp Forceps
 Pinzas-clamps intestinales y para anastomosis
 Pinces-clamps intestinales et à anastomose
 Pinze intestinali e per anastomosi



DE MARTEL-WOLFSON

10-0622

Dickdarm-Anastomosen-Klemmen, Maullänge 60 mm, Satz zu 3 Stück

Colon-anastomosis clamp forceps, 60 mm length of jaws, set of 3 pieces

Clamps para anastomosis del colon, longitud de la boca 60 mm, juego de 3 piezas

Clamps pour anastomose du colon, mors de 60 mm, jeu de 3 pieces

Pinze per anastomosi del colon, bocche lungh. 60 mm., set 3 pezzi

▶ 10-0623

Dickdarm-Anastomosen-Klemmen, Maullänge 75 mm, Satz zu 3 Stück

Colon-anastomosis clamp forceps, 75 mm length of jaws, set of 3 pieces

Clamps para anastomosis del colon, longitud de la boca 75 mm, juego de 3 piezas

Clamps pour anastomose du colon, mors de 75 mm, jeu de 3 pieces

Pinze per anastomosi del colon, bocche lungh. 75 mm., set 3 pezzi

10-0624

Dickdarm-Anastomosen-Klemmen, Maullänge 105 mm, Satz zu 3 Stück

Colon-anastomosis clamp forceps, 105 mm length of jaws, set of 3 pieces

Clamps para anastomosis del colon, longitud de la boca 105 mm, juego de 3 piezas

Clamps pour anastomose du colon, mors de 105 mm, jeu de 3 pieces

Pinze per anastomosi del colon, bocche lungh. 105 mm., set 3 pezzi



DE MARTEL-WOLFSON
 10-0625
 9 cm, 3 1/2"

Klemmenhalter, kurz
 Clamp holder, short
 Porta-clamp, corto
 Porte-clamps, court
 Portapinze, corto

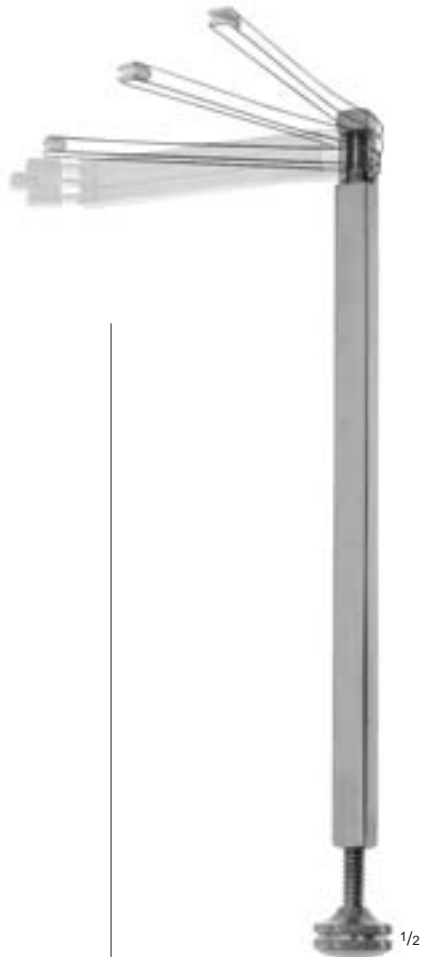

DE MARTEL-WOLFSON
 10-0630
 22,5 cm, 9"

Klemmenhalter, lang
 Clamp holder, long
 Porta-clamp, largo
 Porte-clamps, long
 Portapinze, lungo



DE MARTEL-WOLFSON
 10-0640
 24,5 cm, 9 3/4"

Klemmschließzange
 Clamp closing forceps
 Pinza para cerrar los clamps
 Pince pour fermer les clamps
 Serrapinze

Spornquetsche
 Spur Crusher
 Machacadora para espora
 Ecraseurs intestinaux
 Pinza schiaccia sperone

Pylorusspreizer
 Pylorus Spreader
 Separador para píloro
 Ecarteur du pylore
 Divaricatore per píloro

Darm- und Magenquetschklemmen
 Intestinal and Stomach Clamps
 Pinzas-clamps intestinales y estomacales
 Pincés-clamps pour l'intestin et l'estomac
 Pinze/clamp per intestino e stomaco



KLEINSCHMIDT
 10-0648
 12,5 cm, 5"

Spornquetsche und Appendektomieklammer
 Spur crusher and appendectomy clamp
 Machacadora para espora y clamp para apendectomía
 Ecraseur et clamp à appendicectomie
 Pinza schiaccia sperone e clamp per appendicectomia



BENSON
 10-0168
 15,5 cm, 6"

Pylorusspreizer
 Pylorus spreader
 Separador para píloro
 Ecarteur du pylore
 Divaricatore per píloro



BABY-PAYR
 10-0849
 15,5 cm, 6"

Darm- und Magenquetschklemme mit Stift
 Intestinal and stomach clamp with pin
 Pinza-clamp intestinales y estomacales con espiga
 Pince-clamp et écraseurs pour l'intestin et l'estomac avec pointe
 Clamp per intestino e stomaco con perno

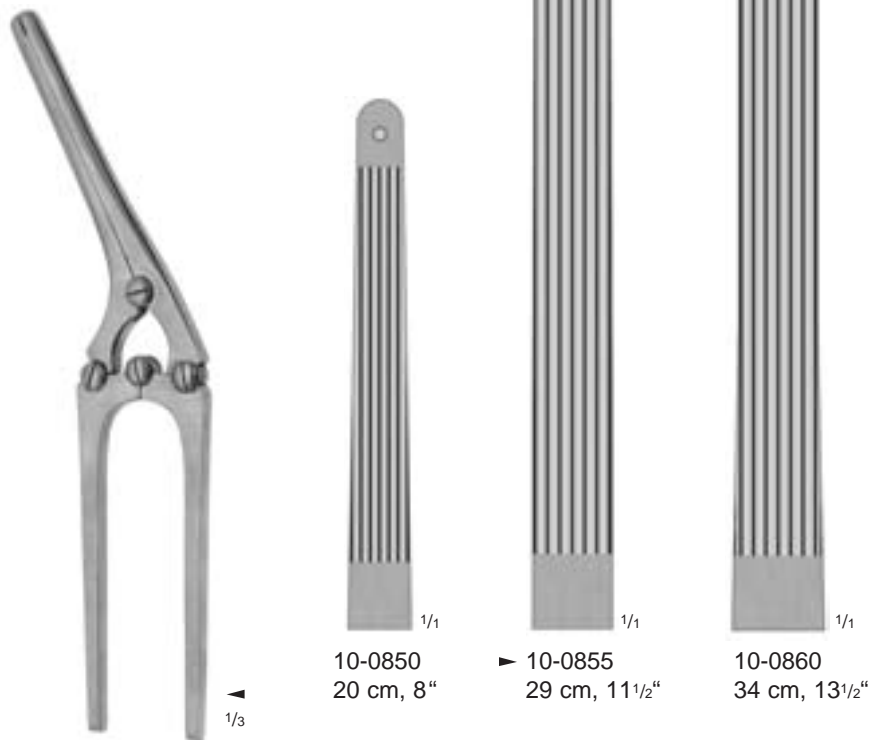

PAYR
 10-0850
 - 10-0860

Darm- und Magenquetschklemmen mit Stift
 Intestinal and stomach clamps with pin
 Pinzas-clamps intestinales y estomacales con espiga
 Pince-clamps et écraseurs pour l'intestin et l'estomac avec pointe
 Clamp per intestino e stomaco con perno

10-0850
 20 cm, 8"

▶ 10-0855
 29 cm, 11 1/2"

10-0860
 34 cm, 13 1/2"



Magen- und Darm-Nähapparat
Stomach and Intestinal Suturing Apparatus
Aparato para suturar estomacal e intestinal
Appareil à suture gastro-intestinale
Apparecchiatura di sutura gastro-intestinale

VON PETZ
10-0700

Magen- und Darm-Nähapparat, komplett, bestehend aus:

- 10-0702 1 Nähapparat für 23 Paar Nähklammern
- 10-0711 1 Füllpinzette
- 10-0712 1 Füllstift
- 10-0713 1 Füllständer
- 10-0714 1 Zusatzschloß
- 10-0715 1 Kurbel
- 10-0716 1 Schraubenzieher
- 10-0717 1 Metalletui für Klammern
- 10-0710 1 Packung mit 300 Stück Nähklammern aus Neusilber
- 10-0718 1 Holzetui 460 x 200 x 55 mm

Stomach and intestinal suturing apparatus, complete, consisting of:

- 10-0702 1 Suturing apparatus for 23 pairs of suturing clips
- 10-0711 1 Filling tweezer
- 10-0712 1 Filling pin
- 10-0713 1 Filling rack
- 10-0714 1 Additional closing clamp
- 10-0715 1 Gear wheel
- 10-0716 1 Screw driver
- 10-0717 1 Metal box for clips
- 10-0710 1 Package containing 300 pieces suture clips of German silver
- 10-0718 1 Wooden case 460 x 200 x 55 mm



1/4

Aparato para suturar estomacal e intestinal, completo, compuesto de:

- 10-0702 1 Aparato para suturar para 23 pares de agrafes para suturar
- 10-0711 1 Pinza para rellenar
- 10-0712 1 Espiga para rellenar
- 10-0713 1 Estante para rellenar
- 10-0714 1 Cierre adicional
- 10-0715 1 Manivela
- 10-0716 1 Destornillador
- 10-0717 1 Estuche de metal para agrafes
- 10-0710 1 Paquetito de 300 piezas agrafes para suturar de plata alemana
- 10-0718 1 Estuche de madera 460 x 200 x 55 mm

Appareil pour la suture gastro-intestinale, complet, composé de:

- 10-0702 1 Appareil à suture pour 23 paires d'agrafes
- 10-0711 1 Pince à préhension les agrafes
- 10-0712 1 Broche pour fixer les agrafes
- 10-0713 1 Support
- 10-0714 1 Clamp de serrage
- 10-0715 1 Manivelle
- 10-0716 1 Tournevis
- 10-0717 1 Boîte métal pour les agrafes
- 10-0710 1 paquet de 300 agrafes à suture en argent blanc
- 10-0718 1 Boîte en bois 460 x 200 x 55 mm

Apparecchiatura per la sutura gastro-intestinale, completo, composto da:

- 10-0702 1 Apparecchiatura per la sutura per 23 paia di agrafes
- 10-0711 1 Pinza per caricare
- 10-0712 1 Perno per posizionare le agrafe
- 10-0713 1 Supporto per caricare
- 10-0714 1 Clamp supplementare
- 10-0715 1 Manovella
- 10-0716 1 Cacciavite
- 10-0717 1 Scatola in metallo per agrafe
- 10-0710 1 Pacchetto da 300 pezzi agrafe in argento bianco
- 10-0718 1 Astuccio in legno 460 x 200 x 55 mm

VON PETZ
10-0701

Magen- und Darm-Nähapparat, komplett, jedoch ohne Holzetui

Stomach and intestinal suturing apparatus, complete, without wooden case

Aparato para suturar estomacal e intestinal, completo, sin estuche de madera

Appareil pour la suture gastro-intestinale, complet, sans boîte en bois

Apparecchiatura per la sutura gastro-intestinale, completo, senza l'astuccio in legno



1/1



1/2

10-0710

Nähklammern aus Neusilber, Packung mit 300 Stück
Suture clips of German silver, package of 300 pieces
Agrafes para suturar de plata alemana, paquetito de 300 piezas
Agrafes en argent blanc, pour la suture gastro-intestinale, boîtes de 300
Agrafe in argento bianco per sutura gastro-intestinale, pacchetto da 300 pezzi

Mastdarm-Rektum-Spekula
 Rectal Specula
 Espéculos para el recto
 Spéculums rectaux
 Speculi rectali

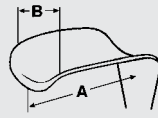

105 x 23-28 mm
 (AxB)

CZERNY
 90-0276
 22,5 cm, 9"

1/2

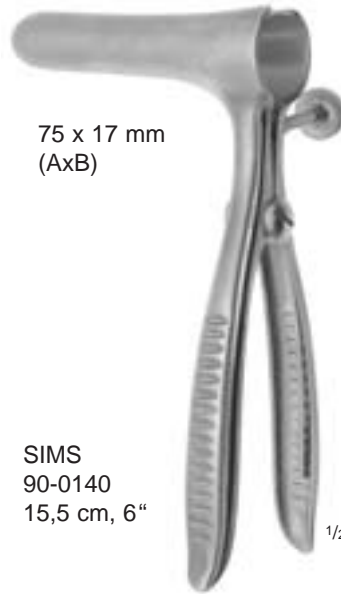

75 x 17 mm
 (AxB)

SIMS
 90-0140
 15,5 cm, 6"

1/2

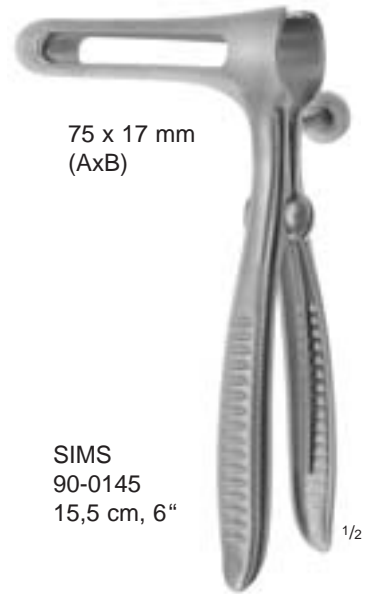

75 x 17 mm
 (AxB)

SIMS
 90-0145
 15,5 cm, 6"

1/2

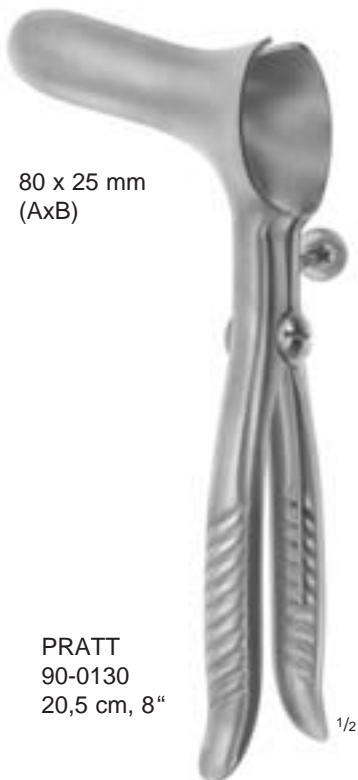

80 x 25 mm
 (AxB)

PRATT
 90-0130
 20,5 cm, 8"

1/2



90 x 16 mm
 (AxB)

MATHIEU
 90-0138
 19,5 cm, 7³/₄"

1/2



Mastdarm-Rektum-Spekula
Rectal Specula
Espéculos para el recto
Spéculums rectaux
Speculi rectali

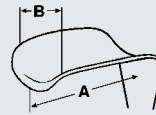

60 x 20 mm
(AxB)

SIMS
90-0147
18 cm, 7"

1/2



90-0148 80 x 25 mm (AxB)
▶ 90-0149 125 x 25 mm (AxB)
90-0155 150 x 25 mm (AxB)

SIMS
90-0148
- 90-0155
24,5 cm, 9 3/4"

1/2

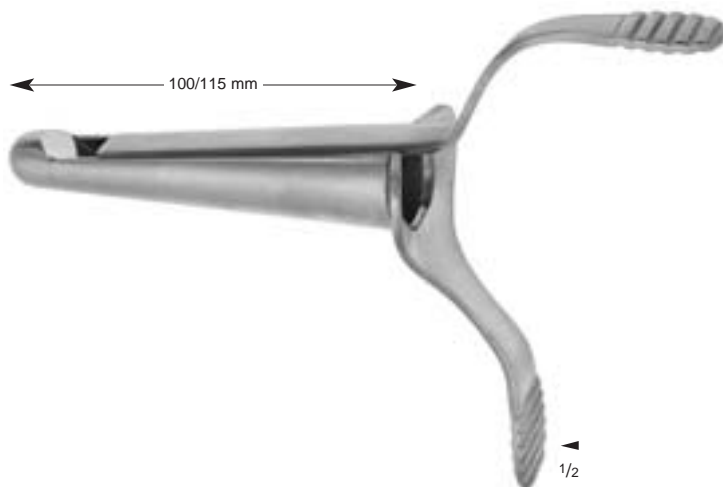

100/115 mm

BRINKERHOFF

▶ 90-0205 ø 15-25 mm x 100 mm
90-0210 ø 19-31 mm x 115 mm

1/2

Sphinkteroskope
Sphincteroscopes
Esfinteroscopios
Sphinctérosopes
Sfinteroscopi

Anuskope
Anoscopes
Anoscopios
Anusopes
Anoscopi

Analspreizer
Rectal Retractor
Separador para el recto
Dilatateurs pour anus et rectum
Dilatatori per l'ano ed il retto



KELLY
► 90-0150 ø 21 mm x 50 mm
90-0151 ø 27 mm x 50 mm

Sphinkteroskope
Sphincteroscopes
Esfinteroscopios
Sphinctérosopes
Sfinteroscopi



HIRSCHMANN
90-0225 ø 19 mm x 65 mm
► 90-0230 ø 22 mm x 65 mm

Anuskope
Anoscopes
Anoscopios
Anusopes
Anoscopi



IVES-FANSLER
90-0180
ø 22 mm x 80 mm

Anoskop mit Hartgummi-Obturator
Anoscope with vulcanite obturator
Anoscopio con obturador de plástico
Anusopes avec opturateur en ébonite
Anoscopi con otturatore di ebanite



ROSCHKE
90-0099
ø 15-30 mm x 70 mm

Analspreizer
Rectal retractor
Separador para el recto
Dilatateur pour anus
Dilatatore per l'ano



Analspreizer
Rectal Retractors
Separadores para el recto
Dilatateurs pour anus et rectum
Dilatatori per l'ano ed il retto

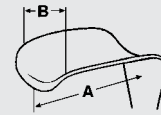

70 x 22 mm
(AxB)



BARR
90-0100
 18,5 cm, 7 1/4"

55 x 23 mm
(AxB)

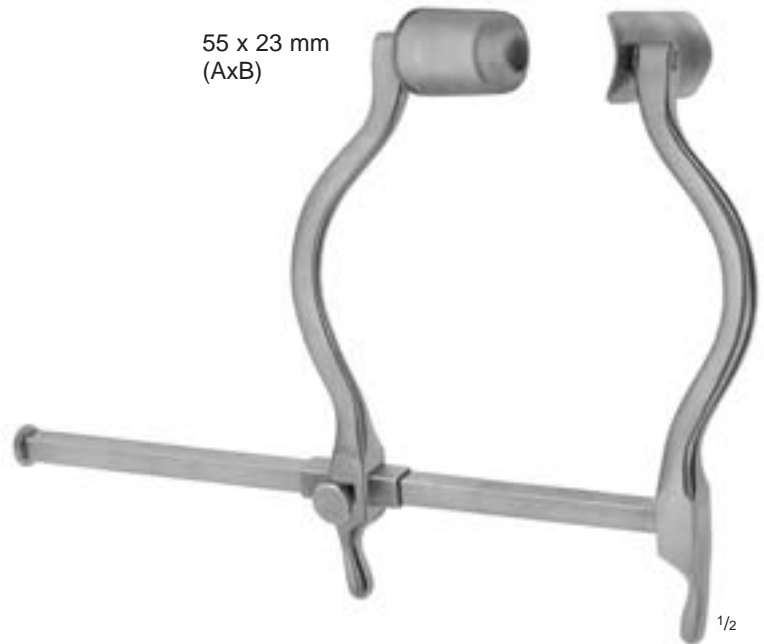

SMITH-BUIE
90-0110

90-0117



90-0119

ALAN-PARK
90-0115
 14,5 cm, 5 3/4"

Analspreizer mit Kugelschnellverschluss, komplett, bestehend aus:

- 90-0116 1 Sperrer
- 90-0117 1 Paar Seitenvalven 75 x 22 mm (AxB)
- 90-0118 1 Paar Seitenvalven 95 x 22 mm (AxB)
- 90-0119 1 Mittelvalve 95 x 22 mm (AxB)

Rectal retractor with ball snap closure, complete, consisting of:

- 90-0116 1 Spreader
- 90-0117 1 Pair lateral valves 75 x 22 mm (AxB)
- 90-0118 1 Pair lateral valves 95 x 22 mm (AxB)
- 90-0119 1 Central valve 95 x 22 mm (AxB)

Separador para el recto con cierre esférico, completo, compuesto de:

- 90-0116 1 Separador
- 90-0117 1 Par de valvas laterales 75 x 22 mm (AxB)
- 90-0118 1 Par de valvas laterales 95 x 22 mm (AxB)
- 90-0119 1 Valva central 95 x 22 mm (AxB)

Ecarteur rectal, complet, composé de:

- 90-0116 1 Dilatateur
- 90-0117 1 Paire de valves latérales 75 x 22 mm (AxB)
- 90-0118 1 Paire de valves latérales 95 x 22 mm (AxB)
- 90-0119 1 Valve centrale 95 x 22 mm (AxB)

Dilatatore rettale con chiusura a scatto, completo, composto da:

- 90-0116 1 Dilatatore
- 90-0117 1 Paia di valve laterali 75 x 22 mm (AxB)
- 90-0118 1 Paia di valve laterali 95 x 22 mm (AxB)
- 90-0119 1 Valve centrale 95 x 22 mm (AxB)

Watteträger
Cotton Carrier
Porta-algodón
Porte-cotons
Portacotone

Analsonden
Rectal Probes
Sondas para el recto
Sondes rectales
Sonde rettali

Druckklemme
Pressure Clamp
Pinza-clamp de presión progresiva
Pince-clamp à pression
Pinza/clamp a pressione

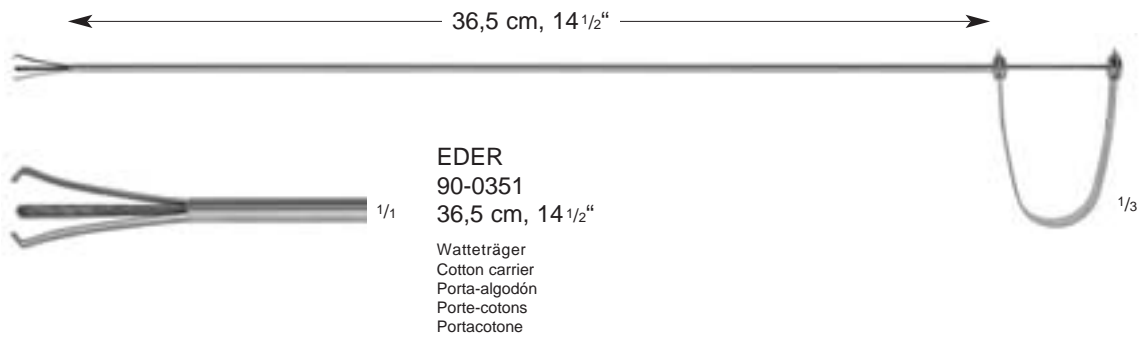

EDER
90-0351
36,5 cm, 14 1/2"

Watteträger
Cotton carrier
Porta-algodón
Porte-cotons
Portacotone

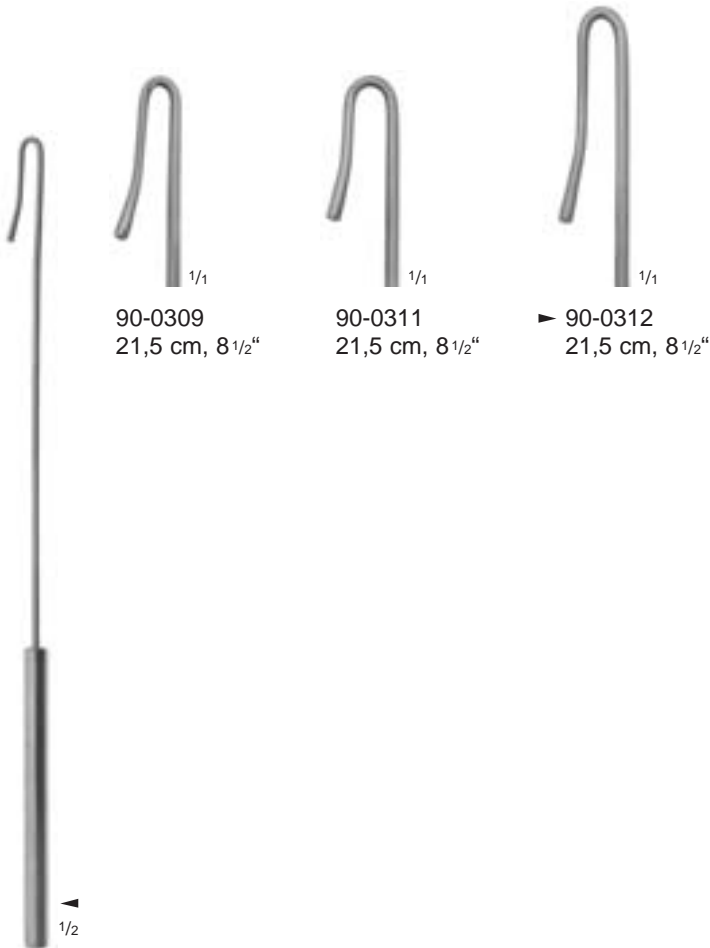

90-0309
21,5 cm, 8 1/2"

90-0311
21,5 cm, 8 1/2"

▶ 90-0312
21,5 cm, 8 1/2"

PRATT
90-0309
- 90-0312

Fistelnsonden (Krypthaken)
Fistula probes (crypt hooks)
Sondas para fistula (gancho para cripta)
Sondes pour fistules (crochets à crypte)
Sonde per fistola (gancio a cripta)

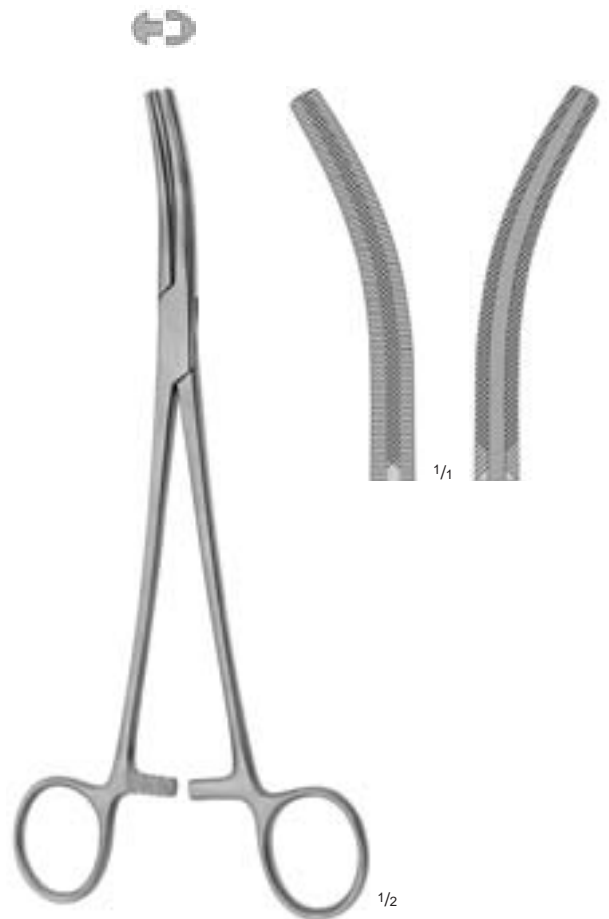

BUIE
90-0955
22 cm, 8 3/4"

Druckklemme
Pressure clamp
Pinza-clamp de presión progresiva
Pince-clamp à pression
Pinza/clamp a pressione



Hämorrhoiden-Faßzange
 Haemorrhoidal Forceps
 Pinza-clamp para hemorroides
 Pincés-clamps pour hémorroïdes
 Pinze per emorroidi

Hämorrhoiden-Ligatoren
 Haemorrhoidal-Ligators
 Ligadores para hemorroides
 Ligateurs hémorroïdaux
 Legatori emorroidali

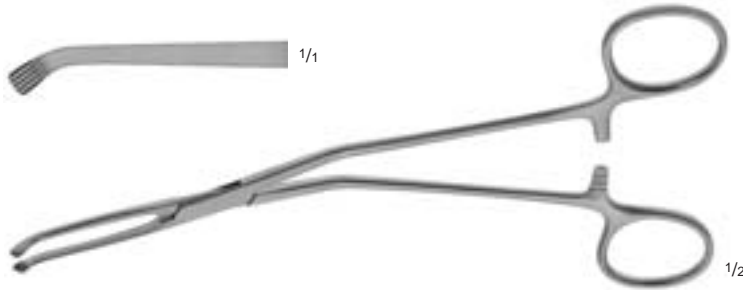

MC GIVNEY
 90-0962
 19 cm, 7 1/2"

Hämorrhoiden-Faßzange
 Haemorrhoidal forceps
 Pinza-clamp para hemorroides
 Pincés-clamps pour hémorroïdes
 Pinze per emorroidi



90-0969

Ligatur-Gummiringe, in Packung à 100 Stück
 Ligature rubber rings, in package of 100 pieces
 Anillos de goma para ligadura, en paquete de 100 piezas
 Bagues de caoutchouc pour ligatures, paquet de 100 pièces
 Anelli di gomma per legatori, conf. 100 pezzi



RUDD
 90-0970
 27,5 cm, 10 3/4"

Hämorrhoiden-Ligator mit Ladekonus ø 12 mm (90-0971)
 Haemorrhoidal ligator with loading attachment ø 12 mm (90-0971)
 Ligador para hemorroides con cono de carga ø 12 mm (90-0971)
 Ligateur hémorroïdales avec cône de charge ø 12 mm (90-0971)
 Legatori emorroidali con carica a cono ø 12 mm (90-0971)

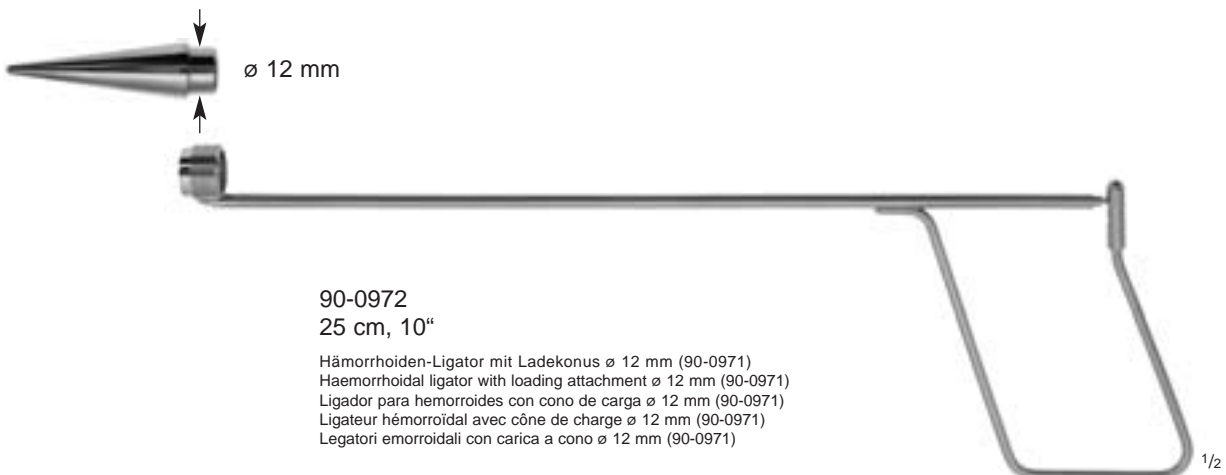

90-0972
 25 cm, 10"

Hämorrhoiden-Ligator mit Ladekonus ø 12 mm (90-0971)
 Haemorrhoidal ligator with loading attachment ø 12 mm (90-0971)
 Ligador para hemorroides con cono de carga ø 12 mm (90-0971)
 Ligateur hémorroïdal avec cône de charge ø 12 mm (90-0971)
 Legatori emorroidali con carica a cono ø 12 mm (90-0971)

Hämorrhoiden-Saugligatoren
 Haemorrhoidal Suction Ligators
 Ligadores de aspiración para hemorroides
 Ligateurs aspirateurs pour hémorroïdes
 Legatori emorroidali con aspiratore





Mastdarm-Biopsiezangen
 Rectal Biopsy Specimen Forceps
 Pinzas sacabocado para biopsia rectal
 Pincas à biopsie rectale
 Pinze taglienti per biopsia rettale

← 42 cm, 16 1/2" →

4,0 mm

90-0622 35,0 cm, 13 3/4"
 90-0623 42,0 cm, 16 1/2"

3,5 mm

90-0632 35,0 cm, 13 3/4"
 ▶ 90-0633 42,0 cm, 16 1/2"

YEOMAN
 90-0622
 - 90-0633

← 33,5 cm, 13 1/4" →

360°
 drehbar
 turnable
 girable
 rotative
 rotante

90-0656
 Griff allein
 Handle only
 Mango suelto
 Manche seul
 Manico solo

YEOMAN
 90-0652
 - 90-0654

3,8 mm

▶ 90-0652 33,5 cm, 13 1/4" (90-0653 Aufsatz allein • Stem only • Punta suelta • Rallonge seule • Punta sola)
 90-0654 38,5 cm, 15 1/4" (90-0655 Aufsatz allein • Stem only • Punta suelta • Rallonge seule • Punta sola)

← 33,5 cm, 13 1/4" →

360°
 drehbar
 turnable
 girable
 rotative
 rotante

90-0706
 Griff allein
 Handle only
 Mango suelto
 Manche seul
 Manico solo

90-0712 33,5 cm, 13 1/4" (90-0713 Aufsatz allein • Stem only • Punta suelta • Rallonge seule • Punta sola)

3,8 mm



LAWNTON

Medizintechnik



Galle, Leber, Niere, Blase, Urologie
Gall, Liver, Kidney, Bladder, Urology
Bilis, Hígado, Riñón, Vejiga, Urología
Bile, Foie, Rein, Vessie, Urologie
Bile, Fegato, Rene, Vescica, Urologia



Instrumente für Galle, Leber, Niere, Blase und Urologie
Instruments for Gall, Liver, Kidney, Bladder and Urology
Instrumentos para bilis, hígado, riñón, vejiga y urología
Instruments pour bile, foie, rein, vessie et urologie
Strumenti per bile, fegato, rene, vescica e urologia



Gallenblasenzangen	Seite	23, 209, 389, 457
Gall Bladder Forceps	Page	23, 209, 389, 457
Pinzas-clamps para la vesícula biliar	Página	23, 209, 389, 457
Pinces clamps pour vésicule biliaire	Page	23, 209, 389, 457
Pinze per colecisti	Pagina	23, 209, 389, 457



Gallenkanal-Klemmzangen	Seite	178, 189
Gall Duct Forceps	Page	178, 189
Pinzas-clamps para el conducto biliar	Página	178, 189
Pince-clamp pour canal biliaire	Page	178, 189
Pinze per il condotto biliare	Pagina	178, 189



Gallenkanal- und Cystikus-Klemme	Seite	182
Gall Duct and Cystic Forceps	Page	182
Pinzas-clamps para el conducto biliar y cístico	Página	182
Pinces pour le canal biliaire et cystique	Page	182
Pinze per il condotto biliare e cistico	Pagina	182



Nierenklemmen	Seite	190
Kidney Clamps	Page	190
Pinzas-clamps para renal	Página	190
Clamps rénaux	Page	190
Pinze per il rene	Pagina	190



Nierenstielklemmen	Seite	191, 195
Kidney Pedicle Clamps	Page	191, 195
Pinzas clamps para el pedúnculo renal	Página	191, 195
Pinces-clamps pour pédicules rénaux	Page	191, 195
Pinze per peduncoli renali	Pagina	191, 195



Blasenspatel, Blasenwundspreizer	Seite	268, 310
Bladder Spatulas, Bladder Retractors	Page	268, 310
Espátulas para la vesícula, Separadores vesicales	Página	268, 310
Spatules vésicales, Ecarteurs vésicaux	Page	268, 310
Spatole vescicali, Divaricatori vescicali	Pagina	268, 310



Bumerang-Nadelhalter	Seite	372
Boomerang Needle Holders	Page	372
Porta-agujas de bumerang	Página	372
Porte-aiguilles boomerang	Page	372
Portaghi boomerang	Pagina	372



ø 5,0 mm



1/2

MOYNIHAN
 11-0265
 34 cm, 13 1/2"

Gallensteinsonde und
 -löffel aus Zinn, biegsam

Gall stone probe and
 scoop of tin, malleable

Sonda y cucharilla para
 los cálculos biliares, maleable

Sonde-curette pour vésicule
 biliaire, malléable

Sonda con cucchiaino per
 calcoli biliari, malleabile

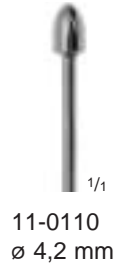

1/1

11-0110
 ø 4,2 mm



1/2



1/1

▶ 11-0115
 ø 6,0 mm

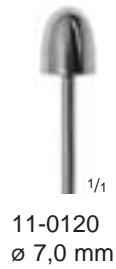

1/1

11-0120
 ø 7,0 mm

DESJARDINS
 11-0110
 -11-0120
 28 cm, 11"

Gallengangsonden,
 federnd

Gall duct probes,
 flexible

Sondas para el conducto
 biliar, flexible

Dilatateurs à voies biliaires
 flexible

Dilatatori per condotti biliari
 flessibili

ø 3,5 mm

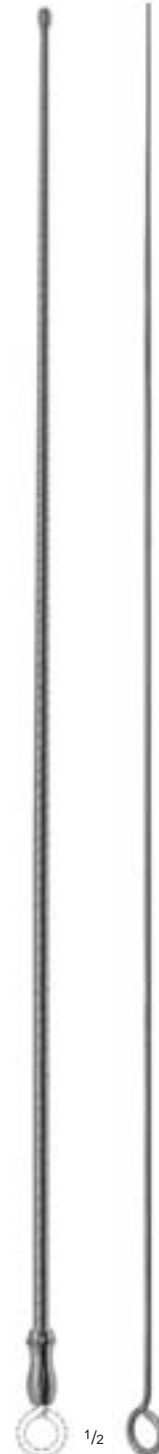

1/2

OCHSNER
 11-0100
 38,5 cm, 15 1/4"

Gallengangsonde,
 federnd

Gall duct probes,
 flexible

Sonda para el conducto
 biliar, flexible

Dilatateur à voies biliaires
 flexible avec conducteur

Dilatatore per condotti biliari
 flessibile



Gallengang-Dilatationsoliven
 Common Bile Duct Dilators
 Dilatadores para el conducto biliar
 Dilatateurs biliaires
 Dilatatore per coledoco

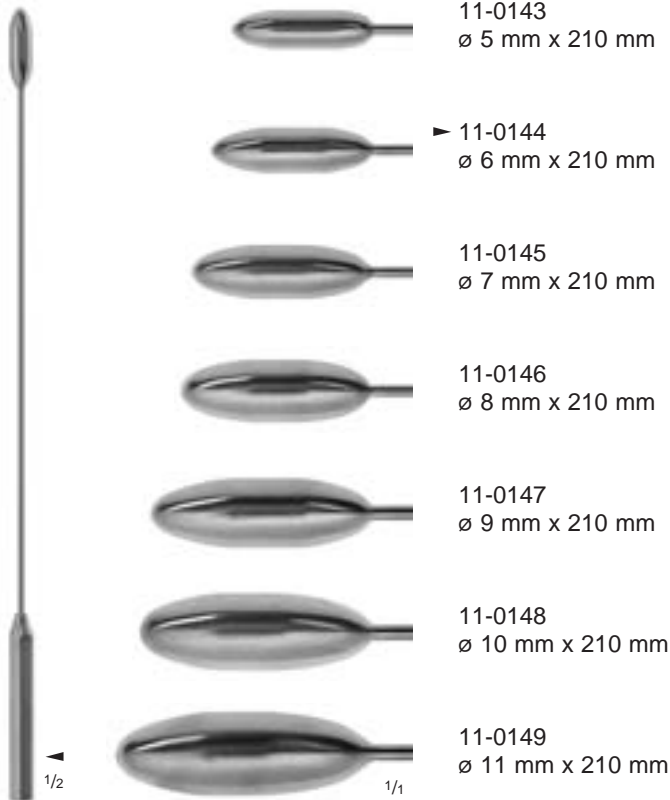

- 11-0141
ø 3 mm x 210 mm
- 11-0142
ø 4 mm x 210 mm
- 11-0143
ø 5 mm x 210 mm
- ▶ 11-0144
ø 6 mm x 210 mm
- 11-0145
ø 7 mm x 210 mm
- 11-0146
ø 8 mm x 210 mm
- 11-0147
ø 9 mm x 210 mm
- 11-0148
ø 10 mm x 210 mm
- 11-0149
ø 11 mm x 210 mm

BAKES
11-0140

Satz von 9 Gallengang-Dilatationsoliven 11-0141 bis 11-0149, biegsam, in Plastiktasche (11-0139)

Set of 9 common bile duct dilators 11-0141 to 11-0149, malleable, in plastic roll (11-0139)

Juego de 9 dilatadores para el conducto biliar del 11-0141 al 11-0149, maleable, en bolsa de plástico (11-0139)

Jeu de 9 dilatateurs biliaires du 11-0141 au 11-0149 malléables en sachet plastique (11-0139)

Set di 9 dilatatori per condotti biliari dal 11-0141 al 11-0149, malleabili, con rotolo di plastica (11-0139)

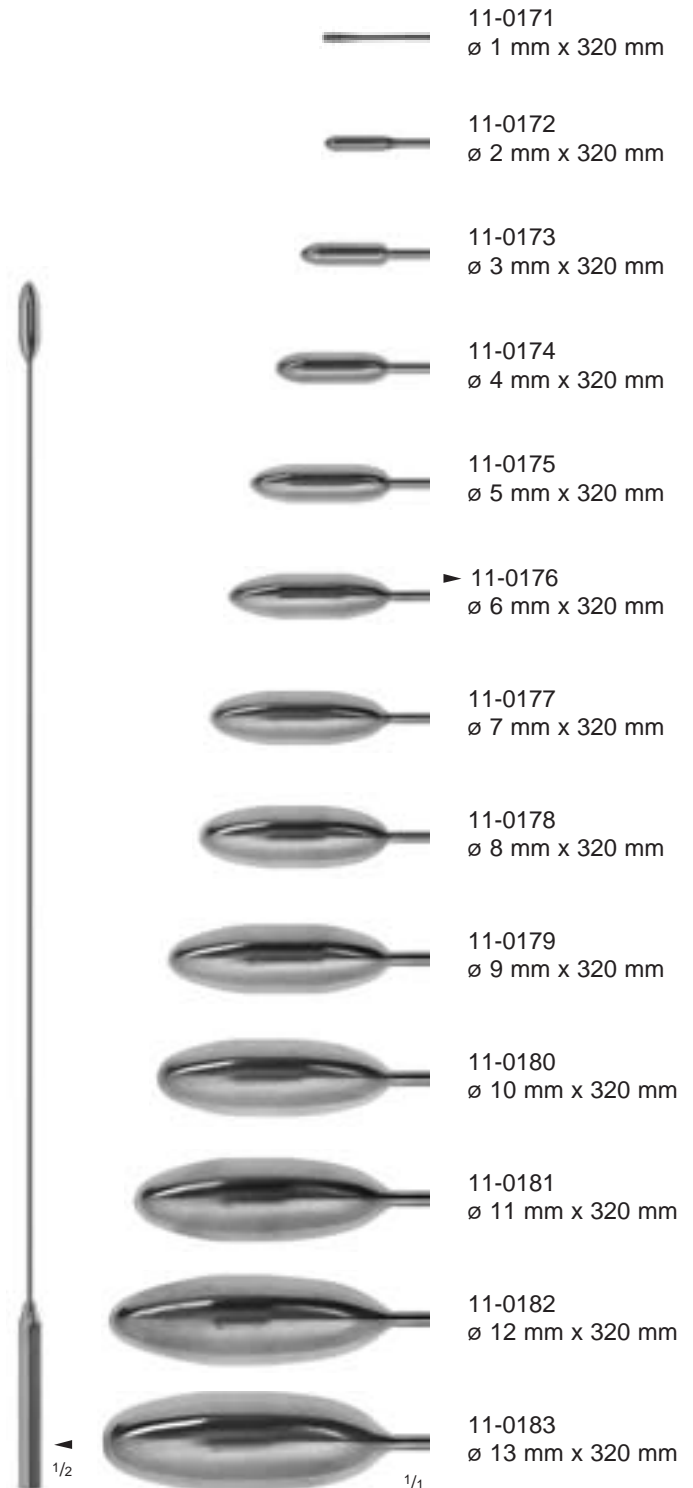

- 11-0171
ø 1 mm x 320 mm
- 11-0172
ø 2 mm x 320 mm
- 11-0173
ø 3 mm x 320 mm
- 11-0174
ø 4 mm x 320 mm
- 11-0175
ø 5 mm x 320 mm
- ▶ 11-0176
ø 6 mm x 320 mm
- 11-0177
ø 7 mm x 320 mm
- 11-0178
ø 8 mm x 320 mm
- 11-0179
ø 9 mm x 320 mm
- 11-0180
ø 10 mm x 320 mm
- 11-0181
ø 11 mm x 320 mm
- 11-0182
ø 12 mm x 320 mm
- 11-0183
ø 13 mm x 320 mm

BAKES
11-0170

Satz von 13 Gallengang-Dilatationsoliven 11-0171 bis 11-0183, biegsam, in Plastiktasche (11-0186)

Set of 13 common bile duct dilators 11-0171 to 11-0183, malleable, in plastic roll (11-0186)

Juego de 13 dilatadores para el conducto biliar del 11-0171 al 11-0183, maleable, en bolsa de plástico (11-0186)

Jeu de 13 dilatateurs biliaires du 11-0171 au 11-0183 malléables en sachet plastique (11-0186)

Set di 13 dilatatori per condotti biliari dal 11-0171 al 11-0183, malleabili, con rotolo di plastica (11-0186)

Gallensteinlöffel
 Gall Stone Scoops
 Cucharillas para los cálculos biliares
 Curettes pour calculs biliaires
 Cucchiari per calcoli biliari

Gallenblasenlöffel
 Gall bladder scoop
 Cucharilla para la vesicula biliar
 Cuiller pour vésicule biliaire
 Cucchiaio per colecisti



MAYO
 11-0200
 27,5 cm, 10^{3/4}"

Gallensteinlöffel
 Gall Stone Scoops
 Cucharillas para los cálculos biliares
 Curettes pour calculs biliaires
 Cucchiari per calcoli biliari

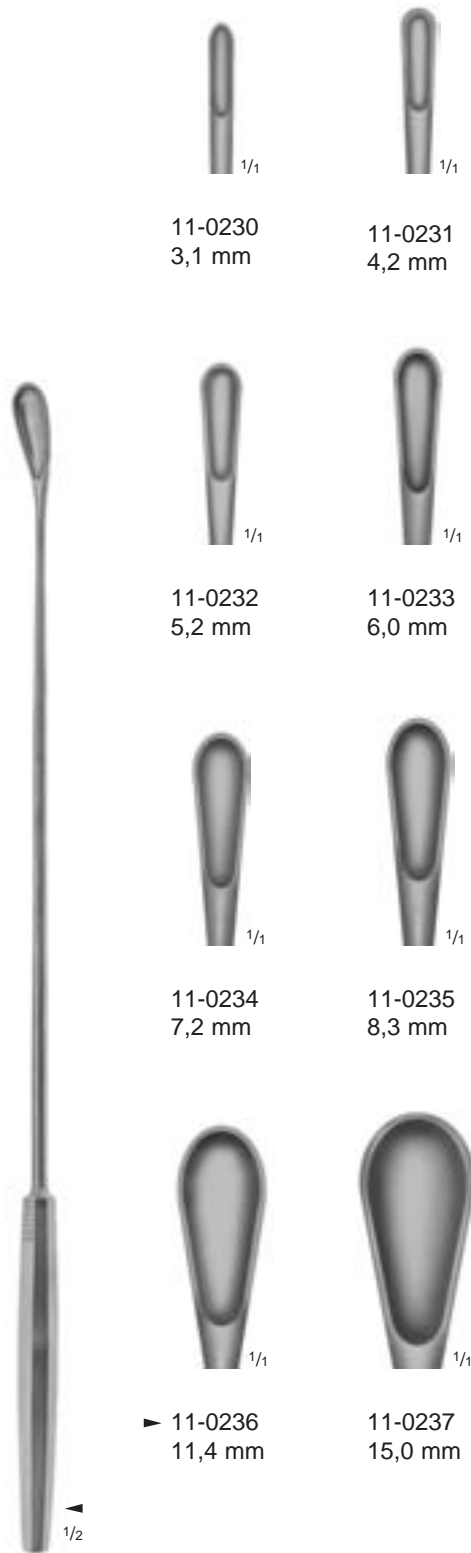

LUER-KOERTE
 11-0230
 - 11-0237
 31 cm, 12^{1/4}"

Gallensteinlöffel, biegsam
 Gall Stone Scoops, malleable
 Cucharillas para los cálculos biliares, maleable
 Curettes pour calculs biliaires, malléables
 Cucchiari per calcoli biliari, malleabili



MOORE
 11-0240
 30 cm, 12"

Gallenblasenlöffel
 Gall bladder scoop
 Cucharilla para la vesicula biliar
 Cuillère pour vésicule biliaire
 Cucchiaio per colecisti



Gallensteinzangen
Gall Stone Forceps
Pinzas para los cálculos biliares
Pinces pour calculs biliaires
Pince per calcoli biliari



1/1

► 11-0309
21 cm, 8 1/4"



1/1

11-0310
21 cm, 8 1/4"

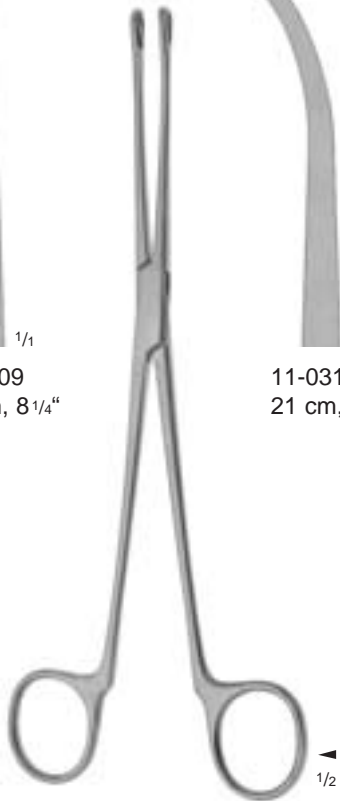

1/2

BLAKE
11-0309
- 11-0310



1/1

► 11-0314
20,5 cm, 8"



1/1

11-0315
20,5 cm, 8"

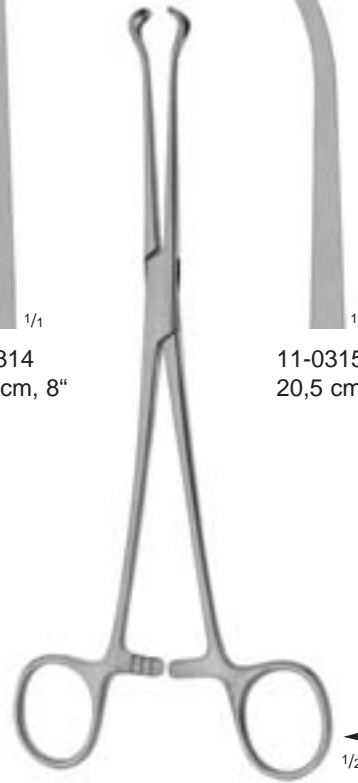

1/2

MAYO-BLAKE
11-0314
- 11-0315

Gallensteinzangen
 Gall Stone Forceps
 Pinzas para los cálculos biliares
 Pincès pour calculs biliaires
 Pince per calcoli biliari



MIXTER
 11-0305
 22,5 cm, 9"



11-0300
 23 cm, 9"

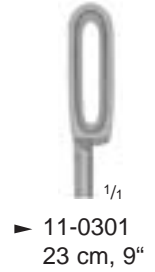

▶ 11-0301
 23 cm, 9"



DESJARDINS
 11-0300
 - 11-0301



Nierensteinzangen
Kidney Stone Forceps
Pinzas para los cálculos renales
Pinces pour les calculs rénaux
Pinze per calcoli renali

▶ 92-0504
23 cm, 9"

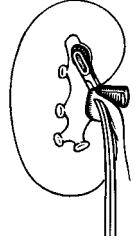

92-0503
20,5 cm, 8"

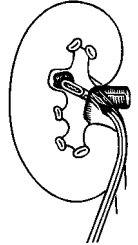

92-0502
19 cm, 7 1/2"

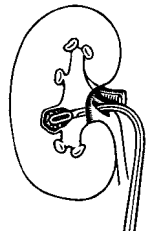

RANDALL
92-0501
- 92-0504

92-0501
18 cm, 7"

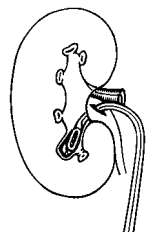

Nierensteinzangen
 Kidney Stone Forceps
 Pinzas para los cálculos renales
 Pincés pour les calculs rénaux
 Pinze per calcoli renali

Nierenfaßzange
 Kidney Elevating Forceps
 Pinza para sostener el riñón
 Pince pour la préhension du rein
 Pinza per afferrare il rene



▶ 92-0505
 19 cm, 7 1/2"

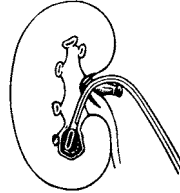

92-0506
 19 cm, 7 1/2"

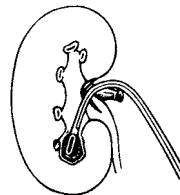

RANDALL
 92-0505
 - 92-0506

Nierensteinzangen
 Kidney Stone Forceps
 Pinzas para los cálculos renales
 Pincés pour les calculs rénaux
 Pinze per calcoli renali



1/1



DARTIGUES
 96-0815
 28 cm, 11"

Nierenfaßzange
 Kidney elevating forceps
 Pinza para sostener el riñón
 Hystérolabe
 Pinza per afferrare il rene



Prostatahaken
 Prostatic Retractors
 Separadores para la prostata
 Ecarteurs prostatiques
 Retrattori prostatici

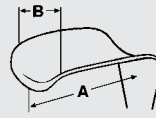

23 x 25 mm (AxB)



68 x 38 mm (AxB)



36 x 13 mm (AxB)



36 x 38 mm (AxB)



YOUNG
 92-0200
 23 cm, 9"

Bulbus-Haken
 Bulbus hook
 Gancho para el bulbus
 Crochet en bulbus
 Bulbo ad uncino



YOUNG
 92-0205
 22 cm, 8³/₄"

anterior
 anterior
 anterior
 antérieur
 anteriore



YOUNG
 92-0210
 22,5 cm, 9"

lateral
 lateral
 lateral
 latéral
 laterale



YOUNG
 92-0215
 21,5 cm, 8¹/₂"

gegabelt
 forked
 horquilla
 en fourche
 a forchetta



MILLIN
 92-0256
 29,5 cm, 11 3/4"
 Blasenhalsspreizer
 Bladder neck spreader
 Dilatador para el cuello vesical
 Dilatateur vésicale
 Dilatatore per collo vescicale

1/2



MILLIN
 92-0251
 23 cm, 9"

KapselFaßzange, zur retropubi-
 schen Prostatektomie

Capsule forceps, for retropubic
 prostatectomy

Pinza capsular para prostatectomía
 retropúbica

Pince pour saisir les capsules, pour
 prostatectomie rétropubienne

Pinza per prendere capsule, per
 prostatectomia retropubica

1/2



MILLIN
 92-0252
 23 cm, 9"

Faßzange, 8x7 Zähne, für die vor-
 deren Lappen

Prostatic lobe holding forceps, for
 anterior lobes, 8x7 teeth

Pinza para coger los lóbulos anterior-
 res, 8x7 dientes

Pince pour saisir les lambeaux
 antérieurs, 8x7 dents

Pinza per afferrare i lobi prostatici
 anteriori, 8x7 denti

1/2



MILLIN
 92-0255
 24 cm, 9 1/2"

Fadenführungs-
 zange

Ligature carrying forceps

Pinza porta-ligaduras supra-pubiana

Pince porte-fil

Pinza portafilo

1/2



Dilatationsbougies
 Dilating Bougies
 Bujías dilatadoras
 Bougies dilatatrices
 Candelette dilatatrici

Metallkatheter
 Metal Catheters
 Sondas metálicas
 Sondes vésicales métalliques
 Cateteri metallici



VAN BUREN	Ø mm	Charr. (French)
92-1408	2 ² / ₃	8
92-1410	3 ¹ / ₃	10
92-1412	4	12
92-1414	4 ² / ₃	14
▶ 92-1416	5 ¹ / ₃	16
92-1418	6	18
92-1420	6 ² / ₃	20
92-1422	7 ¹ / ₃	22
92-1424	8	24
92-1426	8 ² / ₃	26
92-1428	9 ¹ / ₃	28
92-1430	10	30
92-1432	10 ² / ₃	32
92-1434	11 ¹ / ₃	34
92-1436	12	36

27,5 cm, 10³/₄"

Dilatationsbougies
 Dilating bougies
 Bujías dilatadoras
 Bougies dilatatrices
 Candelette dilatatrici



	Ø mm	Charr. (French)
▶ 92-1752	2 ² / ₃	8
92-1754	3 ¹ / ₃	10
92-1756	4	12
92-1758	4 ² / ₃	14
92-1760	5 ¹ / ₃	16
92-1762	6	18
92-1764	6 ² / ₃	20

15 cm, 6"

Metallkatheter für Frauen
 Metal catheters for women
 Sondas metálicas para mujeres
 Sondes vésicales métalliques pour femmes
 Cateteri metallici per donne



	Ø mm	Charr. (French)
▶ 92-1730	2 ² / ₃	8
92-1732	3 ¹ / ₃	10
92-1734	4	12
92-1736	4 ² / ₃	14
92-1738	5 ¹ / ₃	16
92-1740	6	18
92-1742	6 ² / ₃	20

25 cm, 10"

Metallkatheter für Männer
 Metal catheters for men
 Sondas metálicas para hombres
 Sondes vésicales métalliques pour hommes
 Cateteri metallici per uomini



GUYON
 92-0480
 39 cm, 15 1/2"

Katheter-
Einführungsinstrument
 Catheter introducing
instrument
 Instrumento para
introducir catéteres
 Mandrin pour sondes en
gomme
 Strumento per introdurre
cateteri o sonde



GUYON
 92-0481
 35 cm, 13 3/4"

Katheterspanner und
Einführungsinstrument
 Catheter guide (introducer)
 Guía para catéteres
(introductor)
 Mandrin pour sondes
 Catetere guida (interoduttore)



DITTEL
 92-0486
 46 cm, 18"

Katheterspanner und
Einführungsinstrument
 Catheter guide (introducer)
 Guía para catéteres
(introductor)
 Mandrin pour sondes
 Catetere guida (interoduttore)



92-0544
 14,5 cm, 5 3/4"

Klemme zum Fixieren des
Samenstrangs
 Fixation clamp for the sperma-
tic cord
 Pinza para fijar el cordón
espermático
 Pince pour fixer le cordon
spermatique
 Pinza per fissare il tronco
spermatico



92-0546
 27 cm, 10 3/4"

Sekretlöffel, biegsam
 Secretion curette,
malleable
 Cucharilla para secreción,
maleable
 Cuillères pour prélèvements
des sécrétions, malléables
 Curetta per secrezioni,
malleabile



Urologie-Instrumente
Genito-Urinary Instruments
Instrumentos para la urología
Instruments pour l'urologie
Strumenti per l'urologia

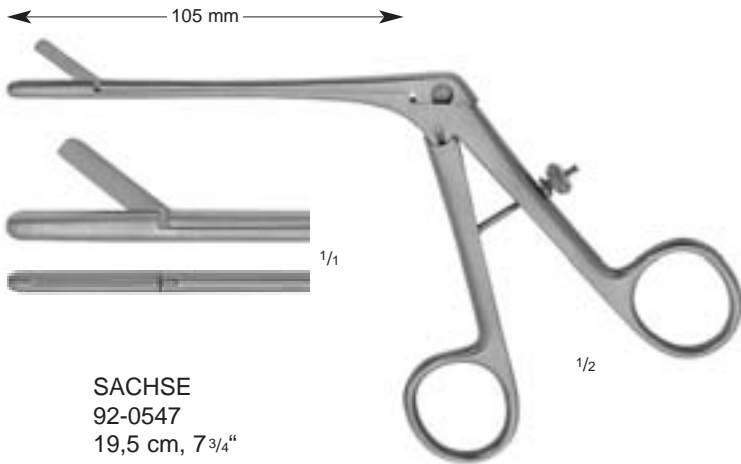

SACHSE
92-0547
19,5 cm, 7³/₄"

Meatotom
Meatotome
Meatotomy
Méatotome
Meatotomo



92-0549

KNUTSON
92-0548

Urethrographie-Instrument, bestehend aus verstellbarer Penishalterung mit verschiebbarer Kanüle mit Konus (92-0549)

Urethrography-instrument consisting of holder, penile, adjustable with sliding cannula with cone (92-0549)

Instrumento de uretrografia, compuesto del soporte para el penis ajustable, con cánula regulable con cono (92-0549)

Uréthrographe avec support réglable pour le pénis, canule à robinet, avec embout (92-0549)

Strumento per ureterografia, composto da supporto per il pene regolabile, con cannula scorrevole e cono (92-0549)

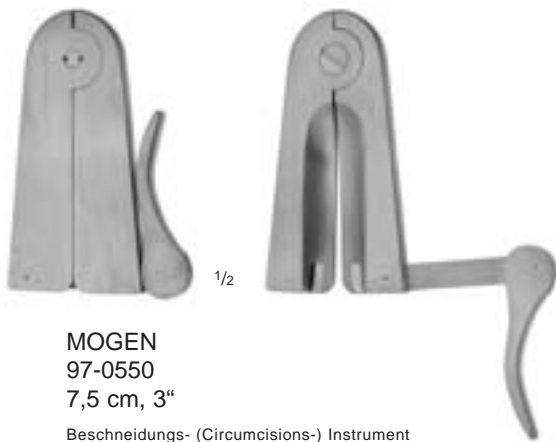

MOGEN
97-0550
7,5 cm, 3"

Beschneidungs- (Circumcisions-) Instrument
Circumcision instrument
Instrumento para circuncisión
Instrument de circoncision
Strumento per circoncisione



97-0552 ø 8 mm

für Säuglinge • baby size • para bebés • pour bébés • per neonati

97-0553 ø 11 mm

97-0554 ø 13 mm

für Knaben • child size • para niños • pour garçons • per bambini

► 97-0555 ø 16 mm

97-0556 ø 21 mm

für Jugendliche • adolescent size • para adolescentes • pour adolescents • per adolescenti

97-0557 ø 26 mm

97-0558 ø 32 mm

für Männer • men's size • para hombres • pour hommes • per uomini

Beschneidungs- (Circumcisions-) Instrumente
Circumcision instruments
Instrumentos para circuncisión
Instruments de circoncision
Strumenti per circoncisione



STOCKMANN
92-0370
8 cm, 3¹/₈"

Penisklemme
Penis clamp
Compresseur urétral
Compresseur de l'urètre
Serrapene



STRAUSS
92-0372
11 cm, 4³/₈"

Penisklemme
Penis clamp
Compresseur urétral
Compresseur de l'urètre
Serrapene

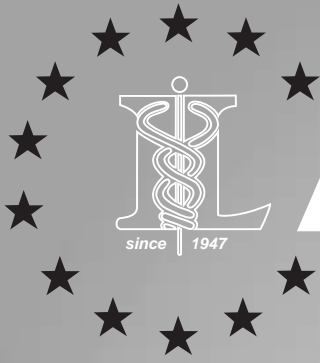

LAWNTON

Medizintechnik



Gynäkologie
Gynecology
Ginecología
Gynécologie
Ginecologia



Instrumente für Gynäkologie
 Instruments for Gynecology
 Instrumentos para ginecología
 Instruments pour gynécologie
 Strumenti per ginecologia



Polypen- und Ovarienzangen	Seite	23, 389
Polypus and Ovum Forceps	Page	23, 389
Pinzas para pólipos uterinos y ovarios	Página	23, 389
Pinces à polypes et ovaires	Page	23, 389
Pinze per polipi e ovaie	Pagina	23, 389



DURACUT® Gynäkologische Scheren mit Hartmetallschneiden	Seite	60
DURACUT® Gynecological Scissors with tungsten carbide edges	Page	60
DURACUT® Tijeras para ginecología con filos de carburo tungsteno	Página	60
DURACUT® Ciseaux pour gynécologie avec des lames en tungstène	Page	60
DURACUT® Forbici per ginecologia con lame in carburo di tungsteno	Pagina	60



Uterusscheren	Seite	86, 104 - 106
Uterine Scissors	Page	86, 104 - 106
Tijeras para el útero	Página	86, 104 - 106
Ciseaux utérins	Page	86, 104 - 106
Forbici per utero	Pagina	86, 104 - 106



Hysterektomieklemmen	Seite	194 - 196
Hysterectomy Forceps	Page	194 - 196
Pinzas-clamps para hysterectomía	Página	194 - 196
Pinces à hystérectomie	Page	194 - 196
Pinze per isterectomia	Pagina	194 - 196



ATRAUMATIC-GRIP Hysterektomieklemmen	Seite	197
ATRAUMATIC-GRIP Hysterectomy Forceps	Page	197
ATRAUMATIC-GRIP Pinzas-clamps para hysterectomía	Página	197
ATRAUMATIC-GRIP Pinces à hystérectomie	Page	197
ATRAUMATIC-GRIP Pinze per isterectomia	Pagina	197



Tamponzangen	Seite	205, 208
Uterine Dressing Forceps	Page	205, 208
Pinzas para tampones	Página	205, 208
Pinces à pansements	Page	205, 208
Pinze per medicature	Pagina	205, 208



Tupfer- und Schwammzangen	Seite	209 - 210
Dressing and Sponge Holding Forceps	Page	209 - 210
Pinzas para torundas y esponjas	Página	209 - 210
Pinces à tampons et éponges	Page	209 - 210
Pinze per tamponi e spugne	Pagina	209 - 210



Fistelhaken	Seite	221
Fistula Hooks	Page	221
Ganchos para fístulas	Página	221
Crochets pour les fistules	Page	221
Uncini per fistole	Pagina	221



Scheidenspekula	Seite	248, 304
Vaginal Specula	Page	248, 304
Espéculos vaginales	Página	248, 304
Spéculums vaginaux	Page	248, 304
Speculi vaginali	Pagina	248, 304



Scheidenhalter	Seite	254
Vaginal Retractors	Page	254
Valvas vaginales	Página	254
Valves vaginales	Page	254
Retrattori vaginali	Pagina	254



Vulva-Spreizer	Seite	281
Vaginal Retractors	Page	281
Separadores para la vulva	Página	281
Ecarteurs vulvaires	Page	281
Divaricatori vaginali	Pagina	281



Uterusfaßzange	Seite	421
Uterine Elevating Forceps	Page	421
Pinzas para el útero	Página	421
Pinces hystérolabes	Page	421
Pinze per sollevare l'utero	Pagina	421





Scheidenspekula
Vaginal Specula
Espécules vaginales
Spéculums vaginaux
Speculi vaginali

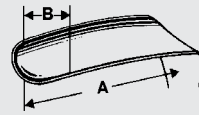

CUSCO
95-0010
75 x 17 mm (AxB)

Scheidenspekulum für Jungfrauen, mit seitlicher Stellschraube, Griff umlegbar

Vaginal speculum for virgins with lateral fixation screw, tilt-down handle

Espéculo vaginal para vírgenes, con tornillo de sujeto lateral, mango plegable

Spéculum vaginal pour vierges, avec fixation latérale à vis

Speculo vaginale per vergini, con vite di regolazione laterale



CUSCO
95-0197 75 x 32 mm (AxB)
▶ 95-0198 85 x 35 mm (AxB)
95-0199 100 x 35 mm (AxB)

Scheidenspekula mit seitlicher Stellschraube, Griff umlegbar

Vaginal specula with lateral fixation screw, tilt-down handle

Espécules vaginales con tornillo de sujeto lateral, mango plegable

Spéculums vaginaux, avec fixation latérale à vis

Speculi vaginali, con vite di regolazione laterale



CUSCO
95-0030
75 x 17 mm (AxB)

Scheidenspekulum für Jungfrauen, mit zentraler Stellschraube, Griff umlegbar

Vaginal speculum for virgins with central fixation screw, tilt-down handle

Espéculo vaginal para vírgenes, con tornillo de sujeto central, mango plegable

Spéculum vaginal pour vierges, avec fixation centrale à vis

Speculo vaginale per vergini, con vite di regolazione centrale



CUSCO
▶ 95-0037 75 x 32 mm (AxB)
95-0038 85 x 35 mm (AxB)
95-0039 100 x 35 mm (AxB)

Scheidenspekula mit zentraler Stellschraube, Griff umlegbar

Vaginal specula with central fixation screw, tilt-down handle

Espécules vaginales con tornillo de sujeto central, mango plegable

Spéculums vaginaux, avec fixation centrale à vis

Speculi vaginali, con vite di regolazione centrale

Scheidenspekula
 Vaginal Specula
 Espécules vaginales
 Spéculums vaginaux
 Speculi vaginali

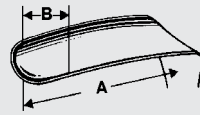

CUSCO

- 95-0015 90 x 22-25 mm (AxB)
- ▶ 95-0016 100 x 25-27 mm (AxB)
- 95-0017 105 x 27-30 mm (AxB)

Scheidenspekula, Schweizer Modell (konisch), mit seitlicher Stellschraube, Griff umlegbar

Vaginal specula, Swiss pattern, cone shaped, with lateral fixation screw, tilt-down handle

Espécules vaginales, modèle suisse (cônic), con tornillo de sujeción lateral, mango plegable

Spéculums vaginaux, modèle suisse (conique), avec fixation latérale à vis

Speculi vaginali, modello svizzero, profilo a cono con vite di regolazione laterale



TRELAT

- 95-0020 85 x 33 mm (AxB)
- ▶ 95-0021 95 x 35 mm (AxB)
- 95-0022 115 x 43 mm (AxB)

Scheidenspekula, parallel öffnend, Griff umlegbar

Vaginal specula, parallel opening, tilt-down handle

Espécules vaginales, apertura paralela, mango plegable

Spéculums vaginaux, à valves parallèles

Speculi vaginali, apertura parallela



COLLIN

- 95-0080 90 x 28 mm (AxB)
- ▶ 95-0081 100 x 35 mm (AxB)
- 95-0082 110 x 40 mm (AxB)

Scheidenspekula
 Vaginal specula
 Espécules vaginales
 Spéculums vaginaux
 Speculi vaginali



COLLIN-LANDAU

- 95-0085 90 x 28 mm (AxB)
- ▶ 95-0086 100 x 35 mm (AxB)
- 95-0087 110 x 40 mm (AxB)

Scheidenspekula, oberes Spekulablatt kürzer
 Vaginal specula, upper blade of specula shortened
 Espécules vaginales, valvas superior más corta
 Spéculums vaginaux, valve supérieure plus courte
 Speculi vaginali, valva superiore corta



Scheidenspekula
Vaginal Specula
Espéculos vaginales
Spéculums vaginaux
Speculi vaginali

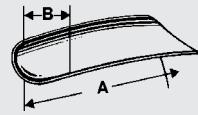

SEMM

- 95-0119 90 x 14-18 mm (AxB)
- ▶ 95-0120 100 x 17-20 mm (AxB)
- 95-0121 100 x 25-30 mm (AxB)

Scheidenspekula mit Doppelsperre,
für Einhandbedienung

Vaginal specula with double lock,
one-hand operated

Espéculos vaginales con cierre doble,
para el uso con una mano

Spéculums vaginaux, double ouverture
utilisé à la main

Speculi vaginali, a doppio fermo,
impiego con una mano

1/2

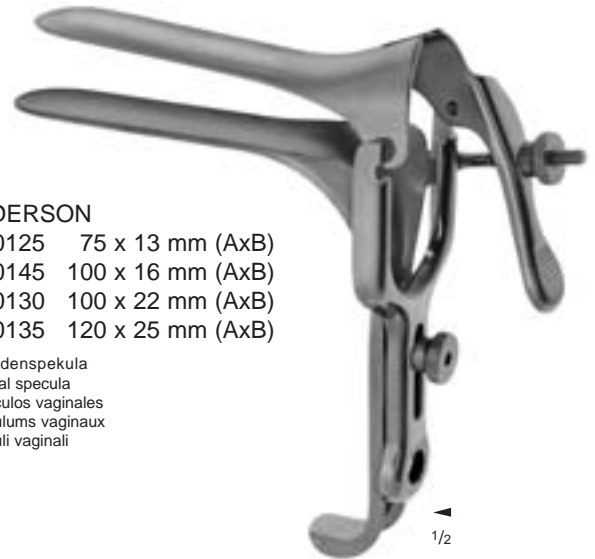

PEDERSON

- 95-0125 75 x 13 mm (AxB)
- 95-0145 100 x 16 mm (AxB)
- ▶ 95-0130 100 x 22 mm (AxB)
- 95-0135 120 x 25 mm (AxB)

Scheidenspekula
Vaginal specula
Espéculos vaginales
Spéculums vaginaux
Speculi vaginali

1/2

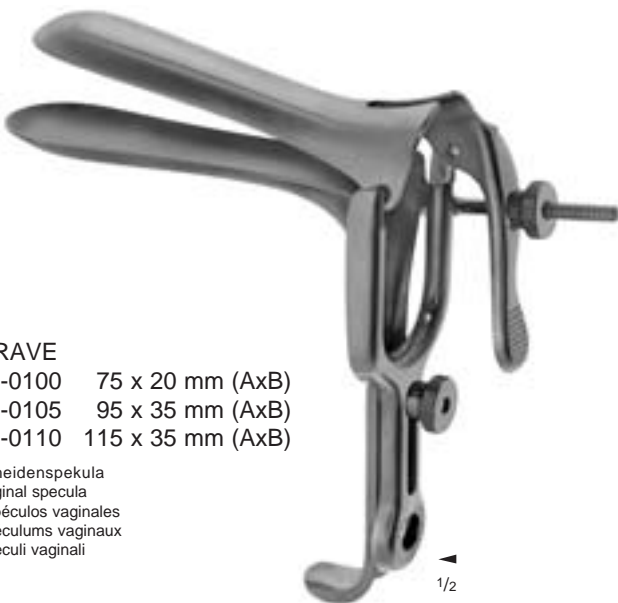

GRAVE

- 95-0100 75 x 20 mm (AxB)
- ▶ 95-0105 95 x 35 mm (AxB)
- 95-0110 115 x 35 mm (AxB)

Scheidenspekula
Vaginal specula
Espéculos vaginales
Spéculums vaginaux
Speculi vaginali

1/2



GRAVE modif.

- 95-0156
100 x 35 mm (AxB)

Scheidenspekulum, rechte Seite offen
Vaginal speculum, right side open
Espéculo vaginal, parte derecha abierta
Spéculum vaginaux, ouverts à droite
Speculo vaginale, apertura a destra

1/2

Scheidenspekula
Vaginal Specula
Espécúlos vaginales
Spéculums vaginaux
Speculi vaginali

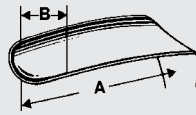

Oberfläche geschwärzt
Surface black-finish
Superficie negra
Surface noire
Superficie nera



PEDERSON

- 95-0040 75 x 13 mm (AxB)
- ▶ 95-0041 100 x 22 mm (AxB)
- 95-0042 120 x 25 mm (AxB)

Scheidenspekula für Laserchirurgie, mit Absaugung am oberen Blatt

Vaginal specula for laser surgery, suctioning from upper blade

Espécúlos vaginales para la cirugía con laser, tubo de succión en la valva superior

Spéculums vaginaux pour chirurgie laser, avec embout aspiration sur la valve supérieure

Speculi vaginali per chirurgia laser, aspirazione dalla valva superiore

1/2

PEDERSON

- 95-0045 75 x 13 mm (AxB)
- 95-0046 100 x 22 mm (AxB)
- 95-0047 120 x 25 mm (AxB)

Scheidenspekula für Laserchirurgie, mit Absaugung am unteren Blatt

Vaginal specula for laser surgery, suctioning from lower blade

Espécúlos vaginales para la cirugía con laser, tubo de succión en la valva inferior

Spéculums vaginaux pour chirurgie laser, avec embout aspiration sur la valve inférieure

Speculi vaginali per chirurgia laser, aspirazione dalla valva inferiore

Oberfläche geschwärzt
Surface black-finish
Superficie negra
Surface noire
Superficie nera



GRAVE

- 95-0050 75 x 20 mm (AxB)
- ▶ 95-0051 95 x 35 mm (AxB)
- 95-0052 115 x 35 mm (AxB)

Scheidenspekula für Laserchirurgie, mit Absaugung am oberen Blatt

Vaginal specula for laser surgery, suctioning from upper blade

Espécúlos vaginales para la cirugía con laser, tubo de succión en la valva superior

Spéculums vaginaux pour chirurgie laser, avec embout aspiration sur la valve supérieure

Speculi vaginali per chirurgia laser, aspirazione dalla valva superiore

1/2

GRAVE

- 95-0055 75 x 20 mm (AxB)
- 95-0056 95 x 35 mm (AxB)
- 95-0057 115 x 35 mm (AxB)

Scheidenspekula für Laserchirurgie, mit Absaugung am unteren Blatt

Vaginal specula for laser surgery, suctioning from lower blade

Espécúlos vaginales para la cirugía con laser, tubo de succión en la valva inferior

Spéculums vaginaux pour chirurgie laser, avec embout aspiration sur la valve inférieure

Speculi vaginali per chirurgia laser, aspirazione dalla valva inferiore



NOTT

- ▶ 95-0146 90 x 30 mm (AxB)
- 95-0147 110 x 30 mm (AxB)

Scheidenspekula
Vaginal specula
Espécúlos vaginales
Spéculums vaginaux
Speculi vaginali

1/2

DE VILBISS

- 95-0149 102 x 32 mm (AxB)

Scheidenspekulum
Vaginal speculum
Espécúlo vaginal
Spéculum vaginal
Speculo vaginale



1/2



Scheidenspekula und -halter
 Vaginal Specula and Retractors
 Espéculos y valvas vaginales
 Spéculums et valves vaginaux
 Speculi e valve vaginali

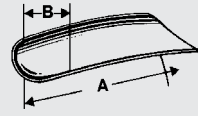

Satz aus je 1 Spekulum und 1 Halter
 Set of 1 speculum and 1 retractor each
 Juego de 1 espéculo y 1 valva
 Jeu de 1 spéculum et 1 valve
 Serie da 1 specolo e 1 valva

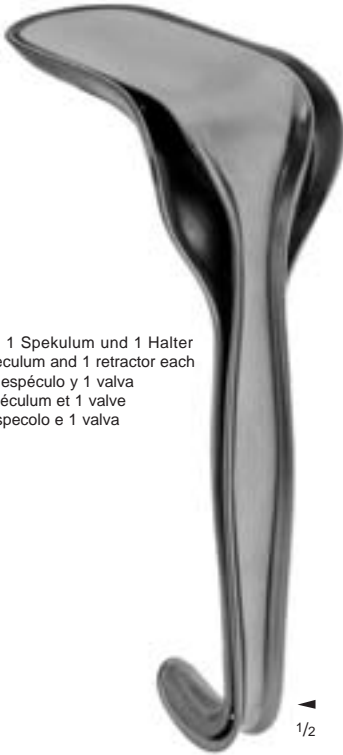

1/2

KALLMORGEN

- ▶ 95-1240 70 x 40 mm (AxB)
- 95-1244 90 x 40 mm (AxB)

Spekula allein
 Specula only
 Espéculos sueltos
 Spéculums seuls
 Solo speculi



1/2

KALLMORGEN

- ▶ 95-1241 70 x 40 mm (AxB)
- 95-1245 90 x 40 mm (AxB)

Halter allein
 Retractors only
 Valvas sueltas
 Valves seules
 Solo valve

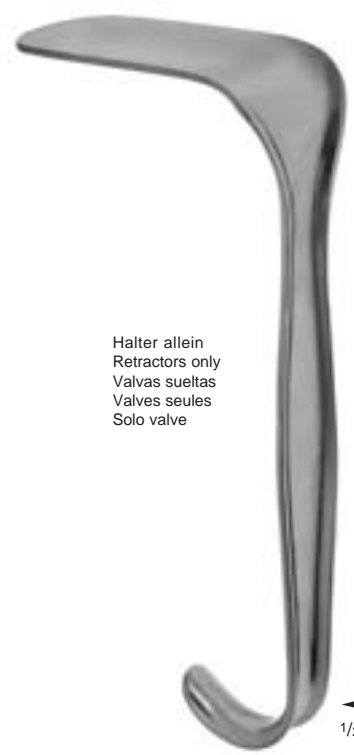

1/2

KALLMORGEN

- ▶ 95-1242 75 x 33 mm (AxB)
- 95-1246 95 x 33 mm (AxB)

Satz aus je 1 Spekulum und 1 Halter
 Set of 1 speculum and 1 retractor each
 Juego de 1 espéculo y 1 valva
 Jeu de 1 spéculum et 1 valve
 Set speculo e valva

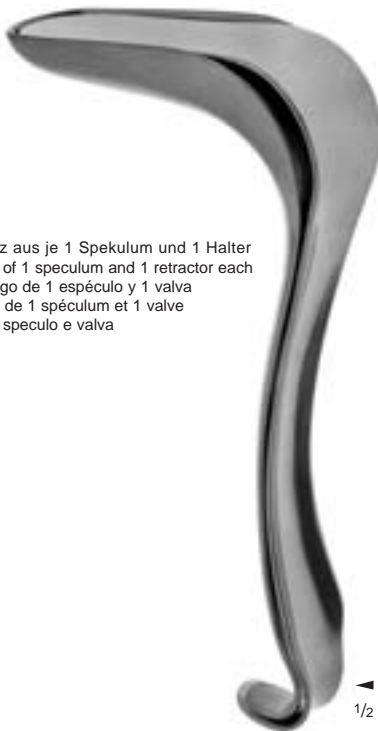

1/2

KRISTELLER

- 95-0296 70 x 27 mm (AxB)
- ▶ 95-0297 80 x 30 mm (AxB)
- 95-0298 90 x 36 mm (AxB)

Spekula allein
 Specula only
 Espéculos sueltos
 Spéculums seuls
 Solo speculi

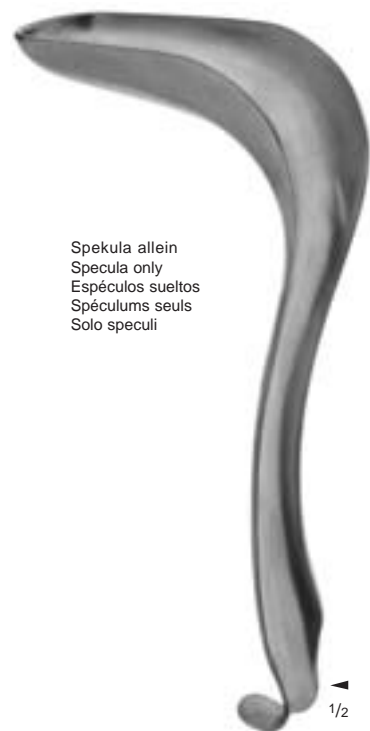

1/2

KRISTELLER

- 95-0290 70 x 27 mm (AxB)
- ▶ 95-0291 80 x 30 mm (AxB)
- 95-0292 90 x 36 mm (AxB)

Halter allein
 Retractors only
 Valvas sueltas
 Valves seules
 Solo valve



1/2

KRISTELLER

- 95-0293 75 x 23 mm (AxB)
- ▶ 95-0294 85 x 26 mm (AxB)
- 95-0295 100 x 32 mm (AxB)

Scheidenspekula und -halter
 Vaginal Specula and Retractors
 Espéculos y valvas vaginales
 Spéculums et valves vaginaux
 Speculi e valve vaginali

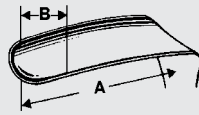

mit konisch verlaufenden Blättern, für Jungfrauen
 with conically shaped blades, virgin sizes
 con valvas de forma cónica, para vírgenes
 avec valves coniques, pour vierges
 con valve coniche, per vergini



KRISTELLER

- ▶ 95-1254 105 x 18 mm (AxB)
- 95-1255 105 x 21 mm (AxB)

Satz aus je 1 Spekulum und 1 Halter
 Set of 1 speculum and 1 retractor each
 Juego de 1 espéculo y 1 valva
 Jeu de 1 spéculum et 1 valve
 Set speculo e valva



KRISTELLER

- ▶ 95-1250 105 x 18 mm (AxB)
- 95-1251 105 x 21 mm (AxB)

Spekula allein
 Specula only
 Espéculos sueltos
 Spéculums seuls
 Solo speculi



KRISTELLER

- ▶ 95-1252 110 x 14 mm (AxB)
- 95-1253 110 x 17 mm (AxB)

Halter allein
 Retractors only
 Valvas sueltas
 Valves seules
 Solo valve



Scheidenspekula und -halter
 Vaginal Specula and Retractors
 Espéculos y valvas vaginales
 Spéculums et valves vaginaux
 Speculi e valve vaginali

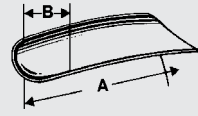

mit flachen Spekula
 specula flat hollow
 espéculos con huecos planos
 avec les spéculums plats
 con speculi piatti



KRISTELLER

- 95-1266 105 x 26 mm (AxB)
- ▶ 95-1267 105 x 28 mm (AxB)
- 95-1268 105 x 33 mm (AxB)

Satz aus je 1 Spekulum und 1 Halter
 Set of 1 speculum and 1 retractor each
 Juego de 1 espéculo y 1 valva
 Jeu de 1 spéculum et 1 valve
 Set speculo e valva

KRISTELLER

- 95-1260 105 x 26 mm (AxB)
- ▶ 95-1261 105 x 28 mm (AxB)
- 95-1262 105 x 33 mm (AxB)

Spekula allein
 Specula only
 Espéculos sueltos
 Spéculums seuls
 Solo speculi

KRISTELLER

- 95-1263 115 x 22 mm (AxB)
- ▶ 95-1264 115 x 24 mm (AxB)
- 95-1265 115 x 29 mm (AxB)

Halter allein
 Retractors only
 Valvas sueltas
 Valves seules
 Solo valve

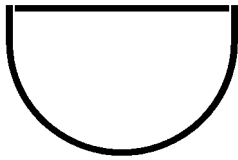
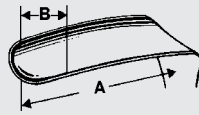

mit tiefen Spekula
 specula deep hollow
 espéculos con huecos profundos
 avec les spéculums profonds
 con speculi profondi



KRISTELLER

- 95-1215 110 x 27 mm (AxB)
- ▶ 95-1216 110 x 30 mm (AxB)
- 95-1217 110 x 36 mm (AxB)

Satz aus je 1 Spekulum und 1 Halter
 Set of 1 speculum and 1 retractor each
 Juego de 1 espéculo y 1 valva
 Jeu de 1 spéculum et 1 valve
 Set speculo e valva



KRISTELLER

- 95-1200 110 x 27 mm (AxB)
- ▶ 95-1201 110 x 30 mm (AxB)
- 95-1202 110 x 36 mm (AxB)

Spekula allein
 Specula only
 Espéculos sueltos
 Spéculums seuls
 Solo speculi



KRISTELLER

- 95-1210 115 x 23 mm (AxB)
- ▶ 95-1211 115 x 26 mm (AxB)
- 95-1212 115 x 32 mm (AxB)

Halter allein
 Retractors only
 Valvas sueltas
 Valves seules
 Solo valve



Scheidenspekula
Vaginal Specula
Espéculos vaginales
Spéculums vaginaux
Speculi vaginali

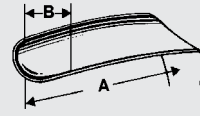

1/2

SIMS
95-0257 65 x 25 mm (Ax B)
70 x 30 mm (Ax B)
12,5 cm, 5"

95-0258 70 x 30 mm (Ax B)
70 x 35 mm (Ax B)
15,0 cm, 6"

95-0259 85 x 35 mm (Ax B)
90 x 40 mm (Ax B)
17,5 cm, 7"

Scheidenspekula, doppelendig
Vaginal specula, double-ended
Espéculos vaginales, dobles
Spéculums vaginaux, doubles
Speculi vaginali, doppi



1/2

BREISKY
95-0275 70 x 22 mm (Ax B)
76 x 25 mm (Ax B)
14,0 cm, 5 1/2"

95-0276 76 x 25 mm (Ax B)
82 x 30 mm (Ax B)
14,0 cm, 5 1/2"

▶ 95-0277 82 x 30 mm (Ax B)
95 x 38 mm (Ax B)
17,0 cm, 6 3/4"

95-0278 95 x 38 mm (Ax B)
102 x 44 mm (Ax B)
17,0 cm, 6 3/4"

Scheidenspekula, doppelendig
Vaginal specula, double-ended
Espéculos vaginales, dobles
Spéculums vaginaux, doubles
Speculi vaginali, doppi



1/2

JACKSON
95-0271 75 x 40 mm (Ax B)
▶ 95-0272 90 x 40 mm (Ax B)
95-0273 100 x 40 mm (Ax B)

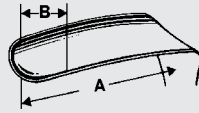

1/2

MATHIEU

- ▶ 95-1310 95 x 13-23 mm (AxB)
- 95-1311 95 x 16-30 mm (AxB)

Spekula allein
 Specula only
 Espécules sueltos
 Spéculums seuls
 Solo speculi



1/2

MATHIEU

- ▶ 95-1312 100 x 11-21 mm (AxB)
- 95-1313 100 x 14-27 mm (AxB)

Halter allein
 Retractors only
 Valvas sueltas
 Valves seules
 Solo valve



1/2

DOYEN

- ▶ 95-0215 60 x 30 mm (AxB)
- 95-0216 70 x 30 mm (AxB)
- 95-0217 80 x 30 mm (AxB)



Scheidenspekula
Vaginal Specula
Espécules vaginales
Spéculums vaginaux
Speculi vaginali

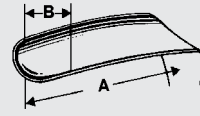

- MATZENAUER**
- 95-1350 125 x 15 mm (AxB)
 - 95-1351 125 x 20 mm (AxB)
 - ▶ 95-1352 125 x 25 mm (AxB)
 - 95-1353 125 x 30 mm (AxB)
 - 95-1354 125 x 35 mm (AxB)
 - 95-1355 125 x 40 mm (AxB)



- LANDAU**
- ▶ 95-0285 100 x 28 mm (AxB)
 - 95-0286 110 x 38 mm (AxB)



- BREISKY**
- 95-0175 100 x 15 mm (AxB)
 - 95-0176 100 x 20 mm (AxB)
 - ▶ 95-0177 100 x 25 mm (AxB)
 - 95-0178 100 x 30 mm (AxB)
 - 95-0179 100 x 35 mm (AxB)
 - 95-0180 100 x 40 mm (AxB)
 - 95-0222 130 x 15 mm (AxB)
 - 95-0225 130 x 20 mm (AxB)
 - 95-0226 130 x 25 mm (AxB)
 - 95-0227 130 x 30 mm (AxB)
 - 95-0228 130 x 35 mm (AxB)
 - 95-0229 130 x 40 mm (AxB)
 - 95-0244 160 x 40 mm (AxB)
 - 95-0245 180 x 40 mm (AxB)

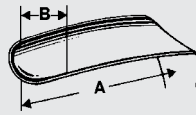

AUWARD-BERLIND
 95-0182
 102 x 45 mm (AxB)
 1,14 kg

Scheidenspekulum mit festem Gewicht und Löchern im Blatt

Vaginal speculum with fixed weight and holes in blade

Espécule vaginal con peso fijo y valva perforada

Spéculum vaginal avec poids fixe et valve à trous

Speculo vaginale con peso fisso e fori sulla lama



AUWARD
 95-0200
 83 x 38 mm (AxB)
 0,91 kg

► 95-0201
 83 x 38 mm (AxB)
 1,14 kg

95-0202
 83 x 38 mm (AxB)
 1,36 kg

Scheidenspekula mit festem Gewicht
 Vaginal specula with fixed weight
 Espécules vaginal con peso fijo
 Spéculums vaginal avec poids fixe
 Speculi vaginali con peso fisso



AUWARD
 95-1290
 102 x 45 mm (AxB)
 1,14 kg

Scheidenspekulum mit abnehmbarem Gewicht

Vaginal speculum with detachable weight

Espécule vaginal con peso desmontable

Spéculum vaginal avec poids démontable

Speculo vaginale a peso smontabile



Scheidenspekula
Vaginal Specula
Espécules vaginales
Spéculums vaginaux
Speculi vaginali

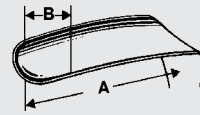

95-2001

95-2002
0,4 kg

95-2003
0,8 kg

SCHERBACK
95-2000

Satz, bestehend aus:
95-2001 1 Griff
95-2002 1 Gewicht 0,4 kg
95-2005 1 Blatt 80 x 30 mm
95-2006 1 Blatt 85 x 35 mm
95-2007 1 Blatt 85 x 40 mm
95-2008 1 Blatt 55 x 40-60 mm
95-2009 1 Blatt 70 x 45-70 mm



95-2005
80 x 30 mm (AxB)



95-2006
85 x 35 mm (AxB)



95-2007
85 x 40 mm (AxB)



95-2008
55 x 40-60 mm (AxB)



95-2009
70 x 45-70 mm (AxB)

Set, consisting of:
95-2001 1 Handle
95-2002 1 Weight 0.4 kg
95-2005 1 Blade 80 x 30 mm
95-2006 1 Blade 85 x 35 mm
95-2007 1 Blade 85 x 40 mm
95-2008 1 Blade 55 x 40-60 mm
95-2009 1 Blade 70 x 45-70 mm

Jeu, composé de:
95-2001 1 Manche
95-2002 1 Poids 0,4 kg
95-2005 1 Valve 80 x 30 mm
95-2006 1 Valve 85 x 35 mm
95-2007 1 Valve 85 x 40 mm
95-2008 1 Valve 55 x 40-60 mm
95-2009 1 Valve 70 x 45-70 mm

Juego, compuesto de:
95-2001 1 Mango
95-2002 1 Peso 0,4 kg
95-2005 1 Valva 80 x 30 mm
95-2006 1 Valva 85 x 35 mm
95-2007 1 Valva 85 x 40 mm
95-2008 1 Valva 55 x 40-60 mm
95-2009 1 Valva 70 x 45-70 mm

Serie, composta da:
95-2001 1 Manico
95-2002 1 Peso 0,4 kg
95-2005 1 Valva 80 x 30 mm
95-2006 1 Valva 85 x 35 mm
95-2007 1 Valva 85 x 40 mm
95-2008 1 Valva 55 x 40-60 mm
95-2009 1 Valva 70 x 45-70 mm



WEISSBARTH
95-0299
80 x 42 mm (AxB)

Scheidenspekulum mit abnehmbarem Auffangsieb
Vaginal speculum with removable strainer and perforated bottom
Espécule vaginal con tamiz desmontable
Spéculum vaginal avec tamis démontable
Speculo vaginale con filtro smontabile et fondo forato

Endospekula
Endospecula
Endoespécules
Endospéculum
Endospeculi

Uterus-Dilatator
Uterine Dilator
Dilatador uterino
Dilatateurs du col de l'utérus
Dilatatori uterini



KOGAN
95-0482
24 cm, 9 1/2"

Endospekulum für Harnröhre und Cervix, ohne Sperre
Endospeculum for cervix and urethra, without catch
Endoespécule para uretra y cerviz, sin cierre
Endospéculum pour urètre et col utérin, sans verrou
Endospeculo per cervice e uretra, senza cremagliera



KOGAN
95-0483
24 cm, 9 1/2"

Endospekulum für Harnröhre und Cervix, mit Skalensperre und Fixierschraube
Endospeculum for cervix and urethra, with scale-ratchet and fixing screws
Endoespécule para uretra y cerviz, con cierre graduado y tornillo fijador
Endospéculum pour urètre et col utérin crémaillère à vis
Endospeculo per cervice e uretra, con nottolino graduato e vite di fissaggio

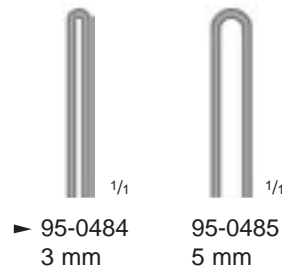

► 95-0484 3 mm
95-0485 5 mm



KOGAN
95-0484
- 95-0485
27 cm, 10 3/4"

Endospekula für Harnröhre und Cervix, mit Sperre
Endospecula for cervix and urethra, with catch
Endoespécules para uretra y cerviz, con cierre
Endospéculum pour urètre et col utérin avec crémaillère, avec verrou
Endospecoli per cervice e uretra, con cremagliera



GOODELL
95-0480
34 cm, 13 1/2"

Uterus-Dilatator
Uterine dilator
Dilatador uterino
Dilatateur du col de l'utérus
Dilatatore uterino



Uterus-Dilatatoren
 Uterine Dilators
 Dilatadores uterinos
 Dilatateurs du col de l'utérus
 Dilatatori uterini



1/2

HEGAR

- 95-0321 ø 1,0 mm
 - 95-0322 ø 2,0 mm
 - 95-0323 ø 3,0 mm
 - 95-0324 ø 4,0 mm
 - 95-0325 ø 5,0 mm
 - 95-0326 ø 6,0 mm
 - 95-0327 ø 7,0 mm
 - 95-0328 ø 8,0 mm
 - 95-0329 ø 9,0 mm
 - 95-0330 ø 10,0 mm
 - 95-0331 ø 11,0 mm
 - ▶ 95-0332 ø 12,0 mm
 - 95-0333 ø 13,0 mm
 - 95-0334 ø 14,0 mm
 - 95-0335 ø 15,0 mm
 - 95-0336 ø 16,0 mm
 - 95-0337 ø 17,0 mm
 - 95-0338 ø 18,0 mm
 - 95-0339 ø 19,0 mm
 - 95-0340 ø 20,0 mm
 - 95-0341 ø 21,0 mm
 - 95-0342 ø 22,0 mm
 - 95-0343 ø 23,0 mm
 - 95-0344 ø 24,0 mm
 - 95-0345 ø 25,0 mm
 - 95-0346 ø 26,0 mm
- 18,5 cm, 7 1/4"

mit glattem Muldengriff
 with sloped handle
 con mango aplanado
 à manche aplati
 con manico iclinato



1/2

HEGAR

- 95-1321 ø 1,5 mm
 - 95-1322 ø 2,5 mm
 - 95-1323 ø 3,5 mm
 - 95-1324 ø 4,5 mm
 - 95-1325 ø 5,5 mm
 - 95-1326 ø 6,5 mm
 - 95-1327 ø 7,5 mm
 - 95-1328 ø 8,5 mm
 - 95-1329 ø 9,5 mm
 - 95-1330 ø 10,5 mm
 - 95-1331 ø 11,5 mm
 - ▶ 95-1332 ø 12,5 mm
 - 95-1333 ø 13,5 mm
 - 95-1334 ø 14,5 mm
 - 95-1335 ø 15,5 mm
 - 95-1336 ø 16,5 mm
 - 95-1337 ø 17,5 mm
- 18,5 cm, 7 1/4"

mit glattem Muldengriff
 with sloped handle
 con mango aplanado
 à manche aplati
 con manico iclinato



1/2

HEGAR

- 95-0379 ø 2,0 / 3,0 mm
 - 95-0381 ø 3,0 / 4,0 mm
 - 95-0382 ø 5,0 / 6,0 mm
 - 95-0383 ø 7,0 / 8,0 mm
 - 95-0384 ø 9,0 / 10,0 mm
 - ▶ 95-0385 ø 11,0 / 12,0 mm
 - 95-0386 ø 13,0 / 14,0 mm
 - 95-0387 ø 15,0 / 16,0 mm
 - 95-0388 ø 17,0 / 18,0 mm
 - 95-0391 ø 19,0 / 20,0 mm
 - 95-0396 ø 21,0 / 22,0 mm
 - 95-0397 ø 23,0 / 24,0 mm
 - 95-0399 ø 25,0 / 26,0 mm
- 20 cm, 8"

Uterus-Dilatatoren
 Uterine Dilators
 Dilatadores uterinos
 Dilatateurs du col de l'utérus
 Dilatatori uterini



1/4

▲
 mit glattem Muldengriff
 with sloped handle
 con mango aplanado
 à manche aplati
 con manico iclinato
 ▼



1/4



1/4

HEGAR 95-0360

Dilatatorensatz, bestehend aus:

- 95-0324 - 95-0337 14 Dilatatorensätze Ø 4-17 mm
- 95-0364 1 Lagerungssieb für Dilatatorensätze Ø 4-12 mm
- 95-0365 1 Lagerungssieb für Dilatatorensätze Ø 13-17 mm
- 95-0366 1 Metallkoffer mit Scharnierdeckel 205 x 105 x 45 mm (BxTxH)

Dilator set, consisting of:

- 95-0324 - 95-0337 14 Dilators Ø 4-17 mm
- 95-0364 1 Rack for dilators Ø 4-12 mm
- 95-0365 1 Rack for dilators Ø 13-17 mm
- 95-0366 1 Metal case with hinged lid 205 x 105 x 45 mm (wxdxh)

Juego de dilatadores, compuesto de:

- 95-0324 - 95-0337 14 Dilatadores de Ø 4-17 mm
- 95-0364 1 Soporte para dilatadores de Ø 4-12 mm
- 95-0365 1 Soporte para dilatadores de Ø 13-17 mm
- 95-0366 1 Estuche de metal con tapa de bisagra 205 x 105 x 45 mm

Jeu de dilateurs, composé de:

- 95-0324 - 95-0337 14 Dilateurs de Ø 4-17 mm
- 95-0364 1 chevalet pour dilateurs de Ø 4-12 mm
- 95-0365 1 chevalet pour dilateurs de Ø 13-17 mm
- 95-0366 1 Boîte métal avec couvercle à charnière 205 x 105 x 45 mm

Set dilatatori, composto da:

- 95-0324 - 95-0337 14 Dilatatori Ø 4-17 mm
- 95-0364 1 Supporto di Ø 4-12 mm
- 95-0365 1 Supporto di Ø 13-17 mm
- 95-0366 1 Scatola metallica con coperchio a cerniera 205 x 105 x 45 mm

HEGAR 95-0362

Dilatatorensatz, bestehend aus:

- 95-0321 - 95-0346 26 Dilatatorensätze Ø 1-26 mm
- 95-0367 1 Lagerungssieb für Dilatatorensätze Ø 1-17 mm
- 95-0368 1 Lagerungssieb für Dilatatorensätze Ø 18-26 mm
- 95-0369 1 Metallkoffer mit Scharnierdeckel 310 x 210 x 55 mm (BxTxH)

Dilator set, consisting of:

- 95-0321 - 95-0346 26 Dilators Ø 1-26 mm
- 95-0367 1 Rack for dilators Ø 1-17 mm
- 95-0368 1 Rack for dilators Ø 18-26 mm
- 95-0369 1 Metal case with hinged lid 310 x 210 x 55 mm (wxdxh)

Juego de dilatadores, compuesto de:

- 95-0321 - 95-0346 26 Dilatadores de Ø 1-26 mm
- 95-0367 1 Soporte para dilatadores de Ø 1-17 mm
- 95-0368 1 Soporte para dilatadores de Ø 18-26 mm
- 95-0369 1 Estuche de metal con tapa de bisagra 310 x 210 x 55 mm

Jeu de dilateurs, composé de:

- 95-0321 - 95-0346 26 Dilateurs de Ø 1-26 mm
- 95-0367 1 chevalet pour dilateurs de Ø 1-17 mm
- 95-0368 1 chevalet pour dilateurs de Ø 18-26 mm
- 95-0369 1 Boîte métal avec couvercle à charnière 310 x 210 x 55 mm

Set dilatatori, composto da:

- 95-0321 - 95-0346 26 Dilatatori Ø 1-26 mm
- 95-0367 1 Supporto di Ø 1-17 mm
- 95-0368 1 Supporto di Ø 18-26 mm
- 95-0369 1 Scatola metallica con coperchio a cerniera 310 x 210 x 55 mm

HEGAR 95-0380

Dilatatorensatz, bestehend aus:

- 95-0381 - 95-0388 8 Dilatatorensätze Ø 3/4 - 17/18 mm
- 95-0389 1 auskochbare Segeltuchrolle

Dilator set, consisting of:

- 95-0381 - 95-0388 8 Dilators Ø 3/4 - 17/18 mm
- 95-0389 1 Boilable canvas roll

Juego de dilatadores, compuesto de:

- 95-0381 - 95-0388 8 Dilatadores de Ø 3/4 - 17/18 mm
- 95-0389 1 Bolsa de tela esterilizable por ebullición

Jeu de dilateurs, composé de:

- 95-0381 - 95-0388 8 Dilateurs de Ø 3/4 - 17/18 mm
- 95-0389 1 Trousse stérilisable par ébullition

Set dilatatori, composto da:

- 95-0381 - 95-0388 8 Dilatatori Ø 3/4 - 17/18 mm
- 95-0389 1 Borsa telata sterilizzabile



Uterussonden
Uterine Probes
Histerómetros
Hystéromètres
Isterometri

∅ 4,0 mm



1/2

SIMS
95-0390
34 cm, 13 1/2"

mit Zolleinteilung,
biegsam, versilbert

graduated in inch,
malleable, silver-plated

graduado en pulgadas,
maleable, plateado

gradué, en pouces, malléable,
argent

graduato in pollice, malleabile,
placcato in argento

∅ 4,0 mm



1/2

SIMS
95-0392
34 cm, 13 1/2"

mit Zentimetereinteilung,
biegsam, versilbert

graduated in centimeters,
malleable, silver-plated

graduado en centímetros,
maleable, plateado

gradué en cm, malléable,
argent

graduato in cm, malleabile,
placcato in argento

∅ 4,0 mm



1/2

SIMS
95-0405
34 cm, 13 1/2"

mit Zentimetereinteilung,
biegsam, 18/8 Stahl

graduated in centimeters,
malleable, 18/8 steel

graduado en centímetros,
maleable, acero 18/8

gradué en cm, malléable,
acier inox

graduato in cm, malleabile,
acciaio inox 18/8

∅ 4,0 mm



1/2

SIMPSON
95-0401
34 cm, 13 1/2"

mit Zentimetereinteilung,
biegsam, versilbert

graduated in centimeters,
malleable, silver-plated

graduado en centímetros,
maleable, plateado

gradué en cm, malléable,
argent

graduato in cm, malleabile,
placcato in argento

∅ 4,0 mm



1/2

VALLEIX
95-0406
29 cm, 11 1/2"

mit Zentimetereinteilung und
Schieber, biegsam, versilbert

graduated in centimeters, with
slider, malleable, chromium plated

graduado en centímetros con
un cursor, maleable, cromado

gradué en cm avec curseur,
malléable, chromé

graduato in cm, con cursore,
malleabile, cromato

Uterus-Depressor
 Uterine Depressor
 Depresores uterinos
 Dépresseur utérin
 Depressori uterini

Tamponadeführer
 Uterine Gauze Packer
 Conductor de tapónes
 Conducteur porte-tampon
 Porta garza uterino

IUP (Intrauterinpeßsar)- Faßzangen
 IUD (Intra Uterine Device)- Forceps
 Pinzas-DIU (Dispositivo Intra-Uterino)
 Pincas-DIU
 Pinza intra-uterina



ø 9,0 mm



1/2

95-0408
 20,5 cm, 8"

Konisationsstift
 Conisation pin
 Clavija cónica
 Conique
 Punta conica



24 mm

28 mm

1/2

BRAUN
 95-0410
 27 cm, 10 3/4"

Uterus-Depressor
 Uterine depressor
 Depresor uterino
 Dépresseur utérin
 Depressori uterini



1/2

AMANN
 95-0414
 33 cm, 13"

Tamponadeführer
 Uterine gauze packer
 Conductor de tapónes
 Conducteur porte-tampon
 Porta garza uterino



1/1



1/2

► 95-0300 ø 3 mm x 220 mm
 95-0301 ø 3 mm x 285 mm

IUP (Intrauterinpeßsar)- Faßzangen
 mit flexiblem Schaft

IUD (Intra Uterine Device)- Forceps
 with flexible shaft

Pinzas-DIU (Dispositivo Intra-Uterino)
 con vástago flexible

Pince-DIU tige flexible

Pinza intra-uterina con asta flessibile



Instrumente für Laserchirurgie, Oberfläche geschwärzt
 Instruments for Laser Surgery, surface black-finish
 Instrumentos para la cirugía laser, superficie negra
 Instruments pour la chirurgie laser, surface noire
 Strumenti per chirurgia laser, superficie nera



1/1

Scheidenspekula für Laserchirurgie siehe Seite 433!
 Vaginal specula for laser surgery see page 433!
 Espéculos vaginales para la cirugía laser vean pagina 433!
 Spéculum vaginaux pour la chirurgie laser voir page 433!
 Specoli vaginali per chirurgia laser vedi pagina 433!



1/1

► 95-0487
3 mm



1/1

95-0488
5 mm



1/1



1/1



1/2

95-0486
25 cm, 10"

Lateral-Spekulum
 Lateral speculum
 Espéculo lateral
 Speculum latéral
 Speculo laterale



1/2

KOGAN
 95-0487
 - 95-0488
 27 cm, 10³/₄"

Endospekula für Harnröhre und Cervix
 Endospecula for cervix and urethra
 Endoespéculos para cerviz y uretra
 Spéculum pour urètre et col utérin
 Endospeculi per cervic ed uretra



1/2

95-0740
26,5 cm, 10¹/₂"

Meßinstrument
 Measuring instrument
 Instrumento para medir
 Instrument pour mesurer
 Strumento per misure



1/2

95-0741
28,5 cm, 11¹/₄"

Meßinstrument
 Measuring instrument
 Instrumento para medir
 Instrument pour mesurer
 Strumento per misure



1/1



1/1



1/1



1/1



1/1



1/2

95-0745
 24,5 cm, 9³/₄"
 Häkchen
 Hook
 Gancho
 Crochet
 Uncino



1/2

EMMET
 95-0746
 24,5 cm, 9³/₄"
 Häkchen
 Hook
 Gancho
 Crochet
 Uncino



1/2

95-0747
 24,5 cm, 9³/₄"
 Häkchen
 Hook
 Gancho
 Crochet
 Uncino



1/2

95-0748
 23,5 cm, 9¹/₄"
 Häkchen
 Hook
 Gancho
 Crochet
 Uncino



1/2

95-0749
 26 cm, 10¹/₄"
 Häkchen
 Hook
 Gancho
 Crochet
 Uncino



Instrumente für Laserchirurgie, Oberfläche geschwärzt
Instruments for Laser Surgery, surface black-finish
Instrumentos para la cirugía laser, superficie negra
Instruments pour la chirurgie laser, surface noire
Strumenti per chirurgia laser, superficie nera



95-0750
24,5 cm, 9³/₄"

Meßsonde
Measuring probe
Sonda para medir
Sonde pour mesurer
Sonda per misura

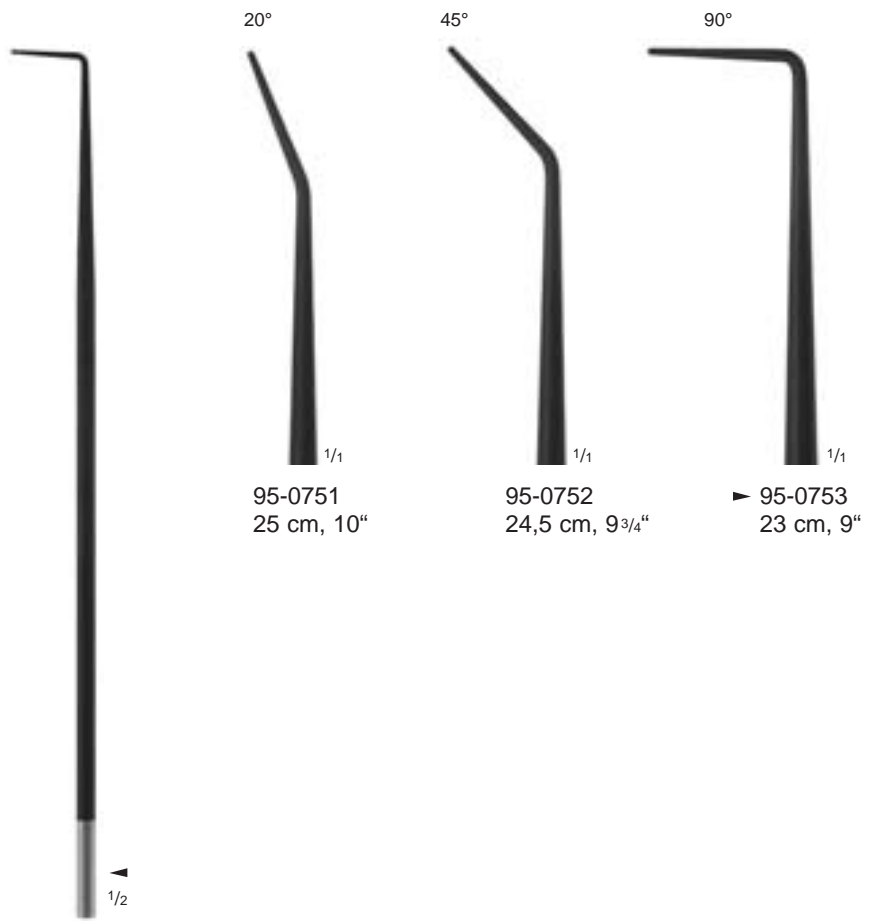

95-0751
25 cm, 10"

95-0752
24,5 cm, 9³/₄"

▶ 95-0753
23 cm, 9"

95-0751
- 95-0753

Sonden
Probes
Sondas
Sondes
Sonde



95-0755
 27 cm, 10^{3/4}"

Tiefenmesser
 Depth ruler
 Sonda para medir la profundidad
 Instrument de mesure pour la profondeur
 Sonda per misurare la profondità

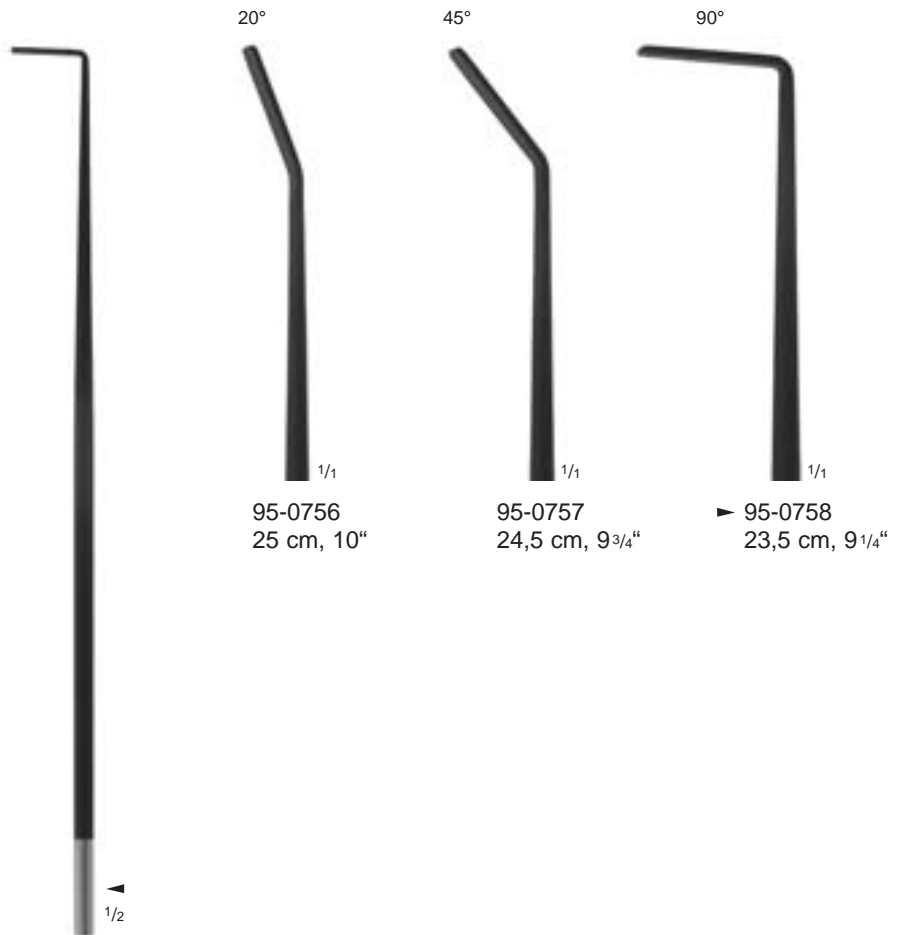

95-0756
 25 cm, 10"

95-0757
 24,5 cm, 9^{3/4}"

▶ 95-0758
 23,5 cm, 9^{1/4}"

95-0756
 - 95-0758

Sonden
 Probes
 Sondas
 Sondes
 Sonda



Hakenzangen
Uterine Tenaculum Forceps
Pinzas para coger el cuello del útero
Pinces pour abaissement du col de l'utérus
Pinze per abbassare il collo dell'utero



STAUDE-
MOORE
96-0320
17 cm, 6³/₄"

1/2



BARRETT
96-0300
18 cm, 7"

1/2



ADAIR
10-0188
18,5 cm, 7¹/₄"

1/2



SCHRÖDER
96-0313
25,5 cm, 10"

1/2



SCHRÖDER
96-0309
25 cm, 10"

1/2



BRAUN
96-0310
25 cm, 10"

1/2

Hakenzangen
Uterine Tenaculum Forceps
Pinzas para coger el cuello del útero
Pinces pour abaissement du col de l'utérus
Pinze per abbassare il collo dell'utero



1/2

POZZI
96-0303
25,5 cm, 10"

kräftiges Modell
heavy pattern
modelo fuerte
modèle fort
modello pesante



1/2

DUPLAY
96-0315
28,5 cm, 11 1/4"



1/2

HULKA
96-0305
29 cm, 11 1/2"

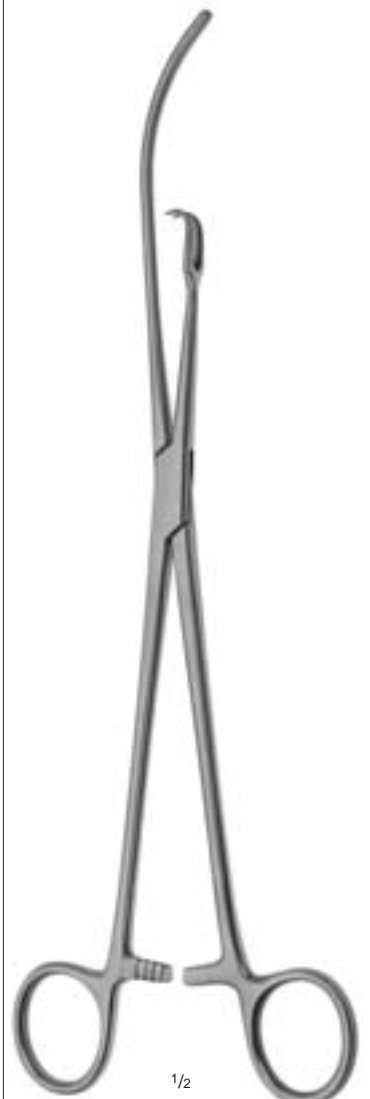

1/2

HULKA-KENWICK
96-0306
29 cm, 11 1/2"



Hakenzangen
 Uterine Tenaculum Forceps
 Pinzas para coger el cuello del útero
 Pinces pour abaissement du col de l'utérus
 Pinze per abbassare il collo dell'utero

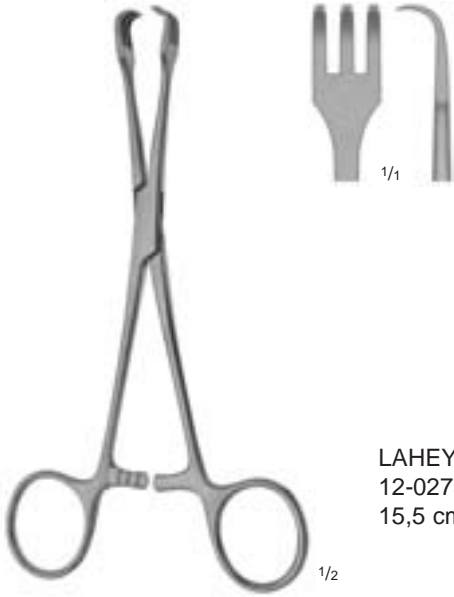

LAHEY
 12-0275
 15,5 cm, 6"

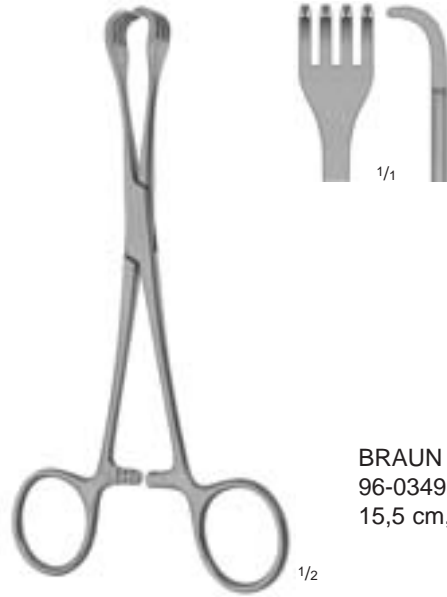

BRAUN
 96-0349
 15,5 cm, 6"



SCHRÖDER
 96-0350
 25 cm, 10"

gerade
 straight
 recta
 droits
 retta



SCHRÖDER
 96-0351
 25 cm, 10"

aufgebogen
 curved on flat
 curva sobre el plano
 courbe sur le plat
 curva su un lato



SCHRÖDER
 96-0352
 25 cm, 10"

seitwärts gebogen
 curved sideways
 curva lateral
 courbe sur le côté
 curva sul fianco

Hakenzangen

Uterine Tenaculum Forceps

Pinzas para coger el cuello del útero

Pinces pour abaissement du col de l'utérus

Pinze per abbassare il collo dell'utero



1/1



1/1



1/1



1/2

CZERNY
96-0355
21 cm, 8¹/₄"



1/2

PRATT
96-0357
26 cm, 10¹/₄"



1/2

PRATT
96-0740
27,5 cm, 10³/₄"



Hakenzangen

Uterine Tenaculum Forceps

Pinzas para coger el cuello del útero

Pinces pour abaissement du col de l'utérus

Pinze per abbassare il collo dell'utero



JACOBS
96-0380
21 cm, 8 1/4"

gerade
straight
recta
droit
retta

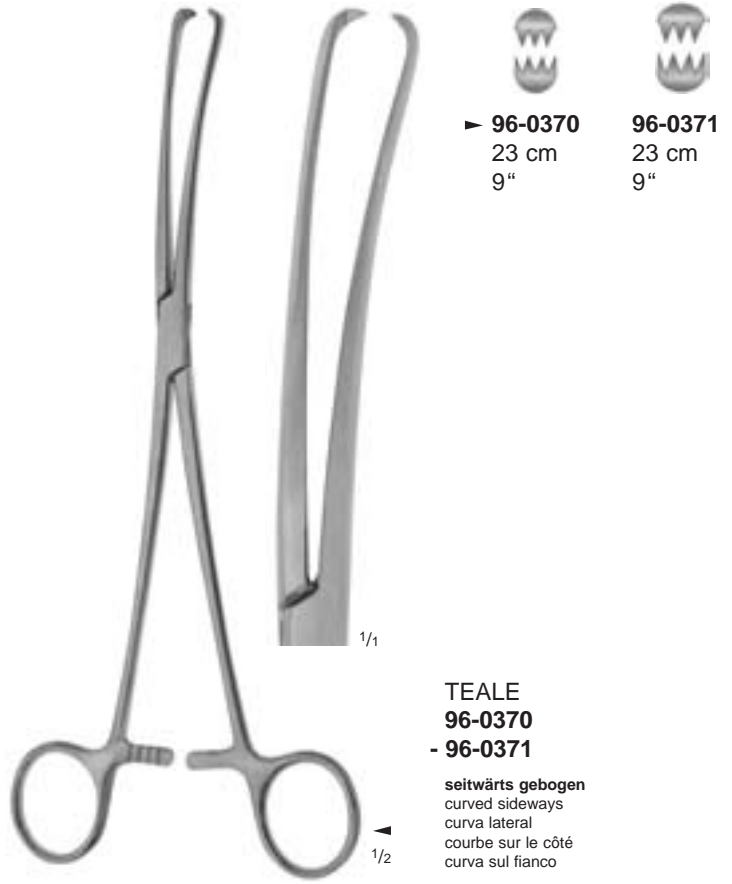

► **96-0370**
23 cm
9"

96-0371
23 cm
9"

TEALE
96-0370
- **96-0371**

seitwärts gebogen
curved sideways
curva lateral
courbe sur le côté
curva sul fianco

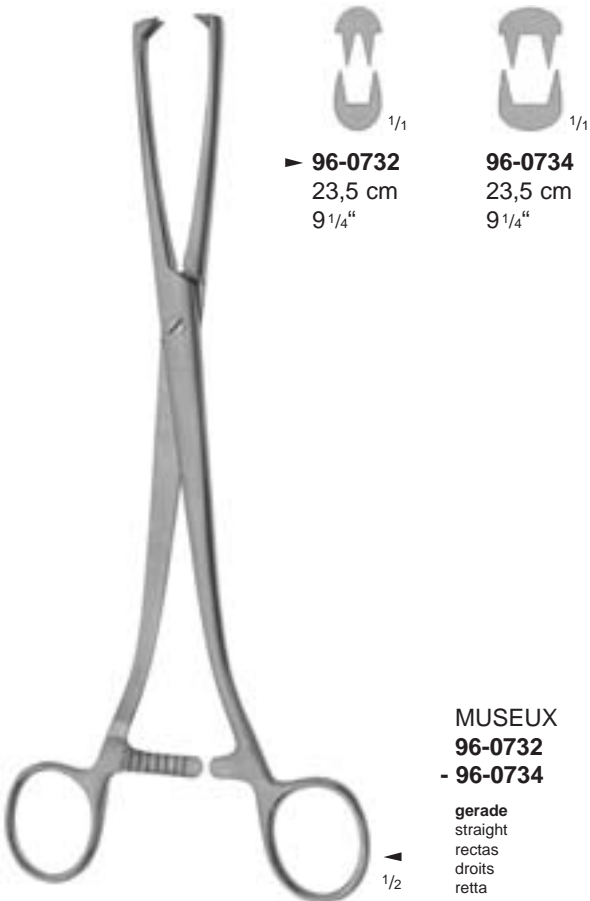

► **96-0732**
23,5 cm
9 1/4"

96-0734
23,5 cm
9 1/4"

MUSEUX
96-0732
- **96-0734**

gerade
straight
rectas
droits
retta



► **96-0733**
23,5 cm
9 1/4"

96-0735
23,5 cm
9 1/4"

MUSEUX
96-0733
- **96-0735**

seitwärts gebogen
curved sideways
curva lateral
courbe sur le côté
curva sul fianco

Polypen- und Ovarienzangen

Polypus and Ovum Forceps

Pinzas para pólipos uterinos y ovarios

Pinces à polypes et ovaires

Pinze per polipi e ovaie



1/2

DOYEN
16-0306
18,5 cm, 7 1/4"



1/2

HEYWOOD-SMITH
97-0452
25 cm, 10"



1/2

NOTO
97-0456
27 cm, 10 3/4"



1/2

KELLY
97-0450
31 cm, 12 1/4"



Uterusfaßzangen

Uterine Elevating Forceps
Pinzas para el útero
Pincas hystérolabes
Pinze per afferrare l'utero

Myomheber

Myoma Screws
Tirabuzóns para mioma
Tracteurs pour fibrome
Succhielli per fibroma



mit beweglichen Mauftteilen
with movable jaws
con mandibula movable
avec mors mobiles
con mandibole mobili



DOYEN
96-0749
17 cm, 6^{3/4}"

Myomheber ø 20 mm
Myoma screw ø 20 mm
Tirabuzón para mioma ø 20 mm
Tracteur pour fibrome ø 20 mm
Succhiello per fibroma ø 20 mm



SOMER
96-0800
23 cm, 9"

Uterusfaßzange
Uterine elevating forceps
Pinza para el útero
Pince hystérolabe
Pinza per afferrare l'utero



COLLIN
96-0817
26,5 cm, 10^{1/2}"

Uterusfaßzange
Uterine elevating forceps
Pinza para el útero
Pince hystérolabe
Pinza per afferrare l'utero



DOYEN
96-0750
17 cm, 6^{3/4}"

Myomheber ø 29 mm
Myoma screw ø 29 mm
Tirabuzón para mioma ø 29 mm
Tracteur pour fibrome ø 29 mm
Succhiello per fibroma ø 29 mm

Biopsieküretten

Biopsy Curettes

Curetas para biopsia

Curettes pour biopsie

Curette per biopsia



RANDALL
95-0809
25 cm, 10"

Endometrium-Saug-Biopsiekürette

Endometrial suction biopsy curette

Cureta aspiradora para biopsia endo-uterina

Curette aspiratrice pour biopsie de l'endomètre

Curetta aspirante per la biopsia dell'endometrio



NOVAK
95-0810
25 cm, 10"

Endometrium-Saug-Biopsiekürette

Endometrial suction biopsy curette

Cureta aspiradora para biopsia endo-uterina

Curette aspiratrice pour biopsie de l'endomètre

Curetta aspirante per la biopsia dell'endometrio



MOD. MÜNCHEN
95-0812
27 cm, 10^{3/4}"

Endometrium-Strichkürette

Endometrial biopsy curette

Cureta para biopsia endo-uterina

Curette à biopsie de l'endomètre

Curetta per la biopsia dell'endometrio



KEVOURKIAN-YOUNGE
95-0764
28 cm, 11"

Endocervix-Biopsiekürette

Endocervical biopsy curette

Cureta para biopsia endo-cerviz

Curette à biopsie endo-cervicale

Curetta per la biopsia endo-cervicale



KEVOURKIAN-YOUNGE
95-0765
28 cm, 11"

Endocervix-Biopsiekürette

Endocervical biopsy curette

Cureta para biopsia endo-cerviz

Curette à biopsie endo-cervicale

Curetta per la biopsia endo-cervicale



Biopsieküretten

Biopsy Curettes
Curettes para biopsia
Curettes pour biopsie
Curette per biopsia

Uterus-Biopsiezange

Cervical Biopsy and Specimen Forceps
Pinza saca-bocados para biopsia
Pince emporte-pièces à biopsie
Pinza per la biopsia cervicale e da prelievo

ø 5 mm



95-1101
28,5 cm, 11 1/4"

ø 7 mm



95-1102
28,5 cm, 11 1/4"

ø 9 mm



95-1103
28,5 cm, 11 1/4"

biegsam • malleable • maleables • malléables • malleabili

ø 5 mm



95-1105
28,5 cm, 11 1/4"

ø 7 mm



95-1106
28,5 cm, 11 1/4"

ø 9 mm



95-1107
28,5 cm, 11 1/4"

starr • rigid • rígidas • rigides • rigidi

MILAN
95-1101
- 95-1107

Endocervix-Biopsieküretten, Arbeitsteil bestehend aus mehreren, untereinander angeordneten konkaven Rundmessern

Endocervical biopsy curettes, working portion consisting of several concave-shaped circular knives, arranged one beneath the other

Cureta para biopsia endo-cervix, con cuchillitos redondos colocados uno sobre otro, concavos

Curettes pour biopsie endo-cervicale constituées de plusieurs parties tranchantes circulaires concaves

Curette per la biopsia endo-cervicale, con parte attiva formata da dischi, taglienti concavi sistemati l'uno sull'altro



THOMS-GAYLOR
95-0550
24 cm, 9 1/2"

Uterus-Biopsiezange

Cervical biopsy and specimen forceps

Pinza saca-bocados para biopsia

Pince emporte-pièces à biopsie

Pinza per la biopsia cervicale e da prelievo

Uterus-Biopsiezangen

Cervical Biopsy and Specimen Forceps

Pinzas saca-bocados para biopsia

Pinces emporte-pièces à biopsie

Pinze per la biopsia cervicale e da prelievo



SCHUBERT
95-0670
28,5 cm, 11 1/4"



SCHUBERT
95-0650
26 cm, 10 1/4"



VAN DOREN
95-0652
25 cm, 10"



Uterus-Biopsiezangen

Cervical Biopsy and Specimen Forceps

Pinzas saca-bocados para biopsía

Pinces emporte-pièces à biopsie

Pinze per la biopsia cervicale e da prelievo

← 185 mm →

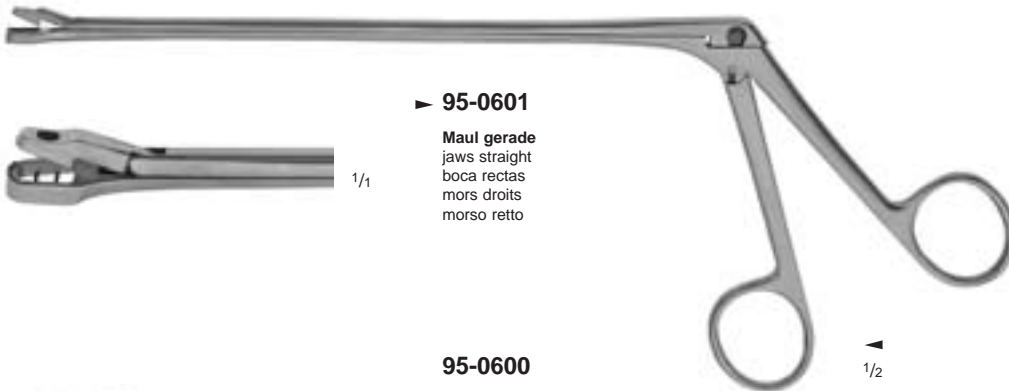

► 95-0601

Maul gerade
jaws straight
boca rectas
mors droits
morso retto



WITTNER
95-0600
- **95-0601**

95-0600

Maul nach links gebogen
jaws curved to left
boca curva hacia la izquierda
mors courbes à gauche
morso curve a sinistra



◄ 1/2

← A →



HARTMANN

- **95-0660** 175 mm (A)
- 95-0661** 210 mm (A)
- 95-0662** 250 mm (A)



◄ 1/2

← 200 mm →



BERGER
95-0659



1/2

Uterus-Biopsiezangen

Cervical Biopsy and Specimen Forceps

Pinzas saca-bocados para biopsia

Pinces emporte-pièces à biopsie

Pinze per la biopsia cervicale e da prelievo

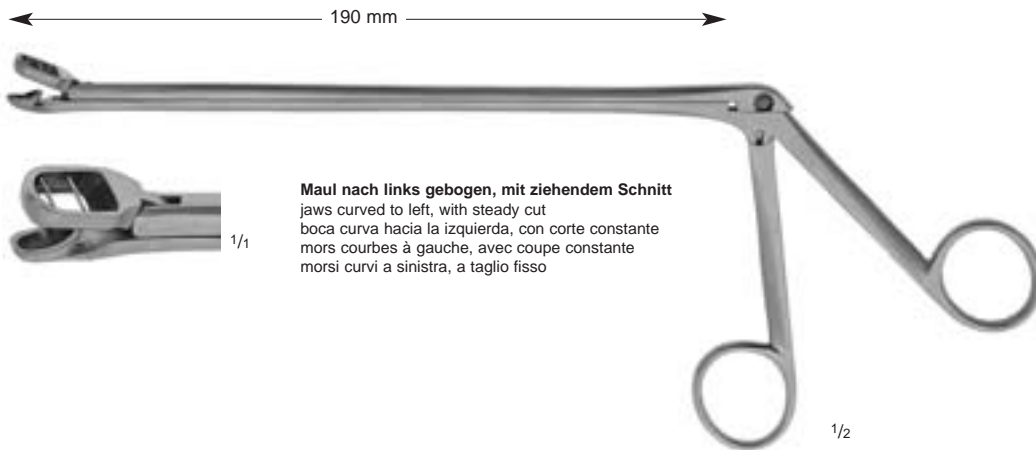

Maul nach links gebogen, mit ziehendem Schnitt
jaws curved to left, with steady cut
boca curva hacia la izquierda, con corte constante
mors courbes à gauche, avec coupe constante
morsi curvi a sinistra, a taglio fisso

ALEXANDER
95-0604

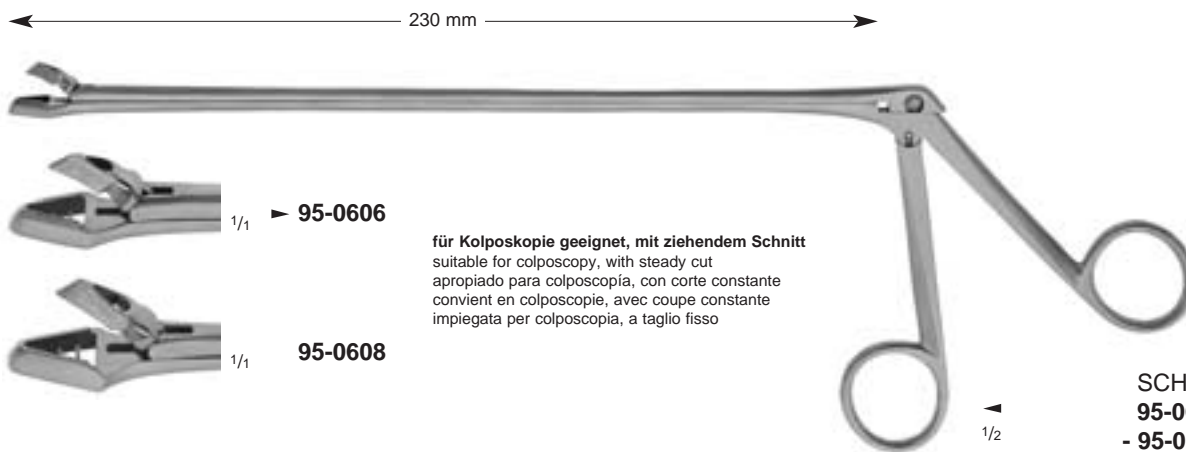

für Kolposkopie geeignet, mit ziehendem Schnitt
suitable for colposcopy, with steady cut
apropiado para colposcopia, con corte constante
convient en colposcopie, avec coupe constante
impiegata per colposcopia, a taglio fisso

SCHUMACHER
95-0606
- 95-0608

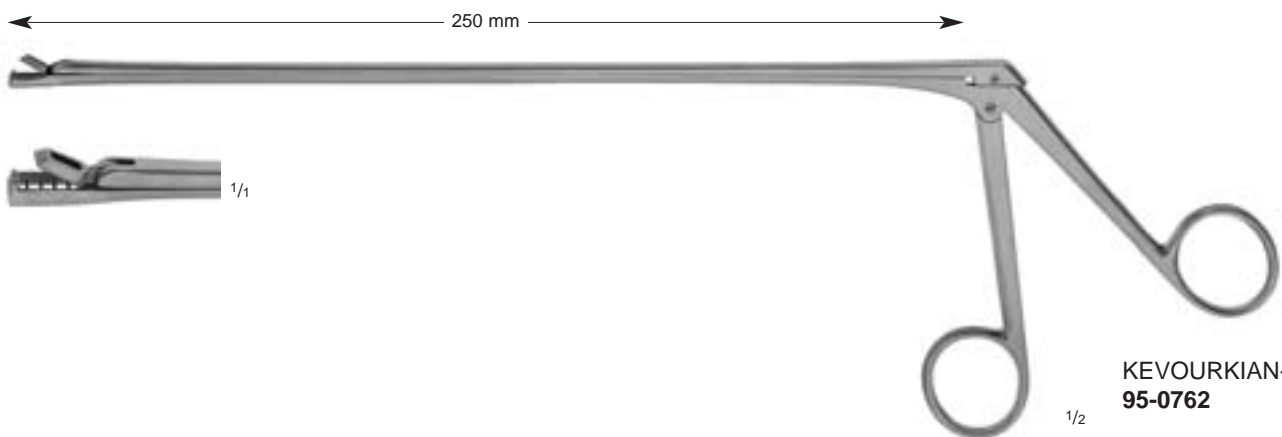

KEVOURKIAN-YOUNGE
95-0762



Uterus-Biopsiezangen

Cervical Biopsy and Specimen Forceps

Pinzas saca-bocados para biopsia

Pinces emporte-pièces à biopsie

Pinze per la biopsia cervicale e da prelievo

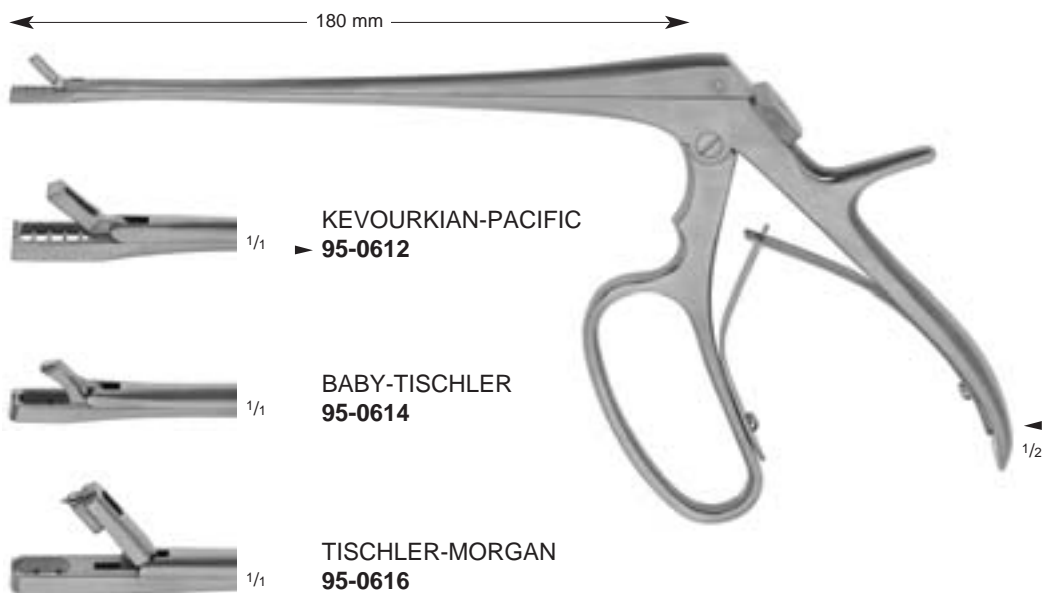
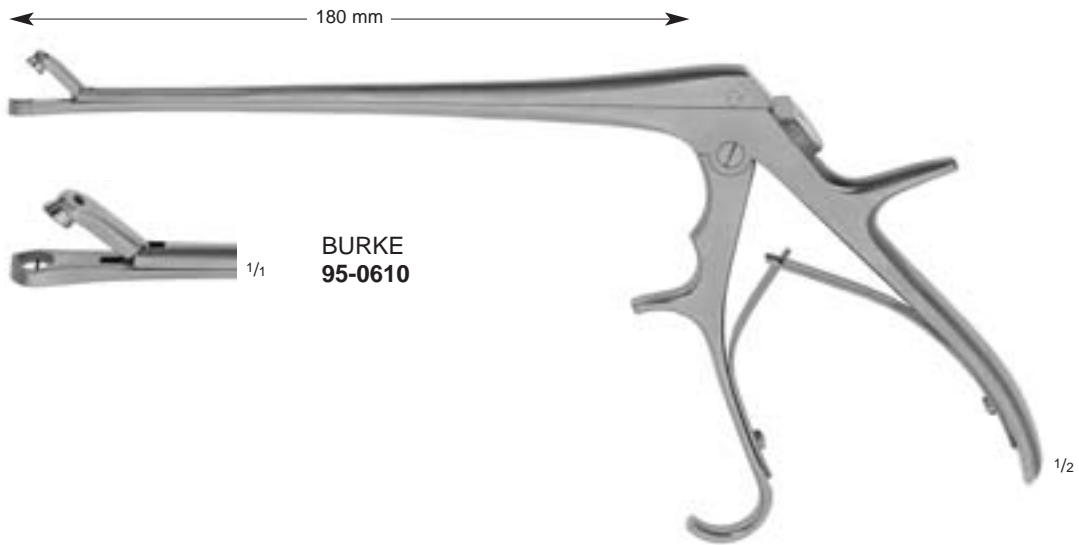

Uterus-Biopsiezangen

Cervical Biopsy and Specimen Forceps

Pinzas saca-bocados para biopsia

Pinces emporte-pièces à biopsie

Pinze per la biopsia cervicale e da prelievo



Instrument komplett
Complete instrument
Instrumento completo
Instrument complet
Strumento completo

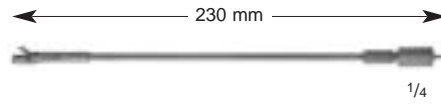

Aufsatz mit Rohr
Tip with tube
Punta con tubo
Tige avec embout
Punta con asta



Griff
Handle
Mango
Manche
Manico

 1/1	TOWNSEND 95-0680 gerade straight recta droit retta	95-0681	95-0699
 1/1	TOWNSEND 95-0682 aufwärts gewinkelt angled upward angulada hacia arriba angulé au dessus angolata superiormente	95-0683	95-0699
 1/1	TOWNSEND 95-0684 abwärts gewinkelt angled downward angulada hacia abajo angulé en dessous angolata inferiormente	95-0685	95-0699
 1/1	TISCHLER 95-0686 gerade straight recta droit retta	95-0687	95-0699
 1/1	TISCHLER 95-0688 aufwärts gewinkelt angled upward angulada hacia arriba angulé au dessus angolata superiormente	95-0689	95-0699
 1/1	TISCHLER 95-0690 abwärts gewinkelt angled downward angulada hacia abajo angulé en dessous angolata inferiormente	95-0691	95-0699
 1/1	KEVOURKIAN- YOUNGE 95-0692 gerade straight recta droit retta	95-0693	95-0699



Uteruslöffel

Uterine Scoops
Cucharillas uterinas
Curettes utérines
Curette uterine

Uteruskürette

Uterine Curette
Cureta uterina
Curette utérine
Curette uterine

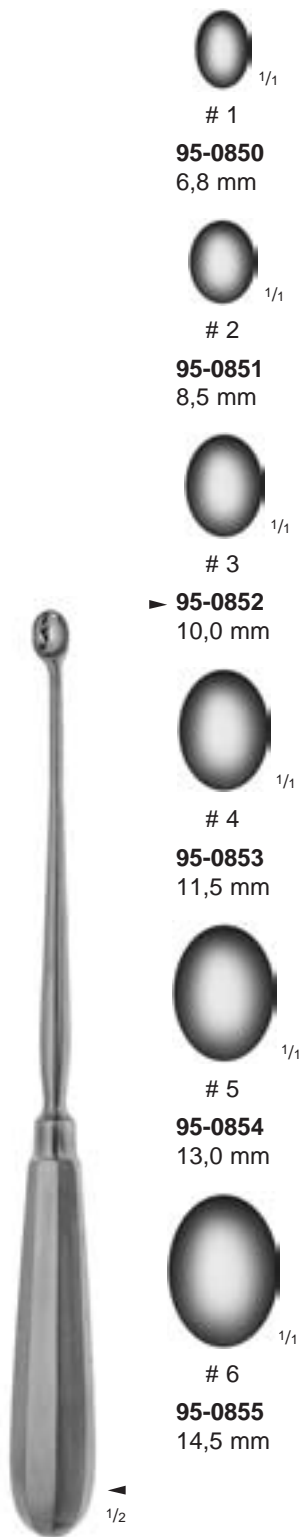

1
95-0850
6,8 mm

2
95-0851
8,5 mm

3
▶ **95-0852**
10,0 mm

4
95-0853
11,5 mm

5
95-0854
13,0 mm

6
95-0855
14,5 mm

SIMON
95-0850
- **95-0855**
25 cm, 10"

Uteruslöffel, scharf / fest
Uterine scoops, sharp / rigid
Cucharillas uterinas, cortante / rígidas
Curettes utérines, tranchantes / rigides
Curette uterine, acute / rigide

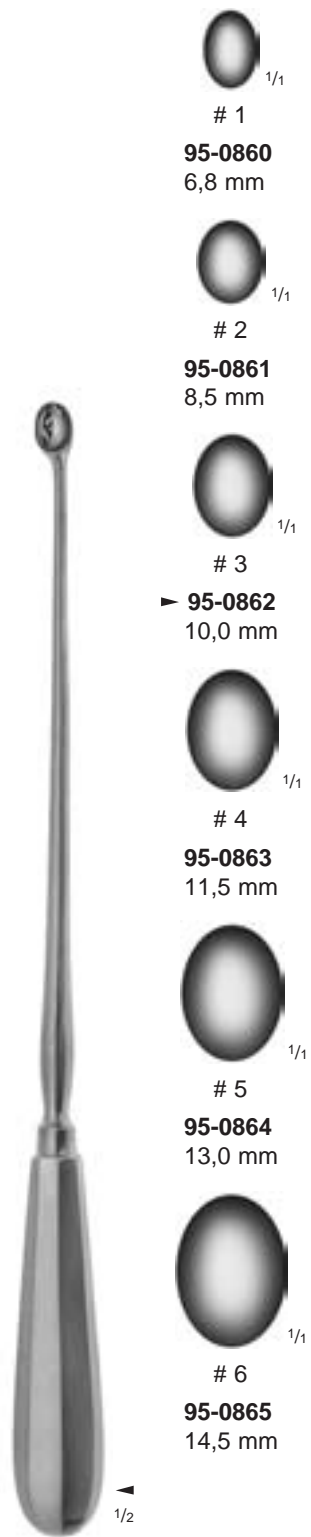

1
95-0860
6,8 mm

2
95-0861
8,5 mm

3
▶ **95-0862**
10,0 mm

4
95-0863
11,5 mm

5
95-0864
13,0 mm

6
95-0865
14,5 mm

SCHRÖDER
95-0860
- **95-0865**
30 cm, 12"

Uteruslöffel, scharf / fest
Uterine scoops, sharp / rigid
Cucharillas uterinas, cortante / rígidas
Curettes utérines, tranchantes / rigides
Curette uterine, acute / rigide

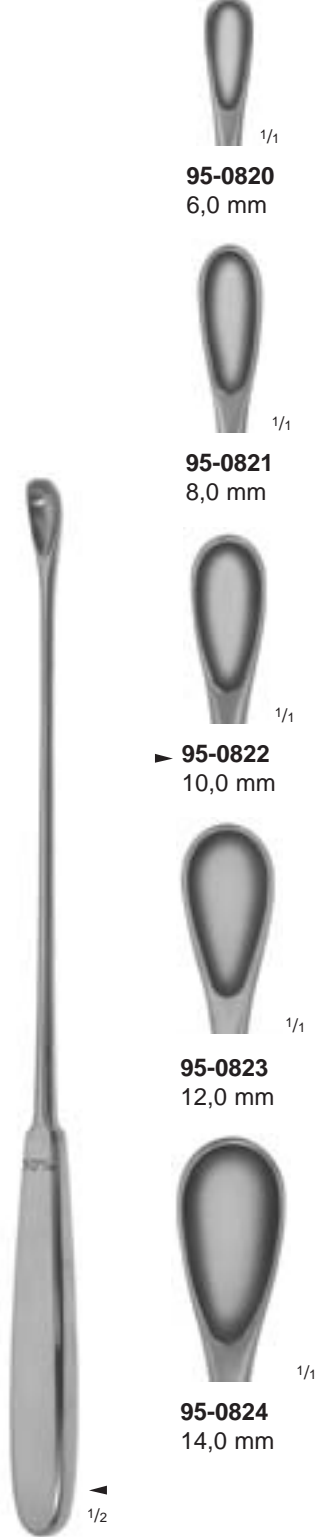

1
95-0820
6,0 mm

2
95-0821
8,0 mm

3
▶ **95-0822**
10,0 mm

4
95-0823
12,0 mm

5
95-0824
14,0 mm

GOURDET
95-0820
- **95-0824**
28 cm, 11"

Uteruslöffel, stumpf / fest
Uterine scoops, blunt / rigid
Cucharillas uterinas, romas / rígidas
Curettes utérines, mousues / rigides
Curette uterine, smusse / rigide

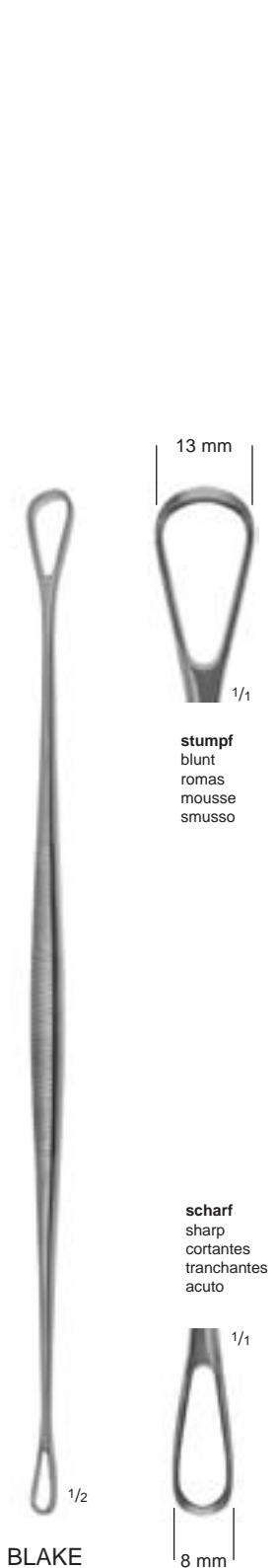

1
95-0927
27,5 cm, 10³/₄"

13 mm

stumpf
blunt
romas
mousse
smusso

8 mm

scharf
sharp
cortantes
tranchantes
acuto

BLAKE
95-0927
27,5 cm, 10³/₄"

Uteruskürette
Uterine curette
Cureta uterina
Curette utérine
Curette uterine

Uterusküretten
 Uterine Curettes
 Curetas uterinas
 Curettes utérines
 Curette uterine

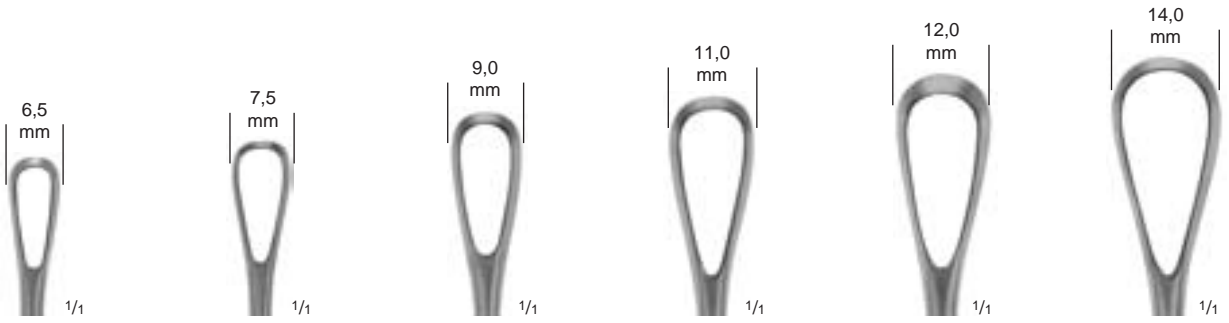

# 1	# 2	# 3	# 4	# 5	# 6
95-1061	95-1062	95-1063	95-1064	95-1065	95-1066
95-1071	95-1072	95-1073	95-1074	95-1075	95-1076
95-1081	95-1082	95-1083	95-1084	95-1085	95-1086
95-1091	95-1092	95-1093	95-1094	95-1095	95-1096

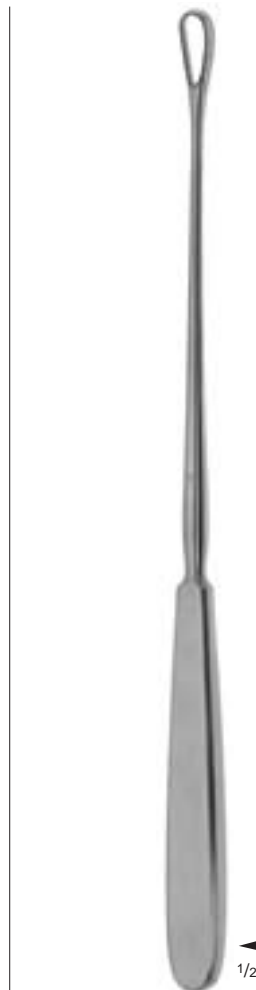

SIMS
95-1061 Fig. 1 6,5 mm
95-1062 Fig. 2 7,5 mm
95-1063 Fig. 3 9,0 mm
95-1064 Fig. 4 11,0 mm
95-1065 Fig. 5 12,0 mm
95-1066 Fig. 6 14,0 mm
 24,5 - 26,0 cm, 9^{3/4}" - 10^{1/4}"

scharf, fest
 sharp, rigid
 cortantes, rígidas
 tranchantes, rigides
 acute, rigide

SIMS
95-1071 Fig. 1 6,5 mm
95-1072 Fig. 2 7,5 mm
95-1073 Fig. 3 9,0 mm
95-1074 Fig. 4 11,0 mm
95-1075 Fig. 5 12,0 mm
95-1076 Fig. 6 14,0 mm
 24,5 - 26,0 cm, 9^{3/4}" - 10^{1/4}"

scharf, biegsam
 sharp, malleable
 cortantes, maleables
 tranchantes, malléables
 acute, malleabile

SIMS
95-1081 Fig. 1 6,5 mm
95-1082 Fig. 2 7,5 mm
95-1083 Fig. 3 9,0 mm
95-1084 Fig. 4 11,0 mm
95-1085 Fig. 5 12,0 mm
95-1086 Fig. 6 14,0 mm
 24,5 - 26,0 cm, 9^{3/4}" - 10^{1/4}"

stumpf, fest
 blunt, rigid
 romas, rígidas
 mousses, rigides
 smusse, rigide

SIMS
95-1091 Fig. 1 6,5 mm
95-1092 Fig. 2 7,5 mm
95-1093 Fig. 3 9,0 mm
95-1094 Fig. 4 11,0 mm
95-1095 Fig. 5 12,0 mm
95-1096 Fig. 6 14,0 mm
 24,5 - 26,0 cm, 9^{3/4}" - 10^{1/4}"

stumpf, biegsam
 blunt, malleable
 romas, maleables
 mousses, malléables
 smusse, malleabile



Uterusküretten
 Uterine Curettes
 Curetas uterinas
 Curettes utérines
 Curette uterine



1/2

RECAMIER

- 95-0988** Fig. 00 6,0 mm
 - 95-0989** Fig. 0 7,5 mm
 - 95-0990** Fig. 1 8,5 mm
 - 95-0991** Fig. 2 9,5 mm
 - ▶ **95-0992** Fig. 3 10,5 mm
 - 95-0993** Fig. 4 11,5 mm
 - 95-0994** Fig. 5 12,5 mm
 - 95-0995** Fig. 6 14,0 mm
 - 95-0996** Fig. 7 15,0 mm
 - 95-0997** Fig. 8 16,0 mm
 - 95-0998** Fig. 9 19,0 mm
 - 95-0999** Fig. 10 20,0 mm
- 29,5 - 32,5 cm, 11 3/4" - 12 3/4"

scharf, fest
 sharp, rigid
 cortantes, rígidas
 tranchantes, rigides
 acute, rigide



1/2

RECAMIER

- 95-0928** Fig. 00 6,0 mm
 - 95-0929** Fig. 0 7,5 mm
 - 95-0930** Fig. 1 8,5 mm
 - 95-0931** Fig. 2 9,5 mm
 - ▶ **95-0932** Fig. 3 10,5 mm
 - 95-0933** Fig. 4 11,5 mm
 - 95-0934** Fig. 5 12,5 mm
 - 95-0935** Fig. 6 14,0 mm
 - 95-0936** Fig. 7 15,0 mm
 - 95-0937** Fig. 8 16,0 mm
 - 95-0938** Fig. 9 19,0 mm
 - 95-0939** Fig. 10 20,0 mm
- 29,5 - 32,5 cm, 11 3/4" - 12 3/4"

scharf, biegsam
 sharp, malleable
 cortantes, maleables
 tranchantes, malléables
 acute, malleable



1/2

RECAMIER

- 95-0978** Fig. 00 6,0 mm
 - 95-1000** Fig. 0 7,5 mm
 - 95-1001** Fig. 1 8,5 mm
 - 95-1002** Fig. 2 9,5 mm
 - ▶ **95-1003** Fig. 3 10,5 mm
 - 95-1004** Fig. 4 11,5 mm
 - 95-1005** Fig. 5 12,5 mm
 - 95-1006** Fig. 6 14,0 mm
 - 95-1007** Fig. 7 15,0 mm
 - 95-1008** Fig. 8 16,0 mm
 - 95-1009** Fig. 9 19,0 mm
 - 95-1010** Fig. 10 20,0 mm
- 29,5 - 32,5 cm, 11 3/4" - 12 3/4"

stumpf, fest
 blunt, rigid
 romas, rígidas
 mousses, rigides
 smusse, rigide



1/2

RECAMIER

- 95-1018** Fig. 00 6,0 mm
 - 95-1020** Fig. 0 7,5 mm
 - 95-1021** Fig. 1 8,5 mm
 - 95-1022** Fig. 2 9,5 mm
 - ▶ **95-1023** Fig. 3 10,5 mm
 - 95-1024** Fig. 4 11,5 mm
 - 95-1025** Fig. 5 12,5 mm
 - 95-1026** Fig. 6 14,0 mm
 - 95-1027** Fig. 7 15,0 mm
 - 95-1028** Fig. 8 16,0 mm
 - 95-1029** Fig. 9 19,0 mm
 - 95-1030** Fig. 10 20,0 mm
- 29,5 - 32,5 cm, 11 3/4" - 12 3/4"

stumpf, biegsam
 blunt, malleable
 romas, maleables
 mousses, malléables
 smusse, malleable

Uterusküretten
 Uterine Curettes
 Curetas uterinas
 Curettes utérines
 Curette uterine



00

95-0988
 95-0928
 95-0978
 95-1018



0

95-0989
 95-0929
 95-1000
 95-1020



1

95-0990
 95-0930
 95-1001
 95-1021



2

95-0991
 95-0931
 95-1002
 95-1022



3

95-0992
 95-0932
 95-1003
 95-1023



4

95-0993
 95-0933
 95-1004
 95-1024



5

95-0994
 95-0934
 95-1005
 95-1025



6

95-0995
 95-0935
 95-1006
 95-1026



7

95-0996
 95-0936
 95-1007
 95-1027



8

95-0997
 95-0937
 95-1008
 95-1028



9

95-0998
 95-0938
 95-1009
 95-1029



10

95-0999
 95-0939
 95-1010
 95-1030



Uterusküretten
 Uterine Curettes
 Curetas uterinas
 Curettes utérines
 Curette uterine

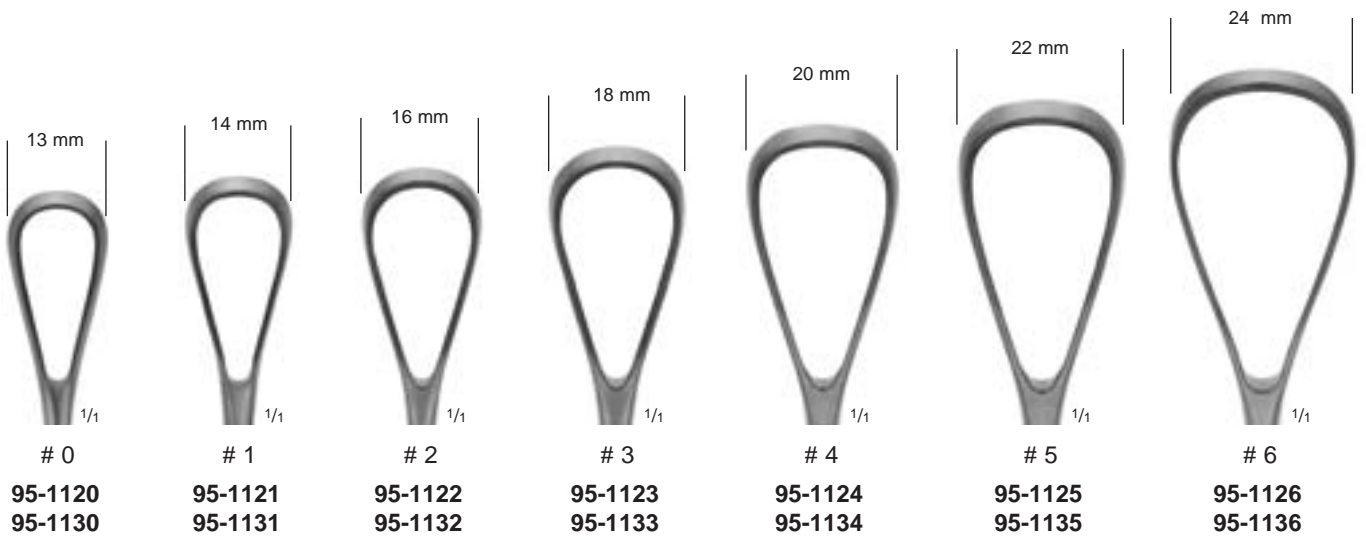

BUMM
95-1120 Fig. 0 13 mm
95-1121 Fig. 1 14 mm
95-1122 Fig. 2 16 mm
 ▶ **95-1123** Fig. 3 18 mm
95-1124 Fig. 4 20 mm
95-1125 Fig. 5 22 mm
95-1126 Fig. 6 24 mm
 28 - 29 cm, 11" - 11 1/2"
scharf, biegsam
 sharp, malleable
 cortantes, maleables
 tranchantes, malléables
 acute malleable



BUMM
95-1130 Fig. 0 13 mm
95-1131 Fig. 1 14 mm
95-1132 Fig. 2 16 mm
 ▶ **95-1133** Fig. 3 18 mm
95-1134 Fig. 4 20 mm
95-1135 Fig. 5 22 mm
95-1136 Fig. 6 24 mm
 28 - 29 cm, 11" - 11 1/2"
stumpf, biegsam
 blunt, malleable
 romas, maleables
 mousses, malléables
 smusse, malleable

Absaugküretten

Aspirating Curettes
Curettes de aspiración
Curettes d'aspiration
Curette per aspirazione

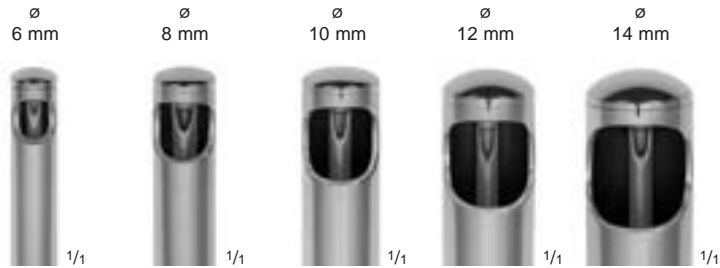
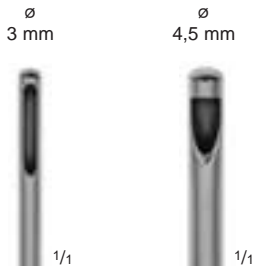

95-1150
28,5 cm
11 1/4"

95-1151
28,5 cm
11 1/4"

Probe- und Absaugküretten
Specimen and aspirating curettes
Curettes de biopsia y de aspiración
Curettes à biopsie et d'aspiration
Curette per prelievo ed aspirazione



95-1152
28,5 cm
11 1/4"

95-1153
28,5 cm
11 1/4"

95-1154
28,5 cm
11 1/4"

95-1155
28,5 cm
11 1/4"

95-1156
28,5 cm
11 1/4"

Absaugküretten
Aspirating curettes
Curettes de aspiración
Curettes d'aspiration
Curette per aspirazione

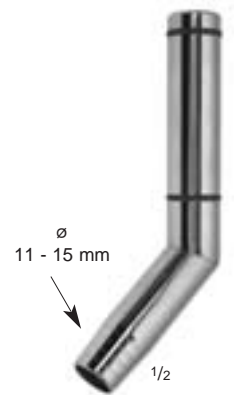

95-1159

Schlauchverbindungsstück für Absaugküretten 95-1152 bis 95-1156, für Saugschlauch von 11 mm Innen-ø

Coupling piece for the connection of aspirating curettes 95-1152 - 95-1156 to flexible tube having an interior diameter of 11 mm

Adaptador de tubo para curetas de aspiración 95-1152 - 95-1156, para tubos de aspiración, ø interior de 11 mm

Embout adaptable aux curettes 95-1152 - 95-1156 pour tube d'aspiration, ø inférieur à 11 mm

Adattatore per la connessione delle curette per aspirazione 95-1152 - 95-1156 ad un tubo flessibile avente un ø int. di 11 mm



Instrumentarium zur Amnioskopie und Mikro-Blutentnahme

Instruments for Amnioscopy and Mikro-Bloodletting

Instrumental para la amnioskopía y la micro-extracción de sangre

Instrumentation pour amnioscopie

Strumentario per l'amnioskopia e il salasso



SALING

- ▶ **97-0600** ø 12-24 mm x 200 mm
- 97-0601** ø 16-24 mm x 200 mm
- 97-0602** ø 20-24 mm x 200 mm

Amnioskop-Tuben, konisch, mit Obturator

Amniotic tubes, cone shaped, with obturator

Amnioscopio, cónico, con obturador

Amnioscope conique, avec obturateur

Amnioscopio conico con otturatore



SALING

- ▶ **97-0620** ø 16-42 mm x 200 mm
- 97-0621** ø 20-44 mm x 200 mm
- 97-0622** ø 33-44 mm x 140 mm

Amnioskop-Tuben für die Mikro-Blutentnahme, konisch, mit Obturator

Amniotic tubes for micro-bloodletting, cone shaped, with obturator

Amnioscopio para la micro-extracción de sangre, cónico, con obturador

Amnioscope pour micro extraction conique, avec obturateur

Amnioscopio per salasso, conico, con otturatore



97-0641

Kaltlicht-Proximalbeleuchtung für Amnioskop-Tuben, mit Anschluß für ACM-, BRITISH STANDARD-, LAWTON-, WOLF-, HSW-, STORZ-, WINTER-, OLYMPUS-Lichtkabel

Cold-light proximal illumination for amniotic tubes, with connection for ACM-, BRITISH STANDARD-, LAWTON-, WOLF-, HSW-, STORZ-, WINTER-, OLYMPUS-light cable

Illuminación-proximal con luz fría para amnioscopios, con conexiones para cables conductores de luz fría ACM, BRITISH-STANDARD, LAWTON, WOLF, HSW, STORZ, WINTER y OLYMPUS

Eclairage à lumière froide pour amnioscopes, avec embouts adaptateurs pour conducteur de lumière froide ACM, BRITISH-STANDARD, LAWTON, WOLF, HSW, STORZ, WINTER et OLYMPUS

Illuminatore prossimale per amnioscopio a luce fredda con connettore per ACM, BRITISH-STANDARD, LAWTON, WOLF, HSW, STORZ, WINTER e OLYMPUS



97-0645

Warmlicht-Proximalbeleuchtung mit Lampe, 4 Volt, für Amnioskop-Tuben

Warm-light proximal illumination with lamp 4 volt for amniotic tubes

Illuminación-proximal con luz caliente para amnioscopios con bombilla, 4 voltios

Eclairage traditionnel avec lampes 4 volts pour tube amnioscope

Illuminatore prossimale a luce calda per amnioscopio con lampada da 4 v.



97-0646

Ersatzlampe, 4 Volt, für 95-0645

Spare lamp, 4 volt, for 95-0645

Bombilla de repuesto, 4 voltios, para 95-0645

Lampe de rechange, 4 volts, pour 95-0645

Lampada di ricambio, 4 v., per 95-0645



97-0648

Transformator, 0-5 Volt regelbar, 220 Volt (andere Spannungen auf Anfrage)

Transformer, 0-5 volt adjustable, 220 volt, (other voltage on request)

Transformador, regulable de 0-5 voltios, 220 voltios (posible en otros voltios - según demanda)

Transformateur, réglable de 0 à 5 volts, 220 volts (possibilité d'autres voltages sur demande)

Trasformatore, regolabile da 0-5 v., 220 v. (altri voltaggi a richiesta)



97-0670

Mikro-Klingen zur Blutentnahme, Packung zu 20 Stück

Micro-blades for bloodletting, package of 20 pieces

Hoja de micro-bisturí para la extracción de sangre, paquete de 20 piezas

Micro lames, paquet de 20 pièces

Micro lame per salasso, conf. da 20 pz.



1/1

97-0672

Halter für Mikro-Klingen 95-0670, Arbeitslänge 28 cm

Carrier for micro blades, working length 28 cm

Porta-hoja de micro-bisturí 95-0670, longitud de trabajo 28 cm

Porte lames 95-0670, longueur utile 28 cm

Porta micro lame, lunghezza di lavoro 28 cm



1/3

97-0674

Glaspipette zur Mikro-Blutentnahme, heparinisiert, 37 cm lang, Packung zu 5 Stück

Glass pipette for micro-bloodletting heparinized, 37 cm long, package of 5 pieces

Pipeta de vidrio para la extracción de sangre, 37 cm, paquete de 5 piezas

Pipette en verre, 37 cm, paquet de 5 pièces

Pipetta di vetro eparinizzata per micro salasso, lungh. 37 cm conf. da 5 pz.

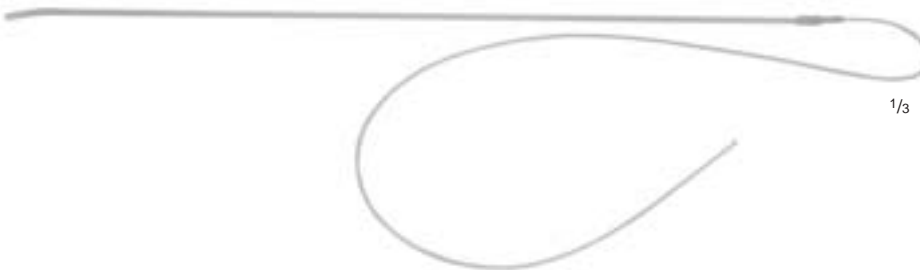

1/3

97-0676

PVC-Schlauch zum Anschluß an Glaspipette bei Mikro-Blutentnahme, 10 m lang

PVC-tubing for connection to the glass pipette during micro-bloodletting, 10 m long

Tubo de plástico con conexión para adaptar la pipeta de vidrio durante la micro-extracción de sangre, longitud 10 m

Tube plastique avec embout adaptable aux pipettes de verre pendant la micro extraction

Tubo in PVC per il collegamento alla pipetta di vetro durante il micro salasso, lungh. 10 m



1/3

97-0678

Katheter- und Schlauch-Führungszange, mit Federgriff, Arbeitslänge 28 cm

Guide forceps for catheters and tubing, with spring handle, working length 28 cm

Pinza conductora para catéteres y tubos, con mango de resorte, longitud de trabajo 28 cm

Pince conductrice pour cathéters et tubes, avec manche à ressort longueur utile 28 cm

Pinza guida per cateteri e tubi, con manico a molla, lunghezza di lavoro 28 cm



1/3

97-0680

Watte- und Tupferträger, dreiteiliges Maul, Arbeitslänge 30 cm

Cotton and sponge holder, three-jawed grip, working length 30 cm

Porta-algodón y -tapones, mandibula tripartita, longitud de trabajo 30 cm

Porte coton, à trois griffes, longueur utile 30 cm

Porta spugne/cotone, presa a 3 morsi, lunghezza di lavoro 30 cm



1/3



Instrumentarium zur Hysterosalpingographie

Instrumentation for Hystero-Salpingography

Instrumental para histero-salpingografía

Instrumentation pour hystéro-salpingographie

Strumentario per isterosalpingografia



97-0666



97-0667



97-0668



97-0669



97-0664



97-0665



97-0663

SCHULTZE

97-0660

Salpingograph zur Sterilitätsdiagnose und -behandlung, zur Röntgendarstellung und Durchblasung von Cervix, Uterus und Tuben, komplett, bestehend aus:

- 97-0664 1 Druckmanometer, mit Leuchtskala
- 97-0663 1 Verbindungsstück mit Hahn
- 97-0665 1 Tubenkatheter mit Hahn
- 97-0666 1 auswechselbarer Uterusverschlußkegel, klein
- 97-0667 1 auswechselbarer Uterusverschlußkegel, mittel
- 97-0668 1 auswechselbarer Uterusverschlußkegel, groß
- 97-0669 1 Recordspritze 10 ml, mit LUER-LOCK-Ansatz
- 97-0661 1 Holzetui

Salpingograph for diagnosis and treatment of sterility, for injections of Lipiodol into the uterus and the Fallopian tubes, for intra-uterine insufflation and for diagnosis by x-rays, complete, consisting of:

- 97-0664 1 Manometer with luminous dial
- 97-0663 1 Connecting-piece with stopcock
- 97-0665 1 Uterine cannula with stopcock
- 97-0666 1 Interchangeable occlusive nozzle, small
- 97-0667 1 Interchangeable occlusive nozzle, medium
- 97-0668 1 Interchangeable occlusive nozzle, large
- 97-0669 1 Record syringe 10 ccm, with LUER-LOCK mount
- 97-0661 1 Wooden Case

Salpingógrafo completo para el diagnóstico y tratamiento de la esterilidad, para inyecciones de Lipiodol en el útero y en las trompas de Falopio, para la insuflación intra-uterina y para el diagnóstico radiográfico, completo, compuesto de:

- 97-0664 1 Manómetro con escala luminosa
- 97-0663 1 Pieza conectiva con llave
- 97-0665 1 Sonda para trompas de Falopio con llave
- 97-0666 1 Cono uterinos intercambiables, pequeño
- 97-0667 1 Cono uterinos intercambiables, mediano
- 97-0668 1 Cono uterinos intercambiables, grande
- 97-0669 1 Jeringa Record 10 ccm, con LUER-LOCK
- 97-0661 1 Estuche de madera

Salpingographe complet pour diagnostic et traitement de la stérilité, pour injection de lipiodol dans l'utérus et les trompes, pour insufflation intra utérine et diagnostic avec rayons X, complet, composé de:

- 97-0664 1 Manomètre
- 97-0663 1 Embout avec robinet
- 97-0665 1 Canule utérine avec robinet
- 97-0666 1 Embout petit
- 97-0667 1 Embout moyen
- 97-0668 1 Embout grand
- 97-0669 1 Seringue 10 cc avec embout LUER-LOCK
- 97-0661 1 Boîtier en bois

Salpingografo per la diagnosi, ed il trattamento della sterilita, per l'iniezione di lipioda nell'utero e nei tubi di falloppio, per l'insufflazione introuterina e diagnostica a raggi X, completo, composto da:

- 97-0664 1 Manometro con ruadrante luminoso
- 97-0663 1 Connessione con rubinetto
- 97-0665 1 Cannula uterina con rubinetto
- 97-0666 1 Cono d'occlusione intercambiabile, piccolo
- 97-0667 1 Cono d'occlusione intercambiabile, medio
- 97-0668 1 Cono d'occlusione intercambiabile, grande
- 97-0669 1 Siringa record 10 ccm, con attacco LUER-LOCK
- 97-0661 1 Astuccio in legno

SCHULTZE

97-0662

Salpingograph - ohne Manometer - zur Sterilitätsdiagnose und -behandlung, zur Röntgendarstellung und Durchblasung von Cervix, Uterus und Tuben, komplett, bestehend aus:

- 97-0665 1 Tubenkatheter mit Hahn
- 97-0666 1 auswechselbarer Uterusverschlußkegel, klein
- 97-0667 1 auswechselbarer Uterusverschlußkegel, mittel
- 97-0668 1 auswechselbarer Uterusverschlußkegel, groß
- 97-0669 1 Recordspritze 10 ml, mit LUER-LOCK-Ansatz
- 97-0661 1 Holzetui

Salpingograph - without manometer - for diagnosis and treatment of sterility, for injections of Lipiodol into the uterus and the Fallopian tubes, for intra-uterine insufflation and for diagnosis by x-rays, complete, consisting of:

- 97-0665 1 Uterine cannula with stopcock
- 97-0666 1 Interchangeable occlusive nozzle, small
- 97-0667 1 Interchangeable occlusive nozzle, medium
- 97-0668 1 Interchangeable occlusive nozzle, large
- 97-0669 1 Record syringe 10 ccm, with LUER-LOCK mount
- 97-0661 1 Wooden Case

Salpingógrafo - sin manómetro - completo para el diagnóstico y tratamiento de la esterilidad, para inyecciones de Lipiodol en el útero y en las trompas de Falopio, para la insuflación intra-uterina y para el diagnóstico radiográfico, completo, compuesto de:

- 97-0665 1 Sonda para trompas de Falopio con llave
- 97-0666 1 Cono uterinos intercambiables, pequeño
- 97-0667 1 Cono uterinos intercambiables, mediano
- 97-0668 1 Cono uterinos intercambiables, grande
- 97-0669 1 Jeringa Record 10 ccm, con LUER-LOCK
- 97-0661 1 Estuche de madera

Salpingographe - sans manomètre - complet pour diagnostic et traitement de la stérilité, pour injection de lipiodol dans l'utérus et les trompes, pour insufflation intra utérine et diagnostic avec rayons X, complet, composé de:

- 97-0665 1 Canule utérine avec robinet
- 97-0666 1 Embout petit
- 97-0667 1 Embout moyen
- 97-0668 1 Embout grand
- 97-0669 1 Seringue 10 cc avec embout LUER-LOCK
- 97-0661 1 Boîtier en bois

Salpingografo - senza manometro - per la diagnosi, ed il trattamento della sterilita, per l'iniezione di lipioda nell'utero e nei tubi di falloppio, per l'insufflazione introuterina e diagnostica a raggi X, completo, composto da:

- 97-0665 1 Cannula uterina con rubinetto
- 97-0666 1 Cono d'occlusione intercambiabile, piccolo
- 97-0667 1 Cono d'occlusione intercambiabile, medio
- 97-0668 1 Cono d'occlusione intercambiabile, grande
- 97-0669 1 Siringa record 10 ccm, con attacco LUER-LOCK
- 97-0661 1 Astuccio in legno



LAWNTON

Medizintechnik

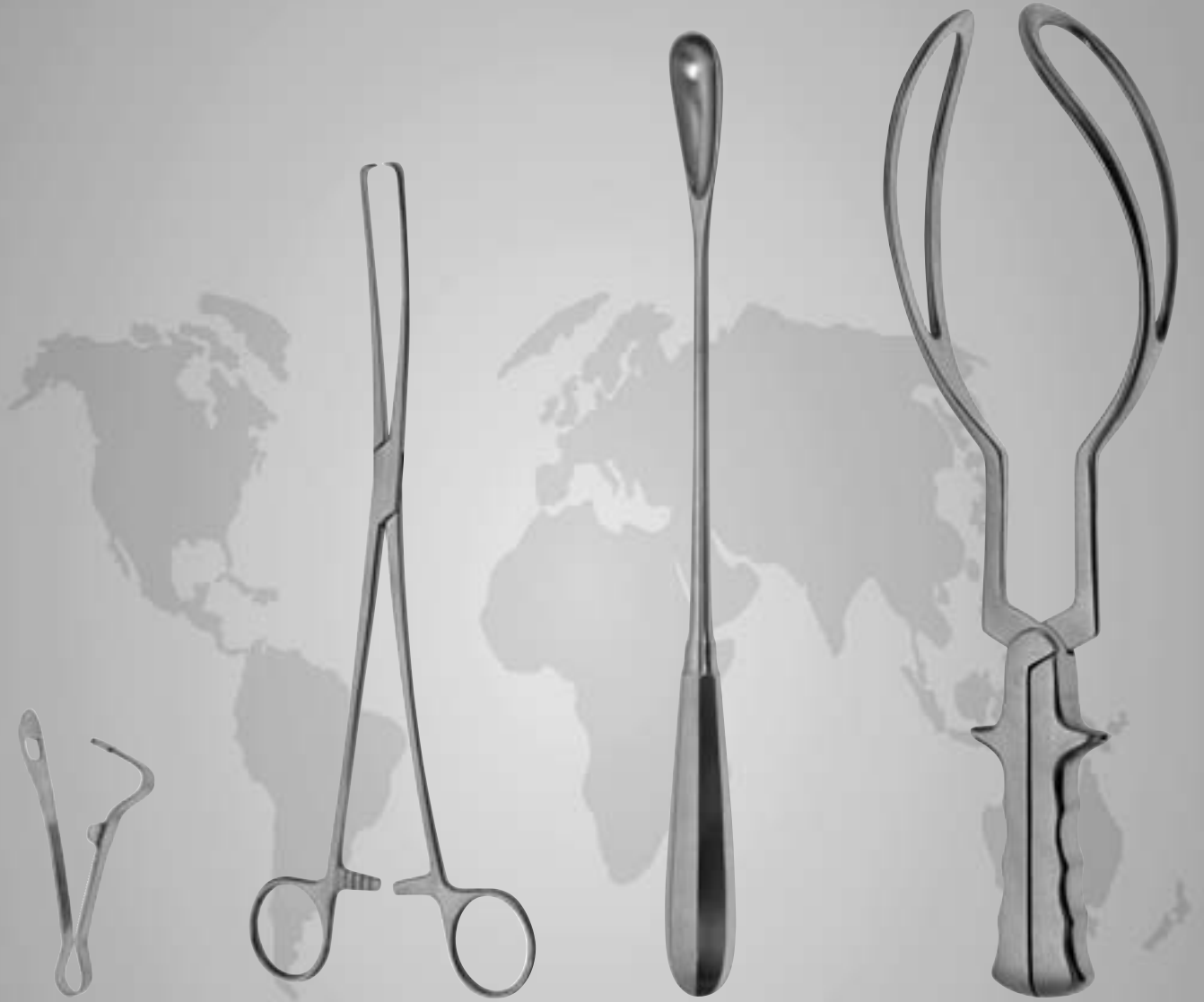

Geburtshilfe
Obstetrics
Obstetricia
Obstétrique
Ostetricia



Instrumente für Geburtshilfe
 Instruments for Obstetrics
 Instrumentos para obstétrica
 Instruments pour obstétrique
 Strumenti per ostetricia



DURACUT® Damm- (Episiotomie-) Scheren	Seite	60
DURACUT® Perineum (Episiotomy) Scissors	Page	60
DURACUT® Tijeras para perineo (episiotomía)	Página	60
DURACUT® Ciseaux à périnée (à épisiotomie)	Page	60
DURACUT® Forbici per perineo (episiotomia)	Pagina	60



Damm- (Episiotomie-) Scheren	Seite	107
Perineum (Episiotomy) Scissors	Page	107
Tijeras para perineo (episiotomía)	Página	107
Ciseaux à périnée (à épisiotomie)	Page	107
Forbici per perineo (episiotomia)	Pagina	107



Nabelschnurscheren	Seite	108
Umbilical Cord Scissors	Page	108
Tijeras umbilicales	Página	108
Ciseaux pour le cordon ombilical	Page	108
Forbici ombelicali	Pagina	108



Kephalotomiescheren	Seite	109
Decapitating Scissors	Page	109
Tijeras para decapitación	Página	109
Ciseaux à détroncation	Page	109
Forbici per decapitazione	Pagina	109

Beckenzirkel
Pelvimeter
Pelvímetro
Pelvimètre
Pelvimetro

Amniotom
Amniotome
Amniótomo
Amniotome
Amniotomo

Blasensprenger
Membrane Puncturing Forceps
Pinza para la vejiga amniótica
Pince perce membrane
Pinza per la puntura amniotica



MARTIN
97-0100
35 cm, 13^{3/4}"

Beckenzirkel, mit Zentimeter- und Zolleinteilung
Pelvimeter, graduated in centimeters and inches
Pelvímetro, graduado en centímetros y pulgadas
Pelvimètre, gradué en cm et en pouces
Pelvimetro, graduato in cm e in pollice



BEACHAM
97-0493
26,5 cm, 10^{1/2}"

Amniotom für die Amnionblase
Amniotome for the amnion bladder
Amniótomo para la vejiga amniótica
Amniotome pour le liquide amniotique
Amniotomo per la vescica amniotica

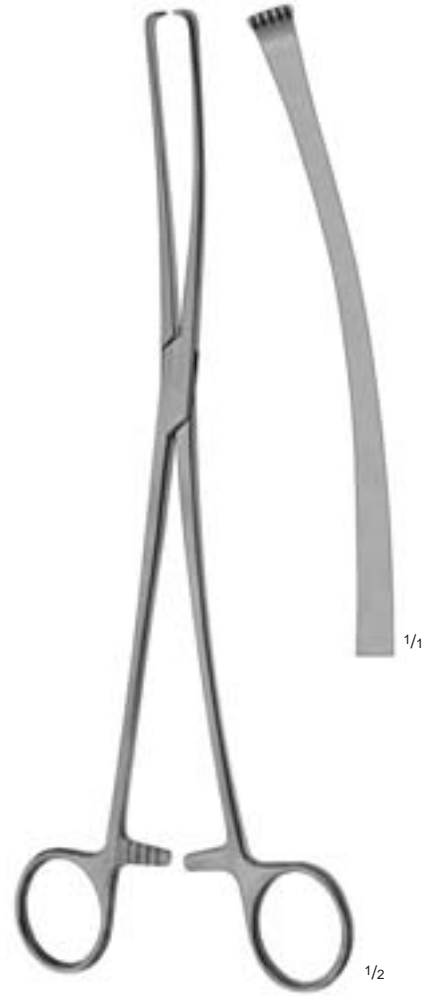

IOWA
97-0495
26 cm, 10^{1/4}"

Blasensprenger, 5x6 Zähne
Membrane puncturing forceps, 5x6 teeth
Pinza para la vejiga amniótica 5x6 dientes
Pince perce membrane, 5x6 dents
Pinza per puntura amniotica, 5x6 denti



Geburtszangen

Forceps

Fórceps

Forceps

Forcipi



SIMPSON-BRAUN
97-0201
31 cm, 12¹/₄"



SIMPSON-BRAUN
97-0200
36 cm, 14¹/₄"



NAEGELE
97-0202
35,5 cm, 14"



NAEGELE
97-0203
40 cm, 15³/₄"



KIELAND
97-0220
41 cm, 16"



KIELAND-LUIKART
97-0225
41 cm, 16"

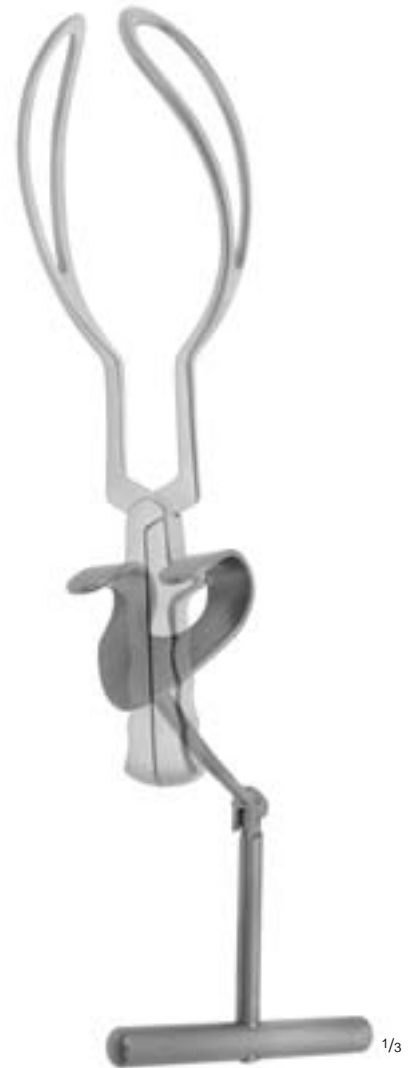

BILL
97-0290

Zughebel, passend für alle Geburtszangen mit gehorntem Standard-Griff

Traction handle to be used with all forceps with standard type handle

Tractor adecuado para todas las fórceps con mango standard

Tracteurs pour tous les forceps avec manches ordinaires

Manico a trazione adatto a tutte le forcipi con manico standard



Geburtszangen

Forceps

Fórceps

Forceps

Forcipi



1/3

WRIGLEY
97-0192
28 cm, 11"

Geburtszange für section caesares (Schnittentbindung)

Forceps for caesarean section

Fórceps para operación cesárea

Forceps pour césarienne

Forcipi per tagli cesarei



1/3

PIPER
97-0300
44,5 cm, 17 1/2"

für nachkommenden Kopf bei Steisslagen

for delivery of the after coming head in breech presentation

especialmente para partos en presentación de nalgas

Spatules pour dégager la tête

Speciale in parti con prententazione di podice



1/3

TARNIER
97-0306
40 cm, 15 3/4"

Geburtszange mit Achsenzugvorrichtung

Forceps with traction rod

Fórceps con dispositivo de tracción

Forceps avec dispositif de traction

Forcipi con dispositivo di trazione



1/2

SELLHEIM
 97-0382
 32 cm, 12 1/2"

Geburtslöffel
 Obstetric lever
 Separador para la salida de cabeza
 Levier obstétrique
 Leva ostetrica



1/3

MURLESS
 97-0380
 30 cm, 12"

Kopfhebel für unteres Segment bei Kaiserschnitt
 Head extractor for use in lower segment in caesarean operation
 Elevador para cabeza usándose en el segmento inferior del útero
 en casos de operaciones cesáreas
 Levier à tête utilisé en cas de césarienne
 Elevatore per testa in interventi con taglio cesareo

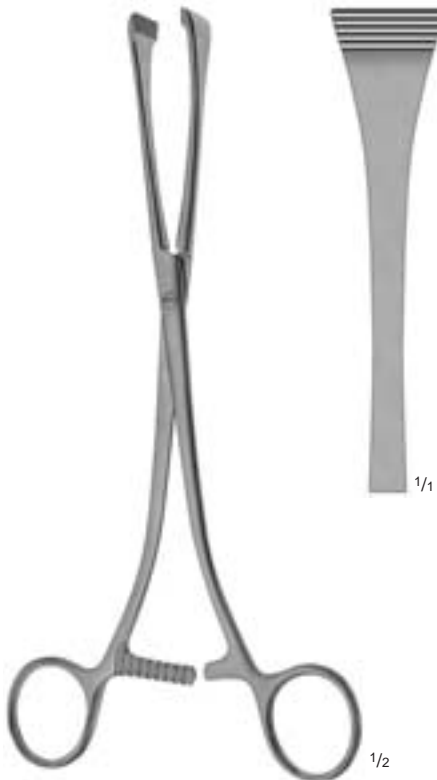

1/1

1/2

GREEN-ARMYTAGE
 97-0390
 20,5 cm, 8"

Uterusklemmzange zur Blutstillung
 Caesarean section haemostatic forceps
 Pinza-clamp uterina para hemostasis
 Pince-clamp utérine pour hémostase
 Pinza emostatiche per tagli cesarei



1/1

1/2

WILLETT
 97-0490
 19 cm, 7 1/2"

Kopfschwartzange
 Scalp flap forceps
 Pinza para pericráneo
 Pince pour le cuir chevelu
 Pinza per il cuoio capelluto



Plazentar- und Abortuszangen
Placenta and Ovum Forceps
Pinzas para aborto y placenta
Pinces placentaires et pour poste-abortum
Pinze placenta e per ovaie



97-0370
28,5 cm, 11 1/4"



▶ 97-0371
28,5 cm, 11 1/4"



97-0372
28,5 cm, 11 1/4"



97-0373
28,5 cm, 11 1/4"



▶ 97-0374
28,5 cm, 11 1/4"



97-0375
28,5 cm, 11 1/4"

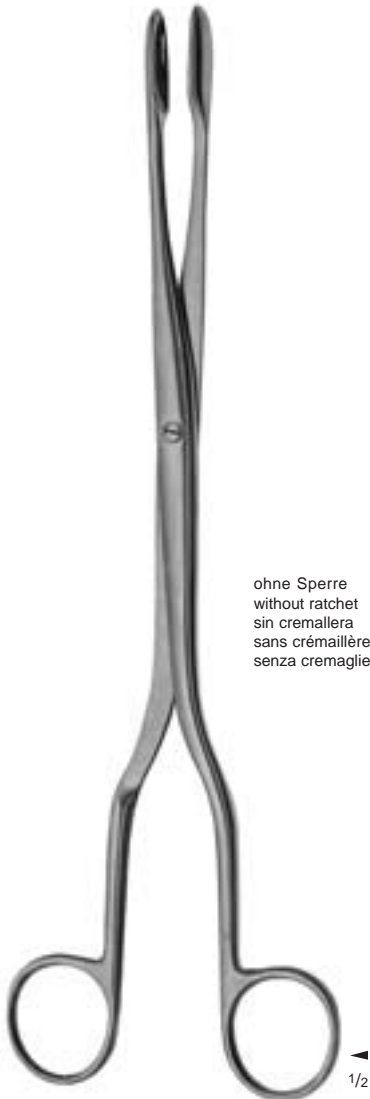

ohne Sperre
without ratchet
sin cremallera
sans crémaillère
senza cremagliera

WINTER
97-0370
- 97-0372



ohne Sperre
without ratchet
sin cremallera
sans crémaillère
senza cremagliera

WINTER
97-0373
- 97-0375



ohne Sperre
 without ratchet
 sin cremallera
 sans crémaillère
 senza cremagliera

SAENGER
 97-0470
 29 cm, 11 1/2"

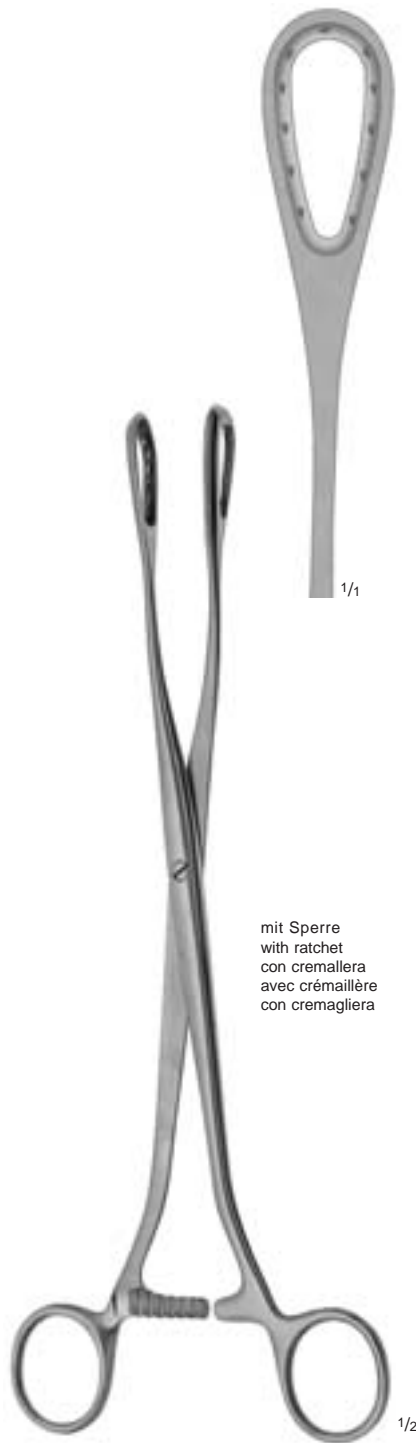

mit Sperre
 with ratchet
 con cremallera
 avec crémaillère
 con cremagliera

SAENGER
 97-0471
 27,5 cm, 10 3/4"

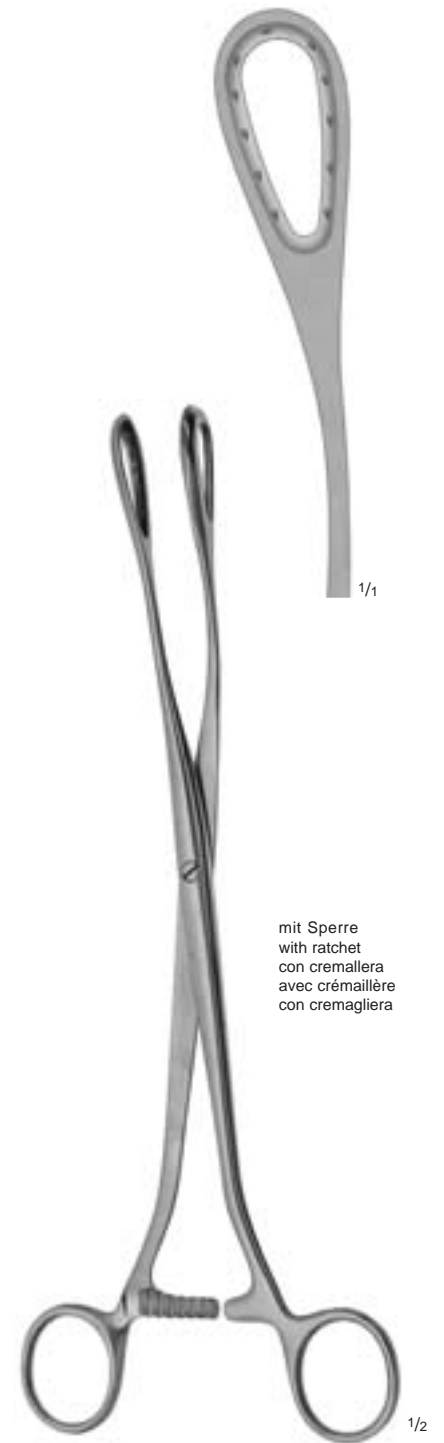

mit Sperre
 with ratchet
 con cremallera
 avec crémaillère
 con cremagliera

SAENGER
 97-0472
 27,5 cm, 10 3/4"



Plazentar- und Abortuslöffel
Placenta and Ovum Scoops
Cucharillas para aborto y placenta
Curettes à avortement et placenta
Cucchiai per placenta e ovaie

Plazentar- und Abortusküretten
Placenta and Ovum Curettes
Curetetas para aborto y placenta
Curettes à avortement et placenta
Curette per placenta e ovaie

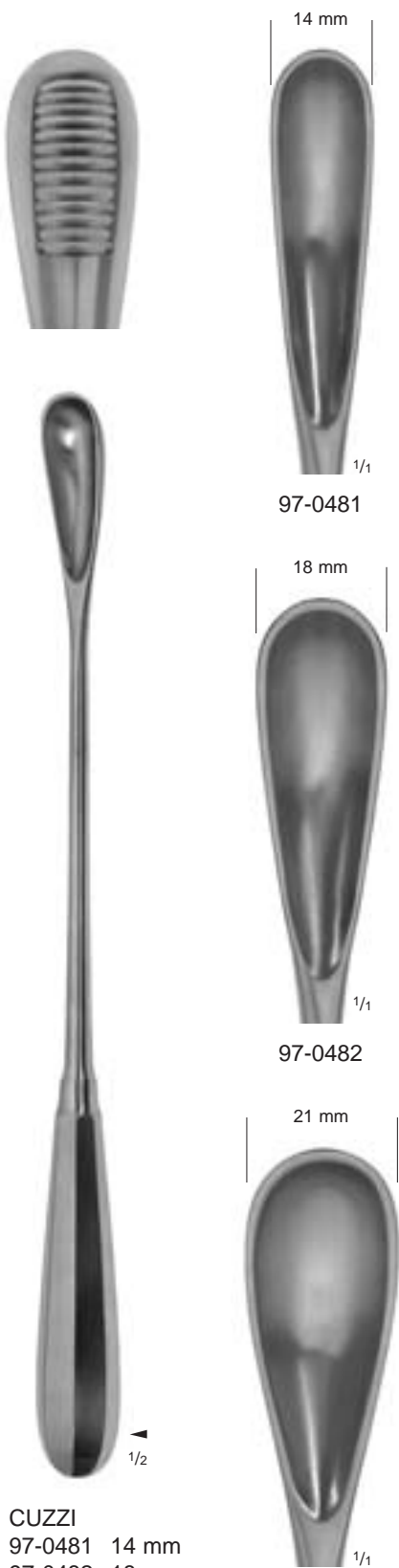

CUZZI

- 97-0481 14 mm
- ▶ 97-0482 18 mm
- 97-0483 21 mm
- 30 cm, 12"

Plazentar- und Abortuslöffel
Placenta and ovum scoops
Cucharillas para aborto y placenta
Curettes à avortement et placenta
Cucchiai per placenta e ovaie

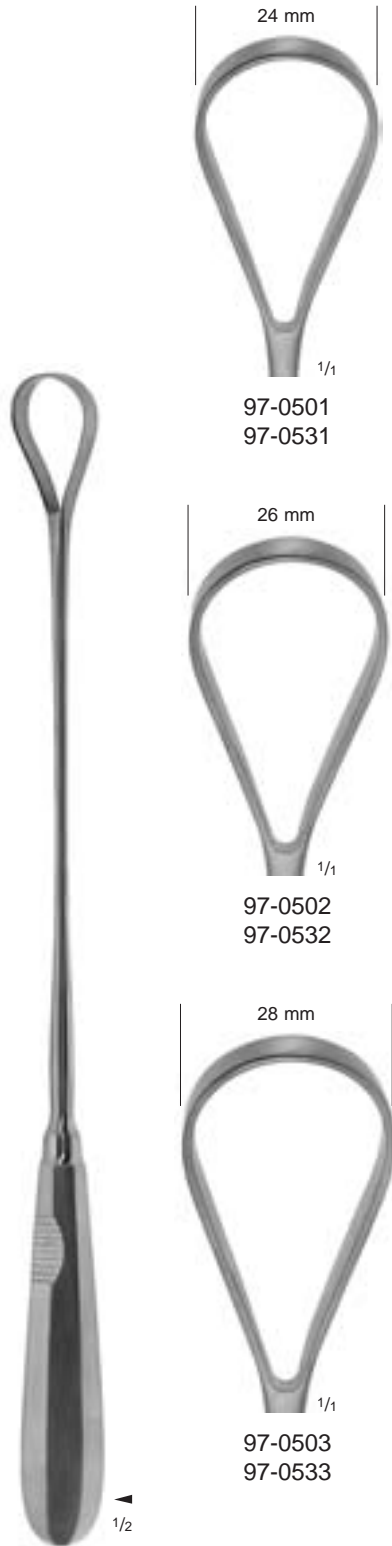

BUMM

- ▶ 97-0501 24 mm
- 97-0502 26 mm
- 97-0503 28 mm
- 31 cm, 12 1/4"
- 97-0531 24 mm
- 97-0532 26 mm
- 97-0533 28 mm
- 31 cm, 12 1/4"

scharf, biegsam
sharp, malleable
cortantes, maleable
trachentes, malléables
acute, malleabile

stumpf, biegsam
blunt, malleable
romas, maleable
mousses, malléables
smusse, malleabile

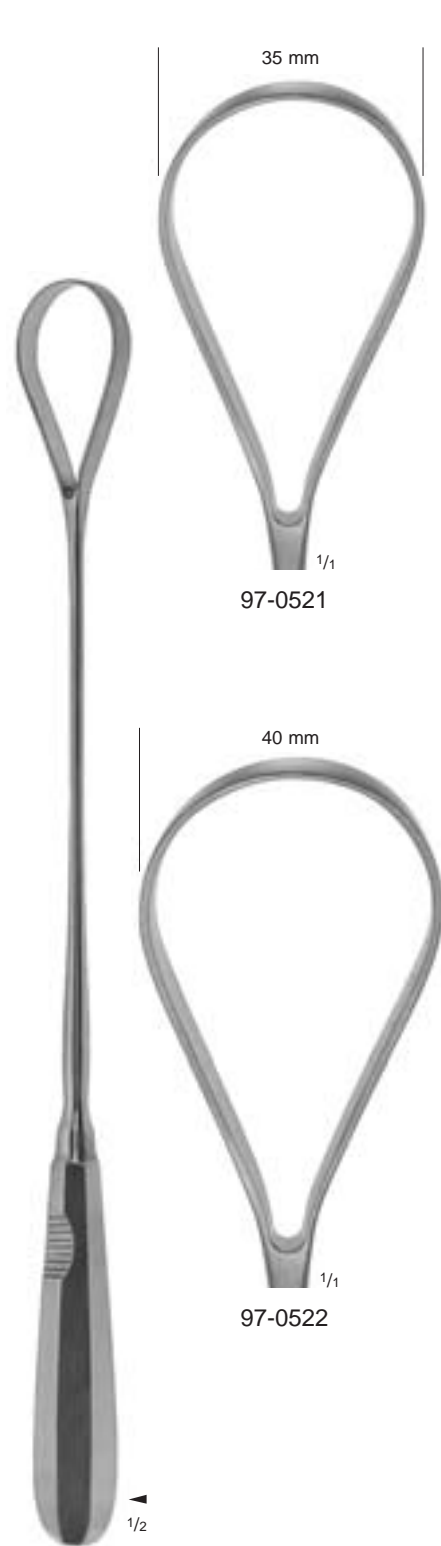

RECAMIER

- 97-0521 35 mm
- ▶ 97-0522 40 mm
- 33,5 cm, 13 1/4"

Plazentar- und Abortusküretten, stumpf / fest
Placenta and ovum curettes, blunt / rigid
Curetetas para aborto y placenta, romas / rígidas
Curettes à avortement et placenta, mousses / rigide
Curette per placenta e ovaie, smusse / rigide

Kranioklast
Cranioclast
Craneoclasto
Cranioclaste
Cranioclasto

Perforatorium
Perforator
Perfora-crâneos
Perce-crâne
Spezzacrano

Dekapitationshaken
Decapitating Hook
Gancho para decapitación
Crochet pour décapitation
Uncino per detroncazione



1/3

BRAUN
97-0410
42 cm, 16 1/2"

Kranioklast
Cranioclast
Craneoclasto
Cranioclaste
Cranioclasto



1/2

SMELLIE
97-0430
25,5 cm, 10"

Perforatorium
Perforator
Perfora-crâneos
Perce-crâne
Spezzacrano



1/2

BRAUN
97-0415
32,5 cm, 12 3/4"

Dekapitationshaken
Decapitating hook
Gancho para decapitación
Crochet pour décapitation
Uncino per detroncazione



Instrumente zur Geburtshilfe
Instruments for Obstetrics
Instrumentos para obstétrica
Instruments pour obstétrique
Strumenti per ostetricia

Instrumente zur transvaginalen Injektion bei Paracervical- und Pudendusnästhesie

Instruments for transvaginal injection for paracervical anaesthesia as well as anaesthesia of the pudendus

Instrumentos para la anestesia transvaginal (pudendus)

Instruments pour anesthésie vaginale

Strumenti per anestesia paracervicale o del pudendo mediante iniezione transvaginale



IOWA
97-0440
14 cm, 5 1/2"

Nadelführung
Trumpet needle guide
Aguja de guía
Aiguille trompette guide
Guida ago a tromba



IOWA
97-0443
ø 0,9 mm x 150 mm

Injektionskanüle,
LUER-LOCK
Injection needle,
LUER-LOCK

Aguja hipodérmica,
LUER-LOCK

Aiguille à hypodermique
LUER-LOCK

Ago per iniezione, attacco
LUER-LOCK



HASSELTINE
97-0515
6 cm, 2 3/8"

Nabelschnurklemmen, in
Packungen zu 12 Stück

Umbilical cord clamps, in
packages of 12 pieces

Clamps umbilicales, en
paquetes de 12 piezas

Clamps pour le cordon
ombilical, en paquet de 12

Pinze ombelicali, pacchi
da 12 pz.



COLLIN
97-0513
9 cm, 3 1/2"

Nabelschnurklemme
Umbilical cord clamp
Clamp umbilicale
Clamp pour le cordon ombilical
Clamp ombelicale



LAWNTON
Medizintechnik



Thorax- und Gefäßchirurgie
Thoracic and Vascular Surgery
Cirugía torácico y vascular
Chirurgie thoracique et vasculaire
Chirurgia toracica e vascolare



Instrumente für Thorax- und Gefäßchirurgie
Instruments for Thoracic and Vascular Surgery
Instrumentos para cirugía torácico y vascular
Instruments pour chirurgie thoracique et vasculaire
Strumenti per la chirurgia vascolare e toracica



DURACUT® Gefäßscheren	Seite	56 - 57
DURACUT® Vascular Scissors	Page	56 - 57
DURACUT® Tijeras vasculares	Página	56 - 57
DURACUT® Ciseaux vasculaires	Page	56 - 57
DURACUT® Forbici vascolari	Pagina	56 - 57



Gefäßscheren mit flachen Federgriffen	Seite	64
Vascular Scissors with Flat Spring Type Handles	Page	64
Tijeras vasculares con mangos de resortes planos	Página	64
Ciseaux vasculaires avec manches à ressorts plats	Page	64
Forbici vascolari con manici a molla piatta	Pagina	64



Gefäßscheren	Seite	95 - 99
Vascular Scissors	Page	95 - 99
Tijeras vasculares	Página	95 - 99
Ciseaux vasculaires	Page	95 - 99
Forbici vascolari	Pagina	95 - 99



Lungenlappenschere	Seite	99
Lobectomy Scissors	Page	99
Tijera para lobectomía	Página	99
Ciseaux à lobectomie	Page	99
Forbici per lobectomia	Pagina	99



ATRAUMATIC-GRIP Gefäßpinzetten	Seite	135
ATRAUMATIC-GRIP Vascular Forceps	Page	135
ATRAUMATIC-GRIP Pinzas vasculares	Página	135
ATRAUMATIC-GRIP Pincas vasculaires	Page	135
ATRAUMATIC-GRIP Pinze vascolari	Pagina	135



Lungenfaßpinzetten	Seite	148 - 149
Lung Grasping Forceps.....	Page	148 - 149
Pinzas agarre del pulmón	Página	148 - 149
Pince pour dissection des poumons	Page	148 - 149
Pinze da presa per la dissezione del polmone	Pagina	148 - 149



TITAN-LINE Bulldogklemmen aus TITAN	Seite	160 - 161
TITAN-LINE Bulldog Clamps, made of TITANIUM	Page	160 - 161
TITAN-LINE Clamps Bulldog, de TITANIO	Página	160 - 161
TITAN-LINE Clamps Bulldog en TITANE	Page	160 - 161
TITAN-LINE Pinze Bulldog in TITANIO	Pagina	160 - 161



Mikro-Bulldogklemmen	Seite	162
Micro Bulldog Clamps	Page	162
Micro-Clamps Bulldog	Página	162
Micro Clamps Bulldog	Page	162
Micro Pinze Bulldog	Pagina	162



Bulldogklemmen	Seite	163
Bulldog Clamps	Page	163
Clamps Bulldog	Página	163
Clamps Bulldog	Page	163
Pinze Bulldog	Pagina	163



ATRAUMATIC-GRIP Gefäßklemmen	Seite	165, 167, 176
ATRAUMATIC-GRIP Vascular Clamps	Page	165, 167, 176
ATRAUMATIC-GRIP Pinzas-clamps vasculares	Página	165, 167, 176
ATRAUMATIC-GRIP Pincas-clamps vasculaires	Page	165, 167, 176
ATRAUMATIC-GRIP Pinze/clamp cardiovascolari	Pagina	165, 167, 176

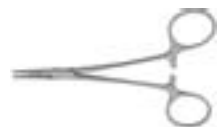

Präparier- und Ligaturklemmen	Seite	180 - 189
Dissecting and Ligature Forceps	Page	180 - 189
Pinzas de disección y ligaduras	Página	180 - 189
Pincas à disséquer et à ligatures	Page	180 - 189
Pinze per dissezione e legature	Pagina	180 - 189



ATRAUMATIC-GRIP Präparier- und Ligaturklemmen	Seite	186
ATRAUMATIC-GRIP Dissecting and Ligature Forceps	Page	186
ATRAUMATIC-GRIP Pinzas de disección y ligaduras	Página	186
ATRAUMATIC-GRIP Pincas à disséquer et à ligatures	Page	186
ATRAUMATIC-GRIP Pinze per dissezione e legature	Pagina	186





Instrumente für Thorax- und Gefäßchirurgie
 Instruments for Thoracic and Vascular Surgery
 Instrumentos para cirugía torácico y vascular
 Instruments pour chirurgie thoracique et vasculaire
 Strumenti per la chirurgia vascolare e toracica



Scapula-Haken	Seite	260
Scapula Retractors	Page	260
Separadores para scápula	Página	260
Ecarteurs à scapula.....	Page	260
Retrattori per scapola	Pagina	260



Lungenhaken	Seite	260
Lung Retractors	Page	260
Separadores para el pulmón	Página	260
Ecarteur à poumons	Page	260
Retrattori per polmone	Pagina	260



Wundhaken und Lungenspatel	Seite	260 - 265
Retractors and Lung Spatulas	Page	260 - 265
Separadores y espátulas para el pulmón	Página	260 - 265
Ecarteurs et spatules pulmonaires	Page	260 - 265
Retrattori e spatole per polmone	Pagina	260 - 265



Venenstripper	Seite	315
Vein Strippers	Page	315
Sondas para várices	Página	315
Strippers à varices	Page	315
Sonde per vene	Pagina	315



Gefäßspülkanülen	Seite	322
Vascular Irrigation Cannulae	Page	322
Cánulas vasculares para irrigación	Página	322
Aiguilles vasculaires pour irrigation	Page	322
Cannule vascolari per irrigazione	Pagina	322



Saugrohre	Seite	325 - 327
Suction Tubes	Page	325 - 327
Tubos para aspiración	Página	325 - 327
Canules d'aspiration	Page	325 - 327
Tubi per aspirazione	Pagina	325 - 327

Instrumente für Thorax- und Gefäßchirurgie
 Instruments for Thoracic and Vascular Surgery
 Instrumentos para cirugía torácico y vascular
 Instruments pour chirurgie thoracique et vasculaire
 Strumenti per la chirurgia vascolare e toracica



Lungenfaßzangen	Seite	385 - 388
Lung Grasping Forceps.....	Page	385 - 388
Pinzas-clamps agarre del pulmón	Página	385 - 388
Pinces-clamps pour poumons	Page	385 - 388
Pinze da presa per la dissezione del polmone	Pagina	385 - 388



ATRAUMATIC-GRIP Gewebe- und Organfaßzangen	Seite	389
ATRAUMATIC-GRIP Tissue and Organ Grasping Forceps	Page	389
ATRAUMATIC-GRIP Pinzas para tejidos y organos	Página	389
ATRAUMATIC-GRIP Pinces pour tissn et organes	Page	389
ATRAUMATIC-GRIP Pinze da presa per tessuti ed organi	Pagina	389



Embolusfaßzangen	Seite	418
Embolus Grasping Forceps	Page	418
Pinza agarre para embolus	Página	418
Pinces à traction	Page	418
Pinze da presa per emboli	Pagina	418





Sternummeißel
 Sternum Chisel
 Cincel para esternón
 Cisaille et ciseau-burins à sternum
 Scalpello per sterno

Rippenscheren
 Rib Shears
 Costótomos
 Costotomes
 Costotomi



LEBSCHKE
 38-0255
 25,5 cm, 10"

Sternummeißel
 Sternum chisel
 Cincel para esternón
 Cisaille et ciseau-burins à sternum
 Scalpello per sterno



GLUCK
 38-0110
 21 cm, 8 1/4"

Rippenscheren mit ziehendem Schnitt
 Rib shears with drawing cut
 Costótomo con hoja de retroacción
 Costotome avec lame excentrée
 Costotomo con lama eccentrica a scorrimento



38-0099
 22 cm, 8 3/4"

Rippenscheren
 Rib shears
 Costótomo
 Costotome
 Costotomo



38-0100
 23 cm, 9"

Rippenscheren
 Rib shears
 Costótomo
 Costotome
 Costotomo



SAUERBRUCH
 38-0150
 27 cm, 10 3/4"

Rippenscheren
 Rib shears
 Costótomo
 Costotome
 Costotomo



STILLE-GIERTZ
 38-0200
 27 cm, 10 3/4"

Rippenscheren
 Rib shears
 Costótomo
 Costotome
 Costotomo

Rippenscheren
 Rib Shears
 Costótomos
 Costotomes
 Costotomi

Rippen- und Knochenfaßzangen
 Rib and Bone Holding Forceps
 Pinzas para huesos
 Daviers à os
 Pinze per ossa e costole



BETHUNE
 38-0330
 34,5 cm, 13 1/2"
 Rippenschere
 Rib shears
 Costótomo
 Costotome
 Costotomo

1/3

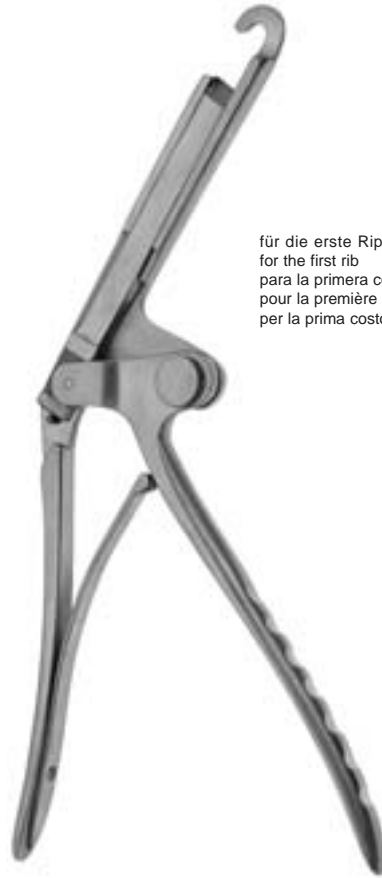

für die erste Rippe
 for the first rib
 para la primera costilla
 pour la première côte
 per la prima costola

SAUERBRUCH-FREY
 38-0198
 34,5 cm, 13 1/2"
 Rippenschere
 Rib shears
 Costótomo
 Costotome
 Costotomo

1/3



SEMB
 38-0230
 19,5 cm, 7 3/4"
 Rippen- und Knochenfaßzange
 Rib and bone holding forceps
 Pinza para huesos
 Daviers à os
 Pinza per ossa e costole

1/2



SEMB
 38-0231
 19,5 cm, 7 3/4"
 Rippen- und Knochenfaßzange
 Rib and bone holding forceps
 Pinza para huesos
 Daviers à os
 Pinza per ossa e costole

1/2



Knochensplitterzangen
 Bone Cutting Forceps
 Pinzas cortantes para huesos
 Pincès coupantes à os
 Cesoie per ossa

Hohlmeißelzangen
 Rib Rongeurs
 Pinzas-gubias
 Pincès-gouges
 Pinze per costole

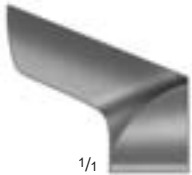

1/1



1/3

LISTON-KEY-HORSLEY
 38-0220
 24,5 cm, 9 3/4"

Knochensplitterzange, doppelt gebogen, für hintere Rippenstümpfe

Bone cutting forceps, S - shaped, for posterior rib stumps

Pinza cortante para huesos, doble curvada, para los muñones de las costillas posteriores

Pincès coupantes à os, double courbure pour extrémité des côtes postérieures

Cesoia per ossa, ad „s“ per estremità delle costole posteriori

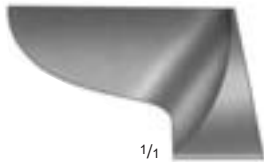

1/1



1/3

SEMB
 38-0210
 23,5 cm, 9 1/4"

Knochensplitterzange, seitwärts gebogen, für vordere Rippenstümpfe

Bone cutting forceps, curved sideways, for anterior rib stumps

Pinza cortante para huesos, curvada lateral, para los muñones de las costillas anteriores

Pincès coupantes à os, courbure latérale pour extrémité des côtes antérieures

Cesoia per ossa, curve lateralmente per le estremità delle costole anteriori



1/1



1/3

MARKWALDER
 45-0498
 19 cm, 7 1/2"

Rundmeißelzange zum Abrunden der Rippenstümpfe

Rib rongeur to round the rib stumps

Pinza gubia redonda para redondear los muñones de las costillas

Pincès coupante pour la base des côtes

Pinza per ossa per tranciare le costole



1/1



1/3

SEMB
 38-0701
 24 cm, 9 1/2"

Hohlmeißelzange zum Kürzen der Rippenstümpfe

Rib rongeur to shorten the rib stumps

Pinza gubia para acortar los muñones de las costillas

Pincès coupante pour raccourcir les côtes

Pinza per ossa per accorciare le costole



DOYEN
 39-0165
 15,5 cm, 6"

für Kinder, rechts
 for children, right
 para niños, derecha
 pour enfants, à droite
 per bambini, destra

DOYEN
 39-0166
 15,5 cm, 6"

für Kinder, links
 for children, left
 para niños, izquierda
 pour enfants, à gauche
 per bambini, sinistra

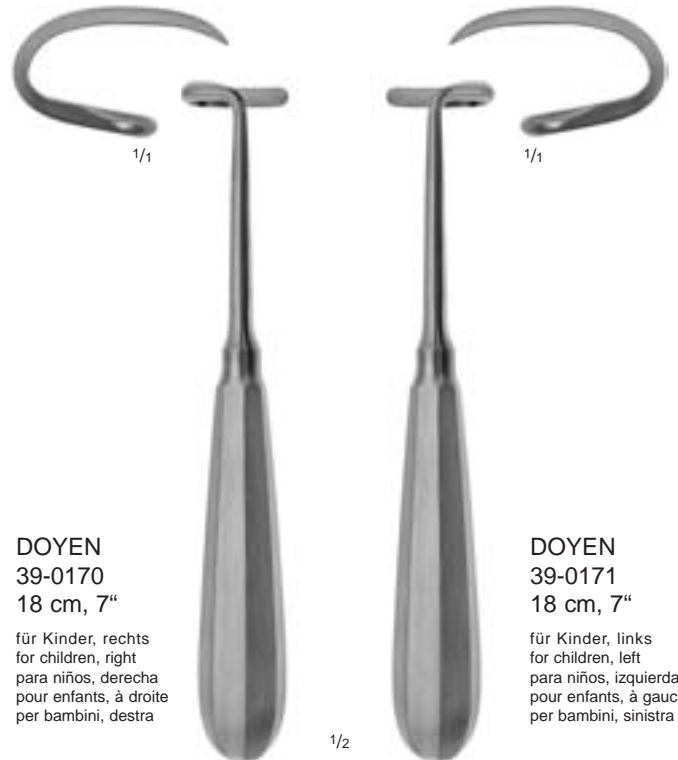

DOYEN
 39-0170
 18 cm, 7"

für Kinder, rechts
 for children, right
 para niños, derecha
 pour enfants, à droite
 per bambini, destra

DOYEN
 39-0171
 18 cm, 7"

für Kinder, links
 for children, left
 para niños, izquierda
 pour enfants, à gauche
 per bambini, sinistra



DOYEN
 39-0175
 17 cm, 6³/₄"

für Erwachsene, rechts
 for adults, right
 para adultos, derecha
 pour adultes, à droite
 per adulti, destra

DOYEN
 39-0176
 17 cm, 6³/₄"

für Erwachsene, links
 for adults, left
 para adultos, izquierda
 pour adultes, à gauche
 per adulti, sinistra



Rippenraspatorien
Rib Raspatories
Periostótomos costales
Rugines à costales
Periostotomi costali

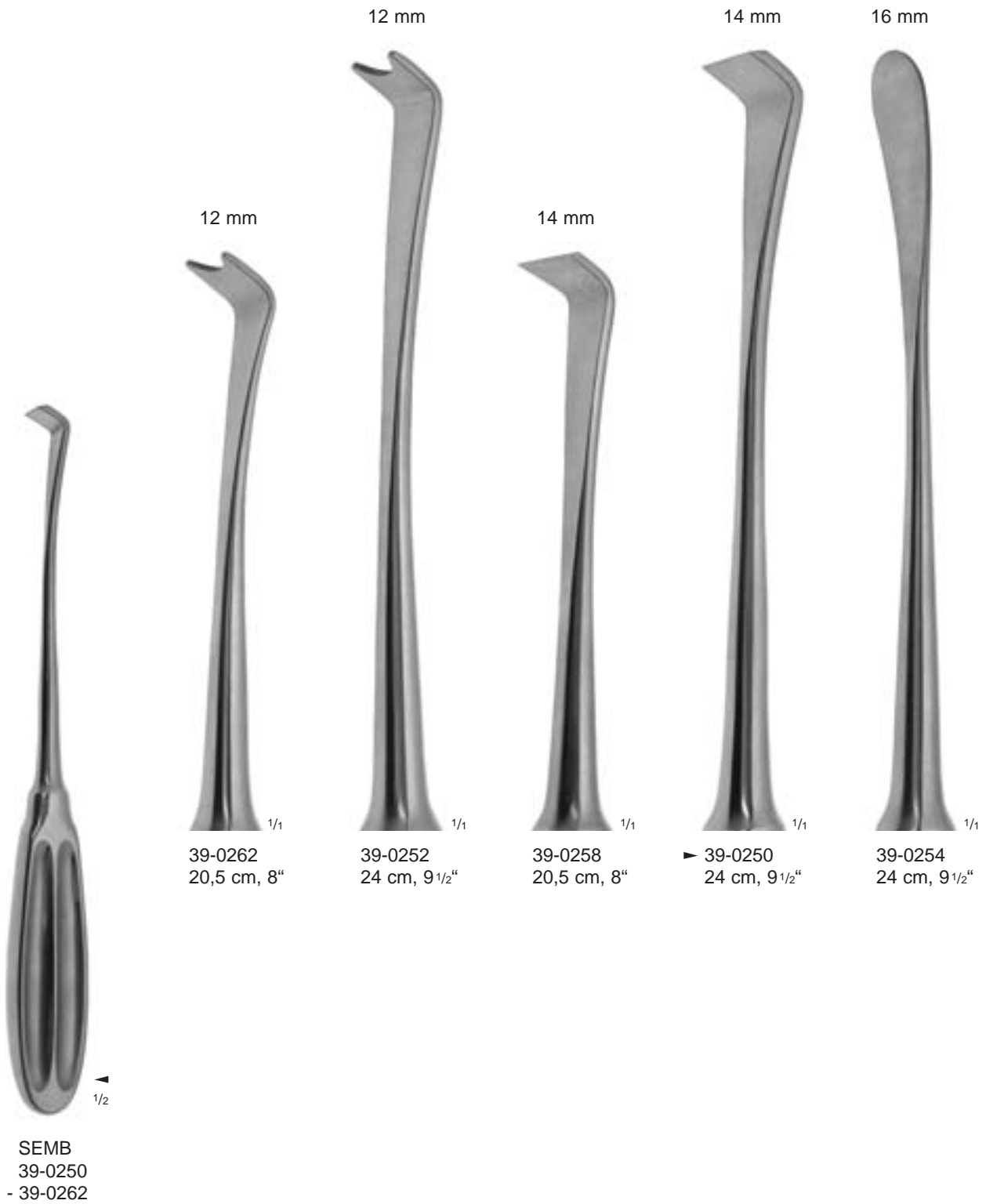

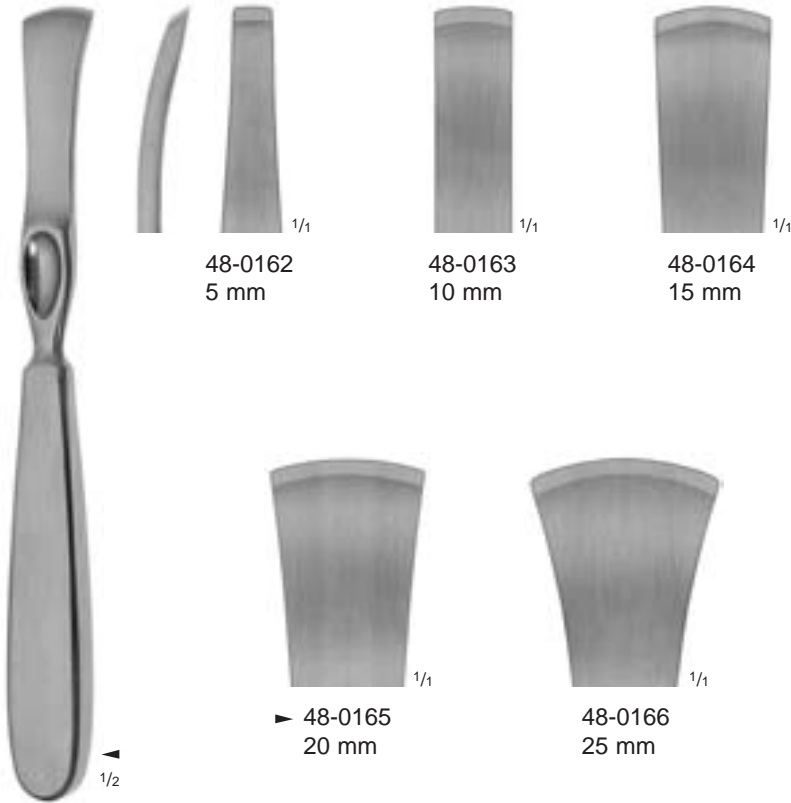

48-0162
5 mm

48-0163
10 mm

48-0164
15 mm

▶ 48-0165
20 mm

48-0166
25 mm

LAMBOTTE
 48-0162
 - 48-0166
 21 cm, 8 1/4"

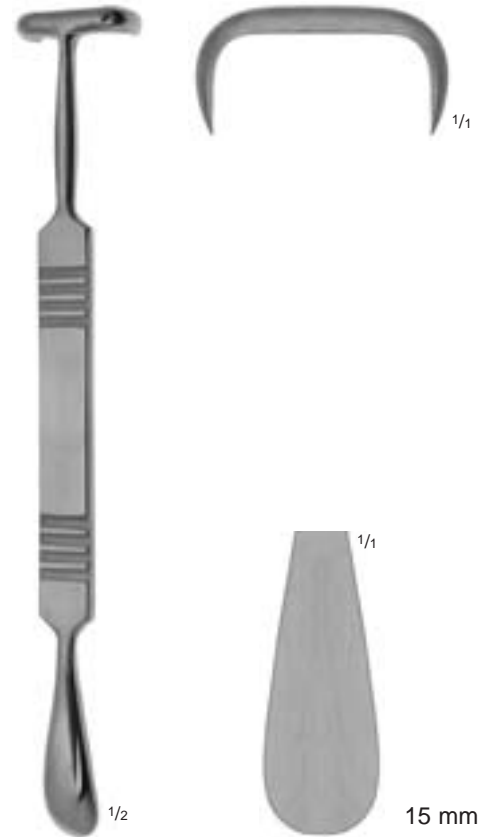

MATSON
 39-0130
 22 cm, 8 3/4"

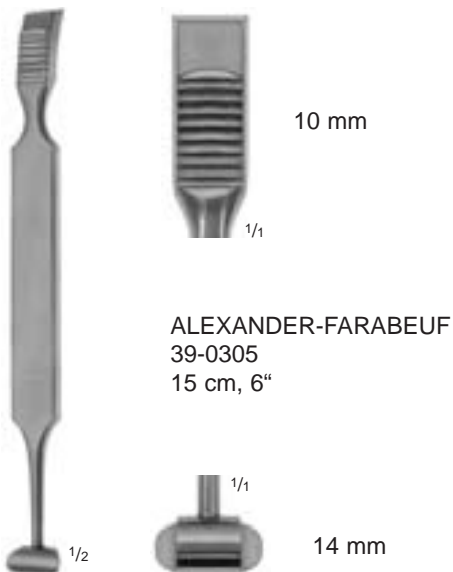

10 mm

ALEXANDER-FARABEUF
 39-0305
 15 cm, 6"

14 mm



12 mm

ALEXANDER-FARABEUF
 39-0302
 21 cm, 8 1/4"

24 mm



Sternotomie-Sperrer aus ALUMINIUM
 Sternotomy Spreaders from ALUMINIUM
 Separadores para esternotomía de ALUMINIO
 Ecarteurs à sternotomie en ALUMINIUM
 Divaricatore per sternotomia in ALLUMINIO

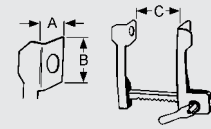

COOLEY

	A	B	C
37-0143	12 mm	16 mm	70 mm

für Säuglinge • for babies • para bebés • pour bébé • per neonati

1/3



COOLEY

	A	B	C
37-0144	15 mm	30 mm	100 mm

für Kinder • for children • para niños • pour enfants • per bambini

1/3

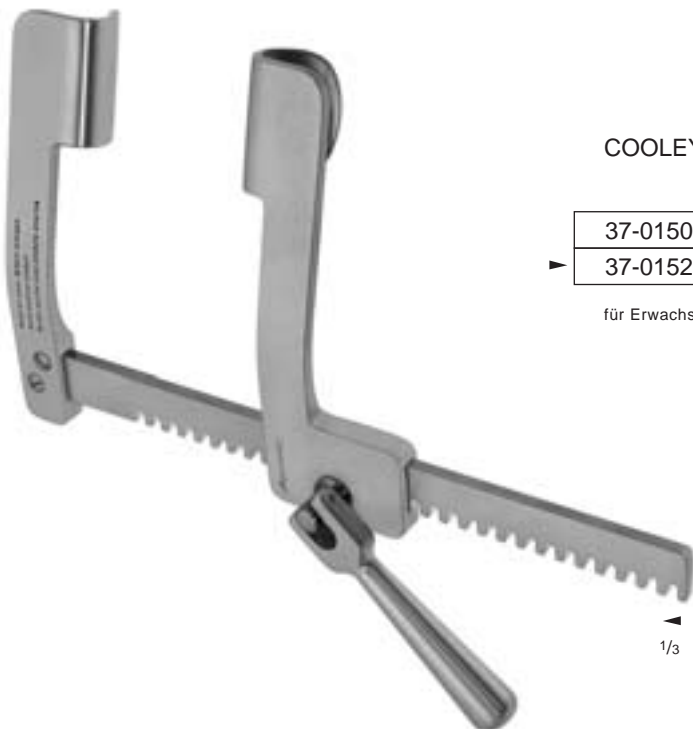

COOLEY

	A	B	C
37-0150	20 mm	45 mm	140 mm
37-0152	30 mm	50 mm	185 mm

für Erwachsene • for adults • para adultos • pour adultes • per adulti

1/3

Sternotomie-Sperrer
 Sternotomy Spreaders
 Separadores para esternotomía
 Ecarteurs à sternotomie
 Divaricatori per sternotomia

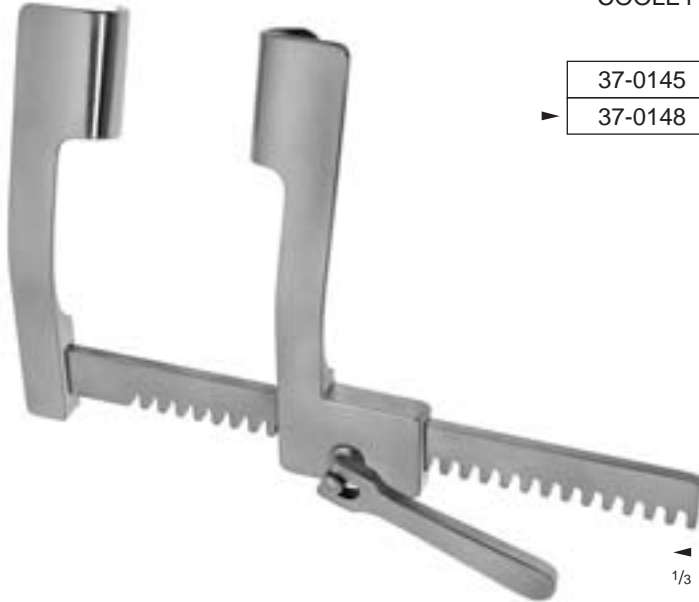
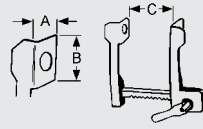

COOLEY

	A	B	C
▶ 37-0145	21 mm	45 mm	150 mm
▶ 37-0148	35 mm	50 mm	175 mm

37-0145

für Kinder
 for children
 para niños
 pour enfants
 per bambini

37-0148

für Erwachsene
 for adults
 para adultos
 pour adultes
 per adulti

▶ 1/3

mit beweglichen Doppelvalven
 with moveable double blades
 con valvas dobles maleables
 avec doubles valves malléables
 con doppie valve mobili



MORSE

	A	B	C
▶ 37-0155	15 mm	21 mm	165 mm
▶ 37-0156	22 mm	27 mm	200 mm

37-0155

für Kinder
 for children
 para niños
 pour enfants
 per bambini

37-0156

für Erwachsene
 for adults
 para adultos
 pour adultes
 per adulti

▶ 1/3



Rippensperrer aus ALUMINIUM
 Rib Spreaders from ALUMINIUM
 Separadores costales de ALUMINIUM
 Ecarteurs à côtes en ALUMINIUM
 Divaricatori costali in ALLUMINIO

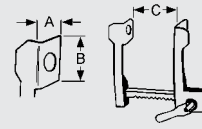

CASTANEDA

	A	B	C
37-0157	10 mm	32 mm	65 mm

für Säuglinge • for babies • para bebés • pour bébés • per neonati



CASTANEDA

	A	B	C
37-0158	12 mm	45 mm	70 mm

für Kinder • for children • para niños • pour enfants • per bambini



CASTANEDA

	A	B	C
37-0159	15 mm	60 mm	120 mm

für Kinder • for children • para niños • pour enfants • per bambini



FINOCHIETTO modif.

	A	B	C
37-0142	14 mm	15 mm	120 mm

für Kinder • for children • para niños • pour enfants • per bambini

Rippensperrer aus ALUMINIUM
 Rib Spreaders from ALUMINIUM
 Separadores costales de ALUMINIO
 Ecarteurs à côtes en ALUMINIUM
 Divaricatori costali in ALLUMINIO

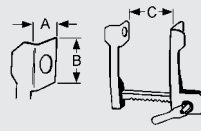

FINOCHIETTO-INFANT

	A	B	C
37-0185	15 mm	15 mm	75 mm

für Säuglinge • for babies • para bebés • pour bébés • per neonati



FINOCHIETTO-BABY-HAIGHT

	A	B	C
37-0186	31 mm	31 mm	100 mm

für Kinder • for children • para niños • pour enfants • per bambini

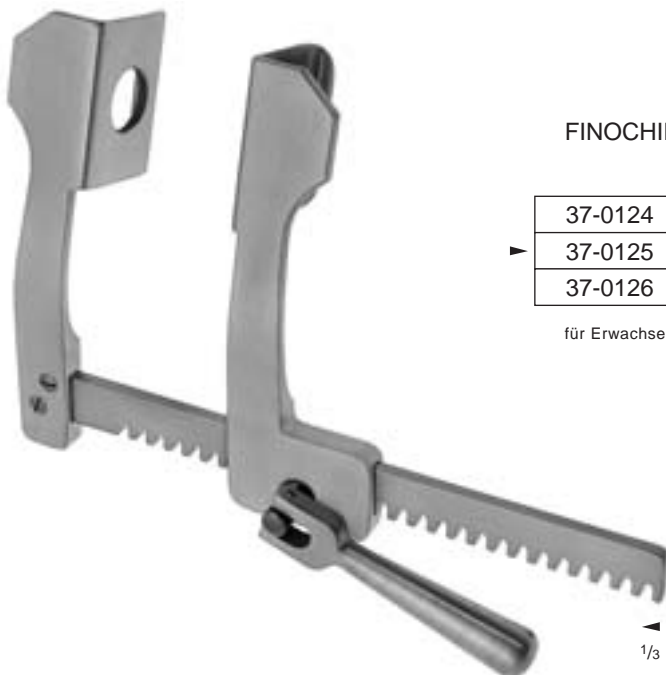

FINOCHIETTO

	A	B	C
37-0124	35 mm	44 mm	150 mm
37-0125	47 mm	62 mm	180 mm
37-0126	79 mm	62 mm	180 mm

für Erwachsene • for adults • para adultos • pour adultes • per adulti



Rippensperrer aus ALUMINIUM
 Rib Spreaders from ALUMINIUM
 Separadores costales de ALUMINIO
 Ecarteurs à côtes en ALUMINIUM
 Divaricatori costali in ALLUMINIO

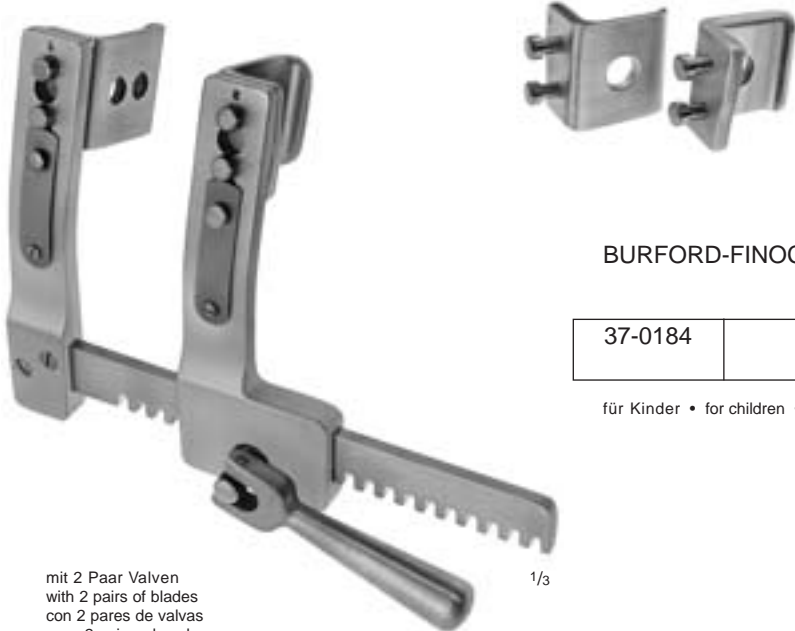
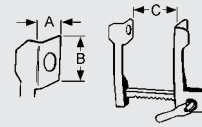

BURFORD-FINOCHIETTO

	A	B	C
37-0184	34 mm 48 mm	42 mm 42 mm	145 mm

für Kinder • for children • para niños • pour enfants • per bambini

mit 2 Paar Valven
 with 2 pairs of blades
 con 2 pares de valvas
 avec 2 paires de valves
 con 2 paia di valve

1/3

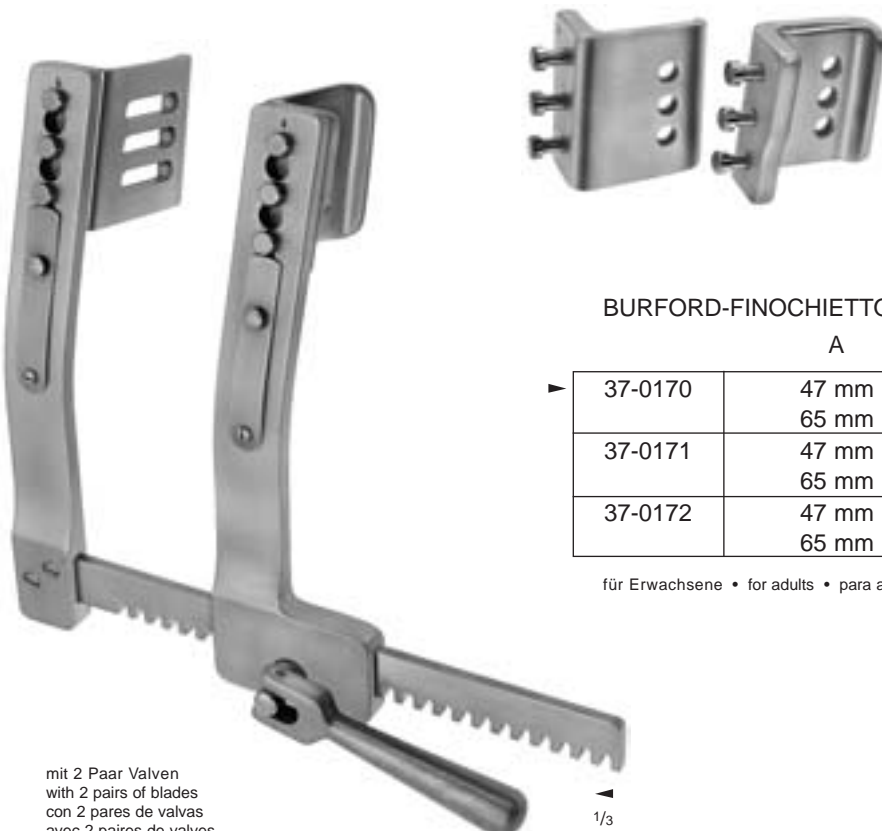

BURFORD-FINOCHIETTO

	A	B	C
▶ 37-0170	47 mm 65 mm	62 mm 62 mm	185 mm
37-0171	47 mm 65 mm	62 mm 62 mm	260 mm
37-0172	47 mm 65 mm	62 mm 62 mm	300 mm

für Erwachsene • for adults • para adultos • pour adultes • per adulti

mit 2 Paar Valven
 with 2 pairs of blades
 con 2 pares de valvas
 avec 2 paires de valves
 con 2 paia di valve

▶
1/3

Rippensperrer
 Rib Spreaders
 Separadores costales
 Ecarteurs à côtes
 Divaricatori costali

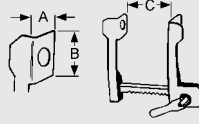

FINOCHIETTO-BABY

	A	B	C
37-0183	19 mm	20 mm	85 mm

für Säuglinge • for babies • para bebés • pour bébés • per neonati

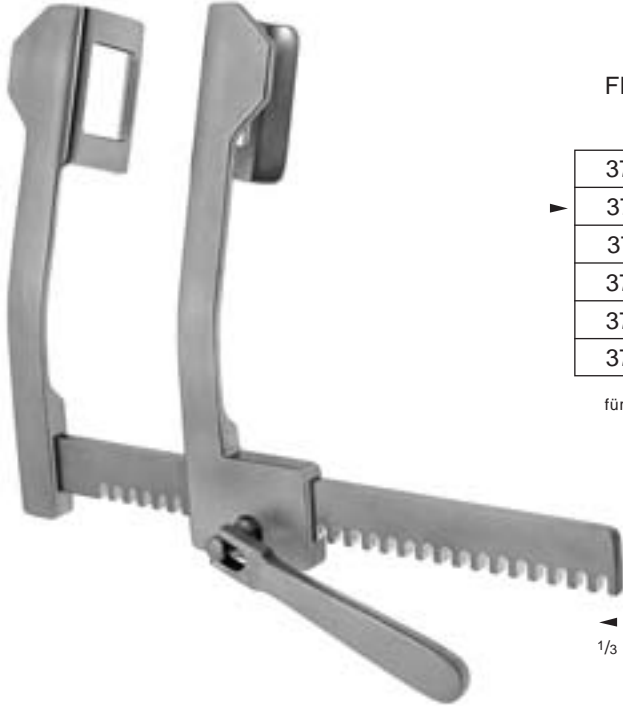

FINOCHIETTO

	A	B	C
37-0100	39 mm	45 mm	140 mm
37-0110	50 mm	66 mm	200 mm
37-0111	50 mm	66 mm	250 mm
37-0120	68 mm	66 mm	200 mm
37-0121	68 mm	66 mm	250 mm
37-0122	68 mm	66 mm	300 mm

für Erwachsene • for adults • para adultos • pour adultes • per adulti

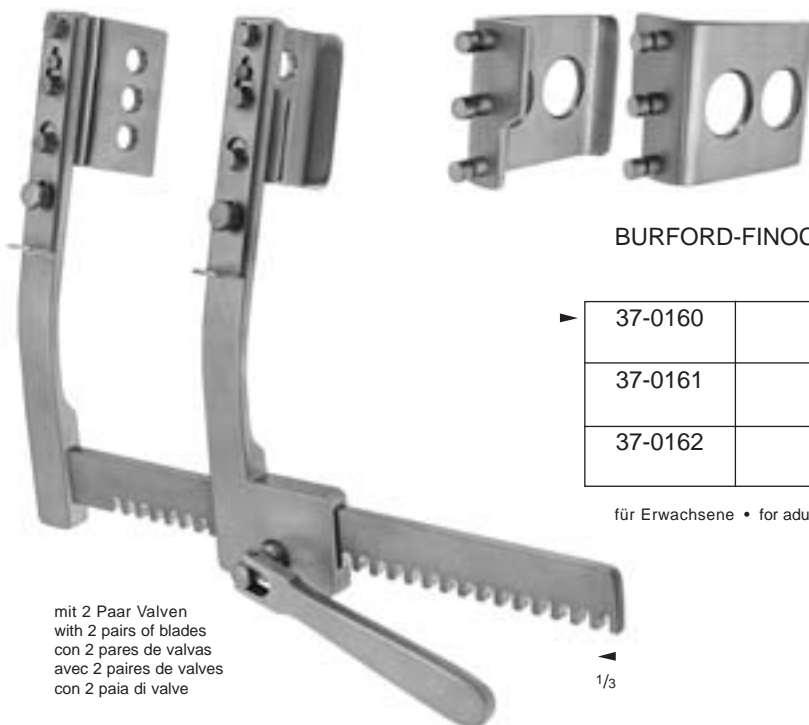

BURFORD-FINOCHIETTO

	A	B	C
37-0160	48 mm 77 mm	64 mm 64 mm	210 mm
37-0161	48 mm 77 mm	64 mm 64 mm	260 mm
37-0162	48 mm 77 mm	64 mm 64 mm	300 mm

für Erwachsene • for adults • para adultos • pour adultes • per adulti

mit 2 Paar Valven
 with 2 pairs of blades
 con 2 pares de valvas
 avec 2 paires de valves
 con 2 paia di valve



Rippensperrer
Rib Spreader
Separador costal
Ecarteur à côtes
Divaricatore costali

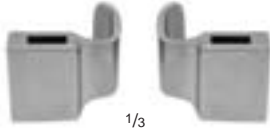
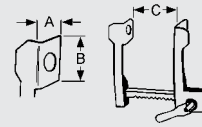

1/3

37-0204
30 x 30 mm (AxB)

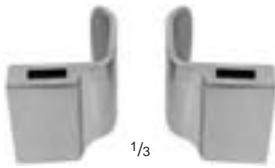

1/3

37-0206
40 x 40 mm (AxB)

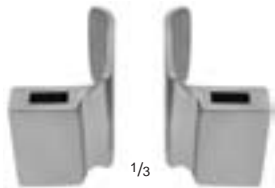

1/3

37-0208
50 x 50 mm (AxB)



1/3

DE BAKEY 37-0200

komplett, bestehend aus:

- 37-0202 1 Sperrer
- 37-0204 2 Seitenvalven 30 x 30 mm (AxB)
- 37-0206 2 Seitenvalven 40 x 40 mm (AxB)
- 37-0208 2 Seitenvalven 50 x 50 mm (AxB)

complete, consisting of:

- 37-0202 1 Spreader
- 37-0204 2 Lateral blades 30 x 30 mm (AxB)
- 37-0206 2 Lateral blades 40 x 40 mm (AxB)
- 37-0208 2 Lateral blades 50 x 50 mm (AxB)

completo, compuesto de:

- 37-0202 1 Separador
- 37-0204 2 Valvas laterales 30 x 30 mm (AxB)
- 37-0206 2 Valvas laterales 40 x 40 mm (AxB)
- 37-0208 2 Valvas laterales 50 x 50 mm (AxB)

complet, composé de:

- 37-0202 1 Ecarteur
- 37-0204 2 Valves latérales 30 x 30 mm (AxB)
- 37-0206 2 Valves latérales 40 x 40 mm (AxB)
- 37-0208 2 Valves latérales 50 x 50 mm (AxB)

completo, composto da:

- 37-0202 1 Divaricatore
- 37-0204 2 Valve laterali 30 x 30 mm (AxB)
- 37-0206 2 Valve laterali 40 x 40 mm (AxB)
- 37-0208 2 Valve laterali 50 x 50 mm (AxB)

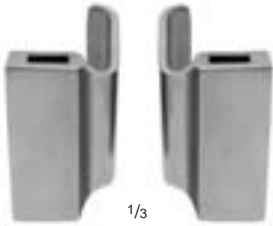
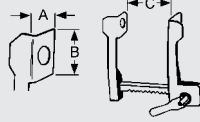

37-0214
 60 x 60 mm
 (AxB)

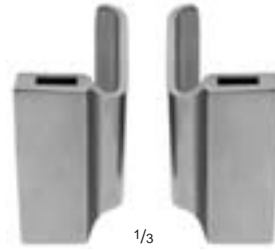

37-0217
 80 x 60 mm
 (AxB)



37-0215
 50 x 80 mm
 (AxB)

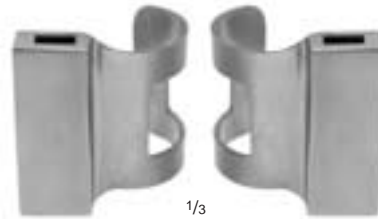

37-0218
 50 x 66 mm
 (AxB)



37-0216
 40 x 100 mm
 (AxB)



**DE BAKEY
 37-0210**

komplett, bestehend aus:

- 37-0212 1 Sperrer
- 37-0214 2 Seitenvalven 60 x 60 mm (AxB)
- 37-0215 2 Seitenvalven 50 x 80 mm (AxB)
- 37-0216 2 Seitenvalven 40 x 100 mm (AxB)

complete, consisting of:

- 37-0212 1 Spreader
- 37-0214 2 Lateral blades 60 x 60 mm (AxB)
- 37-0215 2 Lateral blades 50 x 80 mm (AxB)
- 37-0216 2 Lateral blades 40 x 100 mm (AxB)

completo, compuesto de:

- 37-0212 1 Separador
- 37-0214 2 Valvas laterales 60 x 60 mm (AxB)
- 37-0215 2 Valvas laterales 50 x 80 mm (AxB)
- 37-0216 2 Valvas laterales 40 x 100 mm (AxB)

complet, composé de:

- 37-0212 1 Ecarteur
- 37-0214 2 Valves latérales 60 x 60 mm (AxB)
- 37-0215 2 Valves latérales 50 x 80 mm (AxB)
- 37-0216 2 Valves latérales 40 x 100 mm (AxB)

completo, composto da:

- 37-0212 1 Divaricatore
- 37-0214 2 Valve laterali 60 x 60 mm (AxB)
- 37-0215 2 Valve laterali 50 x 80 mm (AxB)
- 37-0216 2 Valve laterali 40 x 100 mm (AxB)



Rippensperrer
 Rib Spreaders
 Separadores costales
 Ecarteurs à côtes
 Divaricatori costali

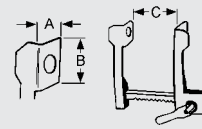

RIENHOFF-FINOCHIETTO

	A	B	C
37-0130	30 mm	32 mm	155 mm

1/3



HAIGHT

	A	B	C
37-0222	30 mm	30 mm	90 mm

1/3



TUFFIER

	A	B	C
37-0221	51 mm	43 mm	170 mm

1/3

Rippensperrer
Rib Spreader
Separador costal
Ecarteur à côtes
Divaricatori costali

Thoraxsperrer
Thoracic Retractor
Separador torácico
Ecarteur thoracique
Divaricatori per il torace

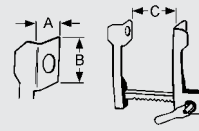

CHEVALIER

	A	B	C
37-0137	27 mm	100 mm	190 mm

Rippensperrer
Rib spreader
Separador costal
Ecarteur à côtes
Divaricatore costale

1/3

← 240 mm (C) →



37-0236
75 x 75 mm (AxB)

1/3



37-0234
48 x 65 mm (AxB)

MERCEDES

37-0230

Thoraxsperrer, komplett, bestehend aus:

- 37-0232 1 Sperrer
- 37-0234 2 Seitenvlaven 48 x 65 mm (AxB)
- 37-0236 2 Seitenvlaven 75 x 75 mm (AxB)

Thoracic retractor, complete, consisting of:

- 37-0232 1 Spreader
- 37-0234 2 Lateral blades 48 x 65 mm (AxB)
- 37-0236 2 Lateral blades 75 x 75 mm (AxB)

Separador torácico, completo, compuesto de:

- 37-0232 1 Separador
- 37-0234 2 Valvas laterales 48 x 65 mm (AxB)
- 37-0236 2 Valvas laterales 75 x 75 mm (AxB)

Ecarteur thoracique, complet, composé de:

- 37-0232 1 Ecarteur
- 37-0234 2 Valves latérales 48 x 65 mm (AxB)
- 37-0236 2 Valves latérales 75 x 75 mm (AxB)

Divaricatore per il torace, completo, composto da:

- 37-0232 1 Divaricatore
- 37-0234 2 Valve laterali 48 x 65 mm (AxB)
- 37-0236 2 Valve laterali 75 x 75 mm (AxB)



Rippenkontraktoren
Rib Contractors
Aproximadores para costillas
Rapprocheurs de côtes
Approssimatori costali

Rippensperrer
Rib Spreader
Separador costal
Ecarteur des côtes
Divaricatore costali



BAILEY-BABY
37-0248
15,5 cm, 6"

Rippenkontraktor
Rib contractor
Aproximador para costillas
Rapprocheur de côtes
Approssimatore costale



BAILEY
37-0250
20 cm, 8"

Rippenkontraktor, für Kinder
Rib contractor, for children
Aproximador para costillas, para niños
Rapprocheur de côtes, pour enfants
Approssimatore costale, per bambini



BAILEY-GIBBON
37-0255
20 cm, 8"

Rippenkontraktor, für Erwachsene
Rib contractor, for adults
Aproximador para costillas, para adultos
Rapprocheur de côtes, pour adultes
Approssimatore costale, per adulti



SELLORS
37-0258
20 cm, 8"

Rippensperrer und -kontraktor mit
drehbaren Klauen
Rib spreader and contractor
with swivel blades
Separador y contractor costal
con garras girables
Ecarteur et rapprocheur des côtes avec
valves orientables
Divaricatore ed approssimatore costale
con valve orientabili

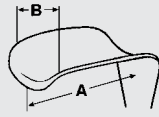

45 x 48 mm (AxB)

1/2

COOLEY
 30-0130
 25 cm, 10"

rechts
 right
 derecho
 droite
 destro



45 x 48 mm (AxB)

1/2

COOLEY
 30-0131
 25 cm, 10"

rechts, gerieft
 right, serrated
 derecho, estriado
 droite, cannelé
 destro, seghettato



24 x 48 mm (AxB)

1/2

COOLEY
 30-0132
 27,5 cm, 10³/₄"

links
 left
 izquierdo
 gauche
 sinistro



Gefäßdilatoren
Vascular Dilators
Dilatadores vasculares
Dilatateurs vasculaires
Dilatatori vascolari

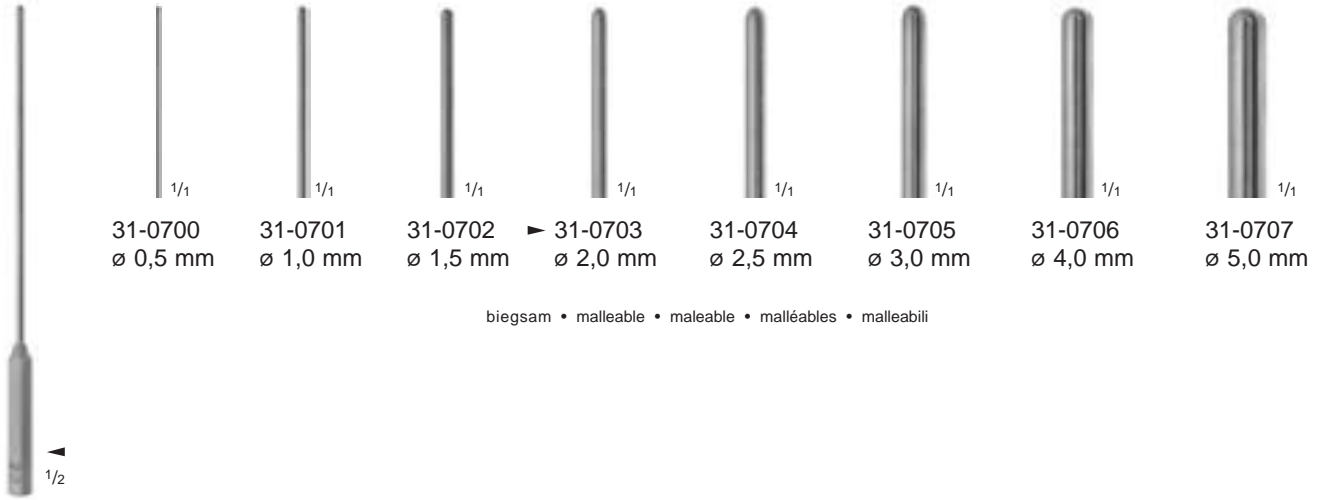

biegsam • malleable • maleable • malléables • malleabili

COOLEY
31-0700
- 31-0707
13 cm, 5 1/8"

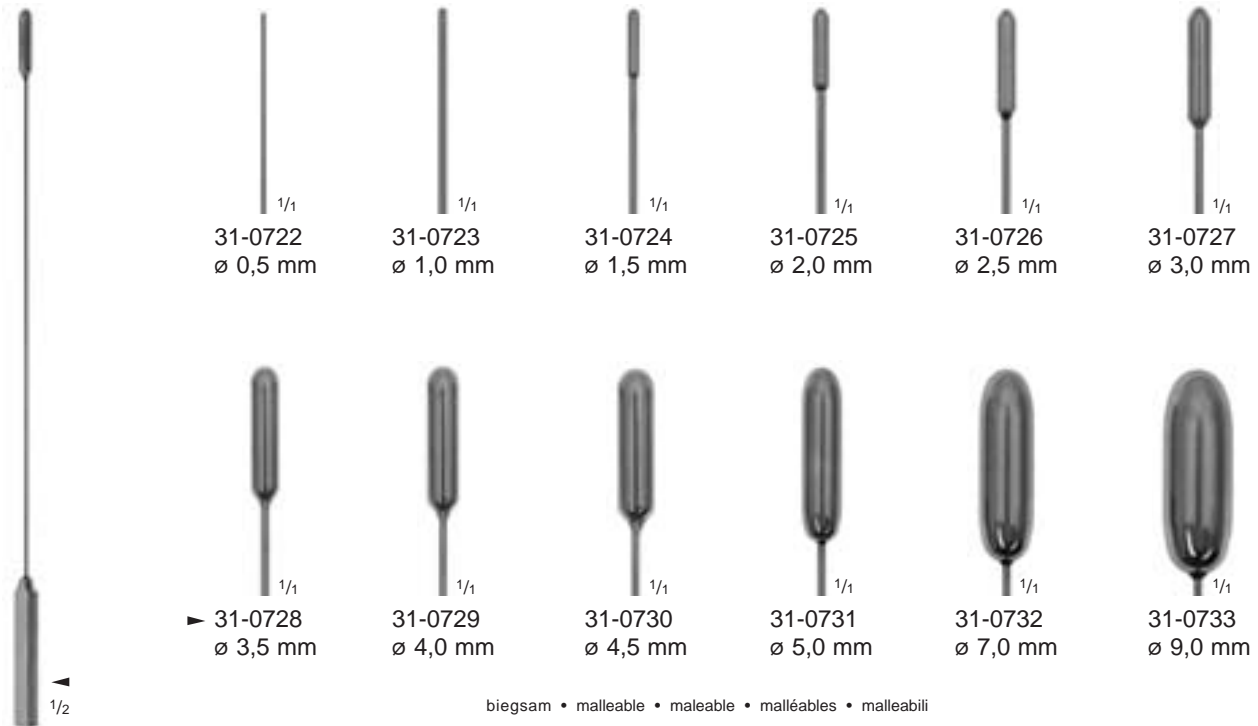

biegsam • malleable • maleable • malléables • malleabili

DE BAKEY
(GARRETT)
31-0722
- 31-0733
19 cm, 7 1/2"



Spreizweite 5 - 20 mm
blade opening from 5 - 20 mm
abertura de 5 a 20 mm
ouverture 5 - 20 mm
apertura mm 5 - 20 mm

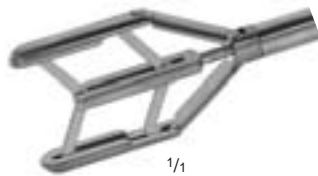

COOLEY
31-0758

für Mitralklappenstenosen (Kinder)
for mitral valve (pediatric)
para estenosis mitral (niños)
pour sténoses mitrales (enfants)
per stenosi mitrali (pediatrico)

Spreizweite 8 - 42 mm
blade opening from 8 - 42 mm
abertura de 8 a 42 mm
ouverture 8 - 42 mm
apertura mm 8 - 42 mm

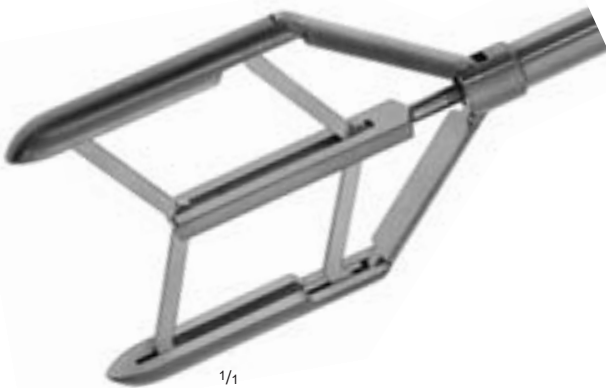

TUBBS
31-0760

für Mitralklappenstenosen
for mitral valve
para estenosis mitral
pour sténoses mitrales
per stenosi mitrali



Intima-Spatel und -Dilatoren
 Intima Spatulas and Dilators
 Espátulas y dilatadores para la íntima
 Spatules et dilateurs
 Spatole e dilatatori per strutture piú interne



1/1
2 mm

ø 1,0 mm



ROBB
31-0600
20,5 cm, 8"

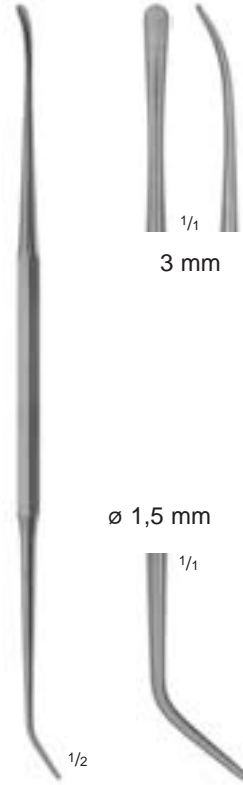

1/1
3 mm

ø 1,5 mm



ROBB
31-0601
20,5 cm, 8"



1/1
4 mm

ø 2,0 mm



ROBB
31-0602
20,5 cm, 8"



1/1
5 mm

ø 2,5 mm



ROBB
31-0603
20,5 cm, 8"

Intima-Spatel und -Dilatoren • Intima spatulas and dilators • Espátulas y dilatadores para la íntima • Spatules et dilateurs pour la tunique interne • Spatole e dilatatori per intima



1/1
3 mm
31-0615
17 cm, 6 3/4"



1/1
3 mm
▶ 31-0616
17 cm, 6 3/4"

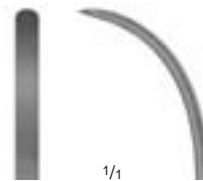

1/1
3 mm
31-0617
17 cm, 6 3/4"

LEMMON
31-0615
- 31-0617

Intima-Spatel
Intima spatulas
Espátulas para la íntima
Spatules pour la tunique interne
Spatole per intima

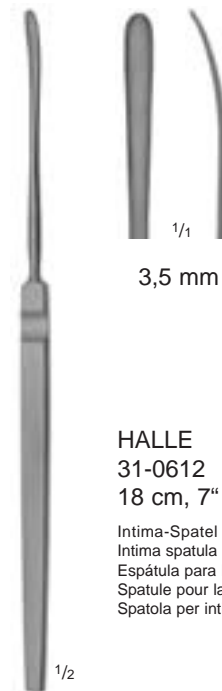

HALLE
31-0612
18 cm, 7"

Intima-Spatel
Intima spatula
Espátula para la íntima
Spatule pour la tunique interne
Spatola per intima

Intima-Spatel

Intima Spatulas

Espátulas para la íntima

Spatules pour la tunique interne

Spatole per intima

Intima-Messer

Intima Knife

Cuchillo para la íntima

Couteau pour la tunique interne

Bisturi per intima

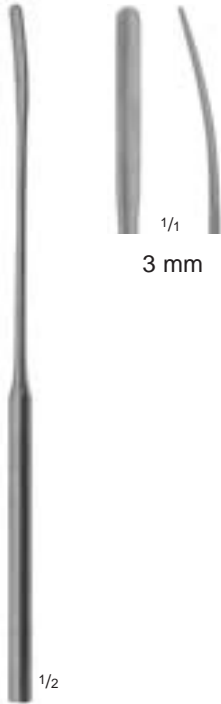

31-0608
18,5 cm, 7 1/4"



31-0609
21,5 cm, 8 1/2"

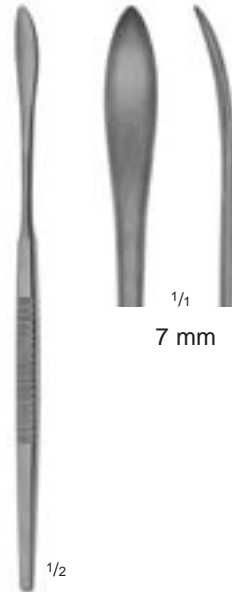

SCHMID
31-0605
15,5 cm, 6"

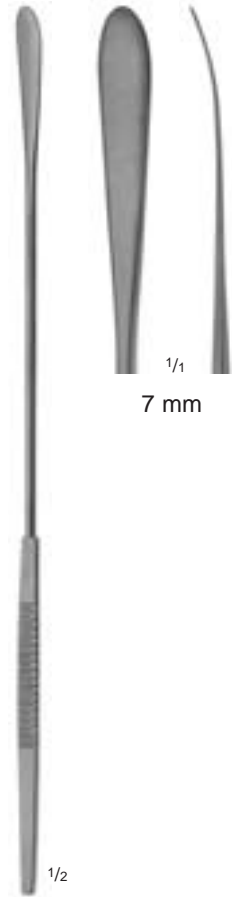

SCHMID
31-0607
23,5 cm, 9 1/4"

Intima-Spatel • Intima spatulas • Espátulas para la íntima • Spatules pour la tunique interne • Spatole per intima



CANNON
31-0632
15 cm, 6"

Intima-Messer
Intima knife
Cuchillo para la íntima
Couteau pour la tunique interne
Bisturi per intima



CANNON
31-0634
18 cm, 7"

Intima-Spatel
Intima spatula
Espátula para la íntima
Spatule pour la tunique interne
Spatola per intima



Endarterektomiestripper

Endarterectomy Stripper
Sondas para endarterectomía
Sondes à endartérectomie
Tiravene per endarterectomia



1/1

CANNON

- ▶ **31-0660** ø 7,0 x 7,8 mm
 - 31-0661** ø 8,0 x 9,0 mm
 - 31-0662** ø 9,0 x 10,0 mm
- 24 cm, 9 1/2"

oval, biegsam
oval, malleable
ovales, maleables
ovales, malléables
ovali, malleabili



1/1

CANNON

- ▶ **31-0665** ø 2,8 x 3,1 mm
 - 31-0666** ø 3,9 x 4,3 mm
 - 31-0667** ø 5,0 x 5,7 mm
 - 31-0668** ø 6,0 x 6,7 mm
 - ▶ **31-0669** ø 7,0 x 8,0 mm
 - 31-0670** ø 7,8 x 9,0 mm
 - 31-0671** ø 8,7 x 10,2 mm
 - 31-0672** ø 9,4 x 10,8 mm
 - 31-0673** ø 15,5 x 17,3 mm
 - 31-0674** ø 18,0 x 20,5 mm
 - 31-0675** ø 20,2 x 23,2 mm
- 33 cm, 13"

oval, flexibel
oval, flexible
ovales, flexibles
ovales, flexibles
ovali, flessibili



1/1

- 31-0618** ø 2,0 mm
 - 31-0619** ø 3,0 mm
 - 31-0620** ø 4,0 mm
 - 31-0622** ø 6,0 mm
 - ▶ **31-0623** ø 7,0 mm
 - 31-0624** ø 8,5 mm
 - 31-0626** ø 10,0 mm
 - 31-0628** ø 12,0 mm
 - 31-0630** ø 14,0 mm
- 50 cm, 19 3/4"

rund, flexibel
round, flexible
redondos, flexibles
rondes, flexibles
rotonde, flessibili



1/2

31-0635

8,5 cm, 3 3/8"

Handgriff für 31-0618 - 31-0675
Handle for 31-0618 - 31-0675
Mango para 31-0618 - 31-0675
Manche pour 31-0618 - 31-0675
Manico per 31-0618 - 31-0675

Endarterektomie-Satz

Endarterectomy Set

Juego para endarterectomía

Jeu pour endartérectomie

Set per endarterectomia

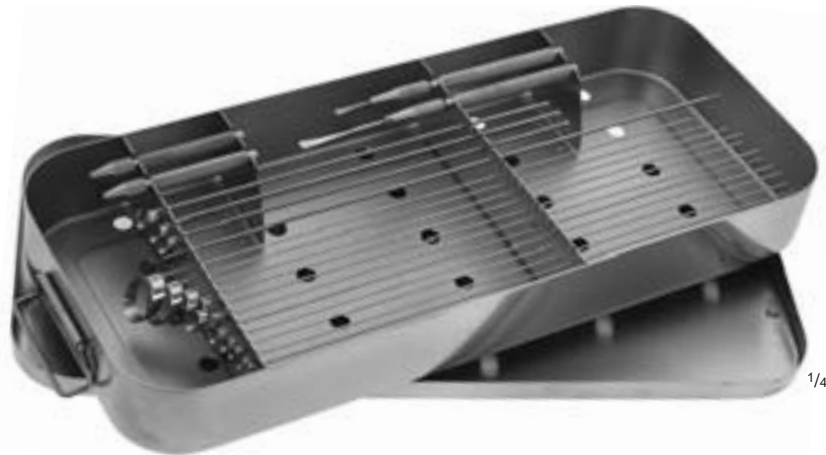

1/4

CANNON

31-0690

Endarterektomie-Satz, bestehend aus:

31-0660	1	Endarterektomiestripper, oval, biegsam,	ø 7,0 x 7,8 mm, 24 cm, 9 1/2"
31-0661	1	Endarterektomiestripper, oval, biegsam,	ø 8,0 x 9,0 mm, 24 cm, 9 1/2"
31-0662	1	Endarterektomiestripper, oval, biegsam,	ø 9,0 x 10,0 mm, 24 cm, 9 1/2"
31-0665	1	Endarterektomiestripper, oval, flexibel,	ø 2,8 x 3,1 mm, 33 cm, 13 "
31-0666	1	Endarterektomiestripper, oval, flexibel,	ø 3,9 x 4,3 mm, 33 cm, 13 "
31-0667	1	Endarterektomiestripper, oval, flexibel,	ø 5,0 x 5,7 mm, 33 cm, 13 "
31-0668	1	Endarterektomiestripper, oval, flexibel,	ø 6,0 x 6,7 mm, 33 cm, 13 "
31-0669	1	Endarterektomiestripper, oval, flexibel,	ø 7,0 x 8,0 mm, 33 cm, 13 "
31-0670	1	Endarterektomiestripper, oval, flexibel,	ø 7,8 x 9,0 mm, 33 cm, 13 "
31-0671	1	Endarterektomiestripper, oval, flexibel,	ø 8,7 x 10,2 mm, 33 cm, 13 "
31-0672	1	Endarterektomiestripper, oval, flexibel,	ø 9,4 x 10,8 mm, 33 cm, 13 "
31-0673	1	Endarterektomiestripper, oval, flexibel,	ø 15,5 x 17,3 mm, 33 cm, 13 "
31-0674	1	Endarterektomiestripper, oval, flexibel,	ø 18,0 x 20,5 mm, 33 cm, 13 "
31-0675	1	Endarterektomiestripper, oval, flexibel,	ø 20,2 x 23,2 mm, 33 cm, 13 "
31-0677	1	Einführungsinstrument, flexibel, 32 cm, 12 1/2"	
31-0632	1	Intima-Messer, 4,7 mm, 15 cm, 6"	
31-0634	1	Intima-Spatel, 5,6 mm, 18 cm, 7"	
31-0635	2	Handgriffe für Endarterektomiestripper, 8,5 mm, 3 3/8"	
07-0782	1	Sterilisier-Etui 430 x 180 x 55 mm	

Juego para endarterectomía, compuesto de:

31-0660	1	Sonda para endarterectomía, oval, maleable,	ø 7,0 x 7,8 mm, 24 cm, 9 1/2"
31-0661	1	Sonda para endarterectomía, oval, maleable,	ø 8,0 x 9,0 mm, 24 cm, 9 1/2"
31-0662	1	Sonda para endarterectomía, oval, maleable,	ø 9,0 x 10,0 mm, 24 cm, 9 1/2"
31-0665	1	Sonda para endarterectomía, oval, flexible,	ø 2,8 x 3,1 mm, 33 cm, 13 "
31-0666	1	Sonda para endarterectomía, oval, flexible,	ø 3,9 x 4,3 mm, 33 cm, 13 "
31-0667	1	Sonda para endarterectomía, oval, flexible,	ø 5,0 x 5,7 mm, 33 cm, 13 "
31-0668	1	Sonda para endarterectomía, oval, flexible,	ø 6,0 x 6,7 mm, 33 cm, 13 "
31-0669	1	Sonda para endarterectomía, oval, flexible,	ø 7,0 x 8,0 mm, 33 cm, 13 "
31-0670	1	Sonda para endarterectomía, oval, flexible,	ø 7,8 x 9,0 mm, 33 cm, 13 "
31-0671	1	Sonda para endarterectomía, oval, flexible,	ø 8,7 x 10,2 mm, 33 cm, 13 "
31-0672	1	Sonda para endarterectomía, oval, flexible,	ø 9,4 x 10,8 mm, 33 cm, 13 "
31-0673	1	Sonda para endarterectomía, oval, flexible,	ø 15,5 x 17,3 mm, 33 cm, 13 "
31-0674	1	Sonda para endarterectomía, oval, flexible,	ø 18,0 x 20,5 mm, 33 cm, 13 "
31-0675	1	Sonda para endarterectomía, oval, flexible,	ø 20,2 x 23,2 mm, 33 cm, 13 "
31-0677	1	Instrumento conductor, flexible, 32 cm, 12 1/2"	
31-0632	1	Cuchillo para la íntima, 4,7 mm, 15 cm, 6"	
31-0634	1	Espátula para la íntima, 5,6 mm, 18 cm, 7"	
31-0635	2	Mangos para las sondas para endarterectomía, 8,5 mm, 3 3/8"	
07-0782	1	Estuche para esterilizar, 430 x 180 x 55 mm	

Set per endarterectomia, composto da:

31-0660	1	Tiravene per endarterectomia, ovali, malleabile,	ø 7,0 x 7,8 mm, 24 cm, 9 1/2"
31-0661	1	Tiravene per endarterectomia, ovali, malleabile,	ø 8,0 x 9,0 mm, 24 cm, 9 1/2"
31-0662	1	Tiravene per endarterectomia, ovali, malleabile,	ø 9,0 x 10,0 mm, 24 cm, 9 1/2"
31-0665	1	Tiravene per endarterectomia, ovali, flessibile,	ø 2,8 x 3,1 mm, 33 cm, 13 "
31-0666	1	Tiravene per endarterectomia, ovali, flessibile,	ø 3,9 x 4,3 mm, 33 cm, 13 "
31-0667	1	Tiravene per endarterectomia, ovali, flessibile,	ø 5,0 x 5,7 mm, 33 cm, 13 "
31-0668	1	Tiravene per endarterectomia, ovali, flessibile,	ø 6,0 x 6,7 mm, 33 cm, 13 "
31-0669	1	Tiravene per endarterectomia, ovali, flessibile,	ø 7,0 x 8,0 mm, 33 cm, 13 "
31-0670	1	Tiravene per endarterectomia, ovali, flessibile,	ø 7,8 x 9,0 mm, 33 cm, 13 "
31-0671	1	Tiravene per endarterectomia, ovali, flessibile,	ø 8,7 x 10,2 mm, 33 cm, 13 "
31-0672	1	Tiravene per endarterectomia, ovali, flessibile,	ø 9,4 x 10,8 mm, 33 cm, 13 "
31-0673	1	Tiravene per endarterectomia, ovali, flessibile,	ø 15,5 x 17,3 mm, 33 cm, 13 "
31-0674	1	Tiravene per endarterectomia, ovali, flessibile,	ø 18,0 x 20,5 mm, 33 cm, 13 "
31-0675	1	Tiravene per endarterectomia, ovali, flessibile,	ø 20,2 x 23,2 mm, 33 cm, 13 "
31-0677	1	Strumento introduttore, flessibile, 32 cm, 12 1/2"	
31-0632	1	Bisturi per intima, 4,7 mm, 15 cm, 6"	
31-0634	1	Dissettore per intima, 5,6 mm, 18 cm, 7"	
31-0635	2	Manico per tiravene, 8,5 mm, 3 3/8"	
07-0782	1	Cestello per sterilizzazione 430 x 180 x 55 mm	

Endarterectomy set, consisting of:

31-0660	1	Endarterectomy stripper, oval, malleable,	ø 7,0 x 7,8 mm, 24 cm, 9 1/2"
31-0661	1	Endarterectomy stripper, oval, malleable,	ø 8,0 x 9,0 mm, 24 cm, 9 1/2"
31-0662	1	Endarterectomy stripper, oval, malleable,	ø 9,0 x 10,0 mm, 24 cm, 9 1/2"
31-0665	1	Endarterectomy stripper, oval, flexible,	ø 2,8 x 3,1 mm, 33 cm, 13 "
31-0666	1	Endarterectomy stripper, oval, flexible,	ø 3,9 x 4,3 mm, 33 cm, 13 "
31-0667	1	Endarterectomy stripper, oval, flexible,	ø 5,0 x 5,7 mm, 33 cm, 13 "
31-0668	1	Endarterectomy stripper, oval, flexible,	ø 6,0 x 6,7 mm, 33 cm, 13 "
31-0669	1	Endarterectomy stripper, oval, flexible,	ø 7,0 x 8,0 mm, 33 cm, 13 "
31-0670	1	Endarterectomy stripper, oval, flexible,	ø 7,8 x 9,0 mm, 33 cm, 13 "
31-0671	1	Endarterectomy stripper, oval, flexible,	ø 8,7 x 10,2 mm, 33 cm, 13 "
31-0672	1	Endarterectomy stripper, oval, flexible,	ø 9,4 x 10,8 mm, 33 cm, 13 "
31-0673	1	Endarterectomy stripper, oval, flexible,	ø 15,5 x 17,3 mm, 33 cm, 13 "
31-0674	1	Endarterectomy stripper, oval, flexible,	ø 18,0 x 20,5 mm, 33 cm, 13 "
31-0675	1	Endarterectomy stripper, oval, flexible,	ø 20,2 x 23,2 mm, 33 cm, 13 "
31-0677	1	Introducing instrument, flexible, 32 cm, 12 1/2"	
31-0632	1	Intima knife, 4,7 mm, 15 cm, 6"	
31-0634	1	Intima dissector, 5,6 mm, 18 cm, 7"	
31-0635	2	Handles for endarterectomy strippers, 8,5 mm, 3 3/8"	
07-0782	1	Sterilizing case 430 x 180 x 55 mm	

Jeu pour endartérectomie, composé de:

31-0660	1	Stripper pour endartérectomie, ovales, malléable,	ø 7,0 x 7,8 mm, 24 cm, 9 1/2"
31-0661	1	Stripper pour endartérectomie, ovales, malléable,	ø 8,0 x 9,0 mm, 24 cm, 9 1/2"
31-0662	1	Stripper pour endartérectomie, ovales, malléable,	ø 9,0 x 10,0 mm, 24 cm, 9 1/2"
31-0665	1	Stripper pour endartérectomie, ovales, flexibles,	ø 2,8 x 3,1 mm, 33 cm, 13 "
31-0666	1	Stripper pour endartérectomie, ovales, flexibles,	ø 3,9 x 4,3 mm, 33 cm, 13 "
31-0667	1	Stripper pour endartérectomie, ovales, flexibles,	ø 5,0 x 5,7 mm, 33 cm, 13 "
31-0668	1	Stripper pour endartérectomie, ovales, flexibles,	ø 6,0 x 6,7 mm, 33 cm, 13 "
31-0669	1	Stripper pour endartérectomie, ovales, flexibles,	ø 7,0 x 8,0 mm, 33 cm, 13 "
31-0670	1	Stripper pour endartérectomie, ovales, flexibles,	ø 7,8 x 9,0 mm, 33 cm, 13 "
31-0671	1	Stripper pour endartérectomie, ovales, flexibles,	ø 8,7 x 10,2 mm, 33 cm, 13 "
31-0672	1	Stripper pour endartérectomie, ovales, flexibles,	ø 9,4 x 10,8 mm, 33 cm, 13 "
31-0673	1	Stripper pour endartérectomie, ovales, flexibles,	ø 15,5 x 17,3 mm, 33 cm, 13 "
31-0674	1	Stripper pour endartérectomie, ovales, flexibles,	ø 18,0 x 20,5 mm, 33 cm, 13 "
31-0675	1	Stripper pour endartérectomie, ovales, flexibles,	ø 20,2 x 23,2 mm, 33 cm, 13 "
31-0677	1	Instrument d'introduction, flexible, 32 cm, 12 1/2"	
31-0632	1	Couteau, 4,7 mm, 15 cm, 6"	
31-0634	1	Spatule dissecteur, 5,6 mm, 18 cm, 7"	
31-0635	2	Manches pour stripper, 8,5 mm, 3 3/8"	
07-0782	1	Boîte stérilisable 430 x 180 x 55 mm	



Tunnelier-Satz

Tunneling Set

Juego para tunelar

Jeu pour tunneliser

Set per scanalare



1/4

31-0870

Tunnelier-Satz, bestehend aus:

- 31-0871 2 Universal Tunnelier-Griffe
- 31-0872 1 Tunnelier-Schaft, gebogen, 225 mm
- 31-0873 1 Tunnelier-Schaft, gerade, 225 mm
- 31-0874 1 Tunnelier-Schaft, gebogen, 540 mm
- 31-0875 2 Oliven-Aufsätze, ø 5 mm
- 31-0876 2 Oliven-Aufsätze, ø 6 mm
- 31-0877 2 Oliven-Aufsätze, ø 7 mm
- 31-0878 2 Oliven-Aufsätze, ø 8 mm
- 31-0879 2 Oliven-Aufsätze, ø 10 mm
- 31-0880 2 Oliven-Aufsätze, ø 12 mm
- 31-0881 1 Venen-Aufsatz
- 31-0882 1 LUER-Adapter
- 31-0883 1 Schlüssel
- 07-0825 1 Halteplatte für Aufsätze
- 07-0826 1 Sterilisierbehälter 550 x 115 x 35 mm

Tunneling set, consisting of:

- 31-0871 2 Universal handles
- 31-0872 1 Tunneling shaft, curved, 225 mm
- 31-0873 1 Tunneling shaft, straight, 225 mm
- 31-0874 1 Tunneling shaft, curved, 540 mm
- 31-0875 2 Bullet tips, ø 5 mm
- 31-0876 2 Bullet tips, ø 6 mm
- 31-0877 2 Bullet tips, ø 7 mm
- 31-0878 2 Bullet tips, ø 8 mm
- 31-0879 2 Bullet tips, ø 10 mm
- 31-0880 2 Bullet tips, ø 12 mm
- 31-0881 1 Vein tip
- 31-0882 1 LUER-Adapter
- 31-0883 1 Key
- 07-0825 1 Plate for tips only
- 07-0826 1 Sterilizing case 550 x 115 x 35 mm

Juego para tunelar, compuesto de:

- 31-0871 2 Mangos universales para tunelar
- 31-0872 1 Vástago para tunelar, curvo, 225 mm
- 31-0873 1 Vástago para tunelar, recto, 225 mm
- 31-0874 1 Vástago para tunelar, curvo, 540 mm
- 31-0875 2 Olivas, ø 5 mm
- 31-0876 2 Olivas, ø 6 mm
- 31-0877 2 Olivas, ø 7 mm
- 31-0878 2 Olivas, ø 8 mm
- 31-0879 2 Olivas, ø 10 mm
- 31-0880 2 Olivas, ø 12 mm
- 31-0881 1 Punta para venas
- 31-0882 1 Punta con adaptador LUER
- 31-0883 1 Llave
- 07-0825 1 Soporte para puntas
- 07-0826 1 Estuche para esterilizar 550 x 115 x 35 mm

Jeu pour tunneliser, composé de:

- 31-0871 2 Manche universel pour tunneliser
- 31-0872 1 Tige pour tunneliser, courbe, 225 mm
- 31-0873 1 Tige pour tunneliser, droite, 225 mm
- 31-0874 1 Tige pour tunneliser, courbe, 540 mm
- 31-0875 2 Olives, ø 5 mm
- 31-0876 2 Olives, ø 6 mm
- 31-0877 2 Olives, ø 7 mm
- 31-0878 2 Olives, ø 8 mm
- 31-0879 2 Olives, ø 10 mm
- 31-0880 2 Olives, ø 12 mm
- 31-0881 1 Embout pour veines
- 31-0882 1 Adaptateur LUER
- 31-0883 1 Clef
- 07-0825 1 Support pour embouts
- 07-0826 1 Boîte pour stériliser 550 x 115 x 35 mm

Set per scanalare, composto da:

- 31-0871 2 Manici universali
- 31-0872 1 Asta, curva, 225 mm
- 31-0873 1 Asta, retta, 225 mm
- 31-0874 1 Asta, curva, 540 mm
- 31-0875 2 Olive, ø 5 mm
- 31-0876 2 Olive, ø 6 mm
- 31-0877 2 Olive, ø 7 mm
- 31-0878 2 Olive, ø 8 mm
- 31-0879 2 Olive, ø 10 mm
- 31-0880 2 Olive, ø 12 mm
- 31-0881 1 Testa adattatore per vene
- 31-0882 1 Adattatore LUER
- 31-0883 1 Chiave
- 07-0825 1 Supporto per olive
- 07-0826 1 Cestello per sterilizzazione 550 x 115 x 35 mm

Ersatzteile • Spare parts • Piezas de repuesto • Pièces de rechange • Pezzi di ricambio



1/3

31-0871



1/3

31-0883



1/1

31-0875
ø 5 mm



1/1

31-0876
ø 6 mm



1/1

31-0877
ø 7 mm



1/1

31-0878
ø 8 mm



1/1

31-0879
ø 10 mm



1/1

31-0880
ø 12 mm



1/1

31-0881



1/1

31-0882

Tunnelier-Instrumente für Bypass-Implantation

Tunneling Instruments for Bypass Grafting

Instrumentos para tunelar e injertar Bypass

Tunnelisateur pour bypass

Strumenti per scanalare per trapiantare, bypass

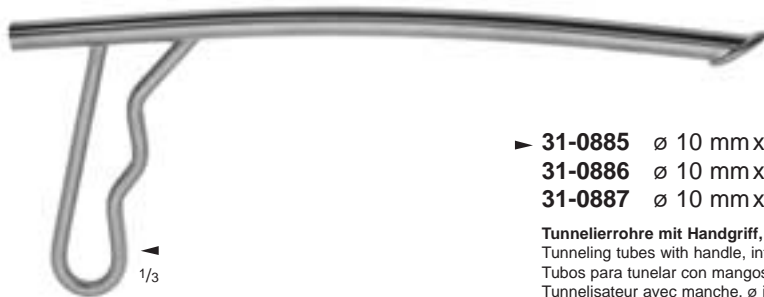

► **31-0885** ø 10 mm x 280 mm

31-0886 ø 10 mm x 380 mm

31-0887 ø 10 mm x 680 mm

Tunnelierrohre mit Handgriff, Innendurchmesser 10 mm

Tunneling tubes with handle, internal diameter 10 mm

Tubos para tunelar con mangos, ø interior 10 mm

Tunnelisateur avec manche, ø intérieur 10 mm

Tubo per scanalare con manico, ø int. 10 mm

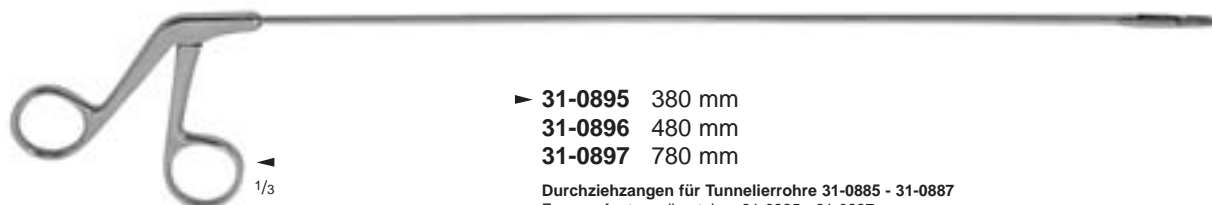

► **31-0895** 380 mm

31-0896 480 mm

31-0897 780 mm

Durchziehungen für Tunnelierrohre 31-0885 - 31-0887

Forceps for tunneling tubes 31-0885 - 31-0887

Pinzas pasadoras para los tubos para tunelar 31-0885 - 31-0887

Pinces pour tunnelisateur 31-0885 - 31-0887

Pinza per tubi per scanalare 31-0885 - 31-0887

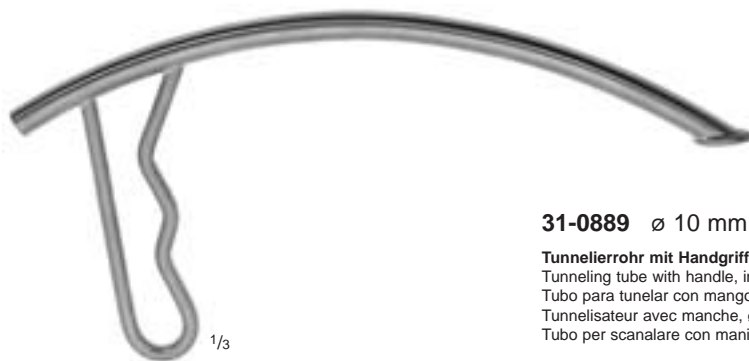

31-0889 ø 10 mm x 280 mm

Tunnelierrohr mit Handgriff, Innendurchmesser 10 mm

Tunneling tube with handle, internal diameter 10 mm

Tubo para tunelar con mango, ø interior 10 mm

Tunnelisateur avec manche, ø intérieur 10 mm

Tubo per scanalare con manico, ø int. 10 mm



31-0898 380 mm

Durchziehange für Tunnelierrohr 31-0889

Forceps for tunneling tube 31-0889

Pinza pasadora para tubo para tunelar 31-0889

Pinces pour tunnelisateur 31-0889

Pinza per tubo per scanalare 31-0889



Tourniquets

Tourniquets
Torniquetes
Tourniquets
Tourniquets
Tourniquets

Biopsiekanülen

Biopsy Needles
Agujas de biopsia
Aiguilles à biopsie
Aghi per biopsia

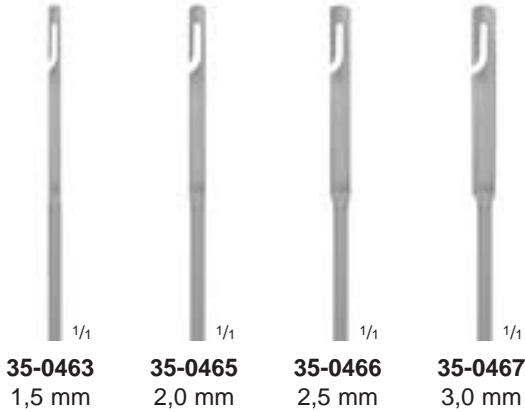

35-0463
1,5 mm

35-0465
2,0 mm

35-0466
2,5 mm

35-0467
3,0 mm

35-0463
- 35-0467

Fadenfänger allein
Suture hook, only
Porta-ligaduras, suelto
Tirette seule
Tira-filo, solo

RUMEL-BELMONT
▶ **35-0460** ø 3,2 mm
35-0462 ø 6,4 mm
33 cm, 13"

Tourniquets, flexibel
Tourniquets, flexible
Torniquetes, flexibles
Tourniquets, flexibles
Tourniquets, flessibile



KLIMA-ROSEGGER
18-0421 ø 1,2 x 35 mm
▶ **18-0420** ø 1,8 x 35 mm

Kanülen zur Sternalpunktion
Sternum puncture needles
Agujas para la punción del esternón
Aiguilles à la ponction sternale
Aghi per la puntura dello sterno



ABRAMS
39-0500
ø 4,0 x 90 mm

Kanüle zur Brustfellpunktion
Pleura puncture needle
Aguja para la punción de la pleura
Aiguille à ponction pleurale
Ago per la puntura della pleura

ATRAUMATIC-GRIP Instrumente mit atraumatischer Riefung

ATRAUMATIC-GRIP Instruments with non-traumatic serration

ATRAUMATIC-GRIP Instrumentos con bocas atraumáticas

ATRAUMATIC-GRIP Instruments avec mors atraumatiques

ATRAUMATIC-GRIP Strumenti con presa atraumatica

**LAWTON-Zahnung**

Toothing LAWTON

Dentado LAWTON

Denture LAWTON

Dentatura LAWTON

- **1 x 2 Zahnreihen**
- 1 x 2 rows of teeth
- 1 x 2 hileras de dientes
- 1 x 2 rangées de dents
- 1 x 2 File di denti

**DE BAKEY-Zahnung**

Toothing DE BAKEY

Dentado DE BAKEY

Denture DE BAKEY

Dentatura DE BAKEY

- **1 x 2 Zahnreihen**
- 1 x 2 rows of teeth
- 1 x 2 hileras de dientes
- 1 x 2 rangées de dents
- 1 x 2 File di denti

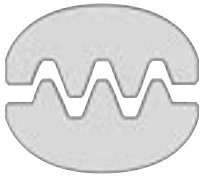
**DE BAKEY-Zahnung**

Toothing DE BAKEY

Dentado DE BAKEY

Denture DE BAKEY

Dentatura DE BAKEY

- **2 x 3 Zahnreihen**
- 2 x 3 rows of teeth
- 2 x 3 hileras de dientes
- 2 x 3 rangées de dents
- 2 x 3 File di denti

**DARDIK-Zahnung**

Toothing DARDIK

Dentado DARDIK

Denture DARDIK

Dentatura DARDIK

- **2 x 3 Zahnreihen**
- 2 x 3 rows of teeth
- 2 x 3 hileras de dientes
- 2 x 3 rangées de dents
- 2 x 3 File di denti

**COOLEY-Zahnung**

Toothing COOLEY

Dentado COOLEY

Denture COOLEY

Dentatura COOLEY

- **2 x 2 Zahnreihen**
- 2 x 2 rows of teeth
- 2 x 2 hileras de dientes
- 2 x 2 rangées de dents
- 2 x 2 File di denti



ATRAUMATIC-GRIP Gefäßklemmen
 ATRAUMATIC-GRIP Vascular Clamps
 ATRAUMATIC-GRIP Pinzas-clamps vasculares
 ATRAUMATIC-GRIP Pincas vasculaires
 ATRAUMATIC-GRIP Pinze vascolari

sehr feine Modelle für Kinderchirurgie • very delicate patterns for pediatric surgery • modelos muy delicados para la pediatría
 modèles très délicats pour chirurgie pédiatrique • modelli molto delicati per uso pediatrico

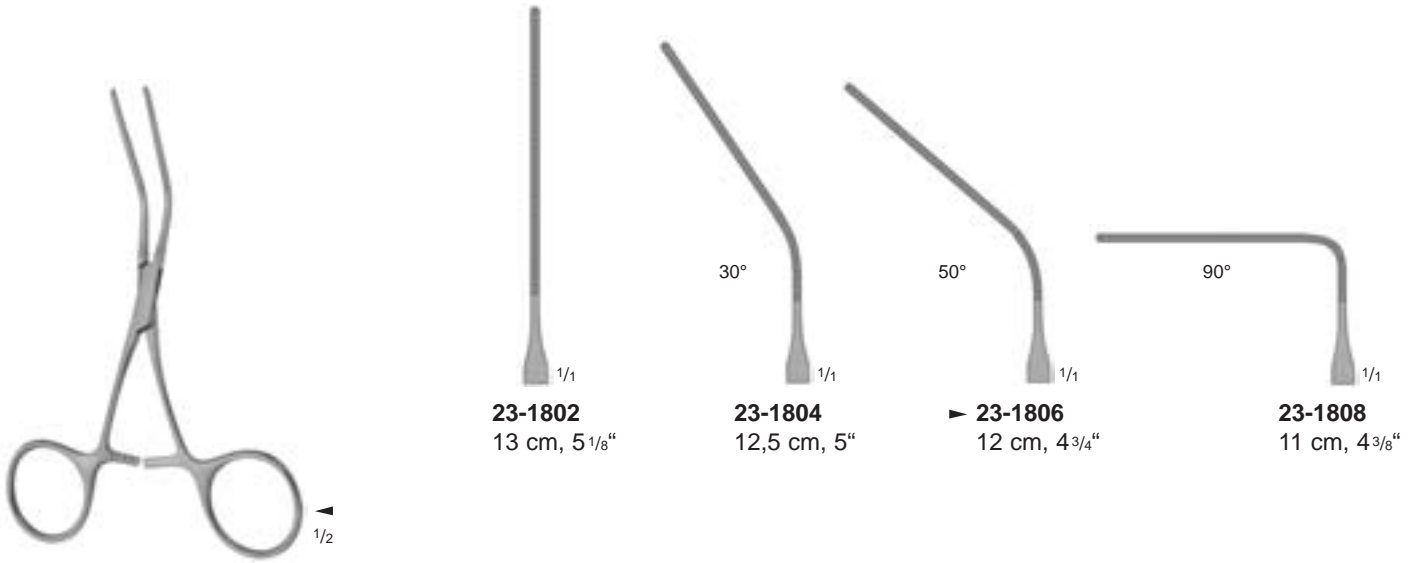

CASTANEDA

23-1802

- **23-1808**

Mehrweckklemmen

Multi-purpose clamps

Pinzas-clamps de varias aplicaciones

Pincas-clamps universelles

Pinze multiuso

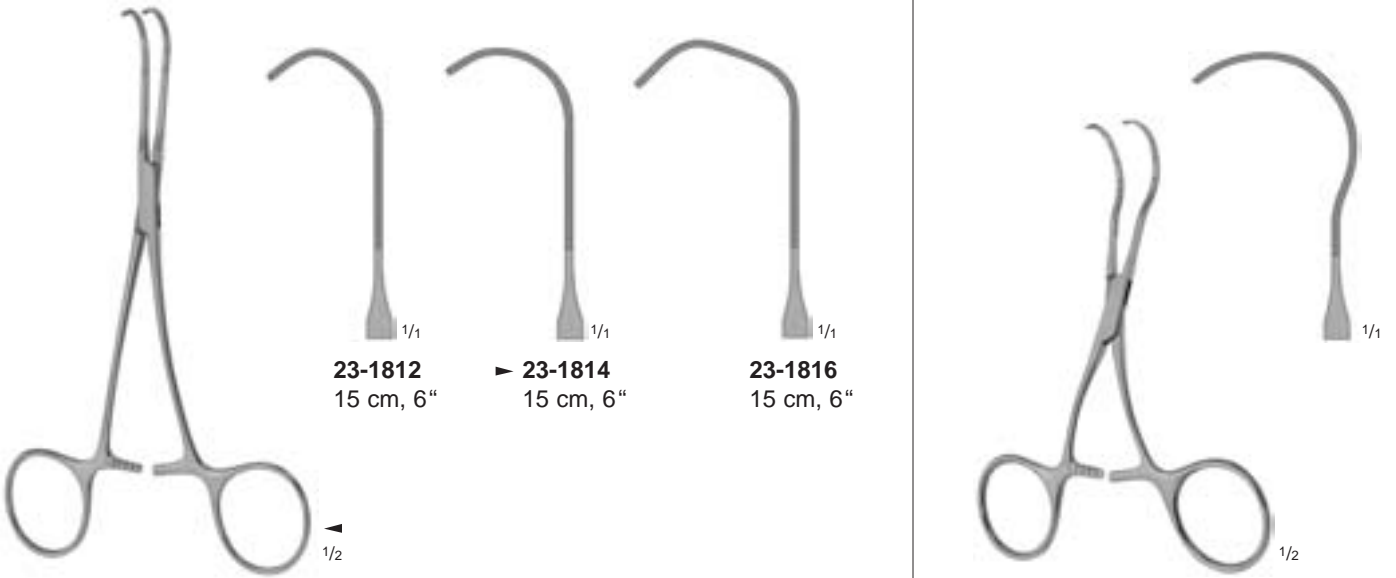

CASTANEDA

23-1812

- **23-1816**

Anastomosenklemmen

Anastomosis clamps

Pinzas-clamps para anastomosis

Pincas-clamps pour anastomose

Pinze per anastomosi

CASTANEDA

23-1818

12 cm, 4 3/4"

Anastomosenklemme

Anastomosis clamp

Pinza-clamp para anastomosis

Pince-clamp pour anastomose

Pinza per anastomosi

ATRAUMATIC-GRIP Gefäßklemmen mit LAWTON-Zahnung
 ATRAUMATIC-GRIP Vascular Clamps with Toothing LAWTON
 ATRAUMATIC-GRIP Pinzas-clamps vasculares con dentado LAWTON
 ATRAUMATIC-GRIP Pincas vasculaires avec denture LAWTON
 ATRAUMATIC-GRIP Pinze vascolari con dentatura LAWTON



sehr feine Modelle für Kinderchirurgie • very delicate patterns for pediatric surgery • modelos muy delicados para la pediatría
 modèles très délicats pour chirurgie pédiatrique • modelli molto delicati per uso pediatrico



23-1820
 16,5 cm, 6 1/2"

Mehrweckklemme
 Multi-purpose clamp
 Pinza-clamp de varias aplicaciones
 Pince-clamp universelles
 Pinza multiuso

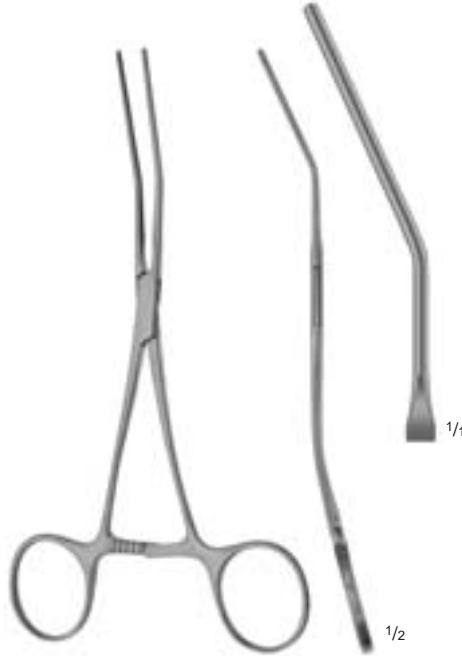

23-1810
 16 cm, 6 1/4"

Mehrweckklemme
 Multi-purpose clamp
 Pinza-clamp de varias aplicaciones
 Pince-clamp universelles
 Pinza multiuso



23-1800
 15 cm, 6"

Mehrweckklemme
 Multi-purpose clamp
 Pinza-clamp de varias aplicaciones
 Pince-clamp universelles
 Pinza multiuso

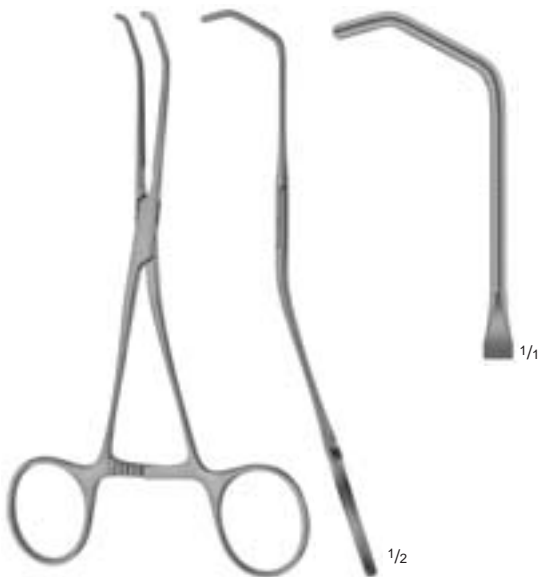

23-1830
 15 cm, 6"

Anastomosenklemme
 Anastomosis clamp
 Pinza-clamp para anastomosis
 Pince-clamp pour anastomose
 Pinza per anastomosi

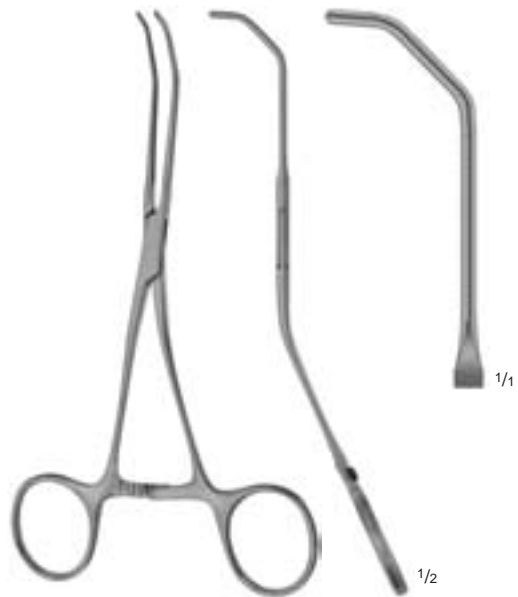

23-1840
 15,5 cm, 6"

Anastomosenklemme
 Anastomosis clamp
 Pinza-clamp para anastomosis
 Pince-clamp pour anastomose
 Pinza per anastomosi



ATRAUMATIC-GRIP Gefäßklemmen mit LAWTON-Zahnung
 ATRAUMATIC-GRIP Vascular Clamps with Toothing LAWTON
 ATRAUMATIC-GRIP Pinzas-clamps vasculares con dentado LAWTON
 ATRAUMATIC-GRIP Pincas vasculaires avec denture LAWTON
 ATRAUMATIC-GRIP Pinze vascolari con dentatura LAWTON



sehr feine Modelle für Kinderchirurgie • very delicate patterns for pediatric surgery • modelos muy delicados para la pediatría
 modèles très délicats pour chirurgie pédiatrique • modelli molto delicati per uso pediatrico



23-1860
23-1870



23-1861
23-1871



23-1862
23-1872



23-1863
23-1873



23-1864
23-1874

Mehrzweckklemmen • Multi-purpose clamps • Pinzas-clamps de varias aplicaciones • Pincas-clamps universelles • Pinze multiuso



▶ 23-1865
▶ 23-1875



23-1866
23-1876



23-1868
23-1878



23-1867
23-1877

Anastomosenklemmen • Anastomosis clamps • Pinzas-clamps para anastomosis • Pincas-clamps pour anastomose • Pinze per anastomosi

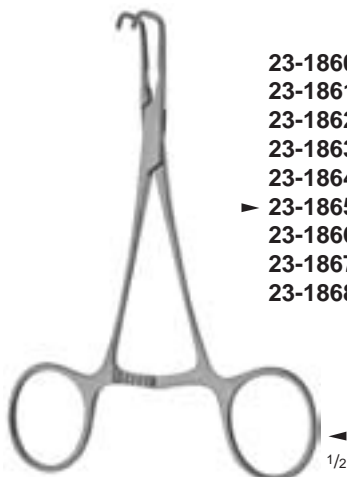

23-1860 14,0 cm, 5 1/2"
 23-1861 14,0 cm, 5 1/2"
 23-1862 13,5 cm, 5 1/4"
 23-1863 13,0 cm, 5 1/8"
 23-1864 14,0 cm, 5 1/2"
 ▶ 23-1865 12,5 cm, 5"
 23-1866 12,5 cm, 5"
 23-1867 13,5 cm, 5 1/4"
 23-1868 13,0 cm, 5 1/8"

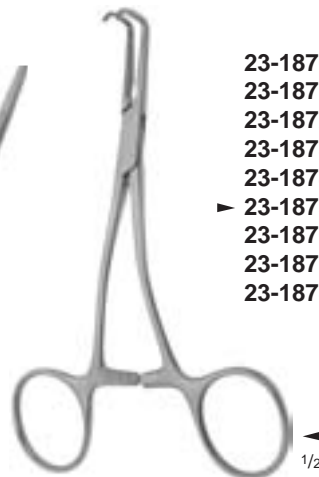

23-1870 13,5 cm, 5 1/4"
 23-1871 13,5 cm, 5 1/4"
 23-1872 13,0 cm, 5 1/8"
 23-1873 12,5 cm, 5"
 23-1874 13,5 cm, 5 1/4"
 ▶ 23-1875 12,0 cm, 4 3/4"
 23-1876 12,0 cm, 4 3/4"
 23-1877 13,0 cm, 5 1/8"
 23-1878 12,5 cm, 5"

ATRAUMATIC-GRIP Gefäßklemmen mit LAWTON-Zahnung
 ATRAUMATIC-GRIP Vascular Clamps with Toothing LAWTON
 ATRAUMATIC-GRIP Pinzas-clamps vasculares con dentado LAWTON
 ATRAUMATIC-GRIP Pincas vasculaires avec denture LAWTON
 ATRAUMATIC-GRIP Pinze vascolari con dentatura LAWTON



sehr feine Modelle für Kinderchirurgie • very delicate patterns for pediatric surgery • modelos muy delicados para la pediatría
 modèles très délicats pour chirurgie pédiatrique • modelli molto delicati per uso pediatrico



23-1880
23-1890



23-1881
23-1891



23-1882
23-1892



23-1883
23-1893



23-1884
23-1894

Mehrweckklemmen • Multi-purpose clamps • Pinzas-clamps de varias aplicaciones • Pincas-clamps universelles • Pinze multiuso



► 23-1885
► 23-1895



23-1886
23-1896



23-1888
23-1898



23-1887
23-1897

Anastomosenklemmen • Anastomosis clamps • Pinzas-clamps para anastomosis • Pincas-clamps pour anastomose • Pinze per anastomosi

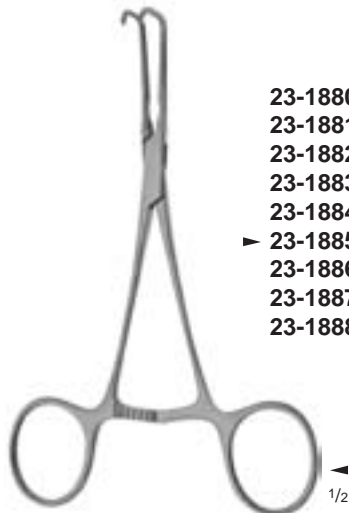

23-1880 15,0 cm, 6"
 23-1881 15,0 cm, 6"
 23-1882 14,5 cm, 5³/₄"
 23-1883 13,5 cm, 5¹/₄"
 23-1884 14,5 cm, 5³/₄"
 ► 23-1885 13,5 cm, 5¹/₄"
 23-1886 13,5 cm, 5¹/₄"
 23-1887 14,5 cm, 5³/₄"
 23-1888 14,0 cm, 5¹/₂"

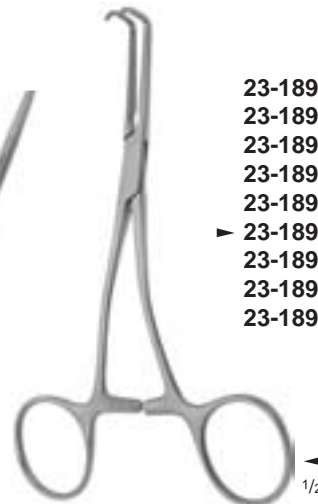

23-1890 14,5 cm, 5³/₄"
 23-1891 14,5 cm, 5³/₄"
 23-1892 14,0 cm, 5¹/₂"
 23-1893 13,0 cm, 5¹/₈"
 23-1894 14,0 cm, 5¹/₂"
 ► 23-1895 13,0 cm, 5¹/₈"
 23-1896 13,0 cm, 5¹/₈"
 23-1897 14,0 cm, 5¹/₂"
 23-1898 13,5 cm, 5¹/₄"



ATRAUMATIC-GRIP Karotis-Klemmen mit LAWTON-Zahnung
 ATRAUMATIC-GRIP Carotid Clamps with Toothing LAWTON
 ATRAUMATIC-GRIP Pinzas-clamps para carótida con dentado LAWTON
 ATRAUMATIC-GRIP Pincas-clamps pour la carotide avec denture LAWTON
 ATRAUMATIC-GRIP Pinze per la carotide con dentatura LAWTON

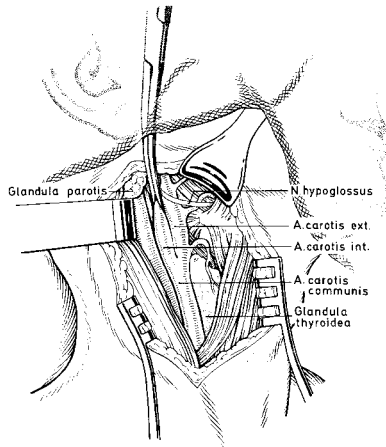

Der Einsatz der Spezialklemme nach DEVIN in der Karotis-Chirurgie ist sehr vorteilhaft, da das Instrument nicht in das Operationsfeld hineinragt und bei der Arteriotomie ein freies Gesichtsfeld gewährleistet ist.

The special DEVIN clamp offers numerous advantages for carotid surgery. Its use ensures that the area in which the arteriotomy is performed is not obstructed by any instrument in front of or behind the operating area.

La utilización de la pinza especial DEVIN en la cirugía de la carótida ofrece grandes ventajas; de este modo no hay ningún instrumento que cruce (tanto adelante que atrás) la región de la arteriotomía.

L'utilisation du clamp spécial de DEVIN est très avantageuse pour la chirurgie carotidienne, car ainsi il n'y a pas d'instrument qui croise (par devant ou par derrière) la région de l'artériotomie.

La pinza DEVIN offre numerosi vantaggi nella chirurgia della carotide. Il suo impiego assicura che nell'area ove viene eseguita l'arteriotomia il campo non sia ostruito (davanti e dietro).

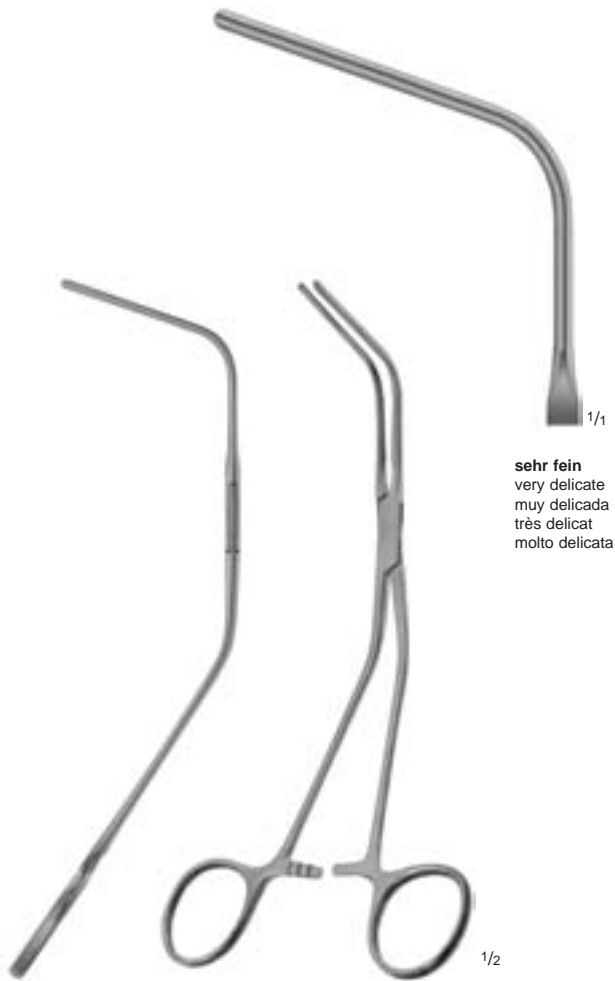

sehr fein
 very delicate
 muy delicada
 très délicat
 molto delicata

DEVIN
 23-1850
 19 cm, 7 1/2"



sehr fein
 very delicate
 muy delicada
 très délicat
 molto delicata

DEVIN
 23-1852
 17,5 cm, 7"

ATRAUMATIC-GRIP Bulldogklemmen mit DE BAKEY-Zahnung

ATRAUMATIC-GRIP Bulldog Clamps with Toothing DE BAKEY

ATRAUMATIC-GRIP Clamps Bulldog con dentado DE BAKEY

ATRAUMATIC-GRIP Clamps Bulldog avec denture DE BAKEY

ATRAUMATIC-GRIP Pinze Bulldog con dentatura DE BAKEY



Schließdruck einstellbar
occlusion pressure adjustable
presión de oclusión ajustable
pression d'occlusion ajustable
pressione occlusiva regolabile



▶ **30-1000**
8 cm
3 1/8"

30-1005
9 cm
3 1/2"

30-1010
10,5 cm
4 1/8"

30-1015
12 cm
4 3/4"

30-1001
7,5 cm
3"

30-1006
8,5 cm
3 3/8"

30-1011
10 cm
4"

30-1016
11,5 cm
4 1/2"

GLOVER-
DE BAKEY
30-1000
- **30-1016**



GLOVER-
DE BAKEY
30-1026
5 cm, 2"



SATINSKY-
DE BAKEY
30-1027
7 cm, 2 3/4"



CAROTIS-
DE BAKEY
30-1030
9 cm, 3 1/2"



SATINSKY-
DE BAKEY
30-1025
10 cm, 4"



ATRAUMATIC-GRIP Bulldogklemmen mit DE BAKEY-Zahnung

ATRAUMATIC-GRIP Bulldog Clamps with Toothing DE BAKEY

ATRAUMATIC-GRIP Clamps Bulldog con dentado DE BAKEY

ATRAUMATIC-GRIP Clamps Bulldog avec denture DE BAKEY

ATRAUMATIC-GRIP Pinze Bulldog con dentatura DE BAKEY

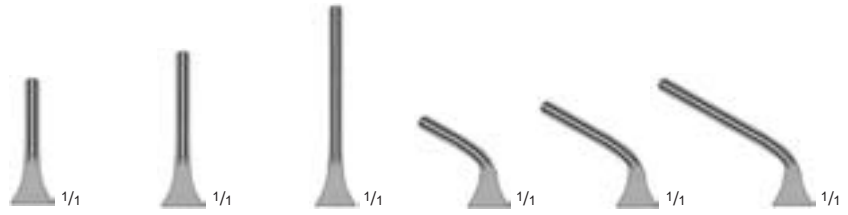

Kat. Nr. Cat. ref. Núm. de cat. No. de cat. No di cat.	06-0082	06-0083	▶ 06-0084	06-0085	06-0086	06-0087
Länge Length Longitud Longeur Lungh.	49 mm	53 mm	59 mm	44 mm	46 mm	49 mm
Maullänge Length of jaw Longitud de boca Longueur des mors Lungh. dei morsi	10 mm	14 mm	20 mm	10 mm	14 mm	20 mm
Schließdruck Occlusion pressure Presión de oclusión Pression d'occlusion Pressione occlusiva	180 ± 10 gr.	180 ± 10 gr.	180 ± 10 gr.	180 ± 10 gr.	180 ± 10 gr.	180 ± 10 gr.
Gewicht Weight Peso Poids Peso	3 gr.	3 gr.	3 gr.	3 gr.	3 gr.	3 gr.



DIETRICH-
DE BAKEY
06-0082
- 06-0087

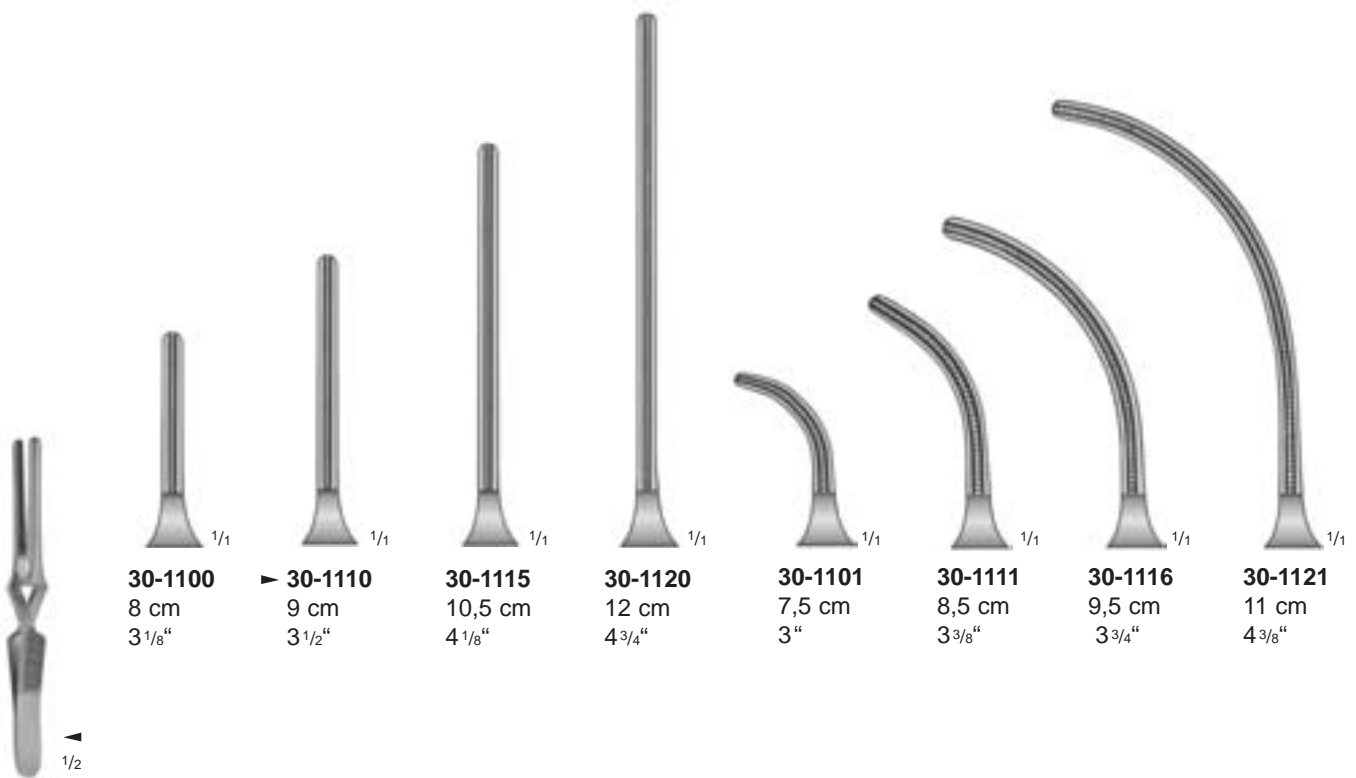

30-1100
8 cm
3 1/8"

▶ **30-1110**
9 cm
3 1/2"

30-1115
10,5 cm
4 1/8"

30-1120
12 cm
4 3/4"

30-1101
7,5 cm
3"

30-1111
8,5 cm
3 3/8"

30-1116
9,5 cm
3 3/4"

30-1121
11 cm
4 3/8"



DE BAKEY
30-1100
- 30-1121

ATRAUMATIC-GRIP Bulldogklemmen mit DE BAKEY-Zahnung

ATRAUMATIC-GRIP Bulldog Clamps with Toothing DE BAKEY

ATRAUMATIC-GRIP Clamps Bulldog con dentado DE BAKEY

ATRAUMATIC-GRIP Clamps Bulldog avec denture DE BAKEY

ATRAUMATIC-GRIP Pinze Bulldog con detatura DE BAKEY



1/2



1/1

30-1124
9 cm, 3 1/2"



1/1

30-1125
11 cm, 4 3/8"

GREGORY-SOFT

30-1124

- **30-1125**

Karotisklemmen

Carotid clamps

Pinzas-clamps para carótis

Pinces-clamps pour la carotide

Pinze per la carotide



1/1

30-1127
11 cm, 4 3/8"

links
left
izquierda
gauche
sinistra



1/1

30-1128
11 cm, 4 3/8"

rechts
right
derecha
droite
destra



1/2

GREGORY-SOFT

30-1127

- **30-1128**

Karotisklemmen

Carotid clamps

Pinzas-clamps para carótis

Pinces-clamps pour la carotide

Pinze per la carotide



1/2

JOHNS-HOPKINS

06-0035

24,5 cm, 9 3/4"

Anlege- und Entfernungszange für Bulldogklemmen 06-0082 - 06-0087 und 30-1100 - 30-1121

Applying and removing forceps for Bulldog clamps 06-0082 - 06-0087 and 30-1100 - 30-1121

Pinza para poner y quitar clamps Bulldog 06-0082 - 06-0087 y 30-1100 - 30-1121

Pince pour poser et retirer les clamps Bulldog 06-0082 - 06-0087 et 30-1100 - 30-1121

Pinza per applicare e rimuovere clamps 06-0082 - 06-0087 e 30-1100 - 30-1121



ATRAUMATIC-GRIP Bulldogklemmen mit DE BAKEY-Zahnung

ATRAUMATIC-GRIP Bulldog Clamps with Toothing DE BAKEY

ATRAUMATIC-GRIP Clamps Bulldog con dentado DE BAKEY

ATRAUMATIC-GRIP Clamps Bulldog avec denture DE BAKEY

ATRAUMATIC-GRIP Pinze Bulldog con dentatura DE BAKEY



DE BAKEY
30-1130
13 cm, 5 1/8"

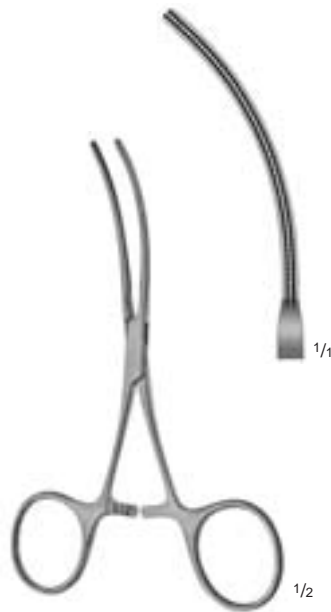

DE BAKEY
30-1132
12,5 cm, 5"



DE BAKEY
30-1136
10 cm, 4"



DE BAKEY
30-1138
12,5 cm, 5"

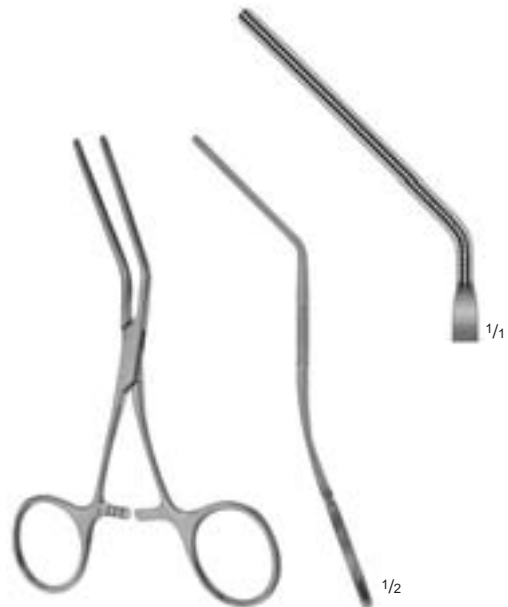

DE BAKEY
30-1134
12,5 cm, 5"

ATRAUMATIC-GRIP Gefäßklemmen mit DE BAKEY-Zahnung
 ATRAUMATIC-GRIP Vascular Clamps with Toothing DE BAKEY
 ATRAUMATIC-GRIP Pinzas-clamps vasculares con dentado DE BAKEY
 ATRAUMATIC-GRIP Pinces vasculaires avec denture DE BAKEY
 ATRAUMATIC-GRIP Pinze vascolari con dentatura DE BAKEY



DE BAKEY-PEAN
06-0423
 - **06-0436**

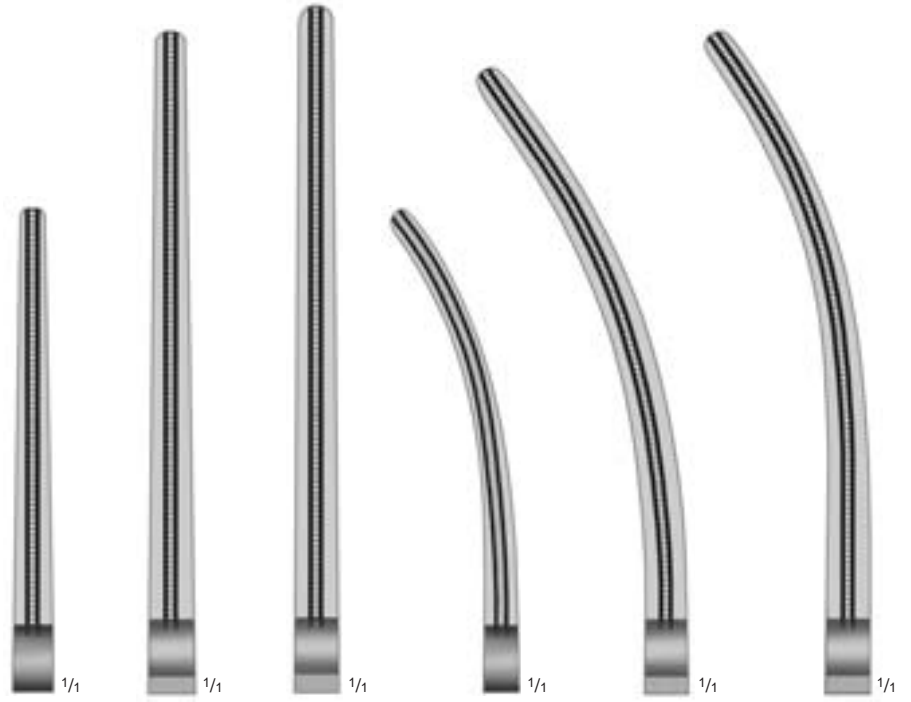

▶ 06-0423	06-0433	06-0434	06-0428	06-0435	06-0436
20 cm	26,5 cm	28 cm	20 cm	26,5 cm	28 cm
8"	10 1/2"	11"	8"	10 1/2"	11"



DE BAKEY
30-1160
 - **30-1167**

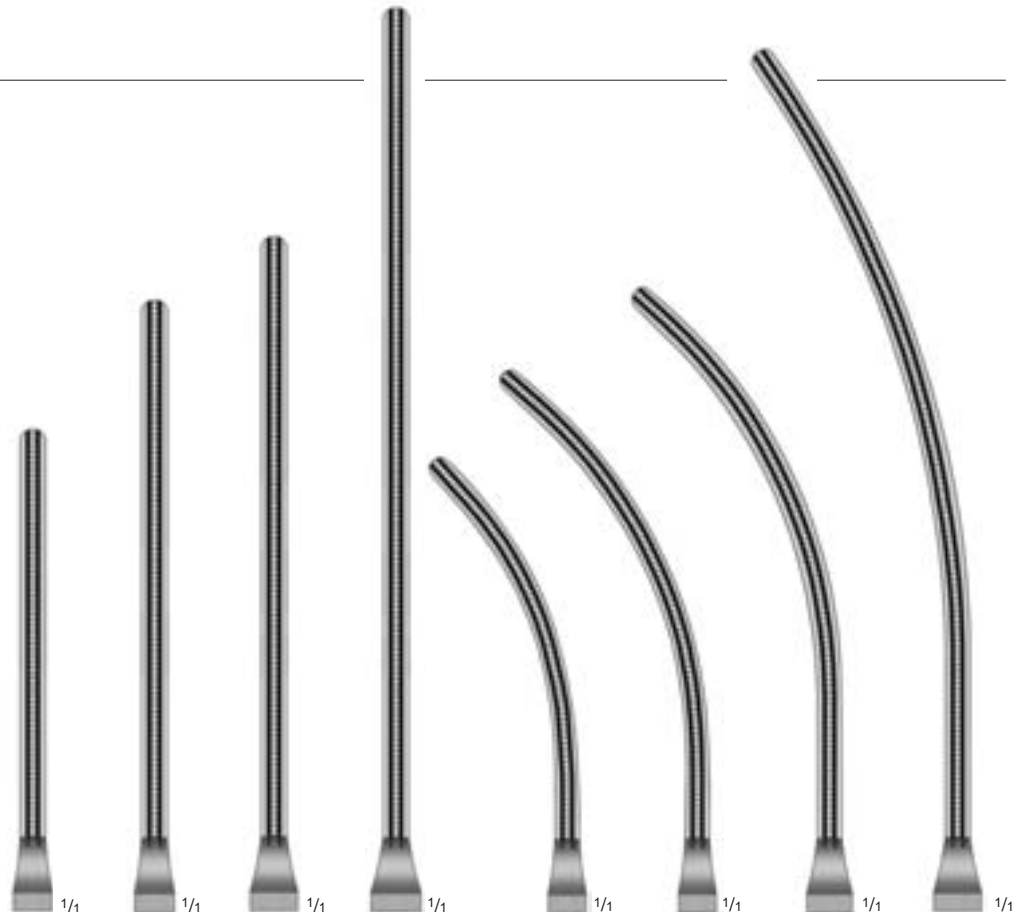

▶ 30-1160	30-1162	30-1164	30-1166	30-1161	30-1163	30-1165	30-1167
21,5 cm	23 cm	27 cm	31 cm	21,5 cm	23 cm	27 cm	31 cm
8 1/2"	9"	10 3/4"	12 1/4"	8 1/2"	9"	10 3/4"	12 1/4"



ATRAUMATIC-GRIP Gefäßklemmen mit DE BAKEY-Zahnung
 ATRAUMATIC-GRIP Vascular Clamps with Toothing DE BAKEY
 ATRAUMATIC-GRIP Pinzas-clamps vasculares con dentado DE BAKEY
 ATRAUMATIC-GRIP Pinces vasculaires avec denture DE BAKEY
 ATRAUMATIC-GRIP Pinze vascolari con dentatura DE BAKEY

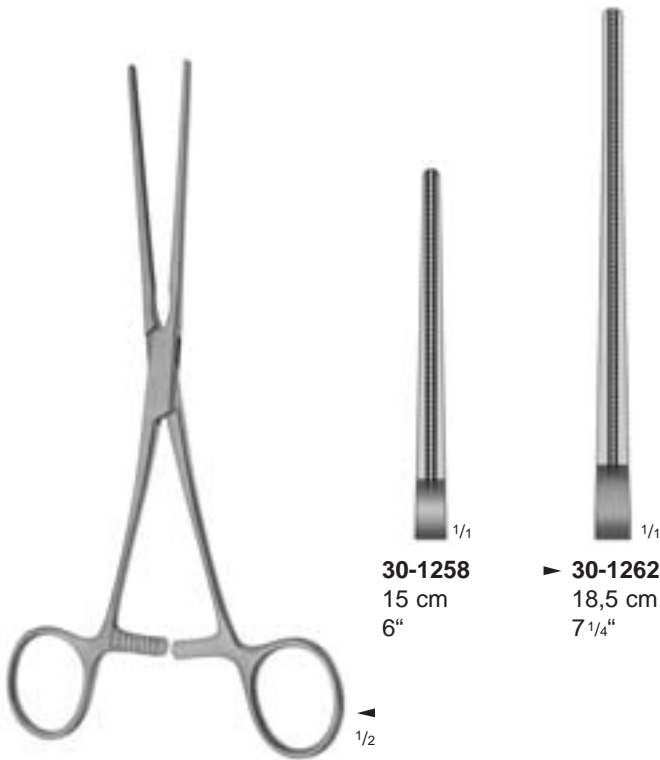

30-1258
15 cm
6"

▶ **30-1262**
18,5 cm
7 1/4"

30-1263
15 cm
6"

▶ **30-1267**
18,5 cm
7 1/4"

DE BAKEY-BAINBRIDGE
30-1258
- 30-1262

DE BAKEY-BAINBRIDGE
30-1263
- 30-1267



23-2535
16 cm, 6 1/4"

▶ **23-2537**
15,5 cm, 6"

23-2539
14 cm, 5 1/2"

Mehrzweckklemmen • Multi-purpose clamps • Pinzas-clamps de varias aplicaciones
 Pinces-clamps universelles • Pinze multiuso

DE BAKEY
23-2535
- 23-2539

ATRAUMATIC-GRIP Patent-Ductusklemmen mit DE BAKEY-Zahnung

ATRAUMATIC-GRIP Patent Ductus Clamps with Toothing DE BAKEY

ATRAUMATIC-GRIP Pinzas patente de conducto con dentado DE BAKEY

ATRAUMATIC-GRIP Clamps patent-ductus avec denture DE BAKEY

ATRAUMATIC-GRIP Pinze esclusive per dotto con dentatura DE BAKEY

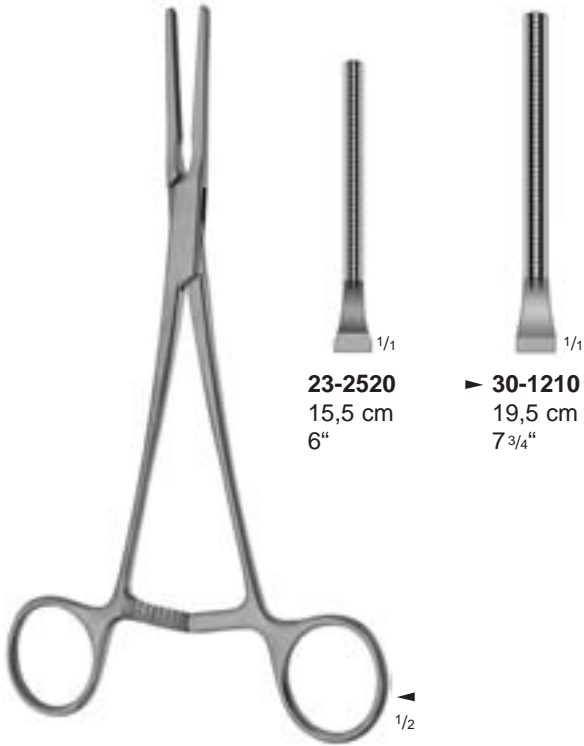

23-2520
15,5 cm
6"

▶ **30-1210**
19,5 cm
7 3/4"

DE BAKEY
23-2520
- **30-1210**

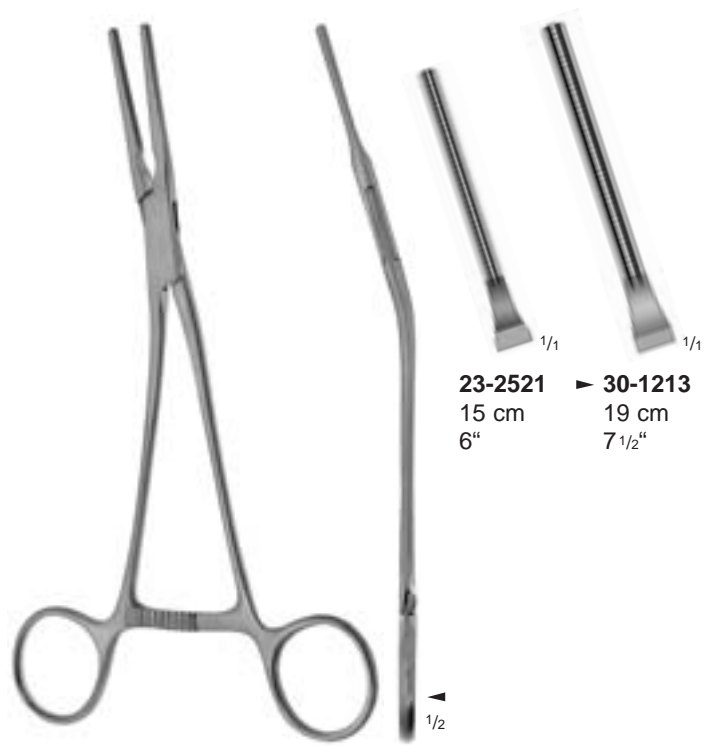

23-2521
15 cm
6"

▶ **30-1213**
19 cm
7 1/2"

DE BAKEY
23-2521
- **30-1213**



DE BAKEY-POTTS
30-1910
20,5 cm, 8"



DE BAKEY-POTTS
30-1911
20 cm, 8"



ATRAUMATIC-GRIP Coarctationsklemmen mit DE BAKEY-Zahnung
ATRAUMATIC-GRIP Coarctation Clamps with Toothing DE BAKEY
ATRAUMATIC-GRIP Pinzas-clamps para coarctación con dentado DE BAKEY
ATRAUMATIC-GRIP Pinces-clamps pour coarctation avec denture DE BAKEY
ATRAUMATIC-GRIP Pinze per coartazione con dentatura DE BAKEY



DE BAKEY
23-2522
16,5 cm, 6 1/2"



DE BAKEY
23-2523
16 cm, 6 1/4"



DE BAKEY
23-2555
17 cm, 6 3/4"



DE BAKEY
23-2524
17 cm, 6 3/4"

ATRAUMATIC-GRIP Coarctationsklemmen mit DE BAKEY-Zahnung

ATRAUMATIC-GRIP Coarctation Clamps with Toothing DE BAKEY

ATRAUMATIC-GRIP Pinzas-clamps para coarctación con dentado DE BAKEY

ATRAUMATIC-GRIP Pincas-clamps pour coarctation avec denture DE BAKEY

ATRAUMATIC-GRIP Pinze per coartazione con dentatura DE BAKEY



30-1915
20,5 cm, 8"



30-1200
22,5 cm, 9"



30-1917
26 cm, 10 1/4"

DE BAKEY
30-1200
- 30-1917

1/2



30-1916
20 cm, 8"



30-1203
22 cm, 8 3/4"



30-1918
25,5 cm, 10"

DE BAKEY
30-1203
- 30-1918

1/2



ATRAUMATIC-GRIP Gefäßklemmen mit DE BAKEY-Zahnung
 ATRAUMATIC-GRIP Vascular Clamps with Toothing DE BAKEY
 ATRAUMATIC-GRIP Pinzas-clamps vasculares con dentado DE BAKEY
 ATRAUMATIC-GRIP Pincas vasculaires avec denture DE BAKEY
 ATRAUMATIC-GRIP Pinze vascolari con dentatura DE BAKEY



GREGORY
30-1150
 - **30-1154**



30-1150
 14 cm, 5 1/2"



▶ **30-1152**
 16 cm, 6 1/4"



30-1154
 18 cm, 7"

Profundaklemmen • Profunda clamps • Pinzas-clamps para la profunda • Pincas-clamps pour fémorale • Pinze per profunda



LELAND-JONES
30-1291
 - **30-1292**



30-1291
 19 cm, 7 1/2"

▶ **30-1292**
 18,5 cm, 7 1/4"



DE BAKEY
30-1235
 18 cm, 7"

Peripheralklemmen • Peripheral vascular clamps • Pinzas-clamps para vasos periféricos • Pincas-clamps vasculaires périphériques • Pinze per vasi periferici

ATRAUMATIC-GRIP Peripheralklemmen mit DE BAKEY-Zahnung

ATRAUMATIC-GRIP Peripheral Vascular Clamps with Toothing DE BAKEY

ATRAUMATIC-GRIP Pinzas-clamps para vasos periféricos

ATRAUMATIC-GRIP Pincas-clamps vasculaires périphériques avec denture DE BAKEY

ATRAUMATIC-GRIP Pinze per vasi periferici con dentatura DE BAKEY



DE BAKEY
30-1250
15,5 cm, 6"



DE BAKEY
30-1240
- 30-1245

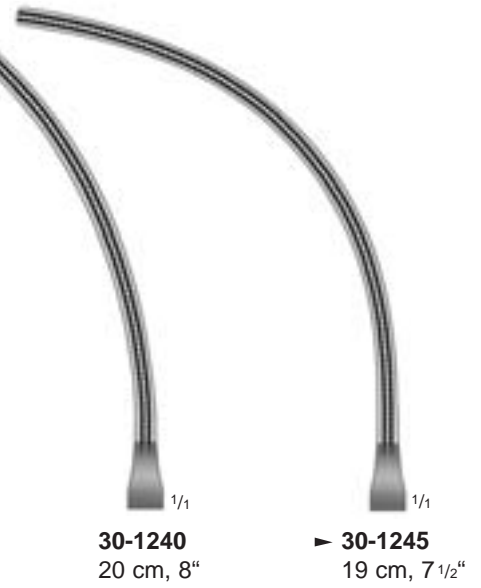

30-1240
20 cm, 8"

▶ 30-1245
19 cm, 7 1/2"



DALE
30-1270
- 30-1276

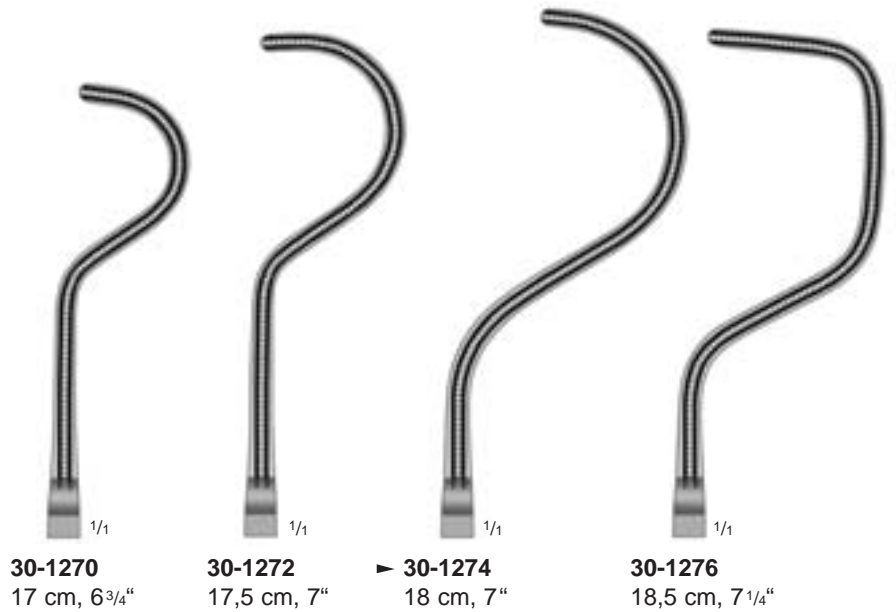

30-1270
17 cm, 6 3/4"

30-1272
17,5 cm, 7"

▶ 30-1274
18 cm, 7"

30-1276
18,5 cm, 7 1/4"



ATRAUMATIC-GRIP Peripheralklemmen mit DE BAKEY-Zahnung

ATRAUMATIC-GRIP Peripheral Vascular Clamps with Toothing DE BAKEY

ATRAUMATIC-GRIP Pinzas-clamps para vasos periféricos

ATRAUMATIC-GRIP Pincas-clamps vasculaires périphériques avec denture DE BAKEY

ATRAUMATIC-GRIP Pinze per vasi periferici con dentatura DE BAKEY



DE BAKEY
30-1280
15 cm, 6"



DE BAKEY
30-1282
16,5 cm, 6 1/2"

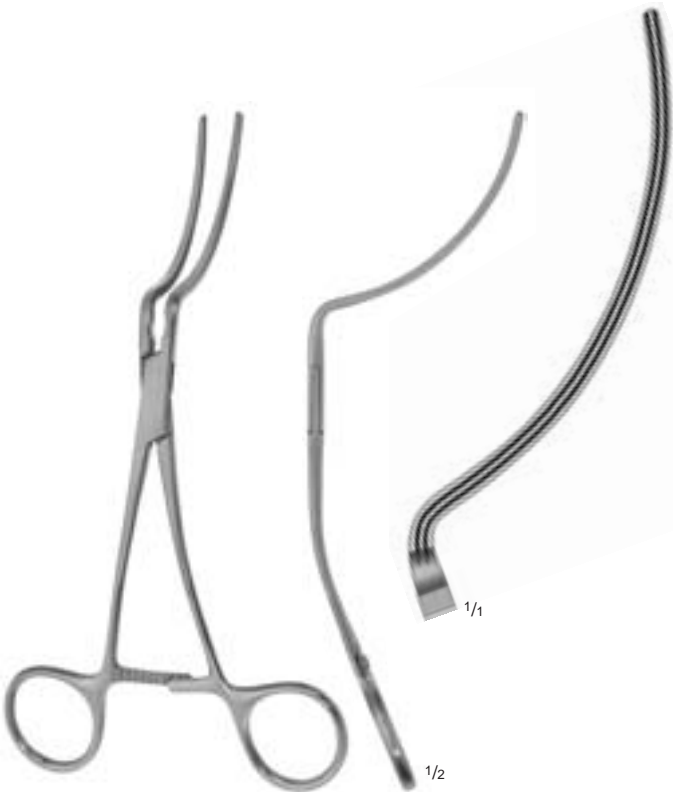

DE BAKEY
30-1284
18 cm, 7"

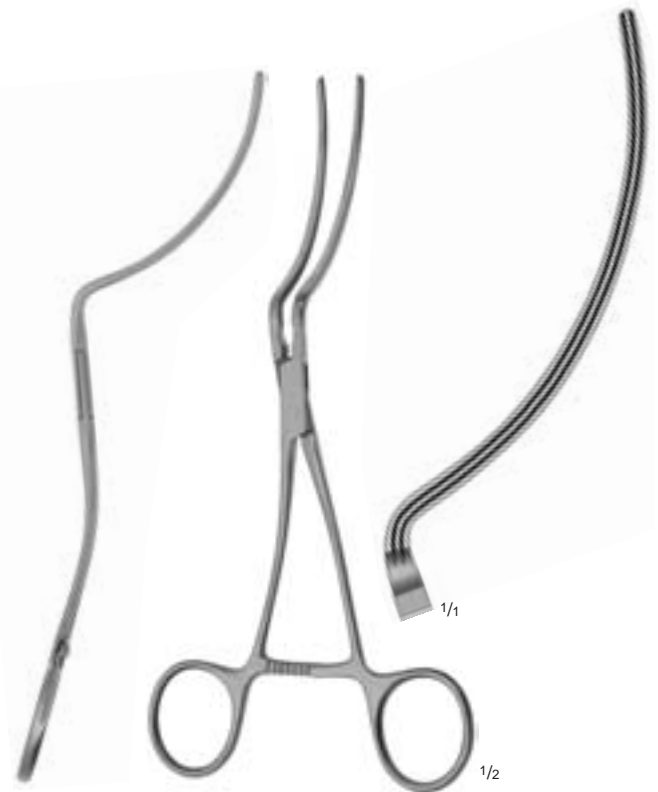

DE BAKEY
30-1286
19 cm, 7 1/2"

ATRAUMATIC-GRIP Gefäßklemmen mit DE BAKEY-Zahnung
ATRAUMATIC-GRIP Vascular Clamps with Toothing DE BAKEY
ATRAUMATIC-GRIP Pinzas-clamps vasculares con dentado DE BAKEY
ATRAUMATIC-GRIP Pincas vasculaires avec denture DE BAKEY
ATRAUMATIC-GRIP Pinze vascolari con dentatura DE BAKEY



DE BAKEY
30-1156
 20 cm, 8"
Nierenarterienklemme
 Renal artery clamp
 Pinza-clamp para arteria renal
 Pince hémostatique rénale
 Pinza emostatica per arteria renale



JAVID
30-1146
 18 cm, 7"
Karotisklemme
 Carotid clamp
 Pinza-clamp para carótida
 Pince-clamp pour la carotide
 Pinza per carotide

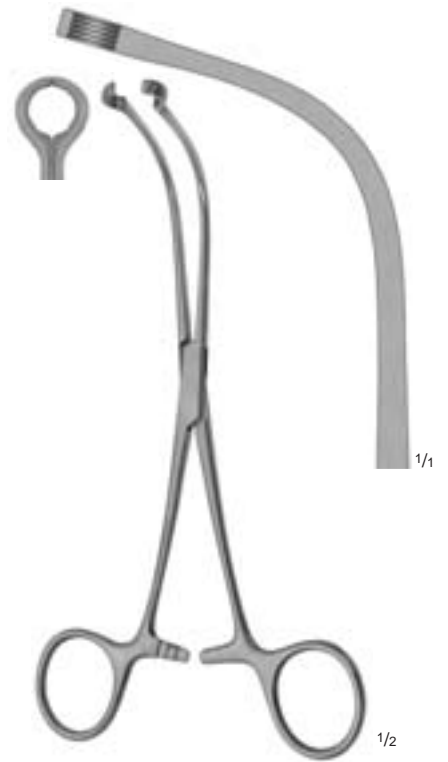

JAVID
30-1148
 19 cm, 7 1/4"
Karotisklemme
 Carotid clamp
 Pinza-clamp para carótida
 Pince-clamp pour la carotide
 Pinza per carotide



SUBRAMANIAN
23-2037
 15,5 cm, 6"



SUBRAMANIAN
23-2038
 15,5 cm, 6"



DE BAKEY-BECK
23-2550
 16 cm, 6 1/4"

Aortaklemmen • Aortic Clamps • Pinzas-clamps para aorta • Pincas-clamps pour aorte • Pinze per aorta



ATRAUMATIC-GRIP Aortaklemmen mit DE BAKEY-Zahnung

ATRAUMATIC-GRIP Aortic Clamps with Toothing DE BAKEY

ATRAUMATIC-GRIP Pinzas-clamps para aorta con dentado DE BAKEY

ATRAUMATIC-GRIP Pincas-clamps pour aorte avec denture DE BAKEY

ATRAUMATIC-GRIP Pinze per aorta con dentatura DE BAKEY

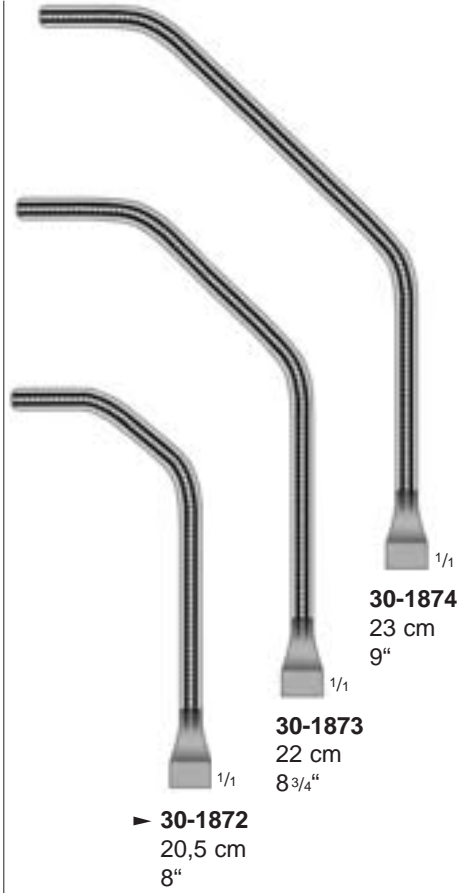

BAILEY
30-1870
- 30-1871



BAILEY
30-1872
- 30-1874



BAILEY
30-1875
- 30-1877

ATRAUMATIC-GRIP Aortaklemmen mit DE BAKEY-Zahnung
ATRAUMATIC-GRIP Aortic Clamps with Toothing DE BAKEY
ATRAUMATIC-GRIP Pinzas-clamps para aorta con dentado DE BAKEY
ATRAUMATIC-GRIP Pincas-clamps pour aorte avec denture DE BAKEY
ATRAUMATIC-GRIP Pinze per aorta con dentatura DE BAKEY



1/1



1/1



1/1



1/2

DIETRICH
30-1646
 19,5 cm, 7 3/4"



1/2

OCHSNER
30-1648
 24 cm, 9 1/2"



1/2

DE BAKEY
30-1650
 26 cm, 10 1/4"



ATRAUMATIC-GRIP Aortaklemmen mit DE BAKEY-Zahnung
ATRAUMATIC-GRIP Aortic Clamps with Toothing DE BAKEY
ATRAUMATIC-GRIP Pinzas-clamps para aorta con dentado DE BAKEY
ATRAUMATIC-GRIP Pincas-clamps pour aorte avec denture DE BAKEY
ATRAUMATIC-GRIP Pinze per aorta con dentatura DE BAKEY



▶ **30-1700**
22,5 cm, 9"



▶ **30-1704**
27,5 cm, 10³/₄"



30-1702
18 cm, 7"



30-1706
23 cm, 9"



DE BAKEY-MORRIS
30-1700
- **30-1702**



DE BAKEY-MORRIS
30-1704
- **30-1706**

ATRAUMATIC-GRIP Gefäßklemmen für Tangential-Verschluss
 ATRAUMATIC-GRIP Tangential Occlusion Clamps
 ATRAUMATIC-GRIP Pinzas-clamps para oclusión tangencial
 ATRAUMATIC-GRIP Pincés vasculaires pour occlusion tangentielle
 ATRAUMATIC-GRIP Pinze vascolari per occlusione tangenziale

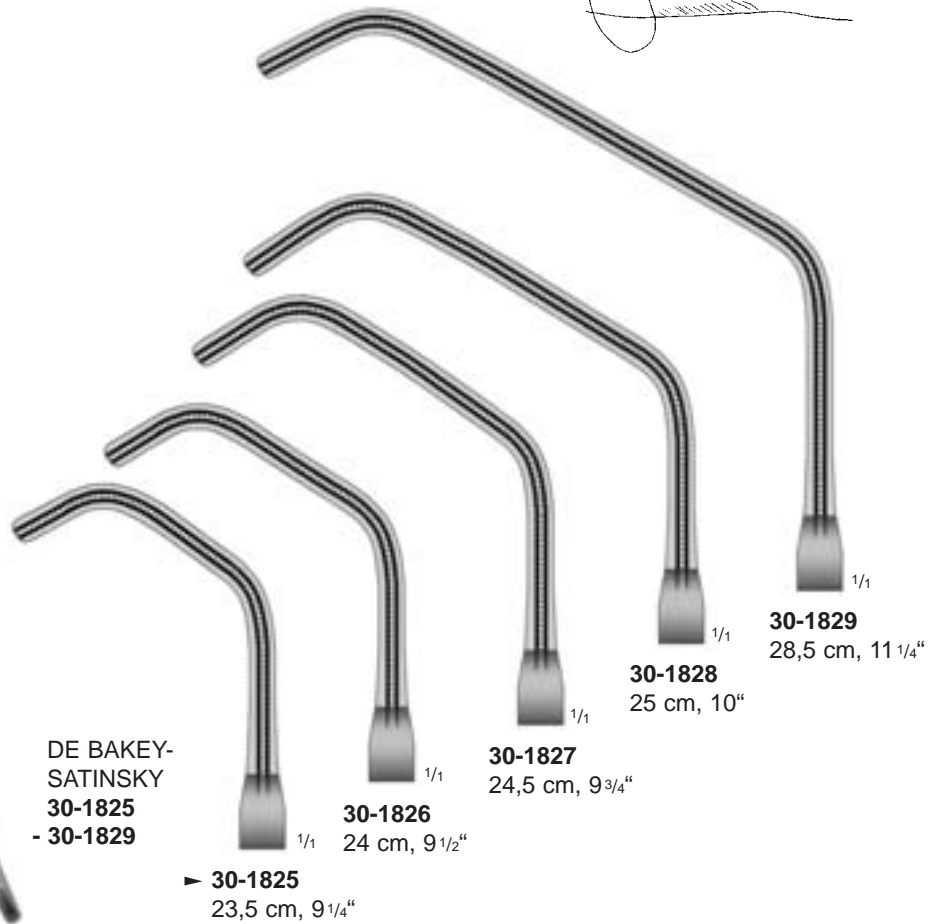
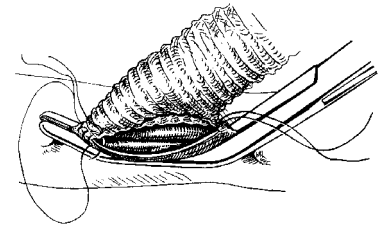
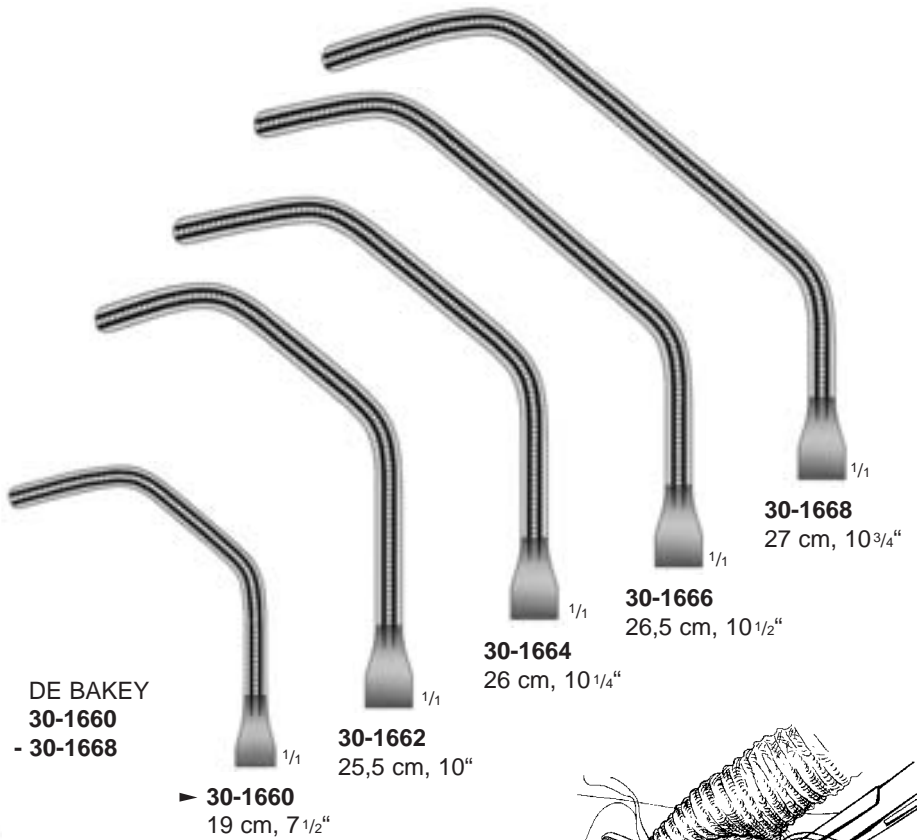



ATRAUMATIC-GRIP Anastomosenklemmen mit DE BAKEY-Zahnung
ATRAUMATIC-GRIP Anastomosis Clamps with Toothing DE BAKEY
ATRAUMATIC-GRIP Pinzas-clamps para anastomosis con dentado DE BAKEY
ATRAUMATIC-GRIP Pinces-clamps à anastomose avec denture DE BAKEY
ATRAUMATIC-GRIP Pinze per anastomosi con dentatura DE BAKEY



DE BAKEY-REYNOLDS
23-2580
- 23-2586

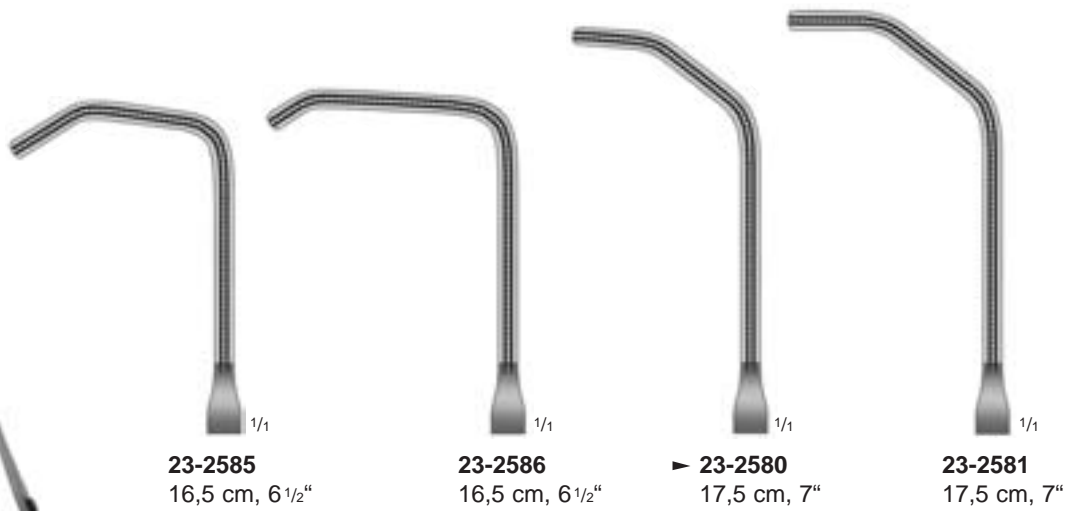

DE BAKEY-DERRA
23-2565
- 23-2567

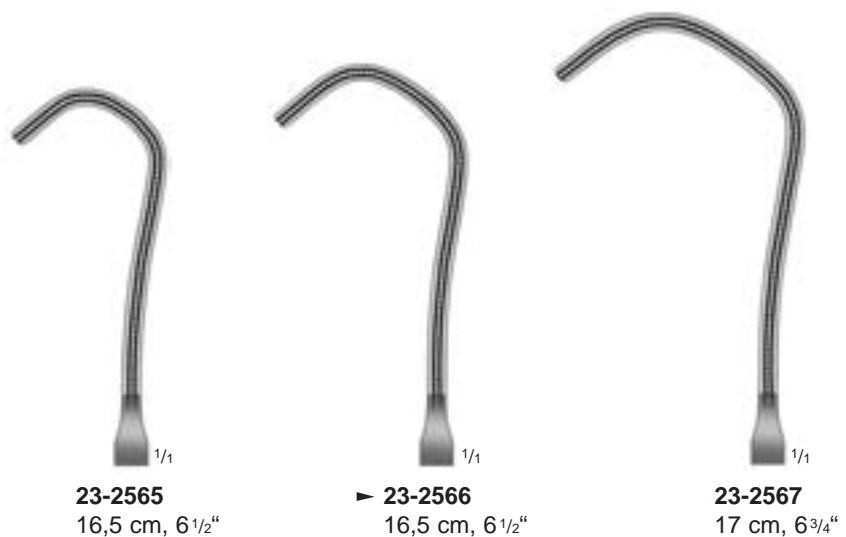

ATRAUMATIC-GRIP Anastomosenklemmen mit DE BAKEY-Zahnung
 ATRAUMATIC-GRIP Anastomosis Clamps with Toothing DE BAKEY
 ATRAUMATIC-GRIP Pinzas-clamps para anastomosis con dentado DE BAKEY
 ATRAUMATIC-GRIP Pincers-clamps à anastomose avec denture DE BAKEY
 ATRAUMATIC-GRIP Pinze per anastomosi con dentatura DE BAKEY

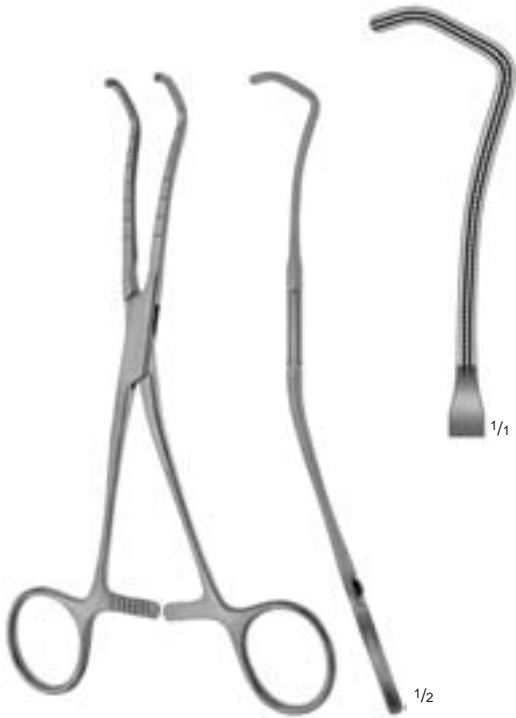

DE BAKEY
23-2593
 17 cm, 6³/₄"

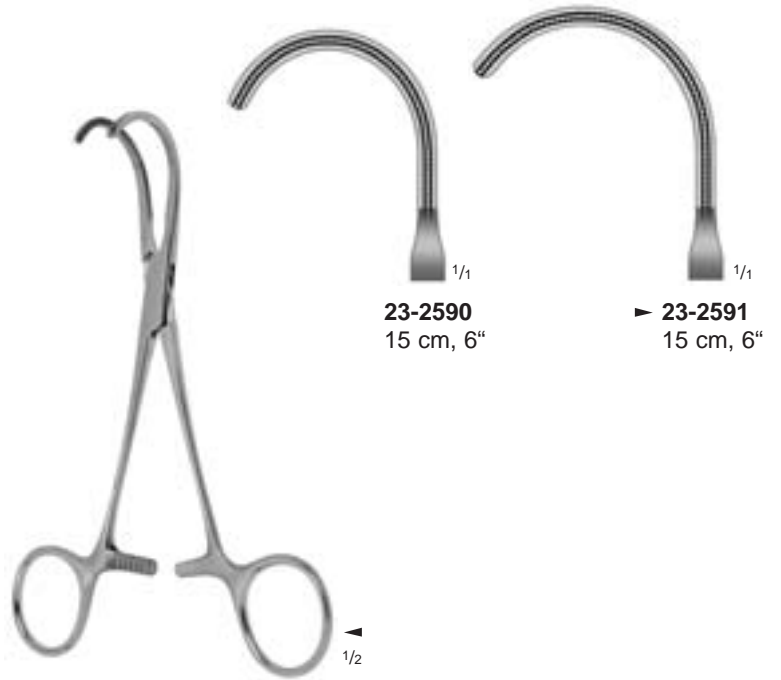

DE BAKEY-BECK
23-2590
 - **23-2591**

23-2590
 15 cm, 6"

▶ **23-2591**
 15 cm, 6"



DE BAKEY
23-2528
 - **23-2530**

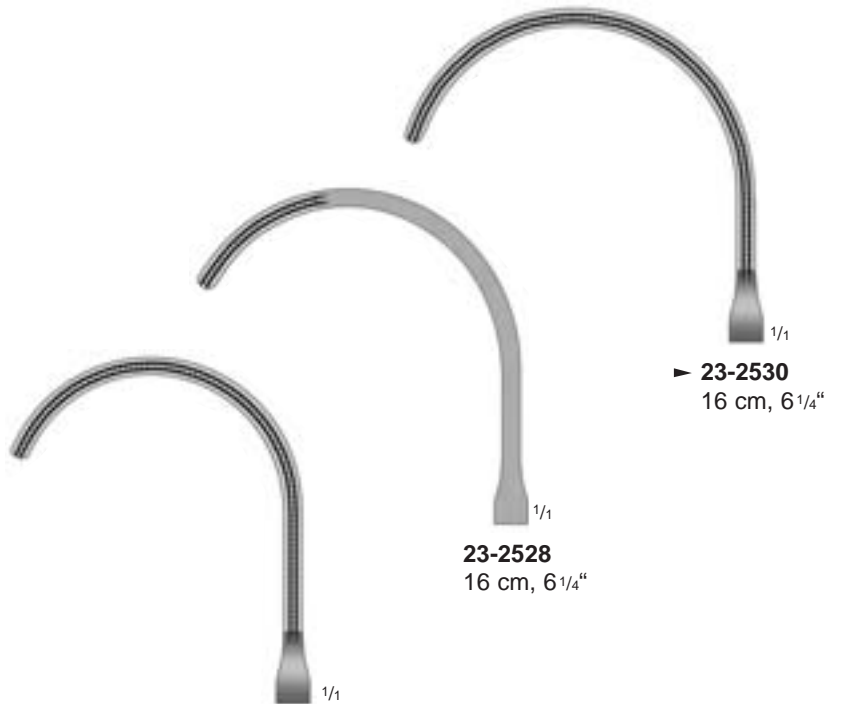

23-2529
 16 cm, 6¹/₄"

23-2528
 16 cm, 6¹/₄"

▶ **23-2530**
 16 cm, 6¹/₄"



ATRAUMATIC-GRIP Anastomosenklemmen mit DE BAKEY-Zahnung
 ATRAUMATIC-GRIP Anastomosis Clamps with Toothing DE BAKEY
 ATRAUMATIC-GRIP Pinzas-clamps para anastomosis con dentado DE BAKEY
 ATRAUMATIC-GRIP Pincas-clamps à anastomose avec denture DE BAKEY
 ATRAUMATIC-GRIP Pinze per anastomosi con dentatura DE BAKEY

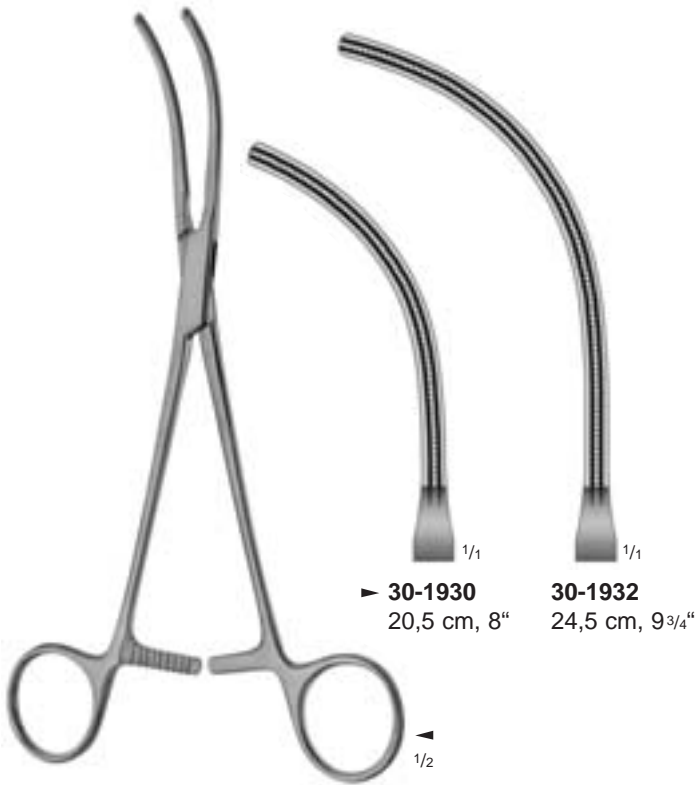

▶ **30-1930** 20,5 cm, 8"
30-1932 24,5 cm, 9³/₄"

GLOVER
30-1930
 - **30-1932**

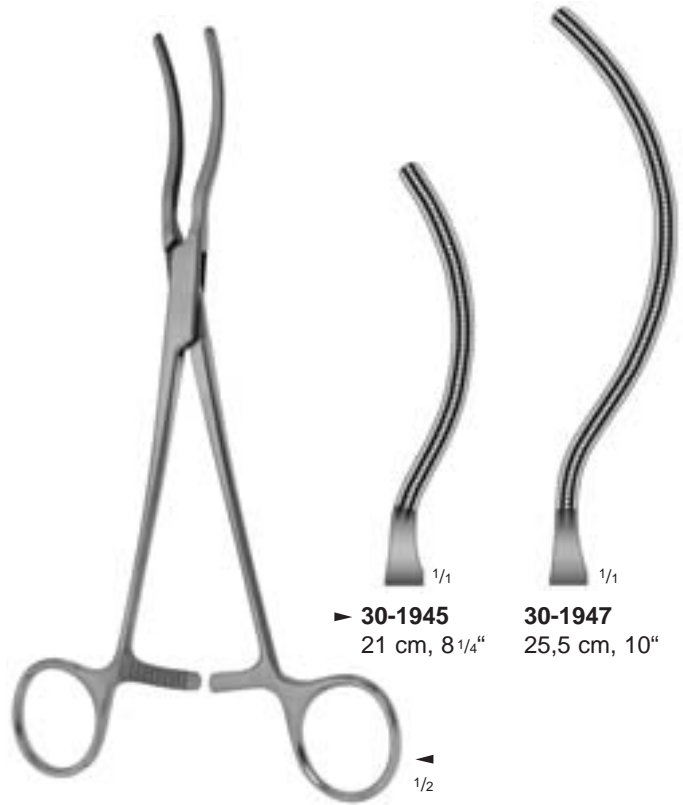

▶ **30-1945** 21 cm, 8¹/₄"
30-1947 25,5 cm, 10"

GLOVER
30-1945
 - **30-1947**

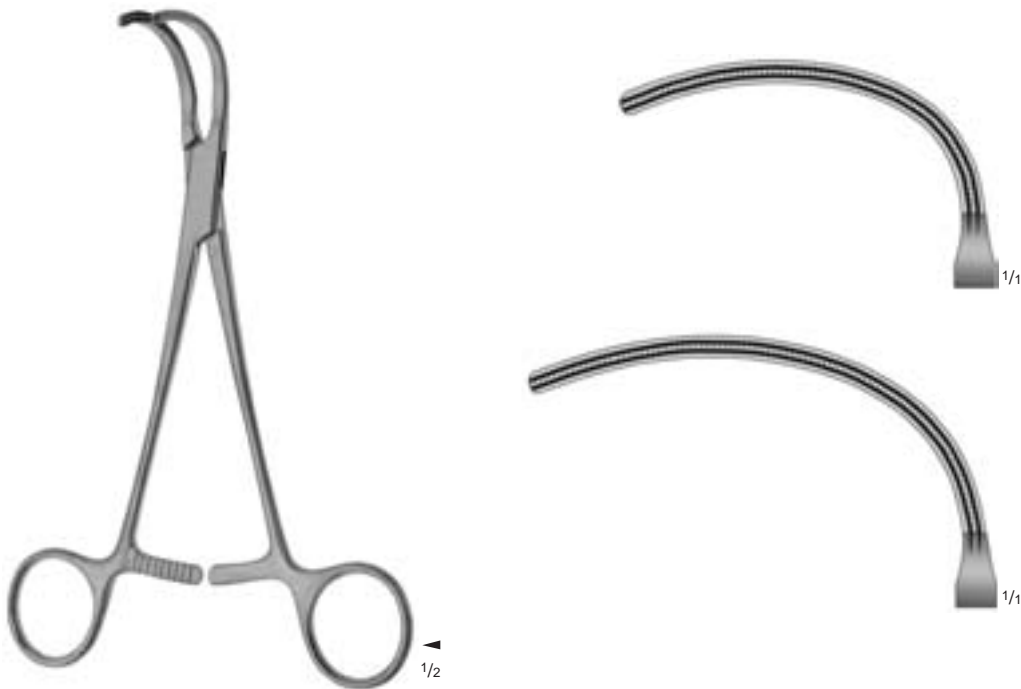

▶ **30-1940** 18 cm, 7"

30-1942 22 cm, 8³/₄"

GLOVER
30-1940
 - **30-1942**

ATRAUMATIC-GRIP Aorta-Aneurysmaklemmen mit DE BAKEY-Zahnung
ATRAUMATIC-GRIP Aorta-Aneurysma Clamps with Toothing DE BAKEY
ATRAUMATIC-GRIP Pinzas-clamps para aneurisma de aorta con dentado DE BAKEY
ATRAUMATIC-GRIP Pincas-clamps pour anévrisme de l'aorte avec denture DE BAKEY
ATRAUMATIC-GRIP Pinze per l'aneurisma dell'aorta aorta con dentatura DE BAKEY



für temporären Verschluss der Iliac-Arterie
 for temporary occlusion of the arteria iliaca
 para la oclusión temporal de la arteria iliaca
 pour occlusion temporaire de l'artere iliaque
 per l'occlusione temporanea dell'arteria iliaca

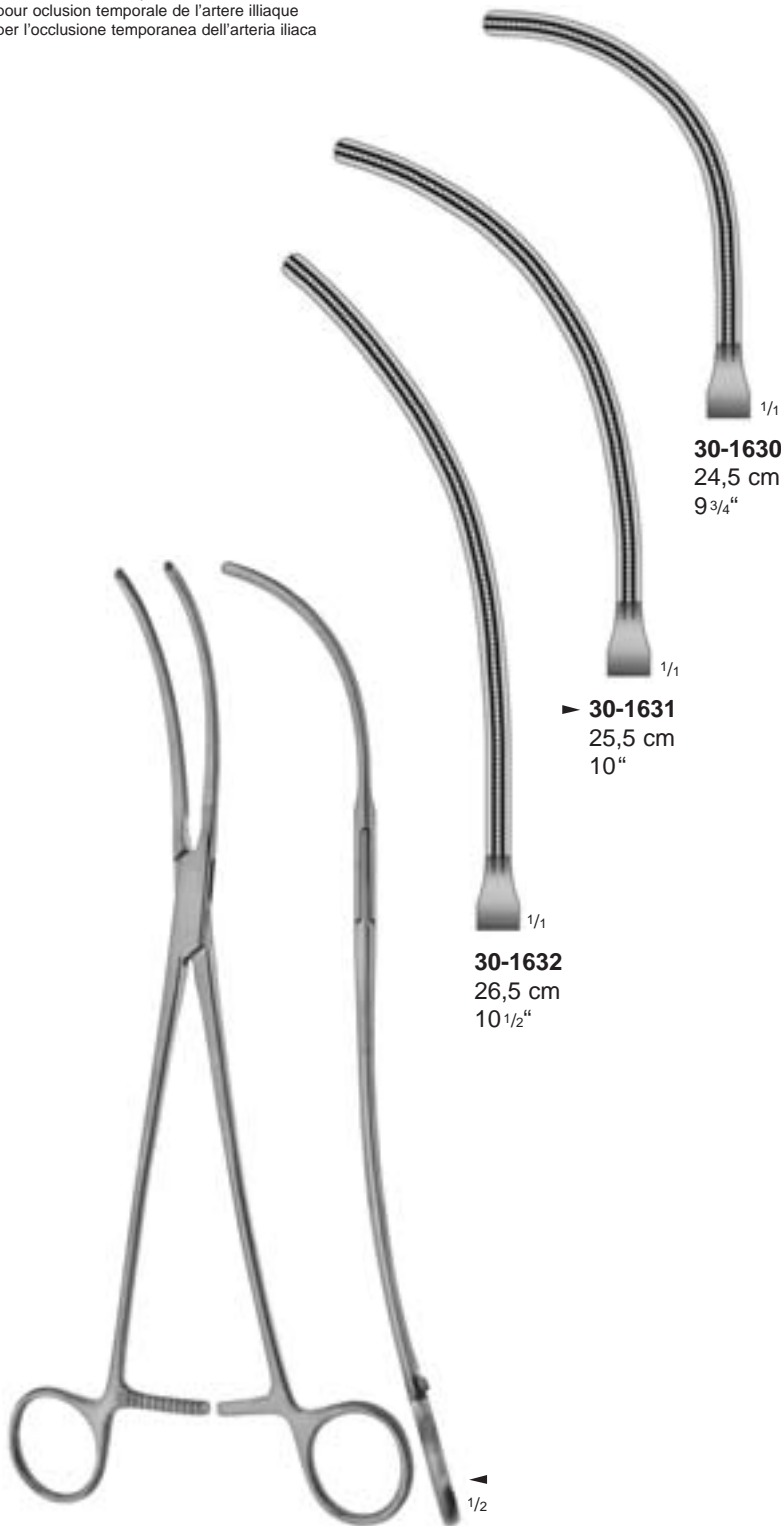

DE BAKEY-BAHNSON
 30-1630
 - 30-1632

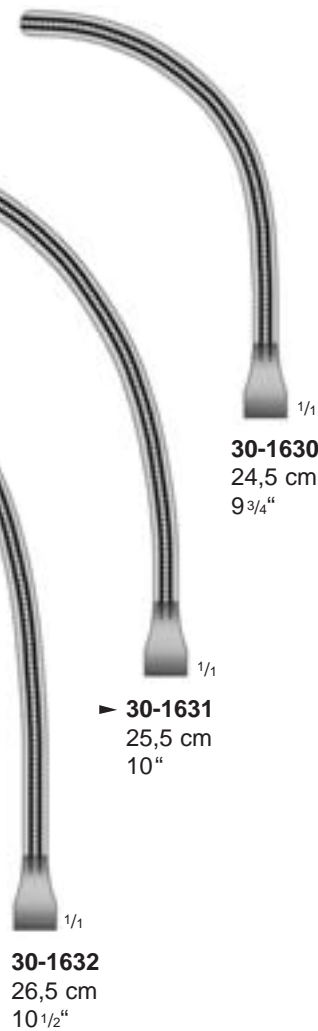

▶ 30-1631
 25,5 cm
 10"

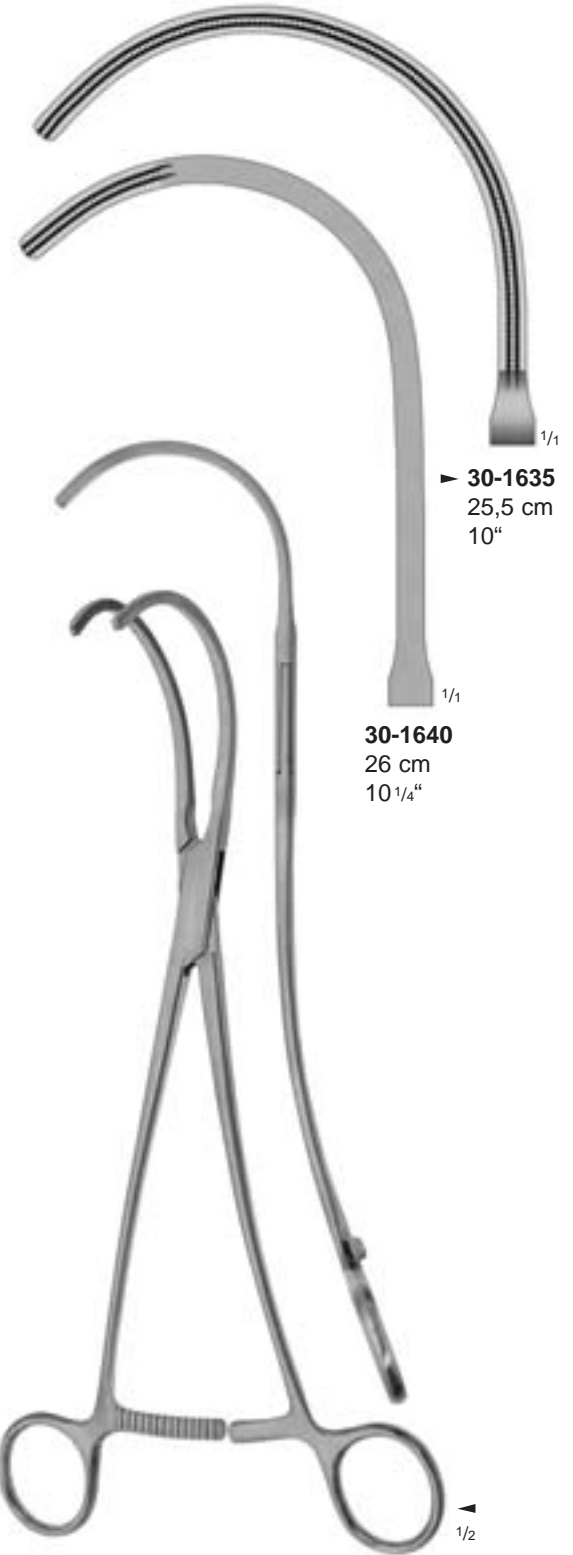

DE BAKEY
 30-1635
 - 30-1640

▶ 30-1635
 25,5 cm
 10"

30-1640
 26 cm
 10 1/4"



ATRAUMATIC-GRIP Aorta-Aneurysmaklemmen mit DE BAKEY-Zahnung
 ATRAUMATIC-GRIP Aorta-Aneurysma Clamps with Toothing DE BAKEY
 ATRAUMATIC-GRIP Pinzas-clamps para aneurisma de aorta con dentado DE BAKEY
 ATRAUMATIC-GRIP Pincas-clamps pour anévrisme de l'aorte avec denture DE BAKEY
 ATRAUMATIC-GRIP Pinze per l'aneurisma dell'aorta con dentatura DE BAKEY



30-1711
 25,5 cm
 10"

▶ **30-1713**
 25,5 cm
 10"

30-1715
 23,5 cm
 9 1/4"

DE BAKEY-CRAFOORD
30-1711
 - **30-1715**

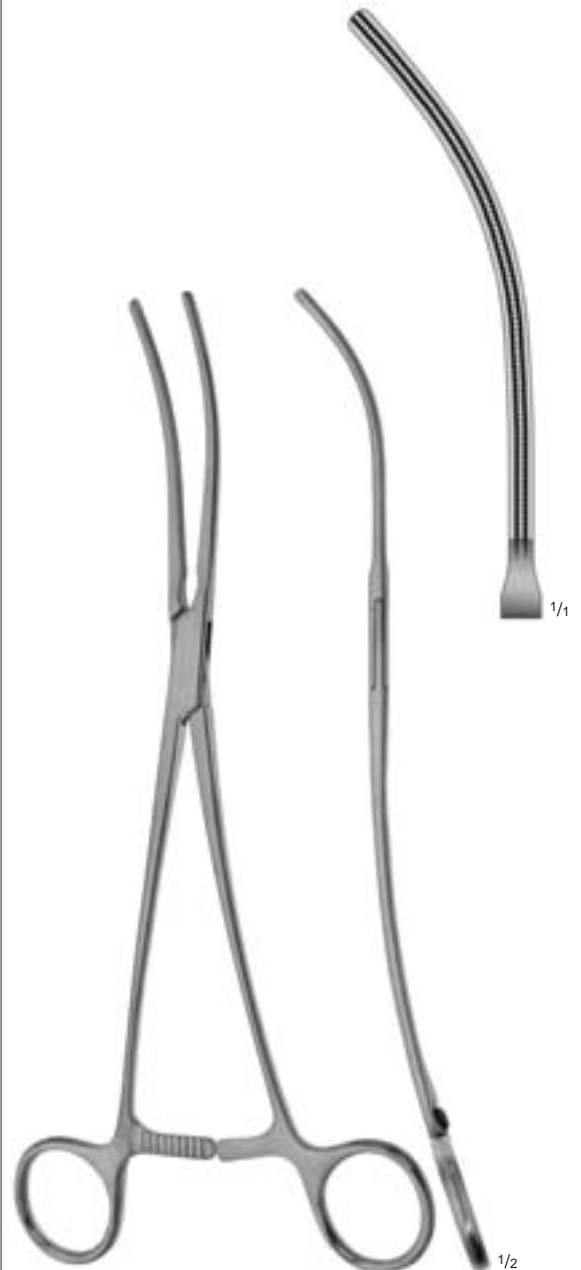

DE BAKEY-CRAFOORD
30-1719
 26 cm, 10 1/4"

ATRAUMATIC-GRIP Aorta-Aneurysmaklemmen mit DE BAKEY-Zahnung
 ATRAUMATIC-GRIP Aorta-Aneurysma Clamps with Toothing DE BAKEY
 ATRAUMATIC-GRIP Pinzas-clamps para aneurisma de aorta con dentado DE BAKEY
 ATRAUMATIC-GRIP Pincas-clamps pour anévrisme de l'aorte avec denture DE BAKEY
 ATRAUMATIC-GRIP Pinze per l'aneurisma dell'aorta con dentatura DE BAKEY

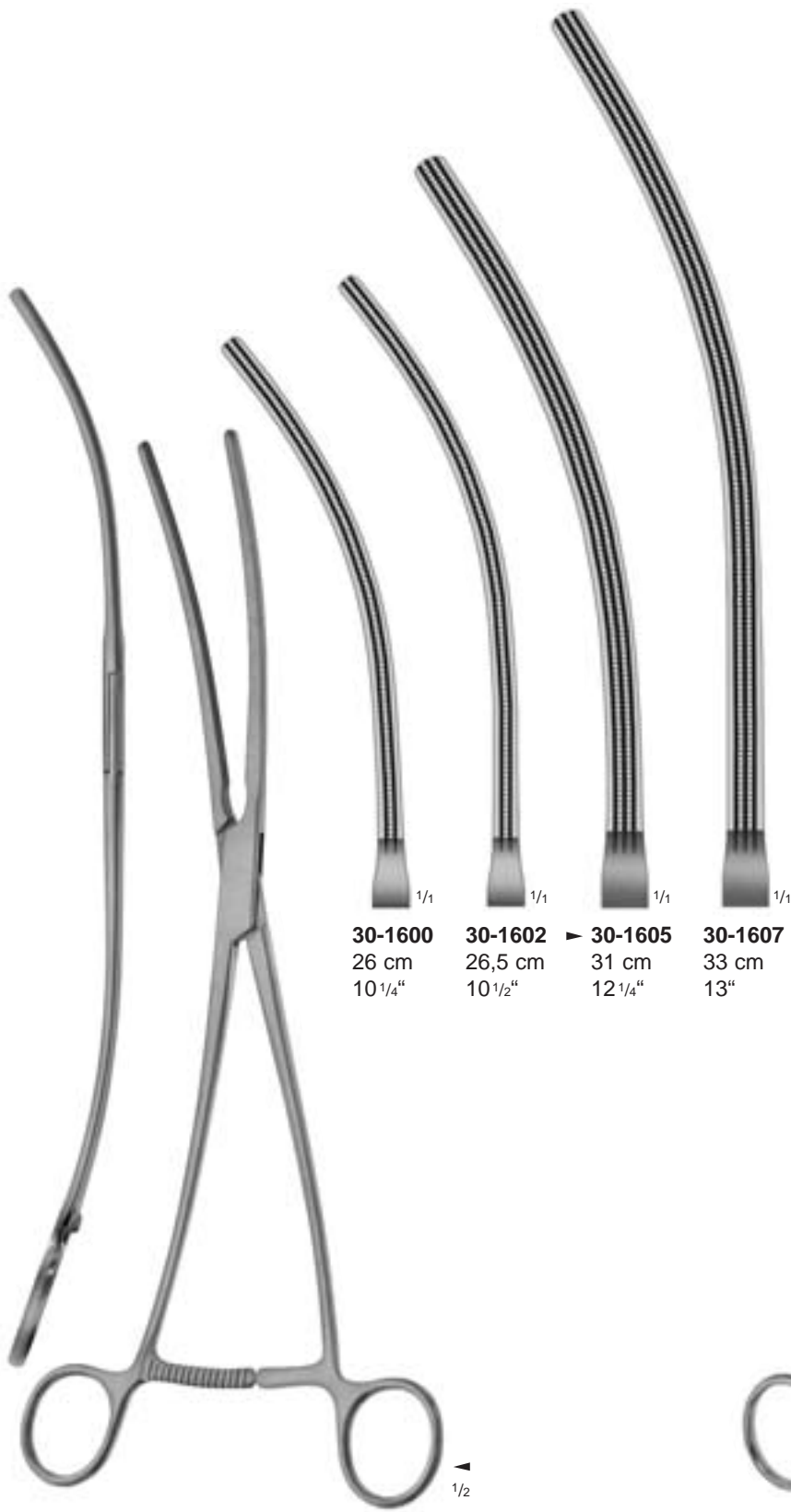

30-1600	30-1602	▶ 30-1605	30-1607
26 cm	26,5 cm	31 cm	33 cm
10 1/4"	10 1/2"	12 1/4"	13"

DE BAKEY
30-1600
 - **30-1607**

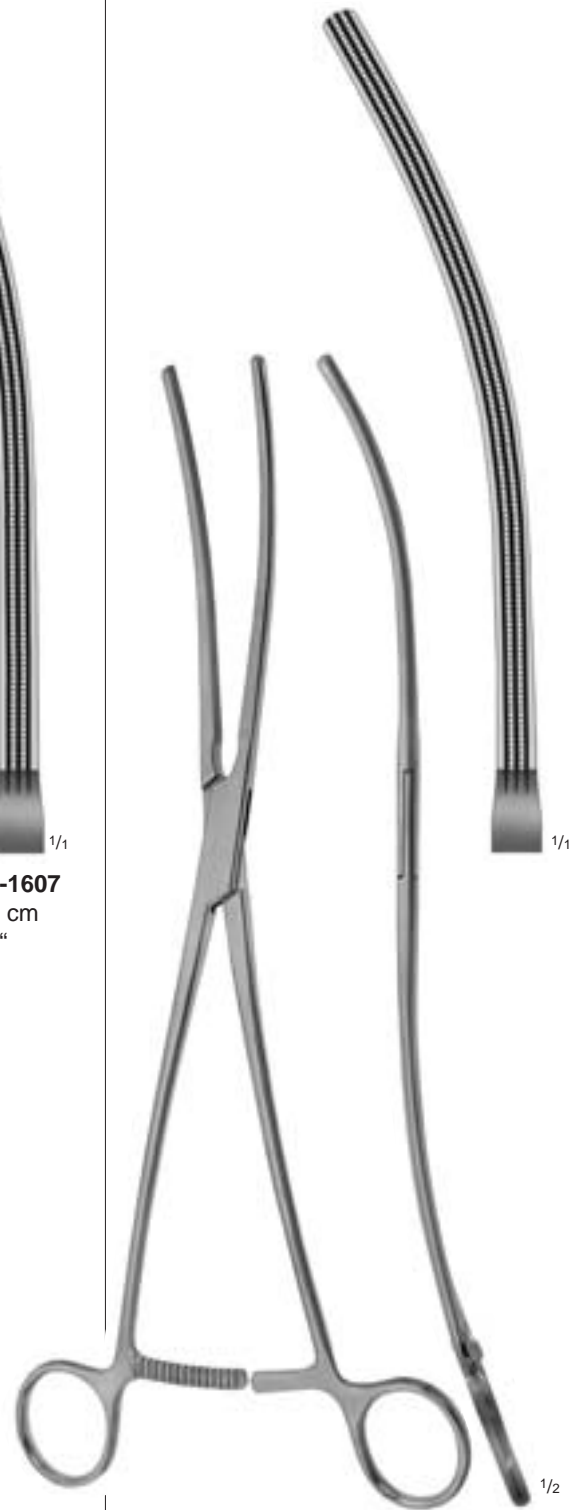

DE BAKEY
30-1610
 30,5 cm, 12"



ATRAUMATIC-GRIP Aorta-Anastomosenklemmen mit DE BAKEY-Zahnung
ATRAUMATIC-GRIP Aorta-Anastomosis Clamps with Toothing DE BAKEY
ATRAUMATIC-GRIP Pinzas-clamps para anastomosis de aorta con dentado DE BAKEY
ATRAUMATIC-GRIP Pincas-clamps à anastomose de l'aorte avec denture DE BAKEY
ATRAUMATIC-GRIP Pinze per l'anastomosi dell'aorta con dentatura DE BAKEY



1/1



1/1



1/2

WEBER
30-1642
25 cm, 10"

links
left
izquierda
à gauche
sinistra



1/2

WEBER
30-1643
25 cm, 10"

rechts
right
derecha
à droite
destra

ATRAUMATIC-GRIP Aorta-Anastomosenklemmen mit DE BAKEY-Zahnung
 ATRAUMATIC-GRIP Aorta-Anastomosis Clamps with Toothing DE BAKEY
 ATRAUMATIC-GRIP Pinzas-clamps para anastomosis de aorta con dentado DE BAKEY
 ATRAUMATIC-GRIP Pincas-clamps à anastomose de l'aorte avec denture DE BAKEY
 ATRAUMATIC-GRIP Pinze per l'anastomosi dell'aorta con dentatura DE BAKEY



▶ **30-1657**
19,5 cm, 7³/₄"

30-1658
20 cm, 8"

LAMBERT-KAY
30-1657
 - **30-1658**



▶ **30-1655**
22,5 cm, 9"

30-1656
23 cm, 9"

WYLIE
30-1655
 - **30-1656**



ATRAUMATIC-GRIP Vena-Cava-Klemmen mit DE BAKEY-Zahnung
 ATRAUMATIC-GRIP Vena-Cava Clamps with Toothing DE BAKEY
 ATRAUMATIC-GRIP Pinzas-clamps para vena cava con dentado DE BAKEY
 ATRAUMATIC-GRIP Pincas-clamps pour veine cave avec denture DE BAKEY
 ATRAUMATIC-GRIP Pinze per vena cava con dentatura DE BAKEY



DE BAKEY-BECK
 30-1886
 - 30-1887

1/2



► 30-1886
 19 cm, 7 1/2"

30-1887
 21 cm, 8 1/4"



1/2



1/1

CALNE
 30-1800
 27 cm, 10 3/4"

Die Spezialklemme ermöglicht ein den anatomischen Verhältnissen angepaßtes Anlegen an der Vena cava inferior oberhalb der Leber. Die Verriegelung am oberen Ende des Mauls hält nach dem Anlegen der Klemme die Maulteile fest zusammen und verhindert somit ein Ausschlüpfen der mit dem Zwerchfell abgeklemmten Vena cava inferior.

The special clamp makes it possible to clamp the vena cava inferior above the liver according to the anatomic conditions. The lock at the upper end of the jaws fixes firmly the parts of the jaws of the clamp after it is placed, thus impeding the vena cava inferior - clamped together with diaphragm - from slipping out.

Se facilita la colocación amoldada de la vena cava inferior sobre el hígado, por causa de la forma anatómica de la pinza clamp especial. El cierre a la punta de la mandíbula sujeta firmamente la pinza clamp y evita que se escape la vena cava inferior con el diafragma.

Le clamp spécial permet un clampage atraumatique de la Veine Cave inférieure au-dessus du foie, adapté aux conditions anatomiques. L'anneau terminal permet de maintenir les mors joints évitant ainsi le glissement de la Veine Cave supérieure clampée avec le diaphragme.

La pinza permette di clampare la Vena Cava inferiore sopra il fegato data la sua forma anatomica. Il fermo nella parte superiore blocca saldamente le estremità della pinza impedendo che la Vena Cava inferiore scivoli via.

ATRAUMATIC-GRIP Präparier- und Ligaturklemmen mit DE BAKEY-Zahnung

ATRAUMATIC-GRIP Dissecting and Ligature Forceps with Toothing DE BAKEY

ATRAUMATIC-GRIP Pinzas para disección y ligaduras con dentado DE BAKEY

ATRAUMATIC-GRIP Pincès à disséquer et à ligatures avec denture DE BAKEY

ATRAUMATIC-GRIP Pinze per dissezione e legature con dentatura DE BAKEY

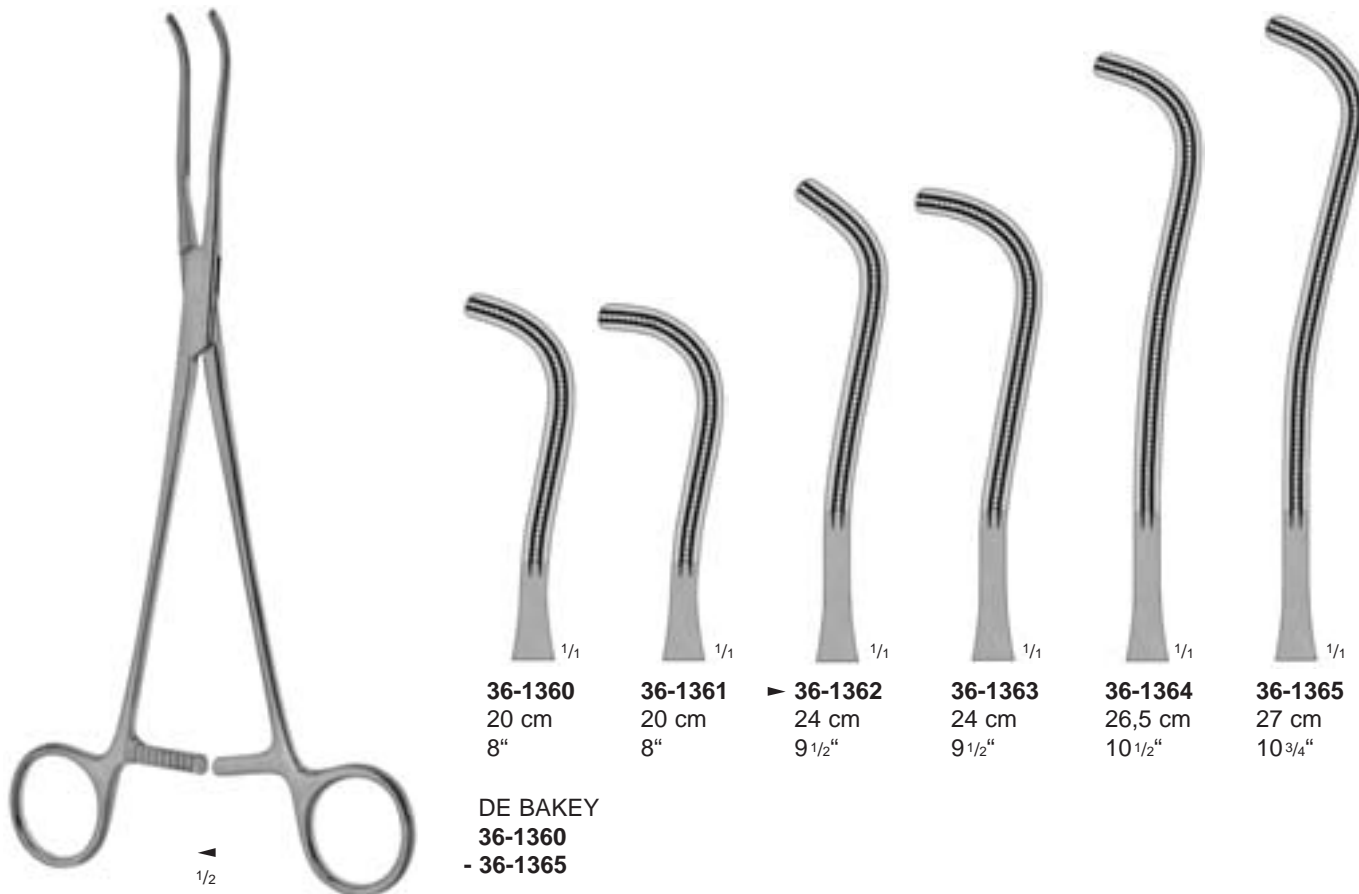
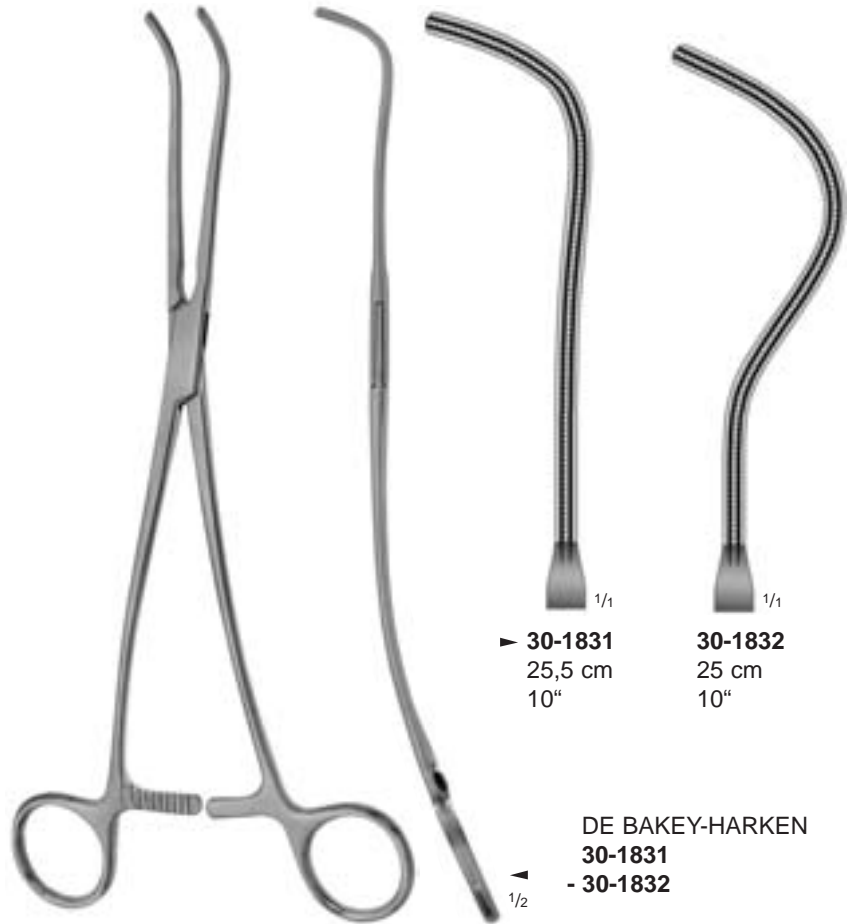
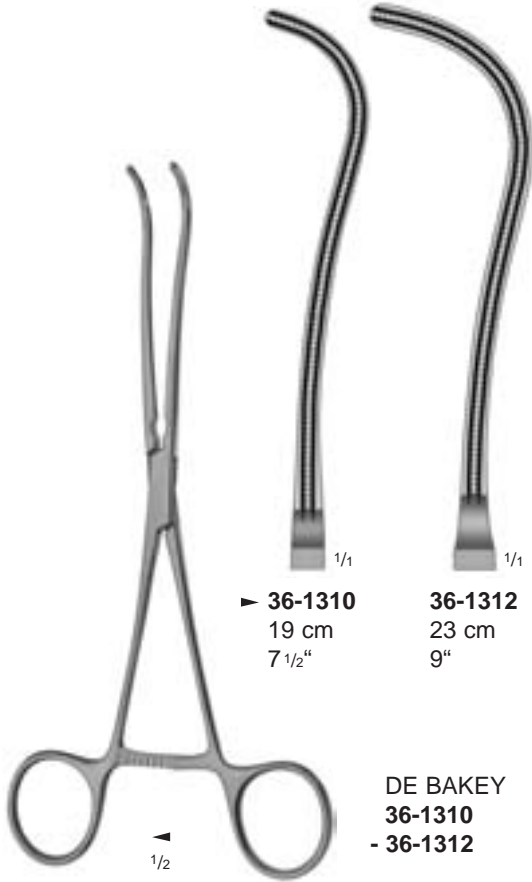



ATRAUMATIC-GRIP Bronchusklemmen mit DE BAKEY-Zahnung
ATRAUMATIC-GRIP Bronchus Clamps with Toothing DE BAKEY
ATRAUMATIC-GRIP Pinzas-clamps bronquiales con dentado DE BAKEY
ATRAUMATIC-GRIP Pincas-clamps à bronches avec denture DE BAKEY
ATRAUMATIC-GRIP Pinze per bronchi con dentatura DE BAKEY



LEES
36-1374
21 cm, 8¹/₄"



LEES
36-1370
22 cm, 8³/₄"



LEES
36-1372
24,5 cm, 9³/₄"

ATRAUMATIC-GRIP Mehrzweckklemmen mit DE BAKEY-Zahnung
 ATRAUMATIC-GRIP Multi-Purpose Clamps with Toothing DE BAKEY
 ATRAUMATIC-GRIP Pinzas-clamps de varias aplicaciones con dentado DE BAKEY
 ATRAUMATIC-GRIP Pincas-clamps universelles avec denture DE BAKEY
 ATRAUMATIC-GRIP Pinze multiuso con dentatura DE BAKEY

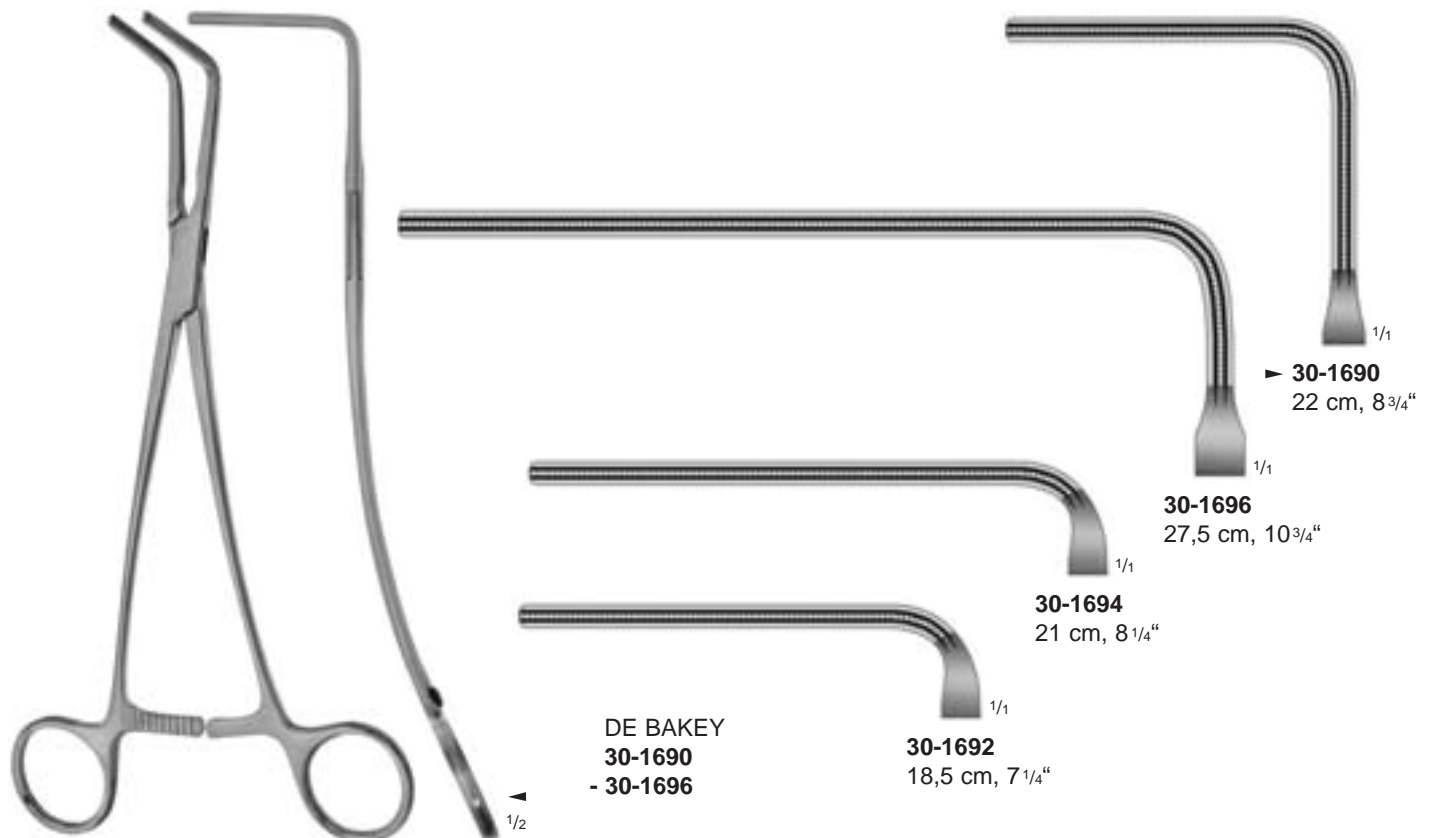
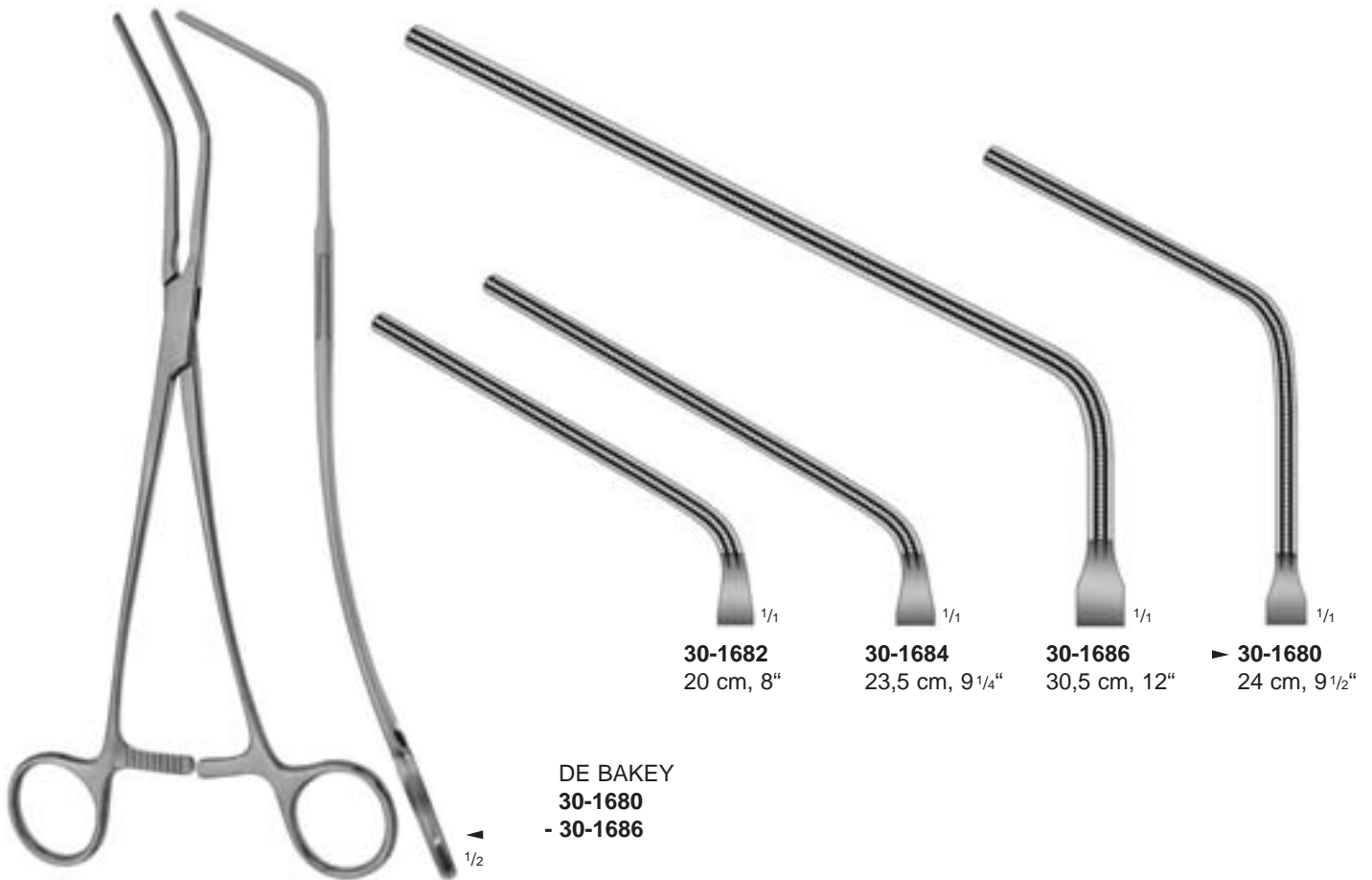



ATRAUMATIC-GRIP Mehrzweckklemmen mit DARDIK-Zahnung

ATRAUMATIC-GRIP Multi-Purpose Clamps with Toothing DARDIK

ATRAUMATIC-GRIP Pinzas-clamps de varias aplicaciones con dentado DARDIK

ATRAUMATIC-GRIP Pincers-clamps universelles avec denture DARDIK

ATRAUMATIC-GRIP Pinze multiuso con dentatura DARDIK



1/1

30-1720
15 cm, 6"



1/1

15 °
30-1722
15 cm, 6"



1/1

30 °
30-1724
15 cm, 6"



1/1

45 °
30-1726
14,5 cm, 5 3/4"



1/1

90 °
30-1728
13 cm, 5 1/8"

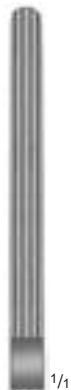

1/1

30-1730
16,5 cm, 6 1/2"



1/1

15 °
30-1732
16,5 cm, 6 1/2"



1/1

▶ 30-1734
16 cm, 6 1/4"

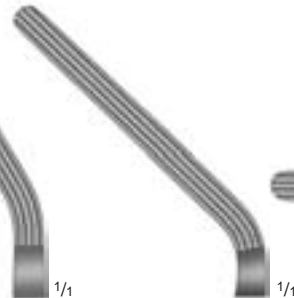

1/1

45 °
30-1736
16 cm, 6 1/4"



1/1

90 °
30-1738
13,5 cm, 5 1/4"



1/2

DARDIK
30-1720
- **30-1738**

ATRAUMATIC-GRIP Gefäßklemmen mit COOLEY-Zahnung
 ATRAUMATIC-GRIP Vascular Clamps with Toothing COOLEY
 ATRAUMATIC-GRIP Pinzas-clamps vasculares con dentado COOLEY
 ATRAUMATIC-GRIP Pincas vasculaires avec denture COOLEY
 ATRAUMATIC-GRIP Pinze vascolari con dentatura COOLEY



für Kinderchirurgie • for pediatric surgery • para la pediatría • pour chirurgie pédiatrique • per chirurgia pediatrica

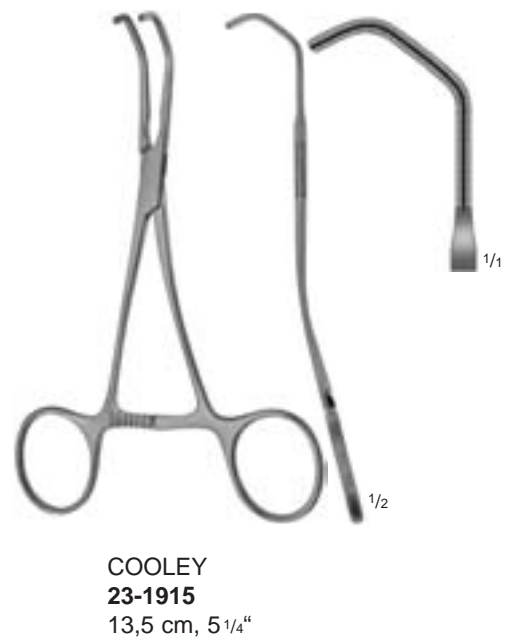
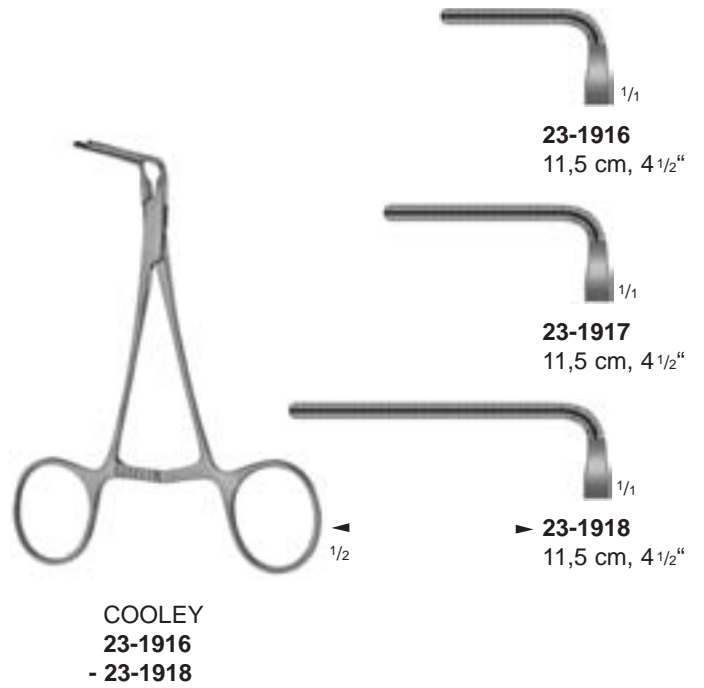
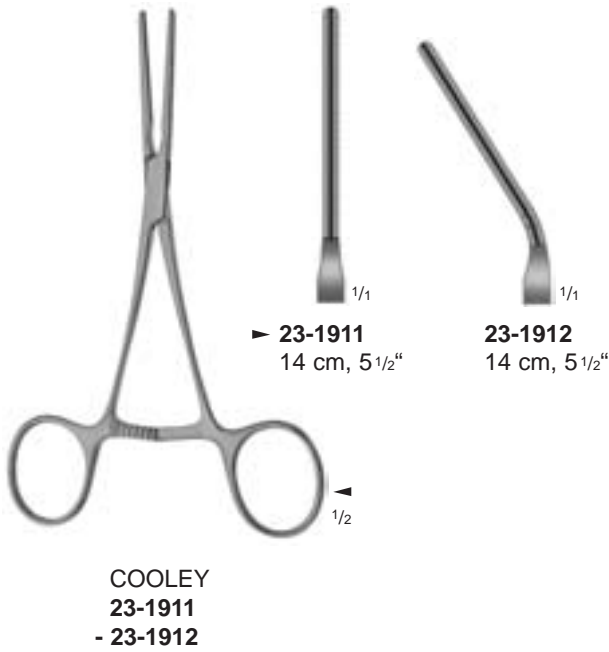



ATRAUMATIC-GRIP Gefäßklemmen mit COOLEY-Zahnung
 ATRAUMATIC-GRIP Blood Vessel Clamps with Toothing COOLEY
 ATRAUMATIC-GRIP Pinzas-clamps para vasos con dentado COOLEY
 ATRAUMATIC-GRIP Pinces vasculaires avec denture COOLEY
 ATRAUMATIC-GRIP Pinze vascolari con dentatura COOLEY



COOLEY
30-2158
 12,5 cm, 5"

Bulldogklemme
 Bulldog clamp
 Clamp Bulldog
 Clamp Bulldog
 Pinza Bulldog

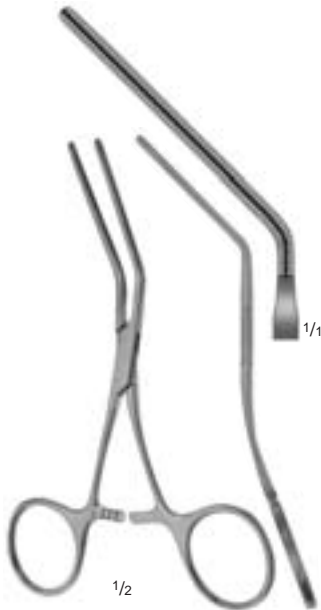

COOLEY
30-2154
 12,5 cm, 5"

Bulldogklemme
 Bulldog clamp
 Clamp Bulldog
 Clamp Bulldog
 Pinza Bulldog



COOLEY
23-2000
 15,5 cm, 6"

Patent-Ductusklemme
 Patent ductus clamp
 Pinza patente de conducto
 Clamp patent, ductus droit
 Clamp patent per dotto



COOLEY
23-2005
 15 cm, 6"

Patent-Ductusklemme
 Patent ductus clamp
 Pinza patente de conducto
 Clamp patent, ductus droit
 Clamp patent per dotto



COOLEY
23-1925
- 23-1935



► **23-1925**
 16 cm, 6 1/4"



23-1930
 15,5 cm, 6"



23-1935
 14 cm, 5 1/2"

Mehrzweckklemmen • Multi-purpose clamps • Pinzas-clamps de varias aplicaciones • Pincers-clamps universelles • Pinze multiuso

ATRAUMATIC-GRIP Coarctationsklemmen mit COOLEY-Zahnung

ATRAUMATIC-GRIP Coarctation Clamps with Toothing COOLEY

ATRAUMATIC-GRIP Pinzas-clamps para coarctación con dentado COOLEY

ATRAUMATIC-GRIP Pincès-clamps pour coarctation avec denture COOLEY

ATRAUMATIC-GRIP Pinze per coartazione con dentatura COOLEY



COOLEY
23-2025
16,5 cm, 6 1/2"



COOLEY
23-2030
16 cm, 6 1/4"



COOLEY
23-2035
17 cm, 6 3/4"

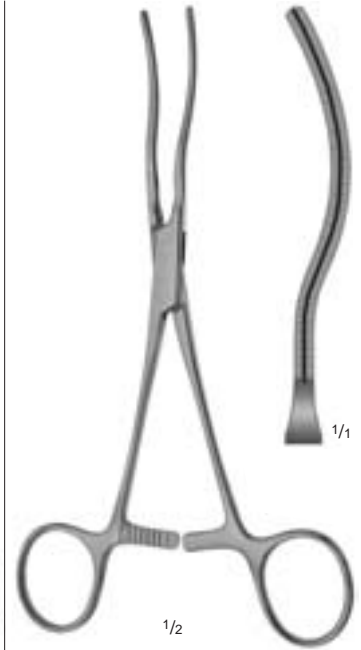

COOLEY
23-2036
17 cm, 6 3/4"

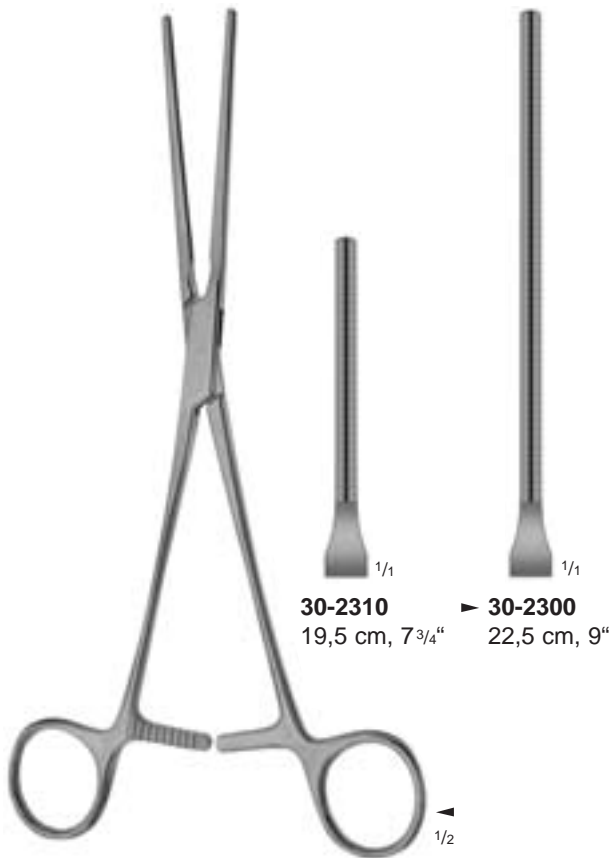

COOLEY
30-2300
- **30-2310**

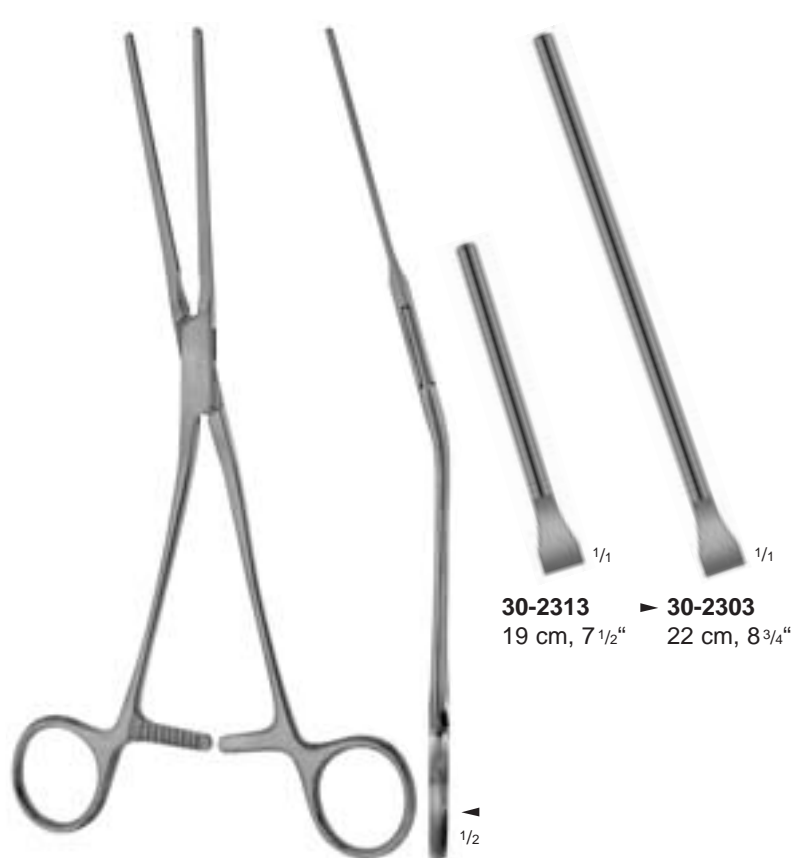

COOLEY
30-2303
- **30-2313**



ATRAUMATIC-GRIP Gefäßklemmen mit COOLEY-Zahnung
 ATRAUMATIC-GRIP Vascular Clamps with Toothing COOLEY
 ATRAUMATIC-GRIP Pinzas-clamps vasculares con dentado COOLEY
 ATRAUMATIC-GRIP Pinces vasculaires avec denture COOLEY
 ATRAUMATIC-GRIP Pinze vascolari con dentatura COOLEY



COOLEY
30-2335
 18 cm, 7"
Peripheralklemme
 Peripheral vascular clamp
 Pinza-clamp para vasos periféricos
 Pince-clamp périphérique
 Pinza per vasi periferici



COOLEY
30-2690
 - **30-2691**
Iliaca Klemmen
 Iliac clamps
 Pinzas-clamps para iliaca
 Pinces-clamps iliaque
 Pinze iliaca



COOLEY
23-2090
 - **23-2092**

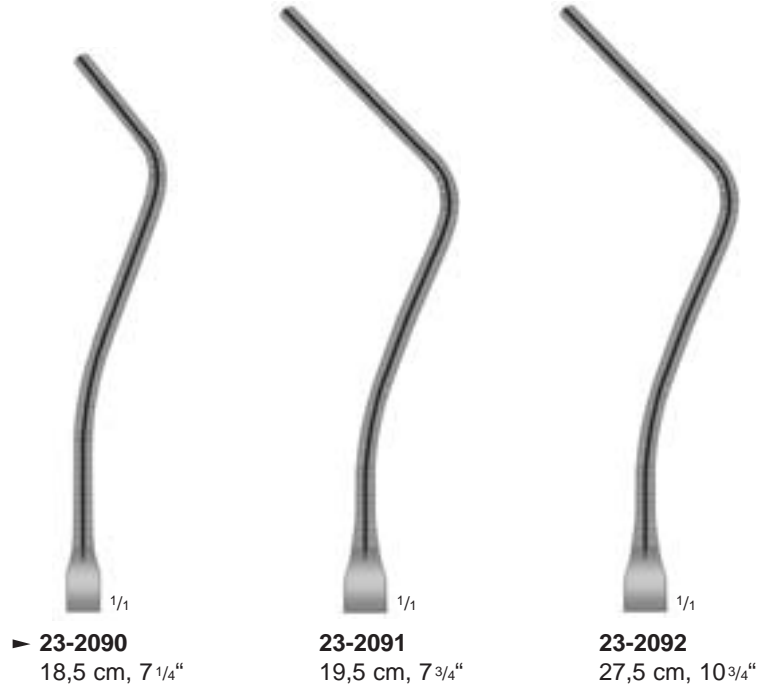

23-2090
 18,5 cm, 7 1/4"
23-2091
 19,5 cm, 7 3/4"
23-2092
 27,5 cm, 10 3/4"

Nierenarterienklemmen, auch für Schlüsselbein- und Halsschlagader
 Renal artery clamps, also used for subclavian and carotid artery
 Pinzas-clamps para las arterias renales, también se usan para la arteria clavicula y carótida
 Pinces hémostatiques rénales, également utilisées pour l'artère claviculaire et la carotide
 Pinze emostatiche per arterie renale, impiegate anche per l'arteria succlavia e la carotide

ATRAUMATIC-GRIP Anastomosenklemmen mit COOLEY-Zahnung

ATRAUMATIC-GRIP Anastomosis Clamps with Toothing COOLEY

ATRAUMATIC-GRIP Pinzas-clamps para anastomosis con dentado COOLEY

ATRAUMATIC-GRIP Pinces-clamps à anastomose avec denture COOLEY

ATRAUMATIC-GRIP Pinze per anastomosi con dentatura COOLEY

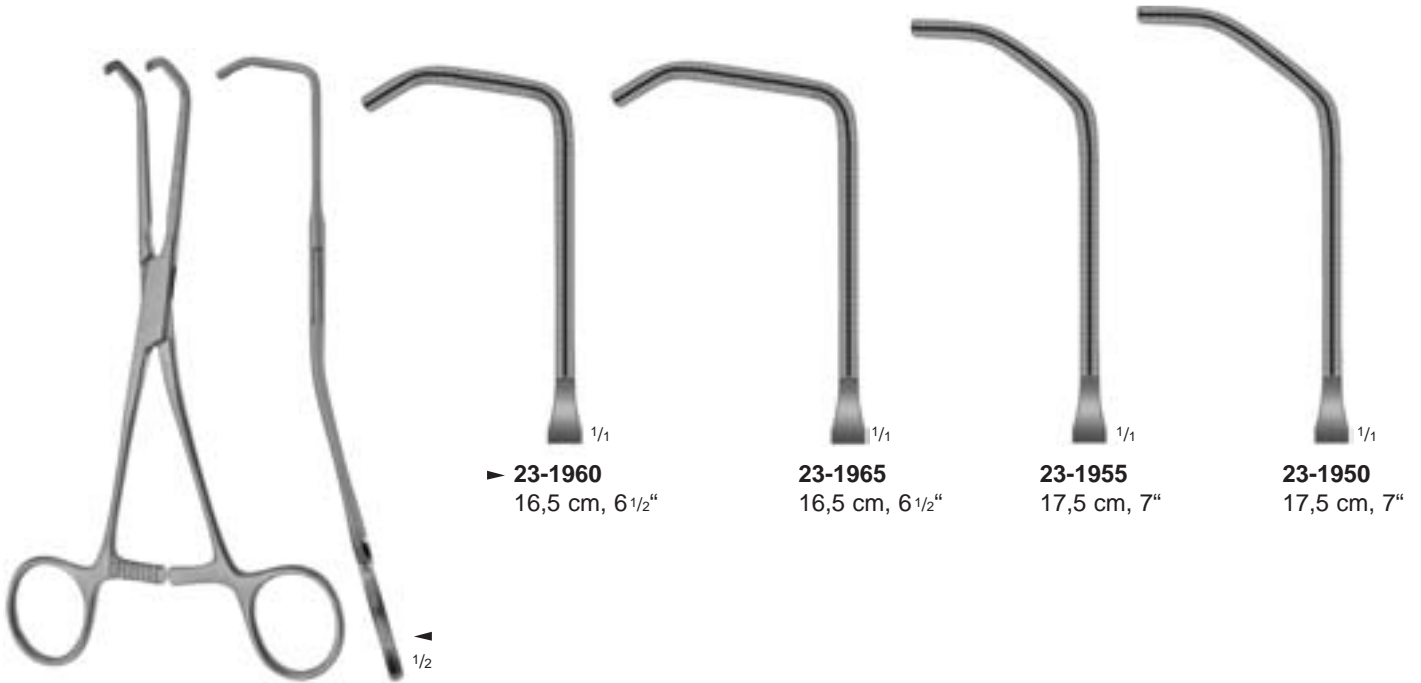

COOLEY-REYNOLDS
23-1950
- 23-1965

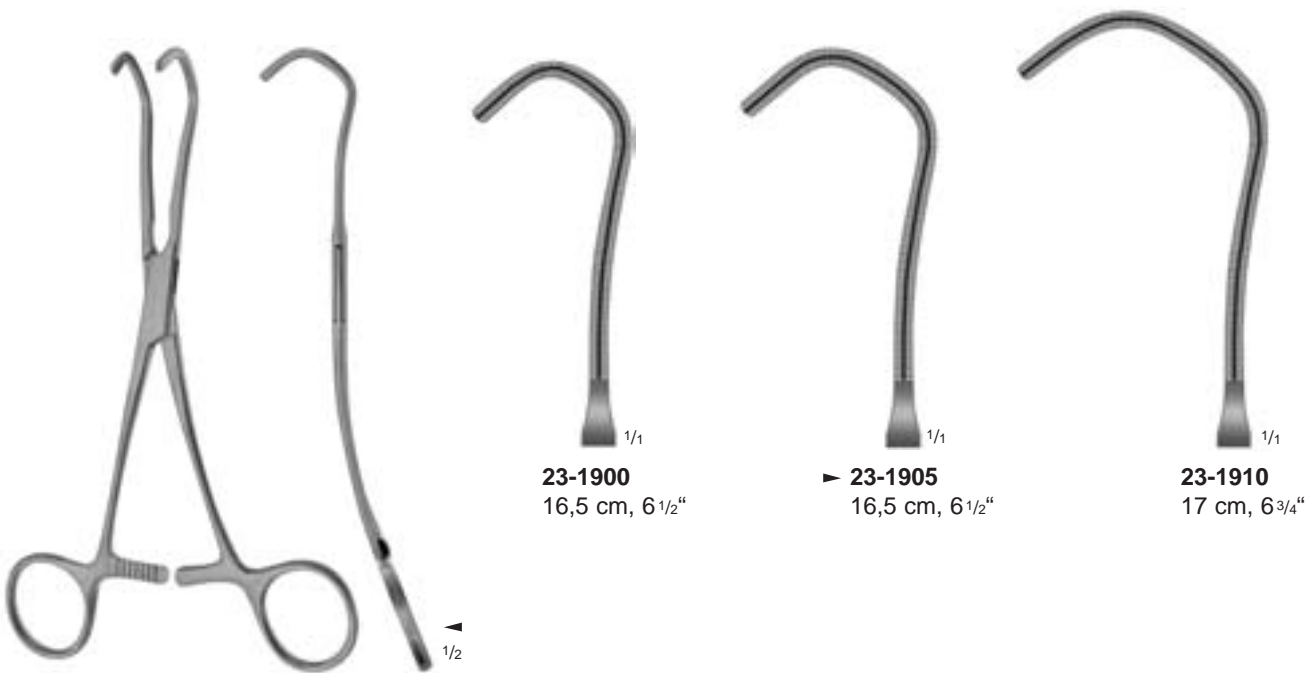

COOLEY-DERRA
23-1900
- 23-1910



ATRAUMATIC-GRIP Anastomosenklemmen mit COOLEY-Zahnung

ATRAUMATIC-GRIP Anastomosis Clamps with Toothing COOLEY

ATRAUMATIC-GRIP Pinzas-clamps para anastomosis con dentado COOLEY

ATRAUMATIC-GRIP Pinces-clamps à anastomose avec denture COOLEY

ATRAUMATIC-GRIP Pinze per anastomosi con dentatura COOLEY



COOLEY
23-1976
17 cm, 6³/₄"

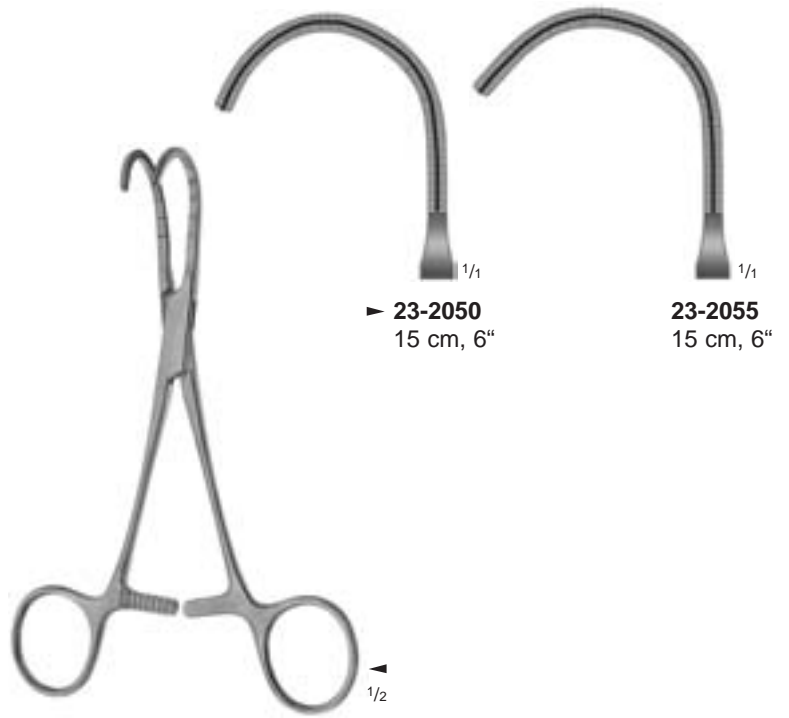

COOLEY-BECK
23-2050
- 23-2055

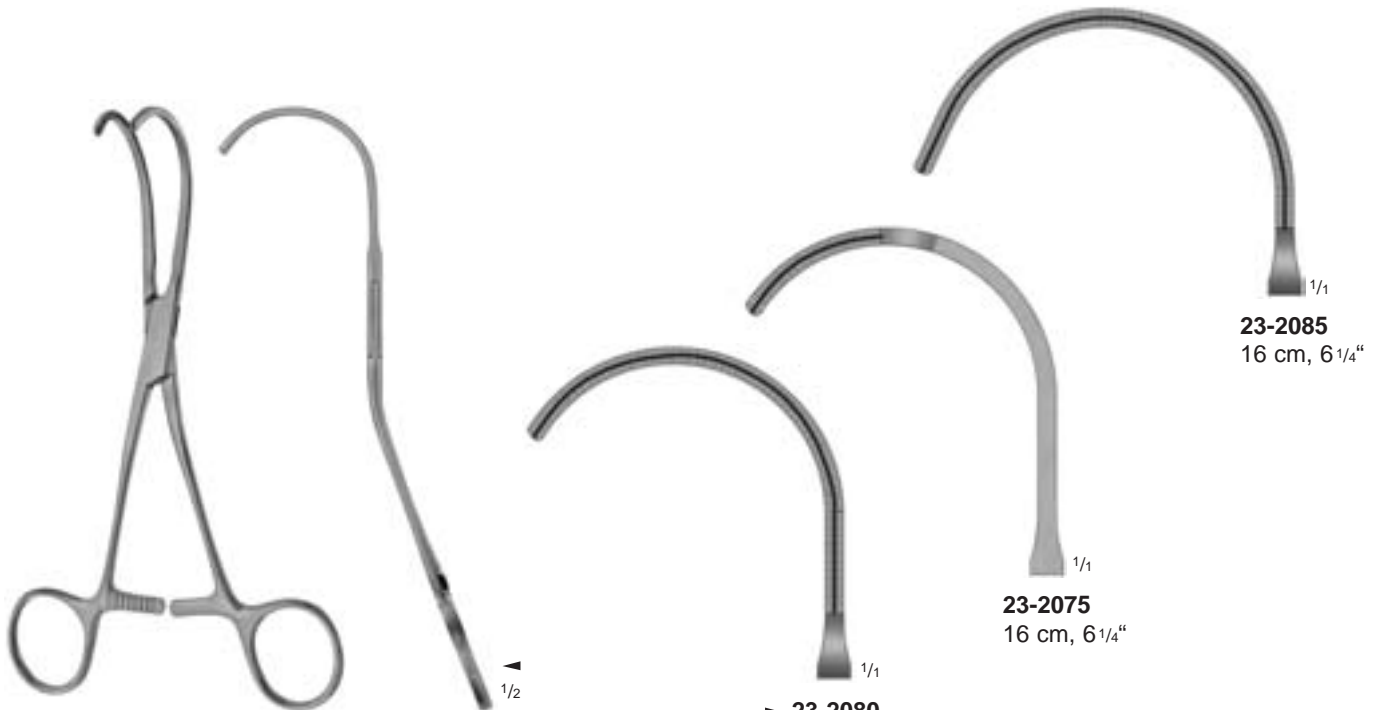

COOLEY
23-2075
- 23-2085

▶ 23-2080
16 cm, 6¹/₄"

23-2075
16 cm, 6¹/₄"

23-2085
16 cm, 6¹/₄"

ATRAUMATIC-GRIP Gefäßklemmen mit COOLEY-Zahnung
 ATRAUMATIC-GRIP Vascular Clamps with Toothing COOLEY
 ATRAUMATIC-GRIP Pinzas-clamps vasculares con dentado COOLEY
 ATRAUMATIC-GRIP Pincas vasculaires avec denture COOLEY
 ATRAUMATIC-GRIP Pinze vascolari con dentatura COOLEY



COOLEY
30-2602
 26,5 cm, 10 1/2"

Aorta-Aneurysmaklemme
 Aortic aneurysma clamp
 Pinza-clamp para aneurisma de aorta
 Pince-clamp pour anévrisme de l'aorte
 Pinza per l'aneurisma dell'aorta



COOLEY
30-2695
 25 cm, 10"

Aortaklemme
 Aortic clamp
 Pinza-clamp para aorta
 Pince-clamp pour aorte
 Pinza per aorta



ATRAUMATIC-GRIP Gefäßklemmen mit COOLEY-Zahnung
 ATRAUMATIC-GRIP Vascular Clamps with Toothing COOLEY
 ATRAUMATIC-GRIP Pinzas-clamps vasculares con dentado COOLEY
 ATRAUMATIC-GRIP Pincas-vasculaires avec denture COOLEY
 ATRAUMATIC-GRIP Pinze vascolari con dentatura COOLEY



1/2

COOLEY
30-2660
 - **30-2668**

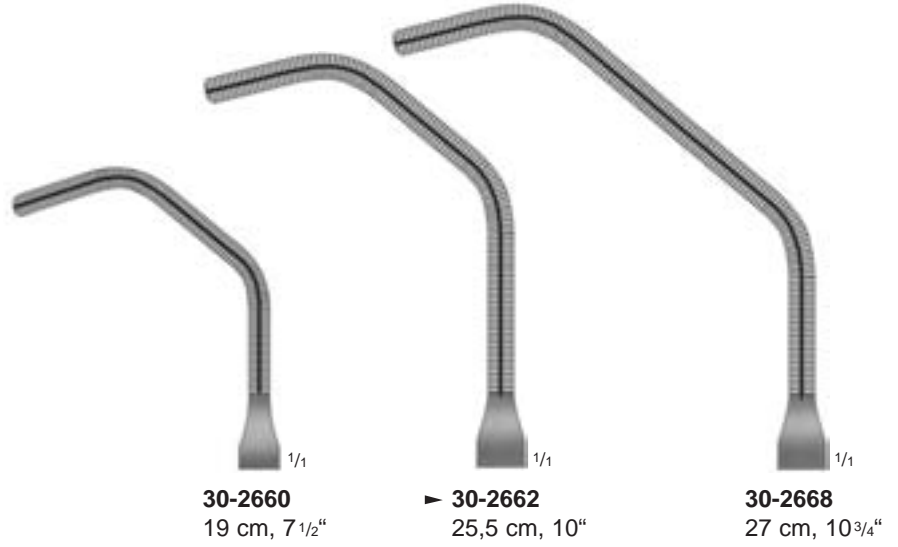

Gefäßklemmen für Tangential-Verschluss
 Tangential occlusion clamps
 Pinzas-clamps para oclusión tangencial
 Pincas-clamps pour occlusion tangentielle
 Pinze per occlusione tangenziale



1/2

COOLEY
30-2682
 - **30-2684**

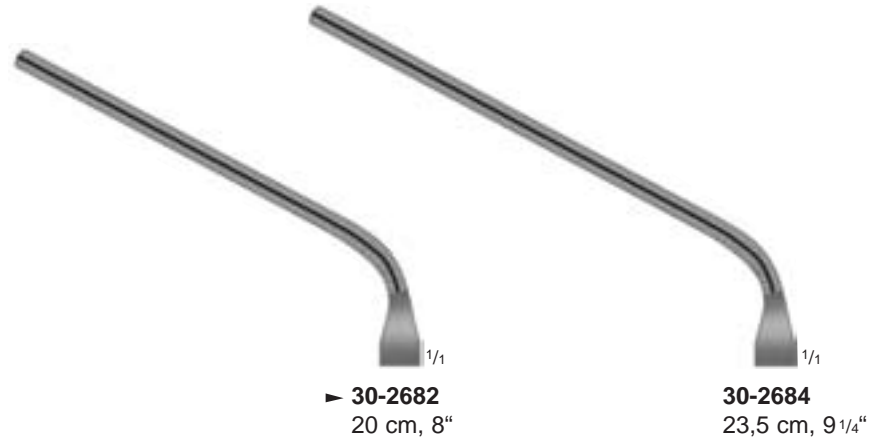

Mehrweckklemmen
 Multi-purpose clamps
 Pinzas-clamps de varias aplicaciones
 Pincas-clamps universelles
 Pinze multiuso

Halbflexible Gefäßklemmen

Semi Flexible Vascular Clamps

Pinzas-clamps vasculares semi-flexibles

Pinces vasculaires semi flexibles

Pinze vascolari semi flessibili



30-1950
12 mm

**Längsriefung,
für A. Carotis**

longitudinal
serration, for A. Carotis

Estriada longitudinal,
para A. Carotis

Striures longitudinales
pour artère carotide

fermo logitudinale,
per l'arteria carotide

1/1



30-1960
12 mm

**glatt
für A. Carotis**

smooth,
for A. Carotis

lisa,
para A. Carotis

lisse
pour artère carotide

liscia,
per l'arteria carotide

1/1



30-1952
20 mm

**Längsriefung,
für A. Poplitea**

longitudinal
serration, for A. Poplitea

Estriada longitudinal,
para A. Poplitea

Striures longitudinales
pour artère poplitée

fermo longitudinale
per l'arteria poplitea

1/1



30-1962
20 mm

**glatt
für A. Poplitea**

smooth,
for A. Poplitea

lisa,
para A. Poplitea

lisse
pour artère poplitée

liscia,
per l'arteria poplitea

1/1



30-1954
30 mm

**Längsriefung,
für A. Femoralis**

longitudinal
serration, for A. Femoralis

Estriada longitudinal,
para A. Femoralis

Striures longitudinales
pour artère fémorale

fermo longitudinale
per l'arteria femorale

1/1



30-1964
30 mm

**glatt
für A. Femoralis**

smooth,
for A. Femoralis

lisa,
para A. Femoralis

lisse
pour artère fémorale

liscia,
per l'arteria femorale

1/1



1/2

30-1950
- 30-1964
23 cm, 9"



Präparier- und Ligaturklemmen

Dissecting and Ligature Forceps
 Pinzas de disección y ligaduras
 Pincas à disséquer et à ligatures
 Pinze per dissezione e legature

Aurikelklemmen

Auricle Clamps
 Pinzas para la aurícula atril
 Pincas-clamps auriculaires
 Pinze ventricolare

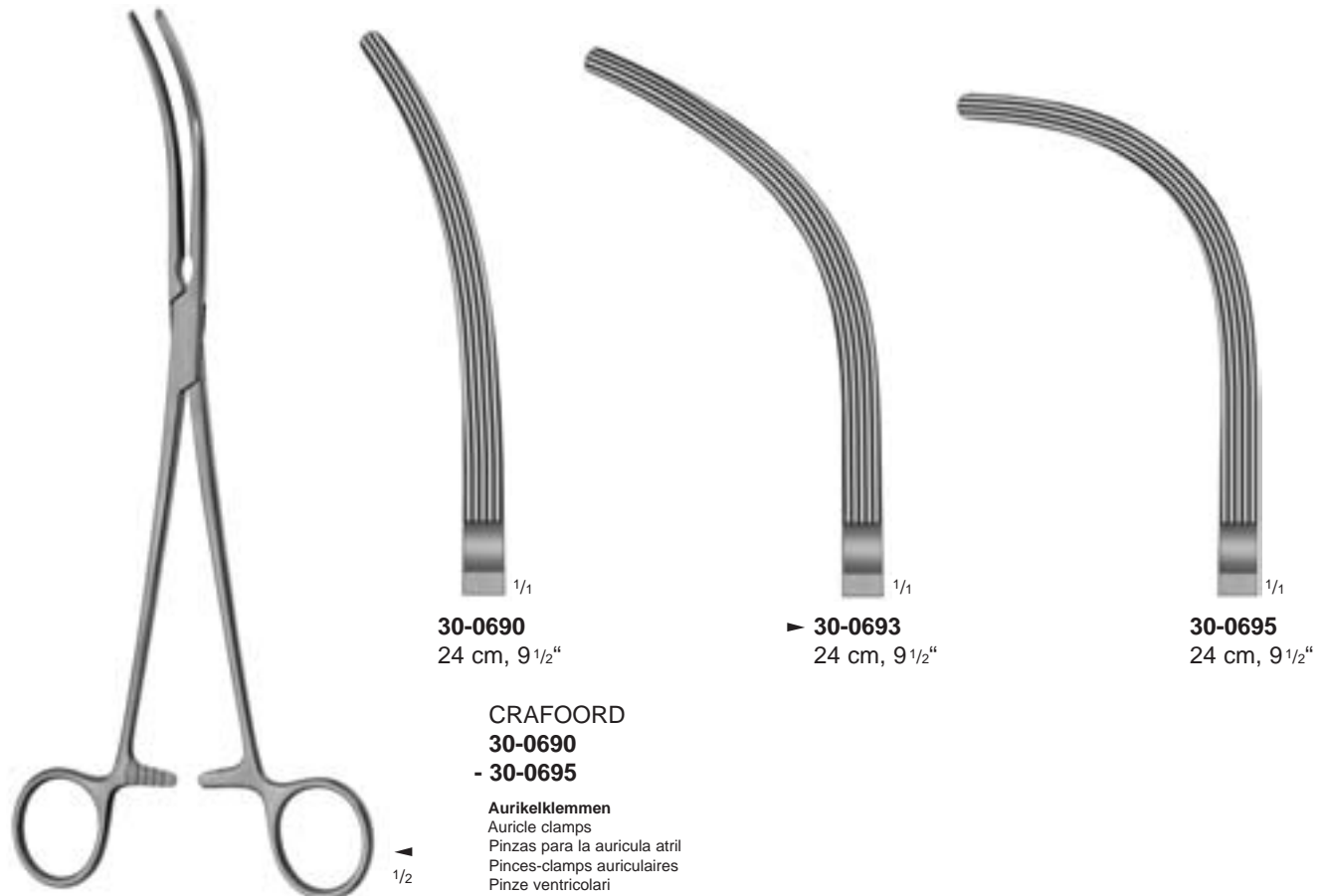
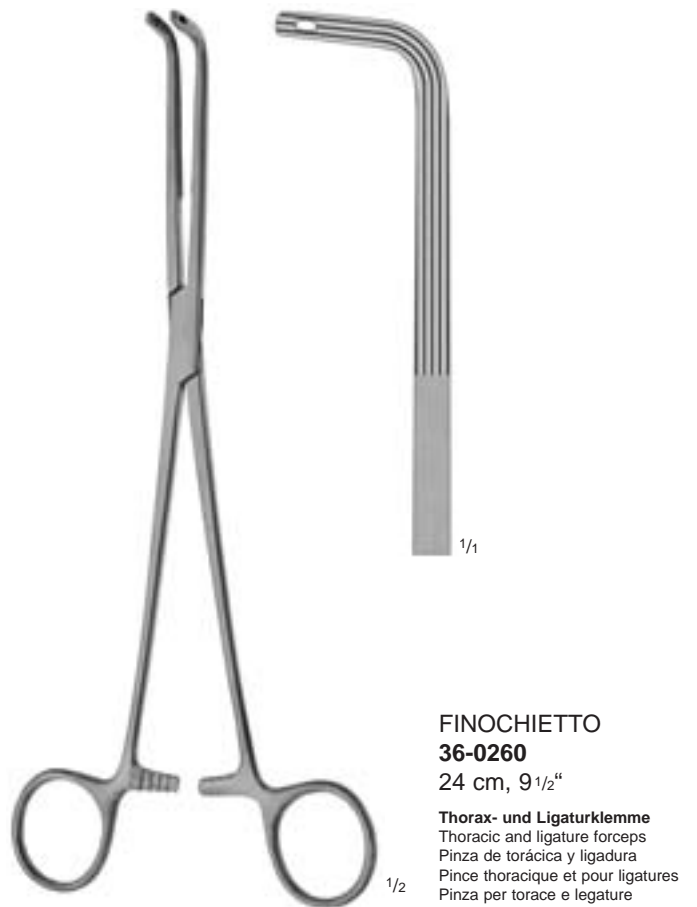
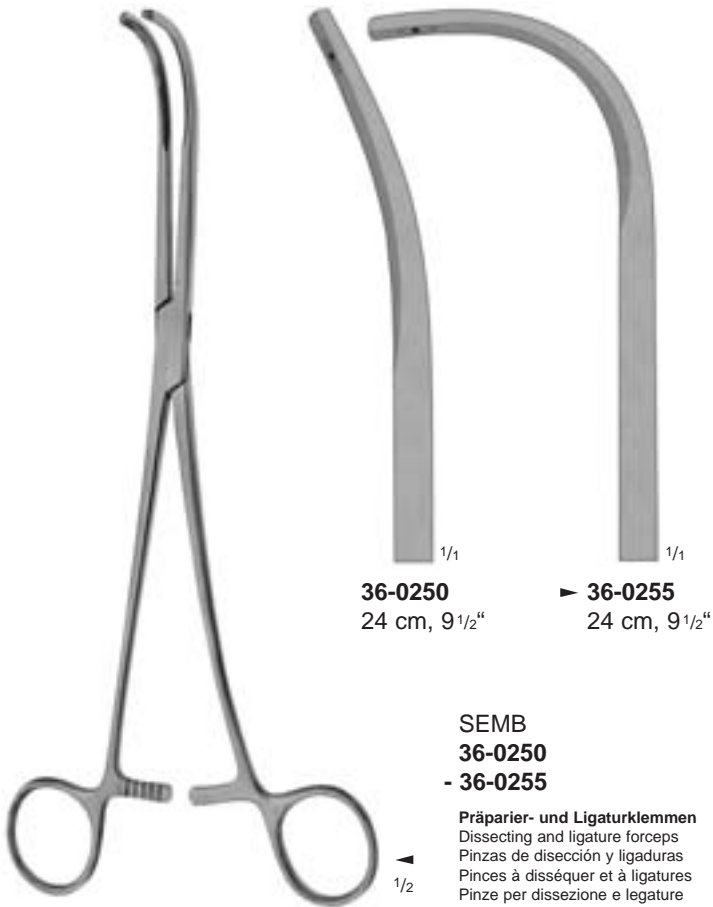

Anastomosen- (Vena cava) Klemme

Anastomosis (Vena Cava) Clamps

Pinzas-clamps para anastomosis (vena cava)

Pinces-clamps à anastomose (veine cave)

Pinze per anastomosi (vena cava)

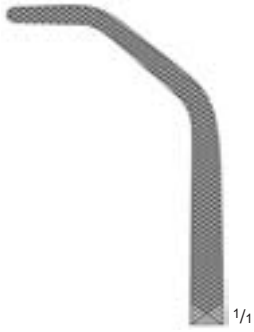

1/1



1/1

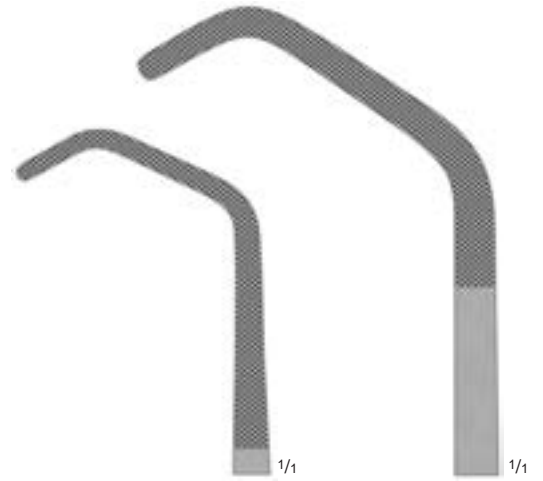

1/1

1/1

30-0811
20,5 cm, 8"

▶ **30-0810**
27 cm, 10³/₄"



1/2

BABY-SATINSKY
30-0801
16 cm, 6¹/₄"



1/2

SATINSKY
30-0800
24 cm, 9¹/₂"



1/2

SATINSKY
30-0810
- **30-0811**



Bronchusklemmen

Bronchus Forceps
Pinzas-clamps bronquiales
Pinces-clamps à bronches
Pinze per legature

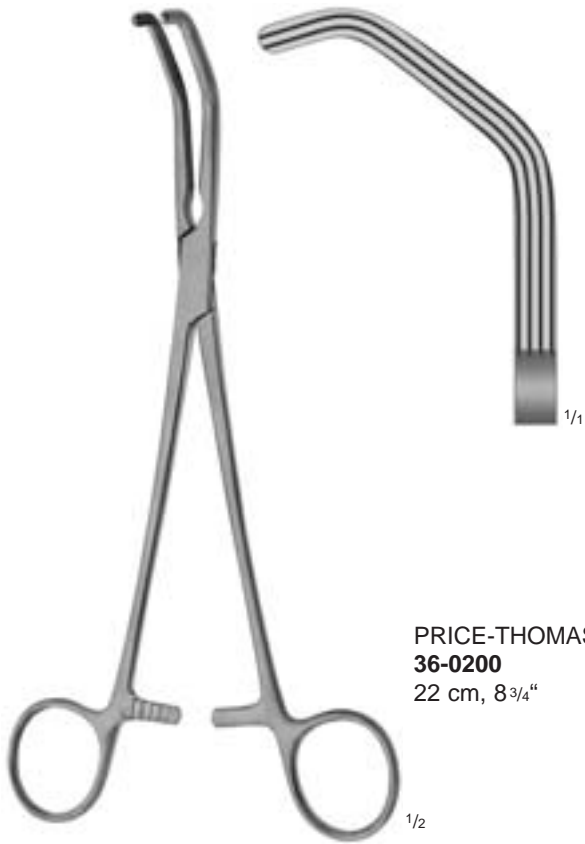

PRICE-THOMAS
36-0200
22 cm, 8³/₄"



▶ **36-0201**
22 cm, 8³/₄"

36-0202
22 cm, 8³/₄"

PRICE-THOMAS
36-0201
- **36-0202**

mit Stiften im Maul
jaw with pins
con dientes
avec dents
con denti



SAROT
36-0410
- **36-0415**

mit Stiften im Maul
jaw with pins
con dientes
avec dents
con denti



▶ **36-0410**
22,5 cm, 9"



36-0415
22,5 cm, 9"



LAWNTON
Medizintechnik



Knochenchirurgie
Bone Surgery
Cirugía ósea
Chirurgie osseuse
Chirurgia ossea



Instrumente für Knochenchirurgie
Instruments for Bone Surgery
Instrumentos para cirugía ósea
Instruments pour chirurgie osseuse
Strumenti per chirurgia ossea



Resektions- und Amputationsmesser	Seite	38 - 39
Resection and Amputation Knives	Page	38 - 39
Cuchillos para resección y amputación	Página	38 - 39
Couteaux à résection et amputation	Page	38 - 39
Bisturi per resezione e amputazione	Pagina	38 - 39



Scharfe Löffel	Seite	466
Bone Curettes	Page	466
Cucharillas cortantes	Página	466
Curettes	Page	466
Curette per ossa	Pagina	466



Sternummeißel	Seite	492
Sternum Chisel	Page	492
Cinzel para esternón	Página	492
Cisailles et ciseau-burins à sternum	Page	492
Scalpello per sterno	Pagina	492



Rippenscheren	Seite	492 - 493
Rib Shears	Page	492 - 493
Costótomos	Página	492 - 493
Costotomes	Page	492 - 493
Costotomi	Pagina	492 - 493



Rippen- und Knochenfaßzangen	Seite	493
Rib and Bone Holding Forceps	Page	493
Pinzas para huesos	Página	493
Daviers porte-os	Page	493
Tenaglie per ossa	Pagina	493



Knochensplitterzangen	Seite	494
Bone Cutting Forceps	Page	494
Pinzas cortantes para huesos	Página	494
Pinces coupantes à os	Page	494
Pinze taglienti per ossa	Pagina	494

Instrumente für Knochenchirurgie
 Instruments for Bone Surgery
 Instrumentos para cirugía ósea
 Instruments pour chirurgie osseuse
 Strumenti per chirurgia ossea



Rundmeißelzange	Seite	494
Rib Rongeur	Page	494
Pinza-gubia para redondear	Página	494
Rongeurs	Page	494
Pinze costali	Pagina	494



Hohlmeißelzangen	Seite	494
Rib Rongeurs	Page	494
Pinzas-gubias	Página	494
Pinces-gouges	Page	494
Pinze costali	Pagina	494



Rippenraspatorien	Seite	495 - 497
Rib Raspatories	Page	495 - 497
Periostótomos costales	Página	495 - 497
Rugines costales	Page	495 - 497
Periostotomi costali	Pagina	495 - 497





Amputation
Amputation
Amputación
Amputation
Amputazione



1/4

47-0240

Komprimeter zur Erzeugung einer Blutleere in den Extremitäten, Manometer mit Meßbereich bis 700 mm Hg, komplett, bestehend aus:

47-0241 1 Luftpumpe mit Manometer
47-0243 1 Oberschenkel-Manschette
47-0244 1 Oberarm-Manschette

Comprimeter. Compression apparatus for producing exsanguination in the extremities. Manometer registers up to 700 mm Hg. Complete, consisting of:

47-0241 1 Pump with manometer
47-0243 1 Cuff for the leg
47-0244 1 Cuff for the upper arm

Torniquete para producir una isquemia local en las extremidades. Manómetro ajustado hasta 700 mm Hg, completo, compuesto de:

47-0241 1 Bomba de aire con manómetro
47-0243 1 Brazaletes para el muslo
47-0244 1 Brazaletes para el brazo

Appareil compressif permettant de créer une ischémie dans les extrémités. Manomètre ajusté jusqu'à 700 mm Hg. Complet, composé de:

47-0241 1 Pompe à air avec manomètre
47-0243 1 Manchette pour le bras
47-0244 1 Manchette pour la cuisse

Apparecchio per arrestare il sangue nelle estremita. Manometro graduato fino a 700 mm Hg.

Completo, composto da:
47-0241 1 Pompa aria con manometro
47-0243 1 Bracciale
47-0244 1 Cosciale



1/2

ESMARCH

47-0245

Staubinde, 5 m lang, 6 cm breit
Compression bandage, 5 m long, 6 cm wide
Venda-compresión, 5 m largo, 6 cm ancho
Bande compressive, 5 m long, 6 cm de large
Fascia per ischemia 5 m x 6 cm



1/4

ESMARCH

47-0248

Stauschlauch, 1 m lang
Compression tube, 1 m long
Tubo-compresión, 1 m largo
Tube compressie, 1 m de long
Tubo per ischemia da 1 m

Amputationsretraktoren
Amputation Retractors
Retradores para amputación
Retracteurs
Retratore per amputazione



PERCY
47-0290

Griffe abnehmbar
Removable handles
Mangos desmontables
Manches démontables
Manici smontabili

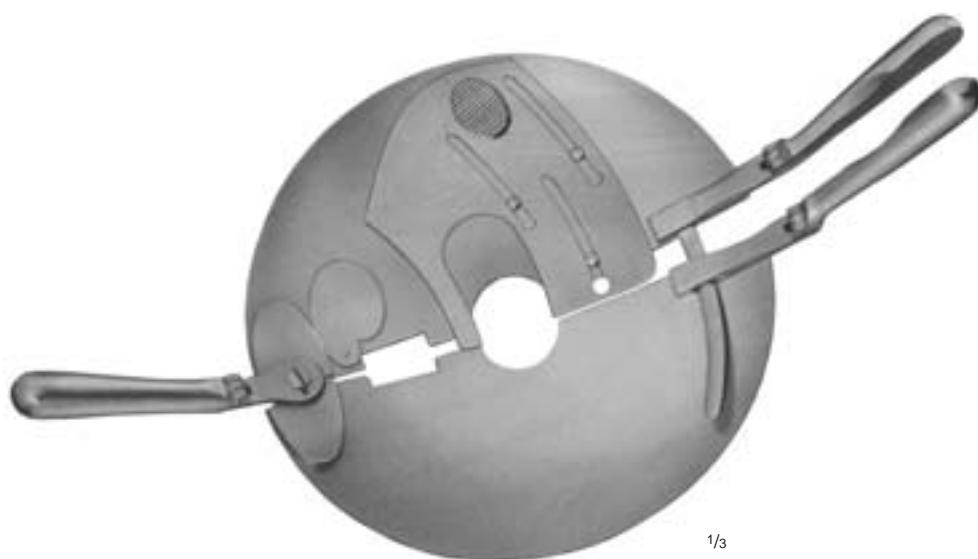

PERCY
47-0291

Griffe umlegbar
Reversible handles
Mangos reversibles
Manches reversibles
Manici reversibili



Amputations- und Resektionssägen
Amputation and Resection Saws
Sierras para amputación y resección
Scies à amputation et résection
Seghe per amputazione e resezione

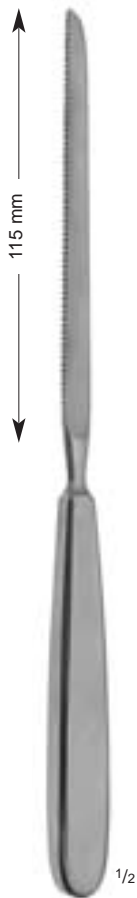

LANGENBECK
47-0300
23,5 cm, 9 1/4"

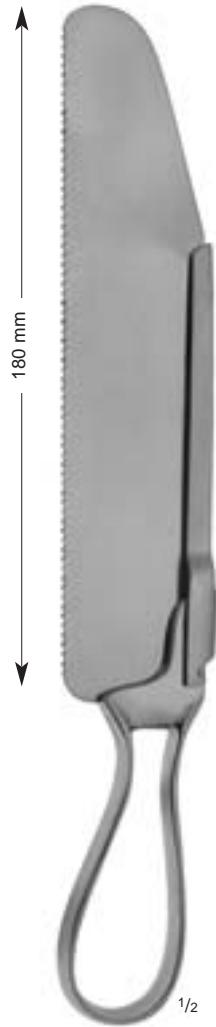

CHARRIÈRE
47-0305
27 cm, 10 3/4"

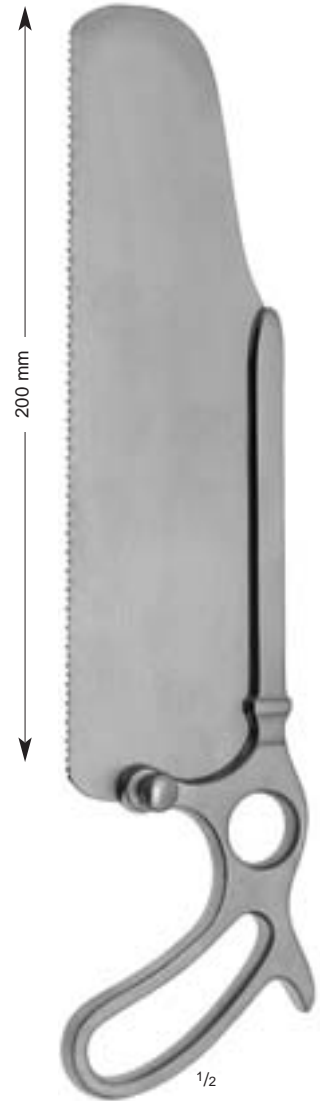

SATTERLEE
47-0310
29 cm, 11 1/2"

mit austauschbarem

Sägeblatt (47-0311)
with interchangeable
saw blade (47-0311)

con hoja de sierra
intercambiable (47-0311)

avec lame interchange-
able (47-0311)

con lama intercambi-
abile (47-0311)

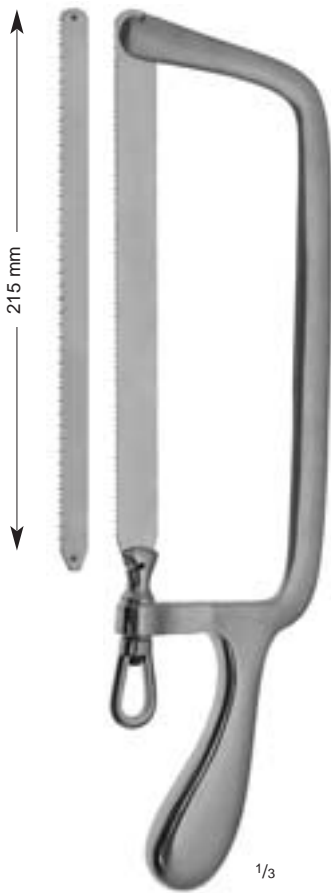

CHARRIÈRE

47-0315

35 cm, 13^{3/4}"

mit je 1 austauschbarem Sägeblatt
 12 mm (47-0316) und 18 mm (47-0317)

with 1 each interchangeable saw blade
 12 mm (47-0316) and 18 mm (47-0317)

con 2 hojas de sierras intercambiables
 12 mm (47-0316) y 18 mm (47-0317)

avec 1 jeu de 2 lames de scie 12 mm
 (47-0316) et 18 mm (47-0317)

con 2 lame intercambiabili 12 mm
 (47-0316) e 18 mm (47-0317)

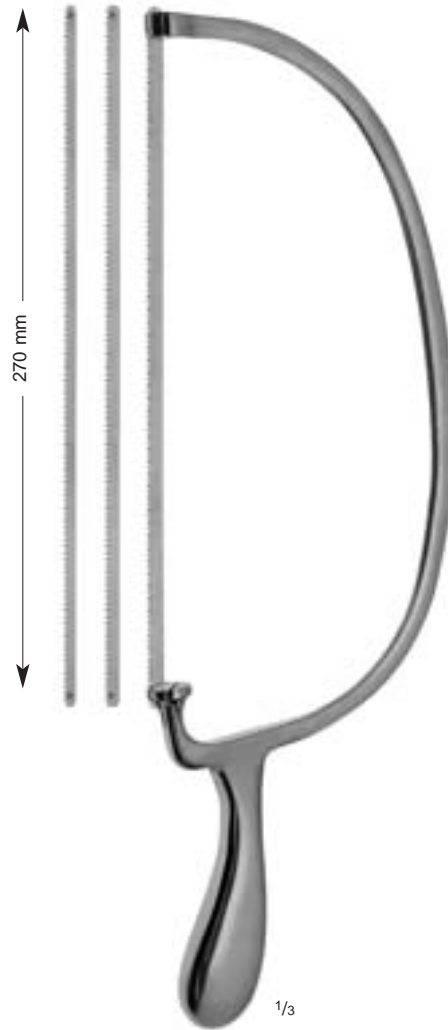

BIER

47-0320

40,5 cm, 16"

mit je 1 austauschbarem Sägeblatt 4 mm
 (47-0321), 6 mm (47-0322) und 8 mm (47-0323)

with 1 each interchangeable saw blade 4 mm
 (47-0321), 6 mm (47-0322) and 8 mm (47-0323)

con 3 hojas de sierras intercambiables 4 mm
 (47-0321), 6 mm (47-0322) y 8 mm (47-0323)

avec 1 jeu de 4 lames de scies 4 mm (47-0321),
 6 mm (47-0322) et 8 mm (47-0323)

con 3 lame intercambiabili 4 mm (47-0321),
 6 mm (47-0322) e 8 mm (47-0323)

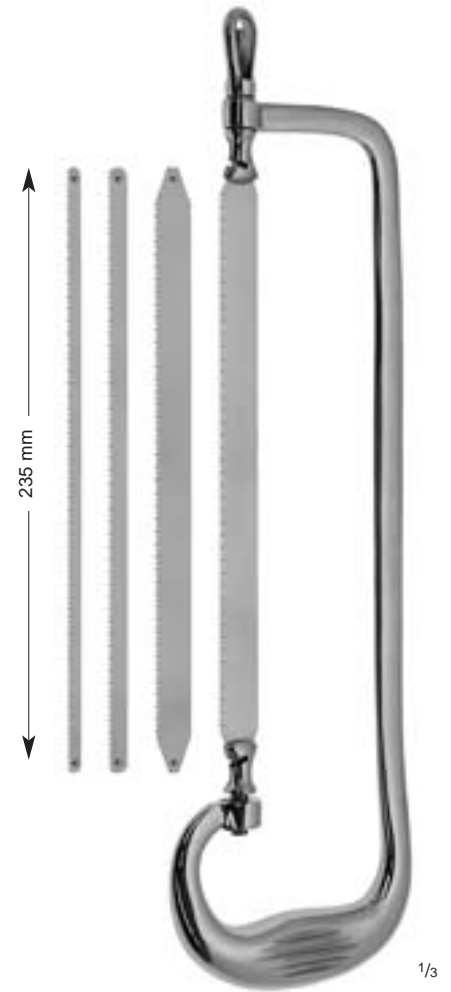

RUST

47-0330

39 cm, 15^{1/2}"

mit je 1 austauschbarem Sägeblatt 6 mm (47-0331),
 8 mm (47-0332), 15 mm (47-0334) und 18 mm (47-0335)

with 1 each interchangeable saw blade 6 mm (47-0331),
 8 mm (47-0332), 15 mm (47-0334) and 18 mm (47-0335)

con 4 hojas de sierras intercambiables 6 mm (47-0331),
 8 mm (47-0332), 15 mm (47-0334) y 18 mm (47-0335)

avec 1 jeu de 4 lames de scies 6 mm (47-0331), 8 mm
 (47-0332), 15 mm (47-0334) et 18 mm (47-0335)

con 4 lame intercambiabili 6 mm (47-0331), 8 mm
 (47-0332), 15 mm (47-0334) e 18 mm (47-0335)



Dissektoren
Dissectors
Disecadores
Dissecteurs
Dissettori

Elevatorien
Elevators
Elevadores
Elévateurs
Elevatori

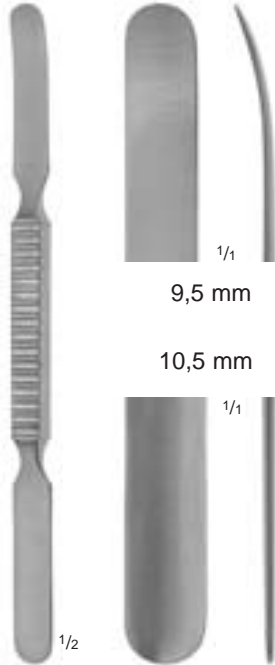

WATSON-CHEYNE
48-0170
17,5 cm, 7"

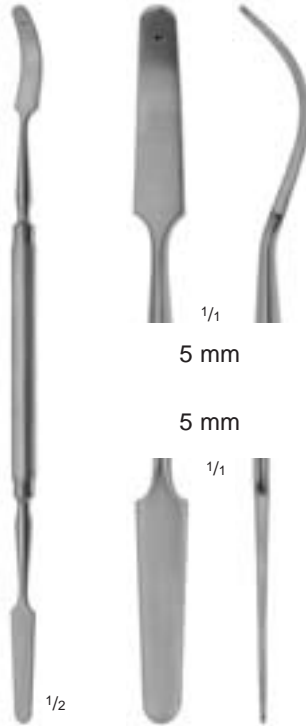

MC DONALD
48-0177
19 cm, 7 1/2"

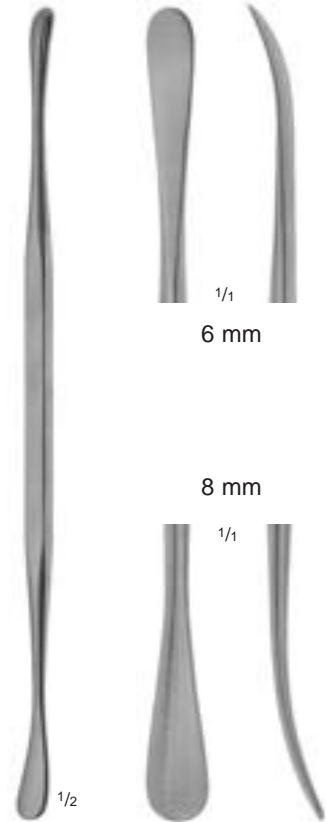

ALDERDYCE
81-0125
21,5 cm, 8 1/2"

Dissektoren • Dissectors • Disecadores • Dissecteurs • Dissettori

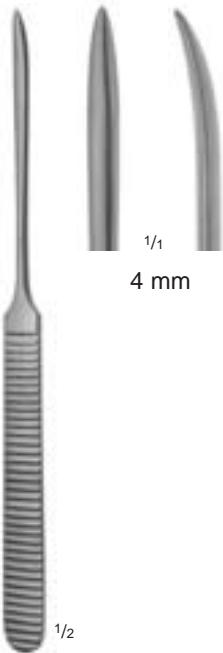

WILLIGER
48-0090
17 cm, 6 3/4"

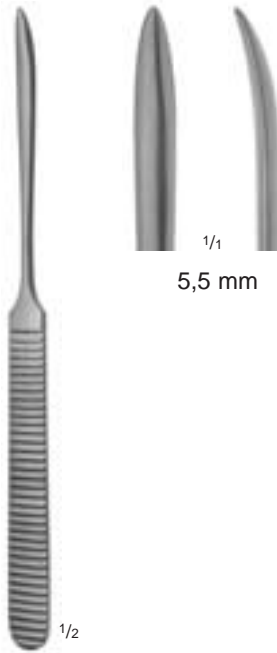

WILLIGER
48-0091
17 cm, 6 3/4"

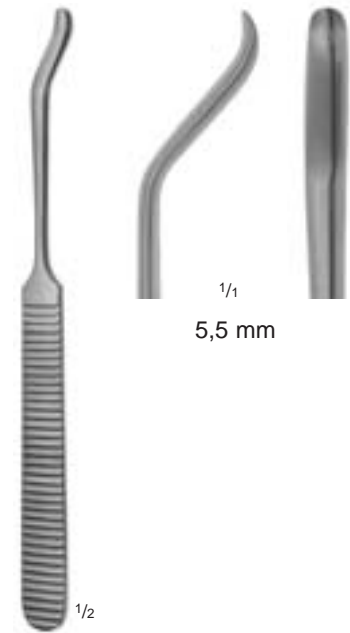

48-0087
16,5 cm, 6 1/2"

Elevatorien • Elevators • Elevadores • Elévateurs • Elevatori

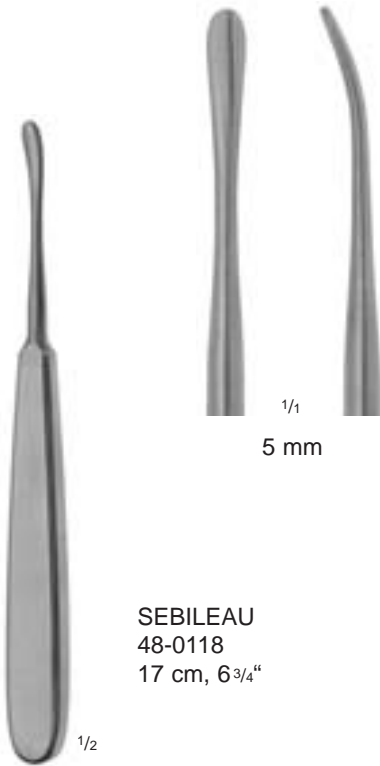

SEBILEAU
48-0118
17 cm, 6^{3/4}"

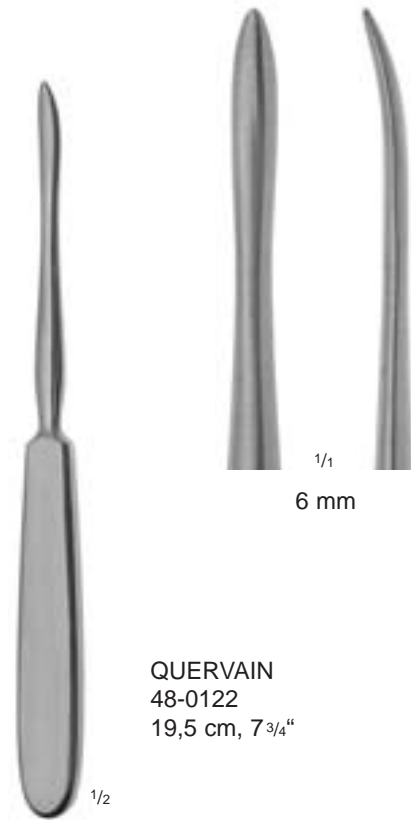

QUERVAIN
48-0122
19,5 cm, 7^{3/4}"

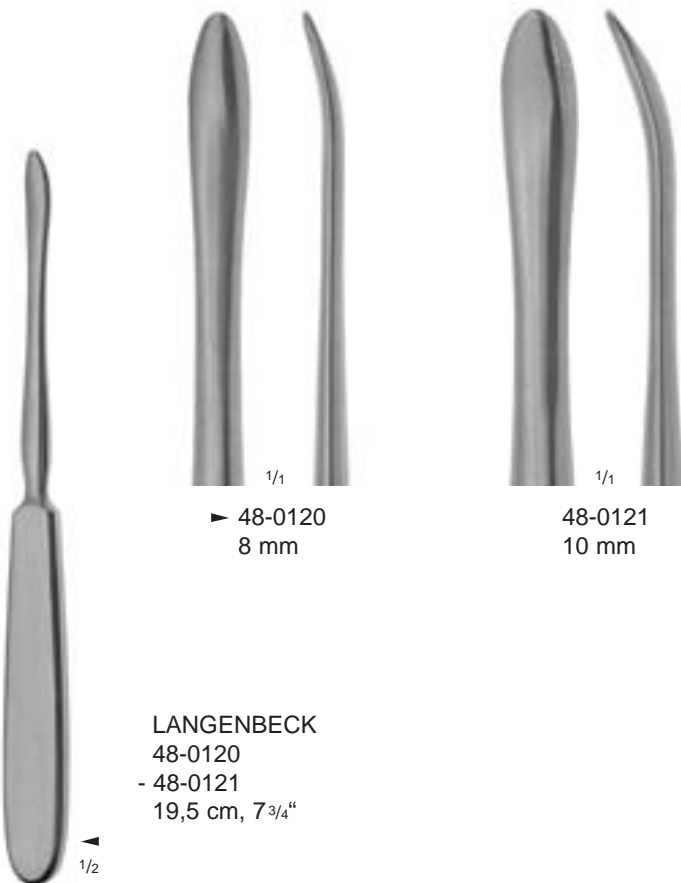

LANGENBECK
48-0120
- 48-0121
19,5 cm, 7^{3/4}"

▶ 48-0120
8 mm

48-0121
10 mm

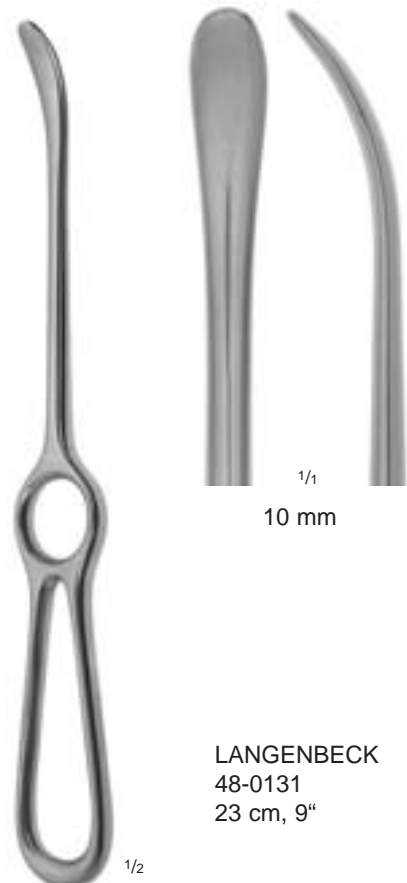

LANGENBECK
48-0131
23 cm, 9"

10 mm



Knochenhebel
Bone Levers
Elevadores para huesos
Leviers à os
Leve per ossa

3 mm

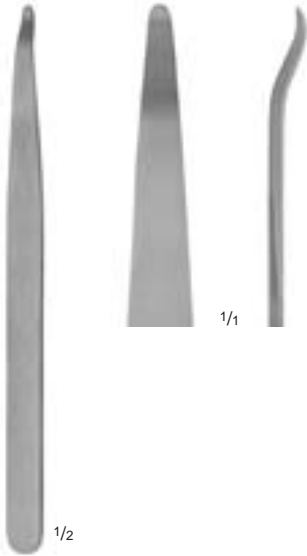

48-0070
14,5 cm, 5³/₄"

6 mm

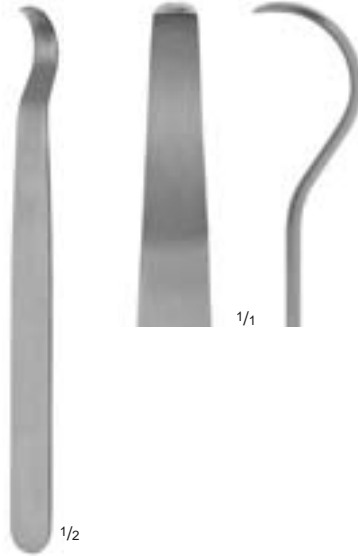

48-0072
14,5 cm, 5³/₄"

7 mm

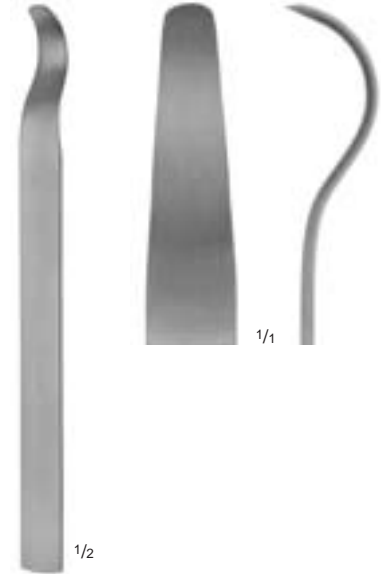

48-0075
15 cm, 6"

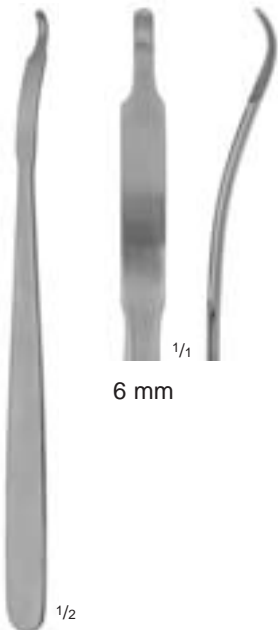

MINI-HOHMANN
45-0302
16 cm, 6¹/₄"

6 mm

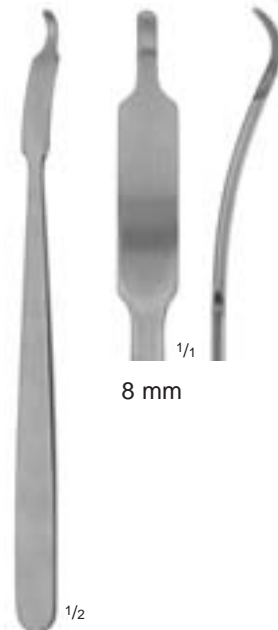

MINI-HOHMANN
45-0304
16 cm, 6¹/₄"

8 mm

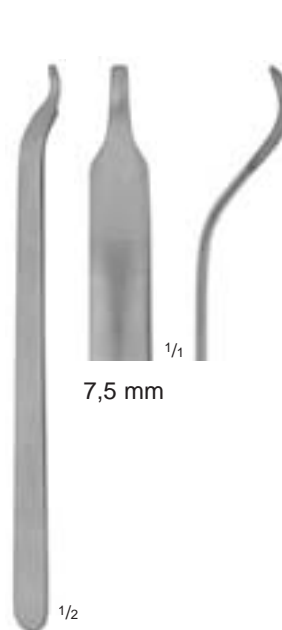

BUCK-GRAMCKO
45-0306
15 cm, 6"

7,5 mm

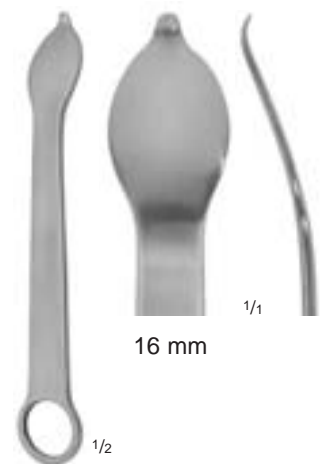

45-0308
12 cm, 4³/₄"

16 mm



17 mm



24 mm



30 mm



WAGNER
 45-0316
 22 cm, 8³/₄"



LANGE-HOHMANN
 45-0312
 25,5 cm, 10"



LANGE-HOHMANN modif.
 45-0314
 26,5 cm, 10¹/₂"



Knochenhebel
Bone Levers
Elevadores para huesos
Leviers à os
Leve per ossa



9 mm



18 mm



18 mm



24 mm



HOHMANN
45-0319
22 cm, 8³/₄"



HOHMANN
45-0317
24 cm, 9¹/₂"



HOHMANN
45-0320
25,5 cm, 10"



HOHMANN
45-0322
26 cm, 10¹/₄"



35 mm



43 mm



64 mm



HOHMANN
 45-0323
 28,5 cm, 11 1/4"



VERBRUGGE-MÜLLER
 45-0324
 24 cm, 9 1/2"



VERBRUGGE-MÜLLER
 45-0325
 25,5 cm, 10"



Knochenhebel
 Bone Levers
 Elevadores para huesos
 Leviers à os
 Leve per ossa

Hüfthebel
 Hib Levers
 Elevadores para caderas
 Elevateurs pour la hanche
 Leve per sciatica



25 mm



24 mm



34 mm



45 mm



HOHMANN
 45-0326
 27 cm, 10^{3/4}"

Knochenhebel
 Bone lever
 Elevador para hueso
 Levier à os
 Leve per ossa



HOHMANN-ALDINGER
 45-0318
 28,5 cm, 11^{1/4}"

Knochenhebel
 Bone lever
 Elevador para hueso
 Levier à os
 Leve per ossa



BLOUNT
 45-0328
 26 cm, 10^{1/4}"

Hüfthebel
 Hib lever
 Elevador para cadera
 Elevateur pour la hanche
 Leve per sciatica



BLOUNT
 45-0329
 26 cm, 10^{1/4}"

Hüfthebel
 Hib lever
 Elevador para cadera
 Elevateur pour la hanche
 Leve per sciatica

Knochenhebel
 Bone Levers
 Elevadores para huesos
 Leviers à os
 Leve per ossa

Luxationshebel
 Luxation Lever
 Elevadores para luxación
 Leviers pour luxation
 Leve per lussazione



45-0330
 45 mm

1/1



▶ 45-0331
 60 mm

1/1



1/2

BENNETT
 45-0330
 - 45-0331
 25 cm, 10"

Knochenhebel
 Bone levers
 Elevadores para huesos
 Leviers à os
 Leve per ossa



30 mm

1/1



18 mm

1/1



30 mm

18 mm

1/2

MURPHY-LANE
 45-0310
 30 cm, 12"

Luxationshebel
 Luxation lever
 Elevador para luxación
 Levier pour luxation
 Leve per lussazione



Raspatorien
 Raspatories
 Periostótomos
 Rugines-raspatoires
 Periostotomi

4 mm

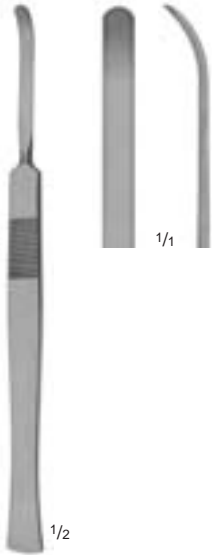

MC KENTY
 71-0450
 14,5 cm, 5³/₄"

5 mm

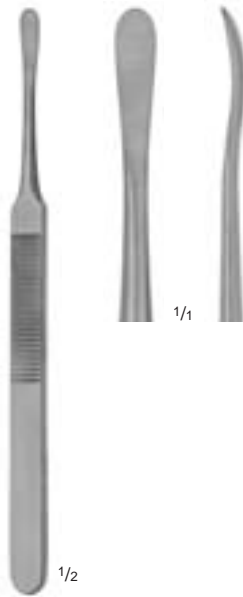

KÖNIG
 48-0105
 15,5 cm, 6"

4 mm

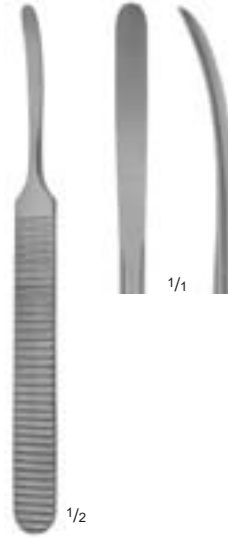

WILLIGER
 48-0107
 14 cm, 5¹/₂"

6 mm

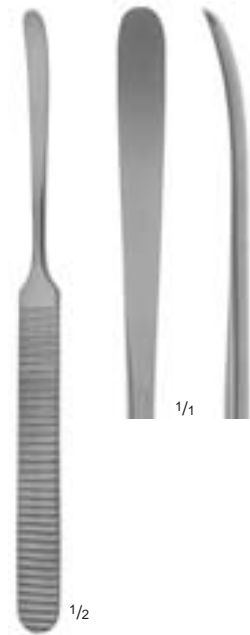

WILLIGER
 48-0108
 16 cm, 6¹/₄"

8 mm

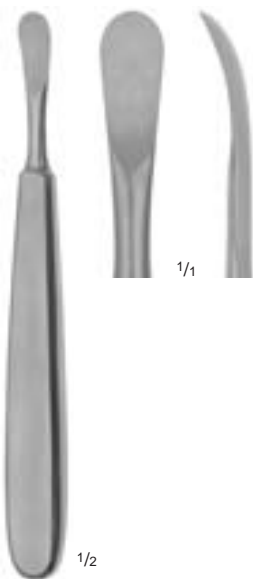

TRELAT
 48-0110
 15 cm, 6"

4 mm

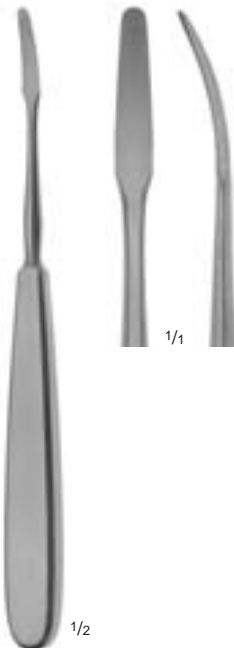

JOSEPH
 77-0760
 17 cm, 6³/₄"

3 mm

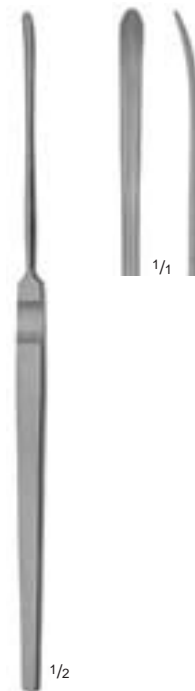

HALLE
 71-0490
 18 cm, 7"

6 mm



SEWALL
 71-0493
 20 cm, 8"





4,5 mm



stumpf
blunt
romo
mousse
smusso

scharf
sharp
agudo
pointu
acuto

4,5 mm



FREER
63-2920
19,5 cm, 7³/₄"





6,5 mm

stumpf
blunt
romo
mousse
smusso

scharf
sharp
agudo
pointu
acuto

6,5 mm

FREER
63-2925
19,5 cm, 7³/₄"





4,5 mm

stumpf
blunt
romo
mousse
smusso

scharf
sharp
agudo
pointu
acuto

4,5 mm





FREER
71-0415
19,5 cm, 7³/₄"

4,5 mm

scharf
sharp
agudo
pointu
acuto

4,5 mm

FREER
71-0416
19,5 cm, 7³/₄"





3,5 mm



stumpf
blunt
romo
mousse
smusso

scharf
sharp
agudo
pointu
acuto

3,5 mm





KILLIAN
71-0441
18,5 cm, 7¹/₄"





4,5 mm

4,5 mm





KILLIAN
71-0440
19 cm, 7¹/₂"



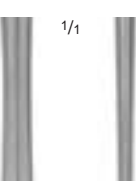

5,5 mm

4,5 mm





HOWARD
48-0172
21,5 cm, 8¹/₂"

4,5 mm

4,5 mm

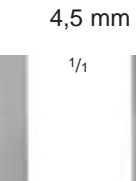
COTTLE
71-0516
23 cm, 9"



Raspatorien
 Raspatories
 Periostótomos
 Rugines-raspatoires
 Periostotomi

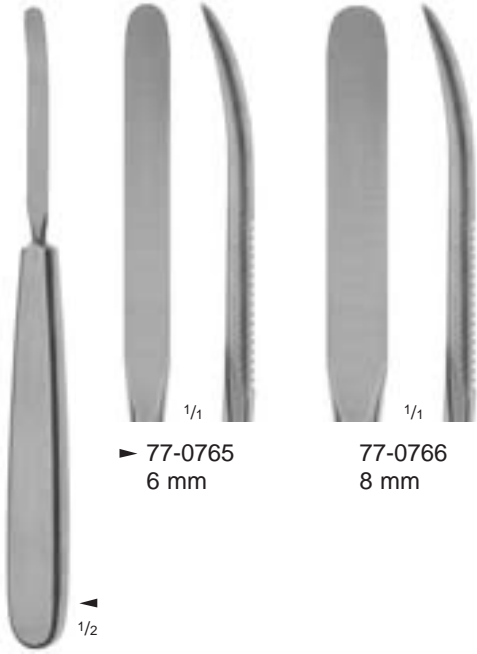

▶ 77-0765
6 mm

77-0766
8 mm

77-0765
- 77-0766
17 cm, 6³/₄"

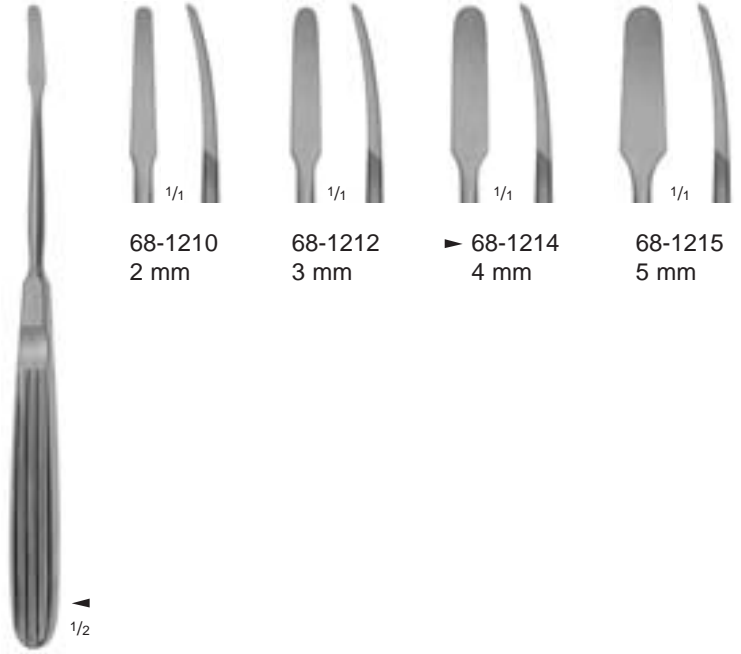

68-1210
2 mm

68-1212
3 mm

▶ 68-1214
4 mm

68-1215
5 mm

LEMPERT
68-1210
- 68-1215
17 cm, 6³/₄"

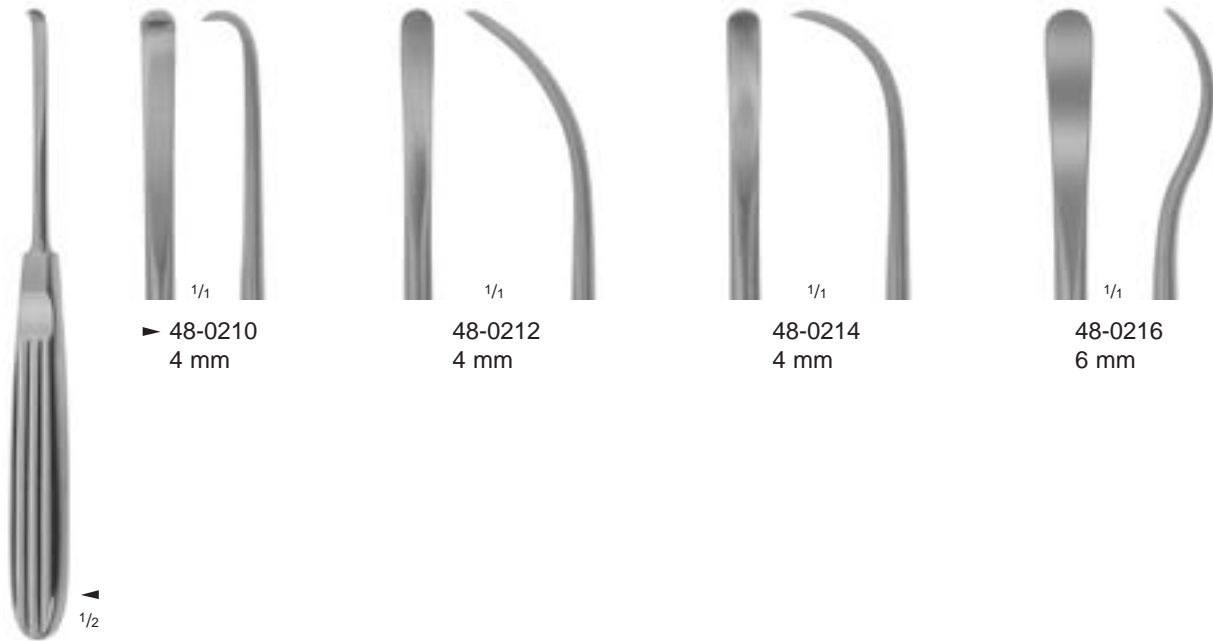

▶ 48-0210
4 mm

48-0212
4 mm

48-0214
4 mm

48-0216
6 mm

MÜHLING
48-0210
- 48-0216
17 cm, 6³/₄"

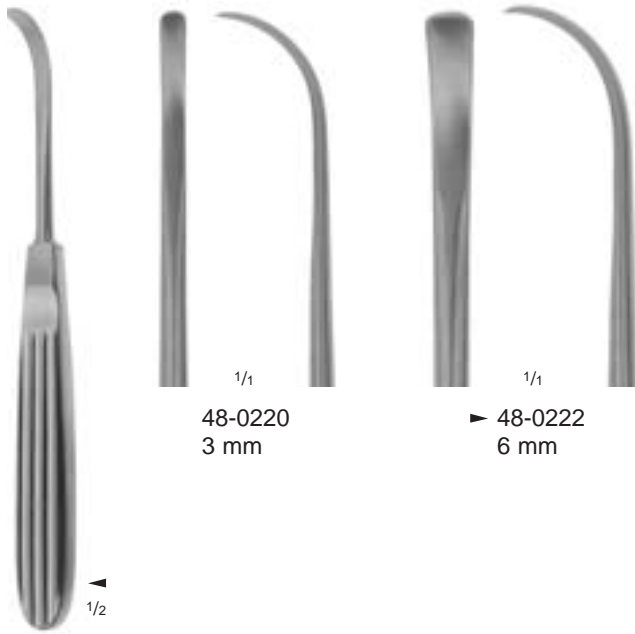

48-0220
 3 mm

▶ 48-0222
 6 mm

48-0220
 - 48-0222
 17 cm, 6^{3/4}"

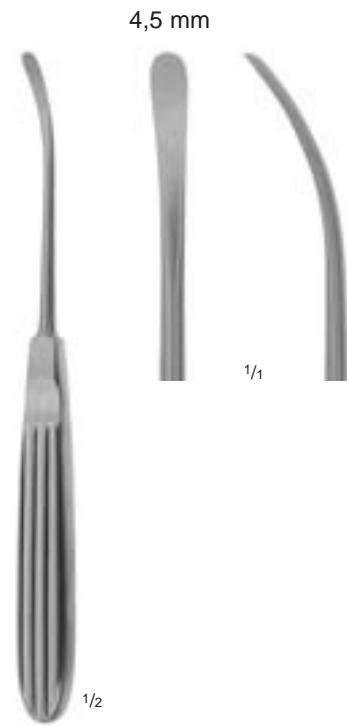

4,5 mm

LANDOLT
 48-0218
 17,5 cm, 7"

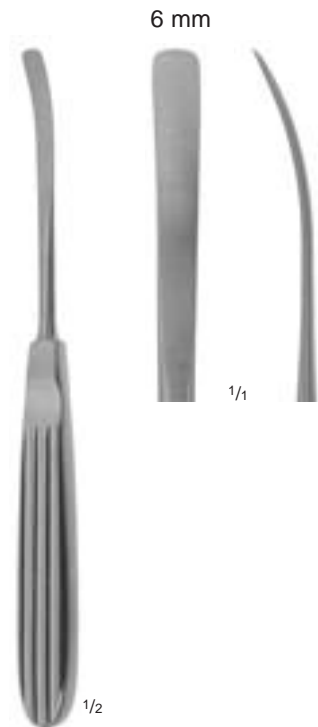

6 mm

CASPAR
 48-0224
 18 cm, 7"

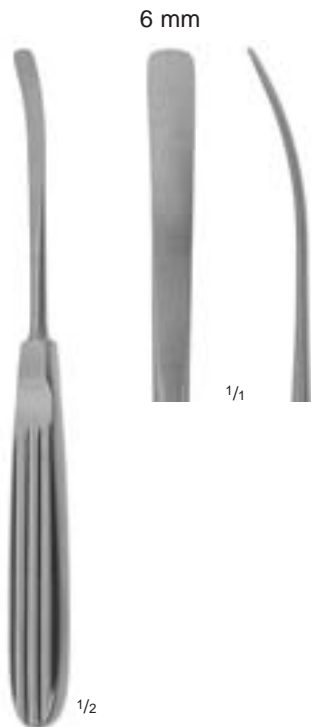

6 mm

CASPAR
 48-0226
 18 cm, 7"

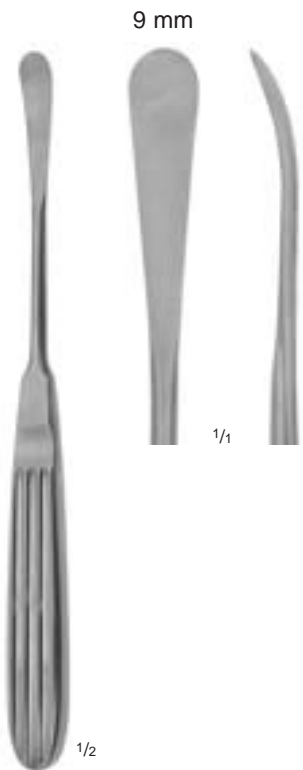

9 mm

COTTLE
 48-0228
 19 cm, 7^{1/2}"



Raspatorien
 Raspatories
 Periostótomos
 Rugines-raspatoires
 Periostotomi



▶ 52-0100
 8 mm

ADSON
 52-0100
 - 52-0115
 17 cm, 6 3/4"

1/2



1/1



1/1

52-0115
 7 mm



1/1

52-0105
 7 mm



1/1

52-0110
 7 mm

18 mm



1/1

SEDILLOT
 39-0195
 19 cm, 7 1/2"

1/2

6 mm

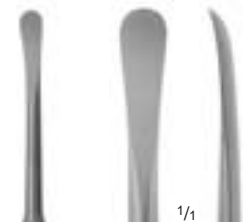

1/1

HOEN
 52-0090
 16 cm, 6 1/4"

1/2

15 mm



1/1

HOEN
 52-0091
 19 cm, 7 1/2"

1/2

20 mm



1/1

HOEN
 52-0092
 19 cm, 7 1/2"

1/2

15 mm



1/1

SEDILLOT
 39-0192
 22 cm, 8 3/4"

1/2

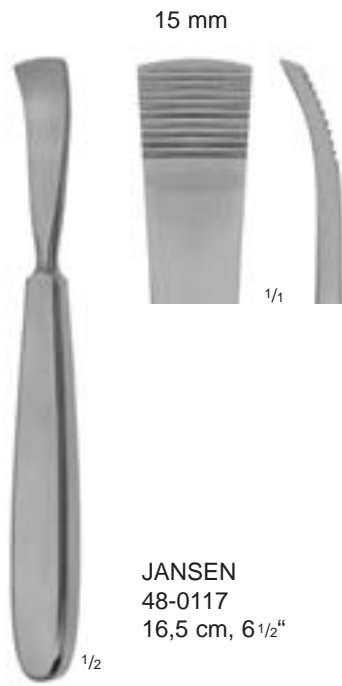

JANSEN
 48-0117
 16,5 cm, 6 1/2"

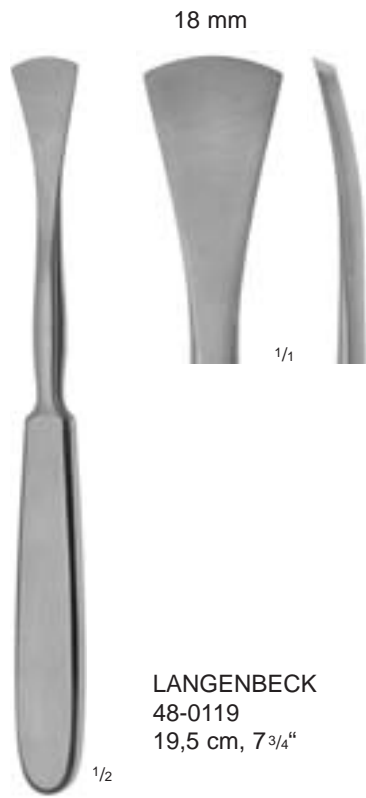

LANGENBECK
 48-0119
 19,5 cm, 7 3/4"

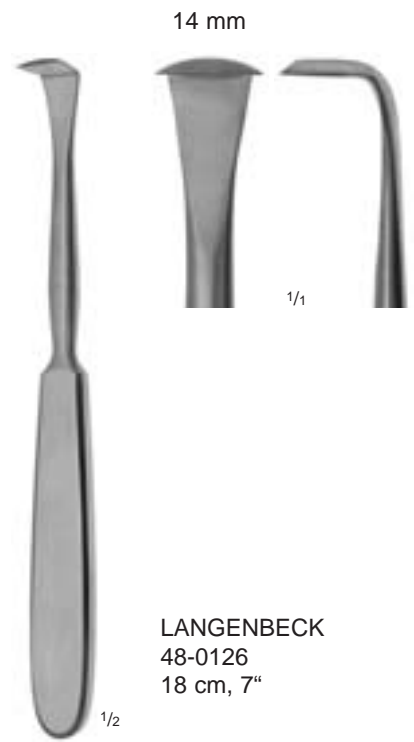

LANGENBECK
 48-0126
 18 cm, 7"

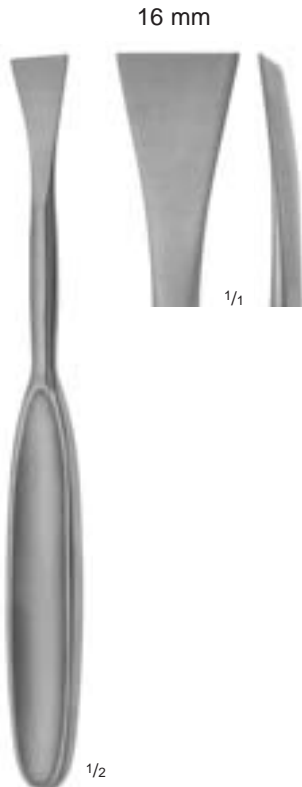

LANGENBECK
 48-0123
 19,5 cm, 7 3/4"

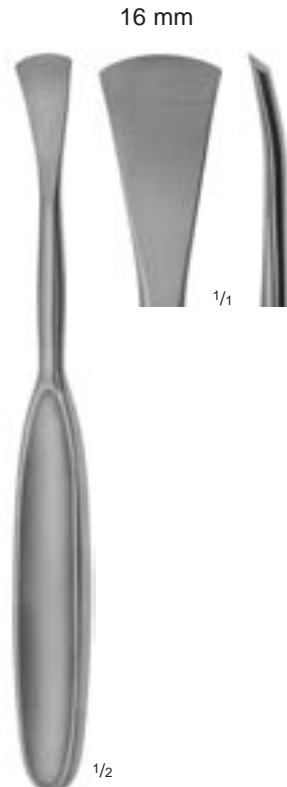

LANGENBECK
 48-0125
 19,5 cm, 7 3/4"

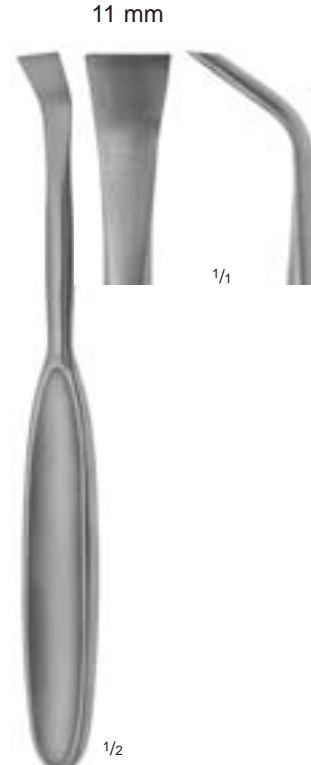

LANGENBECK
 48-0128
 19 cm, 7 1/2"

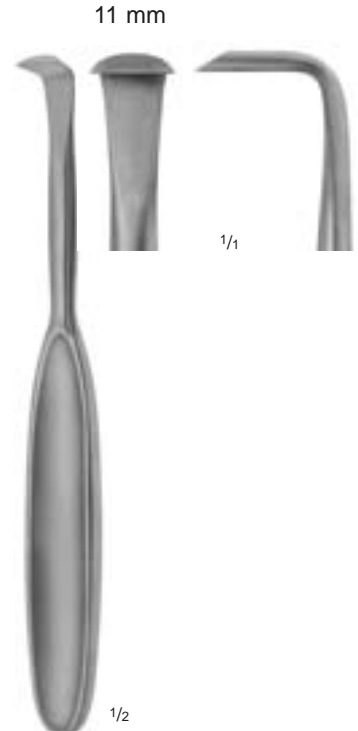

LANGENBECK
 48-0129
 18 cm, 7"



Raspatorien
Raspatories
Periostótomos
Rugines-raspatoires
Periostotomi

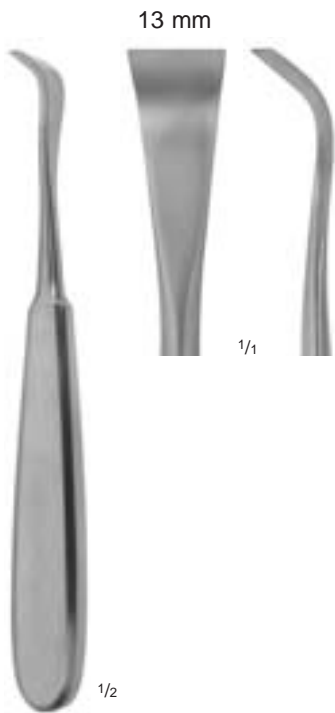

SCHNEIDER
48-0132
17,5 cm, 7"

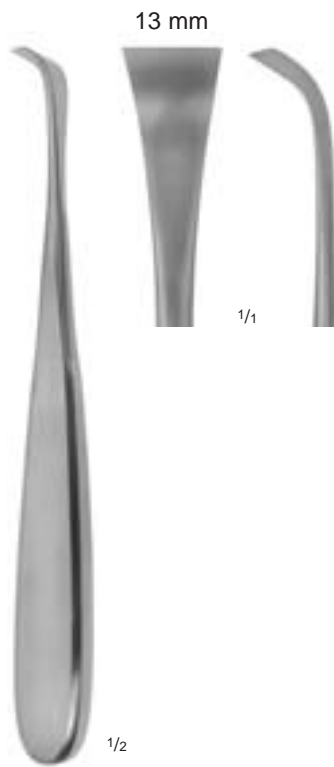

SCHNEIDER-SAUERBRUCH
48-0134
19 cm, 7 1/2"

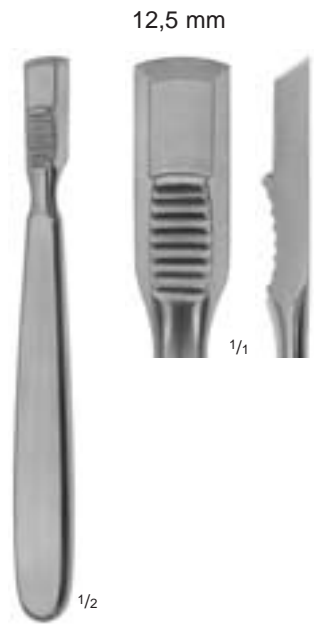

FARABEUF
48-0142
15 cm, 6"



FARABEUF
48-0143
15 cm, 6"



FARABEUF-COLLIN
48-0148
15,5 cm, 6"

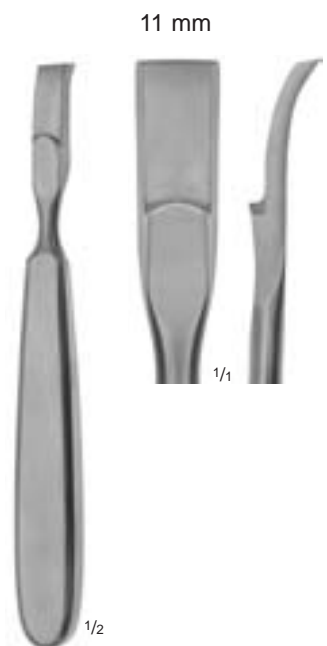

FARABEUF-COLLIN
48-0149
15,5 cm, 6"



3,0 mm

48-0200
 17,5 cm, 7"



6,5 mm

48-0201
 17,5 cm, 7"



9,5 mm

48-0202
 19 cm, 7 1/2"



12,5 mm

▶ 48-0203
 19 cm, 7 1/2"



16,0 mm

48-0204
 20 cm, 8"



19,5 mm

48-0205
 20 cm, 8"



24,5 mm

48-0206
 21 cm, 8 1/4"



KEY
 48-0200
 - 48-0206



10,0 mm

46-0710
 28,5 cm, 11 1/4"



13,0 mm

▶ 46-0711
 28,5 cm, 11 1/4"



19,0 mm

46-0712
 28,5 cm, 11 1/4"



25,0 mm

46-0713
 28,5 cm, 11 1/4"



COBB
 46-0710
 - 46-0713



Raspatorien mit Ferrozellgriff
 Raspatories with handle from artificial wood
 Periostótomos con mango de madera artificial
 Rugines-raspatoires avec manche en „Ferozell“
 Periostotomi con manico in legno artificiale

6 mm



48-0138
 19 cm, 7 1/2"

3 mm



48-0141
 19 cm, 7 1/2"

6 mm



48-0147
 19 cm, 7 1/2"

6 mm



48-0146
 19 cm, 7 1/2"

12 mm



48-0151
 19,5 cm, 7 3/4"

13 mm



48-0152
 20,5 cm, 8"

13 mm



48-0153
 20 cm, 8"

20 mm



48-0154
 20,5 cm, 8"

Raspatorien mit Ferrozellgriff
 Raspatories with handle from artificial wood
 Periostótomos con mango de madera artificial
 Rugines-raspatoires avec manche en „Ferozell“
 Periostotomi con manico in legno artificiale

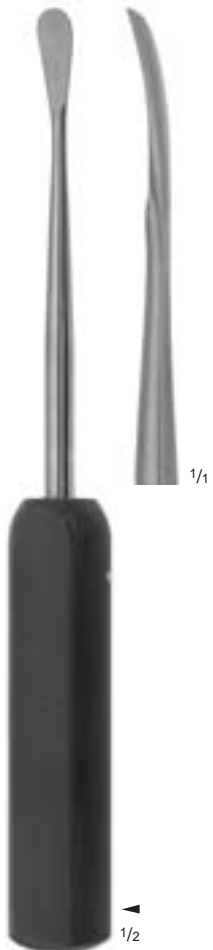

COBB
 48-0156
 - 48-0159
 25 cm, 10"

Sterilisierbar im Autoklav bei 3 bar Überdruck (143°C) !
 Can be autoclaved at 3 bar overpressure (143°C) !
 Esterilizables en autoclave a 3 bar sobrepresión (143°C) !
 Stérilisables à l'autoclave à 3 bars (143°)
 Può'essere autoclavato a 3 bar di pressione (143°)



48-0174
 27,5 cm, 10³/₄"

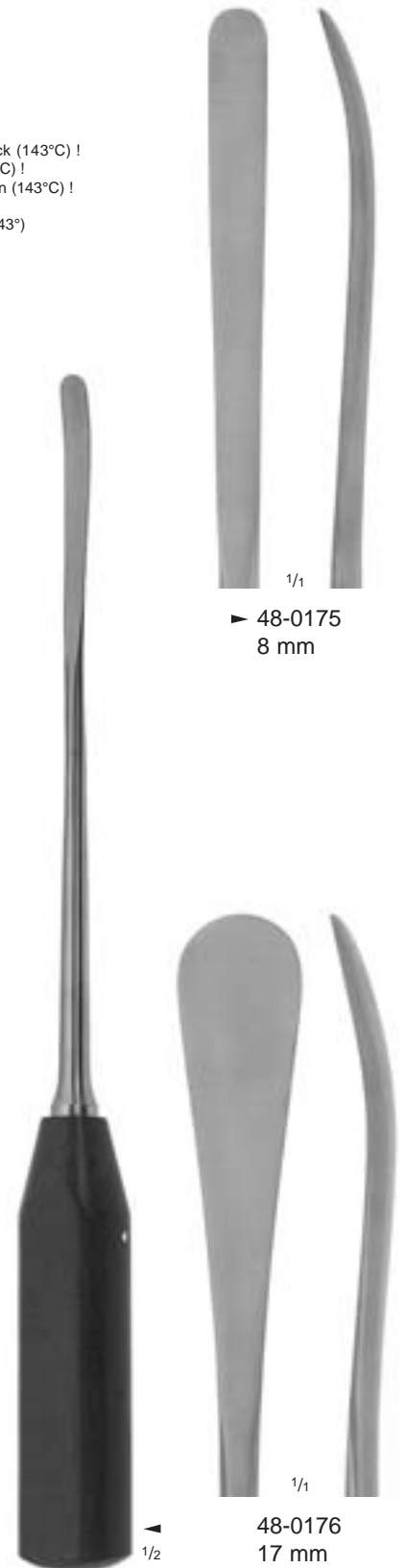

WAGNER
 48-0175
 - 48-0176
 33 cm, 13"



Knochenfeilen
 Bone Files
 Limas para huesos
 Limes à os
 Lime per ossa

Raspeln
 Rasps
 Escofinas
 Râpes
 Raspe



JOSEPH
 77-0400
 16,5 cm, 6 1/2"



GALLAHER
 77-0450
 17 cm, 6 3/4"

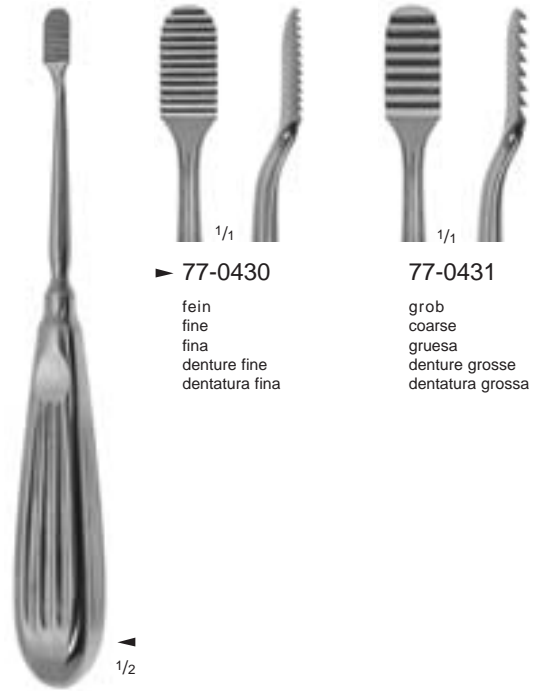

► 77-0430

fein
 fine
 fina
 denture fine
 dentatura fina

77-0431

grob
 coarse
 gruesa
 denture grosse
 dentatura grossa

LEWIS
 77-0430
 - 77-0431
 18 cm, 7"



MILLER
 47-0230
 - 47-0232
 18 cm, 7"



► 47-0231



47-0230



47-0232





MALTZ
77-0440
18 cm, 7"



COTTLE
77-0410
21 cm, 8 1/4"

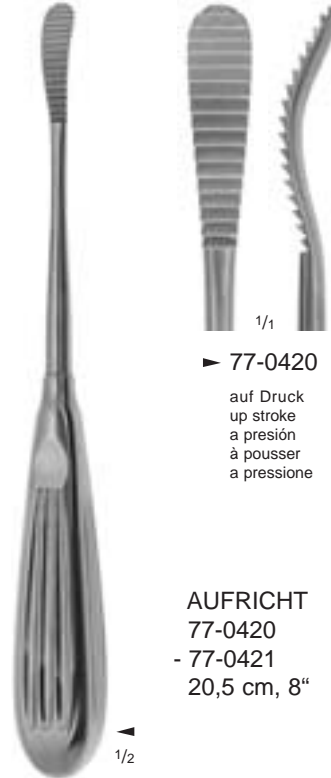

▶ 77-0420
auf Druck
up stroke
a presión
à pousser
a pressione

77-0421
auf Zug
down stroke
a tracción
à tirer
a trazione

AUFRICHT
77-0420
- 77-0421
20,5 cm, 8"



WIENER
70-0960
19,5 cm, 7 3/4"



WIENER
70-0963
19,5 cm, 7 3/4"



BRAWLEY
70-0965
19,5 cm, 7 3/4"



WATSON-
WILLIAMS
70-0967
22 cm, 8 3/4"



Knochenfeilen
Bone Files
Limas para huesos
Limes à os
Lime per ossa

Raspeln
Rasps
Escofinas
Râpes
Raspe



20 mm

18 mm

1/2

PUTTI
47-0210
27 cm, 10 3/4"



10 mm

16 mm

1/2

PUTTI
47-0211
30 cm, 12"

13 mm



1/2

47-0200
24,5 cm, 9 3/4"



20 mm

1/2

47-0217
28,5 cm, 11 1/4"

Knochenfeilen
 Bone Files
 Limas para huesos
 Limes à os
 Lime per ossa

Raspeln
 Rasps
 Escofinas
 Râpes
 Raspe



20 mm



47-0218
 22 cm, 8 3/4"

Feilenhieb / Raspelhieb
 file cut / rasp cut
 filo de lima / filo de escofina
 coupe lime / coupe râpe
 taglio di lima / taglio di raspa

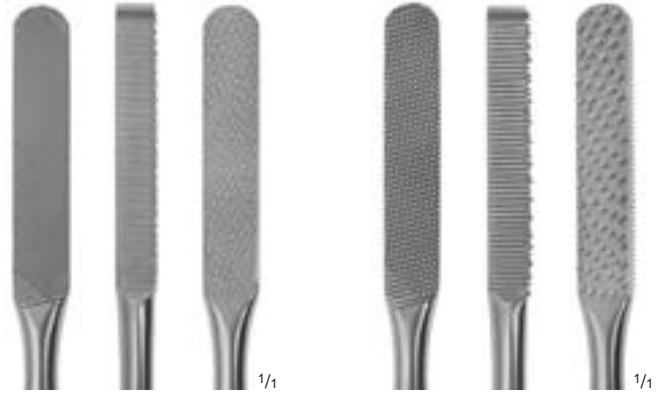

77-0350
 fein
 fine
 fina
 denture fine
 dentatura fina

▶ 77-0355
 grob
 coarse
 gruesa
 denture grosse
 dentatura grossa



FOMON
 77-0350
 - 77-0355
 21,5 cm, 8 1/2"

Feilenhieb / Raspelhieb
 file cut / rasp cut
 filo de lima / filo de escofina
 coupe lime / coupe râpe
 taglio di lima / taglio di raspa





TITE GRIP® Raspeln mit Hartmetalleinlagen
 TITE GRIP® Rasps with tungsten carbide inserts
 TITE GRIP® Escofinas con bocas de carburo tungsteno
 TITE GRIP® Râpes avec mors en tungstène
 TITE GRIP® Raspe con inserti in carburo di tungsteno



▶ 77-1330



77-1332



MILLER
 77-1330
 - 77-1332
 18,5 cm, 7 1/4"



Fig. 1

▶ 77-1340

12 Zähne
 12 teeth
 12 dientes
 12 dents
 12 denti



Fig. 2

77-1341

14 Zähne
 14 teeth
 14 dientes
 14 dents
 14 denti



Fig. 3

77-1342

16 Zähne
 16 teeth
 16 dientes
 16 dents
 16 denti



Fig. 4

77-1343

20 Zähne
 20 teeth
 20 dientes
 20 dents
 20 denti



Fig. 5

77-1344

24 Zähne
 24 teeth
 24 dientes
 24 dents
 24 denti



Fig. 6

77-1345

30 Zähne
 30 teeth
 30 dientes
 30 dents
 30 denti



Fig. 7

77-1346

36 Zähne
 36 teeth
 36 dientes
 36 dents
 36 denti



Fig. 8

77-1347

44 Zähne
 44 teeth
 44 dientes
 44 dents
 44 denti

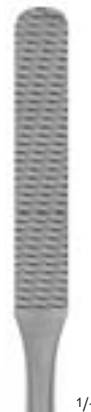

Fig. 9

77-1348

52 Zähne
 52 teeth
 52 dientes
 52 dents
 52 denti



Fig. 10

77-1349

62 Zähne
 62 teeth
 62 dientes
 62 dents
 62 denti



MALTZ
 77-1340
 - 77-1349
 21 cm, 8 1/4"

TITE GRIP® Raspeln mit Hartmetalleinlagen
 TITE GRIP® Rasps with tungsten carbide inserts
 TITE GRIP® Escofinas con bocas de carburo tungsteno
 TITE GRIP® Râpes avec mors en tungstène
 TITE GRIP® Raspe con inserti in carburo di tungsteno



Fig. 1



Fig. 3



Fig. 5



Fig. 7



Fig. 9

▶ 77-1350

12/14 Zähne
 12/14 teeth
 12/14 dientes
 12/14 dents
 12/14 denti

77-1351

16/20 Zähne
 16/20 teeth
 16/20 dientes
 16/20 dents
 16/20 denti

77-1352

24/30 Zähne
 24/30 teeth
 24/30 dientes
 24/30 dents
 24/30 denti

77-1353

36/44 Zähne
 36/44 teeth
 36/44 dientes
 36/44 dents
 36/44 denti

77-1354

52/62 Zähne
 52/62 teeth
 52/62 dientes
 52/62 dents
 52/62 denti



FOMON
 77-1350
 - 77-1354
 20,5 cm, 8"

Fig. 2



Fig. 4



Fig. 6

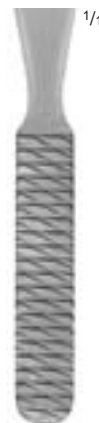

Fig. 8

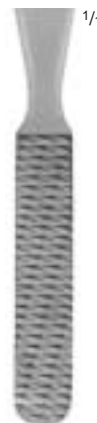

Fig. 10





Scharfe Löffel
 Bone Curettes
 Cucharillas cortantes
 Curettes
 Curette per ossa



HOUSE
66-0158
 15,5 cm, 6"



HOUSE
66-0159
 15 cm, 6"

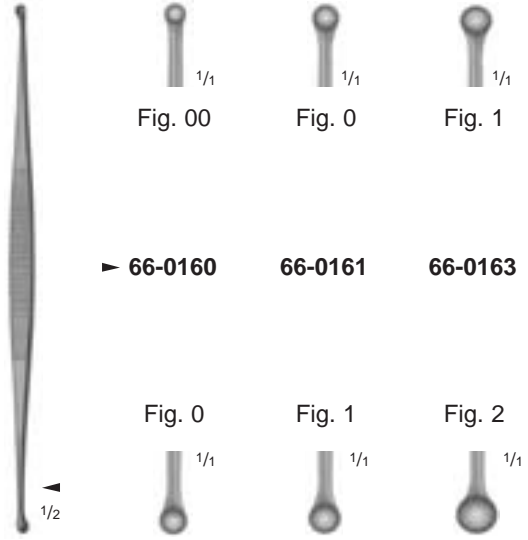

MARTINI
66-0160
 - **66-0163**
 14 cm, 5 1/2"

▶ **66-0160** **66-0161** **66-0163**

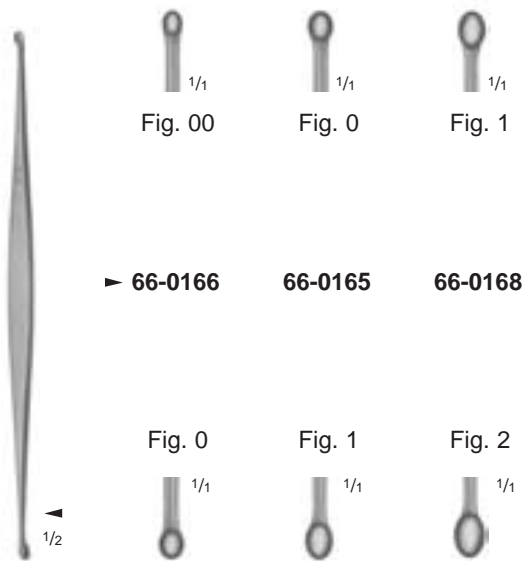
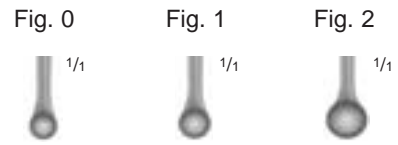

WILLIGER
66-0165
 - **66-0168**
 14 cm, 5 1/2"

▶ **66-0166** **66-0165** **66-0168**

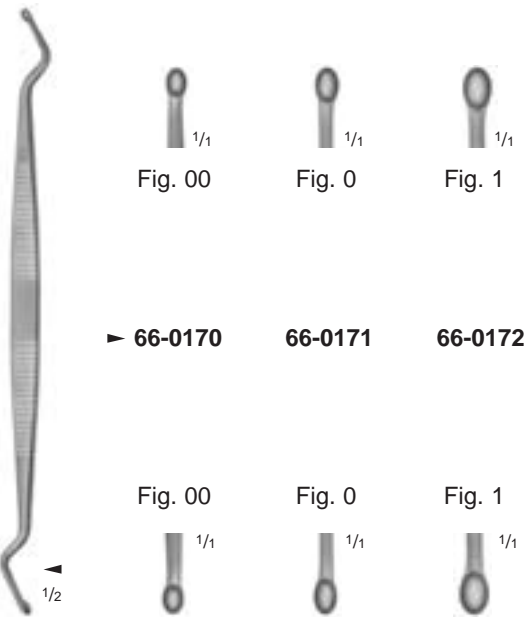
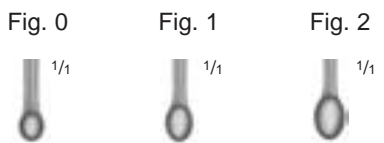

WILLIGER
66-0170
 - **66-0172**
 16 cm, 6 1/4"

▶ **66-0170** **66-0171** **66-0172**

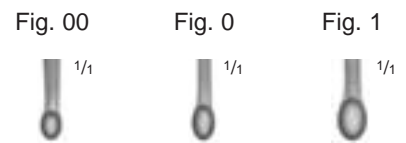



BARTH
66-0167
 18 cm, 7"



JANSEN
66-0162
 16 cm, 6 1/4"



JANSEN
47-0456
 15,5 cm, 6"



47-0425
 21 cm, 8 1/4"

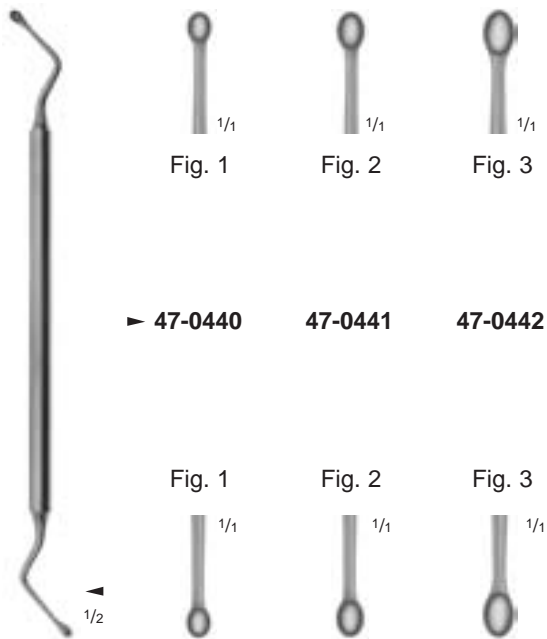

HEMINGWAY
47-0440
 - **47-0442**
 16,5 cm, 6 1/2"

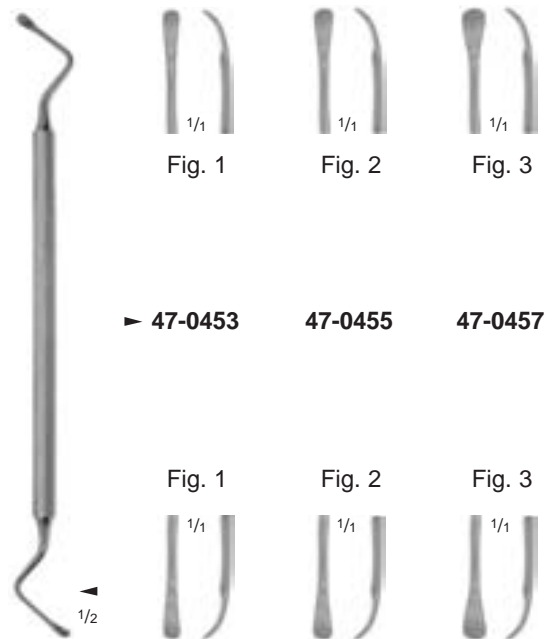

LUCAS
47-0453
 - **47-0457**
 16,5 cm, 6 1/2"



Scharfe Löffel
 Bone Curettes
 Cucharillas cortantes
 Curettes
 Curette per ossa

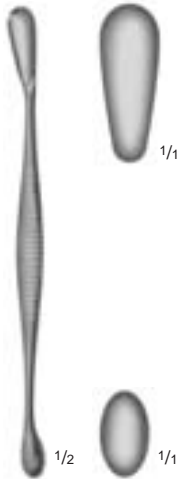

VOLKMANN
47-0400
 12,5 cm, 5"



VOLKMANN
47-0405
 16,5 cm, 6 1/2"



VOLKMANN
47-0410
 20,5 cm, 8"



VOLKMANN
47-0414
 13 cm, 5 1/8"



VOLKMANN
47-0415
 16,5 cm, 6 1/2"



VOLKMANN
47-0416
 20 cm, 8"



WILLIGER
47-0420
 - **47-0423**
 17,5 cm, 7"

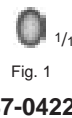
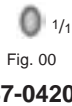

WILLIGER
47-0426
 - **47-0429**
 17,5 cm, 7"

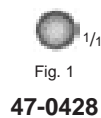
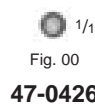

Scharfe Löffel
 Bone Currettes
 Cucharillas cortantes
 Currettes
 Curette per ossa



UFFENORDE
47-0430
 17 cm, 6^{3/4}"



UFFENORDE
47-0431
 17 cm, 6^{3/4}"



MOD. USA
47-0461
 - **47-0466**
 16 cm, 6^{1/4}"

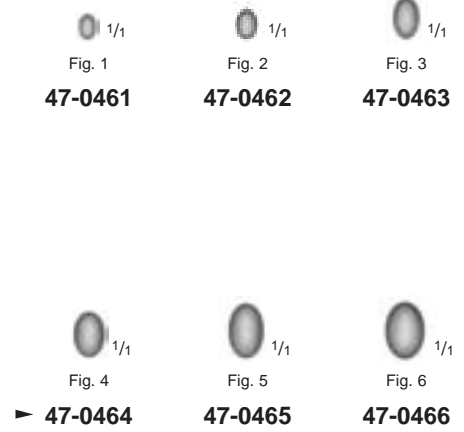

MOD. USA
47-0471
 - **47-0476**
 15,5 cm, 6"

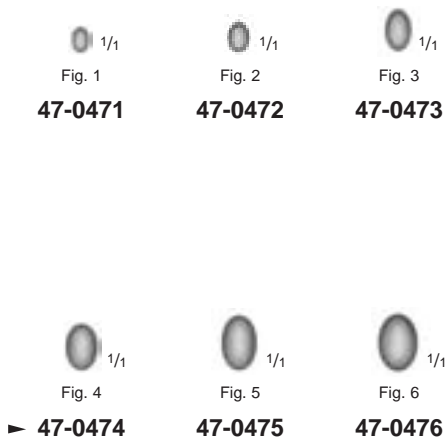

MOD. USA
47-0481
 - **47-0486**
 15,5 cm, 6"

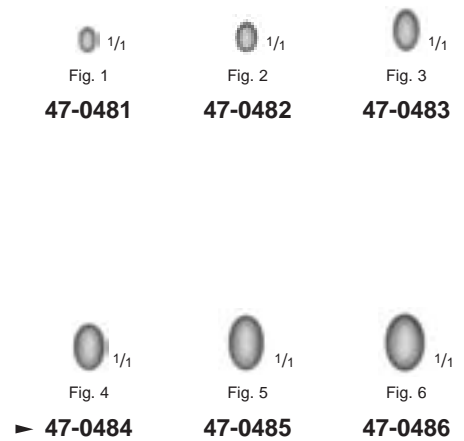



Scharfe Löffel
 Bone Currettes
 Cucharillas cortantes
 Currettes
 Curette per ossa

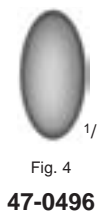
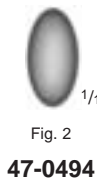
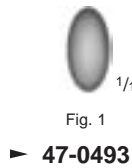
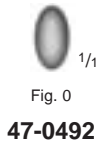

SCHUDE
47-0490
 - **47-0496**
 17,5 cm, 7"

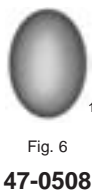
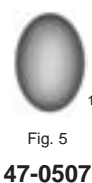
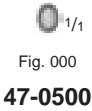
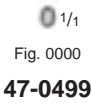

SPRATT
47-0499
 - **47-0508**
 17 cm, 6³/₄"

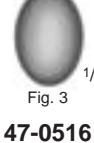
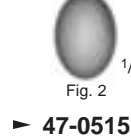
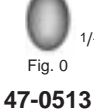

VOLKMANN
47-0510
 - **47-0519**
 17 cm, 6³/₄"

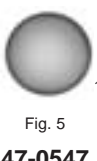
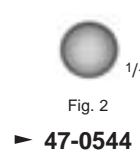

BRUNS
47-0539
 - **47-0548**
 17 cm, 6³/₄"



Fig. 000

47-0520



Fig. 00

47-0521



Fig. 0

47-0522



Fig. 1

47-0523



Fig. 2

47-0524



Fig. 3

▶ **47-0525**



Fig. 4

47-0526



Fig. 5

47-0527



Fig. 6

47-0528



BRUNS
47-0520
 - **47-0528**
 23 cm, 9"



Fig. 000

47-1520



Fig. 00

47-1521



Fig. 0

47-1522



Fig. 1

47-1523



Fig. 2

47-1524



Fig. 3

▶ **47-1525**



Fig. 4

47-1526



Fig. 5

47-1527



Fig. 6

47-1528



BRUNS
47-1520
 - **47-1528**
 22,5 cm, 9"



Fig. 000

47-0530



Fig. 00

47-0531



Fig. 0

47-0532



Fig. 1

47-0533



Fig. 2

47-0534



Fig. 3

▶ **47-0535**



Fig. 4

47-0536



Fig. 5

47-0537



Fig. 6

47-0538



BRUNS
47-0530
 - **47-0538**
 23 cm, 9"



Scharfe Löffel
 Bone Currettes
 Cucharillas cortantes
 Curettes
 Curette per ossa



- Fig. 00000 1/1
- 68-0310**
- Fig. 000 1/1
- 68-0311**
- Fig. 000 1/1
- 68-0312**
- Fig. 0 1/1
- 68-0314**
- Fig. 1 1/1
- 68-0315**

LEMPERT
68-0310
- 68-0315
 20,5 cm, 8"

1/2



biegsam
 malleable
 maleable
 malleables
 malleabile

- Fig. 1 1/1
- 71-0560**
- Fig. 2 1/1
- 71-0561**
- Fig. 3 1/1
- 71-0562**

HALLE
71-0560
- 71-0562
 21 cm, 8 1/4"

1/2



1/1

DAUBENSPECK
71-0580
 19,5 cm, 7 3/4"

1/2



- Fig. 000 1/1
- 47-1540**
- Fig. 00 1/1
- 47-1541**
- Fig. 0 1/1
- 47-1542**
- Fig. 1 1/1
- 47-1543**

47-1540
- 47-1543
 25 cm, 10"

1/2



- Fig. 000 1/1
- 47-1550**
- Fig. 00 1/1
- 47-1551**
- Fig. 0 1/1
- 47-1552**
- Fig. 1 1/1
- 47-1553**

47-1550
- 47-1553
 25 cm, 10"

1/2



- Fig. 000 1/1
- 47-1560**
- Fig. 00 1/1
- 47-1561**
- Fig. 0 1/1
- 47-1562**
- Fig. 1 1/1
- 47-1563**

47-1560
- 47-1563
 25 cm, 10"

1/2

Scharfe Löffel

Bone Currettes

Cucharillas cortantes

Currettes

Curette per ossa





 **47-1570**
2 mm

 **47-1571**
3 mm

 **47-1572**
4 mm

 **47-1573**
5 mm

 **47-1574**
6 mm

 **47-1575**
7 mm

 **47-1576**
8 mm

 **47-1577**
10 mm

 **47-1578**
12 mm

 **47-1579**
14 mm



47-1570
- **47-1579**
18 - 22 cm, 7" - 8 3/4"

schwedische Modelle
Swedish patterns
modelos sueco
modèles suédois
modelli svedese

 **47-1580**
ø 2 mm

 **47-1581**
ø 3 mm

 **47-1582**
ø 4 mm

 **47-1583**
ø 5 mm

 **47-1584**
ø 6 mm

 **47-1585**
ø 7 mm

 **47-1586**
ø 8 mm

 **47-1587**
ø 10 mm

 **47-1588**
ø 12 mm

 **47-1589**
ø 14 mm



47-1580
- **47-1589**
17 - 20 cm, 6 3/4" - 8"

schwedische Modelle
Swedish patterns
modelos sueco
modèles suédois
modelli svedese

 **95-0844**
Fig. 1

 **95-0845**
Fig. 2

 **95-0846**
Fig. 3

 **95-0847**
Fig. 4

 **95-0848**
Fig. 5

 **95-0849**
Fig. 6



SIMON
95-0844
- **95-0849**
24 cm, 9 1/2"



Scharfe Löffel
 Bone Currettes
 Cucharillas cortantes
 Curettes
 Curette per ossa

Stößel
 Tampers
 Pisón
 Chasse-Greffons
 Punzoni

 1/1
 Fig. 0000

47-1600

 1/1
 Fig. 000

47-1601

 1/1
 Fig. 00

47-1602

 1/1
 Fig. 0

47-1603

 1/1
 Fig. 1

47-1604

 1/1
 Fig. 2

▶ **47-1605**

 1/1
 Fig. 3

47-1606

 1/1
 Fig. 4

47-1607

 1/1
 Fig. 5

47-1608

 1/1
 Fig. 6

47-1609



1/2

VOLKMANN
47-1600
 - **47-1609**
 17,5 cm, 7"

Scharfe Löffel mit Ferrozellgriff
 Bone curettes with handle from artificial wood
 Cucharillas cortantes con mango de madera artificial
 Curettes avec manche en „Ferozell“
 Curette taglienti con manico in legno artificiale

 1/1
 Fig. 0000

47-1610

 1/1
 Fig. 000

47-1611

 1/1
 Fig. 00

47-1612

 1/1
 Fig. 0

47-1613

 1/1
 Fig. 1

47-1614

 1/1
 Fig. 2

▶ **47-1615**

 1/1
 Fig. 3

47-1616

 1/1
 Fig. 4

47-1617

 1/1
 Fig. 5

47-1618

 1/1
 Fig. 6

47-1619



1/2

VOLKMANN
47-1610
 - **47-1619**
 28 cm, 11"

Scharfe Löffel mit Ferrozellgriff
 Bone curettes with handle from artificial wood
 Cucharillas cortantes con mango de madera artificial
 Curettes avec manche en „Ferozell“
 Curette taglienti con manico in legno artificiale

Sterilisierbar im Autoklav bei 3 bar Überdruck (143°C) !
 Can be autoclaved at 3 bar overpressure (143°C) !
 Esterilizables en autoclave a 3 bar sobrepresión (143°C) !
 Stérilisables à l'autoclave à 3 bars (143°) !
 Può'essere autoclavato a 3 bar di pressione (143°) !

 1/1

46-0078

ø 2 mm

 1/1

46-0079

ø 3 mm

 1/1

46-0080

ø 4 mm

 1/1

▶ **46-0081**

ø 5 mm

 1/1

46-0082

ø 6 mm

 1/1

46-0083

ø 8 mm

 1/1

46-0084

ø 10 mm



1/2

46-0078
 - **46-0084**
 16 cm, 6 1/4"

Stößel
 Tampers
 Pisón
 Chasse-Greffons
 Punzoni

 1/1

46-0094

ø 3 mm

 1/1

▶ **46-0095**

ø 5 mm

 1/1

46-0096

ø 8 mm

 1/1

46-0097

ø 12 mm

 1/1

46-0098

ø 14 mm

 1/1

46-0099

ø 16 mm



1/2

46-0094
 - **46-0099**
 20 cm, 8"

Stößel mit Ferrozellgriff
 Tampers with handle from artificial wood
 Pisón con mango de madera artificial
 Chasse-Greffons avec manche en „Ferozell“
 Punzone con manico in legno artificiale

Osteotome

Osteotomes
Osteótomos
Ostéotomes
Osteotomi

Flachmeißel

Chisels
Cinceles
Ciseaux-burins
Scalpelli

Hohlmeißel

Gouges
Gubias
Gouges
Sgorbie



HOKE

46-0002 2 mm
46-0003 3 mm
▶ **46-0004** 4 mm
46-0005 5 mm
46-0006 6 mm
46-0007 7 mm
46-0008 8 mm
14 cm, 5 1/2"

Osteotome
Osteotomes
Osteótomos
Ostéotomes
Osteotomi



HOKE

46-0012 2 mm
46-0013 3 mm
▶ **46-0014** 4 mm
46-0015 5 mm
46-0016 6 mm
46-0017 7 mm
46-0018 8 mm
14 cm, 5 1/2"

Osteotome
Osteotomes
Osteótomos
Ostéotomes
Osteotomi

4 mm



FREER

71-0655
17 cm, 6 3/4"

Flachmeißel
Chisel
Cinzel
Ciseaux-burins
Scalpelli

4 mm



FREER

71-0656
17 cm, 6 3/4"

Flachmeißel
Chisel
Cinzel
Ciseaux-burins
Scalpelli

4 mm



WEST

63-2900
16 cm, 6 1/4"

Flachmeißel
Chisel
Cinzel
Ciseaux-burins
Scalpelli

4 mm



WEST

63-2905
16 cm, 6 1/4"

Hohlmeißel
Gouge
Gubia
Gouges
Sgorbie

6 mm



WEST

63-2901
19 cm, 7 1/2"

Flachmeißel
Chisel
Cinzel
Ciseaux-burins
Scalpelli

6 mm



WEST

63-2906
19 cm, 7 1/2"

Hohlmeißel
Gouge
Gubia
Gouges
Sgorbie



Osteotome

Osteotomes

Osteótomos

Ostéotomes

Osteotomi



COTTLE

- 77-0630** 4 mm
- ▶ **77-0631** 6 mm
- 77-0632** 8 mm
- 77-0633** 10 mm
- 77-0634** 12 mm
- 18 cm, 7"

mit Graduierung
with depth markings
graduado
gradué
graduato



COTTLE

- 77-0620**
- 18 cm, 7"

mit Graduierung
with depth markings
graduado
gradué
graduato

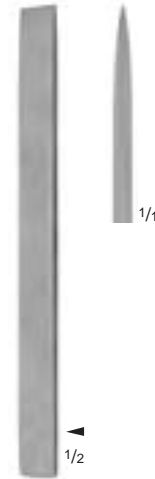

MINI-LAMBOTTE

- 46-0149** 2 mm
- 46-0150** 3 mm
- 46-0151** 4 mm
- 46-0152** 6 mm
- 46-0153** 8 mm
- ▶ **46-0154** 10 mm
- 46-0155** 12 mm
- 46-0157** 15 mm
- 12,5 cm, 5"



MINI-LAMBOTTE

- 46-0350** 2 mm
- 46-0351** 3 mm
- 46-0352** 4 mm
- ▶ **46-0353** 6 mm
- 46-0354** 8 mm
- 46-0355** 10 mm
- 46-0356** 12 mm
- 46-0357** 15 mm
- 17 cm, 6³/₄"

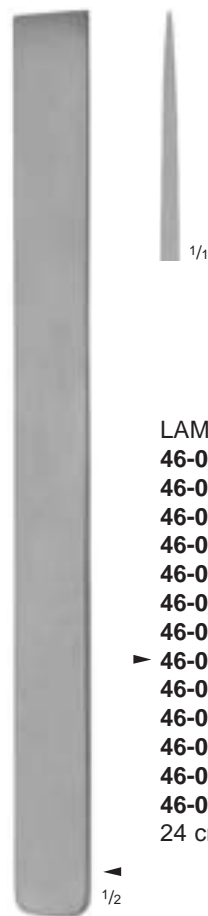

LAMBOTTE

- 46-0360** 4 mm
- 46-0170** 6 mm
- 46-0361** 8 mm
- 46-0362** 10 mm
- 46-0172** 13 mm
- 46-0363** 15 mm
- 46-0364** 18 mm
- ▶ **46-0174** 20 mm
- 46-0176** 25 mm
- 46-0177** 30 mm
- 46-0178** 38 mm
- 46-0365** 44 mm
- 46-0366** 50 mm
- 24 cm, 9¹/₂"

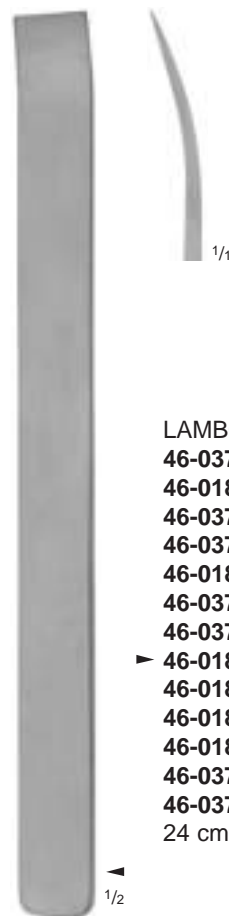

LAMBOTTE

- 46-0370** 4 mm
- 46-0180** 6 mm
- 46-0371** 8 mm
- 46-0372** 10 mm
- 46-0182** 13 mm
- 46-0373** 15 mm
- 46-0374** 18 mm
- ▶ **46-0184** 20 mm
- 46-0186** 25 mm
- 46-0187** 30 mm
- 46-0188** 38 mm
- 46-0375** 44 mm
- 46-0376** 50 mm
- 24 cm, 9¹/₂"

Osteotome

Osteotomes
Osteótomos
Ostéotomes
Osteotomi

Flachmeißel

Chisels
Cinceles
Ciseaux-burins
Scalpelli

Hohlmeißel

Gouges
Gubias
Gouges
Sgorbie



1/1

- 46-0020** 4 mm
46-0022 6 mm
46-0024 8 mm
▶ **46-0026** 10 mm
46-0028 12 mm
13,5 cm, 5 1/4"

Osteotome
Osteotomes
Osteótomos
Ostéotomes
Osteotomi

1/2



1/1

- 46-0030** 4 mm
46-0032 6 mm
46-0034 8 mm
▶ **46-0036** 10 mm
46-0038 12 mm
13,5 cm, 5 1/4"

Flachmeißel
Chisels
Cinceles
Ciseaux-burins
Scalpelli

1/2



1/1

- 46-0040** 4 mm
46-0042 6 mm
46-0044 8 mm
▶ **46-0046** 10 mm
46-0048 12 mm
13,5 cm, 5 1/4"

Hohlmeißel
Gouges
Gubias
Gouges
Sgorbie

1/2



1/1

- ALEXANDER**
67-0391 4 mm
67-0392 6 mm
67-0393 8 mm
▶ **67-0394** 10 mm
67-0395 12 mm
17,5 cm, 7"

Osteotome
Osteotomes
Osteótomos
Ostéotomes
Osteotomi

1/2



1/1

- ALEXANDER**
67-0371 4 mm
67-0372 6 mm
67-0373 8 mm
▶ **67-0374** 10 mm
67-0375 12 mm
17,5 cm, 7"

Flachmeißel
Chisels
Cinceles
Ciseaux-burins
Scalpelli

1/2



1/1

- ALEXANDER**
67-0381 4 mm
67-0382 6 mm
67-0383 8 mm
▶ **67-0384** 10 mm
67-0385 12 mm
17,5 cm, 7"

Hohlmeißel
Gouges
Gubias
Gouges
Sgorbie

1/2



Osteotome

Osteotomes
Osteótomos
Ostéotomes
Osteotomi

Flachmeißel

Chisels
Cinceles
Ciseaux-burins
Scalpelli

Hohlmeißel

Gouges
Gubias
Gouges
Sgorbie



STILLE

46-0380 10 mm
46-0381 12 mm
▶ **46-0382** 15 mm
46-0383 20 mm
46-0384 25 mm
20,5 cm, 8"

Osteotome
Osteotomes
Osteótomos
Ostéotomes
Osteotomi



STILLE

46-0248 8 mm
46-0250 10 mm
46-0252 12 mm
46-0255 15 mm
▶ **46-0260** 20 mm
46-0265 25 mm
46-0270 30 mm
20,5 cm, 8"

Osteotome
Osteotomes
Osteótomos
Ostéotomes
Osteotomi



STILLE

46-0200 10 mm
46-0202 12 mm
46-0205 15 mm
▶ **46-0210** 20 mm
46-0215 25 mm
20,5 cm, 8"

Flachmeißel
Chisels
Cinceles
Ciseaux-burins
Scalpelli



STILLE

46-0225 10 mm
46-0227 12 mm
46-0230 15 mm
▶ **46-0235** 20 mm
46-0240 25 mm
20,5 cm, 8"

Hohlmeißel
Gouges
Gubias
Gouges
Sgorbie

Osteotome, Flachmeißel und Hohlmeißel mit Ferrozellgriff

Osteotomes, Chisels and Gouges with handle from artificial wood
 Osteótomos, cinceles y gubias con mango de madera artificial
 Ostéotomes, ciseaux-burins et gouges avec manche en „Ferozell“
 Osteotomi, scalpelli e sgorbie con manico in legno artificiale



Sterilisierbar im Autoklav bei 3 bar Überdruck (143°C) !
 Can be autoclaved at 3 bar overpressure (143°C) !
 Esterilizables en autoclave a 3 bar sobrepresión (143°C) !
 Stérilisables à l'autoclave à 3 bars (143°) !
 Può essere autoclavato a 3 bar di pressione (143°) !



46-0900
 18,5 cm, 7 1/4"

Meißelgriff für auswechselbare Klinsen mit Spannschlüssel (46-0901)

Handle for interchangeable blades, with key (46-0901)

Mango para hojas intercambiables, con llave (46-0901)

Manche pour lames interchangeables avec clef (46-0901)

Manico per lame intercambiabili, con chiave (46-0901)



46-0902 5 mm

46-0903 10 mm

46-0904 16 mm

► **46-0905** 25 mm

Auswechselbare Osteotomklingen

Interchangeable osteotome blades

Osteótomos, hojas intercambiables

Lames-ostéotomes interchangeables

Lame intercambiabili per osteotomo



46-0906 5 mm

46-0907 10 mm

46-0908 16 mm

► **46-0909** 25 mm

Auswechselbare Flachmeißelklingen

Interchangeable chisel blades

Cinceles, hojas intercambiables

Lames-ciseaux-burins interchangeables

Lame a scalpello intercambiabili

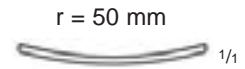

46-0910

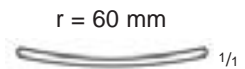

46-0911



46-0912



46-0910 25 mm (r = 50 mm)

46-0911 25 mm (r = 60 mm)

► **46-0912** 25 mm (r = 70 mm)

Auswechselbare Hohlmeißelklingen

Interchangeable gouges blades

Gubias, hojas intercambiables

Lames-gouges interchangeables

Lame a sgorbia intercambiabili



Osteotome und Hohlmeißel mit Ferrozellgriff

Osteotomes and Gouges with handle from artificial wood

Osteótomos y gubias con mango de madera artificial

Ostéotomes et gouges avec manche en „Ferozell“

Osteotomi e sgorbie con manico in legno artificiale

Sterilisierbar im Autoklav bei 3 bar Überdruck (143°C) !

Can be autoclaved at 3 bar overpressure (143°C) !

Esterilizables en autoclave a 3 bar sobrepresión (143°C) !

Stérilisables à l'autoclave à 3 bars (143°) !

Puo'essere autoclavato a 3 bar di pressione (143°) !



MINI-LEXER

- 46-0050** 4 mm
- 46-0051** 6 mm
- ▶ **46-0052** 8 mm
- 46-0053** 10 mm
- 46-0054** 12 mm
- 18 cm, 7"

Osteotome
Osteotomes
Osteótomos
Ostéotomes
Osteotomi



MINI-LEXER

- 46-0060** 4 mm
- 46-0061** 6 mm
- ▶ **46-0062** 8 mm
- 46-0063** 10 mm
- 46-0064** 12 mm
- 18 cm, 7"

Hohlmeißel
Gouges
Gubias
Gouges
Sgorbie



LEXER

- 46-0801** 5 mm
- 46-0802** 7 mm
- 46-0803** 10 mm
- 46-0805** 15 mm
- ▶ **46-0806** 20 mm
- 46-0807** 25 mm
- 46-0808** 30 mm
- 22 cm, 8³/₄"

Osteotome
Osteotomes
Osteótomos
Ostéotomes
Osteotomi



LEXER

- 46-0811** 5 mm
- 46-0812** 7 mm
- 46-0813** 10 mm
- 46-0815** 15 mm
- ▶ **46-0816** 20 mm
- 46-0817** 25 mm
- 46-0818** 30 mm
- 22 cm, 8³/₄"

Hohlmeißel
Gouges
Gubias
Gouges
Sgorbie

Osteotome, Hohlmeißel und Flachmeißel mit Ferrozellgriff

Osteotomes, Gouges and Chisels with handle from artificial wood
 Osteótomos, gubias y cinceles con mango de madera artificial
 Ostéotomes, gouges et ciseaux-burins avec manche en „Ferozell“
 Osteotomi, sgorbie e scalpelli con manico in legno artificiale



LEXER
 ▶ 46-0920 10 mm
 ▶ 46-0921 15 mm
 27,5 cm, 10³/₄“

Osteotome, abgewinkelt
 Osteotomes, angled
 Osteótomos, acodados
 Ostéotomes, angulés
 Osteotomi, angolati



LEXER
 ▶ 46-0925 10 mm
 ▶ 46-0926 15 mm
 27,5 cm, 10³/₄“

Hohlmeißel, abgewinkelt
 Gouges, angled
 Gubias, acodadas
 Gouges, angulées
 Sgorbie, angolati



▶ 46-0930 10 mm
 ▶ 46-0931 15 mm
 16 cm, 6¹/₄“

Flachmeißel
 Chisels
 Cinceles
 Ciseaux-burins
 Scalpelli



▶ 46-0940 10 mm
 ▶ 46-0941 15 mm
 ▶ 46-0942 20 mm
 20 cm, 8“

Flachmeißel
 Chisels
 Cinceles
 Ciseaux-burins
 Scalpelli



▶ 46-0945 10 mm
 ▶ 46-0946 15 mm
 ▶ 46-0947 20 mm
 20 cm, 8“

Flachmeißel
 Chisels
 Cinceles
 Ciseaux-burins
 Scalpelli



Flachmeißel und Hohlmeißel mit Ferrozellgriff

Chisels and Gouges with handle from artificial wood

Cinceles y gubias con mango de madera artificial

Ciseaux-burins et gouges avec manche en „Ferozell“

ScalPELLi e sgorbie con manico in legno artificiale

Sterilisierbar im Autoklav bei 3 bar Überdruck (143°C) !

Can be autoclaved at 3 bar overpressure (143°C) !

Esterilizables en autoclave a 3 bar sobrepresión (143°C) !

Stérilisables à l'autoclave à 3 bars (143°) !

Puo'essere autoclavato a 3 bar di pressione (143°) !

20 mm



46-0950

24,5 cm, 9³/₄"

Flachmeißel
Chisel
Cinzel
Ciseaux-burins
Scalpello

16 mm



46-0952

26,5 cm, 10¹/₂"

Flachmeißel
Chisel
Cinzel
Ciseaux-burins
Scalpello

9 mm



46-0954

22 cm, 8³/₄"

**Hohlmeißel zum Freilegen
abgebrochener Schrauben**

Gouge for removing
broken screws

Gubia para exteriorizar
tornillos truncados

Gouge pour extraire
les vis cassées

Sgorbie per rimuovere
viti rotte



ZIELKE

46-0956 5,5 mm

▶ **46-0958** 9,0 mm

23 cm, 9"

**Hohlmeißel für Skoliose-
Operationen**

Gouges for scoliosis
operations

Gubias para operaciones
scoliosis

Gouge pour scoliose

Sgorbie per interventi
di scoliosi

Hohlmeißel mit Ferrozellgriff

Gouges with handle from artificial wood

Gubias con mango de madera artificial

Gouges avec manche en „Ferozell“

Sgorbie con manico in legno artificiale



Sterilisierbar im Autoklav bei 3 bar Überdruck (143°C) !

Can be autoclaved at 3 bar overpressure (143°C) !

Esterilizables en autoclave a 3 bar sobrepresión (143°C) !

Stérilisables à l'autoclave à 3 bars (143°) !

Puo'essere autoclavato a 3 bar di pressione (143°) !



46-0960 5 mm

▶ **46-0961** 10 mm

46-0962 15 mm

25 cm, 10"

Spongiosa-Hohlmeißel

Spongiosa gouges

Gubias de esponjosa

Ciseaux-burins spongiose

Sgorbie per tessuto osseo spugnoso



46-0965 5 mm

▶ **46-0966** 10 mm

46-0967 15 mm

25 cm, 10"

Spongiosa-Hohlmeißel

Spongiosa gouges

Gubias de esponjosa

Ciseaux-burins spongiose

Sgorbie per tessuto osseo spugnoso



LEXER

▶ **46-0822** 7 mm

46-0823 10 mm

28,5 cm, 11 1/4"

Spongiosa-Hohlmeißel

Spongiosa gouges

Gubias de esponjosa

Ciseaux-burins spongiose

Sgorbie per tessuto osseo spugnoso



Hohlmeißel mit Ferrozellgriff

Gouges with handle from artificial wood

Gubias con mango de madera artificial

Gouges avec manche en „Ferozell“

Sgorbie con manico in legno artificiale

Sterilisierbar im Autoklav bei 3 bar Überdruck (143°C) !

Can be autoclaved at 3 bar overpressure (143°C) !

Esterilizables en autoclave a 3 bar sobrepresión (143°C) !

Stérilisables à l'autoclave à 3 bars (143°) !

Puo'essere autoclavato a 3 bar di pressione (143°) !

8 mm



COBB

46-0970

27,5 cm, 10^{3/4}“

**Spinal-Hohlmeißel,
gerade**

Spinal gouge,
straight

Gubia espinal,
recta

Gouge spinale,
droite

Sgorbie spinali,
rette

8 mm



COBB

46-0971

27 cm, 10^{3/4}“

**Spinal-Hohlmeißel,
leicht gebogen**

Spinal gouge,
light curved

Gubia espinal,
ligeramente curva

Gouge spinale,
légèrement courbe

Sgorbie spinali,
legermente curve

8 mm



COBB

46-0972

27 cm, 10^{3/4}“

**Spinal-Hohlmeißel,
stark gebogen**

Spinal gouge,
strong curved

Gubia espinal,
fuertemente curva

Gouge spinale,
forte courbure

Sgorbie spinali,
molto curve

8 mm



COBB

46-0973

27 cm, 10^{3/4}“

**Spinal-Hohlmeißel,
nach hinten gebogen**

Spinal gouge,
curved backwards

Gubia espinal,
fuertemente curva

Gouge spinale,
contre coudée

Sgorbie spinali,
angolate

Hämmer

Mallets
Martillos
Maillets
Martelli



ø 20 mm
140 g

47-0101
16,5 cm, 6 1/2"
mit Bleifüllung
lead filled head
cabezal relleno
de plomo
tête en plomb
testa di piombo

1/2



ø 20 mm
100 g

47-0102
16,5 cm, 6 1/2"

1/2



ø 26 mm
260 g

LUCAE
47-0110
19,5 cm, 7 3/4"

1/2



ø 26 mm
300 g

WILLIGER
47-0136
24 cm, 9 1/2"

1/2



ø 22 mm
165 g

47-0103
19 cm, 7 1/2"
mit Bleifüllung
lead filled head
cabezal relleno
de plomo
tête en plomb
testa di piombo

1/2



ø 27 mm
140 g

HAJEK
47-0109
20 cm, 8"

1/2



ø 20 mm
110 g

HAJEK
47-0108
21,5 cm, 8 1/2"

1/2



ø 30 mm
220 g

COLLIN
47-0132
20 cm, 8"

1/2



Hämmer

Mallets
Martillos
Maillets
Martelli

47-0133
ø 25 mm
120 g

▶ **47-0134**
ø 30 mm
180 g

47-0135
ø 35 mm
260 g



DOYEN
47-0133
- **47-0135**
19,5 cm, 7 3/4"

ø 25 mm
210 g



GERZOG
47-0100
19 cm, 7 1/2"
mit Bleifüllung
lead filled head
cabezal relleno
de plomo
tête en plomb
testa di piombo

ø 40 mm
700 g



KIRK
47-0105
21 cm, 8 1/4"

ø 20 mm
185 g



MEAD
47-0115
19 cm, 7 1/2"

mit auswechselbaren
Kunststoffbacken (47-0195)
with interchangeable plastic
disks (47-0195)
con tapas de plástico inter-
cambiables (47-0195)
avec masse plastique inter-
changeable (47-0195)
con piastre di plastica inter-
cambiabili (47-0195)

ø 25 mm
140 g



47-0117
18,5 cm, 7 1/4"
mit auswechselbaren
Kunststoffbacken (47-0197)
with interchangeable plastic
disks (47-0197)
con tapas de plástico inter-
cambiables (47-0197)
avec masse plastique inter-
changeable (47-0197)
con piastre di plastica inter-
cambiabili (47-0197)

Hämmer mit Ferrozellgriff

Mallets with handle from artificial wood
Martillos con mango de madera artificial
Maillets avec manche en „Ferozell“
Martelli con manico in legno artificiale



ø 30 mm
215 g



47-0111
25 cm, 10"

mit auswechselbaren
Kunststoffbacken (47-0191)

with interchangeable plastic
disks (47-0191)

con tapas de plástico inter-
cambiables (47-0191)

avec masse plastique inter-
changeable (47-0191)

con piastre di plastica inter-
cambiabili (47-0191)

47-0118
ø 32 mm
390 g

▶ **47-0119**
ø 35 mm
540 g

47-0120
ø 40 mm
740 g



47-0118
- **47-0120**
24 cm, 9 1/2"

ø 45 mm
250 g



47-0140
26 cm, 10 1/4"

aus Ferrozell, mit
Bleifüllung

from artificial wood,
lead filled head

de madera artificial, cabe-
zal relleno de plomo

manche bois, Ferrozell,
tête en plomb

in legno artificiale,
testa di piombo

47-0142
ø 35 mm
120 g

▶ **47-0143**
ø 42 mm
170 g

47-0141
ø 50 mm
220 g



47-0141
- **47-0143**
26 cm, 10 1/4"

aus Ferrozell
from artificial wood
de madera artificial
entièrement en Ferrozell
in legno artificiale



Hämmer

Mallets
Martillos
Maillets
Martelli

ø 30 mm
240 g



COTTLE
47-0116
19 cm, 7 1/2"

1 Seite flach
1 Seite convex

1 side flat
1 side convex
1 lado plano
1 lado convexo
1 côte plat
1 côte convexe
1 lato piatto
1 lato convesso

ø 40 mm
700 g



HEATH
47-0121
18,5 cm, 7 1/4"

mit Kupferfüllung
copper filled head
cabezal relleno
de cobre
tête en cuivre
testa di rame

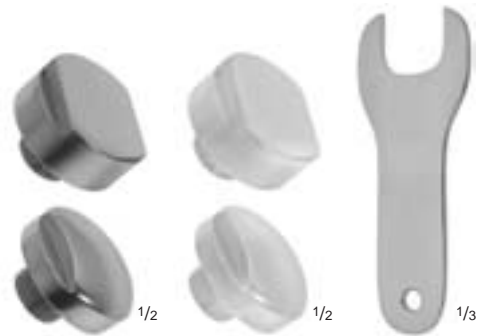

47-0147

47-0148

47-0149

ø 35 mm
170/260 g



WAGNER
47-0146
24,5 cm, 9 3/4"

mit 1 Paar Metallbacken (47-0147), 1 Paar Kunststoffbacken (47-0148) und 1 Schlüssel (47-0149)

with 1 pair of metal disks (47-0147), 1 pair of plastic disks (47-0148) and 1 wrench (47-0149)

con 1 par de tapas de metal (47-0147), 1 par de tapas de plástico (47-0148) y 1 llave (47-0149)

avec 1 paire de disques métalliques (47-0147), 1 paire de disques plastiques (47-0148) et 1 clef plate (47-0149)

con 1 paio de piastre di metallo (47-0147), 1 paio de piastre di plastica (47-0148) e 1 chiave (47-0149)

Hämmer

Mallets
Martillos
Maillets
Martelli



ø 30 mm
300 g



1/2

BERGMANN
47-0129
23,5 cm, 9 1/4"

ø 45 mm
300 g



1/2

BERGMANN
47-0126
25 cm, 10"

ø 29/42 mm
400 g



1/2

47-0150
25 cm, 10"

ø 40 mm
550 g



1/2

OMBREDANNE
47-0127
25 cm, 10"



Repositionszangen
 Reposition Forceps
 Pinzas para reducción
 Pincas à réduction
 Pinze per riposizioni



45-0123
 13,5 cm, 5 1/4"

für Kieferrepositionen
 for maxillary reposition
 para la reducción maxilar
 pour reposition du maxillaire
 per riposizione mascellare



45-0127
 13 cm, 5 1/8"

für Kleinfragmente
 for small fragments
 para fragmentos pequeños
 pour petits fragments
 per piccoli framenti



45-0131
 20,5 cm, 8"



45-0133
 13,5 cm, 5 1/4"



45-0135
 14 cm, 5 1/2"



LEWIN
45-0130
 17,5 cm, 7"

Repositionszangen

Reposition Forceps
Pinzas para reducción
Pincès à réduction
Pinze per riposizioni

Sequesterzangen

Sequestrum Forceps
Pinzas para secuestro
Pincès à séquestre
Pinze per frammento osseo



45-0136

17 cm, 6³/₄"

Repositionszange
Reposition forceps
Pinza para reducción
Pincès à réduction
Pinza per riposizioni

1/2



45-0138

24 cm, 9¹/₂"

Repositionszange
Reposition forceps
Pinza para reducción
Pincès à réduction
Pinza per riposizioni

1/2



45-0140

18,5 cm, 7¹/₄"

Patellazange
Patella forceps
Pinza patella
Pincès patella
Pinza per rotula

1/2



45-0348

20 cm, 8"

Sequesterzange
Sequestrum forceps
Pinza para secuestro
Pincès à séquestre
Pinze per frammento osseo

1/2



45-0349

20 cm, 8"

Sequesterzange
Sequestrum forceps
Pinza para secuestro
Pincès à séquestre
Pinze per frammento osseo

1/2



VAN BUREN

45-0350

23 cm, 9"

Sequesterzange
Sequestrum forceps
Pinza para secuestro
Pincès à séquestre
Pinze per frammento osseo

1/2



Knochenhaltezangen

Bone Holding Forceps

Pinzas para huesos

Daviers

Tenaglie per ossa



DINGMANN
48-0435
18,5 cm, 7 1/4"



DINGMANN modif.
48-0436
18,5 cm, 7 1/4"

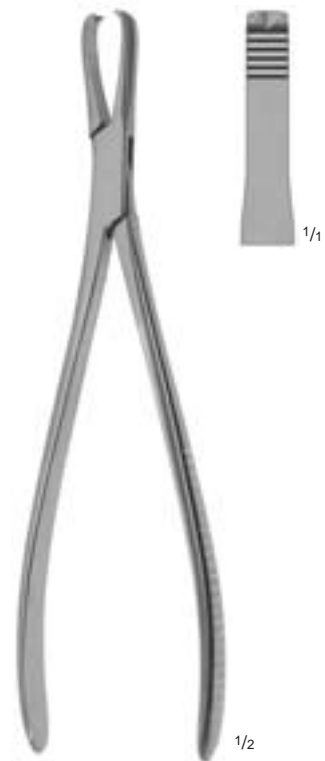

45-0099
20 cm, 8"



LANGENBECK
45-0100
19,5 cm, 7 3/4"



FERGUSON
45-0110
20,5 cm, 8"

Knochenhaltezangen

Bone Holding Forceps

Pinzas para huesos

Daviers

Tenaglie per ossa



KERN-MINI
45-0159
17 cm, 6³/₄"

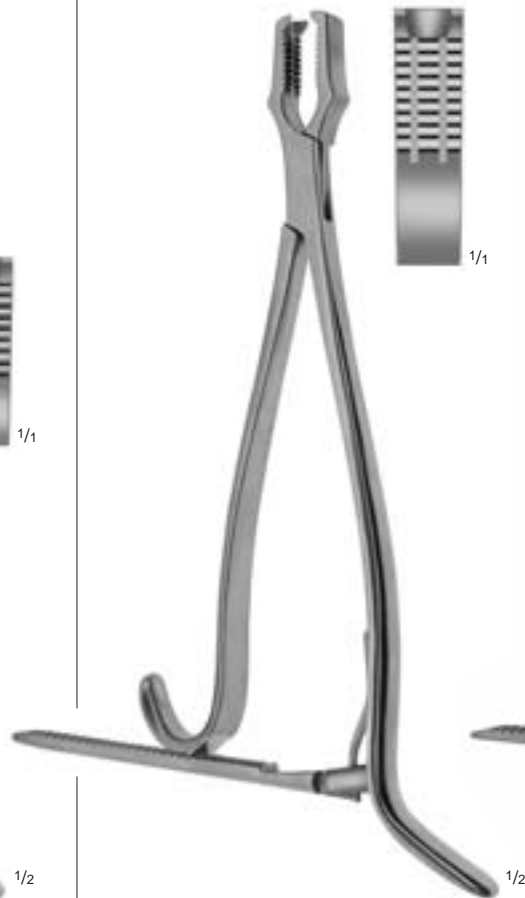

KERN-LANE
45-0161
23,5 cm, 9¹/₄"

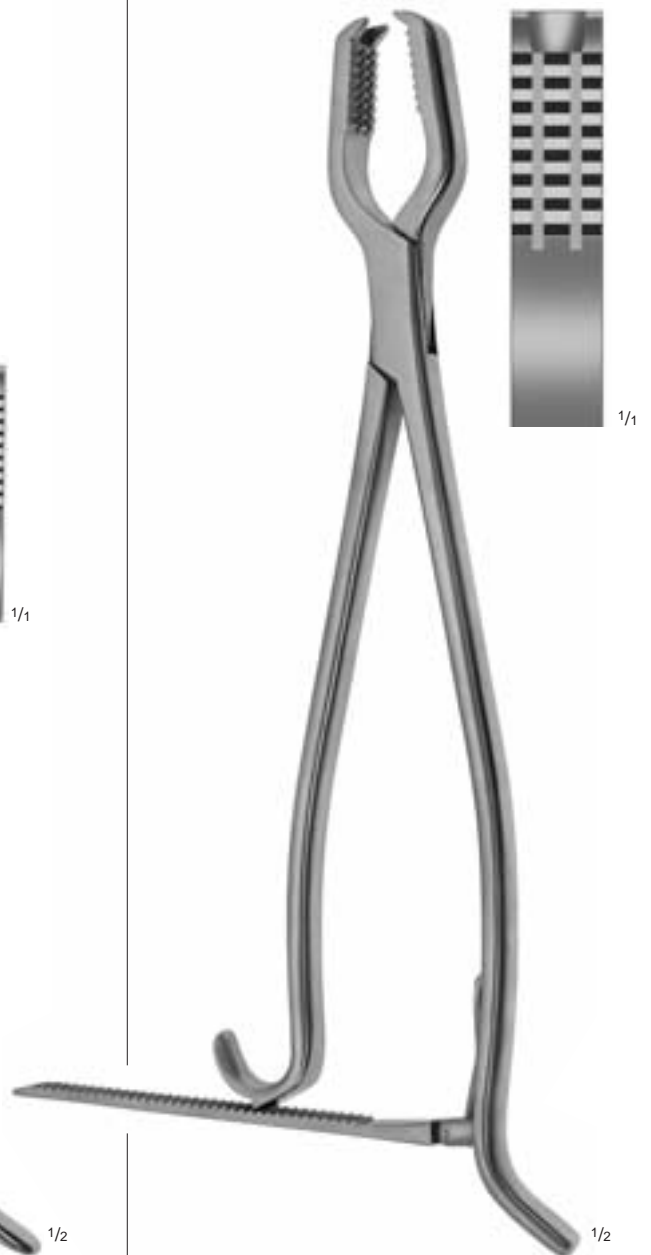

LANE
45-0150
33 cm, 13"



Knochenhaltezangen

Bone Holding Forceps

Pinzas para huesos

Daviers

Tenaglie per ossa



1/1



1/2

FARABEUF-LAMBOTTE

45-0175

25,5 cm, 10"

verstellbar
adjustable
ajustable
à crémaillère
regolabili



1/2

LAMBOTTE

45-0185

- **45-0187**

verstellbar, 1 Maulteil beweglich
adjustable, 1 jaw swiveled
ajustable, 1 mandibula movable
à crémaillère, 1 mors mobile
regolabili, 1 mandibola mobile



9 mm

1/1

► **45-0185**

22 cm, 8³/₄"



10 mm

1/1

45-0186

27 cm, 10³/₄"



11 mm

1/1

45-0187

30,5 cm, 12"

Knochenhaltezangen

Bone Holding Forceps

Pinzas para huesos

Daviers

Tenaglie per ossa



14 mm

1/4



1/2

LAMBOTTE

45-0188

21 cm, 8 1/4"

verstellbar, 1 Maulteil beweglich
adjustable, 1 jaw swiveled
ajustable, 1 mandibula movable
à crémaillère, 1 mors mobile
regolabili, 1 mandibola mobile



1/2

ULRICH

45-0112

- **45-0118**



5,0 mm

1/4

45-0112

18 cm, 7"



7,5 mm

1/4

45-0114

23 cm, 9"



8,0 mm

1/4

45-0116

25 cm, 10"



8,5 mm

1/4

► **45-0118**

28 cm, 11"



Knochenhaltezangen

Bone Holding Forceps

Pinzas para huesos

Daviers

Tenaglie per ossa

9 mm



1/1

45-0191
25 cm, 10"

6 mm



1/1

45-0190
17,5 cm, 7"



1/1

12,5 mm



1/1

45-0193
27 cm, 10³/₄"

11,5 mm



1/1

▶ **45-0192**
26,5 cm, 10¹/₂"



1/2

VERBRUGGE

45-0190

- 45-0193

mit Lappenverschluß
with lip joint
con cierre de labio
avec fermeture à lambeaux
con chiusura a tela

Knochenhaltezangen

Bone Holding Forceps

Pinzas para huesos

Daviers

Tenaglie per ossa



1/1



2,5 mm

1/1

45-0230
15 cm, 6"



6,5 mm

1/1

45-0231
19 cm, 7 1/2"

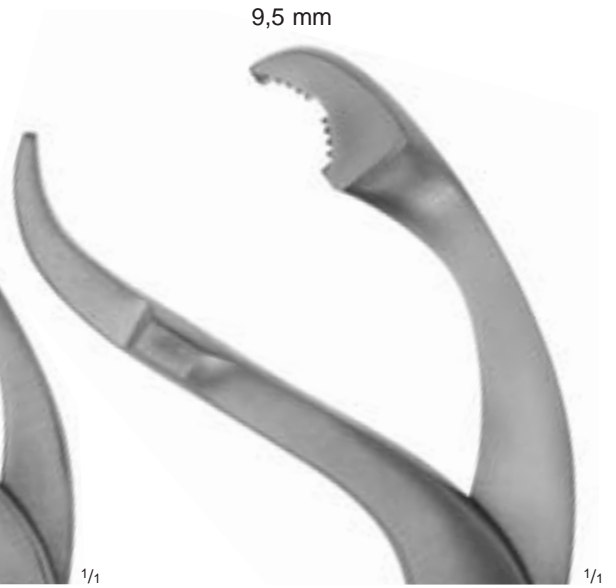

9,5 mm

1/1

45-0232
24 cm, 9 1/2"



1/2



10,0 mm

1/1

45-0233
26 cm, 10 1/4"



11,0 mm

1/1

45-0234
28 cm, 11"

45-0230
- 45-0234

selbstzentrierend mit Gewindesperre
self-centering forceps with thread fixation
autocentrante con cremallera de tuerca
autostatique, à crémaillère
pinze autocentranti con blocco di filettatura



Knochenhalteklammern

Bone Clamps
Pinzas porta-huesos
Daviers
Tenaglie per ossa

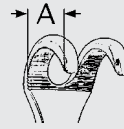

LOWMAN

- 45-0216 12 cm, 4³/₄" / 19 mm (A)
- ▶ 45-0212 18 cm, 7" / 25 mm (A)
- 45-0214 21 cm, 8¹/₄" / 29 mm (A)



LOWMAN

- 45-0201 12 cm, 4³/₄" / 19 mm (A)
- ▶ 45-0202 18 cm, 7" / 25 mm (A)
- 45-0205 21 cm, 8¹/₄" / 29 mm (A)



LOWMAN-LAMBERT

- 45-0225
21 cm, 8¹/₄" / 29 mm (A)



LOWMAN-HOGLUND

- 45-0208
18 cm, 7" / 25 mm (A)

1 Maulteil beweglich
1 jaw swiveled
1 mandibula movibile
1 mors mobile
1 mandibola mobile

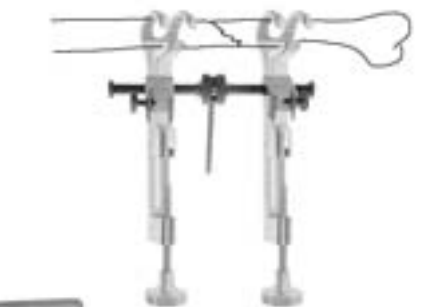

GERSTER
45-0280

Distractionsklammer für Knochen-
halteklammern

Traction bar for bone clamps

Barra de tracción para pinzas
porta-huesos

Tracteur pour daviers

Barra di trazione per tenaglie
per ossa

Hohlmeißelzangen

Bone Rongeurs

Pinzas-gubias

Pinces-gouges

Pinze per ossa



LUER-FRIEDMAN
45-0628
13 cm, 5 1/8"

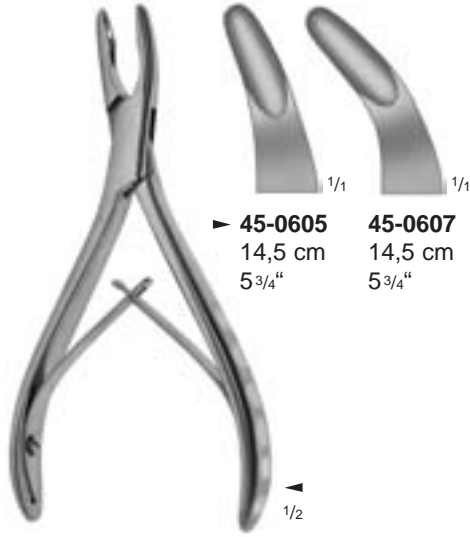

LUER
45-0605
- **45-0607**

▶ **45-0605**
14,5 cm
5 3/4"

45-0607
14,5 cm
5 3/4"

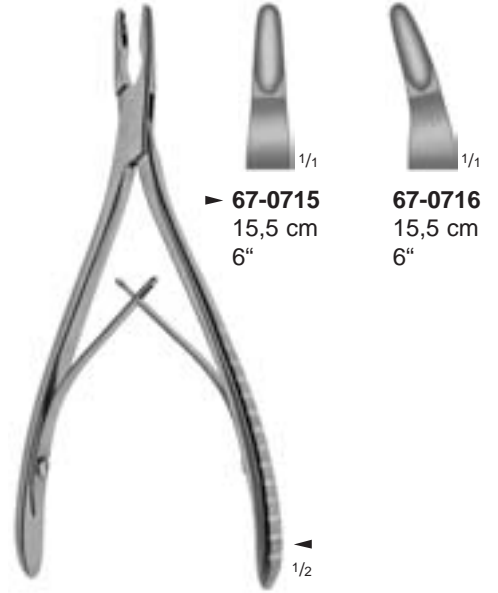

LEMPERT
67-0715
- **67-0716**

▶ **67-0715**
15,5 cm
6"

67-0716
15,5 cm
6"



BLUMENTHAL
99-0099
- **99-0101**

▶ **99-0099**
15,5 cm
6"

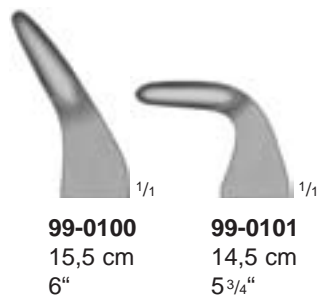

99-0100
15,5 cm
6"

99-0101
14,5 cm
5 3/4"



MEAD
67-0654
16,5 cm, 6 1/2"

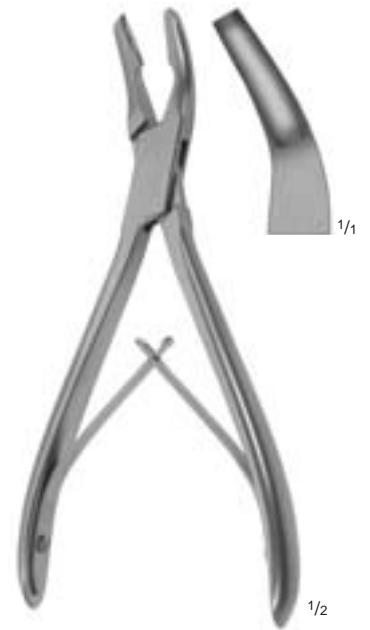

MEAD
67-0656
16,5 cm, 6 1/2"



Hohlmeißelzangen

Bone Rongeurs

Pinzas-gubias

Pinces-gouges

Pinze per ossa

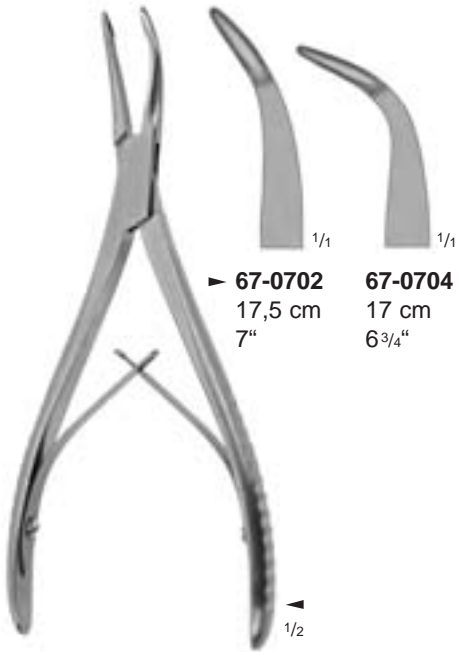

▶ **67-0702** 17,5 cm
7"

67-0704 17 cm
6³/₄"

STELLBRING
67-0702
- **67-0704**



BEYER
45-0613
17 cm, 6³/₄"

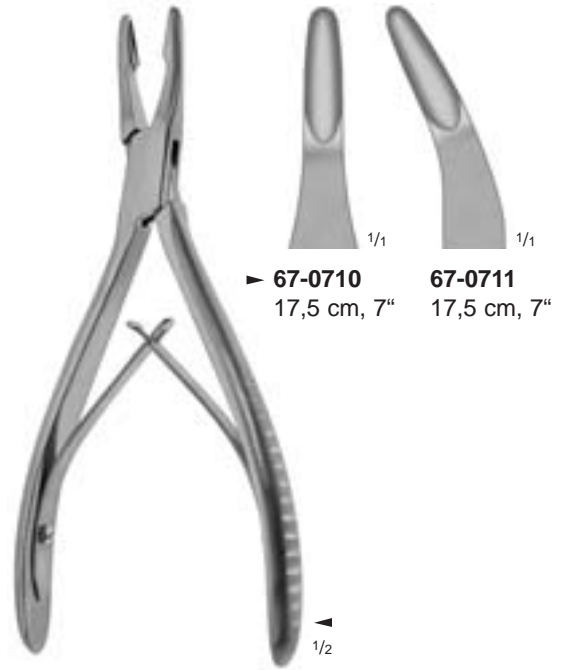

▶ **67-0710** 17,5 cm, 7"

67-0711 17,5 cm, 7"

JANSEN
67-0710
- **67-0711**

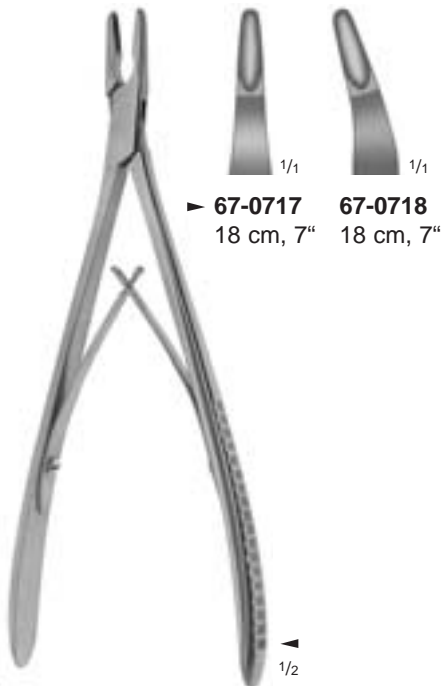

▶ **67-0717** 18 cm, 7"

67-0718 18 cm, 7"

LEMPERT
67-0717
- **67-0718**



JANSEN
67-0712
19 cm, 7¹/₂"

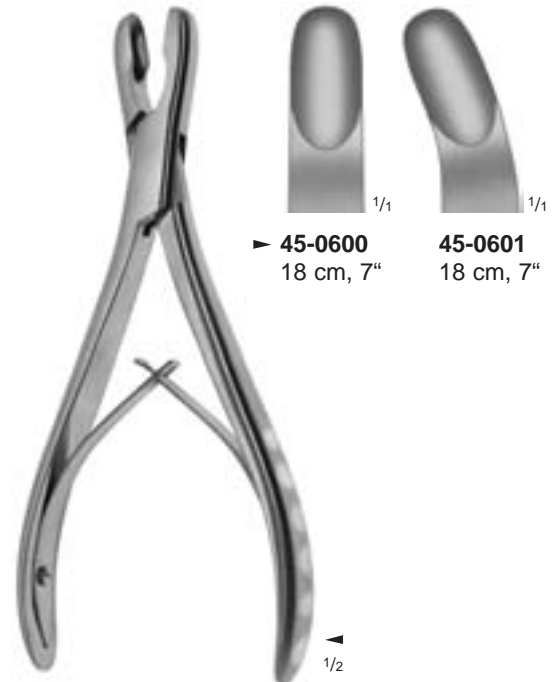

▶ **45-0600** 18 cm, 7"

45-0601 18 cm, 7"

LUER
45-0600
- **45-0601**

Hohlmeißelzangen

Bone Rongeurs
Pinzas-gubias
Pincès-gouges
Pinze per ossa



▶ **45-0460**
15 cm, 6"

45-0462
15 cm, 6"

BÖHLER
45-0460
- **45-0462**



MAYFIELD
45-0509
17,5 cm, 7"

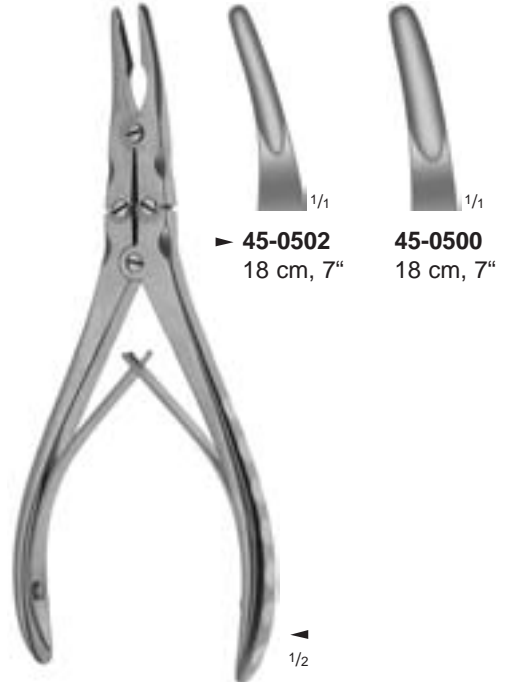

▶ **45-0502**
18 cm, 7"

45-0500
18 cm, 7"

BEYER
45-0500
- **45-0502**



ZAUFAL-JANSEN
45-0505
18 cm, 7"

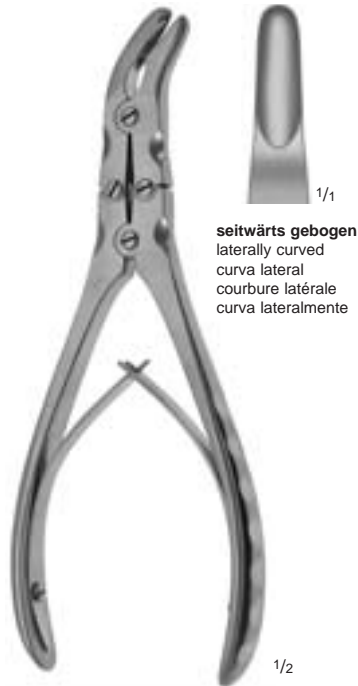

RUSKIN
38-0435
18 cm, 7"

seitwärts gebogen
laterally curved
curva lateral
courbure latérale
curva lateralmente

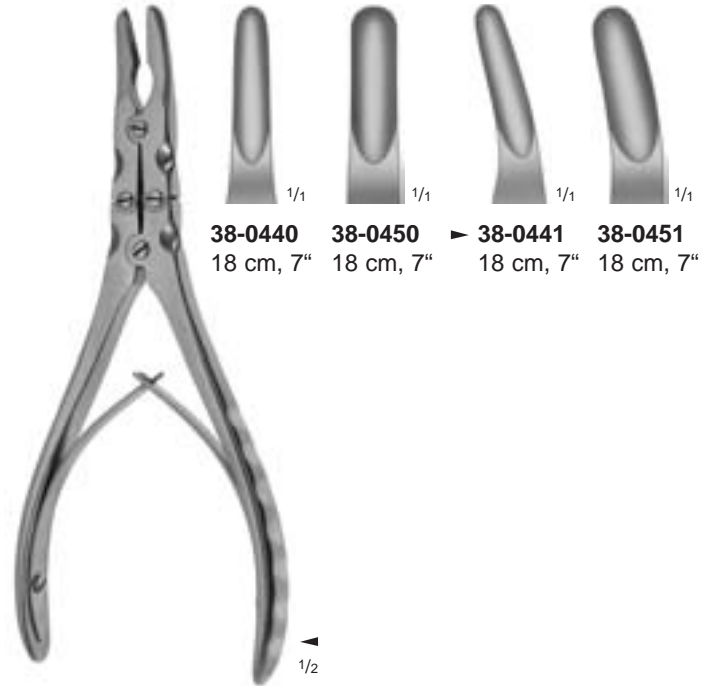

38-0440
18 cm, 7"

38-0450
18 cm, 7"

▶ **38-0441**
18 cm, 7"

38-0451
18 cm, 7"

RUSKIN
38-0440
- **38-0451**



Hohlmeißelzangen

Bone Rongeurs
Pinzas-gubias
Pincès-gouges
Pinze per ossa



MARQUARDT
45-0507
20 cm, 8"



38-0442
20,5 cm, 8"

▶ **38-0443**
20,5 cm, 8"

RUSKIN
38-0442
- **38-0443**

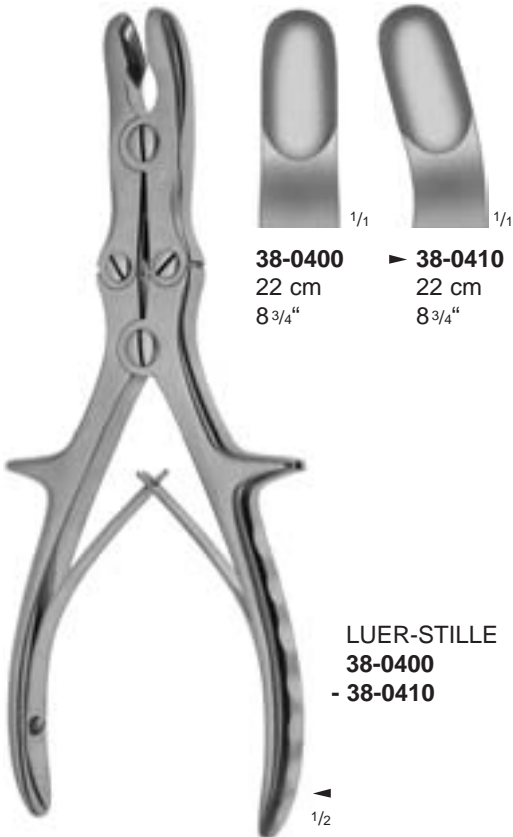

38-0400 ▶ **38-0410**
22 cm 22 cm
8 3/4" 8 3/4"

LUER-STILLE
38-0400
- **38-0410**

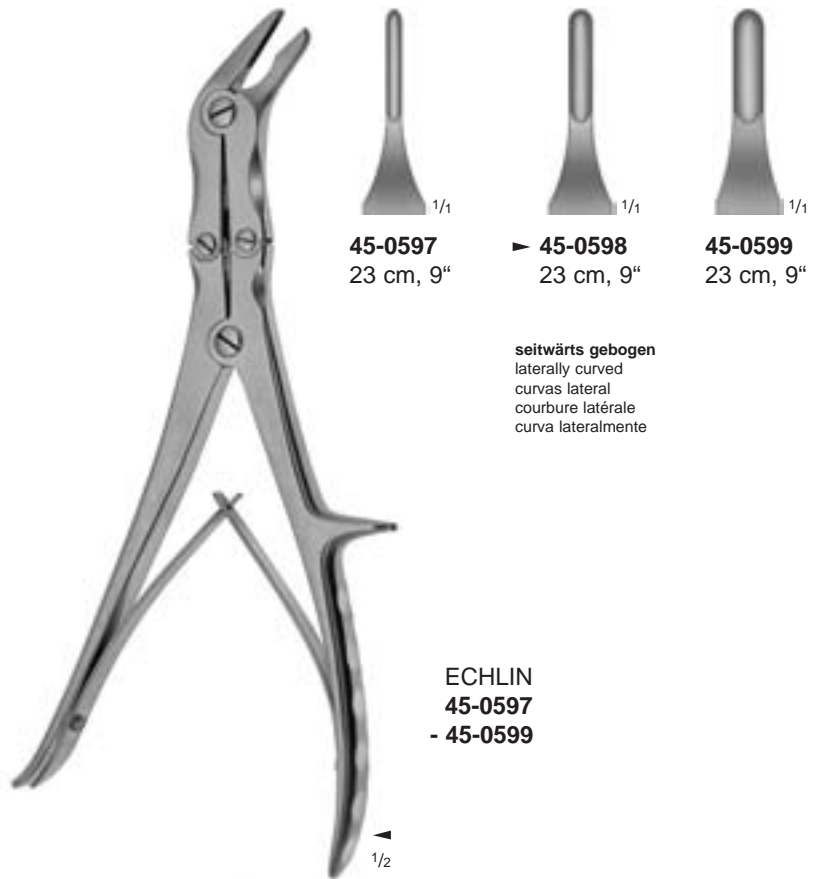

45-0597
23 cm, 9"

▶ **45-0598**
23 cm, 9"

45-0599
23 cm, 9"

seitwärts gebogen
laterally curved
curvas lateral
courbure latérale
curva lateralmente

ECHLIN
45-0597
- **45-0599**

Hohlmeißelzangen

Bone Rongeurs

Pinzas-gubias

Pinces-gouges

Pinze per ossa



1/1



1/1



1/1

38-0501

24,5 cm, 9³/₄"

▶ **38-0500**

24,5 cm, 9³/₄"



1/1



1/1

38-0503

24 cm, 9¹/₂"

▶ **38-0502**

24 cm, 9¹/₂"



1/2

STILLE

38-0425

23 cm, 9"

seitwärts gebogen
laterally curved
curvas lateral
courbure latérale
curva lateralmente



1/2

LEKSELL-STILLE

38-0500

- **38-0501**

seitwärts gebogen
laterally curved
curvas lateral
courbure latérale
curva lateralmente



1/2

FRYKHOLM

38-0502

- **38-0503**

seitwärts gebogen
laterally curved
curvas lateral
courbure latérale
curva lateralmente



Hohlmeißelzangen

Bone Rongeurs

Pinzas-gubias

Pinces-gouges

Pinze per ossa



1/1



1/1



1/1



1/1



1/1

38-0405
25 cm, 10"

▶ **38-0415**
25 cm, 10"



1/2

STILLE-RUSKIN
38-0455
23,5 cm, 9 1/4"



1/2

RÖTTGEN-RUSKIN
38-0460
24 cm, 9 1/2"



1/2

LUER-STILLE
38-0405
- **38-0415**



1/2

LUER-STILLE
38-0703
27 cm, 10 3/4"

Knochensplitterzangen

Bone Cutting Forceps

Pinzas cortantes para huesos

Pinces coupantes

Cesoie per ossa



LITTAUER-LISTON
45-0430
15,5 cm, 6"



KAZANJIAN
78-0120
18,5 cm, 7 1/4"



CLEVELAND
45-0431
15 cm, 6"



CLEVELAND
45-0433
17 cm, 6 3/4"



LISTON
45-0400
- **45-0406**

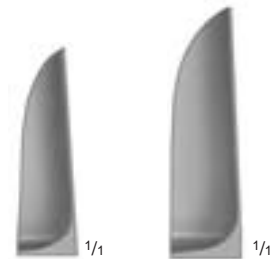

45-0400
14 cm
5 1/2"

45-0402
17 cm
6 3/4"



45-0404
19,5 cm
7 3/4"

45-0406
22 cm
8 3/4"



LISTON
45-0410
- **45-0416**

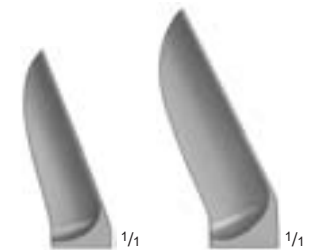

45-0410
14 cm
5 1/2"

45-0412
17 cm
6 3/4"

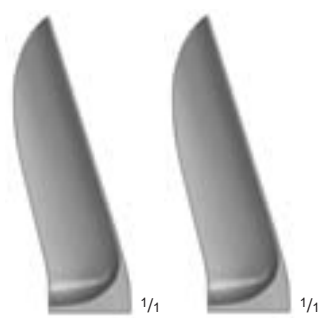

45-0414
19,5 cm
7 3/4"

45-0416
22 cm
8 3/4"



Knochensplitterzangen

Bone Cutting Forceps

Pinzas cortantes para huesos

Pinces coupantes

Cesoie per ossa



WALTON-LISTON (BÖHLER)
45-0428
14,5 cm, 5³/₄"



WALTON-LISTON (BÖHLER)
45-0429
14,5 cm, 5³/₄"



MC INDOE
45-0485
17,5 cm, 7"



RUSKIN
38-0470
18 cm, 7"



RUSKIN
38-0471
18 cm, 7"



RUSKIN-LISTON
45-0490
18,5 cm, 7¹/₄"

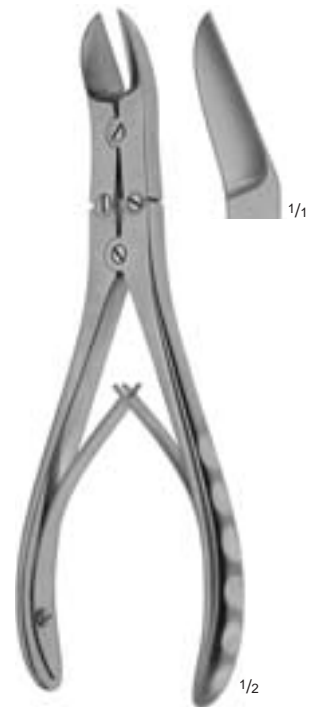

RUSKIN-LISTON
45-0491
18,5 cm, 7¹/₄"

Knochensplitterzangen

Bone Cutting Forceps

Pinzas cortantes para huesos

Pinces coupantes

Cesoie per ossa



LISTON
38-0345
24 cm, 9 1/2"



LISTON
38-0350
27 cm, 10 3/4"



LISTON
38-0355
27 cm, 10 3/4"



Meniskus- und Knorpelfaßzangen

Meniscus and Cartilage Grasping Forceps

Pinzas para menisco y cartilago

Pinces à ménisque et cartilage

Pinza da presa per menisco e cartillagine

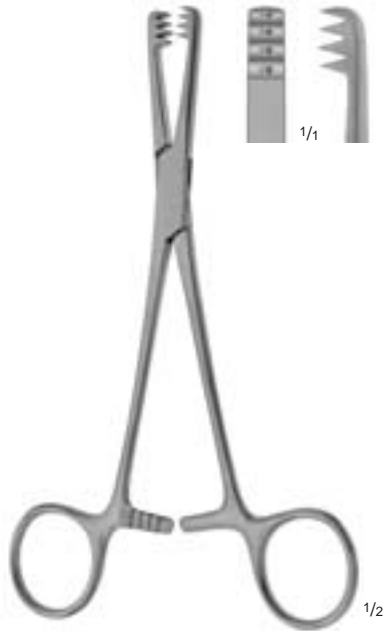

MARTIN
48-0400
16,5 cm, 6 1/2"



MARTIN
48-0405
18,5 cm, 7 1/4"



MARTIN
48-0406
20,5 cm, 8"

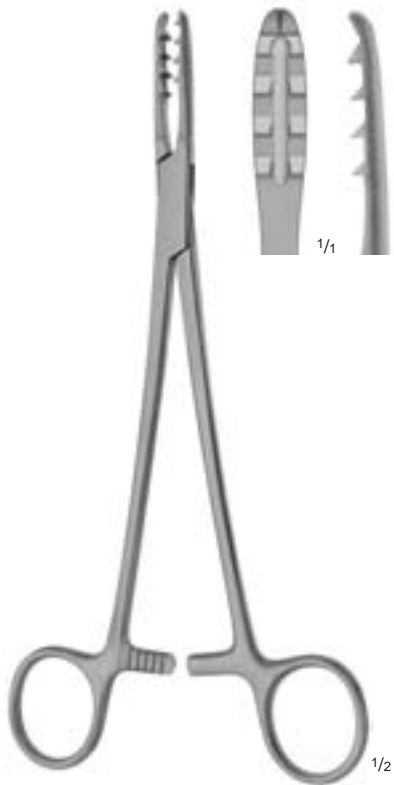

BIRCHER-GANSKE
48-0412
20,5 cm, 8"



BIRCHER-GANSKE
48-0415
20,5 cm, 8"

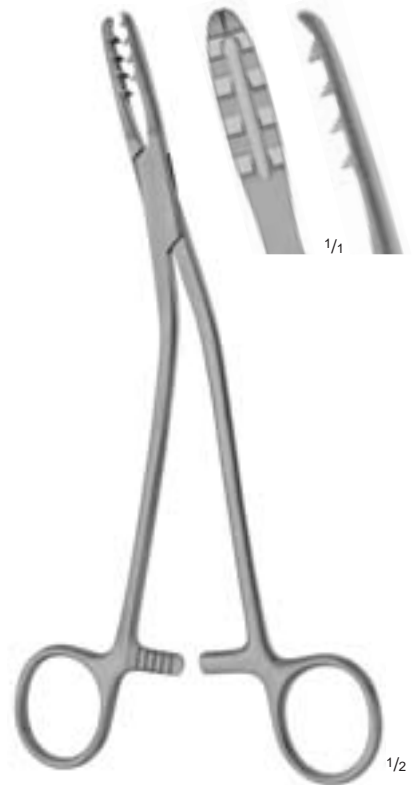

BIRCHER-GANSKE
48-0416
20,5 cm, 8"

Wund- und Meniskushaken

Retractors for Knee
 Separadores para rodilla
 Ecarteurs pour genou
 Retrattori per ginocchio

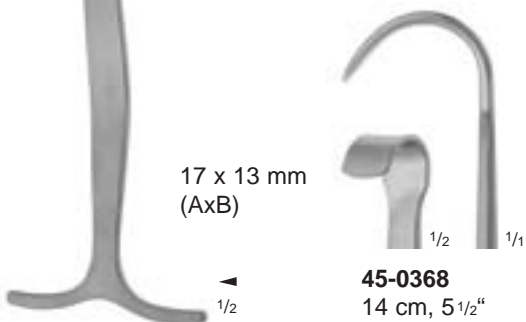
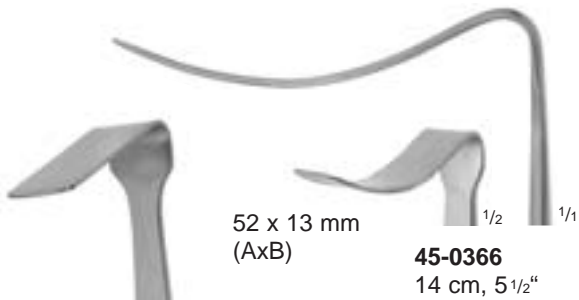
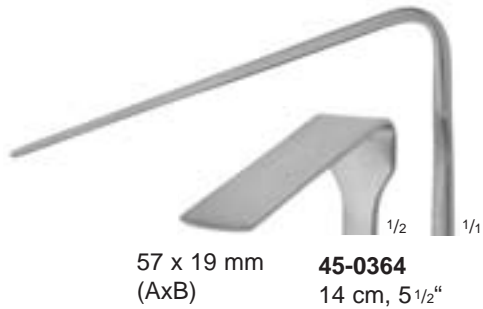
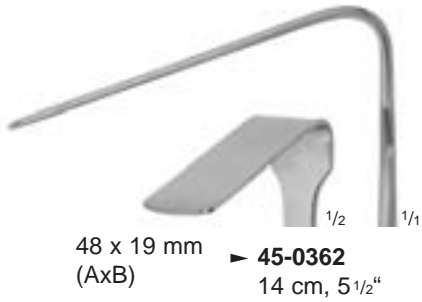
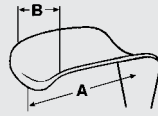

SMILLIE
45-0360
 - **45-0368**

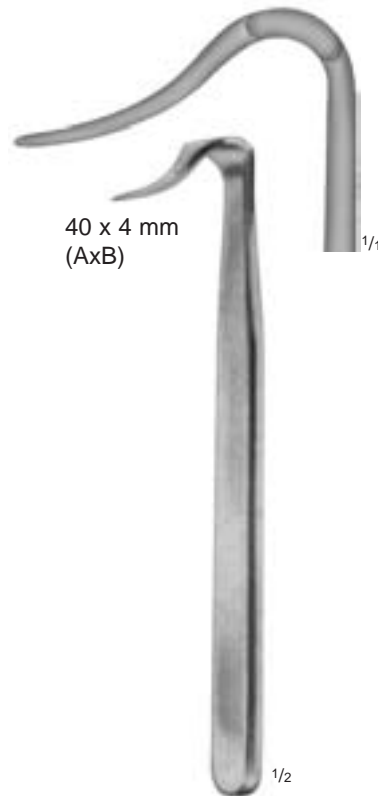
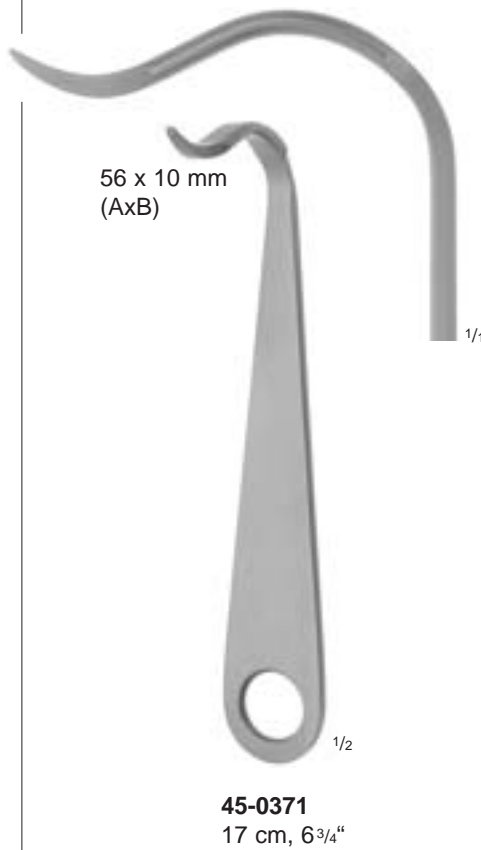

BLOUNT
45-0375
 17,5 cm, 7"



45-0370
 21 cm, 8 1/4"



Meniskusmesser

Meniscus Knives
Bisturíes para menisco
Bistouris à ménisque
Bisturi per menisco

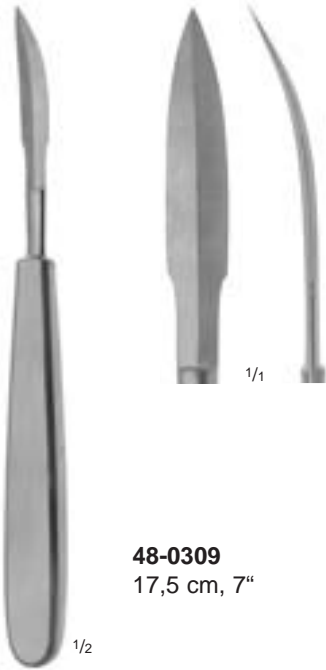

48-0309
17,5 cm, 7"

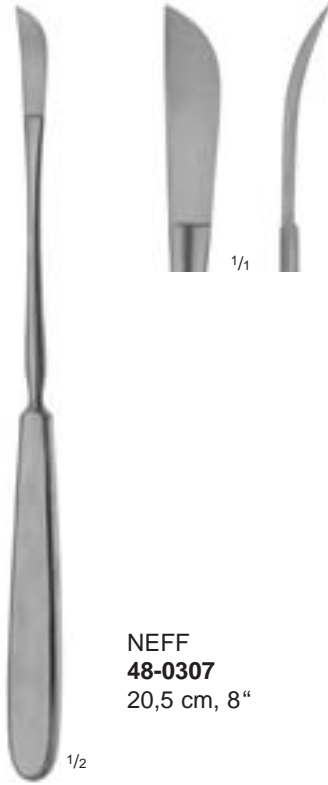

NEFF
48-0307
20,5 cm, 8"

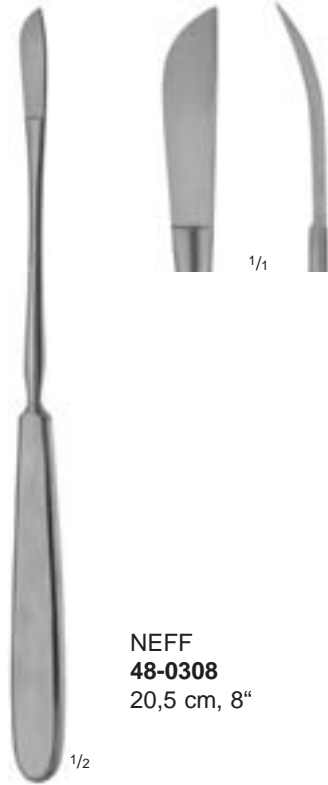

NEFF
48-0308
20,5 cm, 8"

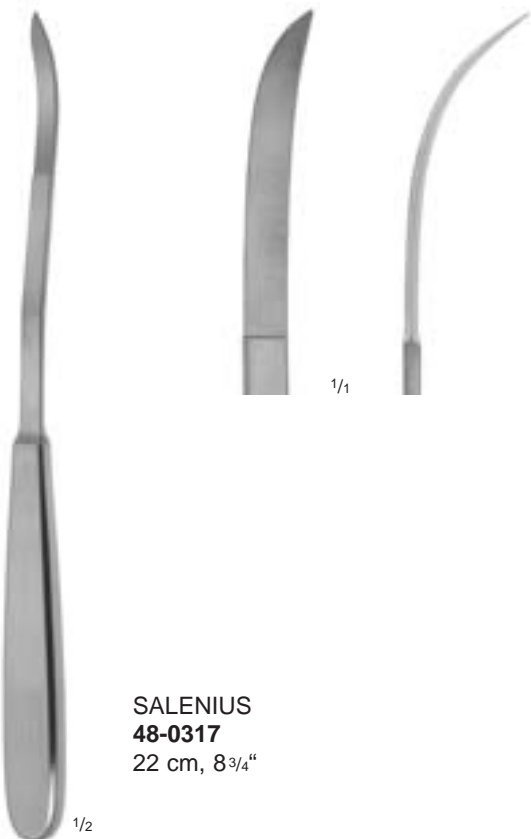

SALENIUS
48-0317
22 cm, 8³/₄"

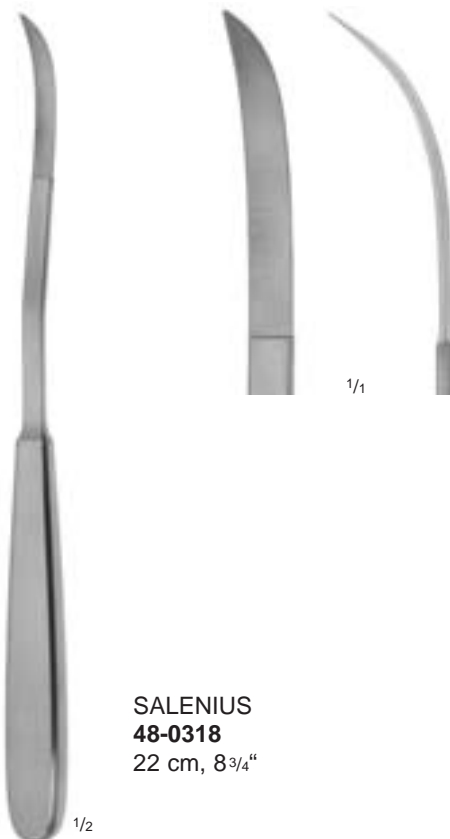

SALENIUS
48-0318
22 cm, 8³/₄"

Meniskussmesser

Meniscus Knives

Bisturíes para menisco

Bistouris à ménisque

Bisturi per menisco

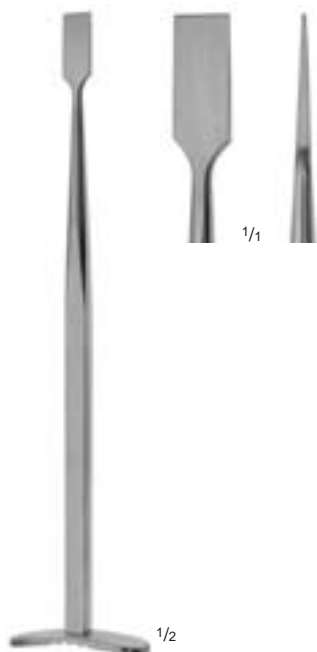

SMILLIE
48-0310
17 cm, 6³/₄"

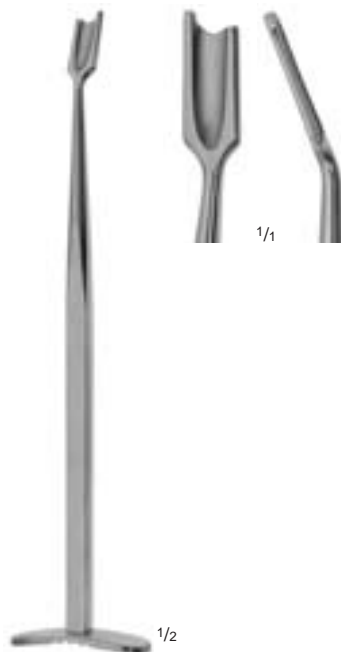

SMILLIE
48-0311
17 cm, 6³/₄"

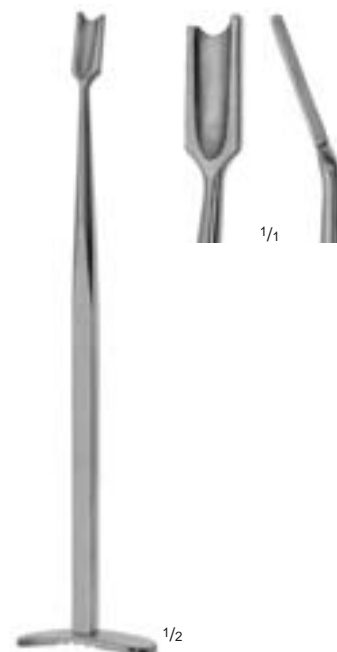

SMILLIE
48-0312
17 cm, 6³/₄"



CANAD. MODELL
48-0331
20,5 cm, 8"



CANAD. MODELL
48-0330
20,5 cm, 8"



BIRCHER
48-0332
19 cm, 7¹/₂"



BIRCHER
48-0333
19 cm, 7¹/₂"



Bleihände

Lead Hands
Manos de plomo
Main de plomb
Mano di piombo

Handhalter

Handrestrainer
Sujetadores de mano
Mains de plomb
Protezione della mano



► **48-0339**
24,5 cm, 9³/₄"

für Kinder
for children
para niños
pour enfants
per bambini

48-0340
37 cm, 14¹/₂"

für Erwachsene
for adults
para adultos
pour adultes
per adulti

Bleihände. Durch Umbiegen der Lappen werden Hand und Finger in Operationslage festgehalten und durch das Gewicht der Bleihand zusätzlich immobilisiert.

Lead hands. Hand and fingers are secured by bending the lateral fixation process and further fixed by weight of lead hand.

Manos de plomo. Doblando los lóbulos se sujeta la mano y los dedos en posición para operar, y se queda también inmóvil por el peso de la mano de plomo.

Mains de plomb. En pliant les lambeaux, la main et les doigts sont fixés en position d'opération et immobilisés grâce au poids de la main en plomb.

Mano di piombo. Legando i lobi, la mano e le dita si assestano in posizione da poter operare grazie al peso della mano di piombo.



VICKERS
48-0341
25 cm, 10"

Handhalter. Schnelles und sicheres Fixieren von Hand, Daumen und Fingern. Finger können seitlich nicht entweichen. Mehrfache Halterungen für Gummiband-Retraktoren.

Handrestrainer. Rapid application and release hand, thumb and individual fingers. Digits cannot escape sideways. Multipoint rubber band anchorages for varied postures.

Sujetador de mano. Aplicación rápida y segura de la mano, del pulgar y de los dedos. Los dedos no se pueden escapar lateralmente. Fijadores múltiples para retractoros de cintas elásticas.

Support de main. Fixation rapide et en sécurité de la main, du pouce et des doigts. Les doigts ne peuvent échapper. Plusieurs supports pour rétracteurs en bandes élastiques.

Supporto-mano. Di rapida applicazione e di sollievo per la mano, pollice e dita individuali. Le dita non possono andare lateralmente munito di varie fasce di gomma per l'ancoraggio in diverse posizioni.

Fingerringsägen

Finger Ring Saws
Sierras para abrir anillos
Scies pour bagues
Seghe per anelli

Fingernagel-Instrumente

Finger Nail Instruments
Instrumentos para uñas
Instruments à ongles
Strumenti per unghie



19-0140
16 cm, 6 1/4"

Fingerringsäge
Finger ring saw
Sierra para abrir anillos
Scie pour bagues
Segha per anelli



19-0141

Ersatzsägeblatt
Spare saw blade
Hoja de repuesto
Lame de scie de rechange
Lama di ricambio per sega



19-0145
16,5 cm, 6 1/2"

Fingerringsäge
Finger ring saw
Sierra para abrir anillos
Scie pour bagues
Segha per anelli



19-0146

Ersatzsägeblatt
Spare saw blade
Hoja de repuesto
Lame de scie de rechange
Lama di ricambio per sega

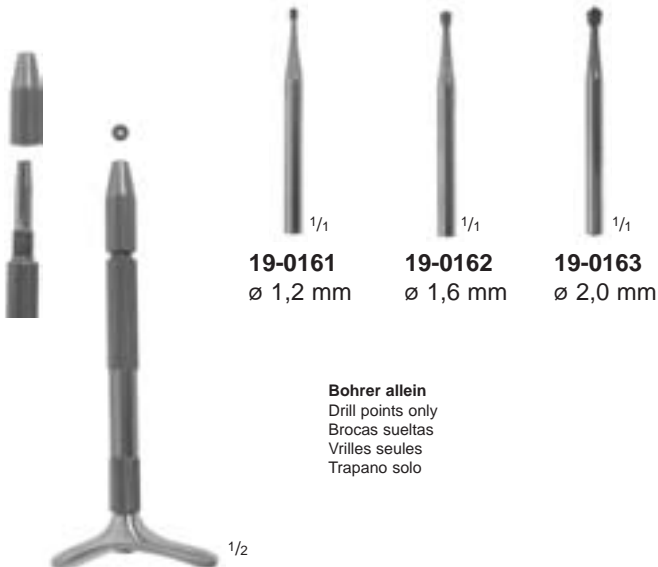

19-0160

Nagelbohrer, komplett, mit Griff und 3 Bohrern
Finger nail drill, complete, with handle and 3 drill points
Taladro para uñas, completo, con mango y 3 brocas
Perceuse à ongles, complète, avec manche et 3 vrilles
Ghiaccia unghie, completo, con manico e 3 di sondaggio

19-0161
ø 1,2 mm

19-0162
ø 1,6 mm

19-0163
ø 2,0 mm

Bohrer allein
Drill points only
Brocas sueltas
Vrilles seules
Trapano solo

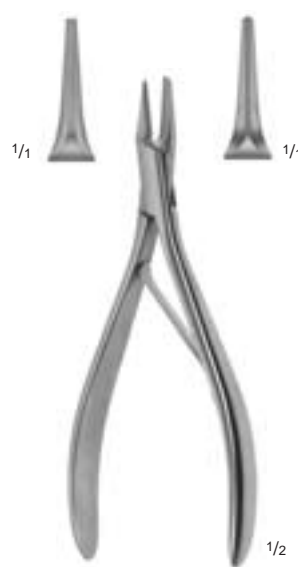

19-0467
13 cm, 5 1/8"

Nagelspaltzange
Nail splitting forceps
Pinza corta-uñas
Pinza à ongles
Pinza per unghie

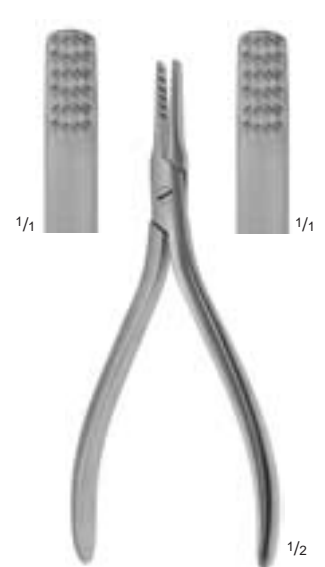

RADOLF
19-0470
13,5 cm, 5 1/4"

Nagelausreißzange
Nail extracting forceps
Pinza arranca-uñas
Pinza pour extraction des ongles
Pinza per estrazione delle unghie



Sehenschäler

Tendon Strippers
Mondador de tendones
Strippers à tendons
Enucleatore per tendine

Sehnenführer

Tendon Passing Instruments
Conductor de tendones
Conducteurs à tendons
Guida per tendine



48-0351
ø 3 mm



▶ **48-0352**
ø 4 mm



48-0353
ø 5 mm



48-0354
ø 6 mm



48-0355
ø 7 mm



BUNNELL
48-0351
- **48-0355**
15 cm, 6"

Sehenschäler
Tendon strippers
Mondador de tendones
Strippers à tendons
Enucleatore per tendine



48-0376
ø 4,0 mm



▶ **48-0377**
ø 4,5 mm



48-0378
ø 5,5 mm



48-0376
- **48-0378**
23 cm, 9"

Sehenschäler, Schaft biegsam
Tendon strippers, malleable shaft
Mondador de tendones, vástago maleable
Strippers à tendons, malléables
Enucleatore per tendine, asse malleabile

ø 4 mm



FISCHER
48-0379
31 cm, 12 1/4"

Sehenschäler
Tendon stripper
Mondador de tendones
Stripper à tendons
Enucleatore per tendine

ø 5 mm



BUNNELL
48-0360
23 cm, 9"

Sehnenführer, Schaft biegsam
Tendon passing instrument, malleable shaft
Conductor de tendones, vástago maleable
Conducteur à tendons, malléable
Guida per tendine, asse malleabile

ø 5,5 mm



48-0364
Schraube allein
screw only
tornillo suelto
vis seul
vite solo

48-0363
33,5 cm, 13 1/4"

Sehnenführer und Tunnelierinstrument, Schaft biegsam
Tendon passing and tunneling instrument, malleable shaft
Conductor de tendones e instrumento para el tunel del tendón, vástago maleable
Conducteur et tunelisateur à tendons, malléable
Strumento guida e per scanalare, asse maleabile

Sehnenfaßzangen

Tendon Seizing Forceps

Pinzas para agarrar el tendón

Pinces à saisir les tendons

Pinze per la presa del tendine

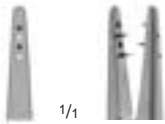

1/1

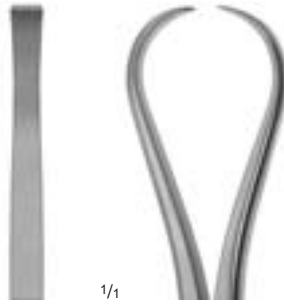

1/1

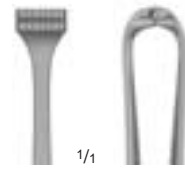

1/1



1/2

48-0380
11,5 cm, 4 1/2"



1/2

JACKSON
48-0382
15,5 cm, 6"
4 x 5 Zähne
4 x 5 teeth
4 x 5 dientes
4 x 5 dent
4 x 5 denti



1/2

STEINMANN
48-0384
15,5 cm, 6"



Sehnenführungszangen
 Tendon Holding Forceps
 Pinzas-conductoras de tendón
 Conducteurs à tendons
 Pinze ferma tendine



CARROLL
48-0388

Nutzlänge: 11 cm, 4 3/8"
 Working length: 11 cm, 4 3/8"
 Longitud útil: 11 cm, 4 3/8"
 Longueur utile: 11 cm, 4 3/8"
 Lunghezza di lavoro: 11 cm, 4 3/8"



BRAND
48-0424
 - 48-0426

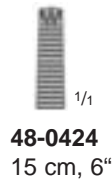

48-0424
 15 cm, 6"

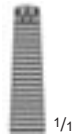

48-0425
 19 cm, 7 1/2"

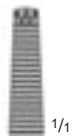

▶ **48-0426**
 24 cm, 9 1/2"



BRAND
48-0427
 - 48-0429

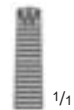

48-0427
 15 cm, 6"

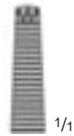

48-0428
 19 cm, 7 1/2"

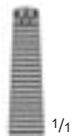

▶ **48-0429**
 24 cm, 9 1/2"

Sehndurchziehungen

Tendon Passing Forceps
Pinzas para pasar tendones
Pinces passe-tendons
Pinze passa tendine

Sehneneinflechtklemmen

Tendon Interlacing Forceps
Pinzas para entrelazar tendones
Pinces pour entrelacer les tendons
Pinze per allacciare tendini

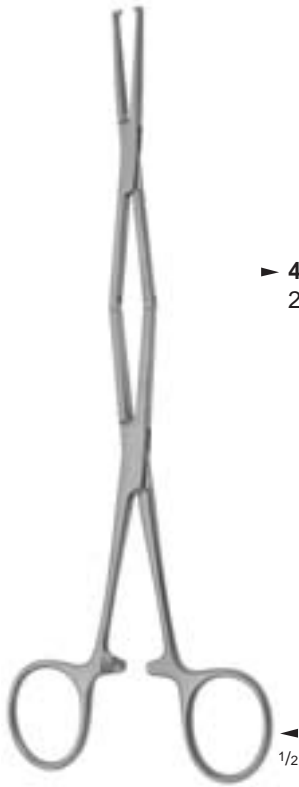

► **48-0460**
20,5 cm, 8"

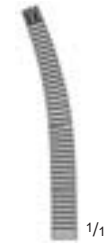
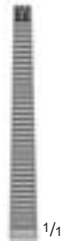

48-0461
20,5 cm, 8"

48-0460
- **48-0461**

Sehndurchziehungen
Tendon passing forceps
Pinzas para pasar tendones
Pinces passe-tendons
Pinze passa tendine



KLEINERT-KUTZ
48-0463
20,5 cm, 8"

Sehndurchziehungen
Tendon passing forceps
Pinza para pasar tendones
Pince passe-tendons
Pinza passa tendine



48-0464
15 cm, 6"

Sehneneinflechtklemme
Tendon interlacing forceps
Pinza para entrelazar tendones
Pince pour entrelacer les tendons
Pinza per intrecciare tendini

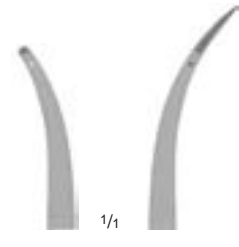

48-0465
15 cm, 6"

Sehneneinflechtklemme
Tendon interlacing forceps
Pinza para entrelazar tendones
Pince pour entrelacer les tendons
Pinza per intrecciare tendini



Bohrerführungsinstrument

Drill Guide Forceps
Pinza-guía para taladros
Pincés-guides
Pinze guida sonda

Reibahlen

Reamers
Escariadores
Pointes-carrées
Punteruoli

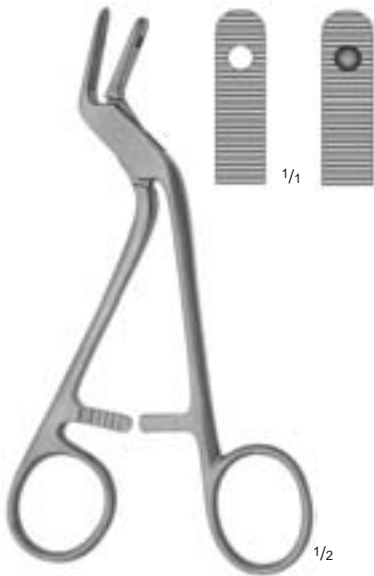

ADSON
50-0190
15 cm, 6"

Bohrerführungs- und Dura-Schutzzange
Drill guide and dura protecting forceps
Pinza-guía para taladros y para proteger la dura-madre
Pince-guide et pour protéger la dure-mère
Pinza guida sonda e per la protezione della dura-madre



48-1019
13 cm, 5 1/8"

Reibahle
Reamer
Escariador
Pointe-carrée
Punteruolo



48-1020
16 cm, 6 1/4"

Reibahle
Reamer
Escariador
Pointe-carrée
Punteruolo



48-1023
14 cm, 5 1/2"

Reibahle
Reamer
Escariador
Pointe-carrée
Punteruolo



PERTHES
48-1031
18,5 cm, 7 1/4"

Reibahle
Reamer
Escariador
Pointe-carrée
Punteruolo



PERTHES
48-1030
21 cm, 8 1/4"

Reibahle
Reamer
Escariador
Pointe-carrée
Punteruolo



PERTHES
48-1035
22 cm, 8 3/4"

Reibahle
Reamer
Escariador
Pointe-carrée
Punteruolo

Handbohrapparat

Hand Bone Drill

Perforador de mano

Perforateur à main

Trapano a mano per ossa

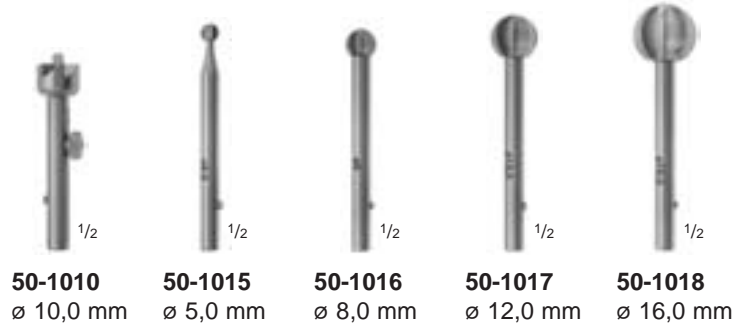
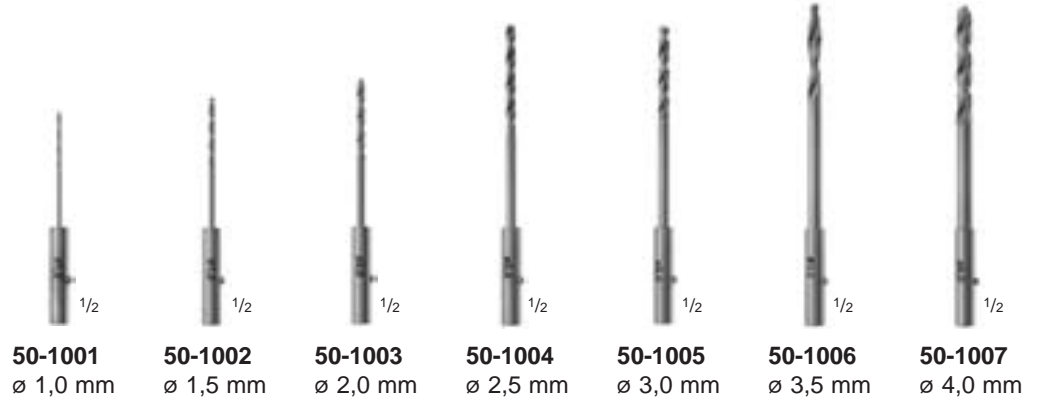

Hand bone drill, complete, consisting of:

50-0121	1 Hand bone drill
50-1001	1 Twist drill ø 1,0 mm
50-1002	1 Twist drill ø 1,5 mm
50-1003	1 Twist drill ø 2,0 mm
50-1004	1 Twist drill ø 2,5 mm
50-1005	1 Twist drill ø 3,0 mm
50-1006	1 Twist drill ø 3,5 mm
50-1007	1 Twist drill ø 4,0 mm
50-1010	1 Trephine ø 10,0 mm
50-1015	1 Spherical burr ø 5,0 mm
50-1016	1 Spherical burr ø 8,0 mm
50-1017	1 Spherical burr ø 12,0 mm
50-1018	1 Spherical burr ø 16,0 mm

Perforador de mano, completo, compuesto de:

50-0121	1 Perforador de mano
50-1001	1 Taladro espiral ø 1,0 mm
50-1002	1 Taladro espiral ø 1,5 mm
50-1003	1 Taladro espiral ø 2,0 mm
50-1004	1 Taladro espiral ø 2,5 mm
50-1005	1 Taladro espiral ø 3,0 mm
50-1006	1 Taladro espiral ø 3,5 mm
50-1007	1 Taladro espiral ø 4,0 mm
50-1010	1 Trépano ø 10,0 mm
50-1015	1 Fresa esférica ø 5,0 mm
50-1016	1 Fresa esférica ø 8,0 mm
50-1017	1 Fresa esférica ø 12,0 mm
50-1018	1 Fresa esférica ø 16,0 mm

STILLE

50-0120

Handbohrapparat, komplett, bestehend aus:

50-0121	1 Handbohrapparat
50-1001	1 Spiralbohrer ø 1,0 mm
50-1002	1 Spiralbohrer ø 1,5 mm
50-1003	1 Spiralbohrer ø 2,0 mm
50-1004	1 Spiralbohrer ø 2,5 mm
50-1005	1 Spiralbohrer ø 3,0 mm
50-1006	1 Spiralbohrer ø 3,5 mm
50-1007	1 Spiralbohrer ø 4,0 mm
50-1010	1 Trephine ø 10,0 mm
50-1015	1 Kugelfräser ø 5,0 mm
50-1016	1 Kugelfräser ø 8,0 mm
50-1017	1 Kugelfräser ø 12,0 mm
50-1018	1 Kugelfräser ø 16,0 mm

Perforateur à main, complet, composé de:

50-0121	1 Perforateur à main
50-1001	1 Mèche hélicoïdales ø 1,0 mm
50-1002	1 Mèche hélicoïdales ø 1,5 mm
50-1003	1 Mèche hélicoïdales ø 2,0 mm
50-1004	1 Mèche hélicoïdales ø 2,5 mm
50-1005	1 Mèche hélicoïdales ø 3,0 mm
50-1006	1 Mèche hélicoïdales ø 3,5 mm
50-1007	1 Mèche hélicoïdales ø 4,0 mm
50-1010	1 Tréphine ø 10,0 mm
50-1015	1 Fraise ø 5,0 mm
50-1016	1 Sphérique ø 8,0 mm
50-1017	1 Sphérique ø 12,0 mm
50-1018	1 Sphérique ø 16,0 mm

Trapano a mano per ossa, completo, composto da:

50-0121	1 Trapano a mano
50-1001	1 Punta a spirale ø 1,0 mm
50-1002	1 Punta a spirale ø 1,5 mm
50-1003	1 Punta a spirale ø 2,0 mm
50-1004	1 Punta a spirale ø 2,5 mm
50-1005	1 Punta a spirale ø 3,0 mm
50-1006	1 Punta a spirale ø 3,5 mm
50-1007	1 Punta a spirale ø 4,0 mm
50-1010	1 Fresa ø 10,0 mm
50-1015	1 Cilindrica ø 5,0 mm
50-1016	1 Fresa sferica ø 8,0 mm
50-1017	1 Fresa sferica ø 12,0 mm
50-1018	1 Fresa sferica ø 16,0 mm



Handbohrapparat

Hand Bone Drill

Perforador de mano

Perforateur à main

Trapano a mano per ossa



50-0141



50-0146



50-0142
ø 10 mm



50-0143
ø 14 mm



50-0144
ø 16 mm



50-0145
ø 22 mm

Hand bone drill, complete, consisting of:

50-0141 1 Hand bone drill
50-0146 1 Extension piece
50-0142 1 Burr ø 10 mm
50-0143 1 Burr ø 14 mm
50-0144 1 Burr ø 16 mm
50-0145 1 Burr ø 22 mm
50-0147 1 Wooden box

Perforador de mano, completo, compuesto de:

50-0141 1 Perforador de mano
50-0146 1 Pieza de prolongación
50-0142 1 Fresa ø 10 mm
50-0143 1 Fresa ø 14 mm
50-0144 1 Fresa ø 16 mm
50-0145 1 Fresa ø 22 mm
50-0147 1 Estuche de madera

HUDSON 50-0140

Handbohrapparat, komplett, bestehend aus:

50-0141 1 Handbohrapparat
50-0146 1 Verlängerungsstück
50-0142 1 Fräser ø 10 mm
50-0143 1 Fräser ø 14 mm
50-0144 1 Fräser ø 16 mm
50-0145 1 Fräser ø 22 mm
50-0147 1 Holzetui

Perforateur à main, complet, composé de:

50-0141 1 Perforateur à main
50-0146 1 Pièce de rallonge
50-0142 1 Fraise ø 10 mm
50-0143 1 Fraise ø 14 mm
50-0144 1 Fraise ø 16 mm
50-0145 1 Fraise ø 22 mm
50-0147 1 Boîte bois

Trapano a mano, completo, composto da:

50-0141 1 Trapano a mano
50-0146 1 Giunto di prolungamento
50-0142 1 Fresa ø 10 mm
50-0143 1 Fresa ø 14 mm
50-0144 1 Fresa ø 16 mm
50-0145 1 Fresa ø 22 mm
50-0147 1 Contenitore in legno



CUSHING
50-0107
ø 13 mm

Bohrer
Drill
Taladro
Perforateur
Punta



ADSON
50-0160
ø 2,4 mm

Spiralbohrer
Twist drill
Taladro espiral
Mèche hélicoïdale
Punta a spirale



MC KENZIE
50-0150
ø 13 mm

Fräser
Burr
Fresa
Fraise
Fresa



ERRICO
50-0151
ø 16 mm

Fräser
Burr
Fresa
Fraise
Fresa

Handbohrapparate

Hand Bone Drills

Perforadores de mano

Perforateurs à main

Trapani a mano per ossa



48-0612

16 cm, 6 1/4"

Handbohrfutter mit Dreibackten-Spannfutter und Spannschlüssel (48-0613), Spannweite bis ø 6,35 mm, längsdurchbohrt, zum Einschlagen und Extrahieren von Bohrdrähten und Nägeln.

Drilling chuck with three-jaw-chuck and key (48-0613), for shanks up to 6.35 mm diam., cannulated, for inserting and extracting wire drills and nails.

Mandril de tres mordazas con llave (48-0613), apertura hasta ø 6,35 mm, barrenado oblongo, para insertar y extraer agujas y clavos.

Perforateur à main avec 3 mâchoires et une clef (48-0613), passage jusqu'à ø 6,35 mm, cranté, pour poser et retirer les broches et les clous.

Trapano con mandrino a 3 ganasce e chiave (48-0613), per punte sopra i 6,35 mm di ø, tubolare, per inserire ed estrarre fili e chiodi.



48-0615

14 cm, 5 1/2"

Handbohrfutter mit Dreibackten-Spannfutter und Spannschlüssel (48-0616), Spannweite bis ø 3,95 mm, längsdurchbohrt, zum Einschlagen und Extrahieren von Bohrdrähten und Nägeln.

Drilling chuck with three-jaw-chuck and key (48-0616), for shanks up to 3.95 mm diam., cannulated, for inserting and extracting wire drills and nails.

Mandril de tres mordazas con llave (48-0616), apertura hasta ø 3,95 mm, barrenado oblongo, para insertar y extraer agujas y clavos.

Perforateur à main avec 3 mâchoires et une clef (48-0616), passage jusqu'à ø 3,95 mm, cranté, pour poser et retirer les broches et les clous.

Trapano con mandrino a 3 ganasce e chiave (48-0616), per punte sopra i 3,95 mm di ø, tubolare, per inserire ed estrarre fili e chiodi.



BUNNELL

48-0580

Handbohrapparat mit Dreibackten-Spannfutter und Spannschlüssel (48-0581), Spannweite bis ø 4 mm, längsdurchbohrt, zur Aufnahme von Bohrdrähten und Nägeln.

Hand drill with three-jaw-chuck and key (48-0581), for shanks up to 4 mm diam., cannulated, for taking wire drills and nails.

Perforador de mano con mandril de tres mordazas y llave (48-0581), apertura hasta ø 4 mm, barrenado oblongo, para agujas y clavos.

Perforateur à manivelle avec 3 mâchoires et une clef (48-0581), passage jusqu'à ø 4 mm, pour les broches et les clous.

Trapano a mano con mandrino a 3 ganasce e chiave (48-0581), per punte sopra i 4 mm di ø, tubolare, per inserire fili e chiodi.



RALK

48-0585

Handbohrapparat mit Dreibackten-Spannfutter und Spannschlüssel (48-0586), Spannweite bis ø 6,35 mm, längsdurchbohrt, zur Aufnahme von Bohrdrähten und Nägeln.

Hand drill with three-jaw-chuck and key (48-0586), for shanks up to 6.35 mm diam., cannulated, for taking wire drills and nails.

Perforador de mano con mandril de tres mordazas y llave (48-0586), apertura hasta ø 6,3 mm, barrenado oblongo, para agujas y clavos.

Perforateur à manivelle avec 3 mâchoires et une clef (48-0586), passage jusqu'à ø 6,35 mm, pour les broches et les clous.

Trapano a mano con mandrino a 3 ganasce e chiave (48-0586), per punte sopra i 6,35 mm di ø, tubolare, per inserire fili e chiodi.



STEINMANN Nägel
 STEINMANN Pins
 STEINMANN Clavos
 STEINMANN Clous
 Chiodi STEINMANN

Extensionsbügel
 Wire Traction Bows
 Etribos para extensión
 Etriers à extension
 Archi per trazione



STEINMANN

- 48-0620** ø 4 mm x 80 mm
- 48-0621** ø 4 mm x 100 mm
- 48-0622** ø 4 mm x 120 mm
- 48-0623** ø 4 mm x 140 mm
- 48-0624** ø 4 mm x 150 mm
- 48-0625** ø 4 mm x 160 mm
- 48-0626** ø 4 mm x 180 mm
- ▶ **48-0627** ø 4 mm x 200 mm
- 48-0628** ø 4 mm x 210 mm
- 48-0629** ø 4 mm x 250 mm

Nägel mit Trokarspitze und 3kant-Schaft, aus nichtrostendem Implantatstahl nach DIN 17443

Pins with trocar point and triangular shaft, material used for implants: stainless steel acc. to DIN 17443

Clavos con punta trocar y vástago triangular, de acero inoxidable para implantes, conforme a DIN 17443

Clou à pointe triangulaire utilisé comme implant, acier inox conforme à la norme DIN 17443

Chiodi con trocar a punta e albero triangolare, materiale usato per innesti, in acciaio inox, conforme alle norme DIN 17443

1/1

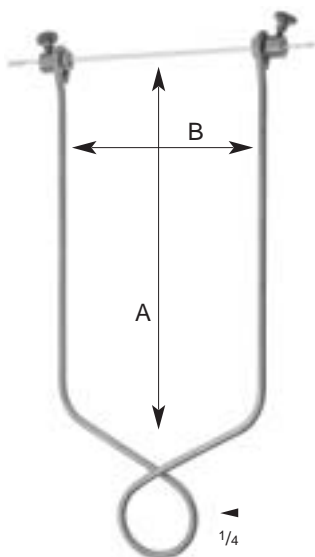

BÖHLER

- 48-0652**
- 160 x 190 mm
- 6 1/4" x 7 1/2" (AxB)

Extensionsbügel für Arm, zur Verwendung von STEINMANN Nägel ø 4 mm

Wire traction bow for arm, to be used with STEINMANN pins, 4 mm diam.

Estribo para extensión de brazo, para clavos de STEINMANN ø 4 mm

Etrier de traction pour bras, utilisé avec clou de STEINMANN ø 4 mm

Cavo per arco di trazione per braccio, da impiegarsi con chiodi STEINMANN, ø 4 mm

1/4

BÖHLER

- ▶ **48-0654**
- 210 x 110 mm
- 8 1/4" x 4 3/8" (AxB)

Extensionsbügel für Oberschenkel und Knie, zur Verwendung von STEINMANN Nägel ø 4 mm

Wire traction bow for thigh and knee, to be used with STEINMANN pins, 4 mm diam.

Estribo para extensión del muslo y de la rodilla, para clavos de STEINMANN ø 4 mm

Etrier de traction pour femur et genou, utilisé avec clou de STEINMANN ø 4 mm

Cavo per arco di trazione per coscia e ginocchio, da impiegarsi con chiodi STEINMANN, ø 4 mm

BÖHLER

- 48-0656**
- 210 x 150 mm
- 8 1/4" x 6" (AxB)

Extensionsbügel für Oberschenkel und Knie, zur Verwendung von STEINMANN Nägel ø 4 mm

Wire traction bow for thigh and knee, to be used with STEINMANN pins, 4 mm diam.

Estribo para extensión del muslo y de la rodilla, para clavos de STEINMANN ø 4 mm

Etrier de traction pour femur et genou, utilisé avec clou de STEINMANN ø 4 mm

Cavo per arco di trazione per coscia e ginocchio, da impiegarsi con chiodi STEINMANN, ø 4 mm

KIRSCHNER Bohrdrähte
 KIRSCHNER Wire Drills
 Agujas de KIRSCHNER
 Broches de KIRSCHNER
 Punte filiformi di KIRSCHNER



	15 cm, 6"	31 cm, 12 1/4"
ø 0,8 mm	48-1708	48-1508
ø 1,0 mm	48-1710	48-1510
ø 1,2 mm	48-1712	48-1512
ø 1,4 mm	48-1714	48-1514
ø 1,5 mm	48-1715	48-1515
ø 1,6 mm	48-1716	48-1516
ø 1,8 mm	48-1718	48-1518
ø 2,0 mm	▶ 48-1720	48-1520
ø 2,2 mm	48-1722	48-1522
ø 2,5 mm	48-1725	48-1525
ø 3,0 mm	48-1727	48-1527

KIRSCHNER Bohrdrähte mit Trokarspitze und flachem Schaftende, aus nichtrostendem Implantatstahl nach DIN 17443, in Packungen zu 10 Stück
 KIRSCHNER Wire drills with trocar point and flat shaft end, material used for implants: stainless steel acc. to DIN 17443, in packages of 10 pieces
 Agujas de KIRSCHNER con punta trocar y cabo plano, de acero inoxidable para implantes, conforme a DIN 17443, en paquetes de 10 pzas.
 Broches KIRSCHNER avec 1 pointe trocar et 1 meplat, acier inox pour implant conforme à DIN 17443, en paquet de 10 pièces
 Punte di KIRSCHNER con trocar a punta ed estremita piatta, in acciaio inox impiegato per innesti, conforme alle norme DIN 17443, in confezioni da 10 pezzi



	15 cm, 6"	31 cm, 12 1/4"
ø 0,8 mm	48-1828	48-1878
ø 1,0 mm	48-1830	48-1880
ø 1,2 mm	48-1832	48-1882
ø 1,4 mm	48-1834	48-1884
ø 1,5 mm	48-1835	48-1885
ø 1,6 mm	48-1836	48-1886
ø 1,8 mm	48-1838	48-1888
ø 2,0 mm	▶ 48-1840	48-1890
ø 2,2 mm	48-1842	48-1892
ø 2,5 mm	48-1845	48-1895
ø 3,0 mm	48-1847	48-1897

KIRSCHNER Bohrdrähte mit Trokarspitze und rundem Schaftende, aus nichtrostendem Implantatstahl nach DIN 17443, in Packungen zu 10 Stück
 KIRSCHNER Wire drills with trocar point and round shaft end, material used for implants: stainless steel acc. to DIN 17443, in packages of 10 pieces
 Agujas de KIRSCHNER con punta trocar y cabo redondo, de acero inoxidable para implantes, conforme a DIN 17443, en paquetes de 10 pzas.
 Broches KIRSCHNER avec 1 pointe trocar et 1 pointe mousse, acier inox pour implant conforme à DIN 17443, en paquet de 10 pièces
 Punte di KIRSCHNER con trocar a punta ed estremita rotonda, in acciaio inox impiegato per innesti, conforme alle norme DIN 17443, in confezioni da 10 pezzi



	10 cm, 4"	15 cm, 6"	31 cm, 12 1/4"
ø 0,8 mm	48-2038	48-2058	48-2078
ø 1,0 mm	48-2040	48-2060	48-2080
ø 1,2 mm	48-2042	48-2062	48-2082
ø 1,4 mm	48-2044	48-2064	48-2084
ø 1,5 mm	48-2045	48-2065	48-2085
ø 1,6 mm	48-2046	48-2066	48-2086
ø 1,8 mm	48-2048	48-2068	48-2088
ø 2,0 mm	▶ 48-2050	48-2070	48-2090
ø 2,2 mm	48-2052	48-2072	48-2092
ø 2,5 mm	48-2055	48-2075	48-2095
ø 3,0 mm	48-2057	48-2077	48-2097

KIRSCHNER Bohrdrähte mit beidseitiger Trokarspitze, aus nichtrostendem Implantatstahl nach DIN 17443, in Packungen zu 10 Stück
 KIRSCHNER Wire drills with trocar point on each end, material used for implants: stainless steel acc. to DIN 17443, in packages of 10 pieces
 Agujas de KIRSCHNER con dos puntas trocar, de acero inoxidable para implantes, conforme a DIN 17443, en paquetes de 10 pzas.
 Broches KIRSCHNER avec 2 pointes trocar, acier inox pour implant conforme à DIN 17443, en paquet de 10 pièces
 Punte di KIRSCHNER con trocar a punta su ciascun lato, in acciaio inox impiegato per innesti, conforme alle norme DIN 17443, in confezione da 10 pezzi



Bohrdrahtspender

Wire Drill Dispenser

Dispensador de agujas

Distributeur de broches

Distributore per punte filiformi

- **Sicherer Transport und schonende Lagerung.**
Perforierter Bohrdrahtspender für sichere Sterilisation.
Klar gekennzeichnete Bohrdrahtspender für jede Bohrdrahtstärke.
- Easy to transport and safely to storage.
Perforated dispenser for guaranteed sterilization.
Labelled wire dispenser for all diameters available.
- Transporte y almacenaje cuidadoso.
Dispensador perforado para la esterilización segura.
Dispensador indicando claramente cada diámetro.
- Facile à transporter et stocker.
Perforations diverses pour garantir la stérilisation.
Distributeur d'étiquettes pour tous diamètres disponibles.
- Facili da trasportare e conservare.
Contenitore forato per garantire la sterilizzazione.
Distributore marcato per i diametri disponibili.



für Bohrdraht \varnothing x Bohrdrahtlänge
for wire \varnothing x wire length
para aguja de \varnothing x longitud de la aguja
pour broches Kirschner \varnothing x longueur de broches
per \varnothing punta e lunghezza punta

► 48-2158	\varnothing 0,8 mm x 150 mm
48-2160	\varnothing 1,0 mm x 150 mm
48-2162	\varnothing 1,2 mm x 150 mm
48-2164	\varnothing 1,4 mm x 150 mm
48-2165	\varnothing 1,5 mm x 150 mm
48-2166	\varnothing 1,6 mm x 150 mm
48-2168	\varnothing 1,8 mm x 150 mm
48-2170	\varnothing 2,0 mm x 150 mm
48-2172	\varnothing 2,2 mm x 150 mm
48-2175	\varnothing 2,5 mm x 150 mm
48-2177	\varnothing 3,0 mm x 150 mm



für Bohrdraht \varnothing x Bohrdrahtlänge
for wire \varnothing x wire length
para aguja de \varnothing x longitud de la aguja
pour broches Kirschner \varnothing x longueur de broches
per \varnothing punta e lunghezza punta

48-2178	\varnothing 0,8 mm x 310 mm
48-2180	\varnothing 1,0 mm x 310 mm
► 48-2182	\varnothing 1,2 mm x 310 mm
48-2184	\varnothing 1,4 mm x 310 mm
48-2185	\varnothing 1,5 mm x 310 mm
48-2186	\varnothing 1,6 mm x 310 mm
48-2188	\varnothing 1,8 mm x 310 mm
48-2190	\varnothing 2,0 mm x 310 mm
48-2192	\varnothing 2,2 mm x 310 mm
48-2195	\varnothing 2,5 mm x 310 mm
48-2197	\varnothing 3,0 mm x 310 mm

Mehrfach-Bohrdrahtspender

Multiple Wire Drill Dispenser

Dispensador de agujas

Distributeur de broches filiformes

Distributore multiplo per punte filiformi



- Vier verschiedene Bohrdrähte in einem Spender.
Eindeutige Kennzeichnung der verschiedenen Durchmesser auf dem Spender.
Sterilisation und Aufbewahrung im Spender.
- Four different wire drills from one dispenser.
Clear size markings on the dispenser.
Sterilization and storage in the dispenser.
- Cuatro agujas distintas en un sólo dispensador.
El dispensador está marcado claramente con los diferentes diámetros.
Esterilización y almacenaje dentro del mismo dispensador.
- 4 différentes broches filiformes dans un distributeur.
Marquage exacte des différents diamètres sur le distributeur.
Stérilisation et conservation dans le distributeur.
- 4 differenti punte filiformi e un solo contenitore
Distributore marcato con i vari diametri
Sterilizzazione e conservazione nello stesso distributore



VICKERS 48-2108

für Bohrdrähte \varnothing 1,0/1,2/1,4/1,6 mm x 100 mm
for wire drills \varnothing 1.0/1.2/1.4/1.6 mm x 100 mm
para agujas de diámetro 1,0/1,2/1,4/1,6 mm x 100 mm
pour broches filiformes \varnothing 1,0/1,2/1,4/1,6 mm x 100 mm
per punte filiformi \varnothing 1,0/1,2/1,4/1,6 mm x 100 mm



► 48-2100

für Bohrdrähte \varnothing 1,0/1,2/1,4/1,6 mm x 150 mm
for wire drills \varnothing 1.0/1.2/1.4/1.6 mm x 150 mm
para agujas de diámetro 1,0/1,2/1,4/1,6 mm x 150 mm
pour broches filiformes \varnothing 1,0/1,2/1,4/1,6 mm x 150 mm
per punte filiformi \varnothing 1,0/1,2/1,4/1,6 mm x 150 mm



► 48-2104

für Bohrdrähte \varnothing 1,0/1,2/1,4/1,6 mm x 310 mm
for wire drills \varnothing 1.0/1.2/1.4/1.6 mm x 310 mm
para agujas de diámetro 1,0/1,2/1,4/1,6 mm x 310 mm
pour broches filiformes \varnothing 1,0/1,2/1,4/1,6 mm x 310 mm
per punte filiformi \varnothing 1,0/1,2/1,4/1,6 mm x 310 mm

48-2102

für Bohrdrähte \varnothing 1,8/2,0/2,2/2,5 mm x 150 mm
for wire drills \varnothing 1.8/2.0/2.2/2.5 mm x 150 mm
para agujas de diámetro 1,8/2,0/2,2/2,5 mm x 150 mm
pour broches filiformes \varnothing 1,8/2,0/2,2/2,5 mm x 150 mm
per punte filiformi \varnothing 1,8/2,0/2,2/2,5 mm x 150 mm

48-2106

für Bohrdrähte \varnothing 1,8/2,0/2,2/2,5 mm x 310 mm
for wire drills \varnothing 1.8/2.0/2.2/2.5 mm x 310 mm
para agujas de diámetro 1,8/2,0/2,2/2,5 mm x 310 mm
pour broches filiformes \varnothing 1,8/2,0/2,2/2,5 mm x 310 mm
per punte filiformi \varnothing 1,8/2,0/2,2/2,5 mm x 310 mm



Extensionsbügel
Wire Traction Bows
Estribos para extensión
Etriers à extension
Archi per trazione

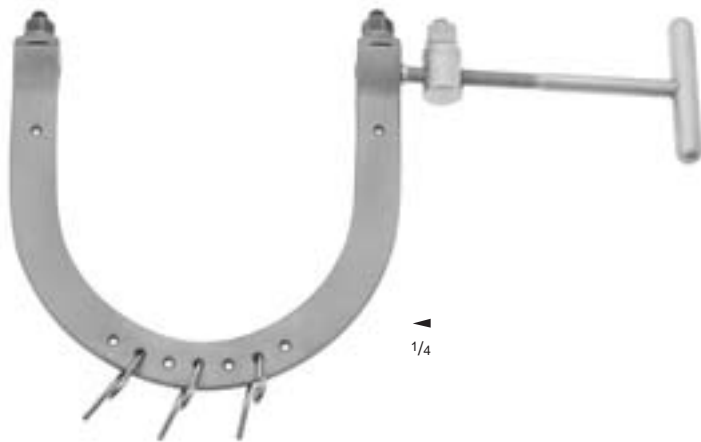

48-0645

Spannschlüssel mit Klemmbacke, zum Spannen des Drahtes

Wire tightener, with clamping jaws
Tensor de alambres
Tendeur de broches avec mors clampants
Strumento tenditore con morso a presa

Weite
Width
Anchura interior
Largeur ouverte
Larghezza interna

Tiefe
Depth
Profundidad
Profondité
Profondità

Anwendung
Application
Aplicación
Application
Applicazione

KIRSCHNER

48-0636	95 mm, 3 ³ / ₄ "	70 mm, 2 ³ / ₄ "	Arm und Ellenbogen	arm and elbow	braza y codo	bras et poignet	braccio e gomito
48-0635	95 mm, 3 ³ / ₄ "	110 mm, 4 ³ / ₈ "	Fersenbein	calcaneus	calcáneo	calcaneum	calcagno
48-0634	105 mm, 4 ¹ / ₈ "	100 mm, 4"	Knie	knee	rodilla	genou	ginococchio
48-0633	120 mm, 4 ³ / ₄ "	120 mm, 4 ³ / ₄ "	Knie	knee	rodilla	genou	ginococchio
48-0632	135 mm, 5 ¹ / ₄ "	130 mm, 5 ¹ / ₈ "	Knie	knee	rodilla	genou	ginococchio
48-0631	155 mm, 6"	155 mm, 6"	Oberschenkel	femur	fémur	fémur	femore
48-0630	200 mm, 8"	155 mm, 6"	Hüfte	hip	coxa	hanche	anca

Extensionsbügel mit 3 Zughaken, zur Verwendung mit KIRSCHNER Drähten bis ø 2,5 mm
Wire traction bows with 3 traction hooks, to be used with KIRSCHNER wires up to 2.5 mm diam.
Estribos para extensión con 3 ganchos de tracción, para agujas de KIRSCHNER hasta ø 2,5 mm
Etriers à extension avec 3 crochets de traction, pour broches KIRSCHNER ø 2,5 mm
Archi per trazione con 3 ganci di trazione, da impiegarsi con fili KIRSCHNER superiori a 2,5 mm di ø

48-0660

40 - 130 mm, 1¹/₂" - 5¹/₈" / 100 mm, 4"

Extensionsbügel mit 3 Zughaken, zur Verwendung mit KIRSCHNER Drähten bis ø 2 mm, verstellbar, kleines Modell

Wire traction bow with 3 traction hooks, to be used with KIRSCHNER wires up to 2 mm diam., adjustable, small size

Estribo para extensión con 3 ganchos de tracción, para agujas de KIRSCHNER hasta ø 2 mm, ajustable, modelo pequeño

Etrier à extension avec 3 crochets de traction, pour broches KIRSCHNER ø 2 mm, réglable, petit modèle

Archi per trazione con 3 ganci di trazione, da impiegarsi con fili KIRSCHNER superiori a 2 mm di ø, regolabile, misura piccola

48-0661

80 - 260 mm, 3¹/₈" - 10¹/₄" / 150 mm, 6"

Extensionsbügel mit 3 Zughaken, zur Verwendung mit KIRSCHNER Drähten bis ø 2,5 mm, verstellbar, großes Modell

Wire traction bow with 3 traction hooks, to be used with KIRSCHNER wires up to 2.5 mm diam., adjustable, large size

Estribo para extensión con 3 ganchos de tracción, para agujas de KIRSCHNER hasta ø 2,5 mm, ajustable, modelo grande

Etrier à extension avec 3 crochets de traction, pour broches KIRSCHNER ø 2,5 mm, réglable, grand modèle

Archi per trazione con 3 ganci di trazione, da impiegarsi con fili KIRSCHNER superiori a 2,5 mm di ø, regolabile, misura grande

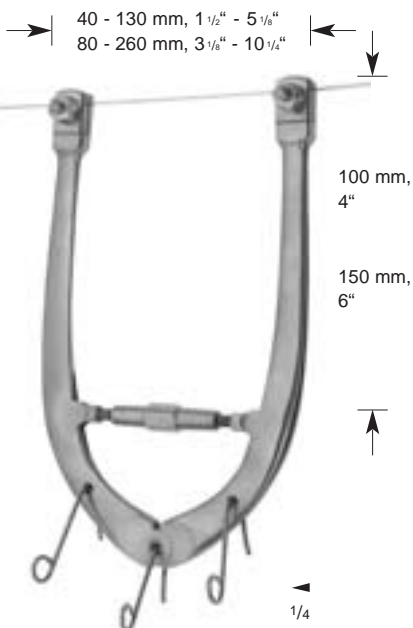

Extensionsbügel

Wire Traction Bows

Estribos para extensión

Etriers à extension

Archi per estensione

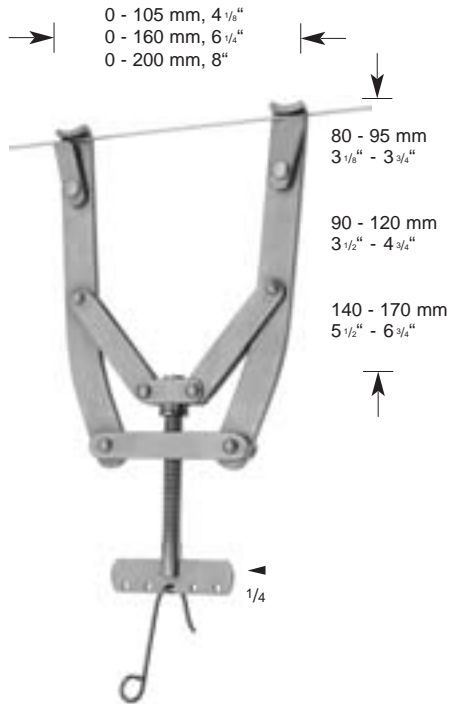

KIRSCHNER

48-0666

0 - 105 mm, 4 1/8" / 80 - 95 mm, 3 1/8" - 3 3/4"

Extensionsbügel mit 1 Zughaken, zur Verwendung mit KIRSCHNER Drähten bis ø 1,6 mm, verstellbar, selbsthemmend

Wire traction bow with 1 traction hook, to be used with KIRSCHNER wires up to 1.6 mm diam., adjustable, holds wire securely

Estribo para extensión con 1 gancho de tracción, para agujas de KIRSCHNER hasta ø 1,6 mm, ajustable, sujeto seguro de la aguja

Etrier à extension avec 1 crochet de traction, pour broches KIRSCHNER ø 1,6, réglable, avec blocage des broches

Archi per trazione con 1 ganci di trazione, da impiegarsi con fili KIRSCHNER superiori a 1,6 mm di ø, regolabile, fili in sicurezza

KIRSCHNER

48-0665

0 - 160 mm, 6 1/4" / 90 - 120 mm, 3 1/2" - 4 3/4"

Extensionsbügel mit 1 Zughaken, zur Verwendung mit KIRSCHNER Drähten bis ø 2,0 mm, verstellbar, selbsthemmend

Wire traction bow with 1 traction hook, to be used with KIRSCHNER wires up to 2.0 mm diam., adjustable, holds wire securely

Estribo para extensión con 1 gancho de tracción, para agujas de KIRSCHNER hasta ø 2,0 mm, ajustable, sujeto seguro de la aguja

Etrier à extension avec 1 crochet de traction, pour broches KIRSCHNER ø 2,0, réglable, avec blocage des broches

Archi per trazione con 1 ganci di trazione, da impiegarsi con fili KIRSCHNER superiori a 2,0 mm di ø, regolabile, fili in sicurezza

KIRSCHNER

▶ 48-0667

0 - 200 mm, 8" / 140 - 170 mm, 5 1/2" - 6 3/4"

Extensionsbügel mit 1 Zughaken, zur Verwendung mit KIRSCHNER Drähten bis ø 2,5 mm, verstellbar, selbsthemmend

Wire traction bow with 1 traction hooks, to be used with KIRSCHNER wires up to 2.5 mm diam., adjustable, holds wire securely

Estribo para extensión con 1 gancho de tracción, para agujas de KIRSCHNER hasta ø 2,5 mm, ajustable, sujeto seguro de la aguja

Etrier à extension avec 1 crochet de traction, pour broches KIRSCHNER ø 2,5, réglable, avec blocage des broches

Archi per trazione con 1 ganci di trazione, da impiegarsi con fili KIRSCHNER superiori a 2,5 mm di ø, regolabile, fili in sicurezza



48-0644

Spannschlüssel für Extensionsbügel 48-0630 - 48-0661

Wrench for wire traction bows 48-0630 - 48-0661

Llave de tuercas para estribo de extensión

Clef plate pour étrier à extension 48-0630 - 48-0661

Chiave per archi per trazione 48-0630 - 48-0661



48-0640

Zughaken, kleines Modell

Traction hook, small size

Gancho de tracción, modelo pequeño

Crochet de traction, petit modèle

Ganci di trazione, misura piccola



48-0641

Zughaken, großes Modell

Traction hook, large size

Gancho de tracción, modelo grande

Crochet de traction, grand modèle

Ganci di trazione, misura grande



48-0674

Begrenzungsplatte mit Schlitz

Fixation disc, slotted

Disco fijador con una muesca

Disque de fixation avec fente

Disco di fissaggio, scanalato



48-0675

Fixierscheiben (Begrenzungsplatten), Paar

Fixation discs, pair

Discos fijadores, par

Disques de fixation paire

Dischi di fissaggio, paio



48-0676

Schraubenzieher für Fixierscheiben

Screw driver, for fixation discs

Destornillador para discos fijadores

Vis pour fixation des disques

Vite guida, per dischi di fissaggio



Cerclage-Instrumente

Cerclage Instruments

Instrumentos para cerclaje

Instrumentos pour cerclage

Strumenti per cerchiaggio



1/2

- 48-0902 ø 0,2 mm
- 48-0903 ø 0,3 mm
- 48-0904 ø 0,4 mm
- 48-0905 ø 0,5 mm
- 48-0906 ø 0,6 mm
- 48-0907 ø 0,7 mm
- 48-0908 ø 0,8 mm
- 48-0909 ø 0,9 mm
- ▶ 48-0910 ø 1,0 mm
- 48-0912 ø 1,2 mm
- 48-0915 ø 1,5 mm

Cerclage-Drähte, weich,
in Ringen zu 10 m

Bone wires, soft, in
coils of 10 m

Hilos de cerclaje, blandos,
en rollos de 10 m

Fil pour cerclage, malléable,
en rouleau de 10 m

Filo per ossa, leggero,
in bobine da m. 10



LOUTE

48-0920

21,5 cm, 8 1/2"

Drahtspanner mit an der Spitze eingebauter
beweglicher Drahtspannbüchse für Cerclage-
Drähte bis ø 1 mm

Wire tightener, with movable tip, for wires up to
1.0 mm diam.

Tensor cierra-hilo con manguito movible en la
punta, para hilos de cerclaje hasta ø 1 mm

Serre-fil avec manche mobile intégré à la pointe
pour fil de cerclage jusqu'à ø 1 mm

Tenditore serra filo con manico mobile sulla
punta, per fili di cerchiaggio da 1 mm. di ø



1/3



1/1

▶ **48-0926**
27,5 cm, 10 3/4"



1/1

48-0927
28,5 cm, 11 1/4"



1/1

48-0928
30,5 cm, 12"

Drahtumführungsnadeln • Wire guides • Agujas pasa-hilos • Aiguilles passe-fils • Guida cavo

DEMEL
48-0926
- 48-0928

Drahtumführungsadeln

Wire Guides

Agujas pasa-hilos

Aiguilles passe-fils

Aghi passafili



hohl, spitz
hollow, sharp
hueco, agudo
creux, pointu
cavo, acuto

1/1

► **48-0931**
24 cm, 9 1/2"



1/2

48-0931
- **48-0932**



hohl, spitz
hollow, sharp
hueco, agudo
creux, pointu
cavo, acuto

1/1

48-0932
27 cm, 10 3/4"



1/2

48-0933
22,5 cm, 9"



1/1

hohl, spitz
hollow, sharp
hueco, agudo
creux, pointu
cavo, acuto



TITE GRIP® Drahtspannzangen mit Hartmetalleinlagen
TITE GRIP® Wire Twisting Forceps with tungsten carbide inserts
TITE GRIP® Pinzas cierra-hilos con bocas de carburo tungsteno
TITE GRIP® Pincers serre-fils avec mors en tungstène
TITE GRIP® Pinze gira cavo con morsi in carburo di tungsteno



08-0294
15 cm, 6"



08-0296
15 cm, 6"



CORWIN-HEGAR
08-0297
16 cm, 6 1/4"



08-0298
18 cm, 7"



08-0299
18,5 cm, 7 1/4"



LINDORF
48-0922
20 cm, 8"

Drahtfaßzangen

Wire Holding Forceps

Pinzas para extraer alambres

Pinces tire-broches

Pinze porta cavo



48-1484
- 48-1488

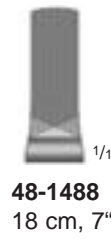
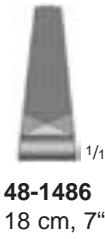

mit Hartmetalleinlagen
with tungsten carbide inserts
con bocas de carburo tungsteno
avec mors en tungstène
con inserti in carburo di tungsteno



Parallelschluß
Parallel action
Acción paralela
Action parallèle
Azione parallela



48-0484
- 48-0486

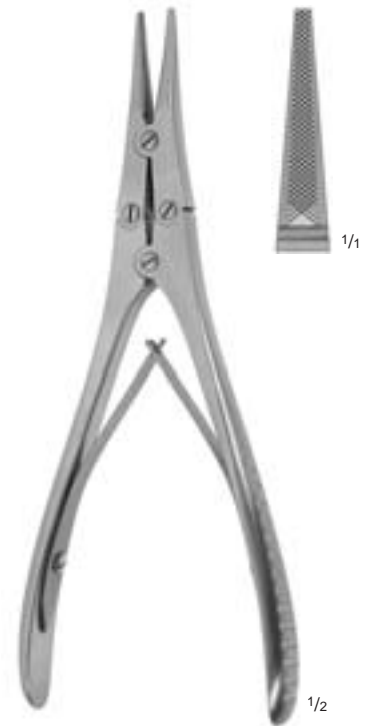
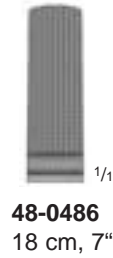
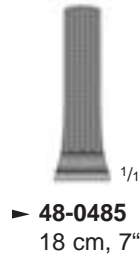
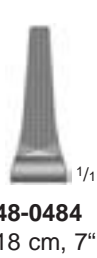

48-0487
19 cm, 7 1/2"



Drahtfaßzangen

Wire Holding Forceps

Pinzas para extraer alambres

Pinces tire-broches

Pinze porta cavo

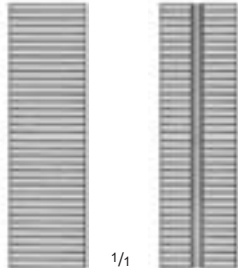

48-0491
17 cm, 6³/₄"



48-0492
18 cm, 7"



48-0493
16 cm, 6¹/₄"

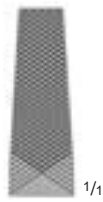

48-0494
17 cm, 6³/₄"



► **48-0495**
17 cm, 6³/₄"

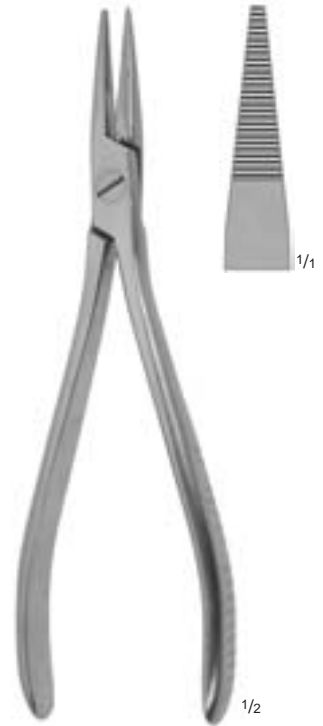

48-0496
19 cm, 7¹/₂"

Drahtscheren

Wire Cutting Scissors
Cizallas corta-alambres
Pincers coupe-fils
Forbici taglia cavo

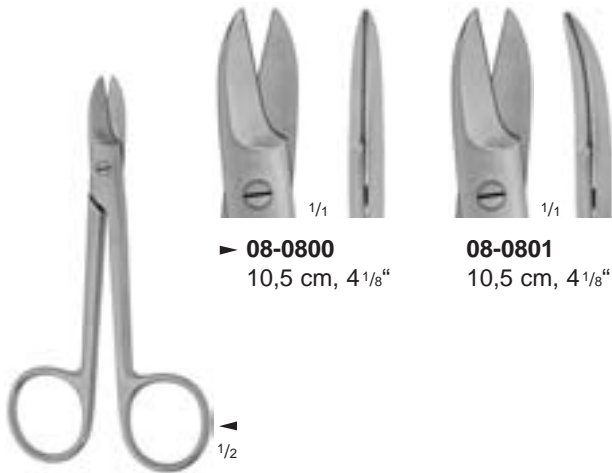

► **08-0800**
10,5 cm, 4 1/8"

08-0801
10,5 cm, 4 1/8"

BEEBEE
08-0800
- **08-0801**

für weichen Draht bis \emptyset
for soft wire up to diam.
para blandos hasta un diam. de
pour couper les fils moux jusqu'à \emptyset
per cavi leggeri con \emptyset superiore a

0,4 mm

für harten Draht bis \emptyset
for hard wire up to diam.
para duros hasta un diam. de
pour couper les fils durs jusqu'à \emptyset
per cavi duri con \emptyset superiore a

0,3 mm

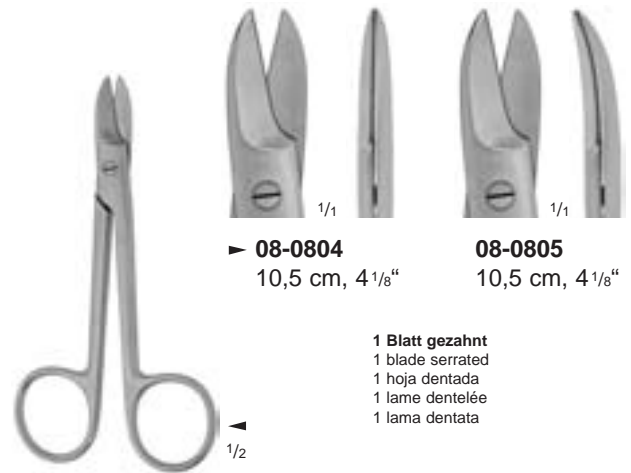

► **08-0804**
10,5 cm, 4 1/8"

08-0805
10,5 cm, 4 1/8"

BEEBEE
08-0804
- **08-0805**

für weichen Draht bis \emptyset
for soft wire up to diam.
para blandos hasta un diam. de
pour couper les fils moux jusqu'à \emptyset
per cavi leggeri con \emptyset superiore a

0,4 mm

für harten Draht bis \emptyset
for hard wire up to diam.
para duros hasta un diam. de
pour couper les fils durs jusqu'à \emptyset
per cavi duri con \emptyset superiore a

0,3 mm

1 Blatt gezahnt
1 blade serrated
1 hoja dentada
1 lame dentelée
1 lama dentata



1 Blatt gezahnt
1 blade serrated
1 hoja dentada
1 lame dentelée
1 lama dentata

UNIVERSAL
08-0810
12 cm, 4 3/4"

für weichen Draht bis \emptyset
for soft wire up to diam.
para blandos hasta un diam. de
pour couper les fils moux jusqu'à \emptyset
per cavi leggeri con \emptyset superiore a

1,2 mm

für harten Draht bis \emptyset
for hard wire up to diam.
para duros hasta un diam. de
pour couper les fils durs jusqu'à \emptyset
per cavi duri con \emptyset superiore a

0,8 mm



DURACUT®

mit Hartmetallschneiden, 1 Blatt gezahnt
with tungsten carbide edges, 1 blade serrated
con filos de carburo tungsteno, 1 hoja dentada
avec mors tungstène, 1 lame dentelée
con inserti in carburo di tungsteno, 1 lama dentata

UNIVERSAL
05-1810
12 cm, 4 3/4"

für weichen Draht bis \emptyset
for soft wire up to diam.
para blandos hasta un diam. de
pour couper les fils moux jusqu'à \emptyset
per cavi leggeri con \emptyset superiore a

1,2 mm

für harten Draht bis \emptyset
for hard wire up to diam.
para duros hasta un diam. de
pour couper les fils durs jusqu'à \emptyset
per cavi duri con \emptyset superiore a

0,8 mm



Drahtkneifzangen
 Wire Cutting Pliers
 Alicates corta-alambres
 Pincès coupe fils
 Tenaglie tagliafili



48-0470
 14,5 cm, 5 3/4"

Drahtbiege- und Schneidezange

Wire bending and cutting plier

Alicate corta y cierra-alambre

Pince à torsader et couper les fils

Tenaglie curva/taglia fili

1,5 mm

48-0471
 16 cm, 6 1/4"

Drahtbiege- und Schneidezange

Wire bending and cutting plier

Alicate corta y cierra-alambre

Pince à torsader et couper les fils

Tenaglie curva/taglia fili

1,5 mm

08-0890
 15,5 cm, 6"

Drahtkneifzange
 Wire cutting plier
 Alicate corta-alambre
 Pince à couper le fil
 Tenaglie tagliafili

2,0 mm

08-0888
 16 cm, 6 1/4"

Drahtkneifzange
 Wire cutting plier
 Alicate corta-alambre
 Pince à couper le fil
 Tenaglie tagliafili

2,0 mm

für weichen Draht bis ø
 for soft wire up to diam.
 para blandos hasta un diam de.
 pour couper les fils doux jusqu'à ø
 per cavi leggeri con ø superiore a

für harten Draht bis ø
 for hard wire up to diam.
 para duros hasta un diam. de
 pour couper les fils durs jusqu'à ø
 per cavi duri con ø superiore a

1,0 mm











1,0 mm

1,5 mm

1,5 mm

DURACUT® Drahtkneifzangen
 DURACUT® Wire Cutters
 DURACUT® Alicates corta-alambres
 DURACUT® Pincès à couper le fil
 DURACUT® Tenaglie tagliafili



				
				
<p>48-1497 12,5 cm, 5"</p> <p>Drahtkneifzange mit Hartmetallschneiden</p> <p>Wire cutter with tungsten carbide edges</p> <p>Alicate corta-alambre con filos de carburo tungsteno</p> <p>Pincès à couper le fil, avec mors tungstène</p> <p>Tenaglie tagliafili, con inserti in carburo di tungsteno</p>	<p>48-1498 18,5 cm, 7 1/4"</p> <p>Drahtkneifzange mit Hartmetallschneiden</p> <p>Wire cutter with tungsten carbide edges</p> <p>Alicate corta-alambre con filos de carburo tungsteno</p> <p>Pincès à couper le fil, avec mors tungstène</p> <p>Tenaglie tagliafili, con inserti in carburo di tungsteno</p>	<p>48-1491 17,5 cm, 7"</p> <p>Drahtkneifzange mit Hartmetallschneiden</p> <p>Wire cutter with tungsten carbide edges</p> <p>Alicate corta-alambre con filos de carburo tungsteno</p> <p>Pincès à couper le fil, avec mors tungstène</p> <p>Tenaglie tagliafili, con inserti in carburo di tungsteno</p>	<p>48-1495 22 cm, 8 3/4"</p> <p>Drahtkneifzange mit Hartmetallschneiden</p> <p>Wire cutter with tungsten carbide edges</p> <p>Alicate corta-alambre con filos de carburo tungsteno</p> <p>Pincès à couper le fil, avec mors tungstène</p> <p>Tenaglie tagliafili, con inserti in carburo di tungsteno</p>	<p>48-1496 23,5 cm, 9 1/4"</p> <p>Drahtkneifzange mit Hartmetallschneiden</p> <p>Wire cutter with tungsten carbide edges</p> <p>Alicate corta-alambre con filos de carburo tungsteno</p> <p>Pincès à couper le fil, avec mors tungstène</p> <p>Tenaglie tagliafili, con inserti in carburo di tungsteno</p>
0,6 mm	2,0 mm	2,0 mm	2,8 mm	3,0 mm
0,4 mm	1,7 mm	1,7 mm	2,5 mm	2,7 mm



Kopf- und Seitenschneider
 Front and Lateral Cutter
 Alicates de corte frontal y lateral
 Pince à couper le fil
 Cesoia con taglio frontale e laterale

Bolzenschneider
 Cutters
 Alicates corta-alambres
 Pinces
 Cesoie



48-1499
 18 cm, 7"

Kopf- und Seitenschneider mit Hartmetallschneiden, für weichen Draht bis \varnothing 2,0 mm und für harten Draht bis \varnothing 1,5 mm

Front and lateral cutter with tungsten carbide edges, for soft wire up to diam. 2.0 mm and for hard wire up to diam. 1.5 mm

Alicates de corte frontal y lateral con filos de carburo tungsteno para alambres blandos hasta un diam. de 2,0 mm y para alambres duros hasta un de 1,5 mm diam.

Pince à couper le fil, frontale et latérale, pour fil mou jusqu'à 2,0 mm \varnothing et pour fil dur jusqu'à 1,5 mm \varnothing

Cesoia con taglio frontale e laterale con inserti in carburo di tungsteno, per cavi morbidi con \varnothing superiore a 2 mm. e cavi duri con \varnothing inferiore a 1,5 mm



► **48-0498** 48 cm, 18³/₄"
48-0499 54 cm, 21¹/₄"

Bolzenschneider zum Abwickeln von Drähten, Schrauben und Nägeln bis \varnothing 6 mm

Cutters for cutting of wires, screws and pins up to diam. 6 mm

Alicates corta-alambres, tornillos y clavos hasta \varnothing 6 mm

Pinces à couper les fils, pivots et clous jusqu'à 6 mm \varnothing

Cesoia per cavi, viti e perni, con \varnothing superiore a 6 mm

Knochenbiopsie-Instrumente

Bone Biopsy Instruments

Instrumentos para biopsia ósea

Instrumentes pour biopsie osseuse

Strumenti per biopsia ossea



CHAMPY

► 48-0950

ø 5 mm

Biopsie-Instrument zur Entnahme von Knochenspänen aus dem Beckenkamm komplett, bestehend aus:

48-0951 1 Trokarhülse

48-0952 1 Punktionstrephine

48-0953 1 Stumpfer Mandrin

Bone biopsy trephine for iliac crest, complete, consisting of:

48-0951 1 Trocar cannula

48-0952 1 Biopsy trephine

48-0953 1 Blunt obturator

Trépano para la cresta iliaca, completo, compuesto de:

48-0951 1 Cánula de trocar

48-0952 1 Trépano de biopsia

48-0953 1 Mandrin romo

Instrument à biopsie pour prélever particules de l'os iliaque

complet, composé de:

48-0951 1 Canule de trocar

48-0952 1 Tréphine de biopsie

48-0953 1 Obturateur

Strumento biopsia per trucioli dell'iliaco, completa, composta da:

48-0951 1 Camicia per tre quarti

48-0952 1 Trapano per biopsia

48-0953 1 Otturatore

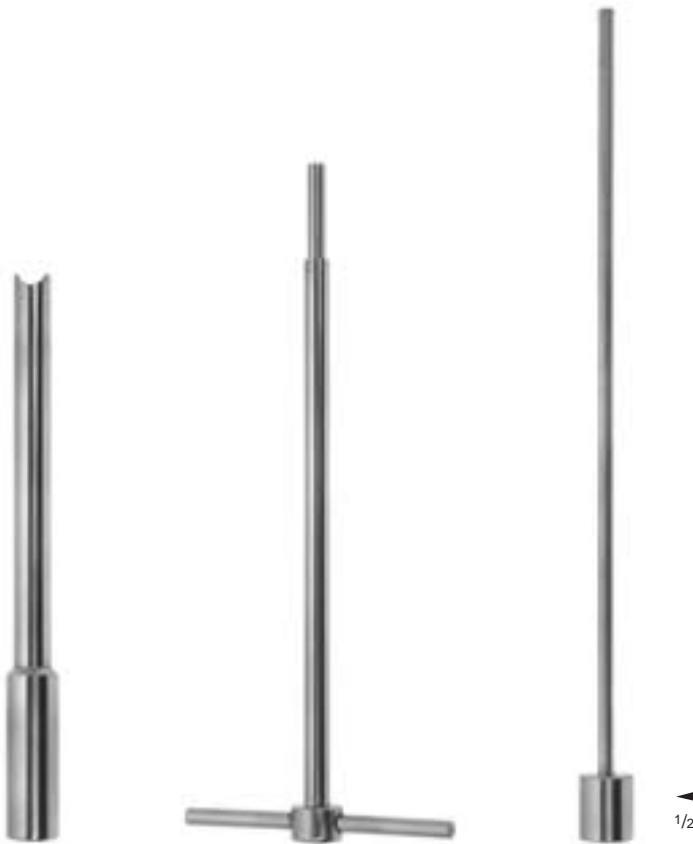

CHAMPY

48-0955

ø 8 mm

Biopsie-Instrument zur Entnahme von Knochenspänen aus dem Beckenkamm komplett, bestehend aus:

48-0956 1 Trokarhülse

48-0957 1 Punktionstrephine

48-0958 1 Stumpfer Mandrin

Bone biopsy trephine for iliac crest, complete, consisting of:

48-0956 1 Trocar cannula

48-0957 1 Biopsy trephine

48-0958 1 Blunt obturator

Trépano para la cresta iliaca, completo, compuesto de:

48-0956 1 Cánula de trocar

48-0957 1 Trépano de biopsia

48-0958 1 Mandrin romo

Instrument à biopsie pour prélever particules de l'os iliaque

complet, composé de:

48-0956 1 Canule de trocar

48-0957 1 Tréphine de biopsie

48-0958 1 Obturateur

Strumento biopsia per trucioli dell'iliaco, completa, composta da:

48-0956 1 Camicia per tre quarti

48-0957 1 Trapano per biopsia

48-0958 1 Otturatore



Notizen

Notes

Notas

Notes

Note



LAWNTON

Medizintechnik



Verband und Gips
Dressing
Vendajes
Pansements, Appareils plâtrés
Bendaggi, Gessature



Verbandscheren
Bandage Scissors
Tijeras para vendajes
Ciseaux à pansements
Forbici per bendaggi



SMITH
05-0802
- 05-0804



► 05-0802
18 cm, 7"

05-0804
20 cm, 8"

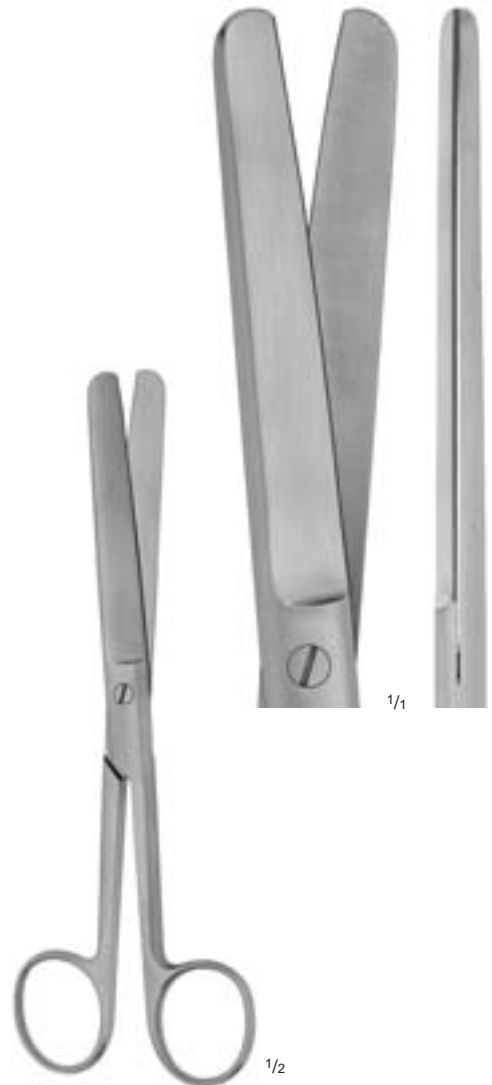

LANGE
05-0806
19 cm, 7 1/2"

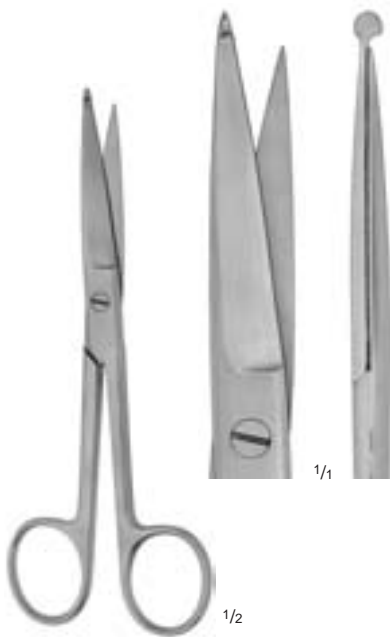

KNOWLES
 05-0895
 14,5 cm, 5³/₄"

für Fingerverbände
 for finger bandages
 para vendajes de dedos
 pour bandages des doigts
 per bendaggi delle dita



LISTER modif.
 05-0835
 14,5 cm, 5³/₄"

1 Blatt gezahnt
 1 blade serrated
 1 hoja dentada
 1 lame dentelée
 1 lama dentata

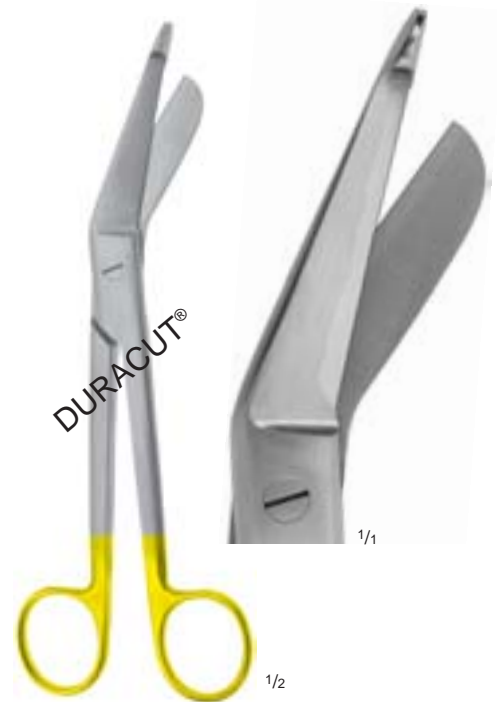

LISTER
 05-1850
 18 cm, 7"

mit Hartmetallschneiden
 with tungsten carbide edges
 con filos de carburo tungsteno
 avec des lames en tungstène
 con lame in carburo di tungsteno



LISTER
 05-0820
 - 05-0860



05-0820
 11,5 cm, 4¹/₂"



▶ 05-0830
 14,5 cm, 5³/₄"



05-0850
 18 cm, 7"



05-0860
 20 cm, 8"



Verband- und Kleiderstoffscheren
Bandage and Cloth Scissors
Tijeras para vendajes y tela
Cisailles à pansements et étoffes d'habillement
Cesoie per bendaggi e vestiti



LISTER
04-5810
14,5 cm, 5³/₄"

Universal Verband- und Kleiderstoffschere aus rostfreiem, säurebeständigem Stahl, mit 1 gezahnten Blatt und Kunststoffgriffen, bis 134°C im Autoklaven sterilisierbar.

Universal bandage and cloth scissors, made of acid-proof stainless steel, with 1 serrated blade and plastic handles, autoclavable up to 134°C.

Tijera universal para vendajes y tela, acero inoxidable y resistente a los ácidos, con 1 hoja dentada y mangos de plástico, esterilizable en autoclave hasta 134°C.

Ciseaux universels pour étoffes en acier inox, avec 1 lame crantée et anneaux en plastique, autoclavables à 134°C.

Cesoie per bendaggi e vestiti, in acciaio inox resistente agli acidi con 1 lama dentata, manico in plastica, sterilizzabile in autoclave fino 134°C.



04-5800
18 cm, 7"

Universal Verband- und Kleiderstoffschere aus rostfreiem, säurebeständigem Stahl, mit 1 gezahnten Blatt und Kunststoffgriffen, bis 134°C im Autoklaven sterilisierbar.

Universal bandage and cloth scissors, made of acid-proof stainless steel, with 1 serrated blade and plastic handles, autoclavable up to 134°C.

Tijera universal para vendajes y tela, acero inoxidable y resistente a los ácidos, con 1 hoja dentada y mangos de plástico, esterilizable en autoclave hasta 134°C.

Ciseaux universels pour étoffes en acier inox, avec 1 lame crantée et anneaux en plastique, autoclavables à 134°C.

Cesoie per bendaggi e vestiti, in acciaio inox resistente agli acidi con 1 lama dentata, manico in plastica, sterilizzabile in autoclave fino 134°C.



► 05-0950
20 cm, 8"

05-0952
23,5 cm, 9 1/4"

ESMARCH
05-0950
- 05-0952



42-0110
21 cm, 8 1/4"



BERGMANN
05-0864
23 cm, 9"



SEUTIN
42-0115
23 cm, 9"



Gipsscheren
Plaster-of-Paris Shears
Cizallas para escayolas
Cisailles pour appareils plâtrés
Cesoie per gessi



BRUNS
05-1970
24 cm, 9 1/2"

mit Hartmetallschneiden
with tungsten carbide edges
con filos de carburo tungsteno
avec des lames en tungstène
con lame in carburo di tungsteno



BRUNS
05-0970
24 cm, 9 1/2"



BRUNS
05-0975
24 cm, 9 1/2"

1 Blatt gezahnt
1 blade serrated
1 hoja dentada
1 lame dentelée
1 lama dentata

Gipsscheren
Plaster-of-Paris Shears
Cizallas para escayolas
Cisailles pour appareils plâtrés
Cesoie per gessi



1/1



1/1



1/2

STILLE-MINI
42-0118
19,5 cm, 7³/₄"

für kleine Gipsverbände
for small plaster dressings
para escayolas pequeñas
pour petits pansements plâtrés
per piccole gessature



1/2

STILLE
42-0120
24,5 cm, 9³/₄"



Gipsscheren
Plaster-of-Paris Shears
Cizallas para escayolas
Cisailles pour appareils plâtrés
Cesoie per gessi



42-0145
23 cm, 9"



▶ 42-0147
27 cm, 10³/₄"



42-0150
37,5 cm, 14³/₄"



◀
1/2

STILLE
42-0145
- 42-0150

Klinge mit verstärktem Rücken
blade with reinforced back
hoja con espalda reforzada
lame avec dos renforcé
lama con dorso rinforzato

Gipsmesser
Plaster Knives
Cuchillos para escayolas
Couteaux pour appareils plâtrés
Coltelli per gessi

Gipssäge
Plaster Saw
Sierra para escayolas
Scie pour appareils plâtrés
Seghe per gessi



ESMARCH
42-0245
18 cm, 7"

Gipsmesser
Plaster knife
Cuchillo para escayolas
Couteaux pour appareils plâtrés
Coltello per gessi



REINER
42-0240
18 cm, 7"

Gipsmesser
Plaster knife
Cuchillo para escayolas
Couteaux pour appareils plâtrés
Coltello per gessi



HOPKINS
42-0232
20 cm, 8"

Gipsmesser mit
Ebenholzheft
Plaster knife with
ebony handle
Cuchillo para escayolas
con mango de ébano
Couteaux pour appareils
plâtrés avec manche ébonite
Coltello per gessi con
manico in ebano



HOPKINS
42-0234
20,5 cm, 8"

Gipsmesser mit
Ebenholzheft
Plaster knife with
ebony handle
Cuchillo para escayolas
con mango de ébano
Couteaux pour appareils
plâtrés avec manche ébonite
Coltello per gessi con
manico in ebano



ENGEL
42-0210
15 cm, 6"

Gipssäge
Plaster saw
Sierra para escayolas
Scie pour appareils plâtrés
Seghe per apparecchi gessati



Oscillierende Gipssäge
Oscillating Plaster Saw
Sierra oscilante para escayolas
Scie oscillante à plâtre
Sega oscillante



42-0351 110 V / 50 Hz
42-0350 220 V / 50 Hz

Die oscillierende Gipssäge wird mit 2 rostfreien Sägeblättern \varnothing 50 + 65 mm (42-0356 + 42-0357) sowie 2 Schraubenschlüssel (42-0355), zum Auswechseln der Sägeblätter geliefert. Als Sonderzubehör für Hartverbände (z. B. Glasfaser etc.) sind 2 spezialgehärtete Sägeblätter \varnothing 50 + 65 mm (42-0358 + 42-0359) lieferbar. Es sollten keine ungepolsterten Gipsverbände aufgeschnitten werden, da durch Mitschwingen der angeklebten Haut am Gips Verletzungsgefahr für die Haut besteht. Für die Normalbenutzung sollte das kleine Sägeblatt mit \varnothing 50 mm verwendet werden. Das große Sägeblatt mit \varnothing 65 mm nur in Ausnahmefällen (z. B. bei dickem Gips etc.) verwenden. Das Gerät ist wartungsfrei, sollte jedoch alle 1 bis 2 Jahre vom Hersteller überprüft werden. Die Gipssäge ist mit einem Sicherheitsschutz-Schalter ausgerüstet. Dieser gewährleistet eine Überbelastung des Motors. Sollte durch Überbelastung die Gipssäge aussetzen, kann diese innerhalb weniger Minuten mittels eines Spezial-Einschalt-Knopfes wieder in Betrieb genommen werden. Dieser Einschalt-Knopf befindet sich unterhalb der Motor-Kabelzuführung. Um eine zu hohe Erwärmung zu vermeiden, empfehlen wir stumpfe und abgenutzte Sägeblätter auszuwechseln. Zur Auswechslung abgenutzter Sägeblätter sollten ausschließlich die mitgelieferten Schraubenschlüssel verwendet werden. Sie vermeiden dadurch ein Überdrehen des Extenters. In regelmäßigen Abständen sollte das rostfreie Kühl-Draht-Gitter gereinigt werden. In explosionsgefährdeten Bereichen darf die Gipssäge nicht verwendet werden. **Technische Daten:** Leistungsaufnahme 90 Watt • Schutzklasse II nach VDE 0740 • Schutzisoliert • Funkentstört • Motorschutzschalter • Gewicht 1500 g.

The oscillating plaster-saw is supplied with 2 stainless steel sawblades with diameters of 50 + 65 mm (42-0356 + 42-0357) plus 2 spanners (42-0355) to exchange the sawblades. As a special requisite for hard bandage (e. g. glass-fibre etc.) 2 specially hardened sawblades diameters 50 + 65 mm (42-0358 + 42-0359) are available. Normally, the small sawblade with diameter 50 mm is used. The large sawblade with diameter 65 mm is used in exceptional cases (e.g. by thick plaster etc.). The unit is maintenance-free, but should however be checked every 1 to 2 years by the manufacturers. The plaster-saw is equipped with a safety-protective switch. This guarantees the motor against overloading. Should the plaster-saw become unfunctional due to overloading the unit can be put into use again within minutes by use of a special switch-on button. The switch-on button is located underneath the motor-cable inlet. To prevent excessive heating we recommend rechanging of blunt and used sawblades. Replacement of used sawblades should only be undertaken with the use of the supplied spanners. This will prevent over-winding. The stainless steel cool-element-grid should be cleaned at regular intervals. The plaster-saw should not be used in explosive danger areas. **Technical Data:** Input 90 watt • Protection class II acc. to VDE 0740 • Protective insulated • Anti-signal interference • Motor-safety switch • Weight 1500 g.

La sierra oscilatoria para escayolas se entrega con dos hojas \varnothing 50 + 65 mm (42-0356 + 42-0357) para serrar y con dos llaves de tuerca especiales (42-0355) para cambiar las hojas de sierra. Para serrar objetos o escayolas de gran resistencia, como fibra de vidrio, disponemos de dos hojas de sierra especialmente templadas \varnothing 50 + 65 mm (42-0358 + 42-0359). No se debe nunca serrar ninguna escayola sin haber sido antes debidamente protegida, pues por la vibración, podrían ocasionarse heridas en la piel pegada a la escayola. Para el uso corriente se emplea la hoja de sierra de \varnothing 50 mm. La hoja de \varnothing 65 mm se usa en casos excepcionales, p.e. cuando la escayola es demasiado gruesa etc.. La sierra oscilante, no exige ningún cuidado especial; debe ser, sin embargo, controlada por el constructor cada año o dos. Esta equipada con un interruptor de seguridad. Dicho interruptor evita el recalentamiento excesivo del motor. En el caso que, por recalentamiento excesivo, se parase el motor, éste podría ser puesto nuevamente en función dentro de pocos minutos, articulando un interruptor especial que se encuentra junto a la salida del cable del motor. Para evitar que se recaliente, se aconseja cambiar las hojas de sierra que no estén en buen estado. Para cambiar las hojas de sierra usadas, debe emplearse únicamente la llave especial que acompaña la sierra. De vez en cuando debe limpiarse la rejilla inoxidable de refrigeración. En lugares, en los cuales exista peligro de explosión, no debe ser empleada dicha sierra. **Datos técnicos:** Potencia de desarrollo 90 W. • clase de protección II según VDE 0740 • protegida con capa aislante • protegida contra interferencias • interruptor protector para el motor • peso 1500 g.

La scie à plâtre oscillante est livrée avec deux lames inoxydables de 50 et 65 mm de \varnothing (42-0356 et 42-0357) ainsi que deux clés à écrous pour changer les lames. En accessoire spécial pour plâtres durs (par ex. fibres de verre etc.), 2 lames de scie en acier trempé spécial de 50 et 65 mm de \varnothing (42-0358 et 42-0359) sont disponibles. Ne pas couper de plâtres non rembourrés; en effet, la couverture de la peau collée au plâtre entraîne un risque de blessure de la peau. Pour l'emploi normal, utiliser la petite lame de scie de 50 mm de \varnothing . N'utiliser la grande lame de scie de 65 mm de \varnothing que dans les cas exceptionnels (par ex. pour des plâtres épais etc.). L'appareil ne demande pas d'entretien, il doit cependant être vérifié par le fabricant tous les 1 à 2 ans. La scie à plâtre est équipée d'un disjoncteur de sécurité. Ce dernier protège le moteur contre la surcharge. Si la scie disjoncte en raison d'une surcharge, elle peut être remise en service au bout de quelques minutes à l'aide d'un bouton spécial de mise en circuit. Ce bouton de mise en circuit se trouve au-dessous du passage du câble du moteur. Afin d'éviter un trop fort échauffement, nous conseillons de remplacer les lames de scie émoussées et usagées. Pour changer les lames de scie usagées, utiliser exclusivement les clés à écrous livrées avec la scie. Vous éviterez ainsi de fausser le dispositif de serrage. Nettoyer à intervalles réguliers la grille métallique inoxydable de refroidissement. Ne pas utiliser la scie à plâtre dans les zones de danger d'explosion. **Caractéristiques techniques:** puissance absorbée 90 Watt • Catégorie II de protection selon VDE 0740 • Double isolation • Antiparasitisme • Disjoncteur-protecteur • Poids 1500 g.

La sega oscillante è corredata con 2 lame in acciaio inox \varnothing 50 e 65 mm. (42-0356 e 42-0357) più 2 chiavi (42-0355) per il cambio delle lame. Quale speciale requisito per bendaggi duri (vetro, fibre, ecc.) sono disponibili 2 lame particolarmente indurite del \varnothing 50 e 65 mm. (42-0358 e 42-0359). Normalmente viene impiegata la lama piccola da 50 mm. La lama grande da 65 mm. viene impiegata in casi eccezionali (gesso spesso, ecc.). L'unità non necessita di manutenzione ma deve essere controllata dalla casa madre ogni 1 o 2 anni. La sega oscillante è munita di interruttore di sicurezza di protezione. Questo protegge il motore dai sovraccarichi. Qualora la sega oscillante fosse inutilizzabile per sovraccarico, l'unità potrà essere rimessa in funzione in pochi minuti attraverso uno speciale bottone situato nella parte inferiore dell'avvolgimento interno. Per prevenire eccessivi surriscaldamenti raccomandiamo di sostituire la lama troppo usata. La sostituzione delle lame deve essere effettuata impiegando esclusivamente le chiavi in dotazione al fine di prevenire sovrappressioni. La griglia di raffreddamento in acciaio inox deve essere pulita ad intervalli regolari. La sega oscillante non deve essere impiegata in aree con pericoli di esplosione. **Dati tecnici:** potenza 90 Watt. • classe di protezione II secondo le norme VDE 0740 • isolamento di protezione • protezione contro le interferenze • interruttore di protezione sul motore • peso 1500 gr.



42-0356
ø 50 mm

Ersatz-Sägeblatt
Spare saw blade
Hoja de sierra, repuesto
Lame de rechange
Lama di ricambio



42-0357
ø 65 mm

Ersatz-Sägeblatt
Spare saw blade
Hoja de sierra, repuesto
Lame de rechange
Lama di ricambio



42-0358
ø 50 mm

Ersatz-Sägeblatt, spezialgehärtet, für Fiberglas- und andere Hartverbände

Spare saw blade, special hardness, for dressing of fiber glass

Hoja de sierra templada especial, para escayolas de fibra de vidrio y otras escayolas gruesas, repuesto

Lame de rechange, à acier trempé pour bandages en fibres de verre et autres bandages durs

Lama di ricambio a temprata speciale per bendaggi in fibre di vetro ed altri bendaggi duri



42-0359
ø 65 mm

Ersatz-Sägeblatt, spezialgehärtet, für Fiberglas- und andere Hartverbände

Spare saw blade, special hardness, for dressing of fiber glass

Hoja de sierra templada especial, para escayolas de fibra de vidrio y otras escayolas gruesas, repuesto

Lame de rechange, à acier trempé pour bandages en fibres de verre et autres bandages durs

Lama di ricambio a temprata speciale per bendaggi in fibre di vetro ed altri bendaggi duri

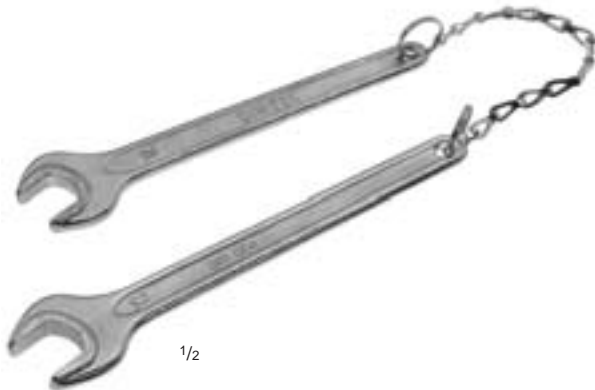

42-0355

Spannschlüssel
Spanners
Llaves de tuerca
Clés à vis
Chiavi



Gipsspreizer
Plaster Spreaders
Separadores para escayolas
Pincas écartantes à plâtre
Apri gesso

Gipsabreißzangen
Plaster Breakers
Pinzas para romper escayolas
Pincas écrasante pour plâtre
Rompi gesso



1/1



1/1



1/1



1/1

42-0302
17,5 cm, 7"

▶ 42-0300
26,5 cm, 10 1/2"



1/3

MOD. USA
42-0315
22,5 cm, 9"

Gipsspreizer
Plaster spreader
Separador para escayolas
Pince écartante à plâtre
Apri gesso



1/3

HENNIG
42-0320
27 cm, 10 3/4"

Gipsspreizer
Plaster spreader
Separador para escayolas
Pince écartante à plâtre
Apri gesso



1/3

WOLFF
42-0300
- 42-0302

Gipsabreißzangen
Plaster breakers
Pinza para romper escayolas
Pince écrasante pour plâtre
Rompi gesso



LAWNTON
Medizintechnik



Neurochirurgie und Laminektomie
Neurosurgery and Laminectomy
Neurocirugía y Laminectomía
Neurochirurgie et Laminectomie
Neurochirurgia e Laminectomia



Instrumente für Neurochirurgie und Laminektomie
Instruments for Neurosurgery and Laminectomy
Instrumentos para neurocirugía y laminectomía
Instruments pour neurochirurgie et laminectomie
Strumenti per neurochirurgia e laminectomia



Rasierklingen-Halter und -Brecher Seite 36
Razor Blade Holders and Breakers Page 36
Pinzas para sujetar y romper hojas de afeitarse Página 36
Pincettes pour saisir et casser les lames de rasoir Page 36
Pinze per afferrare e rompere le lamette di rasoio Pagina 36



Duramesser Seite 37
Dura Knives Page 37
Cuchillos para dura-madre Página 37
Couteaux pour dure-mère Page 37
Bisturi per dura-madre Pagina 37



Mikro-Federscheren, bajonettförmig Seite 66 - 67
Micro Spring Type Scissors, bayonet-shaped Page 66 - 67
Micro-Tijeras con mangos de resortes, forma en bayoneta Página 66 - 67
Micro ciseaux en forme de baïonnette avec manches à ressorts Page 66 - 67
Micro forbici con manici a molla, forma a baionetta Pagina 66 - 67



Scheren für Neurochirurgie Seite 100
Neurosurgical Scissors Page 100
Tijeras para neurocirugía Página 100
Ciseaux pour la neuro-chirurgie Page 100
Forbici per neurochirurgia Pagina 100



Mikro-Pinzetten, bajonettförmig Seite 125
Micro Forceps, bayonet-shaped Page 125
Micro-Pinzas, en forma bayoneta Página 125
Micro Pincas en forme de baïonnette Page 125
Micro Pinze con manici a baionetta Pagina 125



Tumor- und Gewebefäßpinzetten, bajonettförmig Seite 126 - 127
Tumor and Tissue Grasping Forceps, bayonet-shaped Page 126 - 127
Pinzas de agarre para tejido y tumor, en forma bayoneta Página 126 - 127
Pincas en forme de baïonnette pour saisir tumeurs et tissus Page 126 - 127
Pinze per afferrare tessuti e tumori, a baionetta Pagina 126 - 127

Instrumente für Neurochirurgie und Laminektomie
 Instruments for Neurosurgery and Laminectomy
 Instrumentos para neurocirugía y laminectomía
 Instruments pour neurochirurgie et laminectomie
 Strumenti per neurochirurgia e laminectomia



Gefäßclips für temporären Gebrauch	Seite	154 - 156
Vessel Clips for temporary occlusion	Page	154 - 156
Clips vasculares para oclusión temporal	Página	154 - 156
Serre-Fines pour occlusion temporaire	Page	154 - 156
Pinze per occlusioni temporanee	Pagina	154 - 156



Approximatoren	Seite	157 - 159
Approximators	Page	157 - 159
Aproximadores	Página	157 - 159
Approximateurs	Page	157 - 159
Aprossimatori	Pagina	157 - 159



Durahäkchen	Seite	212, 216 - 218
Dura Retractors	Page	212, 216 - 218
Ganchos para dura-madre	Página	212, 216 - 218
Crochets pour la dura-mère	Page	212, 216 - 218
Uncini per dura-madre	Pagina	212, 216 - 218



Nerv- und Gefäßhäkchen	Seite	213 - 215
Nerve and Vessel Hooks	Page	213 - 215
Ganchos para nervios y vasos	Página	213 - 215
Crochets à nerfs et à vaisseaux	Page	213 - 215
Uncini per nervi e vasi	Pagina	213 - 215



Explorations- und Koagulationshäkchen, isoliert	Seite	215
Exploration and Coagulation Hooks, insulated	Page	215
Ganchos para exploración y coagulación, aislados	Página	215
Crochets pour exploration et coagulation, isolés	Page	215
Uncini per esplorazione e coagulazione, isolati	Pagina	215



Laminektomie-Wundspreizer	Seite	279 - 280, 284, 286 - 287
Laminectomy Retractors	Page	279 - 280, 284, 286 - 287
Separadores para laminectomía	Página	279 - 280, 284, 286 - 287
Ecarteurs pour laminectomie	Page	279 - 280, 284, 286 - 287
Divaricatori per laminectomia	Pagina	279 - 280, 284, 286 - 287





Instrumente für Neurochirurgie und Laminektomie
Instruments for Neurosurgery and Laminectomy
Instrumentos para neurocirugía y laminectomía
Instruments pour neurochirurgie et laminectomie
Strumenti per neurochirurgia e laminectomia



Wundspreizer für die cervicale Wirbelsäule Seite 285, 290 - 293
Retractors for cervical spine Page 285, 290 - 293
Separadores para la columna cervical Página 285, 290 - 293
Ecarteurs pour colonne cervicale Page 285, 290 - 293
Divaricatori per colonna cervicale Pagina 285, 290 - 293



Wundspreizer für die Wirbelsäule Seite 288 - 289
Retractors for vertebral column Page 288 - 289
Separadores para la columna vertebral Página 288 - 289
Ecarteurs pour colonne vertebrale Page 288 - 289
Divaricatori per colonna vertebrale Pagina 288 - 289



Wundspreizer für die lumbale Wirbelsäule Seite 294
Retractors for lumbar vertebral column Page 294
Separadores para la cirugía lumbar vertebral Página 294
Ecarteurs pour chirurgie lombaire Page 294
Divaricatori per colonna lombare e vertebrale Pagina 294



Spekula für lumbale Bandscheibenoperationen Seite 295
Specula for lumbar vertebral operations Page 295
Espéculos para la cirugía lumbar vertebral Página 295
Spéculum pour chirurgie lombaire Page 295
Speculo per interventi lombo-vertebrali Pagina 295



Wirbelkörperspreizer Seite 296
Lamina Spreaders Page 296
Separadores para cuerpos vertebrales Página 296
Ecarteurs pour corps vertébraux Page 296
Separatori per vertebre Pagina 296



Mikro-Nadelhalter, bajonettförmig Seite 362
Micro Needle Holders, bayonet-shaped Page 362
Micro-Porta-agujas, en forma bayoneta Página 362
Micro porte-aiguilles en forme de baïonnette Page 362
Micro porta-aghi con manici a baionetta Pagina 362

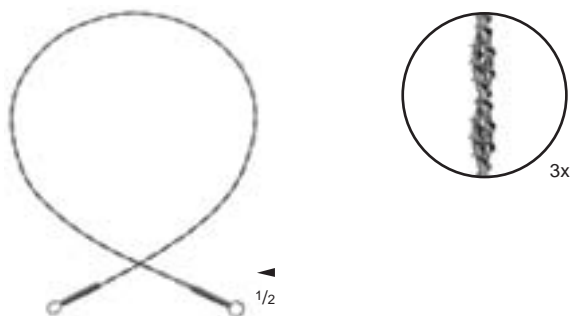

- OLIVECRONA (GIGLI)**
- ▶ 47-0360 25 cm, 10"
 - 47-0365 30 cm, 12"
 - 47-0367 40 cm, 16"
 - 47-0370 50 cm, 20"
 - 47-0371 60 cm, 24"
 - 47-0375 70 cm, 28"

Drahtsägen
 Wire saws
 Sierras de hilo
 Fils-scies
 Fili per sega

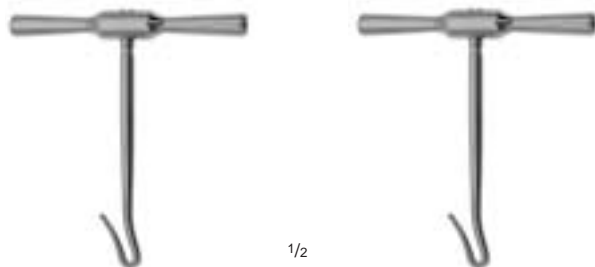

GIGLI
 47-0350
 7 cm, 2 3/4"

Handgriffe für Drahtsägen, 1 Paar
 Hook handles for wire saws, 1 pair
 Mango con gancho, para sierras de hilo, 1 par
 Poignées pour scies, 1 paire
 Manico ad uncino per fili per sega, 1 paio



DE MARTEL (BAILEY)
 50-0335
 33 cm, 13"

Einführungsinstrument für Drahtsägen
 Conductor for wire saws
 Conductor para sierras de hilo
 Conducteur pour scies
 Guida per fili per sega



Schädelzangen
Cranial Rongeur Forceps
Pinzas saca-bocado craneal
Rongeurs crâniens
Pinze per ossa del cranio



53-0971



53-0976



53-0977



1/2

DAHLGREN
53-0970
20 cm, 8"

Schädelstanze mit 2 Haken (53-0971)

Cranial rongeur with 2 hooks (53-0971)

Pinza saca-bocado craneal con
2 ganchos (53-0971)

Rongeur crâniens avec 2 crochets
(53-0971)

Pinza per cranio con 2 ganci (53-0971)



1/2

DE VILBISS
53-0975
20,5 cm, 8"

Schädelstanze mit je 1 Haken klein
(53-0976) und groß (53-0977)

Cranial rongeur with 1 hook each small
(53-0976) and large (53-0977)

Pinza saca-bocado craneal con 1 gancho
pequeño (53-0976) y grande (53-0977)

Rongeur crâniens avec 1 crochet petit
(53-0976) et grand (53-0977)

Pinza per cranio con 1 gancio piccolo
(53-0976) e 1 grande (53-0977)



1/2

CONE
50-0255
22,5 cm, 9"

Schädelstanzzange bis 12 mm
Schädelstärke

Cranial punch rongeur for maxi-
mum of 12 mm of bone

Pinza saca-bocados craneal
para craneo hasta 12 mm

Pince crânienne jusqu'à 12 mm
épaisseurs du crâne

Pinza per cranio, asta 12 mm.



CRUTCHFIELD
 48-0518
 ø 3,5 mm

Vorbohrer für CRUTCHFIELD-Schädelhalter

Drill point for CRUTCHFIELD cervical traction tongs

Perforador inicial para pinzas de tracción craneal CRUTCHFIELD

Alésoir pour étrier traction crânienne de CRUTCHFIELD

Alesatore per pinze di trazione craniale di CRUTCHFIELD



CRUTCHFIELD
 48-0517
 ø 5,0 mm

Vorbohrer für CRUTCHFIELD-Schädelhalter

Drill point for CRUTCHFIELD cervical traction tongs

Perforador inicial para pinzas de tracción craneal CRUTCHFIELD

Alésoir pour étrier traction crânienne de CRUTCHFIELD

Alesatore per pinze di trazione craniale di CRUTCHFIELD

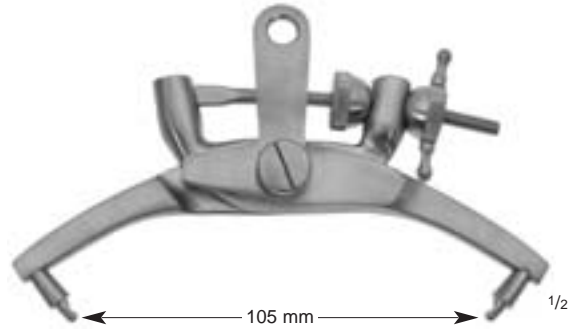

CRUTCHFIELD
 52-0520

Schädelhalter, kleine Größe
 Cervical traction tongs, small size
 Pinza de tracción craneal, tamaño pequeño
 Etrier traction crânienne, petit modèle
 Pinza per trazione craniale, modello piccolo

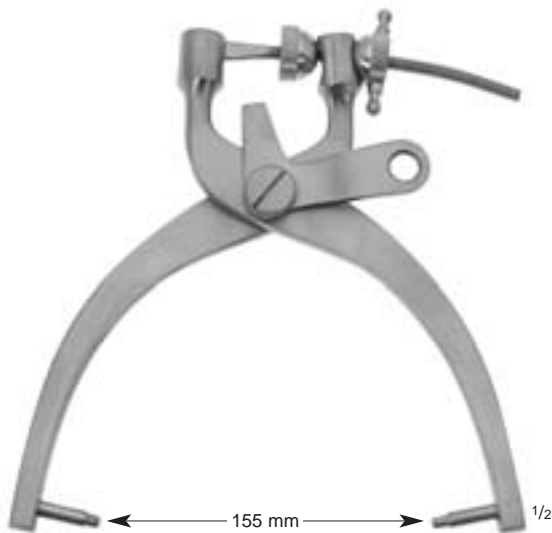

CRUTCHFIELD
 52-0525

Schädelhalter, mittlere Größe
 Cervical traction tongs, medium size
 Pinza de tracción craneal, tamaño mediano
 Etrier traction crânienne, modèle moyen
 Pinza per trazione craniale, modello medio



52-0542

Ersatzdorn
 Spare pin
 Punta de repuesto
 Pointe de rechange seule
 Punta di scorta sola

52-0540

Schädelhalter für Extension der Halswirbel, großes Modell, Dorne verstellbar, deshalb Vorbohren nicht erforderlich

Cervical traction tongs, for extension of the neck vertebrae, large size, pins adjustable hence no initial drilling

Pinza de tracción craneal para la extensión de las vertebrae de cuello, tamaño grande, puntas ajustables suprimiendo perforaciones iniciales

Etrier traction crânienne, pour l'extension des vertèbres cervicales, grand modèle, mandrins réglables supprimant la perforation initiale

Pinza per trazione craniale e l'estensione delle vertebre del collo, modello grande, punte regolabili al fine di evitare la perforazione iniziale



Klammerinstrumentarium
 Clip Instruments
 Instrumental para grapar
 Instruments à suture
 Strumenti per mettere i punti



1/1

MC KENZIE
50-0631

Silberklammern in Plastikbehälter,
 zu 100 Stück

Silver brain clips in plastic vial, comprising
 100 pieces

Grapas de plata en tubo de plástico,
 conteniendo 100 piezas

Agrafes en argent, en petit tube en matière
 plastique, par 100 pièces

Agrafes di argento, contenuti in piccoli tubi
 di materiale plastico, 100 pezzi per tubo



1/1

MC KENZIE
50-0633

Silberdraht zur Herstellung von
 Klammern, in Ringen zu 2,5 gr.

Silver wire in coils of 2.5 g

Hilo de plata para producir
 grapas, en rollos de 2,5 gr.

Fil d'argent pour fabriquer des
 agrafes par rouleaux de 2,5 g

Filo di argento per la costruzione
 di agrafes in rotoli da gr. 2,5



1/3

MC KENZIE
50-0635
148 x 40 x 6 mm

Klammerblock mit 1 Klammern-
 bügel und 1 Schiebedeckel

Silver clip carrier with 1 clip
 holding rack and 1 sliding cover

Porta-grapas con 1 riel para
 grapas y 1 tapa corredera

Support porte-agrafes, avec 1 rangée
 d'agrafes et 1 couvercle coulissant

Supporto porta-agrafes, con 1 fila
 di agrafes e 1 copertura a scorrimento

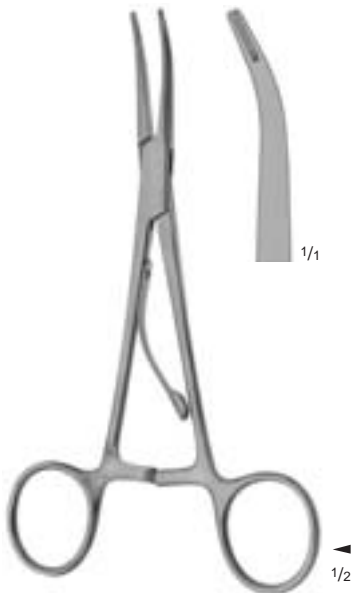

1/1

1/2

MC KENZIE

- ▶ 50-0600 15,5 cm, 6"
- 50-0602 18,5 cm, 7 1/4"

Klammer-Anlegezangen für Silberklammern 50-0631
 Clip applying forceps for silver clips 50-0631
 Pinzas clipadoras para las grapas de plata 50-0631
 Pince pose clips 50-0631
 Pinza metti agrafes per agrafes in argento 50-0631

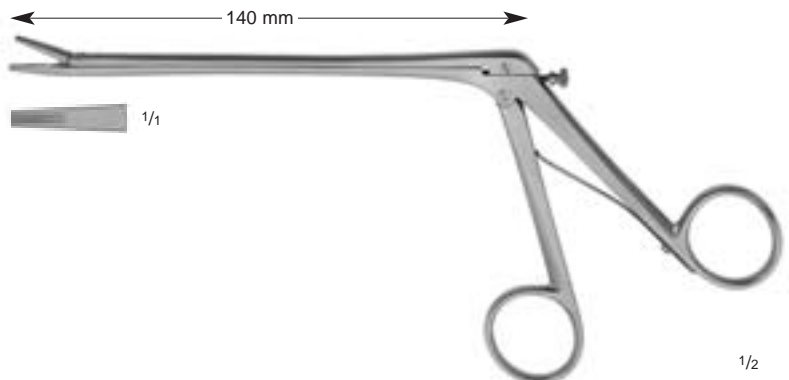

140 mm

1/1

1/2

OLIVECRONA-TOENNIS (SCOVILLE)
50-0679
140 mm

Klammer-Anlegezange für Silberklammern 50-0631
 Clip applying forceps for silver clips 50-0631
 Pinza para colocar las grapas de plata 50-0631
 Pince pose clips 50-0631
 Pinza metti agrafes per agrafes in argento 50-0631



MOD. KÖLN
 50-0649

Kopfhautklammern, in Packungen zu 10 Stück

Scalp hemostasis clips, in packages of 10 pieces

Pinza hemostática para cuero cabelludo, en paquetes de 10 piezas

Agrafes hémostatiques pour cuir chevelu en paquets de 10 pièces

Agrafes emostatici per cuoio capelluto, in confezioni da 10 pezzi



RANEY
 50-0658

Kopfhautklammern, in Packungen zu 12 Stück

Scalp hemostasis clips, in packages of 12 pieces

Pinza hemostática para cuero cabelludo, en paquetes de 12 piezas

Agrafes hémostatiques pour cuir chevelu en paquets de 12 pièces

Agrafes emostatici per cuoio capelluto, in confezioni da 12 pezzi

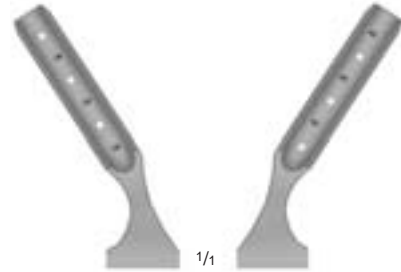

RANEY
 50-0650
 16 cm, 6 1/4"

Anlege- und Abnehmzange für Kopfhautklammern 50-0658

Applying and removing forceps for scalp hemostasis clips 50-0658

Pinza para aplicar y quitar clips hemostáticas de cuero cabelludo 50-0658

Pince pour poser et retirer les clips hémostatiques du cuir chevelu 50-0658

Pinza per applicare e togliere le agrafose emostatiche al cuoio capelluto 50-0658

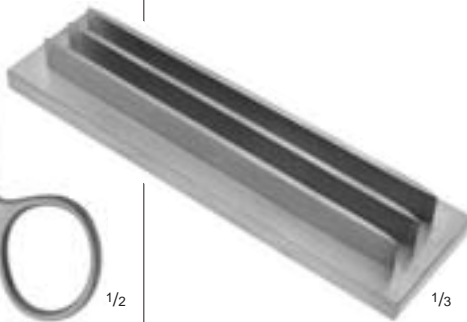

RANEY
 50-0652
 180 x 50 x 25 mm

Klammerblock mit 3 Klammernbügeln

Scalp hemostasis clip carrier with 3 clip holding racks

Porta-grapas con 3 rieles para grapas

Support porte-agrafes, avec 3 rangées d'agrafes

Supporto porta-agrafos, con 3 file di agrafose

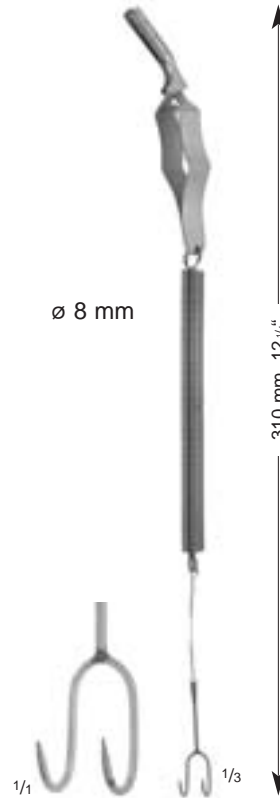

YASARGIL
 52-0252
 31 cm, 12 1/4"

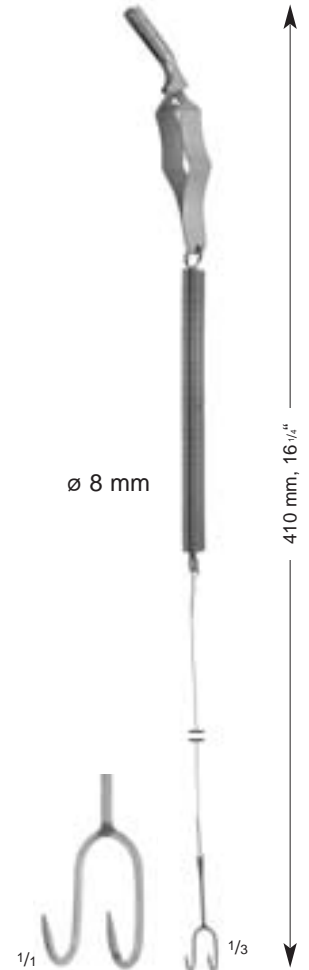

YASARGIL
 52-0254
 41 cm, 16 1/4"

Federhaken zur Galea-Fixation mit Bulldogklemme zum Befestigen am Abdecktuch
 Spring hooks for galea fixation with bulldog clamp, to be fastened to covering drape
 Gancho con muelle para la fijación de la galea, con pinza de bulldog para agarrar tela
 Crochets à muelle pour fixer la galea, avec pince bulldog pour fixer au champ opératoire
 Ganci a molla per fissare la galea con clamp bulldog, da applicare al telo di copertura



Hypophysektomie-Instrumente
 Pituitary Instruments
 Instrumentos para la hipofisectomía
 Instruments pour la hypophysectomie
 Strumenti per ipofisi



LANDOLT-CUSHING
 51-0540 ø 15 mm x 70 mm
 ▶ 51-0541 ø 15 mm x 90 mm

Spekula für trans-sphenoidale
 Hypophysektomie
 Specula for trans-sphenoidal
 hypophysectomy
 Espéculos para la hipofisectomía
 trans-sfenoidal
 Spécula pour la hypophysectomie
 transsphénoïdale
 Speculo per ipofisectomia trans-
 sfenoidale

1/2

ø 4 mm

ø 4 mm

ø 4 mm



1/1

1/1

1/1

RAY

▶ 51-0528
 18,5 cm, 7 1/4"

Kürette, horizontal
 45°

Curette, horizontal
 45°

Cureta horizontal
 45°

Curette horizontale
 45°

Curetta orizzontale
 45°

RAY

51-0524
 18,5 cm, 7 1/4"

Kürette, horizontal
 90°

Curette, horizontal
 90°

Cureta horizontal
 90°

Curette horizontale
 90°

Curetta orizzontale
 90°

RAY

51-0534
 18,5 cm, 7 1/4"

Kürette, vertikal
 45°

Curette, vertical
 45°

Cureta vertical
 45°

Curette verticale
 45°

Curetta verticale
 45°

1/2

ø 4 mm

ø 6 mm



1/1

1/1

HARDY

▶ 51-0577
 26 cm, 10 1/4"

Kürette, horizontal
 90°, biegsam

Curette, horizontal
 90°, malleable

Cureta horizontal
 90°, maleable

Curette horizontale
 90°, malléable

Curetta orizzontale
 90°, malleabile

HARDY

51-0578
 26 cm, 10 1/4"

Kürette, horizontal
 90°, biegsam

Curette, horizontal
 90°, malleable

Cureta horizontal
 90°, maleable

Curette horizontale
 90°, malléable

Curetta orizzontale
 90°, malleabile

1/2

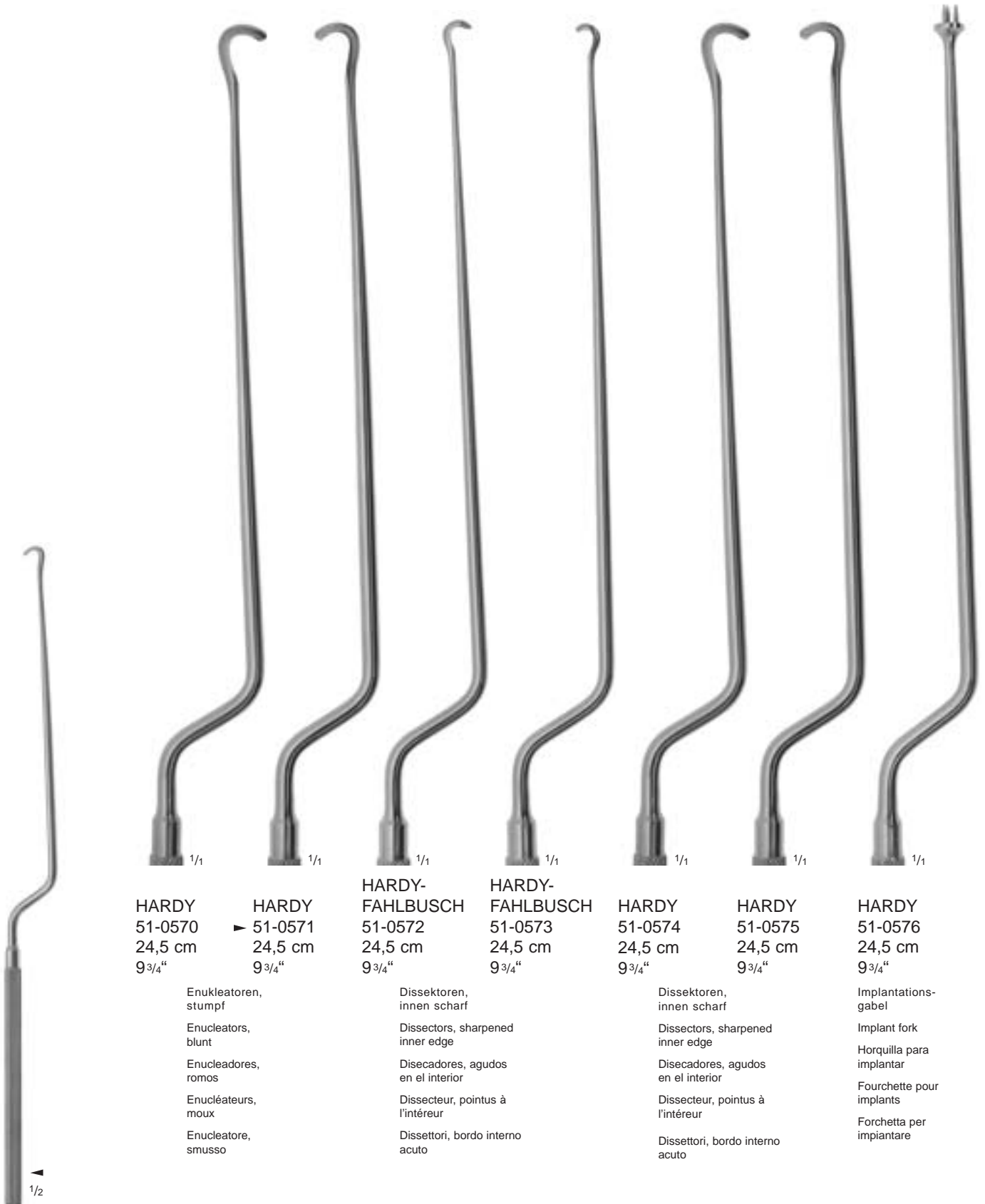

HARDY
 51-0570
 24,5 cm
 9 3/4"

Enukleatoren,
 stumpf
 Enucleators,
 blunt
 Enucleadores,
 romos
 Enucléateurs,
 moux
 Enucleatore,
 smusso

HARDY
 51-0571
 24,5 cm
 9 3/4"

HARDY-
 FAHLBUSCH
 51-0572
 24,5 cm
 9 3/4"

Dissektoren,
 innen scharf
 Dissectors, sharpened
 inner edge
 Disecadores, agudos
 en el interior
 Dissecteur, pointus à
 l'intérieur
 Dissettori, bordo interno
 acuto

HARDY-
 FAHLBUSCH
 51-0573
 24,5 cm
 9 3/4"

HARDY
 51-0574
 24,5 cm
 9 3/4"

Dissektoren,
 innen scharf
 Dissectors, sharpened
 inner edge
 Disecadores, agudos
 en el interior
 Dissecteur, pointus à
 l'intérieur
 Dissettori, bordo interno
 acuto

HARDY
 51-0575
 24,5 cm
 9 3/4"

HARDY
 51-0576
 24,5 cm
 9 3/4"

Implantations-
 gabel
 Implant fork
 Horquilla para
 implantar
 Fourchette pour
 implants
 Forchetta per
 impiantare



Mikro-Instrumente
 Micro Instruments
 Instrumentos para microcirugía
 Instruments pour microchirurgie
 Strumenti per microchirurgia



JACOBSON
 57-0080
 18,5 cm, 7 1/4"

Knopfsonde
 Buttoned probe
 Sonda abotonada
 Sonde boutonée
 Sonda bottonuta



JACOBSON
 57-0085
 18,5 cm, 7 1/4"

Doppelsonde
 Twin probe
 Sonda doble
 Sonde double
 Sonda doppia



JACOBSON
 57-0090
 18,5 cm, 7 1/4"

Fadengabel
 Suture pusher
 Empujador de sutura
 Fourche à fil
 Punzone per sutura



YASARGIL
 57-0115
 18,5 cm, 7 1/4"

Raspatorium
 Raspatory
 Legra
 Rugine-raspatoire
 Periostotomo



YASARGIL
 57-0175
 18,5 cm, 7 1/4"

Dissektor
 Dissector
 Disecador
 Dissecteur
 Dissetto



YASARGIL
 57-0110
 18,5 cm, 7 1/4"

Raspatorium
 Raspatory
 Legra
 Rugine-raspatoire
 Periostotomo



YASARGIL
 57-0100
 18,5 cm, 7 1/4"

Raspatorium
 Raspatory
 Legra
 Rugine-raspatoire
 Periostotomo



YASARGIL
 57-0105
 18,5 cm, 7 1/4"

Raspatorium
 Raspatory
 Legra
 Rugine-raspatoire
 Periostotomo



JACOBSON
 57-0095
 18,5 cm, 7 1/4"

Gefäßmesser
 Vessel knife
 Cuchillo para vasos
 Couteau pour vaisseaux
 Bisturi per vasi



YASARGIL
 57-0130
 18,5 cm, 7 1/4"
 Raspatorium
 Raspatory
 Legra
 Rugine-raspatoire
 Periototomo



YASARGIL
 57-0120
 18,5 cm, 7 1/4"
 Raspatorium
 Raspatory
 Legra
 Rugine-raspatoire
 Periototomo



YASARGIL
 57-0125
 18,5 cm, 7 1/4"
 Raspatorium
 Raspatory
 Legra
 Rugine-raspatoire
 Periototomo



YASARGIL
 57-0050
 18,5 cm, 7 1/4"
 Scharfer Löffel
 Scoop
 Cucharilla cortante
 Curette tranchante
 Curetta tagliente



YASARGIL
 57-0098
 18,5 cm, 7 1/4"
 Gefäßmesser
 Vessel knife
 Cuchillo para vasos
 Couteau pour vaisseaux
 Bisturi per vasi



YASARGIL
 57-0099
 18,5 cm, 7 1/4"
 Gefäßmesser
 Vessel knife
 Cuchillo para vasos
 Couteau pour vaisseaux
 Bisturi per vasi



KOOS
 57-0091
 18,5 cm, 7 1/4"
 Gefäßmesser
 Vessel knife
 Cuchillo para vasos
 Couteau pour vaisseaux
 Bisturi per vasi



KOOS
 57-0094
 18,5 cm, 7 1/4"
 Gefäßmesser
 Vessel knife
 Cuchillo para vasos
 Couteau pour vaisseaux
 Bisturi per vasi



KOOS
 57-0092
 18,5 cm, 7 1/4"
 Gefäßmesser
 Vessel knife
 Cuchillo para vasos
 Couteau pour vaisseaux
 Bisturi per vasi



KOOS
 57-0093
 18,5 cm, 7 1/4"
 Gefäßmesser
 Vessel knife
 Cuchillo para vasos
 Couteau pour vaisseaux
 Bisturi per vasi



KRAUS
 57-0096
 18,5 cm, 7 1/4"
 Gefäßmesser
 Vessel knife
 Cuchillo para vasos
 Couteau pour vaisseaux
 Bisturi per vasi

Schneide seitlich
 lateral cutting edge
 filo de corte lateral
 tranchant latéral
 taglio laterale



► 57-0132
23 cm, 9"
Häkchen
Hook
Gancho
Crochet
Uncino

1/1



57-0134
23 cm, 9"
Häkchen
Hook
Gancho
Crochet
Uncino

1/1



57-0136
23 cm, 9"
Dissektor
Dissector
Disecador
Dissecteur
Dissettore

1/1



57-0138
23 cm, 9"
Dissektor
Dissector
Disecador
Dissecteur
Dissettore

1/1



1/2

57-0132
- 57-0148



57-0142
23 cm, 9"
Raspatorium
Raspatory
Legra
Rugine-raspatoire
Periostotomo

1/1



57-0144
23 cm, 9"
Raspatorium
Raspatory
Legra
Rugine-raspatoire
Periostotomo

1/1



57-0146
23 cm, 9"
Scharfer Löffel
Scoop
Cucharilla cortante
Curette tranchante
Curetta tagliente

1/1



57-0148
23 cm, 9"
Scharfer Löffel
Scoop
Cucharilla cortante
Curette tranchante
Curetta tagliente

1/1



► 57-0150
 23 cm
 9"

Dissektor
 Dissector
 Disecador
 Dissecteur
 Dissettore

57-0152
 23 cm
 9"

Dissektor
 Dissector
 Disecador
 Dissecteur
 Dissettore

57-0154
 23 cm
 9"

Raspatorium
 Raspatory
 Legra
 Rugine-raspatoire
 Periostotomo

57-0150
 - 57-0154

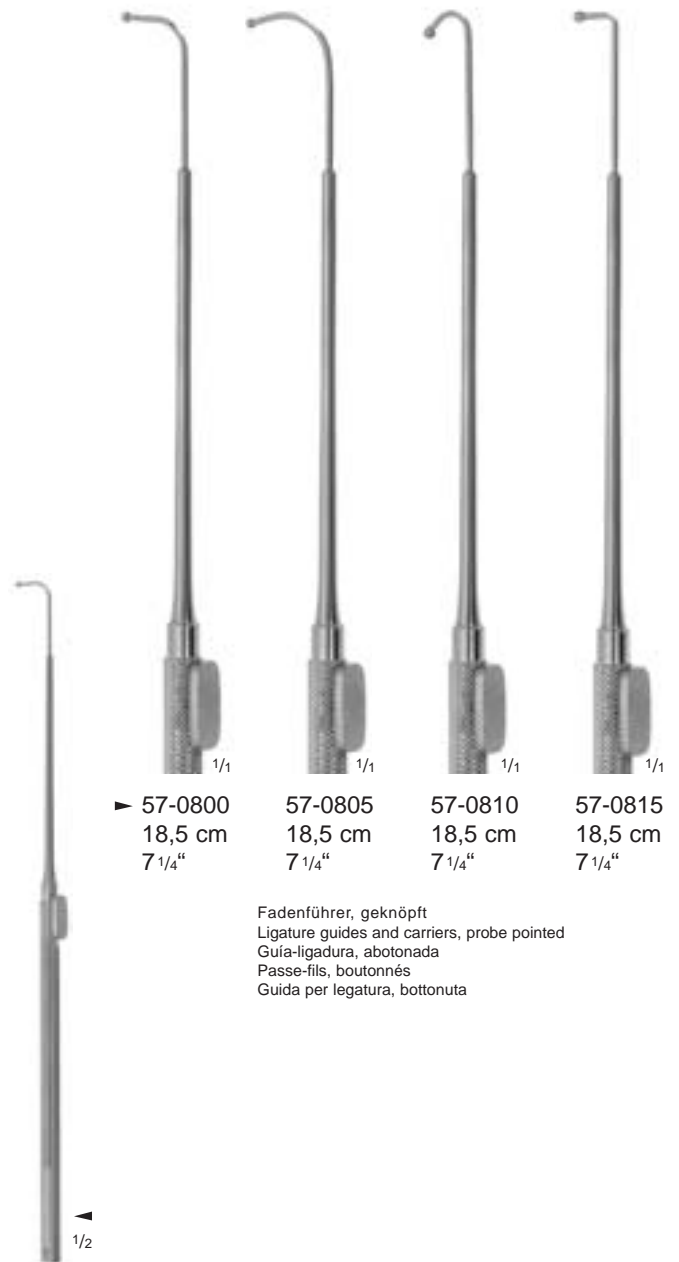

► 57-0800
 18,5 cm
 7 1/4"

Fadenführer, geknöpft
 Ligature guides and carriers, probe pointed
 Guía-ligadura, abotonada
 Passe-fils, boutonnés
 Guida per legatura, bottonuta

57-0805
 18,5 cm
 7 1/4"

57-0810
 18,5 cm
 7 1/4"

57-0815
 18,5 cm
 7 1/4"

YASARGIL
 57-0800
 - 57-0815



Dura-Separatoren
Dura Separators
Disecadores de dura-madre
Dissecteurs pour la dure-mère
Dissettori per la dura-madre

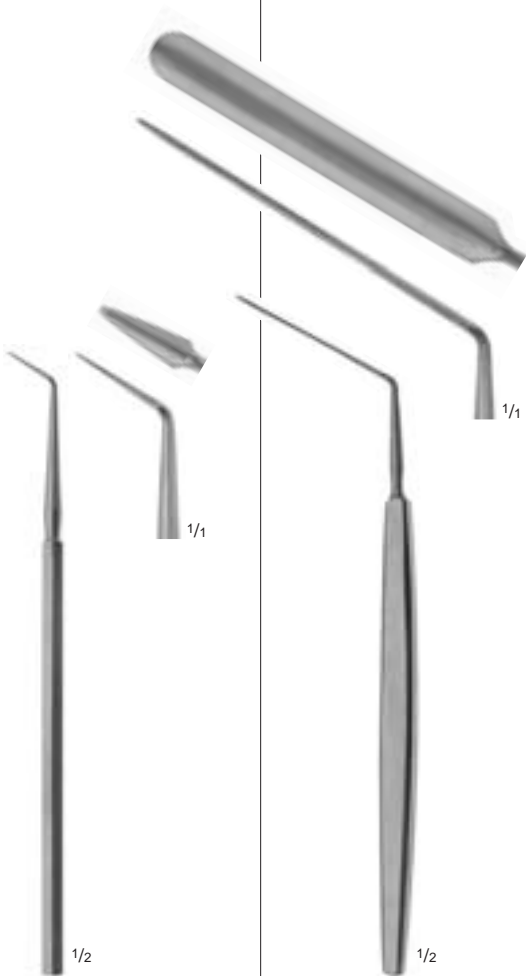

FRAZIER
51-0745
16,5 cm, 6 1/2"

HORSLEY
51-0730
18,5 cm, 7 1/4"



MILLIGAN
51-0731
21 cm, 8 1/4"



SACHS
51-0735
20 cm, 8"

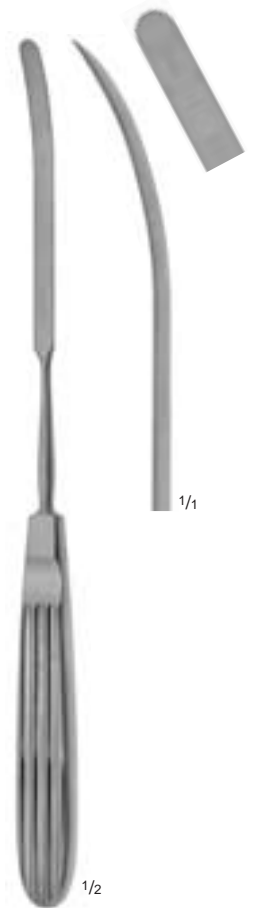

SACHS
51-0729
23 cm, 9"



PENFIELD
 51-0790
 17,5 cm, 7"



PENFIELD
 51-0792
 19,5 cm, 7³/₄"



PENFIELD
 51-0794
 19,5 cm, 7³/₄"



PENFIELD
 51-0796
 21,5 cm, 8¹/₂"



PENFIELD
 51-0798
 29 cm, 11¹/₂"



Dura-Dissektoren
Dura Dissectors
Disecadores para dura-madre
Dissecteurs à dure-mère
Dissettori per la dura-madre



TOENNIS
51-0634
24 cm, 9 1/2"



TOENNIS
51-0636
24 cm, 9 1/2"



OLIVECRONA
51-0640 18 cm, 7"
▶ 51-0641 24 cm, 9 1/2"



OLIVECRONA
51-0643 19,5 cm, 7 3/4"
▶ 51-0644 24,0 cm, 9 1/2"

Nervwurzelhaken
Nerve Root Retractors
Separadores para la raíz de nervios
Rétracteurs pour racines nerveuses
Separatori per le radici dei nervi

Dekompressionshaken
Decompression Hook
Ganchos para decompresión
Crochets pour décompression
Ganci per decompressione



LOVE
52-0200
20,5 cm, 8"

Nervwurzelhaken
Nerve root retractor
Separador para la raíz de nervios
Rétracteur pour racines nerveuses
Separatore per le radici dei nervi

1/2



45°

LOVE
52-0205
18 cm, 7"

Nervwurzelhaken
Nerve root retractor
Separador para la raíz de nervios
Rétracteur pour racines nerveuses
Separatore per le radici dei nervi

1/2



90°

LOVE
52-0210
14 cm, 5 1/2"

Nervwurzelhaken
Nerve root retractor
Separador para la raíz de nervios
Rétracteur pour racines nerveuses
Separatore per le radici dei nervi

1/2



LOVE
52-0202
22,5 cm, 9"

Nervwurzelhaken
Nerve root retractor
Separador para la raíz de nervios
Rétracteur pour racines nerveuses
Separatore per le radici dei nervi

1/2



SCOVILLE
52-0212
23 cm, 9"

Nervwurzelhaken
Nerve root retractor
Separador para la raíz de nervios
Rétracteur pour racines nerveuses
Separatore per le radici dei nervi

1/2



HOLSHER
52-0214
24 cm, 9 1/2"

Nervwurzelhaken
Nerve root retractor
Separador para la raíz de nervios
Rétracteur pour racines nerveuses
Separatore per le radici dei nervi

1/2

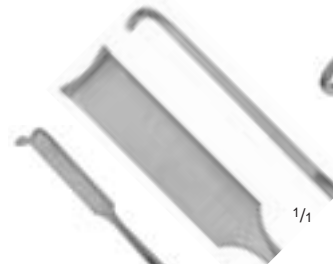

SCOVILLE
52-0216
20 cm, 8"

Nervwurzelhaken
Nerve root retractor
Separador para la raíz de nervios
Rétracteur pour racines nerveuses
Separatore per le radici dei nervi

1/2

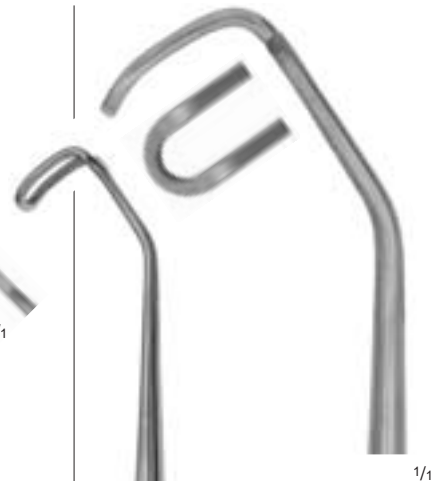

CUSHING
52-0250
21 cm, 8 1/4"

Dekompressionshaken
Decompression hook
Gancho para decompresión
Crochet pour décompression
Gancio per decompressione

1/1



Retraktoren zur Fixation am Schädel

Self-Retaining Retractors, for Skull Mounting

Separadores para la fijación del cráneo

Ecarteurs autofixant au crâne

Autofissatore per retrattori, per il supporto del cranio



LEYLA

52-0220

Selbsthaltender Hirnspatel mit 1 Spannarm, komplett, bestehend aus:

- 52-0224 1 Spannarm, flexibel
- 52-0226 1 Fixiervorrichtung für 1 Spannarm
- 52-0234 1 Spatelhalter für flache Spatel

Self-retaining brain retractor with 1 arm, complete, consisting of:

- 52-0224 1 Flexible arm
- 52-0226 1 Fixation base for 1 arm
- 52-0234 1 Support for flat brain spatulas

Separador automático para el cerebro con 1 brazo, completo, compuesto de:

- 52-0224 1 Brazo, flexible
- 52-0226 1 Fijador para 1 brazo
- 52-0234 1 Porta-espátula para espátulas planas

Ecarteur autofixant au crâne avec 1 bras

complet, composé de:

- 52-0224 1 Bras flexible
- 52-0226 1 Base de fixation pour 1 bras
- 52-0234 1 Support pour spatules plats

Autofissatore per retrattore cervicale con 1 braccio, completo, composto da:

- 52-0224 1 Braccio flessibile
- 52-0226 1 Base di fissaggio per 1 braccio
- 52-0234 1 Supporto per spatole cervicali piatte

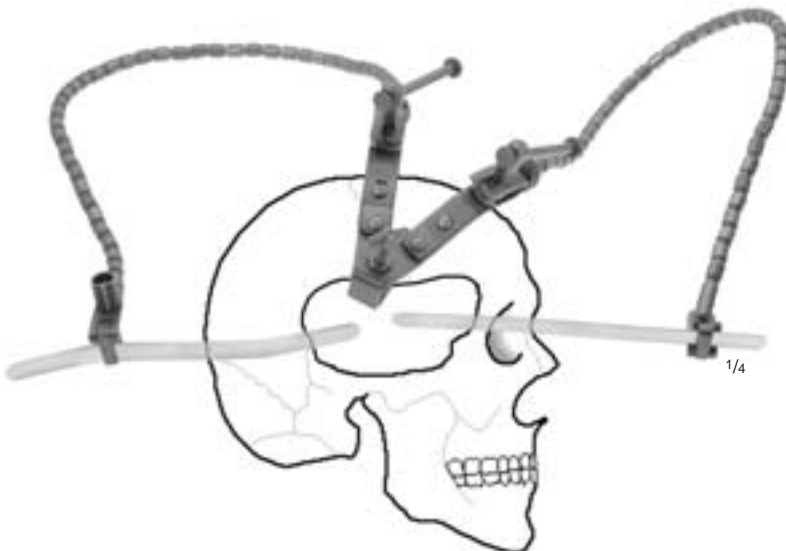

LEYLA

52-0222

Selbsthaltender Hirnspatel mit 2 Spannarmen, komplett, bestehend aus:

- 52-0224 2 Spannarme, flexibel
- 52-0228 1 Fixiervorrichtung für 2 Spannarme
- 52-0234 2 Spatelhalter für flache Spatel

Self-retaining brain retractor with 2 arms, complete, consisting of:

- 52-0224 2 Flexible arms
- 52-0228 1 Fixation base for 2 arms
- 52-0234 2 Supports for flat brain spatulas

Separador automático para cerebro con 2 brazos, completo, compuesto de:

- 52-0224 2 Brazos, flexibles
- 52-0228 1 Fijador para 2 brazos
- 52-0234 2 Porta-espátula para espátulas planas

Ecarteur autofixant au crâne avec 2 bras

complet, composé de:

- 52-0224 2 Bras flexible
- 52-0228 1 Base de fixation pour 2 bras
- 52-0234 2 Support pour spatules plats

Autofissatore per retrattore cervicale con 2 bracci, completo, composto da:

- 52-0224 2 Bracci flessibili
- 52-0228 1 Base di fissaggio per 2 bracci
- 52-0234 2 Supporti per spatole cervicali piatte

Zubehör zu LEYLA-Retraktoren

Accessories for LEYLA Self-Retaining Retractors
Accesorios para separadores automáticos de LEYLA
Accessoires pour écarteurs autofixants de LEYLA
Accessori per autofissatori di retrattori di LEYLA



1/4

LEYLA 52-0224

**Spannarm, zum Aufstecken auf Kupplungsköpfe 52-0244/
52-0246 und Fixiervorrichtungen 52-0226/52-0228/52-0230**

Flexible arm for attaching coupling heads 52-0244/52-0246
and fixation bases 52-0226/52-0228/52-0230

Brazo para colocar sobre el acoplamiento 52-0244/52-0246
y los fijadores 52-0226/52-0228/52-0230

Bras flexible pour fixation aux têtes d'accouplement 52-0244/
52-0246 et base de fixation 52-0226/52-0228/52-0230

Braccio flessibile per il fissaggio delle teste di accoppiamento
52-0244/52-0246 e le basi di fissaggio 52-0226/52-0228/52-0230



1/2

LEYLA 52-0226

**Fixiervorrichtung für 1 Spannarm 52-0224, zum Fest-
schrauben am Schädel**

Fixation base for 1 flexible arm 52-0224, for skull mounting

Fijador para 1 brazo 52-0224, para atornillar al cráneo

Base de fixation pour 1 bras 52-0224, pour fixer au crâne

Base di fissaggio per 1 braccio flessibile 52-0224, per il
supporto del cranio



1/2

LEYLA 52-0228

**Fixiervorrichtung für 2 Spannarme 52-0224, zum Fest-
schrauben am Schädel**

Fixation base for 2 flexible arms 52-0224, for skull mounting

Fijador para 2 brazos 52-0224, para atornillar al cráneo

Base de fixation pour 2 bras 52-0224, pour fixer au crâne

Base di fissaggio per 2 bracci flessibili 52-0224, per il
supporto del cranio



1/2

LEYLA 52-0230

**Fixiervorrichtung für 1 Spannarm 52-0224, zum Fest-
schrauben an Rohrteilen bis ø 16 mm**

Fixation base for 1 flexible arm 52-0224, for mounting to
bars up to 16 mm diam.

Fijador para 1 brazo 52-0224, para atornillar a tubos
hasta 16 mm

Base de fixation pour 1 bras 52-0224, pour fixer aux tubes
jusqu' à ø 16 mm

Base di fissaggio per 1 braccio flessibile 52-0224, per il
supporto di asta di raccordo da 16 mm



1/2

LEYLA 52-0232

**Spatelhalter mit Rundschaft bis ø 5,5 mm, zur Befestigung
am Spannarm 52-0224**

Support for brain spatulas with round shaft up to 5.5 mm diam.,
fixation to flexible arm 52-0224

Porta-espátula con vástago redondo hasta ø 5,5 mm, para
sujetarlo al brazo 52-0224

Support pour spatules avec tiges ronds jusqu' à ø 5,5 mm,
pour fixation au bras

Supporto per spatola craniale con diametro asse 5,5 mm, fissato
al braccio flessibile 52-0224



1/2

LEYLA 52-0234

**Spatelhalter für flache Spatel, zur Befestigung am Spannarm
52-0224**

Support for flat brain spatulas, fixation to flexible arm 52-0224

Porta-espátula para espátulas planas, para sujetarlo al brazo
52-0224

Support pour tiges plats pour fixation 52-0224

Supporto per spatola cervicale piatta, fissato al braccio flessibile
52-0224



Retraktoren zur Fixation am OP-Tisch

Self-Retaining Retractors, Fixation to Operating Table

Separadores para fijación a la mesa de operaciones

Ecarteurs pour fixation à la table d'opération

Autofissatori per retrattori, da fissare alla tavola operatoria



LEYLA

52-0236

Selbsthaltender Hirnspatel mit 1 Spannarm, komplett, bestehend aus:

- 52-0240 1 Kugelgelenkkloben
- 52-0242 1 Haltearm
- 52-0244 1 Kupplungskopf
- 52-0224 1 Spannarm
- 52-0232 1 Spatelhalterung für Spatel mit rundem Griff

Self-retaining brain retractor with 1 flexible arm, complete, consisting of:

- 52-0240 1 Ball and socket joint
- 52-0242 1 Holding rod
- 52-0244 1 Coupling head
- 52-0224 1 Flexible arm
- 52-0232 1 Support, for brain spatulas with round shaft

Separador automático para el cerebro con 1 brazo, completo, compuesto de:

- 52-0240 1 Articulación esférica
- 52-0242 1 Brazo de apoyo
- 52-0244 1 Acoplamiento
- 52-0224 1 Brazo
- 52-0232 1 Porta-espátula para espátulas con mangos redondos

Ecarteur du cerveau autofixant avec 1 bras complet, composé de:

- 52-0240 1 Articulation sphérique
- 52-0242 1 Bras de fixation
- 52-0244 1 Tête d'accouplement
- 52-0224 1 Bras flexible
- 52-0232 1 Support pour spatules avec manches ronds

Autofissatore per retrattori cervicali con 1 braccio flessibile completo, composto da:

- 52-0240 1 Giunto a sfera ad incastro
- 52-0242 1 Porta asta
- 52-0244 1 Testa accoppiamento
- 52-0224 1 Braccio flessibile
- 52-0232 1 Supporto per spatola craniale con albero rotondo



LEYLA

52-0238

Selbsthaltender Hirnspatel mit 2 Spannarmen, komplett, bestehend aus:

- 52-0240 1 Kugelgelenkkloben
- 52-0242 1 Haltearm
- 52-0246 2 Kupplungsköpfe
- 52-0224 2 Spannarme
- 52-0234 1 Spatelhalterung, für flache Spatel
- 52-0232 1 Spatelhalterung, für Spatel mit rundem Griff

Self-retaining brain retractor with 2 flexible arms, complete, consisting of:

- 52-0240 1 Ball and socket joint
- 52-0242 1 Holding rod
- 52-0246 2 Coupling heads
- 52-0224 2 Flexible arms
- 52-0234 1 Support, for flat brain spatulas
- 52-0232 1 Support, for brain spatulas with round shaft

Separador automático para el cerebro con 2 brazos, completo, compuesto de:

- 52-0240 1 Articulación esférica
- 52-0242 1 Brazo de apoyo
- 52-0246 2 Acoplamientos
- 52-0224 2 Brazos
- 52-0234 1 Porta-espátula, para espátulas planas
- 52-0232 1 Porta-espátula, para espátulas con mangos redondos

Ecarteur du cerveau autofixant avec 2 bras complet, composé de:

- 52-0240 1 Articulation sphérique
- 52-0242 1 Bras de fixation
- 52-0246 2 Têtes d'accouplement
- 52-0224 2 Bras flexibles
- 52-0234 1 Support pour spatules plats
- 52-0232 1 Support pour spatules avec manches ronds

Autofissatore per retrattori cervicali con 2 bracci flessibili completo, composto da:

- 52-0240 1 Giunto a sfera ad incastro
- 52-0242 1 Porta asta
- 52-0246 2 Teste accoppiamento
- 52-0224 2 Bracci flessibili
- 52-0234 1 Supporto per spatola craniale piatta
- 52-0232 1 Supporto per spatola craniale con albero rotondo

Zubehör zu LEYLA-Retraktoren

Accessories for LEYLA Self-Retaining Retractors
Accesorios para separadores automáticos de LEYLA
Accessoires pour écarteurs LEYLA
Accessori per autofissatori per retrattori di LEYLA



1/4

LEYLA 52-0240

Kugelgelenkkloben, zur Befestigung des Haltearms 52-0242 an OP-Tisch-Schienen

Ball and socket joint, for fixation rod 52-0242 to pole of operating table

Articulación esférica, para sujetar los brazos de apoyo 52-0242 sobre la mesa de operaciones

Articulation sphérique pour fixation du bras 52-0242 aux bandes de la table d'opération

Giunto a sfera ad incastro, per il fissaggio dell'asta 52-0242 all'estremità del tavolo operatorio

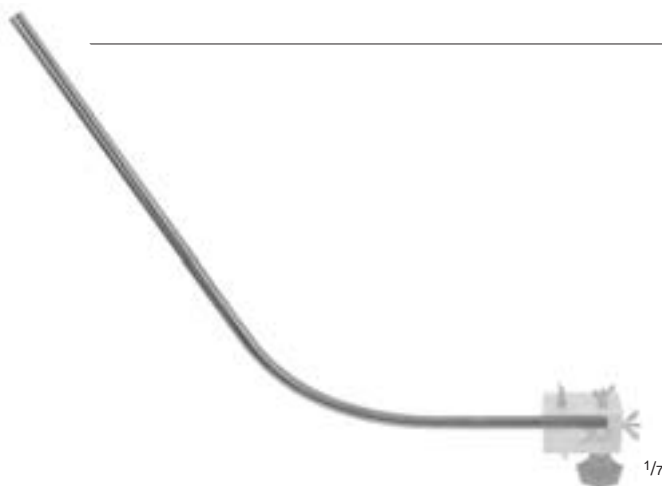

1/7

LEYLA 52-0242

Haltearm zur Fixation im Kugelgelenkkloben 52-0240 und zur Aufnahme der Kupplungsköpfe 52-0244/52-0246

Holding rod for fixation in ball and socket joint 52-0240 and to take coupling heads 52-0244/52-0246

Brazo de apoyo para fijar la articulación esférica 52-0240 y los acoplamientos 52-0244/52-0246

Bras de fixation à l'articulation sphérique 52-0240 et aux têtes d'accouplement 52-0244/52-0246

Porta asta per il fissaggio al giunto a sfera 52-0240 e alle teste di accoppiamento 52-0244/52-0246



1/4

LEYLA 52-0244

Kupplungskopf zur Aufnahme von 1-5 Spannarmen 52-0224

Coupling head to take 1-5 flexible arms 52-0224

Acoplamiento para sujetar 1-5 brazos 52-0224

Tête d'accouplement pour 1-5 bras flexibles 52-0224

Testa accoppiamento per 1-5 bracci flessibili 52-0224



1/4

LEYLA 52-0246

Kupplungskopf, drehbar, in allen Ebenen fixierbar, zur Aufnahme von 1 Spannarm 52-0224

Coupling head, turnable, can be fixed in any position, to take 1 flexible arm 52-0224

Acoplamiento, girable y se puede fijar en todas las posturas para sujetar un brazo 52-0224

Tête d'accouplement, rotative, peut être fixée en toute position, pour tenir 1 bras flexible

Testa accoppiamento, può essere fissato in qualsiasi posizione, supporta 1 braccio flessibile 52-0224



Hirnspatel
Brain Spatulas
Espátulas cerebrales
Spatules cérébrales
Spatole cerebrali



DAVIS
52-0290 13 mm x 190 mm
▶ 52-0291 16 mm x 190 mm
biegsam
malleable
maleables
malléables
malleabili



CUSHING
52-0298
10 + 12 mm x 195 mm



HEIFETZ
52-0261 8 mm x 155 mm
52-0262 11 mm x 155 mm
52-0263 14 mm x 155 mm
▶ 52-0264 17 mm x 155 mm
biegsam
malleable
maleables
malléables
malleabili

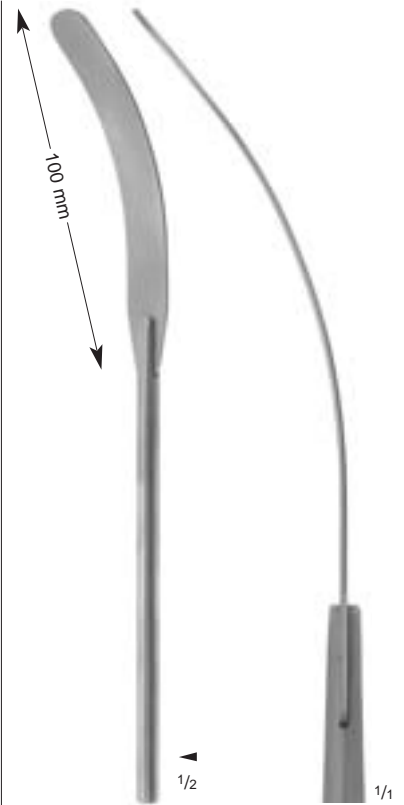

HEIFETZ
52-0265 14 mm x 200 mm
▶ 52-0266 17 mm x 200 mm
52-0267 20 mm x 200 mm
biegsam
malleable
maleables
malléables
malleabili

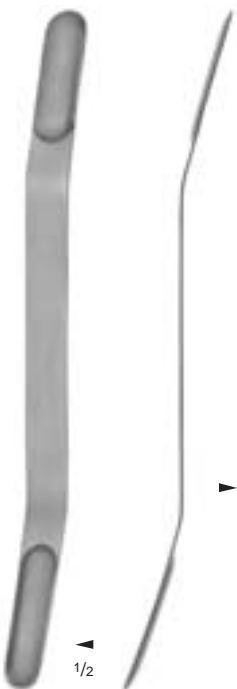

OLIVECRONA
52-0300 7 + 9 mm x 180 mm
▶ 52-0301 11 + 13 mm x 180 mm
52-0302 15 + 18 mm x 180 mm
52-0303 19 + 21 mm x 180 mm
konvex
convex
cónvexas
convexes
convesso

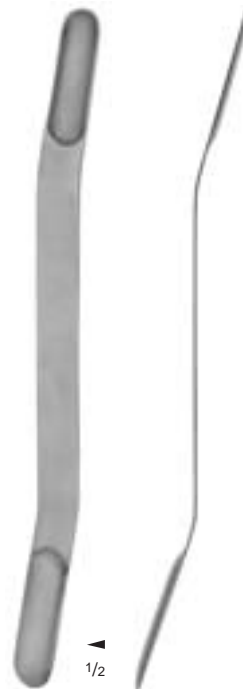

OLIVECRONA
52-0304 7 + 9 mm x 180 mm
▶ 52-0305 11 + 13 mm x 180 mm
52-0306 15 + 18 mm x 180 mm
52-0307 19 + 21 mm x 180 mm
konkav
concave
cóncavas
concaves
concavo

Laminektomie-Stanzen

Laminectomy Punches

Pinzas cortantes para laminectomía

Pinces emporte-pièce à laminectomie

Pinze per laminectomia

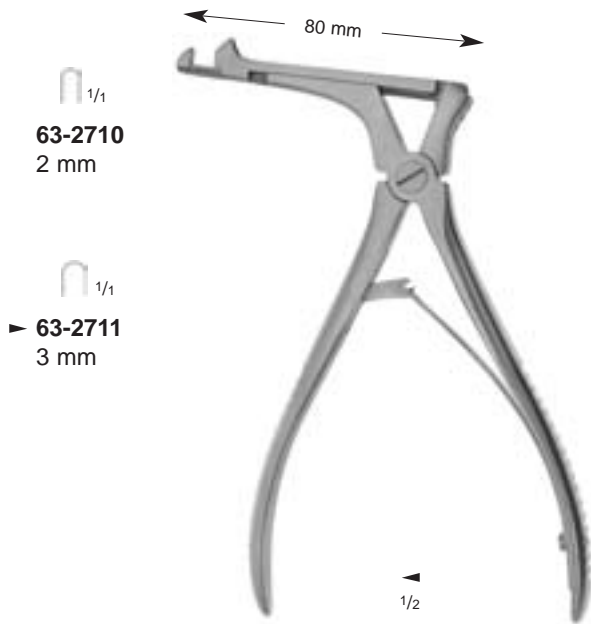

$\frac{1}{1}$

63-2710
2 mm

$\frac{1}{1}$

► **63-2711**
3 mm

$\frac{1}{2}$

CITELLI
63-2710
- **63-2711**

nach oben schneidend 90°
upwards cutting 90°
cortante hacia arriba 90°
coupant vers le haut 90°
taglio a 90° verso l'alto

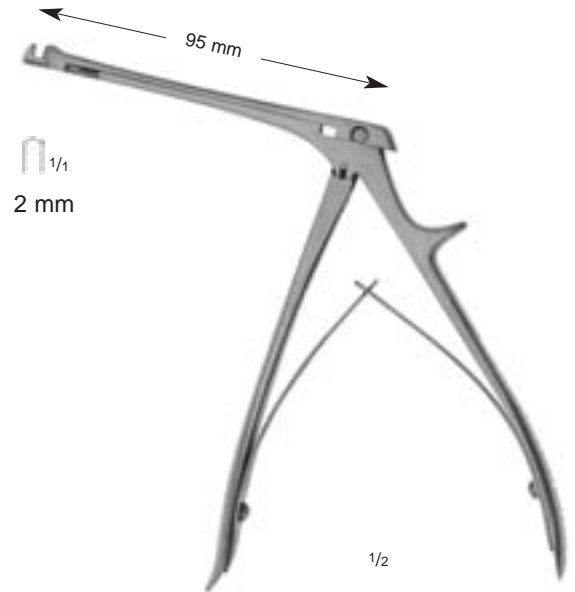

$\frac{1}{1}$

2 mm

$\frac{1}{2}$

BEYER
63-2720

nach oben schneidend 90°
upwards cutting 90°
cortante hacia arriba 90°
coupant vers le haut 90°
taglio a 90° verso l'alto

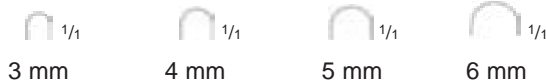

3 mm

4 mm

5 mm

6 mm

	Bissbreite Width of bite Anchura de la boca Largeur des mors Larghezza del morso	Schaftlänge Length of shaft Longitud del vástago Longueur de la tige Lunghezza dell'asta
45-0790	3 mm	90 mm
► 45-0791	4 mm	90 mm
45-0792	5 mm	90 mm
45-0793	6 mm	90 mm



90 mm

$\frac{1}{2}$

KERRISON
45-0790
- **45-0793**

nach oben schneidend 90°
upwards cutting 90°
cortante hacia arriba 90°
coupant vers le haut 90°
taglio a 90° verso l'alto



Laminektomie-Stanzen

Laminectomy Punches

Pinzas cortantes para laminectomía

Pinces emporte-pièce à laminectomie

Pinze per laminectomia

140 mm

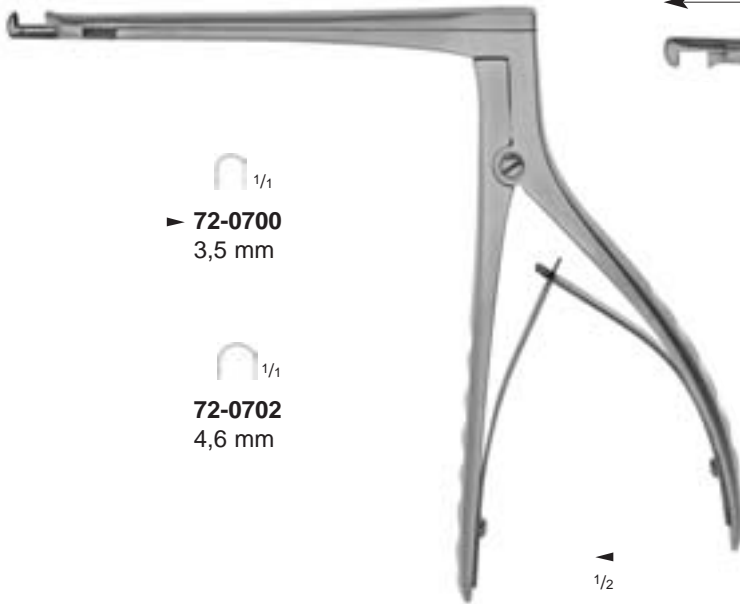

 ^{1/1}
▶ **72-0700**
3,5 mm

 ^{1/1}
72-0702
4,6 mm

1/2

HAJEK-KOFLER
72-0700
- **72-0702**

nach oben schneidend 90°
upwards cutting 90°
cortante hacia arriba 90°
coupant vers le haut 90°
taglio a 90° verso l'alto

140 mm

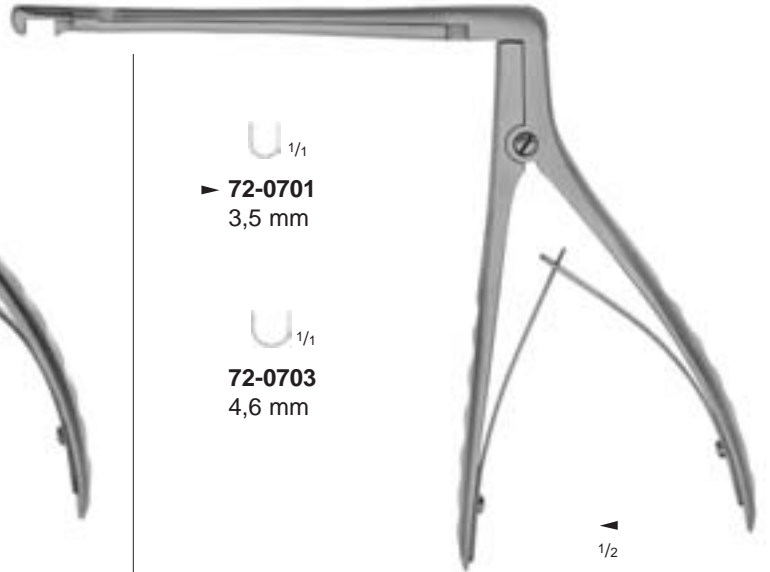

 ^{1/1}
▶ **72-0701**
3,5 mm

 ^{1/1}
72-0703
4,6 mm

1/2

HAJEK-KOFLER
72-0701
- **72-0703**

nach unten schneidend 90°
downwards cutting 90°
cortante hacia abajo 90°
coupant vers le bas 90°
taglio a 90° verso il basso

170 mm

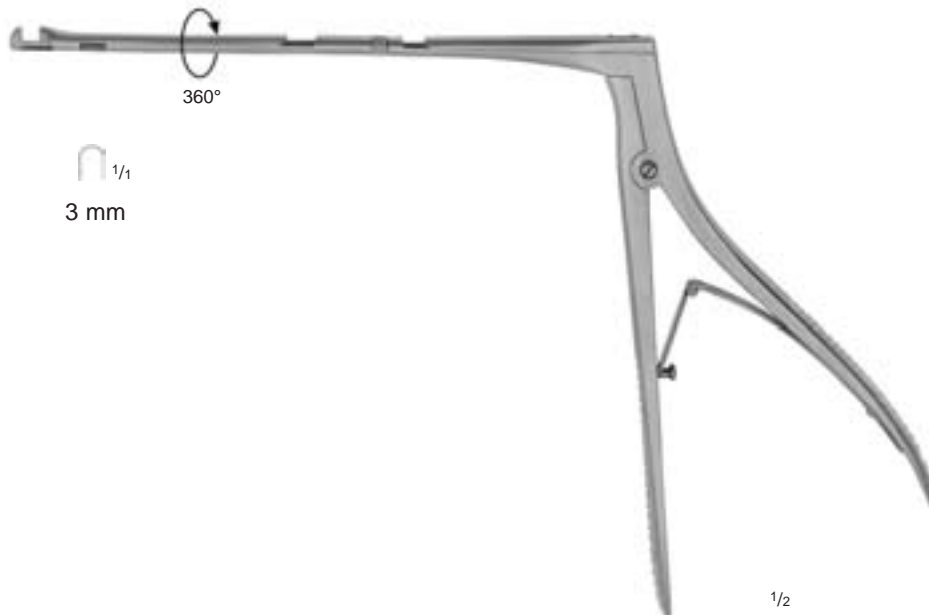

360°

 ^{1/1}
3 mm

1/2

HAJEK-KOFLER
72-0710
3 mm

90° schneidend, Schaft 360° drehbar
90° cutting, shaft rotates 360°
corte 90°, vástago girable 360°
coupant à 90°, tige tournant 360°
taglio a 90°, albero rotante di 360°

Laminektomie-Stanzen

Laminectomy Punches

Pinzas cortantes para laminectomía

Pinces emporte-pièce à laminectomie

Pinze per laminectomia

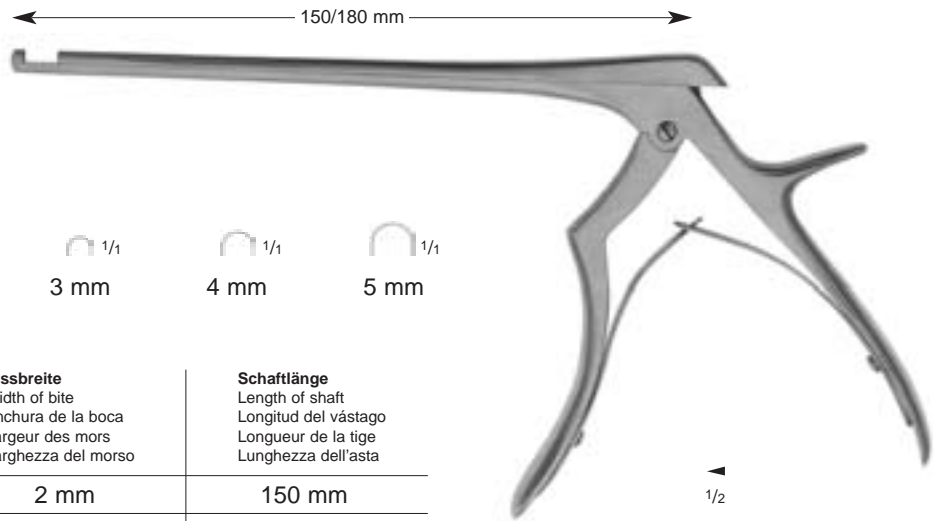

	Bissbreite Width of bite Anchura de la boca Largeur des mors Larghezza del morso	Schaftlänge Length of shaft Longitud del vástago Longueur de la tige Lunghezza dell'asta
45-1100	2 mm	150 mm
45-1101	3 mm	150 mm
45-1102	4 mm	150 mm
45-1103	5 mm	150 mm
45-1130	2 mm	180 mm
▶ 45-1131	3 mm	180 mm
45-1132	4 mm	180 mm
45-1133	5 mm	180 mm

FERRIS-SMITH-KERRISON
45-1100
- 45-1133

nach oben schneidend 90°
upwards cutting 90°
cortante hacia arriba 90°
coupant vers le haut 90°
taglio a 90° verso l'alto

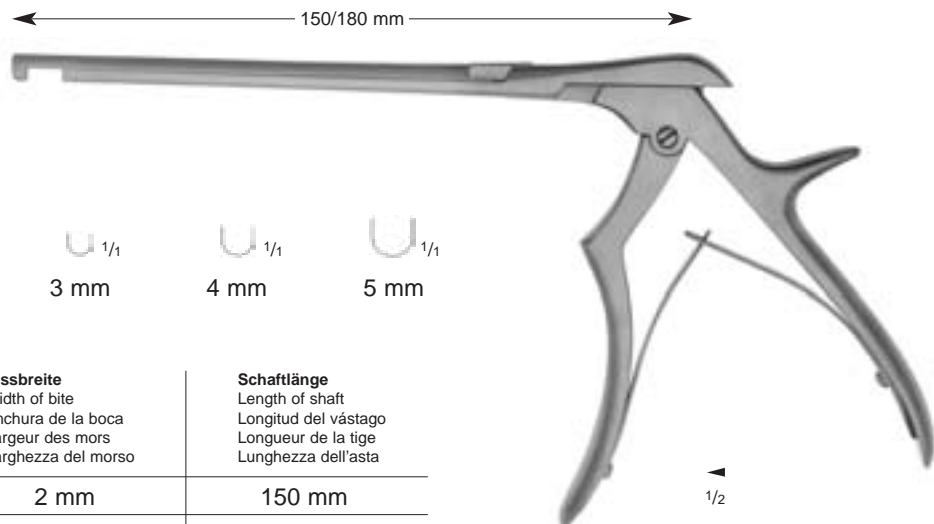

	Bissbreite Width of bite Anchura de la boca Largeur des mors Larghezza del morso	Schaftlänge Length of shaft Longitud del vástago Longueur de la tige Lunghezza dell'asta
45-1105	2 mm	150 mm
45-1106	3 mm	150 mm
45-1107	4 mm	150 mm
45-1108	5 mm	150 mm
45-1135	2 mm	180 mm
▶ 45-1136	3 mm	180 mm
45-1137	4 mm	180 mm
45-1138	5 mm	180 mm

FERRIS-SMITH-KERRISON
45-1105
- 45-1138

nach unten schneidend 90°
downwards cutting 90°
cortante hacia abajo 90°
coupant vers le bas 90°
taglio a 90° verso il basso



Laminektomie-Stanzen

Laminectomy Punches

Pinzas cortantes para laminectomía

Pinces emporte-pièce à laminectomie

Pinze per laminectomia

← 150/180/200 mm →

 1/1
 2 mm
  1/1
 3 mm
  1/1
 4 mm
  1/1
 5 mm

	Bissbreite Width of bite Anchura de la boca Largeur des mors Larghezza del morso	Schaftlänge Length of shaft Longitud del vástago Longueur de la tige Lunghezza dell'asta
45-1110	2 mm	150 mm
45-1111	3 mm	150 mm
45-1112	4 mm	150 mm
45-1113	5 mm	150 mm
45-1140	2 mm	180 mm
▶ 45-1141	3 mm	180 mm
45-1142	4 mm	180 mm
45-1143	5 mm	180 mm
45-1170	2 mm	200 mm
45-1171	3 mm	200 mm
45-1172	4 mm	200 mm
45-1173	5 mm	200 mm

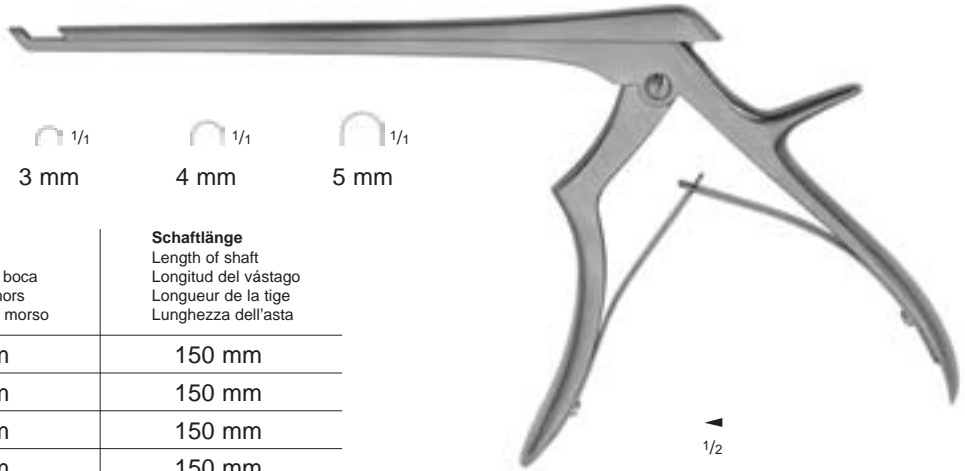



FERRIS-SMITH-KERRISON

45-1110

- **45-1173**

nach oben schneidend 130°
upwards cutting 130°
cortante hacia arriba 130°
coupant vers le haut 130°
taglio a 130° verso l'alto

← 150/200 mm →

 1/1
 3 mm
  1/1
 5 mm

	Bissbreite Width of bite Anchura de la boca Largeur des mors Larghezza del morso	Schaftlänge Length of shaft Longitud del vástago Longueur de la tige Lunghezza dell'asta
45-0743	3 mm	150 mm
45-0745	5 mm	150 mm
▶ 45-1743	3 mm	200 mm
45-1745	5 mm	200 mm

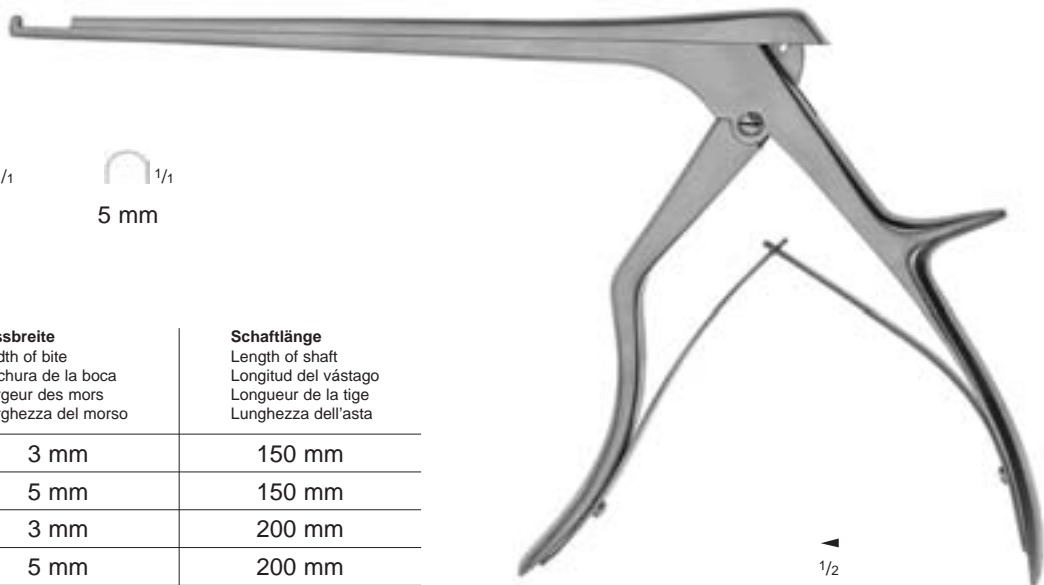

LOVE-KERRISON (COLCLOUGH)

45-0743

- **45-1745**

nach oben schneidend 90°
upwards cutting 90°
cortante hacia arriba 90°
coupant vers le haut 90°
taglio a 90° verso l'alto

Laminektomie-Stanzen

Laminectomy Punches

Pinzas cortantes para laminectomía

Pinces emporte-pièce à laminectomie

Pinze per laminectomia



← 150/200 mm →

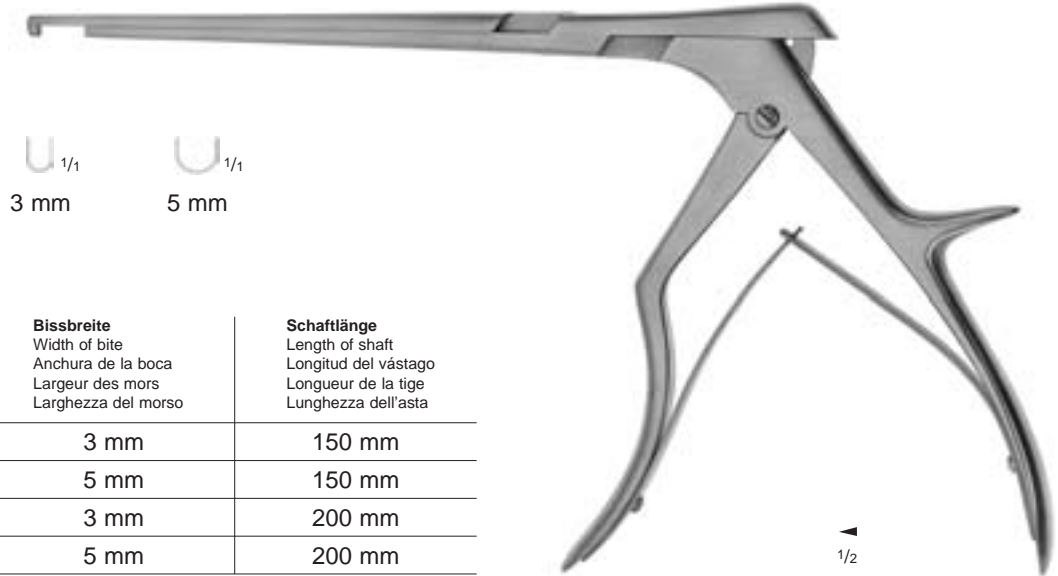

U^{1/1} 3 mm U^{1/1} 5 mm

	Bissbreite Width of bite Anchura de la boca Largeur des mors Larghezza del morso	Schaftlänge Length of shaft Longitud del vástago Longueur de la tige Lunghezza dell'asta
45-0753	3 mm	150 mm
45-0755	5 mm	150 mm
▶ 45-1753	3 mm	200 mm
45-1755	5 mm	200 mm

LOVE-KERRISON (COLCLOUGH)

45-0753

- **45-1755**

nach unten schneidend 90°
downwards cutting 90°
cortante hacia abajo 90°
coupant vers le bas 90°
taglio a 90° verso il basso

← 150/200 mm →

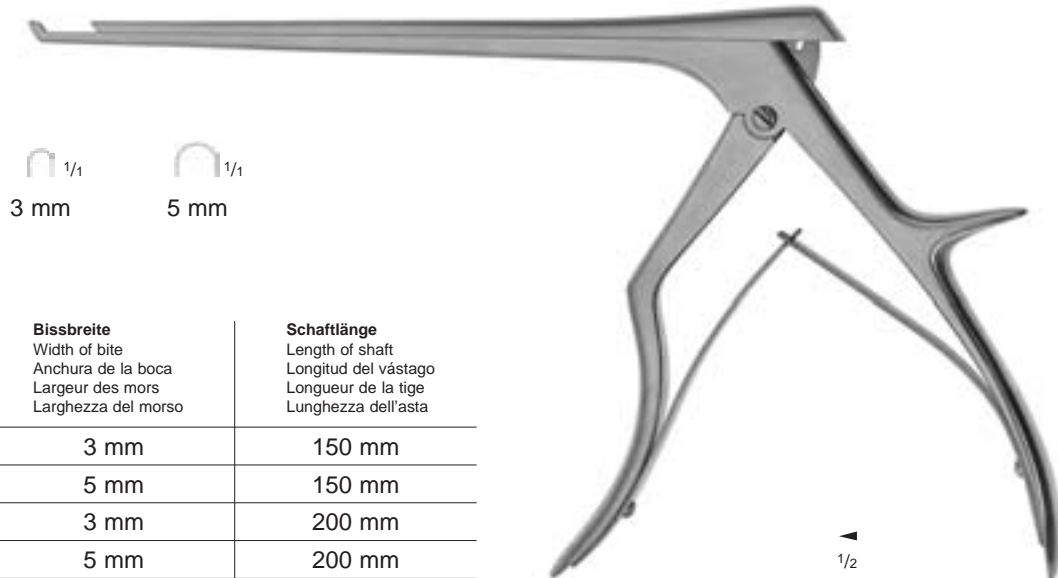

U^{1/1} 3 mm U^{1/1} 5 mm

	Bissbreite Width of bite Anchura de la boca Largeur des mors Larghezza del morso	Schaftlänge Length of shaft Longitud del vástago Longueur de la tige Lunghezza dell'asta
45-0763	3 mm	150 mm
45-0765	5 mm	150 mm
▶ 45-1763	3 mm	200 mm
45-1765	5 mm	200 mm

LOVE-KERRISON (COLCLOUGH)

45-0763

- **45-1765**

nach oben schneidend 130°
upwards cutting 130°
cortante hacia arriba 130°
coupant vers le haut 130°
taglio a 130° verso l'alto



Laminektomie-Stanzen

Laminectomy Punches

Pinzas cortantes para laminectomía

Pinces emporte-pièce à laminectomie

Pinze per laminectomia

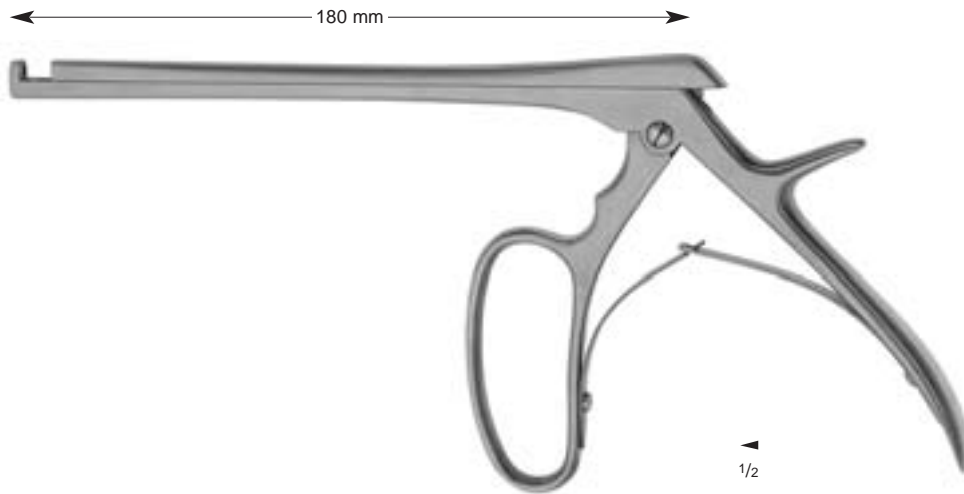

 1/1
45-0806
3 mm

 1/1
▶ **45-0807**
5 mm

FERRIS-SMITH-KERRISON
45-0806
- **45-0807**

nach oben schneidend 90°
upwards cutting 90°
cortante hacia arriba 90°
coupant vers le haut 90°
taglio a 90° verso l'alto



 1/1
45-0814
3 mm

 1/1
45-0817
5 mm

FERRIS-SMITH-KERRISON
45-0814
- **45-0817**

nach unten schneidend 90°
downwards cutting 90°
cortante hacia abajo 90°
coupant vers le bas 90°
taglio a 90° verso il basso



 1/1
45-0812
3 mm

 1/1
45-0815
5 mm

FERRIS-SMITH-KERRISON
45-0812
- **45-0815**

nach oben schneidend 130°
upwards cutting 130°
cortante hacia arriba 130°
coupant vers le haut 130°
taglio a 130° verso l'alto

Laminektomie-Zangen

Laminectomy Rongeurs

Pinzas cortantes para laminectomía

Pinces emporte-pièces à laminectomie

Pinze per laminectomia

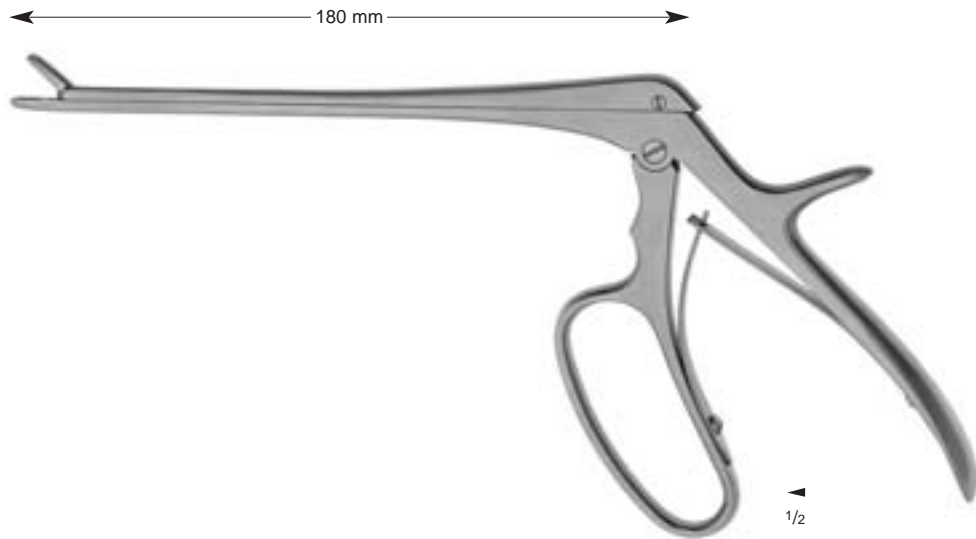

FERRIS-SMITH-CUSHING

45-0852

- **45-0854**

gerade
straight
recta
droits
retta



45-0852
2 x 10 mm



▶ **45-0853**
3 x 10 mm



45-0854
4 x 10 mm



FERRIS-SMITH-CUSHING

45-0862

- **45-0864**

aufgebogen
curved on flat
curva hacia arriba
courbure vers le haut
curva verso l'alto



45-0862
2 x 10 mm



45-0863
3 x 10 mm



45-0864
4 x 10 mm



FERRIS-SMITH-CUSHING

45-0872

- **45-0874**

abwärts gebogen
curved down
curva hacia abajo
courbure vers le bas
curva verso il basso



45-0872
2 x 10 mm



▶ **45-0873**
3 x 10 mm



45-0874
4 x 10 mm



Laminektomie-Zangen

Laminectomy Rongeurs

Pinzas cortantes para laminectomía

Pinces emporte-pièces à laminectomie

Pinze per laminectomia

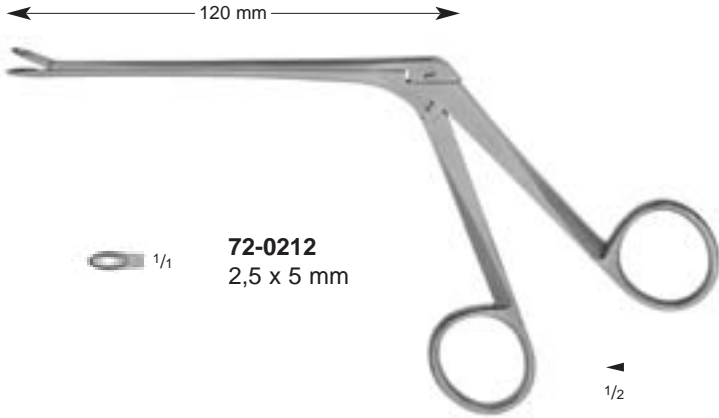

72-0212
2,5 x 5 mm



▶ **72-0222**
3,6 x 8 mm



72-0242
4,8 x 12 mm

WEIL-BLAKESLEY
72-0212
- **72-0242**

gerade
straight
recta
droits
retta

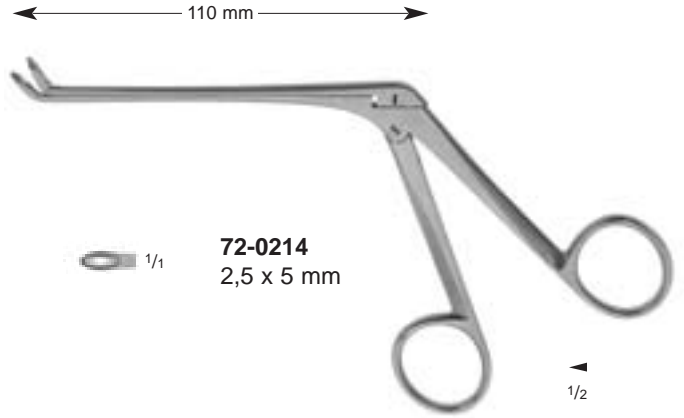

72-0214
2,5 x 5 mm



▶ **72-0224**
3,6 x 8 mm



72-0244
4,8 x 12 mm

WEIL-BLAKESLEY
72-0214
- **72-0244**

aufgebogen
curved on flat
curva hacia arriba
courbure vers le haut
curva verso l'alto

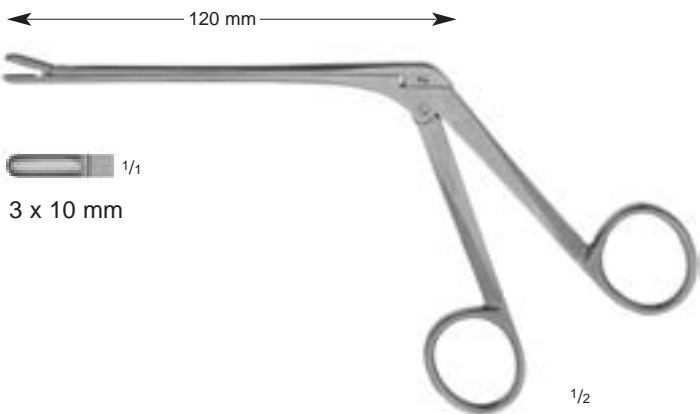

3 x 10 mm

TAKAHASHI
72-0202
3 x 10 mm

gerade
straight
recta
droits
retta

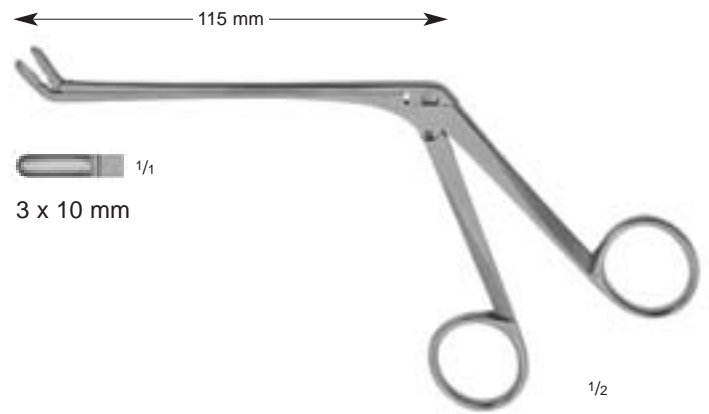

3 x 10 mm

TAKAHASHI
72-0204
3 x 10 mm

aufgebogen
curved on flat
curva hacia arriba
courbure vers le haut
curva verso l'alto

Laminektomie-Zangen

Laminectomy Rongeurs

Pinzas cortantes para laminectomía

Pinces emporte-pièces à laminectomie

Pinze per laminectomia



CUSHING
53-0370
- 53-0378



1/1
2 x 10 mm

	Maulgröße Size of jaw Anchura de la boca Largeur des mors Larghezza del morso	Schaftlänge Length of shaft Longitud del vástago Longueur de la tige Lunghezza dell'asta
53-0370	2 x 10 mm	130 mm
53-0373	2 x 10 mm	150 mm
▶ 53-0375	2 x 10 mm	180 mm

gerade
straight
recta
droits
retta



1/1
2 x 10 mm

	Maulgröße Size of jaw Anchura de la boca Largeur des mors Larghezza del morso	Schaftlänge Length of shaft Longitud del vástago Longueur de la tige Lunghezza dell'asta
53-0371	2 x 10 mm	130 mm
53-0374	2 x 10 mm	150 mm
53-0376	2 x 10 mm	180 mm

aufgebogen
curved on flat
curva hacia arriba
courbure vers le haut
curva verso l'alto



1/1
2 x 10 mm

	Maulgröße Size of jaw Anchura de la boca Largeur des mors Larghezza del morso	Schaftlänge Length of shaft Longitud del vástago Longueur de la tige Lunghezza dell'asta
53-0372	2 x 10 mm	130 mm
53-0378	2 x 10 mm	150 mm
53-0377	2 x 10 mm	180 mm

abwärts gebogen
curved down
curva hacia abajo
courbure vers le bas
curva verso il basso



Laminektomie-Zangen

Laminectomy Rongeurs

Pinzas cortantes para laminectomía

Pinces emporte-pièces à laminectomie

Pinze per laminectomia

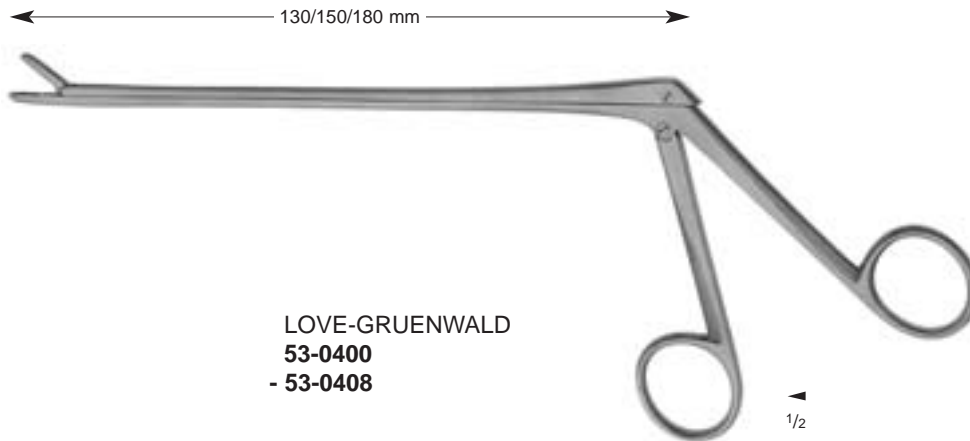

LOVE-GRUENWALD
53-0400
- 53-0408



1/1
3 x 10 mm

	Maulgröße Size of jaw Anchura de la boca Largeur des mors Larghezza del morso	Schaftlänge Length of shaft Longitud del vástago Longueur de la tige Lunghezza dell'asta
53-0400	3 x 10 mm	130 mm
53-0403	3 x 10 mm	150 mm
▶ 53-0405	3 x 10 mm	180 mm

gerade
straight
recta
droits
retta



1/1
3 x 10 mm

	Maulgröße Size of jaw Anchura de la boca Largeur des mors Larghezza del morso	Schaftlänge Length of shaft Longitud del vástago Longueur de la tige Lunghezza dell'asta
53-0401	3 x 10 mm	130 mm
53-0404	3 x 10 mm	150 mm
53-0406	3 x 10 mm	180 mm

aufgebogen
curved on flat
curva hacia arriba
courbure vers le haut
curva verso l'alto



1/1
3 x 10 mm

	Maulgröße Size of jaw Anchura de la boca Largeur des mors Larghezza del morso	Schaftlänge Length of shaft Longitud del vástago Longueur de la tige Lunghezza dell'asta
53-0402	3 x 10 mm	130 mm
53-0408	3 x 10 mm	150 mm
53-0407	3 x 10 mm	180 mm

abwärts gebogen
curved down
curva hacia abajo
courbure vers le bas
curva verso il basso

Laminektomie-Zangen

Laminectomy Rongeurs

Pinzas cortantes para laminectomía

Pinces emporte-pièces à laminectomie

Pinze per laminectomia

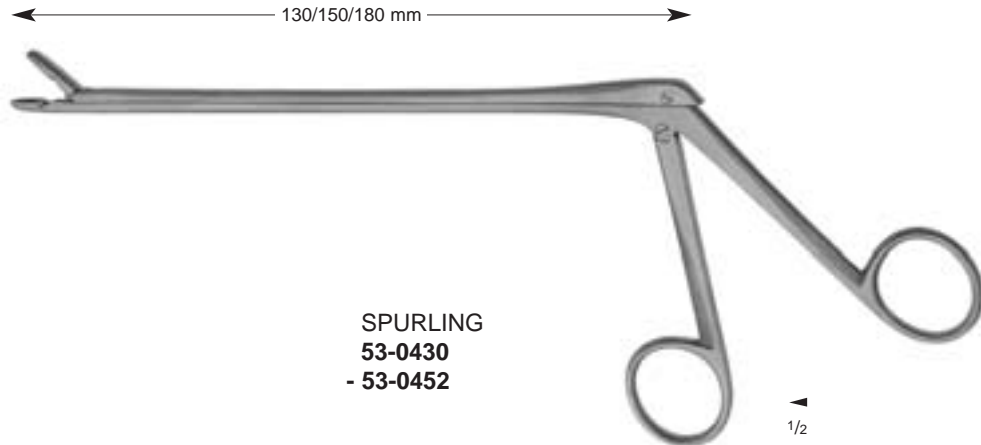

SPURLING
53-0430
- 53-0452



4 x 10 mm

	Maulgröße Size of jaw Anchura de la boca Largeur des mors Larghezza del morso	Schaftlänge Length of shaft Longitud del vástago Longueur de la tige Lunghezza dell'asta
53-0430	4 x 10 mm	130 mm
53-0450	4 x 10 mm	150 mm
▶ 53-0435	4 x 10 mm	180 mm

gerade
straight
recta
droits
retta



4 x 10 mm

	Maulgröße Size of jaw Anchura de la boca Largeur des mors Larghezza del morso	Schaftlänge Length of shaft Longitud del vástago Longueur de la tige Lunghezza dell'asta
53-0431	4 x 10 mm	130 mm
53-0451	4 x 10 mm	150 mm
53-0436	4 x 10 mm	180 mm

aufgebogen
curved on flat
curva hacia arriba
courbure vers le haut
curva verso l'alto



4 x 10 mm

	Maulgröße Size of jaw Anchura de la boca Largeur des mors Larghezza del morso	Schaftlänge Length of shaft Longitud del vástago Longueur de la tige Lunghezza dell'asta
53-0432	4 x 10 mm	130 mm
53-0452	4 x 10 mm	150 mm
53-0437	4 x 10 mm	180 mm

abwärts gebogen
curved down
curva hacia abajo
courbure vers le bas
curva verso il basso



Laminektomie-Zangen

Laminectomy Rongeurs

Pinzas cortantes para laminectomía

Pinces emporte-pièces à laminectomie

Pinze per laminectomia

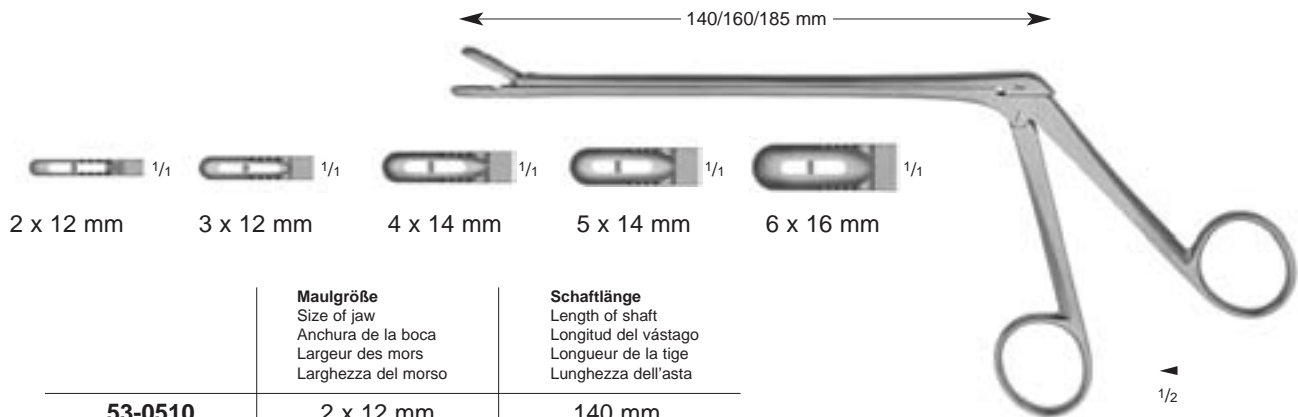

	Maulgröße Size of jaw Anchura de la boca Largeur des mors Larghezza del morso	Schaftlänge Length of shaft Longitud del vástago Longueur de la tige Lunghezza dell'asta
53-0510	2 x 12 mm	140 mm
53-0512	3 x 12 mm	140 mm
53-0514	4 x 14 mm	140 mm
53-0516	5 x 14 mm	140 mm
53-0518	6 x 16 mm	140 mm
53-0520	2 x 12 mm	160 mm
53-0522	3 x 12 mm	160 mm
▶ 53-0524	4 x 14 mm	160 mm
53-0526	5 x 14 mm	160 mm
53-0528	6 x 16 mm	160 mm
53-0530	2 x 12 mm	185 mm
53-0532	3 x 12 mm	185 mm
53-0534	4 x 14 mm	185 mm
53-0536	5 x 14 mm	185 mm
53-0538	6 x 16 mm	185 mm

CASPAR
53-0510
- 53-0538

gerade
straight
recta
droits
retta

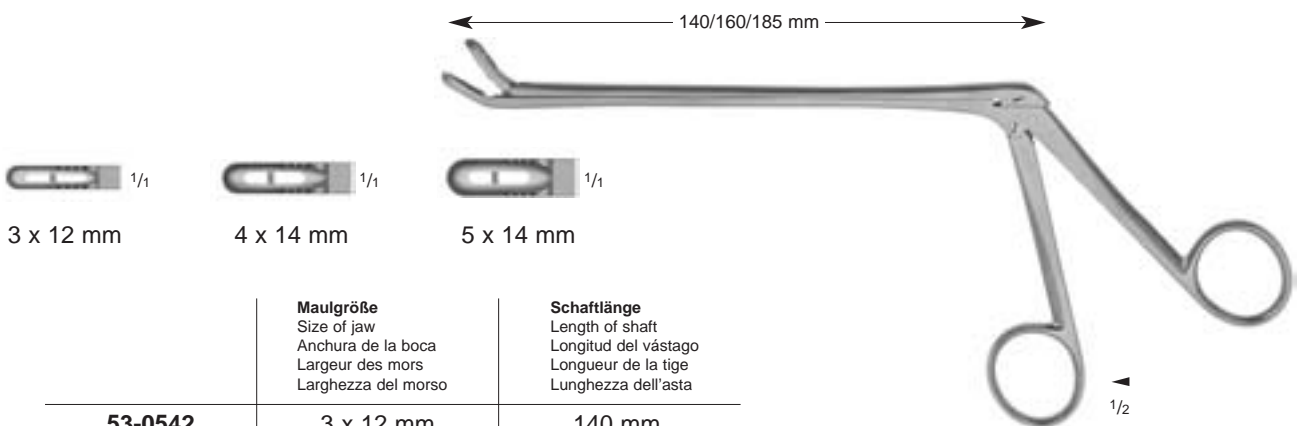

	Maulgröße Size of jaw Anchura de la boca Largeur des mors Larghezza del morso	Schaftlänge Length of shaft Longitud del vástago Longueur de la tige Lunghezza dell'asta
53-0542	3 x 12 mm	140 mm
53-0544	4 x 14 mm	140 mm
53-0546	5 x 14 mm	140 mm
53-0552	3 x 12 mm	160 mm
▶ 53-0554	4 x 14 mm	160 mm
53-0556	5 x 14 mm	160 mm
53-0562	3 x 12 mm	185 mm
53-0564	4 x 14 mm	185 mm
53-0566	5 x 14 mm	185 mm

CASPAR
53-0542
- 53-0566

aufgebogen
curved on flat
curva hacia arriba
courbure vers le haut
curva verso l'alto

Laminektomie-Zangen

Laminectomy Rongeurs

Pinzas cortantes para laminectomía

Pinces emporte-pièces à laminectomie

Pinze per laminectomia



140/160/185 mm



3 x 12 mm



4 x 14 mm

	Maulgröße Size of jaw Anchura de la boca Largeur des mors Larghezza del morso	Schaftlänge Length of shaft Longitud del vástago Longueur de la tige Lunghezza dell'asta
53-0572	3 x 12 mm	140 mm
53-0574	4 x 14 mm	140 mm
53-0582	3 x 12 mm	160 mm
▶ 53-0584	4 x 14 mm	160 mm
53-0592	3 x 12 mm	185 mm
53-0594	4 x 14 mm	185 mm



CASPAR
53-0572
- 53-0594

abwärts gebogen
curved down
curva hacia abajo
courbure vers le bas
curva verso il basso

180 mm

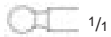

YASARGIL
57-1250
3,5 mm

Hypophysenzange
Pituitary rongeur
Pinza para hipófisis
Pince pour l'hypophyse
Pinza ipofisaria

180 mm



OLDBERG
53-0300
6 mm

Hypophysenzange
Pituitary rongeur
Pinza para hipófisis
Pince pour l'hypophyse
Pinza ipofisaria



CRAIG-KOGLER Wirbelkörper-Biopsieinstrumentarium

CRAIG-KOGLER Vertebral Biopsy Instruments

CRAIG-KOGLER Juego para la biopsia vertebral

CRAIG-KOGLER Set pour la biopsie vertébrale

CRAIG-KOGLER Strumenti per biopsia vertebrale

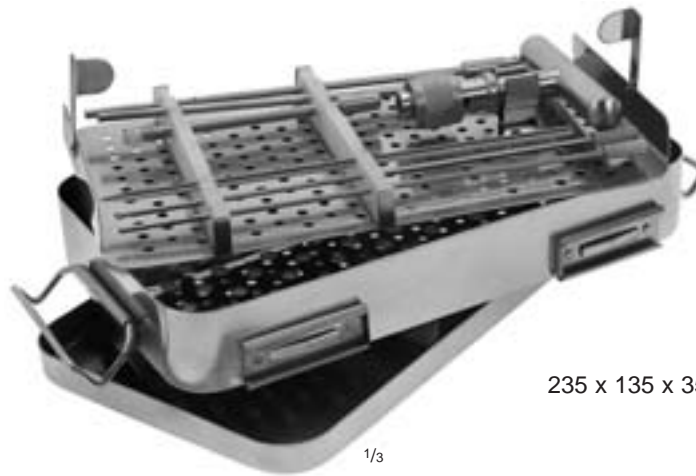

235 x 135 x 35 mm

1/3

CRAIG-KOGLER

45-0950

Wirbelkörper-Biopsieinstrumentarium, komplett, bestehend aus:

- 07-0703 1 Sterilisierbehälter aus 18/8 Chromnickelstahl, mit Halterungen für Kennzeichnungsschilder und mit Textil-Langzeitfilter im Boden, Deckel mit Silikon-Andrückleiste zum Fixieren der Instrumente
- 57-1286 1 Sterilisierrahmen mit Silikonbank - die einzelnen Aussparungen sind der Stärke des jeweiligen Instrumentes angepaßt - und mit Halterung für Griff
- 45-0951 1 Trokarhülse mit Zentimeter-Einteilung, ø 5 mm x 100 mm
- 45-0953 1 halbstumpfer Trokar, ø 4 mm x 190 mm
- 45-0955 1 Punktionsstrephe für Knochen, mit gezahnter Schneide, ø 4 mm x 190 mm
- 45-0956 1 Punktionsstrephe für Weichteile, mit glatter Schneide, ø 4 mm x 190 mm
- 45-0957 1 Handgriff mit Kugelschnellverschluss zum Einführen und zur Extraktion von Punktionsstrephe
- 45-0958 1 Doppelkralle zur Extraktionshilfe von Weichteilen, ø 2,5 mm x 210 mm
- 45-0959 1 stumpfer Mandrin zum Ausstoßen von Gewebeproben, ø 2,5 mm x 210 mm

Set of vertebral biopsy instruments, complete, consisting of:

- 07-0703 1 Sterilizing case of 18/8 nickel chromium steel, with mounts for labels and long-life fabric filter in the base, silicone strips in lid for fixation of instruments
- 57-1286 1 Sterilizing tray with silicone bed (the recesses are of the same width as the individual instruments) and bracket for a handle
- 45-0951 1 Trocar cannula with centimetre scale diam. 5 mm x 100 mm
- 45-0953 1 Semi-blunt trocar diam. 4 mm x 190 mm
- 45-0955 1 Trephine for bone, with serrated cutting edge diam. 4 mm x 190 mm
- 45-0956 1 Trephine for soft tissue, with smooth cutting edge diam. 4 mm x 190 mm
- 45-0957 1 Handle with spherical quick-release mechanism for inserting and withdrawing the trephines
- 45-0958 1 Double-ended retractor for extracting soft tissue diam. 2.5 mm x 210 mm
- 45-0959 1 Blunt obturator for ejecting tissue samples diam. 2.5 mm x 210 mm

Juego para la biopsia vertebral, completo, compuesto de:

- 07-0703 1 Caja de esterilización de acero 18/8, con porta-placas de identificación y con filtro de tejido de larga duración al fondo, tapa con tira de silicona para fijar los instrumentos
- 57-1286 1 Dispositivo de esterilización con armadura de silicona para sujetar los instrumentos, sujetador con mango
- 45-0951 1 Cánula de trocar con escala graduada en centímetros, ø 5 mm x 100 mm
- 45-0953 1 Trocar semi-romo, ø 4 mm x 190 mm
- 45-0955 1 Trépano de punción para huesos, con filo dentado, ø 4 mm x 190 mm
- 45-0956 1 Trépano de punción para tejido blando, con filo liso, ø 4 mm x 190 mm
- 45-0957 1 Mango con cierre esférico rápido para introducir y extraer los trépanos de punción
- 45-0958 1 Doble-garra para extraer tejido blando, ø 2,5 mm x 210 mm
- 45-0959 1 Obturador para sacar pruebas de tejido, ø 2,5 mm x 210 mm

Set pour la biopsie vertébrale, complet, composé de:

- 07-0703 1 Boîte de stérilisation d'acier chrome 18/8, avec supports pour des plaques d'identification et avec des filtres de longue durée au fond, couvercle avec des bandes en silicone pour fixer les instruments
- 57-1286 1 Cadre de stérilisation avec bandes en silicone - avec mesures ajustées aux dimensions des instruments, et avec support pour le manche
- 45-0951 1 Canule de trocar graduée en cm, ø 5 mm x 100 mm
- 45-0953 1 Trocart semi-mou, ø 4 mm x 190 mm
- 45-0955 1 Tréphine de ponction pour os, avec tranchant dentelé, ø 4 mm x 190 mm
- 45-0956 1 Tréphine de ponction pour tissu mou, avec tranchant lisse, ø 4 mm x 190 mm
- 45-0957 1 Manche avec mécanisme à billes pour introduire et enlever les tréphines de ponction
- 45-0958 1 Double griffe pour extraction des tissus moux, ø 2,5 mm x 210 mm
- 45-0959 1 Obturateur mou pour pousser les échantillons de tissu, ø 2,5 mm x 210 mm

Set per biopsia vertebrale, completo, composto da:

- 07-0703 1 Cassetta sterilizzabile in acciaio inox 18/8, con porta placche di riconoscimento, filtro a lunga durata sulla base, strisce di silicone per il fissaggio degli strumenti
- 57-1286 1 Dispositivo di sterilizzazione in silicone per contenere gli strumenti e supporto per il manico
- 45-0951 1 Cannula per trocar con scala centimetrata ø mm. 5 x 100
- 45-0953 1 Trocar semi smusso ø mm. 4 x 190
- 45-0955 1 Trapano per osso, con taglio dentato ø mm. 4 x 190
- 45-0956 1 Trapano per tessuti molli, con taglio piatto ø mm. 4 x 190
- 45-0957 1 Manico con meccanismo sferico di pronto rilascio per inserire ed estrarre, trapani
- 45-0958 1 Retrattore doppio per estrarre il tessuto molle ø mm. 2,5 x 210
- 45-0959 1 Otturatore smusso per espellere il tessuto campione ø mm. 2,5 x 210

CRAIG-KOGLER Wirbelkörper-Biopsieinstrumentarium

CRAIG-KOGLER Vertebral Biopsy Instruments
CRAIG-KOGLER Juego para la biopsia vertebral
CRAIG-KOGLER Set pour la biopsie vertébrale
CRAIG-KOGLER Strumenti per biopsia vertebrale



1/1

45-0951

Ø 5 mm x 100 mm

Trocarhülse mit Zentimeter-Einteilung

Trocar cannula with centimetre scale

Cánula de trocar con escala graduada en centímetros

Canule de trocart graduée en cm

Cannula per trocar con scala centimetrata



1/2



1/1

45-0953

Ø 4 mm x 190 mm

halbstumpfer Trokar

Semi-blunt trocar
Trocar semi-romo
Trocart semi-mou
Trequarti semi smusso



1/2



1/1

45-0955

Ø 4 mm x 190 mm

Punktionstrephine für Knochen, mit gezahnter Schneide

Trephine for bone, with serrated cutting edge

Trépano de punción para huesos, con filo dentado

Tréphine de ponction pour os, avec tranchant dentellé

Trapano per osso, con tagliente dentato



1/2



1/1

45-0956

Ø 4 mm x 190 mm

Punktionstrephine für Weichteile, mit glatter Schneide

Trephine for soft tissue, with smooth cutting edge

Trépano de punción para tejido blando, con filo liso

Tréphine de ponction pour tissu mou, avec tranchant lisse

Trapano per tessuto molle, con taglio piatto



1/2

45-0957

Handgriff mit Kugelschnellverschluss zum Einführen und zur Extraktion von Punktionstrephinen

Handle with spherical quick-release mechanism for inserting and withdrawing the trephines

Mango con cierre esférico rápido para introducir y extraer los trépanos de punción

Manche avec mécanisme à billes pour introduire et enlever les tréphines de ponction

Manico con meccanismo sferico di sgancio per inserire ed estrarre, trapani



1/2



1/1

45-0958

Ø 2,5 mm x 210 mm

Doppelkralle zur Extraktionshilfe von Weichteilen

Double-ended retractor for extracting soft tissue

Doble-garra para extraer tejido blando

Double griffe pour extraction des tissus moux

Retratore doppio per estrarre il tessuto molle



1/2



1/1

45-0959

Ø 2,5 mm x 210 mm

stumpfer Mandrin zum Ausstoßen von Gewebeproben

Blunt obturator for ejecting tissue samples

Obturador para sacar pruebas de tejido

Obtuteur mou pour pousser les échantillons de tissu

Otturatore smusso per espellere il tessuto campione



1/2



Notizen

Notes

Notas

Notes

Note



LAWNTON
Medizintechnik



Tracheotomie
Tracheotomy
Traqueotomía
Trachéotomie
Tracheotomia



Instrumente für Tracheotomie
 Instruments for Tracheotomy
 Instrumentos para traqueotomía
 Instruments pour trachéotomie
 Strumenti per tracheotomia



Trachealhäkchen	Seite	217, 219-220, 226
Trachea Retractors	Page	217, 219-220, 226
Separadores para la tráquea	Página	217, 219-220, 226
Ecarteurs pour trachéotomie	Page	217, 219-220, 226
Uncini tracheali	Pagina	217, 219-220, 226



Kropfwundhaken	Seite	224
Goitre Retractor	Page	224
Separador para bocio	Página	224
Ecarteur à goitre	Page	224
Uncino per gozzo	Pagina	224



Wundspreizer, selbsthaltend	Seite	270
Self-Retaining Retractors	Page	270
Separadores con retenida automática	Página	270
Ecarteurs autostatiques	Page	270
Divaricatori autostatici	Pagina	270



Kropfsonden	Seite	378
Directors-Enucleators	Page	378
Sondas acanaladas	Página	378
Sondes à goitre	Page	378
Sonde per gozzo	Pagina	378



Kropffaßzange	Seite	454
Goitre Seizing Forceps	Page	454
Pinza para coger el bocio	Página	454
Pince à goitre	Page	454
Pinza per gozzo	Pagina	454



Internationale Größenskala
 International Scale
 Escala internacional
 Echelle internationale
 Scala internazionale

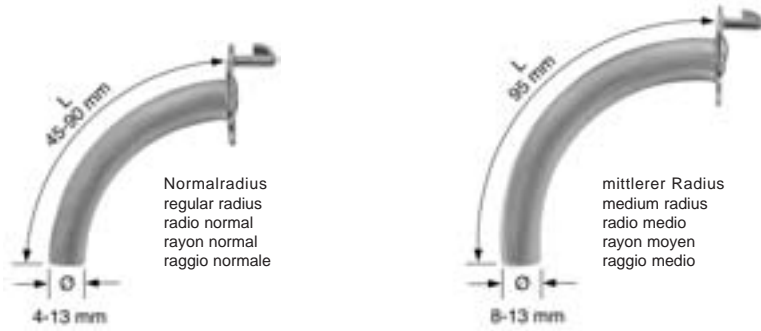
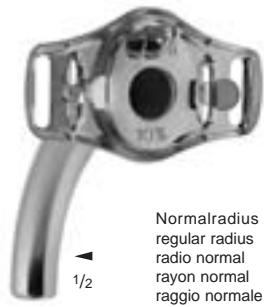

Fig.	0	1	2	3	4	5	6	7	8	9
ø mm	4	5	6	7	8	9	10	11	12	13



LUER

Normalradius
 regular radius
 radio normal
 rayon normal
 raggio normale

Fig.	ø mm	L mm	Silber Silver Plata Argent Argento	Neusilber German silver Plata meneses Argent blanc Argento bianco	Rostfreier Stahl 18/8 Stainless steel 18/8 Acero inoxidable 18/8 Acier inox 18/8 Acciaio inox 18/8
0	4	45	87-0440	87-0450	87-0460
1	5	50	87-0441	87-0451	87-0461
2	6	55	87-0442	87-0452	87-0462
3	7	60	87-0443	87-0453	87-0463
4	8	65	87-0444	87-0454	87-0464
5	9	70	87-0445	87-0455	87-0465
6	10	75	87-0446	▶ 87-0456	87-0466
7	11	80	87-0447	87-0457	87-0467
8	12	85	87-0448	87-0458	87-0468
9	13	90	87-0449	87-0459	87-0469



LUER

mittlerer Radius
 medium radius
 radio medio
 rayon moyen
 raggio medio

Fig.	ø mm	L mm	Silber Silver Plata Argent Argento
4	8	95	87-0414
5	9	95	87-0415
6	10	95	▶ 87-0416
7	11	95	87-0417
8	12	95	87-0418
9	13	95	87-0419



Trachealkanülen
Trachea Tubes
Cánulas traqueales
Canules pour la trachéotomie
Cannule tracheali

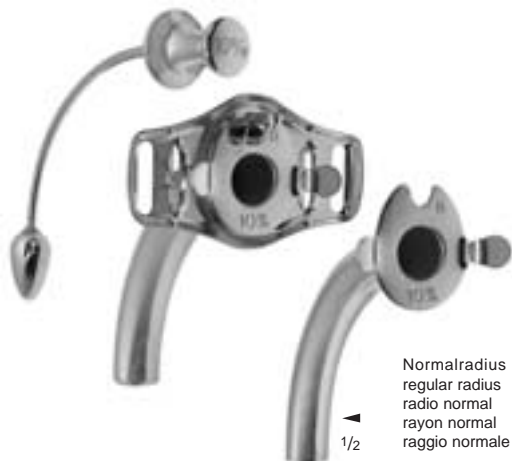

Normalradius
regular radius
radio normal
rayon normal
raggio normale

1/2

CHEVALIER-JACKSON

Fig.	ø mm	L mm	Silber Silver Plata Argent Argento	Neusilber German silver Plata meneses Argent blanc Argento bianco	Rostfreier Stahl 18/8 Stainless steel 18/8 Acero inoxidable 18/8 Acier inox 18/8 Acciaio inox 18/8
0	4	45	87-0400	87-0420	87-0430
1	5	50	87-0401	87-0421	87-0431
2	6	55	87-0402	87-0422	87-0432
3	7	60	87-0403	87-0423	87-0433
4	8	65	87-0404	87-0424	87-0434
5	9	70	87-0405	87-0425	87-0435
6	10	75	87-0406	▶ 87-0426	87-0436
7	11	80	87-0407	87-0427	87-0437
8	12	85	87-0408	87-0428	87-0438
9	13	90	87-0409	87-0429	87-0439



Normalradius
regular radius
radio normal
rayon normal
raggio normale

1/2

Fig.	ø mm	L mm	Neusilber German silver Plata meneses Argent blanc Argento bianco
4	8	65	87-0554
5	9	70	87-0555
6	10	75	▶ 87-0556
7	11	80	87-0557
8	12	85	87-0558
9	13	90	87-0559

Ventil-Sprechkanülen mit rundem Aufsteckventil
Valve speaking tubes, with detachable round valve
Cánulas traqueales con válvula para hablar, redonda
Canules parlantes avec soupape ronde amovible
Cannule parlante con valvola rotonda mobile



Normalradius
regular radius
radio normal
rayon normal
raggio normale

Fig.	ø mm	L mm	Silber Silver Plata Argent Argento	Neusilber German silver Plata meneses Argent blanc Argento bianco
4	8	65	87-0564	87-0574
5	9	70	87-0565	87-0575
6	10	75	87-0566	▶ 87-0576
7	11	80	87-0567	87-0577
8	12	85	87-0568	87-0578
9	13	90	87-0569	87-0579

Ventil-Sprechkanülen, Innenrohr mit Schiebeventil

Valve speaking tubes, inner tube with sliding valve

Cánulas traqueales con válvula para hablar, cánula interior con válvula de corredera

Canules parlantes, tube intérieur avec soupape à coulisse

Cannule parlanti, tubo interno con valvola scorrevole



mittlerer Radius
medium radius
radio medio
rayon moyen
raggio medio

Fig.	ø mm	L mm	Silber Silver Plata
4	8	95	87-0584
5	9	95	87-0585
6	10	95	▶ 87-0586
7	11	95	87-0587
8	12	95	87-0588
9	13	95	87-0589

Ventil-Sprechkanülen, Innenrohr mit Schiebeventil

Valve speaking tubes, inner tube with sliding valve

Cánulas traqueales con válvula para hablar, cánula interior con válvula de corredera

Canules parlantes, tube intérieur avec soupape à coulisse

Cannule parlanti, tubo interno con valvola scorrevole

ø 12 mm



87-0650
30 cm, 12"

Reinigungsbürste für
Trachealkanülen

Cleaning brush for trachea
tubes

Cepillo de limpieza para
cánulas traqueales

Brosse à nettoyer les
canules trachéales

Spazzolino per pulire
per cannule tracheali



Instrumente für Tracheotomie
 Instruments for Tracheotomy
 Instrumentos traqueotomía
 Instruments pour trachéotomie
 Strumenti per tracheotomia



UECKERMANN-DENKER
 87-0150
 - 87-0151
 11,5 cm, 4 1/2"

Not-Tracheotomietrokare mit Silberkanüle (Tracheotom)
 Cryothyreotomy trocars with silver cannula
 Trocares traqueales con cánula de plata (traqueotomo)
 Trocars pour la trachéotomie avec canule argent
 Tre quarti per tracheotomia con cannula di argento



BOSE
 87-0145
 16,5 cm, 6 1/2"

Trachealhäkchen, spitz, links
 Trachea retractor, sharp, left
 Separador para la tráquea, agudo, izquierdo
 Ecarteur pour trachéotomie, pointu, à gauche
 Uncino tracheale, acuto, sinistro



BOSE
 87-0146
 16,5 cm, 6 1/2"

Trachealhäkchen, spitz, rechts
 Trachea retractor, sharp, right
 Separador para la tráquea, agudo, derecho
 Ecarteur pour trachéotomie, pointu, à droite
 Uncino tracheale, acuto, destro

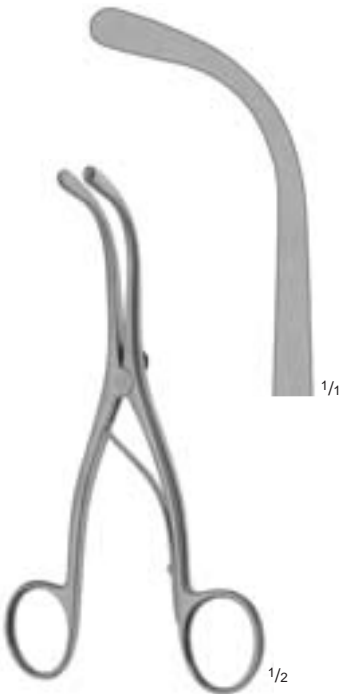

TROUSSEAU
 87-0270
 14 cm, 5 1/2"

Trachealdilatator
 Trachea dilator
 Dilatador para la tráquea
 Dilatateur pour la trachéotomie
 Dilatatore per tracheotomia



LABORDE
 87-0275
 14 cm, 5 1/2"

Trachealdilatator
 Trachea dilator
 Dilatador para la tráquea
 Dilatateur pour la trachéotomie
 Dilatatore per tracheotomia

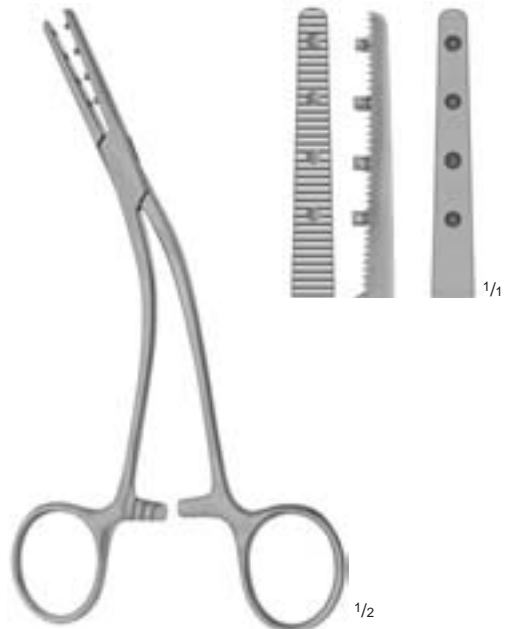

MASTIN
 12-0175
 17 cm, 6 3/4"

Muskelklemme
 Muscular clamp
 Pinza-clamp para músculos
 Pince-clamp musculaire
 Pinza muscolare

Tracheotomiebesteck
Tracheotomy Set
Juego para traqueotomía
Jeu d'instruments pour trachéotomie
Set per tracheotomia

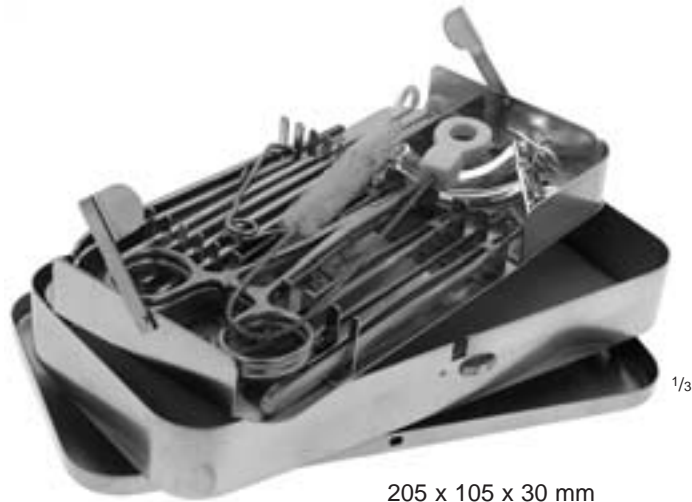

1/3

87-1035

Tracheotomiebesteck, komplett, bestehend aus:

57-1294	1	Rack
07-0960	1	Metalletui
04-1055	2	Griffe No. 4
04-1020	1	Klinge Fig. 20
04-1023	1	Klinge Fig. 23
06-0299	2	PEAN Klemmen, 13 cm, 5 1/8"
09-0116	1	anat. Pinzette, 13 cm, 5 1/8"
09-0156	2	chir. Pinzetten, 13 cm, 5 1/8", 1x2 Zähne
15-0204	1	Hohlsonde, 13 cm, 5 1/8"
20-0211	2	Trachealhäkchen, stumpf, 17 cm, 6 3/4"
21-0159	1	FINSEN Wundspreizer, stumpf, 7 cm, 2 3/4"
87-0145	1	BOSE Trachealhäkchen, scharf, links, 16,5 cm, 6 1/2"
87-0146	1	BOSE Trachealhäkchen, scharf, rechts, 16,5 cm, 6 1/2"
87-0453	1	LUER Trachealkanüle, Fig. 3, ø 7 mm, Neusilber
87-0454	1	LUER Trachealkanüle, Fig. 4, ø 8 mm, Neusilber
87-0650	1	Reinigungsbürste, 30 cm, 12"

205 x 105 x 30 mm

Tracheotomy set, complete, consisting of:

57-1294	1	Rack
07-0960	1	Metal case
04-1055	2	Handles No. 4
04-1020	1	Blade fig. 20
04-1023	1	Blade fig. 23
06-0299	2	PEAN Artery forceps, 13 cm, 5 1/8"
09-0116	1	Dissecting forceps, 13 cm, 5 1/8"
09-0156	2	Tissue forceps, 13 cm, 5 1/8", 1x2 teeth
15-0204	1	Grooved director, 13 cm, 5 1/8"
20-0211	2	Trachea retractors, blunt, 17 cm, 6 3/4"
21-0159	1	FINSEN retractor, blunt, 7 cm, 2 3/4"
87-0145	1	BOSE trachea retractor, sharp, left, 16.5 cm, 6 1/2"
87-0146	1	BOSE trachea retractor, sharp, right, 16.5 cm, 6 1/2"
87-0453	1	LUER trachea tube, fig. 3, ø 7 mm, German silver
87-0454	1	LUER trachea tube, fig. 4, ø 8 mm, German silver
87-0650	1	Cleaning brush, 30 cm, 12"

Juego para traqueotomía, completo, compuesto de:

57-1294	1	Depositorio
07-0960	1	Caja de esterilización
04-1055	2	Mangos No. 4
04-1020	1	Hoja fig. 20
04-1023	1	Hoja fig. 23
06-0299	2	PEAN pinzas hemostáticas, 13 cm, 5 1/8"
09-0116	1	Pinza de disección, 13 cm, 5 1/8"
09-0156	2	Pinzas quirúrgicas, con 1x2 dientes, 13 cm, 5 1/8"
15-0204	1	Sonda acanalada, 13 cm, 5 1/8"
20-0211	2	Separadores traqueales, romos, 17 cm, 6 3/4"
21-0159	1	FINSEN Separador traqueal, romo, 7 cm, 2 3/4"
87-0145	1	BOSE Separador traqueal, agudo, izquierdo, 16,5 cm, 6 1/2"
87-0146	1	BOSE Separador traqueal, agudo, derecho, 16,5 cm, 6 1/2"
87-0453	1	LUER Cánula traqueal, fig. 3, ø 7 mm, de plata meneses
87-0454	1	LUER Cánula traqueal, fig. 4, ø 8 mm, de plata meneses
87-0650	1	Cepillo de limpieza, 30 cm, 12"

Jeu d'instruments pour trachéotomie, complet, composé de:

57-1294	1	Chevalet
07-0960	1	Bôte métal
04-1055	2	Manche de bistouri No. 4
04-1020	1	Lame fig. 20
04-1023	1	Lame fig. 23
06-0299	2	Pinces hémostatiques PEAN, 13 cm, 5 1/8"
09-0116	1	Pince à dissection, 13 cm, 5 1/8"
09-0156	2	Pinces à griffes, 13 cm, 5 1/8", 1x2 dents
15-0204	1	Sonde cannelée, 13 cm, 5 1/8"
20-0211	2	Ecarteurs pour trachéotomie, moux, 17 cm, 6 3/4"
21-0159	1	FINSEN écarteur, mou, 7 cm, 2 3/4"
87-0145	1	BOSE écarteur pour trachéotomie, pointu, à gauche, 16,5 cm, 6 1/2"
87-0146	1	BOSE écarteur pour trachéotomie, pointu, à droite, 16,5 cm, 6 1/2"
87-0453	1	LUER canule trachéale, fig. 3, ø 7 mm, argent blanc
87-0454	1	LUER canule trachéale, fig. 4, ø 8 mm, argent blanc
87-0650	1	Brosse à nettoyer, 30 cm, 12"

Set per tracheotomia, completo, composto da:

57-1294	1	Supporto
07-0960	1	Scatola in metallo
04-1055	2	Manici per bisturi No. 4
04-1020	1	Lama fig. 20
04-1023	1	Lama fig. 23
06-0299	2	Pinze emostatiche PEAN, 13 cm, 5 1/8"
09-0116	1	Pinza per dissezione, 13 cm, 5 1/8"
09-0156	2	Pinze per dissezione con denti 1x2, 13 cm, 5 1/8"
15-0204	1	Sonda scanalata, 13 cm, 5 1/8"
20-0211	2	Uncini tracheali, smussi, 17 cm, 6 3/4"
21-0159	1	Divaricatore FINSEN, smusso, 7 cm, 2 3/4"
87-0145	1	Uncino tracheale BOSE, acuto, sinistro, 16,5 cm, 6 1/2"
87-0146	1	Uncino tracheale BOSE, acuto, destro, 16,5 cm, 6 1/2"
87-0453	1	Cannula tracheale LUER, fig. 3, ø 7 mm, argento bianco
87-0454	1	Cannula tracheale LUER, fig. 4, ø 8 mm, argento bianco
87-0650	1	Spazzolino per pulire, 30 cm, 12"



Tracheotomiebesteck
Tracheotomy Set
Juego para traqueotomía
Jeu d'instruments pour trachéotomie
Set per tracheotomia

205 x 105 x 42 mm

57-1296

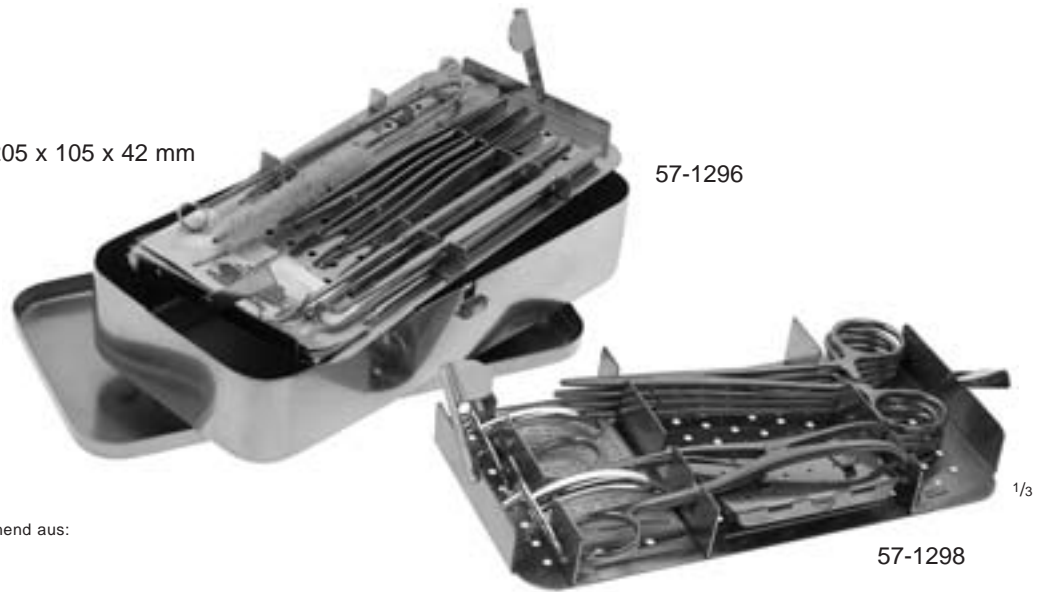

1/3

57-1298

87-1040

Tracheotomiebesteck, komplett, bestehend aus:

57-1296	1 Rack
57-1298	1 Rack
07-0962	1 Metalletui
04-1055	1 Griff No. 4
04-1020	1 Klinge Fig. 20
04-1022	1 Klinge Fig. 22
04-1023	2 Klängen Fig. 23
08-1660	1 Dose gelocht, für Klängen
06-0210	4 CRILE Klemmen, gerade, 14 cm, 5 1/2"
09-0116	1 anat. Pinzette, 13 cm, 5 1/8"
09-0156	2 chir. Pinzetten, 13 cm, 5 1/8", 1x2 Zähne
15-0204	1 Hohlsonde, 13 cm, 5 1/8"
20-0211	2 Trachealhäkchen, stumpf, 17 cm, 6 3/4"
87-0145	1 BOSE Trachealhäkchen, scharf, links, 16,5 cm, 6 1/2"
87-0146	1 BOSE Trachealhäkchen, scharf, rechts, 16,5 cm, 6 1/2"
87-0270	1 TROUSSEAU Trachealdilatator, 14 cm, 5 1/2"
87-0452	1 LUER Trachealkanüle, Fig. 2, ø 6 mm, Neusilber
87-0454	1 LUER Trachealkanüle, Fig. 4, ø 8 mm, Neusilber
87-0650	1 Reinigungsbürste, 30,5 cm, 12"

Tracheotomy set, complete, consisting of:

57-1296	1 Rack
57-1298	1 Rack
07-0962	1 Metal case
04-1055	1 Handle No. 4
04-1020	1 Blade fig. 20
04-1022	1 Blade fig. 22
04-1023	2 Blades fig. 23
08-1660	1 Perforated case, for blades
06-0210	4 CRILE Artery forceps, straight, 14 cm, 5 1/2"
09-0116	1 Dissecting forceps, 13 cm, 5 1/8"
09-0156	2 Tissue forceps, 13 cm, 5 1/8", 1x2 teeth
15-0204	1 Grooved director, 13 cm, 5 1/8"
20-0211	2 Trachea retractors, blunt 17 cm, 6 3/4"
87-0145	1 BOSE Trachea retractor, sharp, left, 16,5 cm, 6 1/2"
87-0146	1 BOSE Trachea retractor, sharp, right, 16,5 cm, 6 1/2"
87-0270	1 TROUSSEAU Trachea dilator, 14 cm, 5 1/2"
87-0452	1 LUER Trachea tube, fig. 2, ø 6 mm, German silver
87-0454	1 LUER Trachea tube, fig. 4, ø 8 mm, German silver
87-0650	1 Cleaning brush, 30 cm, 12"

Jeu d'instruments pour trachéotomie, complet, composé de:

57-1296	1 Chevalet
57-1298	1 Chevalet
07-0962	1 Boîte métal
04-1055	1 Manche de bistouri No. 4
04-1020	1 Lame fig. 20
04-1022	1 Lame fig. 22
04-1023	2 Lames fig. 23
08-1660	1 Boîte perforée, pour lames
06-0210	4 Pincés hémostatiques CRILE, droites 14 cm, 5 1/2"
09-0116	1 Pince à dissection, 13 cm, 5 1/8"
09-0156	2 Pincés à griffes, 13 cm, 5 1/8", 1x2 dents
15-0204	1 Sonde cannelée, 13 cm, 5 1/8"
20-0211	2 écarteurs pour trachéotomie, moux, 17 cm, 6 3/4"
87-0145	1 BOSE écarteur pour trachéotomie, pointu, à gauche, 16,5 cm, 6 1/2"
87-0146	1 BOSE écarteur pour trachéotomie, pointu, à droite, 16,5 cm, 6 1/2"
87-0270	1 TROUSSEAU dilataateur trachéal, 14 cm, 5 1/2"
87-0452	1 LUER canule trachéale, fig. 2, ø 6 mm, argent blanc
87-0454	1 LUER canule trachéale, fig. 4, ø 8 mm, argent blanc
87-0650	1 Brosse à nettoyer, 30 cm, 12"

Juego para traqueotomía, completo, compuesto de:

57-1296	1 Depositivo
57-1298	1 Depositivo
07-0962	1 Caja de esterilización
04-1055	1 Mango No. 4
04-1020	1 Hoja fig. 20
04-1022	1 Hoja fig. 22
04-1023	2 Hojas fig. 23
08-1660	1 Cajita perforada, para hojas
06-0210	4 CRILE Pinzas hemostáticas, rectas, 14 cm, 5 1/2"
09-0116	1 Pinza de disección, 13 cm, 5 1/8"
09-0156	2 Pinzas quirúrgicas, con 1x2 dientes, 13 cm, 5 1/8"
15-0204	1 Sonda acanalada, 13 cm, 5 1/8"
20-0211	2 Separadores traqueales, romos, 17 cm, 6 3/4"
87-0145	1 BOSE Separador traqueal, agudo, izquierdo, 16,5 cm, 6 1/2"
87-0146	1 BOSE Separador traqueal, agudo, derecho, 16,5 cm, 6 1/2"
87-0270	1 TROUSSEAU dilatador para la tráquea, 14 cm, 5 1/2"
87-0452	1 LUER Cánula traqueal, fig. 2, ø 6 mm, de plata meneses
87-0454	1 LUER Cánula traqueal, fig. 4, ø 8 mm, de plata meneses
87-0650	1 Cepillo de limpieza, 30 cm, 12"

Set per tracheotomia, completo, composto da:

57-1296	1 Supporto
57-1298	1 Supporto
07-0962	1 Scatola in metallo
04-1055	1 Manico per bisturi No. 4
04-1020	1 Lama fig. 20
04-1022	1 Lama fig. 22
04-1023	2 Lama fig. 23
08-1660	1 Scatoletta perforata, per lame
06-0210	4 Pinze emostatiche CRILE, rette, 14 cm, 5 1/2"
09-0116	1 Pinza per dissezione, 13 cm, 5 1/8"
09-0156	2 Pinze per dissezione con denti 1x2, 13 cm, 5 1/8"
15-0204	1 Sonda scanalata, 13 cm, 5 1/8"
20-0211	2 Uncini tracheali, smussi, 17 cm, 6 3/4"
87-0145	1 Uncino tracheale BOSE, acuto, sinistra, 16,5 cm, 6 1/2"
87-0146	1 Uncino tracheale BOSE, acuto, destra, 16,5 cm, 6 1/2"
87-0270	1 Dilatatore tracheale TROUSSEAU, 14 cm, 5 1/2"
87-0452	1 Cannula tracheale LUER, fig. 2, ø 6 mm, argento bianco
87-0454	1 Cannula tracheale LUER, fig. 4, ø 8 mm, argento bianco
87-0650	1 Spazzolino per pulire, 30 cm, 12"



LAWNTON

Medizintechnik



Sterilisation, Verschiedenes
Sterilization, Miscellaneous
Esterilización, Diversos artículos
Stérilisation, Divers articles
Sterilizzazione, Articoli vari



PREP LUBE ein flüssiges Konzentrat zur Pflege chirurgischer Instrumente
PREP LUBE a liquid concentrate for surgical instrument care
PREP LUBE un líquido concentrato para el cuidado del instrumental quirúrgico
PREP LUBE liquide concentré pour entretien des instruments
PREP LUBE liquido concentrato per la cura degli strumenti chirurgici

EIGENSCHAFTEN

- Keine ölhaltigen Ablagerungen
- Verlängert die Lebensdauer der Instrumente
- Angenehm im Geruch
- Verhindert Rostbildung
- Keine Bakterienbildung
- Konzentriert

BESCHREIBUNG

PREP LUBE ist ein Schmiermittel auf Emulsionsbasis, entwickelt speziell zur Schmierung und zum Oberflächenschutz von chirurgischen Instrumenten. Routinemäßige Behandlung der Instrumente mit PREP LUBE nach jedem Reinigungsvorgang verlängert deren Lebensdauer.

Es eignet sich ausgezeichnet zum Lösen von festgefressenen Schlüssen, da es durch seine kriechende Eigenschaft in engste Spalten vordringt.

Das gelieferte Konzentrat wird für den Gebrauch im Verhältnis 1:6 mit Wasser verdünnt. Die Instrumente werden in diese Verdünnung getaucht. Man läßt sie abtropfen ohne nachträgliches Abspülen oder Abwischen.

Die Verdünnung bleibt 2 Wochen lang gebrauchsfähig, verhindert jedes Bakterienwachstum und kann wiederholt verwendet werden. Ein zusätzliches Rostschutzmittel verhindert jede Rostbildung, wenn Instrumente mit PREP LUBE behandelt werden.

FEATURES

- No oily residue
- Extends Instrument Life
- Pleasantly Scented
- Anticorrosive
- Bacteriostatic
- Concentrated

DESCRIPTION

PREP LUBE is an emulsified lubrication oil, formulated specifically to lubricate and protect surgical instruments. Routine lubrication of instruments following each cleaning extends their effective life span.

Excellent for loosening „frozen“ box locks, PREP LUBE penetrates deeply into hinges, keeping all parts moving freely.

The concentrate is diluted one to six parts of water for actual use. Instruments are immersed in to the dilution, and then allowed to drain without rinsing or wiping.

The dilution remains stable for two weeks and, being effectively preserved to prevent bacterial growth, may be reused repeatedly. An added rust inhibition system prevents rust formation on instruments being soaked in the instrument bath.

CARACTERÍSTICAS

- Sin residuos oleosos
- Prolonga la vida útil del instrumento
- Con olor agradable
- Anticorrosivo
- Bacterioestático
- Concentrado

DESCRIPCIÓN

PREP LUBE es una emulsión oleosa lubricante especialmente creada para la lubricación de los instrumentos quirúrgicos y la protección de su superficie. El tratamiento periódico de los mismos con PREP LUBE después de cada limpieza prolonga su vida útil.

Es excelente para aflojar cerraduras atascadas, pues puede penetrar fácilmente en cavidades de difícil acceso.

El concentrado se ha de diluir en abundante agua en una proporción 1:6 para su uso. Los instrumentos se sumergen en la solución. Después se dejan escurrir sin enjuagarlos ni secarlos.

La solución permanece durante dos semanas apta para el uso, evita la formación de bacterias y puede ser usada repetidas veces. Un producto antioxidante adicional evita la oxidación en los productos tratados con PREP LUBE.

CARACTERISTIQUES

- Pas de dépôts huileux
- Augmente la durée de vie des instruments
- Odeur agréable
- Empêche l'oxydation
- Pas de formation de bactéries
- Concentré

DESCRIPTION

PREP LUBE est un lubrifiant à base d'émulsion, mis au point spécialement pour la lubrification et la protection des instruments chirurgicaux. Le traitement de routine des instruments avec PREP LUBE après chaque opération de nettoyage prolonge leur durée de vie.

Il convient parfaitement pour éliminer les corps incrustés; en effet, sa propriété rampante lui permet de pénétrer dans les fentes les plus étroites.

Pour l'utiliser, diluer le concentré livré avec de l'eau à raison de 1:6. Plonger les instruments dans cette solution. Les laisser s'égoutter sans rincer ou sécher au chiffon.

La solution reste utilisable pendant 2 semaines, elle empêche toute croissance bactérienne et peut être utilisée plusieurs fois. Un anti-oxydant supplémentaire empêche toute formation de rouille lorsque les instruments sont traités au PREP LUBE.

CARATTERISITCHE

- Senza residui oleosi
- Prolunga la vita degli strumenti
- Odore gradevole
- Anticorrosivo
- Batteriostatico
- Concentrato

DESCRIZIONE

PREP LUBE e' un' emulsione oleosa lubrificante creata per la lubrificazione e la protezione degli strumenti chirurgici. Una lubrificazione di routine degli strumenti dopo la pulizia prolunga la loro vita effettiva.

Eccellente per prevenire blocchi, PREP LUBE penetra profondamente nei cardini, mantenendo le parti libere di muoversi.

Il concentrato va diluito 1 a 6 parti di acqua per impiego normale. Gli strumenti vanno immersi e quindi lasciati ad asciugare senza risciacquare od asciugare.

La soluzione rimane stabile per due settimane, e poiche'evita la formazione di batteri, può essere impiegata ripetutamente. Un additivo antiossidante previene la formazione di ruggine sugli strumenti trattati con PREP LUBE.

PREP LUBE ein flüssiges Konzentrat zur Pflege chirurgischer Instrumente
 PREP LUBE a liquid concentrate for surgical instrument care
 PREP LUBE un líquido concentrato para el cuidado del instrumental quirúrgico
 PREP LUBE liquide concentré pour entretien des instruments
 PREP LUBE liquido concentrato per la cura degli strumenti chirurgici



1/3

04-0502
500 ml

Instrumenten-Pflegemittel in Kunststoffflasche
 Instrument care lubricant in plastic bottle
 Detergente para instrumentos en botella de plástico
 Détergent pour instruments en flacon plastique
 Detergente per strumenti in contenitore di plastica



1/3

► 04-0500 5 l
04-0504 4 x 5 l

Instrumenten-Pflegemittel in Kunststoffflasche
 Instrument care lubricant in plastic bottle
 Detergente para instrumentos en botella de plástico
 Détergent pour instruments en bidon plastique
 Detergente per strumenti in contenitore di plastica



1/2

04-0506

Instrumenten-Pflegemittel in Stift, nachfüllbar
 Instrument care lubricant in pen, refillable
 Detergente para instrumentos en pluma, rellenable
 Détergent pour instruments en stylo, rechargeable
 Detergente per strumenti su penna, ricaricabile



1/3

04-0508
250 ml

Instrumenten-Pflegemittel in Tropfflasche
 Instrument care lubricant in drop bottle
 Detergente para instrumentos en frasco cuentagotas
 Détergent pour instruments en flacon à compte gouttes
 Detergente per strumenti in contenitore con conta gocce



Sterilisierzangen
Sterilizing Forceps
Pinzas para esterilización
Pinces à stérilisation
Pinze per sterilizzazione



► 07-0265 20,5 cm, 8"
07-0270 29,0 cm, 11 $\frac{1}{2}$ "



07-0282
20 cm, 8"



ROGGE
07-0288
23,5 cm, 9 $\frac{1}{4}$ "



CHEATTLE
07-0260
27 cm, 10 $\frac{3}{4}$ "



CHEATTLE
07-0261
28 cm, 11"

Abfallzange
Pick-up Forceps
Pinza para desechos
Pince à déchets
Pinza raccogliatrice

Kappenzangen
Sterilizing Forceps
Combinación tapa/pinza
Combinaison couvercle/pince
Sterilizzatore per pinze



SAUERBRUCH
07-0300
55 cm, 22"

Abfallzange
Pick-up forceps
Pinza para desechos
Pince à déchets
Pinza raccogliatrice

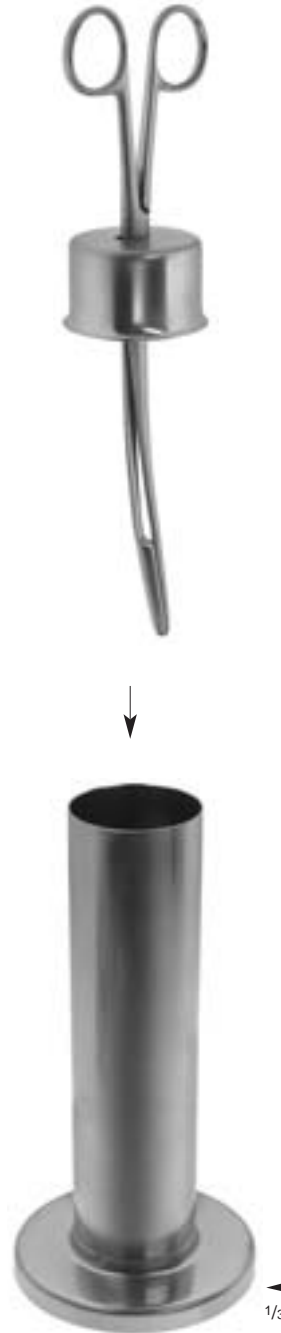

► **07-0302**

Kappenzange bestehend aus:
07-0303 1 Kornzange 25 cm, gebogen, mit Kappe (Deckel)
07-0304 1 Standgefäß mit großer Bodenplatte (standsicher)

Sterilizing forceps consisting of:
07-0303 1 Sterilizing forceps 25 cm, curved, with lid
07-0304 1 Jar with wide bottom plate (anti-tilt)

Combinación tapa/pinza compuesta de:
07-0303 1 Pinza para vendaje 25 cm, curva, con tapa
07-0304 1 Tarro con placa de pie grande (estable)

Combinaison couvercle/pince, composée de:
07-0303 1 Pince à tampons 25 cm, courbe, avec couvercle
07-0304 1 Eprouvette porte-pince avec large pied (stable)

Sterilizzatore per pinze composto di:
07-0303 1 Pinza per medicatura 25 cm, curva, con coperchio
07-0304 1 Contenitore con fondo largo (stabile)

07-0306

Kappenzange bestehend aus:
07-0307 1 Kornzange 32 cm, gebogen, mit Kappe (Deckel)
07-0308 1 Standgefäß mit großer Bodenplatte (standsicher)

Sterilizing forceps consisting of:
07-0307 1 Sterilizing forceps 32 cm, curved, with lid
07-0308 1 Jar with wide bottom plate (anti-tilt)

Combinación tapa/pinza compuesta de:
07-0307 1 Pinza para vendaje 32 cm, curva, con tapa
07-0308 1 Tarro con placa de pie grande (estable)

Combinaison couvercle/pince, composée de:
07-0307 1 Pince à tampons 32 cm, courbe, avec couvercle
07-0308 1 Eprouvette porte-pince avec large pied (stable)

Sterilizzatore per pinze composto di:
07-0307 1 Pinza per medicatura 32 cm, curva, con coperchio
07-0308 1 Contenitore con fondo largo (stabile)



Sterilisierklammern und -gestelle für Ringinstrumente
Safety Pins and Racks for holding Ring Handle Instruments
Imperdibles para esterilización, Porta-instrumentos
Epingles à instruments
Spilli di sicurezza e telai per trattenere gli strumenti

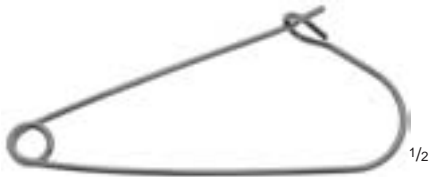

BLUNT
07-0295
10,5 cm, 4 1/8"

Sterilisierklammer
 Safety pin
 Imperdible para esterilización
 Epingle à instruments
 Spillo di sicurezza

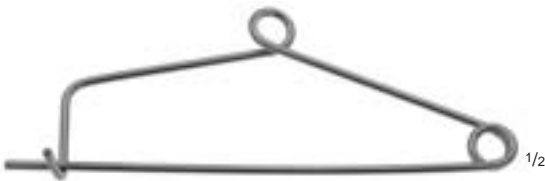

MAYO
07-0296
13,5 cm, 5 1/4"

Sterilisierklammer
 Safety pin
 Imperdible para esterilización
 Epingle à instruments
 Spillo di sicurezza



MAYO
07-0297
13,5 cm, 5 1/4"

Sterilisierklammer
 Safety pin
 Imperdible para esterilización
 Epingle à instruments
 Spillo di sicurezza

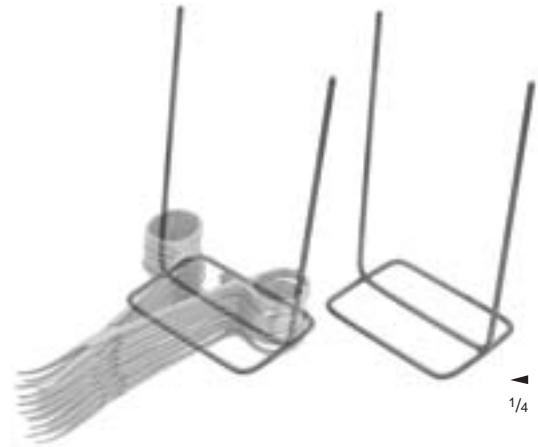

► **07-0350**
15,5 cm, 6"

Sterilisiergestell für 36 Ringgriffinstrumente, 1 Paar
 Safety rack for 36 ring handle instruments, 1 pair
 Porta-instrumento para 36 instrumentos con mangos de anillo, 1 par
 Porte instruments pour 36 instruments à anneaux, 1 paire
 Telaio per 36 strumenti, 1 paio

07-0352
25,5 cm, 10"

Sterilisiergestell für 60 Ringgriffinstrumente, 1 Paar
 Safety rack for 60 ring handle instruments, 1 pair
 Porta-instrumento para 60 instrumentos con mangos de anillo, 1 par
 Porte instruments pour 60 instruments à anneaux, 1 paire
 Telaio per 60 strumenti, 1 paio



07-0400
13 cm, 5 1/8"

Nadel-Sterilisationsgestell
 Suture needle sterilizing rack
 Soporte para esterilizar las agujas de sutura
 Support pour stériliser les aiguilles à suture
 Telaio per sterilizzare aghi per sutura



07-0401
13 cm, 5 1/8"

Stab für 07-0400
 Rod for 07-0400
 Varilla para 07-0400
 Tige pour 07-0400
 Supporto per 07-0400

Sterisierrahmen
Sterilizing Racks
Porta-instrumentos
Cadres de stérilisation
Telaio per sterilizzazione

Bereitstellungsbecher
Storing Cup
Tarro
Goblet
Contenitori



1/3

57-1272
190 x 96 x 30 mm

Sterisierrahmen für 8 Mikro-Instrumente
Sterilizing rack for 8 micro instruments
Porta-instrumento para 8 micro instrumentos
Chevalet de stérilisation pour 8 instruments de la micro-chirurgie
Telaio per sterilizzazione per 8 micro-strumenti



1/3

57-1276
190 x 96 x 30 mm

Sterisierrahmen für 10 Mikro-Instrumente
Sterilizing rack for 10 micro instruments
Porta-instrumento para 10 micro instrumentos
Chevalet de stérilisation pour 10 instruments de la micro-chirurgie
Telaio per sterilizzazione per 10 micro-strumenti



1/2

07-1066

Bereitstellungs-Becher mit Silikon-Bodenplatte
(07-1067) für Mikro-Instrumente

Storing cup with silicon bottom plate (07-1067)
for micro instruments

Tarro con silicona al fondo (07-1067)
para instrumental micro

Boîte ronde pour instruments de micro-chirurgie
avec plaque de fond en silicone (07-1067)

Contenitore per micro-strumenti con
fondo piatto in silicone (07-1067)



Sterilisier- und Bereitschaftsbehälter
Sterilizing and Storing Cases
Cajas para esterilización y conservación
Boîtes pour stérilisation et conservation
Cestelli per sterilizzazione e conservazione



1/4

Sterilisier- und Bereitschaftsbehälter,
 Deckel gelocht/Boden gelocht

Sterilizing and storing cases,
 lid perforated/bottom perforated

Cajas para esterilización y conservación,
 tapa perforada/fondo perforado

Boîtes pour stérilisation et conservation,
 couvercle perforé/fond perforé

Cestelli per sterilizzazione e conservazione,
 coperchio perforato/fondo perforato

Abmessungen (L x B x H)
 Sizes (l x w x h)
 Tamaños (l x f x a)
 Dimensions (lo. x hau. x la.)
 Dimensioni (L. x l. x h)

230 x 130 x 50 mm
 260 x 150 x 50 mm
 275 x 235 x 50 mm
 300 x 200 x 50 mm
 325 x 275 x 50 mm
 420 x 175 x 50 mm
 230 x 130 x 75 mm
 260 x 150 x 75 mm
 300 x 200 x 75 mm
 325 x 275 x 75 mm
 420 x 175 x 75 mm

Behälter
 Cases
 Cajas
 Boîtes
 Recipienti

07-0710
 ▶ 07-0711
 07-0728
 07-0712
 07-0715
 07-0716
 07-0700
 07-0701
 07-0702
 07-0705
 07-0706

Satz Spezialfilter, 5 Paar
 Set of special filters, 5 pairs
 Juego de filtros especiales, 5 pares
 Jeu de 5 paires de filtres spéciaux
 Set di 5 paia di filtri speciali

07-1710
 07-1711
 07-1728
 07-1712
 07-1715
 07-1716
 07-1700
 07-1701
 07-1702
 07-1705
 07-1706



1/4

Deponette,
 Deckel ungelocht/Boden gelocht

Deponette,
 lid non-perforated/bottom perforated

Deponette,
 tapa sin perforación/fondo perforado

Deponette,
 couvercle non perforé, fond perforé

Deponette,
 coperchio non perforato/fondo perforato

Abmessungen (L x B x H)
 Sizes (l x w x h)
 Tamaños (l x f x a)
 Dimensions (lo. x hau. x la.)
 Dimensioni (L. x l. x h)

245 x 135 x 35 mm
 245 x 135 x 50 mm
 245 x 135 x 60 mm

Behälter
 Cases
 Cajas
 Boîtes
 Recipienti

07-0871
 ▶ 07-0872
 07-0873

Satz Spezialfilter, 5 Paar
 Set of special filters, 5 pairs
 Juego de filtros especiales, 5 pares
 Jeu de 5 paires de filtres spéciaux
 Set di 5 paia di filtri speciali

07-1871
 07-1872
 07-1873



1/5

07-0607

295 x 215 x 67 mm (außen, outside, exterior, extérieur, esterne)
 280 x 195 x 55 mm (innen, inside, interior, intérieur, interne)

07-0613

280 x 275 x 67 mm (außen, outside, exterior, extérieur, esterne)
 265 x 255 x 55 mm (innen, inside, interior, intérieur, interne)

07-0618

400 x 280 x 67 mm (außen, outside, exterior, extérieur, esterne)
 380 x 260 x 55 mm (innen, inside, interior, intérieur, interne)

07-0626

490 x 270 x 67 mm (außen, outside, exterior, extérieur, esterne)
 470 x 250 x 55 mm (innen, inside, interior, intérieur, interne)

Sterilisierbehälter mit Bodenlochung (Deckel ungelocht) und Metall-Dauerfilter für Heißluft- und Dampfsterilisation. Herausnehmbare Siebplatte mit Silikonbank dient zur schonenden Lagerung von Instrumenten.

Sterilizing boxes, bottom perforated (lid non-perforated), with long-term metal filter for hot air and steam sterilization. Removable perforated tray with silicone cushions used to store instruments carefully.

Cajas de esterilización con fondo perforado (tapa sin perforación) y filtro de metal de larga duración para la esterilización con aire caliente o al vapor. Bandeja retirable con soportes de silicona, que sirven para el almacenaje cuidadoso.

Boîtes pour stérilisation avec fond perforé (couverture sans perforation) et filtre permanent en métal pour stérilisation à air chaud et à vapeur. Plateau perforé amovible avec tapis en silicone permettant de ranger soigneusement les instruments.

Cestelli per sterilizzazione con fondo perforato (coperchio non-perforato) e filtro metallico a lunga durata per sterilizzazione ad aria calda e vapore. Insetti estraibili con supporto in silicone permettono una custodia adeguata.

▶ **07-0609**

295 x 215 x 67 mm (außen, outside, exterior, extérieur, esterne)
 280 x 195 x 55 mm (innen, inside, interior, intérieur, interne)

07-0614

280 x 275 x 67 mm (außen, outside, exterior, extérieur, esterne)
 265 x 255 x 55 mm (innen, inside, interior, intérieur, interne)

07-0619

400 x 280 x 67 mm (außen, outside, exterior, extérieur, esterne)
 380 x 260 x 55 mm (innen, inside, interior, intérieur, interne)

07-0627

490 x 270 x 67 mm (außen, outside, exterior, extérieur, esterne)
 470 x 250 x 55 mm (innen, inside, interior, intérieur, interne)

Sterilisierbehälter mit Deckel- und Bodenlochung und Textil-Langzeitfilter für Dampfsterilisation. Herausnehmbare Siebplatte mit Silikonbank dient zur schonenden Lagerung von Instrumenten.

Sterilizing boxes, lid and bottom perforation, with long-term textile filter for steam sterilization. Removable perforated tray with silicone cushions used to store instruments carefully.

Cajas de esterilización con tapa y fondo perforado y filtro de tejido de larga duración para la esterilización al vapor. Bandeja retirable con soportes de silicona, que sirven para el almacenaje cuidadoso.

Boîtes pour stérilisation avec fond et couvercle perforés et filtre tissu longue durée pour stérilisation à vapeur. Plateau perforé amovible avec tapis en silicone permettant de ranger soigneusement les instruments.

Cestelli per sterilizzazione con coperchio e fondo perforati e filtro tessile a lunga durata per sterilizzazione a vapore. Insetti estraibili con supporto in silicone permettono una custodia adeguata.



Sterilisierbehälter
Sterilizing Boxes
Cajas de esterilización
Boîtes pour stérilisation
Cestelli per sterilizzazione



1/5

07-0707

295 x 215 x 50 mm (außen, outside, exterior, extérieur, esterne)
280 x 195 x 42 mm (innen, inside, interior, intérieur, interne)

07-0713

280 x 275 x 50 mm (außen, outside, exterior, extérieur, esterne)
265 x 255 x 42 mm (innen, inside, interior, intérieur, interne)

07-0718

400 x 280 x 50 mm (außen, outside, exterior, extérieur, esterne)
380 x 260 x 42 mm (innen, inside, interior, intérieur, interne)

07-0726

490 x 270 x 50 mm (außen, outside, exterior, extérieur, esterne)
470 x 250 x 42 mm (innen, inside, interior, intérieur, interne)

Sterilisierbehälter mit Bodenlochung (Deckel ungelocht) und Metall-Dauerfilter für Heißluft- und Dampfsterilisation. Herausnehmbare Siebplatte mit Silikonstreifen dient zur schonenden Lagerung von Instrumenten.

Sterilizing boxes, bottom perforated (lid non-perforated), with long-term metal filter for hot air and steam sterilization. Removable perforated tray with silicone cushions used to store instruments carefully.

Cajas de esterilización con fondo perforado (tapa sin perforación) y filtro de metal de larga duración para la esterilización con aire caliente o al vapor. Bandeja retirable con soportes de silicona, que sirven para el almacenaje cuidadoso.

Boîtes pour stérilisation avec fond perforé (couverture sans perforation) et filtre permanent en métal pour stérilisation à air chaud et à vapeur. Plateau perforé amovible avec tapis en silicone permettant de ranger soigneusement les instruments.

Cestelli per sterilizzazione con fondo perforato (coperchio non-perforato) e filtro metallico a lunga durata per sterilizzazione ad aria calda e vapore. Inserti estraibili con supporto in silicone permettono una custodia adeguata.

► **07-0709**

295 x 215 x 50 mm (außen, outside, exterior, extérieur, esterne)
280 x 195 x 42 mm (innen, inside, interior, intérieur, interne)

07-0714

280 x 275 x 50 mm (außen, outside, exterior, extérieur, esterne)
265 x 255 x 42 mm (innen, inside, interior, intérieur, interne)

07-0719

400 x 280 x 50 mm (außen, outside, exterior, extérieur, esterne)
380 x 260 x 42 mm (innen, inside, interior, intérieur, interne)

07-0727

490 x 270 x 50 mm (außen, outside, exterior, extérieur, esterne)
470 x 250 x 42 mm (innen, inside, interior, intérieur, interne)

Sterilisierbehälter mit Deckel- und Bodenlochung und Textil-Langzeitfilter für Dampfsterilisation. Herausnehmbare Siebplatte mit Silikonstreifen dient zur schonenden Lagerung von Instrumenten.

Sterilizing boxes, lid and bottom perforation, with long-term textile filter for steam sterilization. Removable perforated tray with silicone cushions used to store instruments carefully.

Cajas de esterilización con tapa y fondo perforado y filtro de tejido de larga duración para la esterilización al vapor. Bandeja retirable con soportes de silicona, que sirven para el almacenaje cuidadoso.

Boîtes pour stérilisation avec fond et couvercle perforés et filtre tissu longue durée pour stérilisation à vapeur. Plateau perforé amovible avec tapis en silicone permettant de ranger soigneusement les instruments.

Cestelli per sterilizzazione con coperchio e fondo perforati e filtro tessile a lunga durata per sterilizzazione a vapore. Inserti estraibili con supporto in silicone permettono una custodia adeguata.

Sterilisierbehälter
 Sterilizing Boxes
 Cajas de esterilización
 Boîtes pour stérilisation
 Cestelli per sterilizzazione



07-2707

295 x 215 x 70 mm (außen, outside, exterior, extérieur, esterne)
 280 x 195 x 55 mm (innen, inside, interior, intérieur, interne)

07-2713

280 x 275 x 70 mm (außen, outside, exterior, extérieur, esterne)
 265 x 255 x 55 mm (innen, inside, interior, intérieur, interne)

07-2718

400 x 280 x 70 mm (außen, outside, exterior, extérieur, esterne)
 380 x 260 x 55 mm (innen, inside, interior, intérieur, interne)

07-2726

490 x 270 x 70 mm (außen, outside, exterior, extérieur, esterne)
 470 x 250 x 55 mm (innen, inside, interior, intérieur, interne)

Sterilisierbehälter mit Bodenlochung (Deckel ungelocht) und Metall-Dauerfilter für Heißluft- und Dampfsterilisation. 2 herausnehmbare Siebplatten mit Silikonstreifen dient zur schonenden Lagerung von Instrumenten.

Sterilizing boxes, bottom perforated (lid non-perforated), with long-term metal filter for hot air and steam sterilization. 2 removable perforated trays with silicone cushions used to store instruments carefully.

Cajas de esterilización con fondo perforado (tapa sin perforación) y filtro de metal de larga duración para la esterilización con aire caliente o al vapor. 2 bandejas retirable con soportes de silicona, que sirven para el almacenaje cuidadoso.

Boîtes pour stérilisation avec fond perforé (couvercle sans perforation) et filtre permanent en métal pour stérilisation à air chaud et à vapeur. 2 Plateaux perforés amovibles avec tapis en silicone permettant de ranger soigneusement les instruments.

Cestelli per sterilizzazione con fondo perforato (coperchio non-perforato) e filtro metallico a lunga durata per sterilizzazione ad aria calda e vapore. 2 Inserti estraibili con supporto in silicone permettono una custodia adeguata.

► **07-2709**

295 x 215 x 70 mm (außen, outside, exterior, extérieur, esterne)
 280 x 195 x 55 mm (innen, inside, interior, intérieur, interne)

07-2714

280 x 275 x 70 mm (außen, outside, exterior, extérieur, esterne)
 265 x 255 x 55 mm (innen, inside, interior, intérieur, interne)

07-2719

400 x 280 x 70 mm (außen, outside, exterior, extérieur, esterne)
 380 x 260 x 55 mm (innen, inside, interior, intérieur, interne)

07-2727

490 x 270 x 70 mm (außen, outside, exterior, extérieur, esterne)
 470 x 250 x 55 mm (innen, inside, interior, intérieur, interne)

Sterilisierbehälter mit Deckel- und Bodenlochung und Textil-Langzeitfilter für Dampfsterilisation. 2 herausnehmbare Siebplatten mit Silikonstreifen dient zur schonenden Lagerung von Instrumenten.

Sterilizing boxes, lid and bottom perforation, with long-term textile filter for steam sterilization. 2 removable perforated trays with silicone cushions used to store instruments carefully.

Cajas de esterilización con tapa y fondo perforado y filtro de tejido de larga duración para la esterilización al vapor. 2 bandejas retirables con soportes de silicona, que sirven para el almacenaje cuidadoso.

Boîtes pour stérilisation avec fond et couvercle perforés et filtre tissu longue durée pour stérilisation à vapeur. 2 Plateaux perforés amovibles avec tapis en silicone permettant de ranger soigneusement les instruments.

Cestelli per sterilizzazione con coperchio e fondo perforati e filtro tessile a lunga durata per sterilizzazione a vapore. 2 Inserti estraibili con supporto in silicone permettono una custodia adeguata.



Steriliserbehälter aus Kunststoff
Sterilizing Boxes of Plastic
Cajas de esterilización de plástico
Boîtes pour stérilisation en plastique
Cestelli in plastica per sterilizzazione



07-0900

162 x 68 x 24 mm (außen, outside, exterior, extérieur, esterne)

152 x 63 x 19 mm (innen, inside, interior, intérieur, interne)

07-0902

175 x 107 x 24 mm (außen, outside, exterior, extérieur, esterne)

165 x 102 x 19 mm (innen, inside, interior, intérieur, interne)

07-0904

200 x 107 x 24 mm (außen, outside, exterior, extérieur, esterne)

190 x 102 x 19 mm (innen, inside, interior, intérieur, interne)

► 07-0906

264 x 157 x 24 mm (außen, outside, exterior, extérieur, esterne)

254 x 152 x 19 mm (innen, inside, interior, intérieur, interne)

Steriliserbehälter mit durchsichtigem Deckel und Silikonmatte dient zur Lagerung von Mikro-Instrumenten. Deckel- und Bodenlochung. Vor der Sterilisation in einen im Fachhandel erhältlichen Folienschlauch eingeschweißt, bleiben Behälter und Instrumente steril und einsatzbereit.

Sterilizing boxes with transparent cover and silicone cushion to store micro instruments. Lid and bottom perforation. The instruments and sterilizing box remain sterile and ready for operation when welded before sterilizing into a foil strip which can be obtained at the specialized dealer.

Caja de esterilización con tapa transparente y soporte de silicona, que sirven para el almacenaje de instrumental micro. Tapa y fondo perforado. Los instrumentos y la caja de esterilización permanecen estéril y preparados para operar si se envasa antes de la esterilización en una funda que se puede conseguir por un distribuidor especial.

Boîte pour stérilisation avec couvercle transparent et tapis en silicone utilisé pour ranger les instruments micro. Couvercle et fond perforés. Les instruments et la boîte restent stériles et prêts pour l'opération s'ils sont emballés sous sachets plastiques avant d'être stérilisés. Ces sachets peuvent être obtenus chez un distributeur spécialisé.

Cestelli per sterilizzazione con coperchio trasparente e supporto in silicone. Servono per la custodia degli strumenti micro. Coperchio e fondo perforati. Cestelli e strumenti restano sterili e pronti per l'impiego se, prima della sterilizzazione, vengono fissati in un tubo flessibile laminato, in vendita presso il commercio specializzato.



07-0916

264 x 157 x 43 mm (außen, outside, exterior, extérieur, esterne)

254 x 152 x 38 mm (innen, inside, interior, intérieur, interne)

Steriliserbehälter mit durchsichtigem Deckel, herausnehmbarer Siebplatte und 2 Silikonmatten dient zur Lagerung von Mikro-Instrumenten. Deckel- und Bodenlochung. Vor der Sterilisation in einen im Fachhandel erhältlichen Folienschlauch eingeschweißt, bleiben Behälter und Instrumente steril und einsatzbereit.

Sterilizing box with transparent cover, removable perforated tray and 2 silicone cushions to store micro instruments. Lid and bottom perforation. The instruments and sterilizing box remain sterile and ready for operation when welded before sterilizing into a foil strip which can be obtained at the specialized dealer.

Caja de esterilización con tapa transparente, 1 bandeja retirable y 2 soportes de silicona, que sirven para el almacenaje de instrumental micro. Coperchio e fondo perforado. Los instrumentos y la caja de esterilización permanecen estéril y preparados para operar si se envasa antes de la esterilización en una funda que se puede conseguir por un distribuidor especial.

Boîte pour stérilisation avec couvercle transparent, plateau perforé amovible et 2 tapis en silicone utilisés pour ranger les instruments micro. Couvercle et fond perforés. Les instruments et la boîte restent stériles et prêts pour l'opération s'ils sont emballés sous sachets plastiques avant d'être stérilisés. Ces sachets peuvent être obtenus chez un distributeur spécialisé.

Cestelli per sterilizzazione con coperchio trasparente, inserto estraibile e 2 supporti in silicone. Servono per la custodia degli strumenti micro. Coperchio e fondo perforati. Cestelli e strumenti restano sterili e pronti per l'impiego se, prima della sterilizzazione, vengono fissati in un tubo flessibile laminato, in vendita presso il commercio specializzato.

Sterilisiertrommeln
Sterilizing Drums
Cajas (tambores) de esterilización
Boîtes rondes pour stérilisation
Cestelli rotondi per sterilizzazione

Farbige Kennzeichnungsschilder
Coloured Identification Labels
Placas de identificación de color
Etiquettes d'identification, en couleur
Targhette di identificazione colorate



KONRICH
07-0846
- 07-0861

Sterilisiertrommeln
Sterilizing drums
Cajas (tambores) para esterilización
Boîtes rondes pour stérilisation
Cestelli rotondi per sterilizzazione

Abmessungen (ø)
Sizes (ø)
Tamaños (ø)
Dimensions (ø)
Dimensioni (ø)

100 x 100 mm
150 x 150 mm
200 x 150 mm
200 x 190 mm
240 x 160 mm
240 x 230 mm
290 x 160 mm
290 x 240 mm
340 x 160 mm
340 x 240 mm
390 x 145 mm
390 x 240 mm
390 x 290 mm

Behälter
Cases
Cajas
Boîtes
Recipienti

07-0846
07-0847
07-0850
07-0851
07-0852
07-0853
07-0855
07-0856
▶ 07-0854
07-0857
07-0858
07-0860
07-0861

Satz Spezialfilter, 5 Paar
Set of special filters, 5 pairs
Juego de filtros especiales, 5 pares
Jeu de 5 paires de filtres spéciaux
Set di 5 paia di filtri speciali

07-1846
07-1847
07-1850
07-1851
07-1852
07-1853
07-1855
07-1856
07-1854
07-1857
07-1858
07-1860
07-1861

07-0897

Kennzeichnungsschild für Sterilisier- und Bereitschaftsbehälter und Deponette. Text (bis 12 Buchstaben) und Farbe (rot, blau, grün, gelb, schwarz, silber) nach Wahl.

Identification label for sterilizing and storing cases and deponette. Inscription (up to 12 letters) and colour (red, blue, green, yellow, black, silver) upon choice.

Placas de identificación para cajas de esterilización y conservación y para deponette. Texto (hasta 12 letras) y color (rojo, azul, verde, amarillo, negro, plateado) a elección.

Etiquettes d'identification pour boîtes à stériliser. Texte (maximum 12 lettres) en couleur (rouges, bleues, vertes, jaunes, noires, argent).

Targhette di identificazione per la sterilizzazione, conservazione e deponette. Iscrizioni (sopra 12 lettere) e colori (rosso, blu, verde, giallo, nero, argento) a scelta.



1/2

07-0899

Kennzeichnungsschild für Sterilisiertrommeln, Sterilisier-Siebschalen und -körbe. Text (bis 12 Buchstaben) und Farbe (rot, blau, grün, gelb, schwarz, silber) nach Wahl.

Identification label for sterilizing drums, sterilizing trays and baskets. Inscription (up to 12 letters) and colour (red, blue, green, yellow, black, silver) upon choice.

Placas de identificación para cajas (tambores) de esterilización y bandejas/cestas de esterilización. Texto (hasta 12 letras) y color (rojo, azul, verde, amarillo, negro, plateado) a elección.

Etiquettes d'identification pour boîtes rondes et plateaux à stériliser. Texte (maximum 12 lettres) en couleur (rouges, bleues, vertes, jaunes, noires, argent).

Targhette di identificazione per la sterilizzazione di cestelli rotondi, vassoi e cestelli. Iscrizioni (sopra 12 lettere) e colori (rosso, blu, verde, giallo, nero, argento) a scelta.



1/2

07-0895

Schilderleiste
Label rack
Porta-placas
Porte-plaques
Porta targhette



1/5



Sterilisier-Siebschalen
Sterilizing Trays
Bandejas y cestas de esterilización
Plateaux de stérilisation
Cestelli per sterilizzazione



- ▶ 07-0766 260 x 260 x 50 mm
- 07-0767 260 x 260 x 80 mm
- 07-0768 260 x 260 x 100 mm

Sterilisier-Siebschalen aus perforiertem Blech, für Container 300 mm lang

Sterilizing trays of perforated steel sheet, for container 300 mm long

Bandejas de esterilización perforadas de chapa de acero para contenedores de 300 mm de largo

Plateaux en inox perforé pour stérilisation, pour container de 300 mm de longueur

Castelli in acciaio perforato per la sterilizzazione di contenitori lunghi 300 mm



- ▶ 07-0740 480 x 260 x 50 mm
- 07-0786 520 x 260 x 50 mm
- 07-0787 520 x 260 x 80 mm
- 07-0788 520 x 260 x 100 mm

Sterilisier-Siebschalen aus perforiertem Blech, für Container 600 mm lang

Sterilizing trays of perforated steel sheet, for container 600 mm long

Bandejas de esterilización perforadas de chapa de acero para contenedores de 600 mm de largo

Plateaux en inox perforé pour stérilisation, pour container de 600 mm de longueur

Castelli in acciaio perforato per la sterilizzazione di contenitori lunghi 600 mm



- 07-0730
- 240 x 240 x 60 mm

Sterilisier-Siebschale aus Drahtgeflecht, für Container 300 mm lang

Sterilizing tray of wire mesh, for container 300 mm long

Cesta de esterilización de alambre para contenedores de 300 mm de largo

Plateau en fil inox pour stérilisation, pour container de 300 mm de longueur

Castello in rete metallica per la sterilizzazione di contenitori lunghi 300 mm



- ▶ 07-0732 480 x 240 x 60 mm
- 07-0747 520 x 240 x 75 mm
- 07-0748 520 x 240 x 100 mm

Sterilisier-Siebschale aus Drahtgeflecht, für Container 600 mm lang

Sterilizing trays of wire mesh, for container 600 mm long

Cesta de esterilización de alambre para contenedores de 600 mm de largo

Plateau en fil inox pour stérilisation, pour container de 600 mm de longueur

Castello in rete metallica per la sterilizzazione di contenitori lunghi 600 mm

Sterilisier-Körbe
Sterilizing Baskets
Cestas de esterilización
Paniers de stérilisation
Castelli per sterilizzazione

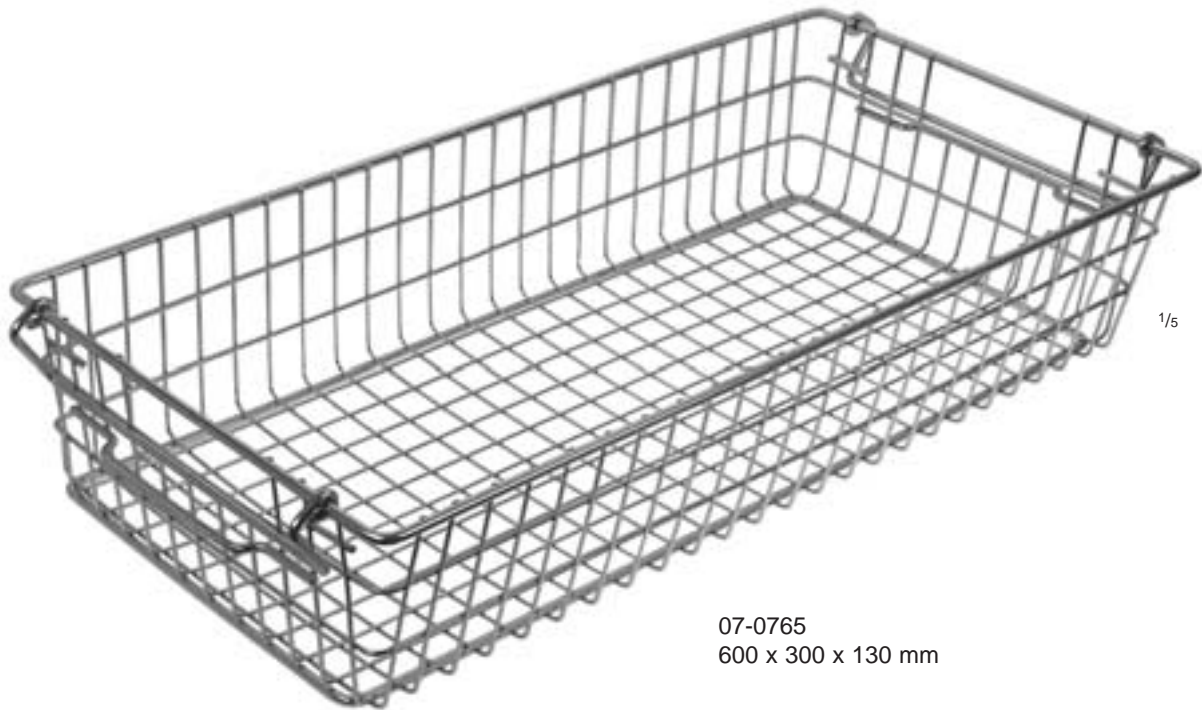

1/5

07-0765
600 x 300 x 130 mm

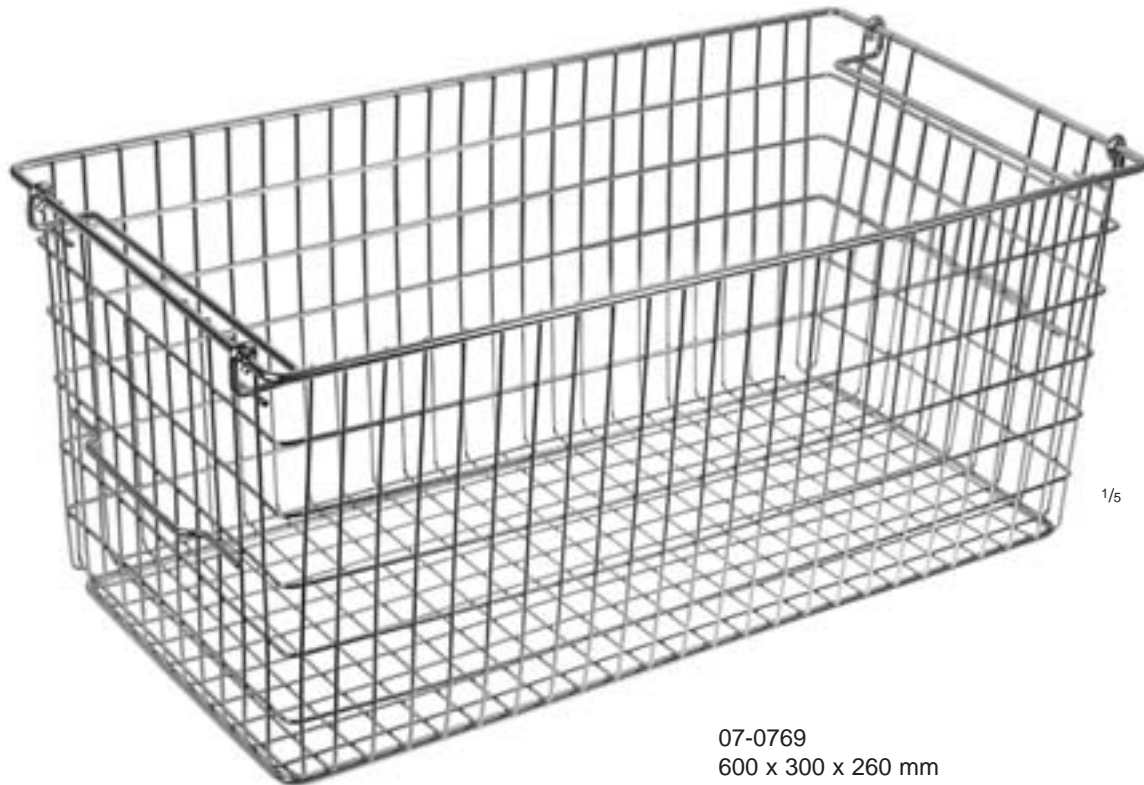

1/5

07-0769
600 x 300 x 260 mm



Instrumentenkästen
Instrument Boxes
Cajas para instrumentos
Boîtes pour instruments
Cassette per strumenti



1/4

Abmessungen (L x B x H)
Sizes (l x w x h)
Tamaños (l x f x a)
Dimensions (lo. x hau. x la.)
Dimensioni (L x l x h)

07-1260	165 x 85 x 35 mm
07-1261	200 x 100 x 35 mm
07-1262	200 x 100 x 50 mm
07-1263	230 x 130 x 50 mm
▶ 07-1264	260 x 150 x 50 mm
07-1265	270 x 235 x 50 mm
07-1266	300 x 200 x 50 mm
07-1267	325 x 275 x 50 mm

mit Knopfdeckel
lid with knob
tapa con botón
avec couvercle à bouton
con coperchio a bottone



1/4

Abmessungen (L x B x H)
Sizes (l x w x h)
Tamaños (l x f x a)
Dimensions (lo. x hau. x la.)
Dimensioni (L x l x h)

07-1270	165 x 85 x 35 mm
07-1271	200 x 100 x 35 mm
07-1272	200 x 100 x 50 mm
07-1273	230 x 130 x 50 mm
▶ 07-1274	260 x 150 x 50 mm
07-1275	270 x 235 x 50 mm
07-1276	300 x 200 x 50 mm
07-1277	325 x 275 x 50 mm

Deckel ohne Knopf
lid without knob
tapa sin botón
avec couvercle sans bouton
con coperchio senza bottone



1/4

07-1280
205 x 105 x 35 mm

Deckel ohne Knopf
lid without knob
tapa sin botón
avec couvercle sans bouton
con coperchio senza bottone

Standgefäße
Jars
Tarrós
Récipients cylindriques
Recipienti cilindrici

Dosen
Containers
Recipientes
Récipients
Recipienti



1/2



1/2



1/2

Abmessungen (ø x H)
Sizes (lø x h)
Tamaños (ø x a)
Dimensions (ø x la.)
Dimensioni (ø x h)

30 x 90 mm
50 x 100 mm
50 x 125 mm
50 x 175 mm
75 x 100 mm
75 x 130 mm
75 x 175 mm
100 x 175 mm
100 x 200 mm

Standgefäß ohne Deckel
Jar without lid
Tarro sin tapa
Récipient sans couvercle
Recipiente senza coperchio

07-1050
07-1056
▶ 07-1051
07-1057
07-1058
07-1059
07-1054
07-1061
07-1055

Deckel allein
Lid only
Tapa suelta
Couvercle seul
Coperchio solo

—
07-1071
▶ 07-1072
07-1073
07-1074
07-1075
07-1076
07-1077
07-1078

Deckel allein mit Dreieck-Aussparung
Lid only with triangle hole
Tapa sola con abertura en triángulo
Couvercle seul avec ouverture triangulaire
Coperchio solo con apertura triangolare

—
07-1081
▶ 07-1082
07-1083
07-1084
07-1085
07-1086
07-1087
07-1088



1/2

Abmessungen (ø x H)
Sizes (lø x h)
Tamaños (ø x a)
Dimensions (ø x la.)
Dimensioni (ø x h)

07-1041 75 x 60 mm
07-1042 75 x 75 mm
07-1043 100 x 60 mm
07-1044 100 x 100 mm
▶ 07-1045 125 x 80 mm
07-1046 125 x 125 mm
07-1047 150 x 150 mm

Dosen, mit Knopfdeckel
Containers, lid with knob
Recipientes, tapa con botón
Récipients avec couvercle à bouton
Recipienti con coperchio a bottone



Instrumentenablageplatten
Instrument Storing Trays
Bandejas para instrumentos
Plateaux pour instruments
Vassoi porta strumenti

Schalen
Trays
Bandejas
Bassins
Bacinelle



Abmessungen (L x B x H)
Sizes (l x w x h)
Tamaños (l x f x a)
Dimensions (lo. x hau. x la.)
Dimensioni (L x l x h)

07-1100	210 x 160 x 10 mm
07-1101	240 x 180 x 10 mm
▶ 07-1102	310 x 150 x 10 mm
07-1103	310 x 210 x 10 mm
07-1104	350 x 240 x 10 mm
07-1105	400 x 270 x 10 mm
07-1106	420 x 280 x 10 mm

Instrumentenablageplatten
Instrument storing trays
Bandejas para instrumentos
Plateaux pour instruments
Vassoi porta strumenti



Abmessungen (L x B x H)
Sizes (l x w x h)
Tamaños (l x f x a)
Dimensions (lo. x hau. x la.)
Dimensioni (L x l x h)

07-1110	230 x 155 x 30 mm
07-1111	300 x 175 x 30 mm
▶ 07-1112	300 x 175 x 40 mm
07-1113	350 x 240 x 36 mm
07-1114	400 x 300 x 50 mm

Mehrzweckschalen
Universal trays
Bandejas universales
Bassins universal
Bacinelle universali



07-1120
235 x 190 x 40 mm

Schwenkschale
Tray
Bandeja rectangulares
Bassin et cuvette pour guéridons
Bacinelle rettangolari

Spülschalen
Solution Bowls
Cubetas para soluciones
Cupules
Scodelle per soluzioni

Waschschüsseln
Wash Bowls
Palanganas
Cuvettes
Scodelle per liquidi



	Abmessungen (ø x H) Sizes (lø x h) Tamaños (ø x a) Dimensions (ø x la.) Dimensioni (ø x h)	Inhalt Capacity Cabida Capacité Capacità
07-1000	70 x 35 mm	0,1 l
07-1001	90 x 50 mm	0,2 l
07-1002	100 x 65 mm	0,3 l
07-1003	115 x 65 mm	0,4 l
07-1004	120 x 70 mm	0,5 l
07-1010	150 x 75 mm	0,7 l
07-1011	155 x 85 mm	1,0 l
07-1012	195 x 120 mm	2,0 l
07-1013	220 x 120 mm	2,7 l
07-1015	245 x 130 mm	4,0 l
07-1018	290 x 150 mm	5,5 l
07-1019	305 x 175 mm	8,0 l
07-1020	360 x 185 mm	12,0 l
▶ 07-1021	370 x 200 mm	14,0 l

Spülschalen
Solution bowls
Cubetas para soluciones
Cuvettes
Scodelle per soluzioni



	Abmessungen (ø x H) Sizes (lø x h) Tamaños (ø x a) Dimensions (ø x la.) Dimensioni (ø x h)	Inhalt Capacity Cabida Capacité Capacità
▶ 07-1022	330 x 90 mm	6,0 l
07-1023	330 x 115 mm	8,0 l

Waschschüsseln
Wash bowls
Palanganas
Cuvettes
Scodella per liquidi



	Abmessungen (ø x H) Sizes (lø x h) Tamaños (ø x a) Dimensions (ø x la.) Dimensioni (ø x h)	Inhalt Capacity Cabida Capacité Capacità
07-1130	40 x 19 mm	0,05 l
07-1131	61 x 30 mm	0,07 l
07-1132	80 x 40 mm	0,14 l
07-1133	116 x 50 mm	0,35 l
07-1134	128 x 55 mm	0,45 l
▶ 07-1135	147 x 65 mm	0,70 l
07-1136	167 x 75 mm	1,10 l
07-1137	187 x 85 mm	1,60 l



07-1140	116 x 35 mm	0,30 l
07-1141	128 x 38 mm	0,40 l
▶ 07-1142	147 x 40 mm	0,50 l
07-1143	157 x 45 mm	0,75 l
07-1144	187 x 45 mm	1,00 l

Runde Schalen
Round bowls
Cubetas redondas
Cupules
Scodelle rotonde



Nierenschalen
Kidney Bowls
Cuñas
Bassins réniformes
Bacinelle reniformi

Dreieckschalen
Triangular Basins
Cubetas triangulares
Bassins triangulaires
Bacinelle triangolari

Stechbecken
Bed Pan
Cubetas
Bassins de lit
Padelle

Abmessungen (L x B x H)
Sizes (l x w x h)
Tamaños (l x f x a)
Dimensions (lo. x hau. x la.)
Dimensioni (L x l x h)



07-0930 170 x 100 x 35 mm
07-0931 200 x 100 x 40 mm
▶ 07-0932 250 x 140 x 40 mm
07-0933 275 x 150 x 45 mm

Nierenschalen
Kidney bowls
Cuñas
Bassins réniformes
Bacinelle reniformi



07-0936

Dreieckschale
Triangular basin
Cubeta triangulares
Bassin triangulaires
Bacinelle triangolari



07-0938

Dreieckschale
Triangular basin
Cubeta triangulares
Bassin triangulaires
Bacinelle triangolari



07-0942 ø 235 mm
▶ 07-0944 ø 310 mm

Stechbecken, mit Knopfdeckel
Bed pan, lid with knob
Cubetas, tapa con botón
Bassin de lit
Padelle, coperchio con bottone



1/2

07-0952
25 cc

Medizinbecher
 Medicine cup
 Vaso graduado
 Gobelet
 Bicchiere per medicinali



1/2

07-0953
50 cc

Medizinbecher
 Medicine cup
 Vaso graduado
 Gobelet
 Bicchiere per medicinali



1/2

07-0954
20 cc

Medizinlöffel
 Medicine spoon
 Cuchara graduada
 Cuillère pour médicaments
 Cucchiato per medicinali



1/3

07-0957
ø 92 x 87 mm

Sputumbecher
 Sputum cup
 Escupideras
 Crachoir
 Sputacchiera



1/3

07-0958
ø 100 x 60 mm

Zahnprothesenschale
 Bowl for dentures
 Tarro para prótesis dental
 Récipient à prothèses dentaires
 Recipienti per protesi dentarie



1/3

07-0964 ø 100 mm
 ▶ 07-0965 ø 120 mm
 07-0966 ø 150 mm
 07-0967 ø 200 mm
 07-0968 ø 240 mm

Trichter
 Funnels
 Embudos
 Entonnoirs
 Imbuti



1/5

07-0990 1,0 l
 07-0991 1,5 l
 ▶ 07-0992 2,0 l

Irrigatoren
 Irrigators
 Irrigadores
 Irrigateurs
 Irrigatori



1/5

07-1030 0,5 l
 07-1031 1,0 l
 ▶ 07-1032 1,5 l

Messbecher
 Measuring jugs
 Copa graduada
 Gobelets gradués
 Misurino graduato



1/5

07-1034 0,25 l
 07-1035 0,50 l
 07-1036 1,00 l
 ▶ 07-1037 1,50 l
 07-1038 2,00 l

Messbecher
 Measuring jugs
 Copa graduada
 Gobelets gradués
 Misurino graduato



Handwaschbürste
Nailbrush
Cepillo de uñas
Brosse à ongles
Spazzola per unghie

Bürstenspender
Brush Dispensers
Distribuidores de cepillos
Distributeurs de brosses
Distributori di spazzole



1/2

07-2000

Handwaschbürste, über 400 Mal im Autoklaven sterilisierbar
Nailbrush, more than 400 times autoclavable
Cepillo de uñas, esterilizable más de 400 veces en autoclave
Brosse à ongles, stérilisable à l'autoclave 400 fois ou plus
Spazzola per unghie, sterilizzabile più di 400 volte in autoclave



1/4

► 07-2002 260 x 155 x 65 mm

Bürstenspender für 10 Bürsten (ohne Bürsten),
mit Aufhängevorrichtung (07-2003)

Brush dispenser for 10 brushes (without brushes),
with suspension hook (07-2003)

Distribuidor de cepillos para 10 cepillos (sin cepillos),
completo con gancho de suspensión (07-2003)

Distributeur pour 10 brosses (sans brosses),
avec crochet de suspension (07-2003)

Distributore per 10 spazzole (spazzole escluse),
con gancio di sospensione (07-2003)

07-2004 260 x 155 x 65 mm

Bürstenspender für 10 Bürsten (ohne Bürsten),
ohne Aufhängevorrichtung

Brush dispenser for 10 brushes (without brushes),
without suspension hook

Distribuidor de cepillos para 10 cepillos (sin
cepillos), sin gancho de suspensión

Distributeur pour 10 brosses (sans brosses),
sans crochet de suspension

Distributore per 10 spazzole (spazzole escluse),
senza gancio di sospensione



1/4

► 07-2006 270 x 240 x 65 mm

Bürstenspender für 20 Bürsten (ohne Bürsten),
mit Aufhängevorrichtung (07-2007)

Brush dispenser for 20 brushes (without brushes),
with suspension hook (07-2007)

Distribuidor de cepillos para 20 cepillos (sin cepillos),
completo con gancho de suspensión (07-2007)

Distributeur pour 20 brosses (sans brosses),
avec crochet de suspension (07-2007)

Distributore per 20 spazzole (spazzole escluse),
con gancio di sospensione (07-2007)

07-2008 270 x 240 x 65 mm

Bürstenspender für 20 Bürsten (ohne Bürsten),
ohne Aufhängevorrichtung

Brush dispenser for 20 brushes (without brushes),
without suspension hook

Distribuidor de cepillos para 20 cepillos (sin
cepillos), sin gancho de suspensión

Distributeur pour 20 brosses (sans brosses),
sans crochet de suspension

Distributore per 20 spazzole (spazzole escluse),
senza gancio di sospensione



1/4

► 07-2010
205 x 185 x 135 mm

Bürsten-Abwurfbehälter mit Aufhänge-
vorrichtung (07-2011)

Brush collecting container, with suspension
hook (07-2011)

Caja para depositar cepillos, con gancho
de suspensión (07-2011)

Boîte pour déposer des brosses à ongles,
avec crochet de suspension (07-2011)

Contentitore per spazzole usate, con gancio
di sospensione (07-2011)

07-2012
205 x 185 x 135 mm

Bürsten-Abwurfbehälter ohne Aufhänge-
vorrichtung

Brush collecting container, without suspension
hook

Caja para depositar cepillos, sin gancho
de suspensión

Boîte pour déposer des brosses à ongles,
sans crochet de suspension

Contentitore per spazzole usate, senza gancio
di sospensione



1/4

07-2014
250 x 150 x 150 mm

Bürstenablagekorb
Brush collecting basket
Cesta para cepillos
Panier pour brosses
Castello per spazzole



Wasserstrahlreinigungspistole mit Aufsätzen
Water Jet Pistol with Several Tips
Pistola-lavatoria de chorro de agua con varias toberas
Pistolet-laveur à jet d'eau avec plusieurs embouts
Pistola a getto d'acqua con vari raccordi



07-2100

Wasserstrahlreinigungspistole, komplett, bestehend aus:

- 07-2102 1 Wasserstrahlreinigungspistole
- 07-2104 1 Reinigungsaufsatz für Flaschen
- 07-2106 1 Reinigungsaufsatz für RECORD Spritzen-Konen
- 07-2108 1 Reinigungsaufsatz für Katheter
- 07-2110 1 Reinigungsaufsatz für Drainageschläuche
- 07-2112 1 Reinigungsaufsatz für Hohlgefäße (Brause)
- 07-2114 1 Reinigungsaufsatz für Kanülen mit RECORD Konus
- 07-2116 1 Reinigungsaufsatz für Kanülen mit LUER Konus
- 07-2118 1 Reinigungsaufsatz für Meß- und Vollpipetten
- 07-2120 1 Reinigungsaufsatz für feine Pipetten (Ery/Leuco)
- 07-2122 1 Aufsteckleiste
- 07-2124 1 Druckschlauch, 1 m
- 07-2126 1 Schelle
- 07-2128 1 Aufhängehaken für Pistole

1/3

Water jet pistol, complete, consisting of:

- 07-2102 1 Water jet pistol
- 07-2104 1 Cleaning tip for bottles
- 07-2106 1 Cleaning tip for cones of RECORD syringes
- 07-2108 1 Cleaning tip for catheters
- 07-2110 1 Cleaning tip for drainage tubings
- 07-2112 1 Cleaning tip for receptacles (shower)
- 07-2114 1 Cleaning tip for hypodermic needles with RECORD cone
- 07-2116 1 Cleaning tip for hypodermic needles with LUER conus
- 07-2118 1 Cleaning tip for measure and volumetric pipettes
- 07-2120 1 Cleaning tip for fine pipettes (Ery/Leuco)
- 07-2122 1 Storing rack
- 07-2124 1 Pressure tubing, 1 m
- 07-2126 1 Strap
- 07-2128 1 Suspension hook for pistol

Pistola-lavatoria de chorro de agua, completo, compuesto de:

- 07-2102 1 Pistola-lavatoria de chorro de agua
- 07-2104 1 Tobera para botellas
- 07-2106 1 Tobera para conos de jeringas RECORD
- 07-2108 1 Tobera para catéteres
- 07-2110 1 Tobera para tubos de drenaje
- 07-2112 1 Tobera para recipientes (ducha)
- 07-2114 1 Tobera para agujas de inyección con cono RECORD
- 07-2116 1 Tobera para agujas de inyección con cono LUER
- 07-2118 1 Tobera para pipetas de medida y volumétricas
- 07-2120 1 Tobera para pipetas finas (eritrocito/leucocito)
- 07-2122 1 Sujetador
- 07-2124 1 Tubo de presión de 1 m
- 07-2126 1 Abrazadera
- 07-2128 1 Gancho de suspensión para pistola

Pistolet-laveur à jet d'eau, complet, composée de:

- 07-2102 1 Pistolet-laveur à jet d'eau
- 07-2104 1 Embout de rinçage pour bouteilles
- 07-2106 1 Embout de rinçage pour raccords de seringues RECORD
- 07-2108 1 Embout de rinçage pour sondes
- 07-2110 1 Embout de rinçage pour sondes à drainage
- 07-2112 1 Embout de rinçage pour vases (douche)
- 07-2114 1 Embout de rinçage pour aiguilles hypodermiques avec raccord RECORD
- 07-2116 1 Embout de rinçage pour aiguilles hypodermiques avec raccord LUER
- 07-2118 1 Embout de rinçage pour pipettes ordinaires et de précision
- 07-2120 1 Embout de rinçage pour pipettes fines (erythro/leuco)
- 07-2122 1 Support (pour embouts)
- 07-2124 1 Tuyau à haute pression en caoutchouc, 1 m
- 07-2126 1 Agrafe
- 07-2128 1 Crochet de suspension

Pistola a getto d'acqua, completa, composta da:

- 07-2102 1 Pistola a getto d'acqua
- 07-2104 1 Raccordo di lavaggio per bottiglie
- 07-2106 1 Raccordo di lavaggio per coni di siringhe RECORD
- 07-2108 1 Raccordo di lavaggio per cateteri
- 07-2110 1 Raccordo di lavaggio per tubi di drenaggio
- 07-2112 1 Raccordo di lavaggio per recipienti (doccia)
- 07-2114 1 Raccordo di lavaggio per aghi ipodermici con cono RECORD
- 07-2116 1 Raccordo di lavaggio per aghi ipodermici con cono LUER
- 07-2118 1 Raccordo di lavaggio per pipette comuni e graduate
- 07-2120 1 Raccordo di lavaggio per pipette fini (eritro/leuco)
- 07-2122 1 Rastrelliera
- 07-2124 1 Tubo ad alta pressione, 1 m
- 07-2126 1 Graffa
- 07-2128 1 Gancio di sospensione per pistola

Aufsätze für Wasserstrahlreinigungspistole
 Tips for Water Jet Pistol
 Toberas para pistola-lavatoria de chorro de agua
 Embouts pour pistolet-laveur à jet d'eau
 Raccordi per pistola a getto d'acqua



07-2104

Reinigungsaufsatz für Flaschen
 Cleaning tip for bottles
 Tobera para botellas
 Embout de rinçage pour bouteilles
 Raccordo di lavaggio per bottiglie



07-2106

Reinigungsaufsatz für RECORD Spritzen-Konen
 Cleaning tip for cones of RECORD syringes
 Tobera para conos de jeringas RECORD
 Embout de rinçage pour raccords de seringues RECORD
 Raccordo di lavaggio per coni di siringhe RECORD



07-2108

Reinigungsaufsatz für Katheter
 Cleaning tip for catheters
 Tobera para catéteres
 Embout de rinçage pour sondes
 Raccordo di lavaggio per cateteri



07-2110

Reinigungsaufsatz für Drainageschläuche
 Cleaning tip for drainage tubings
 Tobera para tubos de drenaje
 Embout de rinçage pour sondes à drainage
 Raccordo di lavaggio per tubi di drenaggio



07-2112

Reinigungsaufsatz für Hohlgefäße (Brause)
 Cleaning tip for receptacles (shower)
 Tobera para recipientes (ducha)
 Embout de rinçage pour vases (douche)
 Raccordo di lavaggio per recipienti (doccia)



07-2114

Reinigungsaufsatz für Kanülen mit RECORD Konus
 Cleaning tip for hypodermic needles with RECORD cone
 Tobera para agujas de inyección con cono RECORD
 Embout de rinçage pour aiguilles hypodermiques avec raccord RECORD
 Raccordo di lavaggio per aghi ipodermici con cono RECORD



07-2116

Reinigungsaufsatz für Kanülen mit LUER Konus
 Cleaning tip for hypodermic needles with LUER cone
 Tobera para agujas de inyección con cono LUER
 Embout de rinçage pour aiguilles hypodermiques avec raccord LUER
 Raccordo di lavaggio per aghi ipodermici con cono LUER



07-2118

Reinigungsaufsatz für Meß- und Vollpipetten
 Cleaning tip for measure and volumetric pipettes
 Tobera para pipetas de medida y volumétricas
 Embout de rinçage pour pipettes ordinaires et de précision
 Raccordo di lavaggio per pipette comuni e graduate



07-2120

Reinigungsaufsatz für feine Pipetten (Ery/Leuco)
 Cleaning tip for fine pipettes (Ery/Leuco)
 Tobera para pipetas finas (eritrocito/leucocito)
 Embout de rinçage pour pipettes fines (erythro/leuco)
 Raccordo di lavaggio per pipette fini (eritro/leuco)

07-2130
 31 cm, 12 1/4"



Reinigungsaufsatz, gerade
 Cleaning tip, straight
 Tobera de limpieza, recta
 Embout de rinçage, droit
 Raccordo di lavaggio, retto

07-2132
 30 cm, 12"



Reinigungsaufsatz, aufgebogen
 Cleaning tip, curved
 Tobera de limpieza, curva
 Embout de rinçage, courbe
 Raccordo di lavaggio, curvo









07-2134

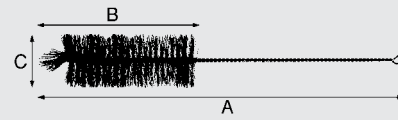



Überwurfmutter zum Anschluß an Gewindehähne,
 1/2 Zoll
 Coupling for connection to water tap, 1/2 inch
 Tuercas-hembras para conexión al grifo de agua,
 1/2 pulgada
 Ecrous-raccord pour la connexion aux robinets à filet
 Raccordi per connessione ai rubinetti filettati



Reinigungsbürsten
 Cleaning Brushes
 Cepillos de limpieza
 Ecouillons
 Spazzole per pulizia



					
	07-2020	07-2022	07-2024	07-2026	07-2028
A	215 mm	215 mm	215 mm	215 mm	215 mm
B	60 mm	65 mm	95 mm	95 mm	100 mm
C	13 mm	15 mm	20 mm	25 mm	28 mm

					
	07-2030	07-2032	07-2034	07-2036	07-2038
A	265 mm	430 mm	285 mm	265 mm	330 mm
B	65 mm	65 mm	75 mm	65 mm	130 mm
C	3 mm	3 mm	7 mm	8 mm	50 mm



1/2

07-2150
 13,5 cm, 5 1/4"

Schreib- und Markierungsstift mit Schraubkappe, auswechselbarem, beidseitig spitzem Hartmetallstift (07-2151)

Writing and marking pencil with screw cap, interchangeable writing pin of hard metal (07-2151)

Lápiz para marcar y escribir con tuerca tapón, punta de carburo tungsteno intercambiable (07-2151)

Crayon pour marquer et écrire, avec écrou-chapeau et pointe en métal dur interchangeable (07-2151)

Lapis per marcare e scrivere con coperchio a vite, e punta di metallo duro intercambiabile (07-2151)



1/2

07-2152
 14 cm, 5 1/2"

Schreib- und Markierungsstift mit Hartmetallstift (07-2153)

Writing and marking pencil with hard metal pin (07-2153)

Lápiz para marcar y escribir con punta de carburo tungsteno (07-2153)

Crayon pour marquer et écrire et pointe en métal dur (07-2153)

Lapis per marcare e scrivere e punta di metallo duro (07-2153)



1/2

07-2154
 14 cm, 5 1/2"

Schreib- und Markierungsstift mit Hartmetallstift (07-2153) und Lupe

Writing and marking pencil with hard metal pin (07-2153) and magnifying glass

Lápiz para marcar y escribir con punta de carburo tungsteno (07-2153) y lupa

Crayon pour marquer et écrire et pointe en métal dur (07-2153) et loupe

Lapis per marcare e scrivere, punta di metallo duro (07-2153) e lente d'ingrandimento



1/2

07-2156
 220 V / 50 Hz

Elektrisches Schreib- und Markierungsgerät mit Netzanschlusskabel und auswechselbarem Hartmetallstift (07-2153), mit Druckknopfschalter, Gewicht ca. 350 g

Electric writing and marking apparatus with connection cable and interchangeable hard metal pin (07-2153), with push-button switch, weight 350 g approx.

Aparato eléctrico para marcar y escribir, con cable de conexión y punta de carburo tungsteno intercambiable (07-2153), con interruptor de botón, peso 350 g

Appareil électrique pour marquer et écrire, avec câble de connexion et pointe en métal dur interchangeable (07-2153), avec interrupteur à bouton de pression, poids 350 grs. approx.

Apparecchio elettrico per marcare e scrivere, con cavo di connessione e punta di metallo duro intercambiabile, con interruttore a bottone (07-2153), peso 350 g ca.



Notizen

Notes

Notas

Notes

Note

A

Abfallzange 735
 Abnehmezangen für Klammern 691
 Abortusküretten 484
 Abortuslöffel 484
 Abortuszangen 482-483
ABRAMS Kanüle zur Brustfellpunktion 329, 518
 Absaugküretten 471
 Absaugrohr-Mikro 321
ADAIR-ALLIS Darm- und Gewebefäßzange 384
ADAIR Hakenzange 452
ADAMS-MAYO Appendektomie-Wundspreizer 284
ADLERKREUTZ Gefäß- und Tumorzangen 148
 Adnexscheren DURACUT 54
ADSON-ANDERSON Wundspreizer 276
ADSON-BABY Präparier- und Ligaturklammern 180
ADSON-BECKMANN Laminektomie-Wundspreizer 279
ADSON-BROWN Feine chirurgische Pinzetten 141
ADSON-BROWN TITE GRIP Chirurgische Pinzette 117
ADSON-MICRO Feine anatomische Pinzetten 129
ADSON-MICRO Feine chirurgische Pinzetten 140-141
ADSON-MICRO TITE GRIP Chirurgische Pinzetten 117
ADSON-TOENNIS DURACUT Präparierscheren 49
ADSON-TOENNIS Präparierscheren 89
ADSON Bohrer 652
ADSON Bohrerführungs- und Dura-Schutzzange 650
ADSON Feine anatomische Pinzetten 129
ADSON Feine Arterienklammern 169
ADSON Feine chirurgische Pinzetten 140-141
ADSON Hemilaminektomie-Wundspreizer 277
ADSON Laminektomie-Wundspreizer 276, 280
ADSON Nadelhalter 367
ADSON Nerv- und Gefäßhaken 215
ADSON Raspatorien 586
ADSON Saugkanülen 323
ADSON TITE GRIP Anatomische Pinzetten 113
ADSON TITE GRIP Chirurgische Pinzetten 117
ADSON Wundspreizer 273, 278
ALAN-PARK Analspreizer 408
ALDERDYCE Dissektor 574
ALDINGER-HOHMANN Knochenheber 580
ALEXANDER-FARABEUF Rippenraspatorien 497
ALEXANDER Flachmeißel 609
ALEXANDER Hohlmeißel 609
ALEXANDER Osteotome 609
ALEXANDER Uterus-Biopsiezange 463
 Algesimeter 4
ALLEN Darmklammern 390
ALLIS-ADAIR Darm- und Gewebefäßzange 384
ALLIS-BABY Darm- und Gewebefäßzangen 383
ALLIS-BOYS Darm- und Gewebefäßzange 384
ALLIS-JUDD Darm- und Gewebefäßzangen 384
ALLIS-OCHSNER Darm- und Gewebefäßzange 383
ALLIS-THOMS Darm- und Gewebefäßzange 385
ALLIS ATRAUMATIC-GRIP Darm- und Gewebefäßzangen 389
ALLIS Darm- und Gewebefäßzangen 383-385
ALLISON Lungenspatel 260
ALM Wundspreizer 270
ALY Algesimeter 4
AMANN Tamponadeführer 447
 Amnioskop-Tuben 472
 Amniotom 477
 Amputationsmesser 38-39
 Amputationsretraktoren 571
 Amputationssägen 572-573
 Analsonden 409
 Analspreizer 407-408
 Anastomosen- (Vena Cava) Klammern 565
 Anastomosenklammern 400-402
 Anastomosenklammern ATRAUMATIC-GRIP 400-401, 520-523, 542-544, 559-560
 Anatomische Pinzetten 132-134
 Anatomische Pinzetten fein 128-131
 Anatomische Pinzetten TITE GRIP 113-115
ANDERSON-ADSON Wundspreizer 276
ANDREW-PYNCHON Saugrohr 325
 Anlegepinzetten für Gefäßclips 154, 156

Anlegezange für Approximatoren 158
 Anlegezange für Bulldogklammern 527
 Anlegezange für Gefäßclips 155
 Anlegezange für TITAN-LINE Bulldogklammern 160
 Anlegezangen für Klammern 690-691
 Anuskope 407
 Aorta-Anastomosenklammern ATRAUMATIC-GRIP 548-549
 Aorta-Aneurysmaklammern ATRAUMATIC-GRIP 545-547, 561
 Aorta-Dilatatoren 511
 Aortaklammern ATRAUMATIC-GRIP 537-540, 561
 Appendektomie-Wundspreizer 284
 Appendektomieklammer 403
 Approximatoren 157-159
ARMYTAGE-GREEN Uterusklemmzange 481
 Arterienklammern 173-179
 Arterienklammern ATRAUMATIC-GRIP 176
 Arterienklammern ATRAUMATIC-GRIP fein 165, 167
 Arterienklammern fein 164-172
 Arterienklammern TITAN-LINE fein 164, 166, 168
 Arteriometerschere 95
ARTHUR Splitterzange 151
 Ästhesiometer 4
 ATRAUMATIC-GRIP Anastomosenklammern 400-401, 520-523, 542-544, 559-560
 ATRAUMATIC-GRIP Aorta-Aneurysmaklammern 545-547, 561
 ATRAUMATIC-GRIP Aorta-Anastomosenklammern 548-549
 ATRAUMATIC-GRIP Aortaklammern 537-540, 561
 ATRAUMATIC-GRIP Arterienklammern 176
 ATRAUMATIC-GRIP Bronchusklammern 552
 ATRAUMATIC-GRIP Bulldogklammern 525-528, 556
 ATRAUMATIC-GRIP Coarctationsklammern 532-533, 557
 ATRAUMATIC-GRIP Darmfäßzangen 389
 ATRAUMATIC-GRIP Darmklammern 391-393, 395-396
 ATRAUMATIC-GRIP Feine Arterienklammern 165, 167
 ATRAUMATIC-GRIP Gefäßklammern 520-523, 529-530, 534, 537, 541, 555-556, 558, 561-562
 ATRAUMATIC-GRIP Gefäßpinzetten 135
 ATRAUMATIC-GRIP Gewebefäßzangen 389
 ATRAUMATIC-GRIP Hysterektomieklammern 197
 ATRAUMATIC-GRIP Iliaca Klammern 558
 ATRAUMATIC-GRIP Karotis-Klammern 524, 527, 537
 ATRAUMATIC-GRIP Ligaturklammern 186, 551
 ATRAUMATIC-GRIP Magenklammern 397
 ATRAUMATIC-GRIP Mehrzweckklammern 520-523, 530, 553-554, 556, 562
 ATRAUMATIC-GRIP Nierenarterienklammern 537, 558
 ATRAUMATIC-GRIP Nierenklammern 190
 ATRAUMATIC-GRIP Obere Verschlussklammer 398
 ATRAUMATIC-GRIP Parametriumklammern 197
 ATRAUMATIC-GRIP Patent-Ductusklammern 531, 556
 ATRAUMATIC-GRIP Peripheralklammern 534-536, 558
 ATRAUMATIC-GRIP Präparierklammern 186, 551
 ATRAUMATIC-GRIP Profundaklammern 534
 ATRAUMATIC-GRIP Rektumklammern 400-401
 ATRAUMATIC-GRIP Untere Verschlussklammern 399
 ATRAUMATIC-GRIP Vena-Cava-Klammern 550
 Atriumhaken 509
AUFRICHT Raspeln 593
AUFRICHT Scheren für plastische Chirurgie 82
 Augennadeln 354
 Aurikelklammern 564
AUSTIN Mikro-Knüpppinzetten 122
AUVARD-BERLIND Scheidenspekulum 441
AUVARD Scheidenspekula 441

B

BABCOCK ATRAUMATIC-GRIP Darm- und Gewebefäßzangen 389
BABCOCK Darm- und Gewebefäßzangen 385
BABCOCK TITE GRIP Darm- und Gewebefäßzangen 388
BABY-ADSON Präparier- und Ligaturklammern 180
BABY-ALLIS Darm- und Gewebefäßzangen 383
BABY-BAILEY Rippenkontraktor 508
BABY-BALFOUR Bauchdeckenhalter 300
BABY-COLLIN Bauchdeckenhalter 297
BABY-CRILE Feine Arterienklammern 166
BABY-DOYEN ATRAUMATIC-GRIP Darmklammern 391
BABY-DOYEN Darmklammern 391

BABY-FINOCHIETTO Rippensperrerr	503
BABY-GELPI Vulva-Spreizer	281
BABY-GILLIES Nadelhalter	370
BABY-GILLIES TITE GRIP Nadelhalter	348
BABY-GOSSET Bauchdeckenhalter	299
BABY-HAIGHT-FINOCHIETTO Rippensperrerr aus ALUMINIUM	501
BABY-KELLY Feine Arterienklemmen	168
BABY-KOCHER ATRAUMATIC-GRIP Darmklemmen	391
BABY-KOCHER Darmklemmen	391
BABY-LEXER Präparierscheren	87
BABY-MEEKER Präparier- und Ligaturklemmen	180
BABY-METZENBAUM Präparierscheren	89
BABY-MIKULICZ Peritoneumklemme	192
BABY-MIXTER Präparier- und Ligaturklemmen	180
BABY-MOSQUITO (HARTMANN) Feine Arterienklemmen	164
BABY-OLSEN-HEGAR TITE GRIP Nadelhalter	348
BABY-OVERHOLT Präparier- und Ligaturklemme	183
BABY-PAYR Darm- und Magenquetschklemme	403
BABY-ROUX Wundhaken	228
BABY-SATINSKY Anastomosen- (Vena Cava) Klemme	565
BABY-TISCHLER Uterus-Biopsiezange	464
BACKHAUS Tuchklemmen	201
BADGLEY Laminektomie-Spreizer	286
BAHNSON-DE BAKEY ATRAUMATIC-GRIP Aorta-Aneurysmaklemmen	545
BAILEY-BABY Rippenkontraktor	508
BAILEY-GIBBON Rippenkontraktor	508
BAILEY (DE MARTEL) Einführungsinstrument für Drahtsägen	687
BAILEY ATRAUMATIC-GRIP Aortaklemmen	538
BAILEY Rippenkontraktor	508
BAINBRIDGE-DE BAKEY ATRAUMATIC-GRIP Gefäßklemmen	530
BAINBRIDGE Darmklemmen	390
BAKES Gallengang-Dilatationsolive	416
BALFOUR-BABY Bauchdeckenhalter	300
BALFOUR-KIRSCHNER Valven für Bauchdeckenhalter	307
BALFOUR Bauchdeckenhalter	300-303
BALFOUR Valven für Bauchdeckenhalter	303
BALLENGER-FOERSTER Tupfer- und Schwammzangen	209
BALLENTINE-HEANEY Hysterektomieklammer	196
BALLENTINE Hysterektomieklammer	196
BARNES Saugkanüle	321
BARR Analspreizer	408
BARRAQUER-TROUTMAN Mikro-Nadelhalter	360
BARRAQUER Cilienpinzette	152
BARRAQUER Mikro-Nadelhalter	360
BARRAYA-STILLE Gefäß- und Tumorzangen	148
BARRETT Hakenzange	452
BARTH Scharfer Löffel	599
Bauchdeckenhaken	309, 248-249
Bauchdeckenhalter	297-309
Bauchdeckenscheren	106
Bauchspatel	266-267
BAUMGARTNER-HEGAR TITE GRIP Nadelhalter	342
BAUMGARTNER Nadelhalter	366
BAUMGARTNER TITE GRIP Nadelhalter	342
BEACHAM Amniotom	477
BECK-COOLEY ATRAUMATIC-GRIP Anastomosenklemmen	560
BECK-DE BAKEY ATRAUMATIC-GRIP Anastomosenklemmen	543
BECK-DE BAKEY ATRAUMATIC-GRIP Aortaklemmen	537
BECK-DE BAKEY ATRAUMATIC-GRIP Vena-Cava-Klemmen	550
Becken, Stech-	750
Beckenzirkel	477
BECKMANN-ADSON Laminektomie-Wundspreizer	279
BECKMANN-EATON Laminektomie-Wundspreizer	280
BECKMANN Laminektomie-Wundspreizer	280
BEEBEE Drahtscheren	665
BEER Cilienpinzette	152
Behälter, Bereitschafts-	738
Behälter, Sterilisier-	738-742
Beinhautmesser	39
BELMONT-RUMEL Tourniquets	518
BENGOLEA Feine Arterienklemmen	172
BENNETT Knochenheber	581
BENSON Pyloruspreizer	403
Bereitschaftsbehälter	738
Bereitstellungsbecher	737
BERGER Binokulare Kopflupen	8
BERGER Uterus-Biopsiezangen	462
BERGMANN Hämmer	621
BERGMANN Kleiderstoff- und Gipscheren	675
BERLIND-AUVAUD Scheidenspekulum	441
BERLINER Perkussionshammer	2
BERNHARD Tuchklemme	201
Beschneidungs-Instrumente	426
BETHUNE Rippenschere	493
BEYER Hohlmeißelzangen	632-633
BEYER Laminektomie-Stanzen	707
BIEMER-MÜLLER Approximatoren	157
BIEMER Gefäßclips	156
BIEMER Venenschere	63
BIER Amputations- und Resektionssäge	573
BILL Zughebel für Geburtszangen	479
Binde, Stau-	570
Binokulare Kopflupen	8-9
Binokulare Lupenbrille	9
Biopsieinstrumentarium für Wirbelkörper	720-721
Biopsiekanülen	329, 518
Biopsieküretten	459-460
Biopsiezangen, Mastdarm-	412
Biopsiezangen, Uterus-	460-465
BIRCHER-GANSKE Meniskus- und Knorpelfaßzangen	640
BIRCHER Meniskussmesser	643
BLAKE-MAYO Gallensteinzangen	418
BLAKE Gallensteinzangen	418
BLAKE Uteruskürette	466
BLAKESLEY-WEIL Laminektomie-Zangen	714
Blasenhalsspreizer	423
Blasenspatel	268
Blasensprenger	477
Blasenspritzen	331
Blasenwundspreizer	310
Bleihände	644
BLESSING DURACUT Schere für Rektumchirurgie	59
BLOUNT Hüfthebel	580
BLOUNT Wund- und Meniskushaken	641
BLUMENTHAL Hohlmeißelzangen	631
BLUNT Sterilisierklammer	736
BOETTCHER Tonsillenschere	103
BÖHLER (WALTON-LISTON) Knochensplitterzangen	638
BÖHLER Extensionsbügel	654
BÖHLER Hohlmeißelzangen	633
Bohrapparate, Hand-	651-653
Bohrdrähte	655
Bohrdrahtspender	656
Bohrdrahtspender-Mehrfach	657
Bohrer	652
Bohrer, Nagel-	645
Bohrerführungsinstrument	650
Bolzenschneider	668
BONN MOD. Feine chirurgische Pinzetten	138
BONNEY Anatomische Pinzette	134
BONNEY Chirurgische Pinzetten	147
BONNEY TITE GRIP Anatomische Pinzette	115
BONNEY TITE GRIP Chirurgische Pinzette	118
BOSE Trachealhäkchen	728
Bougies, Dilatations-	424
BOYS-ALLIS Darm- und Gewebefaßzange	384
BOZEMANN-DOUGLAS Tamponzangen	208
BOZEMANN (WERTHEIM) TITE GRIP Nadelhalter	346
BOZEMANN Tamponzangen	208
BRAND Sehnenführungszangen	648
BRAUN-SIMPSON Geburtszangen	478
BRAUN-STADLER Damm- (Episiotomie-) Scheren	107
BRAUN Dekapitationshaken	485
BRAUN Hakenzangen	452, 454
BRAUN Kranioklast	485
BRAUN Uterus-Depressor	447
BRAWLEY Raspel	593
BREISKY Scheidenspekula	438, 440
BRIDGE Präparier- und Ligaturklemme	187
BRINKERHOFF Mastdarm-Rektum-Spekula	406
Bronchusklemmen	566
Bronchusklemmen ATRAUMATIC-GRIP	552
BROPHY (SULLIVAN) Feine Präparierscheren	93
BROPHY Feine anatomische Pinzetten	130
BROPHY Feine chirurgische Pinzetten	143
BROWN-ADSON Feine chirurgische Pinzetten	141
BROWN-ADSON TITE GRIP chirurgische Pinzette	117
BROWN Gewebefaßpinzetten	148

BROWN Nadelhalter	366
BROWNE-DENIS Bauchdeckenhalter	305
BRUENINGS Zungenspatel	12
BRUNNER Rektum-Anastomosenklemme	400
BRUNNER Wundhaken	252-253
BRUNS DURACUT Gipsschere	676
BRUNS Gipsscheren	676
BRUNS Scharfe Löffel	602-603
BUCHWALD Zungenspatel	12
BUCK-GRAMCKO Knochenheber	576
BUCK Perkussionshammer	3
BUELAU Trokar	318
BUIE-SMITH Analspreizer	408
BUIE Druckklemme	409
Bulbus-Haken	422
Bulldogklemmen	163
Bulldogklemmen ATRAUMATIC-GRIP	525-528, 556
Bulldogklemmen aus TITAN	160-161
Bulldogklemmen Mikro	162
Bumerang-Nadelhalter	372
BUMM Plazentar- und Abortusküretten	484
BUMM Uterusküretten	470
BUNNELL Handbohrapparat	653
BUNNELL Sehnenführer	646
BUNNELL Sehnenschäler	646
BURFORD-FINOCCHIETTO Rippensperrer	503
BURFORD-FINOCCHIETTO Rippensperrer aus ALUMINIUM	502
BURKE Uterus-Biopsiezange	464
Bürsten, Handwasch-	752
Bürsten, Reinigungs-	756
Bürstenablagekörbe	753
Bürstspender	752
BUSH Nabelschnurscheren	108

C

CALNE ATRAUMATIC-GRIP Vena-Cava-Klemme	550
CANAD. MODELL Meniskusmesser	643
CANNON Endarterektomie-Satz	515
CANNON Endarterektomiestripper	514
CANNON Intima-Messer	513
CANNON Intima-Spatel	513
CAPLAN DURACUT Septumschere	59
CARMALT-ROCHESTER Arterienklemmen	178
CAROTIS-DE BAKEY ATRAUMATIC-GRIP Bulldogklemmen	525
Carpal- Tunnel-Wundspreizer	271
CARROLL Nadelhalter	366
CARROLL Sehnenführungsange	648
CARROLL TITE GRIP Nadelhalter	344
CASPAR Explorations- und Koagulationshäkchen	215
CASPAR Laminektomie-Zangen	718-719
CASPAR Raspatorien	585
CASPAR Spekula für lumbale Bandscheibenoperationen	295
CASPAR Wundhaken	245
CASPAR Wundspreizer für die Wirbelsäule	288, 290-292, 294
CASTANEDA ATRAUMATIC-GRIP Anastomosenklemmen	520
CASTANEDA ATRAUMATIC-GRIP Mehrzweckklemmen	520
CASTANEDA Rippensperrer aus ALUMINIUM	500
CASTROVIEJO-MICRO Nadelhalter	358
CASTROVIEJO Feine chirurgische Pinzetten	138
CASTROVIEJO Nadelhalter	363
CASTROVIEJO Rasierklingen-Halter und -Brecher	36
CASTROVIEJO TITE GRIP Mikro-Nadelhalter	338-339
CASTROVIEJO Zirkel	7
Catgut	353
CATLIN Amputationsmesser	38
Cerclage-Drähte	660
Cerclage-Instrumente	660
CHAMPY Knochenbiopsie-Instrumente	669
CHAPUT Darm- und Gewebefäßzange	383
CHARRIERE Amputations- und Resektionssägen	572-573
CHEATTLE Sterilisierzangen	734
CHERON Korn- und Tupferzange	207
CHEVALIER-JACKSON Trachealkanülen	726
CHEVALIER Rippensperrer	507
CHEYNE-WATSON Dissektor	574
CHILDE Wundnahtpinzette	378
Chirurgische Nähnadeln	354-356

Chirurgische Pinzetten	144-148
Chirurgische Pinzetten fein	138-143
Chirurgische Pinzetten TITE GRIP	117-118
Chirurgische Scheren	71-83
Chirurgische Scheren DURACUT	46
Chirurgische Scheren fein	68-70
Choanenhaken	221
Cilienpinzetten	152
Circumcisions-Instrumente	426
CITELLI Laminektomie-Stanze	707
CLAR Stirnlampe	11
CLEVELAND Knochensplitterzangen	637
CLOWARD Wirbelkörperspreizer	296
CLOWARD Wundspreizer für die Wirbelsäule	285
COAKLEY Kieferhöhlentroker	319
Coarctationsklemmen ATRAUMATIC-GRIP	532-533, 557
COBB Raspatorien	589
COBB Raspatorien mit Ferrozellgriff	591
COBB Spinal-Hohlmeißel mit Ferrozellgriff	616
COLCLOUGH (LOVE-KERRISON) Laminektomie-Stanzen	710-711
COLLER-CRILE Feine Arterienklemmen	167
COLLIER Nadelhalter	363
COLLIN-BABY Bauchdeckenhalter	297
COLLIN-DUVAL Darm- und Gewebefäßzangen	386
COLLIN-DUVAL Darmpinzette	149
COLLIN-FARABEUF Raspatorien	588
COLLIN-HARTMANN Wundhaken	229
COLLIN-LANDAU Scheidenspekula	431
COLLIN ATRAUMATIC-GRIP Darm- und Gewebefäßzangen	389
COLLIN Bauchdeckenhalter	297-298
COLLIN Darm- und Gewebefäßzange	386
COLLIN Dynamometer	6
COLLIN Hammer	617
COLLIN Klammerentfernungszange	379
COLLIN Korn- und Tupferzange	207
COLLIN Nabelschnurklemme	486
COLLIN Scheidenspekula	431
COLLIN Uterusfaßzange	458
COLLIN Wundhaken	227
COLLIN Zungenzange	23
CONE Schädelstanzzange	688
CONTOUR SCALP Wundspreizer	276
CONVERSE (GILLIES) Hauthäkchen	216
CONVERSE TITE GRIP Nadelhalter	342
COOLEY-BECK ATRAUMATIC-GRIP Anastomosenklemmen	560
COOLEY-DERRA ATRAUMATIC-GRIP Anastomosenklemmen	559
COOLEY-REYNOLDS ATRAUMATIC-GRIP Anastomosenklemmen	559
COOLEY Aorta-Dilatator	511
COOLEY ATRAUMATIC-GRIP Anastomosenklemmen	560
COOLEY ATRAUMATIC-GRIP Aorta-Aneurysmaklemme	561
COOLEY ATRAUMATIC-GRIP Aortaklemme	561
COOLEY ATRAUMATIC-GRIP Bulldogklemmen	556
COOLEY ATRAUMATIC-GRIP Coarctationsklemmen	557
COOLEY ATRAUMATIC-GRIP Gefäßklemmen	555-556, 562
COOLEY ATRAUMATIC-GRIP Iliaca-Klemmen	558
COOLEY ATRAUMATIC-GRIP Mehrzweckklemmen	556, 562
COOLEY ATRAUMATIC-GRIP Nierenarterienklemmen	558
COOLEY ATRAUMATIC-GRIP Patent-Ductusklemmen	556
COOLEY ATRAUMATIC-GRIP Peripheralklemmen	558
COOLEY Atriumhaken	509
COOLEY Gefäßdilatoren	510
COOLEY Saugrohre	327
COOLEY Sternotomie-Sperrer	499
COOLEY Sternotomie-Sperrer aus ALUMINIUM	498
COOPER Unterbindungsnadel	374
Coronararterien-Schere	95
CORWIN-HEGAR TITE GRIP Drahtspannzange	662
CORYLLOS Wundhaken und Lungenspatel	261
COTTLE-NEIVERT Nasenflügelhaken	221
COTTLE Dura- und Hauthäkchen	217
COTTLE DURACUT Nasenscheren	58
COTTLE Häkchen für plastische Chirurgie	218
COTTLE Hammer	620
COTTLE Nasenscheren	102
COTTLE Osteotome	608
COTTLE Raspatorien	583, 585
COTTLE Raspel	593
CRAFOORD-DE BAKEY ATRAUMATIC-GRIP Aorta-Aneurysmaklemmen	546

CRAFOORD-STILLE Feine Arterienklemmen	170
CRAFOORD (STELZNER) Lungenlappen- und Rektumschere	99
CRAFOORD Aurikelklemmen	564
CRAFOORD Feine Arterienklemme	171
CRAIG-KOGLER Wirbelkörper-Biopsieinstrumentarium	720-721
CRILE-BABY Feine Arterienklemmen	166
CRILE-COLLER Feine Arterienklemmen	167
CRILE-MICRO Feine Arterienklemmen	166
CRILE-MURRAY Nadelhalter	366
CRILE-RANKIN-DE BAKEY ATRAUMATIC-GRIP Feine Arterienklemmen	167
CRILE-RANKIN (OCHSNER-DIXON) Feine Arterienklemmen	167
CRILE-RANKIN Feine Arterienklemmen	167
CRILE-WOOD Nadelhalter	366, 368
CRILE-WOOD TITE GRIP Nadelhalter	343
CRILE-WOOD TITE GRIP Nadelhalter für Linkshänder	341
CRILE Feine Arterienklemmen	166
CRILE Nadelhalter	371
CRILE Nerv- und Gefäßhäkchen	214
CRILE TITAN-LINE Feine Arterienklemmen	166
CRILE Wundhaken	227
CRUTCHFIELD Schädelhalter	689
CRUTCHFIELD Vorbohrer für Schädelhalter	689
CULLEN-WERTHEIM Nierenstielklemme	191
CURTIS Chirurgische Pinzette	147
CUSCO Scheidenspekula	430-431
CUSHING-FERRIS-SMITH Laminektomie-Zangen	713
CUSHING-LANDOLT Spekula für trans-sphenoidale Hypophysektomie	692
CUSHING-TAYLOR Feine anatomische Pinzetten	130
CUSHING-TAYLOR Feine chirurgische Pinzetten	143
CUSHING-TAYLOR Ohr- und Nasenpinzetten	136
CUSHING-TAYLOR TITE GRIP Anatomische Pinzette	114
CUSHING Bohrer	652
CUSHING Dekompressionshaken	701
CUSHING Durahäkchen	218
CUSHING Feine anatomische Pinzetten	130
CUSHING Feine chirurgische Pinzetten	142
CUSHING Hirnspatel	706
CUSHING Laminektomie-Zangen	715
CUSHING Nerv- und Gefäßhäkchen	214
CUSHING TITE GRIP Anatomische Pinzetten	114
CUSHING Venenhaken	222-223
CUZZI Plazentar- und Abortuslöffel	484
CZERNY Hakenzange	455
CZERNY Mastdarm-Rektum-Spekulum	405

D

DAHLGREN Schädelstanze	688
DALE ATRAUMATIC-GRIP Peripheralklemmen	535
Damm- (Episiotomie-) Scheren	107
Damm- (Episiotomie-) Scheren DURACUT	60
DANDY Feine Arterienklemmen	165
DANDY Nerv- und Gefäßhäkchen	214
DARDIK ATRAUMATIC-GRIP Mehrzweckklemmen	554
Darm- und Magen-Nähapparat	404
Darmfaßzangen	383-388
Darmfaßzangen ATRAUMATIC-GRIP	389
Darmfaßzangen TITE GRIP	388
Darmklemmen	390-396, 403
Darmklemmen ATRAUMATIC-GRIP	391-393, 395-396
Darmnadeln	354
Darmpinzette	149
Darmscheren	109
Darmspatel	266-267
DARTIGUES Nierenfaßzange	421
DAUBENSPECK Scharfer Löffel	604
DAVIDSON Scapula-Haken	260
DAVIS-RAGNELL Haken für plastische Chirurgie	226
DAVIS Hirnspatel	706
DAY Ohrhäkchen	213
DE BAKEY-BAHNSON ATRAUMATIC-GRIP Aorta-Aneurysmaklemmen	545
DE BAKEY-BAINBRIDGE ATRAUMATIC-GRIP Gefäßklemmen	530
DE BAKEY-BECK ATRAUMATIC-GRIP Anastomosenklemmen	543
DE BAKEY-BECK ATRAUMATIC-GRIP Aortaklemmen	537
DE BAKEY-BECK ATRAUMATIC-GRIP Vena-Cava-Klemmen	550
DE BAKEY-CAROTIS ATRAUMATIC-GRIP Bulldogklemmen	525
DE BAKEY-CRAFOORD ATRAUMATIC-GRIP Aorta-Aneurysmaklemmen	546

DE BAKEY-CRILE-RANKIN ATRAUMATIC-GRIP Feine Arterienklemmen	167
DE BAKEY-DERRA ATRAUMATIC-GRIP Anastomosenklemmen	542
DE BAKEY-DIETRICH ATRAUMATIC-GRIP Bulldogklemmen	526
DE BAKEY-GLOVER ATRAUMATIC-GRIP Bulldogklemmen	525
DE BAKEY-GUYON ATRAUMATIC-GRIP Nierenklemmen	190
DE BAKEY-HALSTED-MOSQUITO ATRAUMATIC-GRIP Feine Arterienklemmen	165
DE BAKEY-HARKEN ATRAUMATIC-GRIP Präparier- und Ligaturklemmen	551
DE BAKEY-HEANEY (ROGERS) ATRAUMATIC-GRIP Hysterektomieklammern	197
DE BAKEY-MORRIS ATRAUMATIC-GRIP Aortaklemmen	540
DE BAKEY-PEAN ATRAUMATIC-GRIP Arterienklemmen	176
DE BAKEY-PEAN ATRAUMATIC-GRIP Gefäßklemmen	529
DE BAKEY-POTTS ATRAUMATIC-GRIP Patent-Ductusklemmen	531
DE BAKEY-REYNOLDS ATRAUMATIC-GRIP Anastomosenklemmen	542
DE BAKEY-RUMEL ATRAUMATIC-GRIP Präparier- und Ligaturklemmen	186
DE BAKEY-RUMEL Präparier- und Ligaturklemmen	186
DE BAKEY-SATINSKY ATRAUMATIC-GRIP Bulldogklemmen	525
DE BAKEY-SATINSKY ATRAUMATIC-GRIP Gefäßklemmen	541
DE BAKEY-WERTHEIM (ROGERS) ATRAUMATIC-GRIP Parametriumklemmen	197
DE BAKEY (GARRETT) Gefäßdilatoren	510
DE BAKEY Arteriotomieschere	95
DE BAKEY ATRAUMATIC-GRIP Anastomosenklemmen	543
DE BAKEY ATRAUMATIC-GRIP Aorta-Aneurysmaklemmen	545-547
DE BAKEY ATRAUMATIC-GRIP Aortaklemmen	539
DE BAKEY ATRAUMATIC-GRIP Bulldogklemmen	526, 528
DE BAKEY ATRAUMATIC-GRIP Coarctationsklemmen	532-533
DE BAKEY ATRAUMATIC-GRIP Gefäßklemmen	529, 541
DE BAKEY ATRAUMATIC-GRIP Gefäßpinzetten	135
DE BAKEY ATRAUMATIC-GRIP Mehrzweckklemmen	530, 553
DE BAKEY ATRAUMATIC-GRIP Nierenearterienklemme	537
DE BAKEY ATRAUMATIC-GRIP Patent-Ductusklemmen	531
DE BAKEY ATRAUMATIC-GRIP Peripheralklemmen	534-536
DE BAKEY ATRAUMATIC-GRIP Präparier- und Ligaturklemmen	551
DE BAKEY DURACUT Gefäßscheren	57
DE BAKEY Gefäßscheren	96
DE BAKEY Rippensperrer	504-505
DE BAKEY Saugrohr	325
DE BAKEY TITE GRIP Gewebefaß- und Nadelzieh-Pinzetten	116
DE BAKEY TITE GRIP Nadelhalter	343
DE MARTEL-WOLFSON Dickdarm-Anastomosens-Klemmen	402
DE MARTEL-WOLFSON Klemmenhalter	402
DE MARTEL-WOLFSON Klemmenschießzange	402
DE MARTEL (BAILEY) Einführungsinstrument für Drahtsägen	687
DE VILBISS Schädelstanze	688
DE VILBISS Scheidenspekula	433
DEAN DURACUT Zahnfleischscheren	55
DEAN Tonsillenschere	103
DEAVER-FORD Wundhaken und Lungenspatel	263
DEAVER Chirurgische Scheren	71
DEAVER Wundhaken und Lungenspatel	264-265
Deckglaspinzette	152
DEJERINE Perkussionshämmer	2
Dekapitationshaken	485
Dekompressionshaken	701
DEMEL Drahtumführungsnadeln	661
DENHARDT Mundsperrer	22
DENIS-BROWNE Bauchdeckenhalter	305
DENKER-UECKERMANN Not-Tracheotomietrokare	728
DERF Nadelhalter	363
DERF TITE GRIP Nadelhalter	342
Dermatome	41-42
DERRA-COOLEY ATRAUMATIC-GRIP Anastomosenklemmen	559
DERRA-DE BAKEY ATRAUMATIC-GRIP Anastomosenklemmen	542
DESCHAMPS Unterbindungsnadeln	374-376
DESJARDINS Gallengangsonden	415
DESJARDINS Gallensteinzangen	419
DESMARRES Venenhaken (Lidhalter)	222
DEUCHER Bauchdeckenhalter	299
DEVIN ATRAUMATIC-GRIP Karotis-Klemmen	524
DIEFFENBACH Bulldogklemmen	163
DIETRICH-DE BAKEY ATRAUMATIC-GRIP Bulldogklemmen	526
DIETRICH-HEGEMANN DURACUT Gefäßscheren	56
DIETRICH-HEGEMANN Gefäßscheren	96
DIETRICH ATRAUMATIC-GRIP Aortaklemmen	539

DIETRICH Gefäßscheren	97
DIETRICH Mikro-Bulldogklemmen	162
DIETRICH TITE GRIP Mikro-Nadelhalter	339
Dilatationsbougies	424
Dilatationsoliven, Gallengang-	416
Dilatatoren, Aorta-	511
Dilatatoren, Gefäß-	510
Dilatatoren, Intima-	512
Dilatatoren, Tracheal-	728
Dilatatoren, Uterus-	443-445
DINGMANN Knochenhaltezange	624
DINGMANN Modif. Knochenhaltezange	624
Dissektoren	574, 693-694, 696-697
Dissektoren, Dura-	699-700
Distrationsklammer	630
DITTEL Katheterspanner	425
DIXON-LOVELACE Feine Arterienklemmen	169
DIXON-OCHSNER (CRILE-RANKIN) Feine Arterienklemmen	167
DIXON (PEAN) Arterienklemmen	174
DOCKHORN Wundhaken	245
Doppelsonde	694
Dosen	747
DOUGLAS-BOZEMANN Tamponzangen	208
DOUGLAS Cilienpinzette	152
DOUGLAS Kieferhöhlentrokär	320
DOYEN-BABY ATRAUMATIC-GRIP Darmklemmen	391
DOYEN-BABY Darmklemmen	391
DOYEN-STILLE Wundhaken	247
DOYEN ATRAUMATIC-GRIP Darmklemmen	392-393
DOYEN Bauchdeckenhaken	248-249
DOYEN Bauchdeckenscheren	106
DOYEN Darmklemmen	392-393
DOYEN Hammer	618
DOYEN Hohlsonden	314
DOYEN Myomheber	458
DOYEN Polypen- und Ovarienzange	457
DOYEN Rippenraspatorien	495
DOYEN Scheidenhalter	439
DOYEN Tuchklemme	200
Draht, Silber-	690
Drahtbiegezangen	666
Drähte für Cerclage	660
Drahtfaßzangen	663-664
Drahtfaßzangen TITE GRIP	663
Drahtkneifzangen	666
Drahtkneifzangen DURACUT	667
Drahtsägen	687
Drahtscheren	665
Drahtscheren DURACUT	665
Drahtspanner	660
Drahtspannzangen TITE GRIP	662
Drahtumführungs-nadeln	660-661
Dreieckschalen	750
Druckklemme	409
DUBOIS Kephalotomiescheren	109
DUPLAY Hakenzange	453
Dura-Dissektoren	699-700
Dura-Separatoren	698
DURACUT Adnexscheren	54
DURACUT Chirurgische Scheren	46
DURACUT Damm- (Episiotomie-) Scheren	60
DURACUT Drahtkneifzangen	667
DURACUT Drahtscheren	665
DURACUT Feine Scheren	45
DURACUT Fistelscheren	45
DURACUT Gefäßscheren	45, 56-57
DURACUT Gefäßscheren	56-57
DURACUT Gipsschere	676
DURACUT Gynäkologische Scheren	60
DURACUT Irisschere	45
DURACUT Ligaturscheren	353
DURACUT Nasenscheren	58
DURACUT Parametriumscheren	60
DURACUT Präparierscheren	47-54
DURACUT Schere für Rektumchirurgie	59
DURACUT Scheren für plastische Chirurgie	45
DURACUT Septumscheren	59
DURACUT Uterusscheren	60
DURACUT Verbandscheren	673

DURACUT Zahnfleischscheren	55
Durahäkchen	212, 216-218
Duramesser	37
DURANTE Gefäß- und Tumorpinzetten	149
Duraschere	100
DUVAL-COLLIN Darm- und Gewebefaßzangen	386
DUVAL-COLLIN Dampinzette	149
DUVAL Darm- und Gewebefaßzangen	386-387
DUVAL Dampinzette	149
DUVAL TITE GRIP Darm- und Gewebefaßzangen	388
Dynamometer	6

E

EASTMAN-RICHARDSON Wundhaken	250
EATON-BECKMANN Laminektomie-Wundspreizer	280
ECHLIN Hohlmeißelzangen	634
EDER Watteträger	409
EICKEN-KILLIAN Kieferhöhlenspülkanülen	322
Einführungsinstrument für Drahtsägen	687
EISELSBERG Ligatur- und Fadenschere	352
Elevatoren	574-575
EMMET Fistelhaken	221
EMMET Häkchen für Laserchirurgie	449
EMMET Korn- und Tupferzange	207
Endarterektomie-Satz	515
Endarterektomiestripper	514
Endocervix-Biopsieküretten	459-460
Endometrium-Saug-Biopsieküretten	459
Endometrium-Strichkürette	459
Endospekula	443
Endospekula für Laserchirurgie	448
ENGEL Gipssäge	679
ENGL. MOD. Tuchklemme	200
Entfernungszangen für Bulldogklemmen	527
Entfernungszangen für TITAN-LINE Bulldogklemmen	160
Entfernungszangen für Wundklammern	379
Enukleatoren	693
ERRICO Bohrer	652
Ersatzteile für oszillierende Gipssäge	681
ESMARCH Gipsmesser	679
ESMARCH Kleiderstoff- und Gipscheren	675
ESMARCH Staubbinde	570
ESMARCH Stauschlauch	570
EUFRATE PASQUE TITE GRIP Nadelhalter	344
EWALD Feine anatomische Pinzetten	129
EWALD Feine chirurgische Pinzetten	140
Explorationshäkchen	215
Extensionsbügel	654, 658-659
EYE FRENCH TITE GRIP Nadelhalter	340

F

Fadenfänger	378
Fadenführer	697
Fadenführungszange	423
Fadengabeln	378, 694
Fadenpinzette	152
Fadenscheren	352
FAHLBUSCH-HARDY Dissektoren	693
FANSLER-IVES Anuskop	407
FARABEUF-ALEXANDER Rippenraspatorien	497
FARABEUF-COLLIN Raspatorien	588
FARABEUF-LAMBOTTE Knochenhaltezange	626
FARABEUF Raspatorien	588
FARABEUF Wundhaken	227
FARRELL (LATHBURY) Watteträger	316
Faßpinzetten	149
Faßpinzetten PERFECT-GRIP, Mikro-	124
Faßpinzetten, Mikro-	124
Faßzangen	423
Faßzangen TITE GRIP, Draht-	663
Faßzangen, Draht-	663-664
Faßzangen, Hämorrhoiden-	410
Faßzangen, IUP (Intrauterinpeessar)-	447
Faßzangen, Kapsel-	423
Faßzangen, Knochen	493

Faßzangen, Knorpel-	640
Faßzangen, Meniskus-	640
Faßzangen, Nieren-	421
Faßzangen, Rippen	493
Faßzangen, Sehnen-	647
Faßzangen, Uterus-	458
FAURE Peritoneumklemmen	193
FAVALORO Coronararterien-Schere	95
Federhaken zur Galea-Fixation	691
FEHLAND ATRAUMATIC-GRIP Rektum-Anastomosenklemmen	401
FEILCHENFELD Splitterpinzetten	150
Feilen, Knochen-	592, 594-595
Feilen, Nagel-	18
FEIN Watteträger	317
Feine anatomische Pinzetten	128-131
Feine Arterienklemmen	164-172
Feine Arterienklemmen ATRAUMATIC-GRIP	165, 167
Feine Arterienklemmen TITAN-LINE	164, 166, 168
Feine chirurgische Pinzetten	138-143
Feine chirurgische Scheren	68-70
Feine Präparierscheren	92-93
Feine Scheren DURACUT	45
Feine Sehnscheren	92
FERGUSON Nähnadeln	356
FERGUSON Operationsschere	80
FERGUSON (FRAZIER) Saugkanülen	323
FERGUSON Knochenhaltezange	624
FERRIS-SMITH-CUSHING Laminektomie-Zangen	713
FERRIS-SMITH-KERRISON Laminektomie-Stanzen	709-710, 712
FERRIS-SMITH Chirurgische Pinzetten	147
Finger-Wundspreizer	270
Fingernagel-Instrumente	645
Fingerringssägen	645
FINOCHIETTO-BABY-HAIGHT Rippensperrer aus ALUMINIUM	501
FINOCHIETTO-BABY Rippensperrer	503
FINOCHIETTO-BURFORD Rippensperrer	503
FINOCHIETTO-BURFORD Rippensperrer aus ALUMINIUM	502
FINOCHIETTO-INFANT Rippensperrer aus ALUMINIUM	501
FINOCHIETTO-RIENHOFF Rippensperrer	506
FINOCHIETTO Modif. Rippensperrer aus ALUMINIUM	500
FINOCHIETTO Nadelhalter	369
FINOCHIETTO Rippensperrer	503
FINOCHIETTO Rippensperrer aus ALUMINIUM	501
FINOCHIETTO Thorax- und Ligaturklemme	564
FINOCHIETTO TITE GRIP Nadelhalter	346
FINSEN Wundspreizer	270
FISCH Durahäkchen	212
FISCHER Sehenschäler	646
Fistelhaken	221
Fistelscheren	80
Fistelscheren DURACUT	45
Fistelsonden	314, 409
Flachmeißel	607, 609-610
Flachmeißel mit Ferrozellgriff	611, 613-614
FLETCHER (JAVERTS) Tupfer- und Schwammzange	210
FLUHRER Knopfsonden	313
FOERSTER-BALLENGER Tupfer- und Schwammzangen	209
FOERSTER (FORBES) Tupfer- und Schwammzange	210
FOERSTER Bauchdeckenhalter	308
FOMON Choanenhaken	221
FOMON DURACUT Nasenscheren	58
FOMON Knochenfeilen	595
FOMON Nasenflügelscheren	81
FOMON Nasenflüglhaken	221
FOMON Nasenscheren	102
FOMON Raspeln	595
FOMON Scheren für plastische Chirurgie	82
FOMON TITE GRIP Raspeln	597
FORBES (FOERSTER) Tupfer- und Schwammzange	210
FORD-DEAVER Wundhaken und Lungenspatel	263
FOSS Wundhaken und Lungenspatel	263
FOX-GOLDMANN DURACUT Zahnfleischscheren	55
FOX-GOLDMANN Zahnfleischscheren	94
FOX Lupusküretten	20
FRANZ Bauchdeckenhalter	304
FRAZIER (FERGUSON) Saugkanülen	323
FRAZIER Dura- und Hauthäkchen	216
FRAZIER Dura-Separator	698
FRAZIER Saugkanülen	323

FREER Flachmeißel	607
FREER Raspatorien	583
FREER Wundhäkchen	218
FRENCH EYE TITE GRIP Nadelhalter	340
FRENZEL Zungenspatel	12
FREY-SAUERBRUCH Rippenschere	493
FRIEDMAN-LUER Hohlmeißelzange	631
FRICTSCH Wundhaken	250
FROHN Watteträger	316
FRYKHOLM Hohlmeißelzangen	635
Führungshohlsonden	377-378
Führungsnadeln	334
Führungszange, Katheter- und Schlauch-	473

G

GALLAHER Raspel	592
Gallenblasenlöffel	417
Gallenblasentrokare	318
Gallengang-Dilatationsoliven	416
Gallengangsonden	415
Gallensteinlöffel	417
Gallensteinsonde	415
Gallensteinzangen	418-419
GANSKE-BIRCHER Meniskus- und Knorpelfaßzangen	640
GARRETT (DE BAKEY) Gefäßdilatoren	510
GAYLOR-THOMS Uterus-Biopsiezange	460
Geburtshilfe-Instrumente	481, 486
Geburtslöffel	481
Geburtszangen	478-480
Gefäßclips	154-156
Gefäßdilatoren	510
Gefäßhäkchen	213-215
Gefäßklemmen ATRAUMATIC-GRIP	520-523, 529-530, 534, 537, 541, 555-556, 558, 561-562
Gefäßklemmen halbflexibel	563
Gefäßmesser	694-695
Gefäßnadeln	354
Gefäßpinzetten	148-149
Gefäßpinzetten ATRAUMATIC-GRIP	135
Gefäßscheren	80, 95-98
Gefäßscheren DURACUT	45, 56-57
Gefäßspülkanülen	322
GEISSENDOERFER-OVERHOLT Präparier- und Ligaturklemmen	184
GELPI-BABY Vulva-Spreizer	281
GELPI-SELETZ Vulva-Spreizer	281
GELPI Vulva-Spreizer	281
GEMINI-MIXTER Präparier- und Ligaturklemmen	181
GEMINI Präparier- und Ligaturklemmen	181
GERALD Feine anatomische Pinzetten	130
GERALD Feine chirurgische Pinzetten	142
GERALD TITE GRIP Anatomische Pinzette	114
GERALD TITE GRIP Chirurgische Pinzette	117
Geräte zur Beschriftung	757
Geräte zur Markierung	757
GERSTER Distractionsklammer	630
GERZOG Hammer	618
Gewebefaß-Pinzetten TITE GRIP	116
Gewebefaßpinzetten	126-127, 148
Gewebefaßzangen	383-388
Gewebefaßzangen ATRAUMATIC-GRIP	389
Gewebefaßzangen TITE GRIP	388
GIBBON-BAILEY Rippenkontraktor	508
GIERTZ-STILLE Rippenschere	492
GIGLI (OLIVERCRONA) Drahtsägen	687
GIGLI Handgriffe für Drahtsägen	687
GIL-VERNET (MARBERGER) Venen- und Hilushaken	223
GILLIES-BABY Nadelhalter	370
GILLIES-BABY TITE GRIP Nadelhalter	348
GILLIES (CONVERSE) Hauthäkchen	216
GILLIES Feine chirurgische Pinzetten	142
GILLIES Hauthäkchen	216
GILLIES Nadelhalter	370
GILLIES TITE GRIP Chirurgische Pinzette	117
GILLIES TITE GRIP Nadelhalter	348
Gipsabreißzangen	682
Gipsmesser	679
Gipssäge	679

Gipssäge oszillierend	680
Gipssäge oszillierend - Ersatzteile	681
Gipsscheren	675-678
Gipsscheren DURACUT	676
Gipsspreizer	682
Glaspipette zur Mikro-Blutentnahme	473
GLASSMANN (KILNER) Präparierscheren	83
GLOVER-DE BAKEY ATRAUMATIC-GRIP Bulldogklemmen	525
GLOVER ATRAUMATIC-GRIP Anastomosenklemmen	544
GLUCK Rippenscherer	492
GOELET Wundhaken	229
GOLDMANN-FOX DURACUT Zahnfleischscheren	55
GOLDMANN-FOX Zahnfleischscheren	94
GOOD Tonsillenscherer	103
GOODELL Uterus-Dilatator	443
GORNEY DURACUT Septumscherer	59
GORNEY Scheren für plastische Chirurgie	82
GOSSET-BABY Bauchdeckenhalter	299
GOSSET Bauchdeckenhalter	299-300
GOURDET Uteruslöffel	466
GRAEFE (TYRELL) Hauthäkchen (Irishäkchen)	216
GRAEFE Chirurgische Pinzette	148
GRAEFE Feine anatomische Pinzetten	128
GRAEFE Feine chirurgische Pinzetten	139
GRAEFE Schielhaken	213
GRAHAM Durahäkchen	217
GRAMCKO-BUCK Knochenhebel	576
GRAVE Modif. Scheidenspekula	432
GRAVE Scheidenspekula	432-433
GREEN-ARMYTAGE Uterusklemmzange	481
GREEN-SENN Wundhaken	224
GREEN Schilddrüsenhaken	243
GREEN Tuchklemme	200
GREGORY-SOFT ATRAUMATIC-GRIP Karotisklemmen	527
GREGORY ATRAUMATIC-GRIP Profundaklemmen	534
GRONINGEN Nerv- und Gefäßhäkchen	215
GROSS Korn- und Tupferzangen	204
GRUENWALD-LOVE Laminektomie-Zangen	716
GRUENWALD (JANSEN) Ohr- und Nasenpinzette	136
GRUENWALD Ohr- und Nasenpinzetten	136
Gummiringe, Ligatur	410
GUNNAR-HEY Schlauchroller	203
GUTHRIE Hauthäkchen (Irishäkchen)	218
GUYON-DE BAKEY ATRAUMATIC-GRIP Nierenklemmen	190
GUYON Katheter-Einführungsinstrument	425
GUYON Katheterspanner	425
GUYON Nierenklemme	190
Gynäkologische Scheren DURACUT	60

H

HABERER Bauch- und Darmspatel	267
Hähne für Spritzen	333
HAIGHT-FINOCHIETTO-BABY Rippensperren aus ALUMINIUM	501
HAIGHT Rippensperren	506
HAJEK-KOFLER Laminektomie-Stanzen	708
HAJEK Hämmer	617
Häkchen	696
Häkchen für Laserchirurgie	449
Häkchen für Mikrochirurgie	212
Häkchen für plastische Chirurgie	217-219
Häkchen, Dura	212, 216-218
Häkchen, Explorations	215
Häkchen, Gefäß	213-215
Häkchen, Haut	216-218
Häkchen, Iris	216-218
Häkchen, Koagulations	215
Häkchen, Nerv	213-215
Häkchen, Ohr	213
Häkchen, Tracheal	217, 219-220, 728
Häkchen, Wund	212, 216-221
Haken für plastische Chirurgie	226
Haken zur Galea-Fixation, Feder	691
Haken, Atrium	509
Haken, Bauchdecken	248-249, 309
Haken, Choanen	221
Haken, Dekapitations	485
Haken, Dekompressions	701

Haken, Fistel	221
Haken, Hilus	223
Haken, Knochen	232
Haken, Krypt	409
Haken, Leber	255
Haken, Lungen	260
Haken, Meniskus	641
Haken, Nasenflügel	221
Haken, Nervwurzel	701
Haken, Pelvis	258
Haken, Prostata	422
Haken, Scapula	260
Haken, Schiel	213
Haken, Schilddrüsen	243
Haken, Sehnenscheiden	225
Haken, Tracheal	226
Haken, Venen	217, 222-223
Haken, Wund	222-259, 261-265, 641
Haken-Bulbus	422
Hakenzangen	452-456
Halbflexible Gefäßklemmen	563
HALLE Duramesser	37
HALLE Intima-Spatel	512
HALLE Raspatorien	582
HALLE Scharfe Löffel	604
HALSEY Nadelhalter	363
HALSEY TITE GRIP Nadelhalter	342
HALSEY TITE GRIP Nadelhalter für Linkshänder	341
HALSTED-MICRO Feine Arterienklemmen	164
HALSTED-MOSQUITO-DE BAKEY ATRAUMATIC-GRIP feine Arterienklemmen	165
HALSTED-MOSQUITO (HEISS) Feine Arterienklemmen	170
HALSTED-MOSQUITO Feine Arterienklemmen	164-165
HALSTED-MOSQUITO TITAN-LINE Feine Arterienklemmen	164
HALSTED Feine Arterienklemmen	169, 171
Halter für Mikro Klingen	473
Halter, Klemmen	402
Halter, Lid	222
Halter, Schädel	689
Halter, Scheiden	434-437, 439
Hämmer	2-3, 617-618, 620-621
Hämmer mit Ferrozellgriff	619
Hämorrhoiden-Faßzange	410
Hämorrhoiden-Ligatoren	410
Hämorrhoiden-Saugligatoren	411
Hand- und Carpal- Tunnel-Wundspreizer	271
Hand- und Unterarm-Wundspreizer	271
Handbohrapparate	651-653
Handgriffe für Drahtsägen	687
Handhalter	644
Handtuchablagekörbe	753
Handwaschbürste	752
HARDY-FAHLBUSCH Dissektoren	693
HARDY Dissektoren	693
HARDY Eukleatoren	693
HARDY Implantationsgabel	693
HARDY Küretten	692
HARKEN-DE BAKEY ATRAUMATIC-GRIP Präparier- und Ligaturklemmen	551
HARRINGTON-MAYO Präparierscheren	86
HARRINGTON Wundhaken und Lungenspatel	262
HARTMANN-COLLIN Wundhaken	229
HARTMANN (MOSQUITO-BABY) Feine Arterienklemmen	164
HARTMANN Ohrkatheter	322
HARTMANN Stimmgabeln	4
HARTMANN Uterus-Biopsiezangen	462
HASSELLTINE Nabelschnurklemmen	486
Hauthäkchen	216-218
Hautstanzbesteck	20
Hautstanzen	20
HAVERFIELD-SCOVILLE Laminektomie-Spreizer	286
HAYES ATRAUMATIC-GRIP Rektum-Anastomosenklemmen	400
HEANEY-BALENTINE Hysterektomieklammer	196
HEANEY-DE BAKEY (ROGERS) ATRAUMATIC-GRIP Hysterektomieklammer	197
HEANEY-REZEK Hysterektomieklammer	196
HEANEY-SIMON Wundhaken	254
HEANEY Chirurgische Pinzetten	147
HEANEY Hysterektomieklammer	196

HEANEY Nadelhalter	369
HEANEY TITE GRIP Nadelhalter	346
HEATH-RICHTER Klammerentfernungszange	379
HEATH Hammer	620
HEGAR-BABY-OLSEN TITE GRIP Nadelhalter	348
HEGAR-BAUMGARTNER TITE GRIP Nadelhalter	342
HEGAR-CORWIN TITE GRIP Drahtspannzange	662
HEGAR-MAYO Nadelhalter	367
HEGAR-MAYO TITE GRIP Nadelhalter	345
HEGAR-MAYO TITE GRIP Nadelhalter für Linkshänder	341
HEGAR-OLSEN Nadelhalter	370
HEGAR-OLSEN TITE GRIP Nadelhalter	348
HEGAR Uterus-Dilatatoren	444-445
HEGEMANN-DIETRICH DURACUT Gefäßscheren	56
HEGEMANN-DIETRICH Gefäßscheren	96
HEGENBARTH Klammeranlegepinzette	379
HEIFETZ Hirnspatel	706
HEIFETZ Tumor- und Gewebefäßpinzetten	127
HEISS (HALSTED-MOSQUITO) Feine Arterienklemmen	170
HEISS (PAUL-MIXTER) Präparier- und Ligaturklemme	182
HEISTER Mundsperrer	22
Hemilaminektomie-Wundspreizer	277
HEMINGWAY Scharfe Löffel	599
HENLEY Wundspreizer	282-283
HENNIG Gipsspreizer	682
HERRICK Nierenstielklemme	191
HEY-GUNNAR Schlauchroller	203
HEYMANN DURACUT Nasenscheren	58
HEYMANN Nasenscheren	101
HEYWOOD-SMITH Polypen- und Ovarienzange	457
HEYWOOD-SMITH Zungenzangen	23
HIBBS Wundhaken	231
Hilushaken	223
Hirnmesser	40
Hirnspatel	706
HIRSCHMANN Anuskope	407
HOEN Raspatorien	586
HOGLUND-LOWMAN Knochenhalteklammer	630
Hohlmeißel	607, 609-610
Hohlmeißel-Spinal mit Ferrozellgriff	616
Hohlmeißel-Spongiosa mit Ferrozellgriff	615
Hohlmeißel mit Ferrozellgriff	611-616
Hohlmeißelzangen	494, 631-636
Hohlsonden	314
HOHMANN-ALDINGER Knochenhebel	580
HOHMANN-LANGE Knochenhebel	577
HOHMANN-LANGE Modif. Knochenhebel	577
HOHMANN-MINI Knochenhebel	576
HOHMANN Knochenhebel	578-580
HOKE Osteotome	607
HOLSHER Nervwurzelhaken	701
HOLZBACH Hysterektomieklammern	194
HOPKINS-JOHNS Anlege- und Entfernungszange für Bulldogklemmen	527
HOPKINS-JOHNS Bulldogklemmen	163
HOPKINS Gipsmesser	679
HORGAN Mittelvalve für Bauchdeckenhalter	303
HORNE-JOBSON Watteträger	317
HORSLEY-LISTON-KEY Knochensplitterzange	494
HORSLEY Dura-Separator	698
HÖSEL Wundhaken	246
HOSPITAL-PROVIDENCE Feine Arterienklemmen	168
HOUSE Scharfe Löffel	598
HOWARD Raspatorium	583
HRYNTSCHAK-YOUNG Bumerang-Nadelhalter	372
HUDSON Handbohrapparat	652
Hüfthebel	580
HULKA-KENWICK Hakenzangen	453
HULKA Hakenzange	453
HUMBY Dermatome	42
HUNTER Splitterpinzetten	150
HURD Unterbindungsnadeln	374
Hypophysektomie-Instrumente	692-693
Hypophysenzange	719
Hysterektomieklammern	194-196
Hysterektomieklammern ATRAUMATIC-GRIP	197

Iliaca Klemmen ATRAUMATIC-GRIP	558
Implantationsgabel	693
INFANT-FINOCHIETTO Rippensperrer aus ALUMINIUM	501
INGE Wirbelkörperspreizer	296
Injektionskanüle	486
Instrumentarium zur Amnioskopie	472-473
Instrumentarium zur Hysterosalpingographie	474
Instrumentarium zur Mikro-Blutentnahme	472-473
Instrumente, Tunnelier-	517
Instrumenten-Pflegemittel	733
Instrumentenablageplatten	748
Instrumentenkästen	746
Insulin-Spitzen	330
Intima-Dilatatoren	512
Intima-Messer	513
Intima-Spatel	512-513
Inzisionsschere	80
IOWA Blasensprenger	477
IOWA Injektionskanüle	486
IOWA Nadelführung	486
Irishäkchen	216-218
Irisscheren DURACUT	45
Irrigatoren	751
ISRAEL Wundhaken	237
IUP (Intrauterinpeppisar)- Faßzangen	447
IVES-FANSLER Anuskop	407

J

JACKSON-CHEVALIER Trachealkanülen	726
JACKSON Scheidenspekula	438
JACKSON Sehnenfaßzange	647
JACKSON Trachealhäkchen	217
JACKSON Trachealhaken	226
JACOBS Hakenzange	456
JACOBSON Doppelsonde	694
JACOBSON Fadengabel	694
JACOBSON Gefäßmesser	694
JACOBSON Knopfsonde	694
JACOBSON Mikro-Scheren	64
JACOBSON PERFECT-GRIP Mikro-Nadelhalter	359
JACOBSON TITE GRIP Mikro-Nadelhalter	338
JAMESON Feine Präparierscheren	93
JAMESON Nadelhalter	368
JANET Wund- und Blasenspritzen	331
JANET Zylinder für Spritzen	331
JANSEN-ZAUFL Hohlmeißelzangen	633
JANSEN (GRUENWALD) Ohr- und Nasenpinzette	136
JANSEN Hohlmeißelzangen	632
JANSEN Ohr- und Nasenpinzette	136
JANSEN Raspatorium	587
JANSEN Scharfe Löffel	599
JANSEN Stirnlampe	11
JANSEN Wundspreizer	272
JAVERTS (FLETCHER) Tupfer- und Schwammzange	210
JAVID ATRAUMATIC-GRIP Karotis-Klemmen	537
JOBSON-HORNE Watteträger	317
JOHNS-HOPKINS Anlege- und Entfernungszange für Bulldogklemmen	527
JOHNS-HOPKINS Bulldogklemmen	163
JONES-LELAND ATRAUMATIC-GRIP Peripheralklemmen	534
JONES Tuchklemmen	200
JORGENSEN Präparierschere	98
JOSEPH Häkchen für plastische Chirurgie	217, 219
JOSEPH Knochenfeile	592
JOSEPH Nasenplastikmesser	37
JOSEPH Raspatorien	582
JOSEPH DURACUT Scheren für plastische Chirurgie	45
JOSEPH Scheren für plastische Chirurgie	70
JUDD-ALLIS Darm- und Gewebefäßzangen	384
JUDD-MASSON Blasenwundspreizer	310

K

KADER Bauch- und Darmspatel	267
KALLMORGEN Scheidenspekula und -halter	434

KALT Gefäßnadeln	354	Klammeranlegezangen	379, 690-691
KALT Nadelhalter	363	Klammerblock	690-691
Kaltlicht-Proximalbeleuchtung für Amnioskop Tuben	472	Klammerentfernungszangen	379
Kanülen für die Leberblindpunktion	329	Klammerinstrumentarium	690-691
Kanülen zur Brustfellpunktion	329, 518	Klammern, Knochenhalte-	630
Kanülen zur gezielten Leberpunktion	329	Klammern, Kopfhaut-	691
Kanülen zur Lumbalpunktion	328	Klammern, Silber-	690
Kanülen zur Sternalpunktion	329, 518	Klammern, Sterilisier-	736
Kanülen, Biopsie-	518, 529	KLAPP Sehnenscheidenhaken	225
Kanülen, Gefäß-	322	Kleiderstoffscheren	674-675
Kanülen, Injektions-	486	Klein-Transformator für Stirnlampen	11
Kanülen, Kieferhöhlenpunktions-	319	KLEINERT-KUTZ Sehnendurchziehange	649
Kanülen, Kieferhöhlenspül-	322	KLEINSCHMIDT Spornquetsche und Appendektomieklamme	403
Kanülen, Peritoneal-Pneu-	329	Klemmen ATRAUMATIC-GRIP, Obere Verschluß-	398
Kanülen, Saug-	320-323	Klemmen ATRAUMATIC-GRIP, Untere Verschluß-	399
Kanülen, Septum-	328	Klemmen ATRAUMATIC-GRIP, Anastomosen-	400-401, 520-523, 542-544, 559-560
Kanülen, Spezial-	328	Klemmen ATRAUMATIC-GRIP, Aorta-	537-540, 561
Kanülen, Tonsillen-	328	Klemmen ATRAUMATIC-GRIP, Aorta-Anastomosen-	548-549
Kanülen, Tracheal-	725-727	Klemmen ATRAUMATIC-GRIP, Aorta-Aneurysma-	545-547, 561
Kanülen, Ventil-Sprech-	726-727	Klemmen ATRAUMATIC-GRIP, Arterien-	176
Kappenzangen	735	Klemmen ATRAUMATIC-GRIP, Bronchus-	552
Kapselfaßzange	423	Klemmen ATRAUMATIC-GRIP, Bulldog-	525-528, 556
Karotis-Klemmen ATRAUMATIC-GRIP	524, 527, 537	Klemmen ATRAUMATIC-GRIP, Coarctations-	532-533, 557
Katheter- und Schlauch-Führungszange	473	Klemmen ATRAUMATIC-GRIP, Darm-	391-393, 395-396
Katheter, Metall-	424	Klemmen ATRAUMATIC-GRIP, Gefäß-	520-523, 529-530, 534, 537, 541, 555-556, 558, 561-562
Katheter, Ohr-	322	Klemmen ATRAUMATIC-GRIP, Hysterektomie-	197
Katheter-Einführungsinstrument	425	Klemmen ATRAUMATIC-GRIP, Iliaca-	558
Katheter-Einführungszangen	32	Klemmen ATRAUMATIC-GRIP, Karotis-	524, 527, 537
Katheterspanner	425	Klemmen ATRAUMATIC-GRIP, Ligatur-	186, 551
KATSCH Komедonenquetscher	19	Klemmen ATRAUMATIC-GRIP, Magen-	397
KAY-LAMBERT ATRAUMATIC-GRIP Aorta-Anastomosenklemmen	549	Klemmen ATRAUMATIC-GRIP, Mehrzweck-	520-523, 530, 553-554, 556, 562
KAZANJIAN Knochensplitterzange	637	Klemmen ATRAUMATIC-GRIP, Nieren-	190
Kehlkopfspiegel	13-14	Klemmen ATRAUMATIC-GRIP, Nierenarterien-	537, 558
KELLY-BABY Feine Arterienklemmen	168	Klemmen ATRAUMATIC-GRIP, Parametrium-	197
KELLY-RANKIN Feine Arterienklemmen	169	Klemmen ATRAUMATIC-GRIP, Patent-Ductus-	531, 556
KELLY DURACUT Gefäß- und Fistelscheren	45	Klemmen ATRAUMATIC-GRIP, Peripheral-	534-536, 558
KELLY Feine Arterienklemmen	168	Klemmen ATRAUMATIC-GRIP, Präparier-	186, 551
KELLY Gefäß- und Fistelscheren	80	Klemmen ATRAUMATIC-GRIP, Profunda-	534
KELLY Polypen- und Ovarienzange	457	Klemmen ATRAUMATIC-GRIP, Rektum-	400-401
KELLY Sphinkterskope	407	Klemmen ATRAUMATIC-GRIP, Vena-Cava-	550
KELLY TITAN-LINE Feine Arterienklemmen	168	Klemmen aus TITAN, Bulldog-	160-161
KELLY Wundhaken	251, 255	Klemmen fein ATRAUMATIC-GRIP, Arterien-	165, 167
Kennzeichnungsschilder	743	Klemmen fein TITAN-LINE, Arterien-	164, 166, 168
KENWICK-HULKA Hakenzangen	453	Klemmen fein, Arterien-	164-172
Kephalotomiescheren	109	Klemmen halbflexibel, Gefäß-	563
KERN-LANE Knochenhaltezange	625	Klemmen Mikro, Bulldog-	162
KERN-MINI Knochenhaltezange	625	Klemmen zum Fixieren des Samenstrangs	425
KERRISON-FERRIS-SMITH Laminektomie-Stanzen	709-710, 712	Klemmen, Anastomosen-	400-402
KERRISON-LOVE (COLCLOUGH) Laminektomie-Stanzen	710-711	Klemmen, Anastomosen- (Vena Cava)	565
KERRISON Laminektomie-Stanzen	707	Klemmen, Appendektomie-	403
KEVOURKIAN-PACIFIC Uterus-Biopsiezange	464	Klemmen, Arterien-	173-179
KEVOURKIAN-YOUNGE Endocervix-Biosieküretten	459	Klemmen, Aurikel-	564
KEVOURKIAN-YOUNGE Uterus-Biopsiezange	463, 465	Klemmen, Bronchus-	566
KEY-HORSLEY-LISTON Knochensplitterzange	494	Klemmen, Bulldog-	163
KEY Raspatorien	589	Klemmen, Darm-	390-396, 403
KEYES Hautstanzbesteck	20	Klemmen, Druck-	409
KEYES Hautstanzen	20	Klemmen, Hysterektomie-	194-196
Kieferhöhlenpunktionskanülen	319	Klemmen, Ligatur-	180-189, 564
Kieferhöhlenspülkanülen	322	Klemmen, Magenquetsch-	403
Kieferhöhlentrokare	319-320	Klemmen, Muskel-	728
KIELAND-LUIKART Geburtszange	479	Klemmen, Nabelschnur-	486
KIELAND Geburtszange	479	Klemmen, Nieren-	190
KILLIAN-EICKEN Kieferhöhlenspülkanülen	322	Klemmen, Nierenstiel-	191
KILLIAN (MÜHLING) Septumschere	102	Klemmen, Penis-	426
KILLIAN Raspatorien	583	Klemmen, Peritoneum-	192-193
KILNER (GLASSMANN) Präparierscheren	83	Klemmen, Präparier-	180-189, 564
KILNER Feine Präparierscheren	93	Klemmen, Rektum-	400-402
KILNER Hauthäkchen	216	Klemmen, Schlauch-	203
KILNER TITE GRIP Nadelhalter	342	Klemmen, Sehneneinflecht-	649
KIRK Hammer	618	Klemmen, Sinus-	204
KIRKLIN Venenhaken	223	Klemmen, Thorax-	564
KIRSCHNER-BALFOUR Valven für Bauchdeckenhalter	307	Klemmen, Tonsillen-	179
KIRSCHNER Bauchdeckenhalter	306	Klemmen, Tuch-	200-202
KIRSCHNER Bohrdrähte	655	Klemmenhalter	402
KIRSCHNER Extensionsbügel	658-659	Klemmenschließzange	402
KIRSCHNER Führungshohlsonde	377	KLIMA-ROSEGGGER Kanülen zur Sternalpunktion	329, 518
KIRSCHNER Valven für Bauchdeckenhalter	307		
Klammer, Distractions-	630		
Klammeranlegepinzetten	379		

Klingen	36
Klingen-Mikro zur Blutentnahme	473
KLINGENBERGH-LOTH Präparierschere	98
KNAPP Feine chirurgische Scheren	68
KNAPP Wundhäkchen	218
KNIGHT DURACUT Nasenscheren	58
KNIGHT Nasenscheren	101
Knochenbiopsie-Instrumente	669
Knochenfaßzangen	493
Knochenfeilen	592, 594-595
Knochenhaken	232
Knochenhalteklammern	630
Knochenhaltezangen	624-629
Knochenhebel	576-581
Knochensplitterzangen	494, 637-639
Knopfsonden	312-313, 694
Knorpelfaßzangen	640
Knorpelschere	82
KNOWLES Verbandschere	673
Knüpppinzetten PERFECT-GRIP, Mikro-	121-123
Knüpppinzetten TITE GRIP	113
Knüpppinzetten, Mikro-	121-123
KNUTSON Urethrographie-Instrument	426
Koagulationshäkchen	215
KOCHER-BABY ATRAUMATIC-GRIP Darmklemmen	391
KOCHER-BABY Darmklemmen	391
KOCHER-LANGENBECK Wundhaken	240
KOCHER-OCHSNER Arterienklemmen	177
KOCHER Arterienklemmen	176
KOCHER ATRAUMATIC-GRIP Darmklemmen	395
KOCHER Blasenspatel	268
KOCHER Darmklemmen	392-394
KOCHER Kropfsonden	378
KOCHER Wund- und Knochenhaken	232
KOCHER Wundhaken	235, 242, 244
KOENIG Führungshohlsonden	377
KOERTE-LUER Gallensteinlöffel	417
KOERTE Wundhaken	236
KOFLER-HAJEK Laminektomie-Stanzen	708
KOGAN Endospekula	443
KOGAN Endospekula für Laserchirurgie	448
KÖLN MOD. Kopfhautklammern	691
Komedonenquetscher	19
Komprimierer zur Erzeugung einer Blutleere	570
KÖNIG-ROSER Mundsperrer	22
KÖNIG Raspatorien	582
Konisationsstift	447
KONRICH Sterilisiertrommeln	743
Kontraktoren, Rippen-	508
KOOS Gefäßmesser	695
Kopfhautklammern	691
Kopfhebel	481
Kopflupen, binokular	8-9
Kopfschneider	668
Kopfschwartenzange	481
Körbe für Sterilisation	745
Körbe, Bürstenablage-	753
Körbe, Handtuchablage-	753
Kornzangen	204-207
Kraftmesser	6
Kranioklast	485
Krankenpflegeartikel	751
KRAUS Gefäßmesser	695
KRAUSE Kieferhöhlentrokcar	319
KRAYENBÜHL Nerv- und Gefäßhäkchen	215
KRISTELLER Scheidenspekula und -halter	434-437
KROENLEIN Arterienklemme	173
KRONECKER Unterbindungsnadeln	374
Kropfsonden	378
Kropfwundhaken	224
Krypthaken	409
KÜHNE Deckglaspinzette	152
Küretten	692
Küretten, Abortus-	484
Küretten, Absaug-	471
Küretten, Biopsie-	459-460
Küretten, Endocervix-Biopsie-	459-460
Küretten, Endometrium-Saug-Biopsie-	459
Küretten, Endometrium-Strich-	459

Küretten, Lupus-	20
Küretten, Plazentar-	484
Küretten, Uterus-	466-470
KUTZ-KLEINERT Sehnedurchziehzange	649

L

LA GRANGE Zahnfleissschere	94
LABORDE Trachealdilatator	728
LAHEY-SWEET Präparier- und Ligaturklemme	189
LAHEY Hakenzange	454
LAHEY Kropfwundhaken	224
LAHEY Präparier- und Ligaturklemmen	189
LAHEY Wundhäkchen	219
LAMBERT-KAY ATRAUMATIC-GRIP Aorta-Anastomosenklemmen	549
LAMBERT-LOWMAN Knochenhalteklammer	630
LAMBOTTE-FARABEUF Knochenhaltezange	626
LAMBOTTE-MINI Osteotome	608
LAMBOTTE Knochenhaltezangen	626-627
LAMBOTTE Osteotome	608
LAMBOTTE Rippenraspatorien	497
Laminektomie-Stanzen	707-712
Laminektomie-Wundspreizer	276, 279-280, 284, 286
Laminektomie-Zangen	713-719
LANDAU-COLLIN Scheidenspekula	431
LANDAU Scheidenspekula	440
LANDOLT-CUSHING Spekula für trans-sphenoidale Hypophysektomie	692
LANDOLT Raspatorium	585
LANE-KERN Knochenhaltezange	625
LANE-MURPHY Luxationshebel	581
LANE Knochenhaltezange	625
LANE Tuchklemme	201
LANGE-HOHMANN Knochenhebel	577
LANGE-HOHMANN Modif. Knochenhebel	577
LANGE Verbandscheren	672
LANGENBECK-KOCHER Wundhaken	240
LANGENBECK-MINI Wundhaken	224
LANGENBECK-PARKER (US-ARMY) Wundhaken	231
LANGENBECK-RYDER TITE GRIP Nadelhalter	350
LANGENBECK Amputations- und Resektionssäge	572
LANGENBECK Elevatorien	575
LANGENBECK Knochenhaltezange	624
LANGENBECK Raspatorien	587
LANGENBECK Resektionsmesser	38
LANGENBECK TITE GRIP Nadelhalter	350
LANGENBECK Wundhaken	238-239
Lappenmesser	39
Laryngoskope	24-31
Laserchirurgie-Instrumente	448-451
Lateral-Spekulum für Laserchirurgie	448
LATHBURY (FARRELL) Watteträger	316
LAWRENCE Präparier- und Ligaturklemme	187
LAWTON-MATHIEU TITE GRIP Nadelhalter	349
LAWTON TITE GRIP Nadelhalter	349
LAZAR Mikro-Knüpppinzetten	121
Leberhaken	255
LEBSCHKE Sternummeißel	492
LEES ATRAUMATIC-GRIP Bronchusklemmen	552
LEGUEU Blasenspatel	268
LEKSELL-STILLE Hohlmeißelzangen	635
LELAND-JONES ATRAUMATIC-GRIP Peripheralklemmen	534
LEMMON Intima-Spatel	512
LEMPERT Hohlmeißelzangen	631-632
LEMPERT Raspatorien	584
LEMPERT Scharfe Löffel	604
LERICHE Feine Arterienklemmen	165
LEWIN Repositionszange	622
LEWIS Raspeln	592
LEXER-BABY Präparierscheren	87
LEXER-MAYO DURACUT Präparierscheren	48
LEXER-MAYO Präparierscheren	87
LEXER-MINI Hohlmeißel mit Ferrozellgriff	612
LEXER-MINI Osteotome mit Ferrozellgriff	612
LEXER DURACUT Präparierscheren	49
LEXER Hohlmeißel mit Ferrozellgriff	612-613
LEXER Osteotome mit Ferrozellgriff	612-613
LEXER Präparierscheren	87
LEXER Spongiosa-Hohlmeißel mit Ferrozellgriff	615

LEYLA Retraktoren zur Fixation am OP-Tisch	704-705
LEYLA Retraktoren zur Fixation am Schädel	702-703
LICHTENBERG TITE GRIP Nadelhalter	349
LICHTWITZ Kieferhöhlenpunktionskanülen	319
LICHTWITZ Kieferhöhlentrokare	320
LICHTWITZ V. EICKEN Kieferhöhlenpunktionskanülen	319
Lidhalter	222
Ligatoren, Hämorrhoiden-	410-411
Ligatur-Gummiringe	410
Ligaturklemmen	180-189, 564
Ligaturklemmen ATRAUMATIC-GRIP	186, 551
Ligaturscheren	352-353
Ligaturscheren DURACUT	353
LINDORF TITE GRIP Drahtspannzange	662
Linse für Lupenbrillen	9
LISTER DURACUT Verbandscheren	673
LISTER modif. Verbandschere	673
LISTER Sinusklemmen	204
LISTER Universal Verband- und Kleiderstoffschere	674
LISTER Verbandscheren	673
LISTON-KEY-HORSLEY Knochensplitterzange	494
LISTON-LITTAUER Knochensplitterzange	637
LISTON-RUSKIN Knochensplitterzangen	638
LISTON-WALTON (BÖHLER) Knochensplitterzangen	638
LISTON Amputationsmesser	38
LISTON Knochensplitterzangen	637, 639
LITTAUER-LISTON Knochensplitterzange	637
LITTAUER Cilienpinzette	152
LITTAUER Ligatur- und Fadenschere	352
LITTLER Präparierschere	81
LOCKHART-MUMMERY Fistelsonden	314
LOCKLIN DURACUT Zahnfleischscheren	55
LOCKLIN Zahnfleischscheren	94
LOCKWOOD Darm- und Gewebefaßzange	386
Löffel mit Ferrozellgriff, scharfe	606
Löffel, Abortus	484
Löffel, Gallenblasen-	417
Löffel, Gallenstein-	417
Löffel, Geburts-	481
Löffel, Plazentar-	484
Löffel, scharfe	598-606, 695-696
Löffel, Sekret-	425
Löffel, Uterus-	466
LONG Hysterektomieklammer	194
LORNA Tuchklemmen	202
LOTH-KLINGENBERGH Präparierschere	98
LOTH-SCHOEMAKER Ligatur- und Fadenschere	352
LOUTE Drahtspanner	660
LOVE-GRUENWALD Laminektomie-Zangen	716
LOVE-KERRISON (COLCLOUGH) Laminektomie-Stanzen	710-711
LOVE Nervwurzelhaken	701
LOVELACE-DIXON Feine Arterienklemmen	169
LOVELACE Darm- und Gewebefaßzange	387
LOWER Präparier- und Ligaturklemme	189
LOWMAN-HOGLUND Knochenhalteklammer	630
LOWMAN-LAMBERT Knochenhalteklammer	630
LOWMAN Knochenhalteklammern	630
LUCAE Hammer	617
LUCAE Ohr- und Nasenpinzette	136
LUCAE Ohrhaken	213
LUCAE Stimmgabel	4
LUCAS scharfe Löffel	599
LUER-FRIEDMAN Hohlmeißelzange	631
LUER-KOERTE Gallensteinlöffel	417
LUER-STILLE Hohlmeißelzangen	634, 636
LUER Hohlmeißelzangen	631-632
LUER Trachealkanülen	725
LUER Wundhaken	227
LUIKART-KIELAND Geburtszange	479
Lungenfaßpinzetten	149
Lungenhaken	260
Lungenlappenschere	99
Lungenspatel	260-265
Lupe allein für Lupenbrillen	9
Lupenbrille, binokular	9
Lupusküretten	20
Lupusschaber	19
Luxationshebel	581

M

Magen- und Darm-Nähapparat	404
Magenklemmen ATRAUMATIC-GRIP	397
Magenquetschklemmen	403
MAGILL Katheter-Einführungszangen	32
MAIER-SIMS Korn- und Tupferzangen	205
MAIER Korn- und Tupferzangen	205
MALTZ Raspel	593
MALTZ TITE GRIP Raspeln	596
MARBACH Damm- (Episiotomie-) Scheren	107
MARBERGER (GIL-VERNET) Venen- und Hilushaken	223
Markierungsgeräte	757
MARKWALDER Rundmeißelzange	494
MARQUARDT Hohlmeißelzange	634
MARTIN Beckenzirkel	477
MARTIN Meniskus- und Knorpelfaßzangen	640
MARTIN Wundhaken	254
MARTINI Scharfe Löffel	598
Maßband	6
MASSON-JUDD Blasenwundspreizer	310
MASSON Nadelhalter	368
MASSON TITE GRIP Nadelhalter	347
Maßstäbe	6
Mastdarm-Biopsiezangen	412
Mastdarm-Spekula	405-406
MASTIN Muskelklemme	728
MATHIEU-LAWTON TITE GRIP Nadelhalter	349
MATHIEU Mastdarm-Rektum-Spekulum	405
MATHIEU Nadelhalter	371
MATHIEU Scheidenhalter	439
MATHIEU Scheidenspekula	439
MATHIEU TITE GRIP Nadelhalter	349
MATHIEU Wundhaken	226, 230
MATSON Rippenraspatorien	497
MATZENAUER Scheidenspekula	440
MAUNDER Mundkeil	22
MAYFIELD Hohlmeißelzange	633
MAYO-ADAMS Appendektomie-Wundspreizer	284
MAYO-BLAKE Gallensteinzangen	418
MAYO-HARRINGTON Präparierscheren	86
MAYO-HEGAR Nadelhalter	367
MAYO-HEGAR TITE GRIP Nadelhalter	345
MAYO-HEGAR TITE GRIP Nadelhalter für Linkshänder	341
MAYO-LEXER DURACUT Präparierscheren	48
MAYO-LEXER Präparierscheren	87
MAYO-NOBLE Präparierscheren	86
MAYO-ROBSON ATRAUMATIC-GRIP Darmklemmen	396
MAYO-ROBSON Darmklemmen	396
MAYO-STILLE DURACUT Präparierscheren	48
MAYO-STILLE Präparierscheren	85
MAYO Bauchdeckenhaken	249
MAYO DURACUT Präparierscheren	47
MAYO Gallensteinlöffel	417
MAYO Gefäß- und Tumorpinzette	149
MAYO Präparierscheren	84
MAYO Sterilisierklammern	736
MAYO Zungenspatel	12
MC DONALD Dissektor	574
MC GIVNEY Hämorrhoiden-Faßzange	410
MC INDOE Feine anatomische Pinzette	130
MC INDOE Knochensplitterzange	638
MC INDOE Knorpelschere	82
MC INDOE TITE GRIP Anatomische Pinzette	113
MC INTOSH Laryngoskope	24-27
MC INTOSH Laryngoskopie-Bestecke	24-25
MC KENTY Raspatorien	582
MC KENZIE Bohrer	652
MC KENZIE Klammer-Anlegezangen für Silberklammern	690
MC KENZIE Klammerblock	690
MC KENZIE Silberdraht	690
MC KENZIE Silberklammern	690
MC PHERSON Mikro-Knüpfpinzetten	122
MEAD Hammer	618
MEAD Hohlmeißelzangen	631
Meatotom	426
Medizinbecher	751
Medizinlöffel	751

MEEKER-BABY Präparier- und Ligaturklemmen	180	MILLER Laryngoskopie-Bestecke	28, 30
MEEKER Präparier- und Ligaturklemme	187	MILLER Raspeln	592
Mehrfach-Bohrdrahtspender	657	MILLER TITE GRIP Raspeln	596
Mehrweckklemmen ATRAUMATIC-GRIP	520-523, 530, 553-554, 556, 562	MILLES Mikro-Scheren	64
Meißel mit Ferrozellgriff, Flach-	611, 613-614	MILLIGAN Dura-Separator	698
Meißel mit Ferrozellgriff, Hohl-	611-616	MILLIN-YOUNG Bumerang-Nadelhalter	372
Meißel, Flach-	607, 609-610	MILLIN Blasenhalsspreizer	423
Meißel, Hohl-	607, 609-610	MILLIN Blasenwundspreizer	310
Meißel, Sternum-	492	MILLIN Fadenführungszange	423
MENGHINI Kanülen für die Leberblindpunktion	329	MILLIN Faßzange	423
MENGHINI Kanülen zur gezielten Leberpunktion	329	MILLIN Kapselfaßzange	423
Meniskusfaßzangen	640	MINI-HOHMANN Knochenheber	576
Meniskushaken	641	MINI-KERN Knochenhaltezeange	625
Meniskusmesser	642-643	MINI-LAMBOTTE Osteotome	608
MERCEDES Thoraxsperrer	507	MINI-LANGENBECK Wundhaken	224
Messbecher	751	MINI-LEXER Hohlmeißel mit Ferrozellgriff	612
Messer für Autopsie	40	MINI-LEXER Osteotome mit Ferrozellgriff	612
Messer, Amputations-	38-39	MINI-STILLE Gipsscheren	677
Messer, Beinhaut-	39	MINI-YASARGIL Anlegepinzetten	154
Messer, Gefäß-	694-695	MINI-YASARGIL Gefäßclips	154
Messer, Gips-	679	MIOTTI-OVERHOLT Präparier- und Ligaturklemmen	185
Messer, Hirn-	40	MIXTER-BABY Präparier- und Ligaturklemmen	180
Messer, Intima-	513	MIXTER-GEMINI Präparier- und Ligaturklemmen	181
Messer, Lappen-	39	MIXTER-O'SHAUGNESSY Präparier- und Ligaturklemme	182
Messer, Meniskus-	642-643	MIXTER-OVERHOLT Präparier- und Ligaturklemme	183
Messer, Nasenplastik-	37	MIXTER-PAUL (HEISS) Präparier- und Ligaturklemme	182
Messer, Organ-	40	MIXTER Chirurgische Scheren	79
Messer, Phalangen-	39	MIXTER Gallensteinzange	419
Messer, Resektions-	38-39	MIXTER Präparier- und Ligaturklemmen	182, 188-189
Messer, Sezier-	40	MOBERG Wundhaken	224
Messer, Zwischenknochen-	39	MOD. BONN Feine chirurgische Pinzetten	138
Meßinstrumente	6-7	MOD. CANAD. Meniskusmesser	643
Meßinstrumente für Laserchirurgie	448	MOD. KÖLN Kopfhautklammern	691
Meßsonde für Laserchirurgie	450	MOD. MÜNCHEN Endometrium-Strichkürette	459
Metallgriffe für Kehlkopfspiegel	13	MOD. SWITZERLAND Mikro-Pinzetten (Uhrmacher Modelle)	120
Metallkatheter	424	MOD. USA Anatomische Pinzetten	133
METZENBAUM-BABY Präparierscheren	89	MOD. USA Chirurgische Pinzetten	145
METZENBAUM-NELSON DURACUT Präparierscheren	53	MOD. USA Gipsspreizer	682
METZENBAUM-NELSON Präparierscheren	91	MOD. USA Nabelschnurschere	108
METZENBAUM-THOREK DURACUT Adnexscheren	54	MOD. USA Scharfe Löffel	601
METZENBAUM DURACUT Präparierscheren	49-52, 54	MOD. WIENER Fadenfänger	378
METZENBAUM Präparierscheren	88-90	MODELL RUSS. Gefäß- und Tumorzinnetten	149
MEYERDING Laminektomie-Wundspreizer	284	MOGEN Beschneidungs- (Circumcisions-) Instrument	426
MEYERDING Wundhaken	225	MOLDESSTADT Venenhaken	217
MICHEL Klammeranlege- und Entfernungszange	379	MÖLTGEN Winkelmesser	7
MICHEL Klammeranlegepinzette	379	MOORE-STAUDE Hakenzange	452
MICHEL Rhinoskopiepiegel	14	MOORE Gallenblasenlöffel	417
MICHEL Wundklammern	379	MORGAN-TISCHLER Uterus-Biopsiezange	464
MICRO-ADSON Feine anatomische Pinzetten	129	MORRIS-DE BAKEY ATRAUMATIC-GRIP Aortaklemmen	540
MICRO-ADSON Feine chirurgische Pinzetten	140-141	MORSE Sternotomie-Sperrer	499
MICRO-ADSON TITE GRIP Chirurgische Pinzetten	117	MOSQUITO-BABY (HARTMANN) Feine Arterienklemmen	164
MICRO-CASTROVIEJO Nadelhalter	358	MOSQUITO-HALSTED-DE BAKEY ATRAUMATIC-GRIP Feine Arterienklemmen	165
MICRO-CRILE Feine Arterienklemmen	166	MOSQUITO-HALSTED (HEISS) Feine Arterienklemmen	170
MICRO-HALSTED Feine Arterienklemmen	164	MOSQUITO-HALSTED Feine Arterienklemmen	164-165
MIDDELDORF Wundhaken	243	MOSQUITO-HALSTED TITAN-LINE Feine Arterienklemmen	164
Mikro-Absaugrohr	321	MOTT-PARKER Wundhaken	228
Mikro-Bulldogklemmen	162	MOYNIHAN Arterienklemmen	178
Mikro-Faßpinzetten	124	MOYNIHAN Gallensteinsonde	415
Mikro-Faßpinzetten PERFECT-GRIP	124	MÜHLING (KILLIAN) Septumschere	102
Mikro-Instrumente	694-697	MÜHLING Raspatorien	584
Mikro-Klingen zur Blutentnahme	473	MÜLLER-BIEMER Approximatoren	157
Mikro-Knüpfpinzetten	121-123	MÜLLER-VERBRUGGE Knochenheber	579
Mikro-Knüpfpinzetten PERFECT-GRIP	121-123	MÜLLER Approximatoren	158
Mikro-Nadelhalter	358-362	MUMMERY-LOCKHART Fistel Sondens	314
Mikro-Nadelhalter PERFECT-GRIP	359, 361-362	Mundkeil	22
Mikro-Nadelhalter TITE GRIP	338-339	Mundsperrer	22
Mikro-Pinzetten	125	MURLESS Kopfheber	481
Mikro-Pinzetten (Uhrmacher-Modelle)	120	MURPHY-LANE Luxationsheber	581
Mikro-Pinzetten TITE GRIP	118	MURPHY Stirnband	10
Mikro-Präparierscheren	65, 67	MURRAY-CRILE Nadelhalter	366
Mikro-Scheren	62-67	MUSEUX Hakenzangen	456
Mikroskopier-Pinzetten	121	Muskelklemme	728
MIKULICZ-BABY Peritoneumklemme	192	MYERS Venenstripper	315
MIKULICZ Leberhaken	255	Myomheber	458
MIKULICZ Peritoneumklemmen	192-193	Myrtenblattsonden	313
MIKULICZ Wundhaken	255		
MILAN Endocervix-Biopsieküretten	460		
MILLER-SENN Wundhaken	226		
MILLER Laryngoskope	28-31		

N

NABATOFF Venenstripper.....	315
Nabelschnurklemmen	486
Nabelschnurscheren	108
Nadel-Sterilisierdosen	357
Nadelführung	486
Nadelhalter	363-372
Nadelhalter, Bumerang-.....	372
Nadelhalter-Mikro	358-362
Nadelhalter-Mikro TITE GRIP	338-339
Nadelhalter PERFECT-GRIP.....	364-365
Nadelhalter PERFECT-GRIP, Mikro	359, 361-362
Nadelhalter TITE GRIP	340-350
Nadelhalter TITE GRIP für Linkshänder	341
Nadeln REVERDIN	373
Nadeln, Augen-	354
Nadeln, Darm-	354
Nadeln, Drahtumführungs-	660-661
Nadeln, Gefäß-	354
Nadeln, Näh-	354-356
Nadeln, Unterbindungs-	374-376
Nadelzieh-Pinzetten TITE GRIP	116
NAEGELE Geburtszangen	478
Nägel	654
Nagelausreißzange	645
Nagelbohrer	645
Nagelfeilen	18
Nagelhautscheren	16
Nagelhautzangen	17
Nagelscheren	16
Nagelspaltschere	81
Nagelspaltzange	17, 645
Nagelzangen	17
Nähapparat für Magen und Darm	404
Nähnadeln, chirurgisch	354-356
Nähseide	353
Nahtinstrumente	378
Nasenflügelhaken	221
Nasenflügelscheren	81
Nasenpinzetten	136-137
Nasenplastikmesser	37
Nasensaugrohre	324
Nasenscheren	101-102
Nasenscheren DURACUT	58
NEFF Meniskussmesser	642
NEGUS Arterien- und Tonsillenklemmen	179
NEIVERT-COTTLE Nasenflügelhaken	221
NEIVERT Nadelhalter	363
NEIVERT TITE GRIP Nadelhalter	342
NELATON Hohlsonden	314
NELSON-METZENBAUM DURACUT Präparierscheren	53
NELSON-METZENBAUM Präparierscheren	91
NELSON Chirurgische Pinzette	148
NELSON Trokare	318
Nerv-Approximator	159
Nerv-Präparierschere	93
Nervhäkchen	213-215
Nervwurzelhaken	701
Neurochirurgie-Scheren	100
NEW ORLEANS Nadelhalter	367
NEW ORLEANS TITE GRIP Nadelhalter	344
NEWS Trachealhäkchen	217
Nierenarterienklemme ATRAUMATIC-GRIP	537, 558
Nierenfaßzange	421
Nierenklemmen	190
Nierenklemmen ATRAUMATIC-GRIP	190
Nierenschalen	750
Nierensteinzangen	420-421
Nierenstiellklemmen	191
NOBLE-MAYO Präparierscheren	86
NORTHBENT (SPENCER) Ligatur- und Fadenscheren	352
Not-Tracheotomietrokare	728
NOTO Polypen- und Ovarienzange	457
NOTT Scheidenspekula	433
NOVAK Endometrium-Saug-Biopsiekurette	459

O

Obere Verschlussklemme ATRAUMATIC-GRIP	398
O'BRIEN Ligatur- und Fadenschere	352
OBWEGESER TITE GRIP Knüpfpinzetten	113
OBWEGESER Wundhaken	241
OCHSNER-ALLIS Darm- und Gewebefaßzange	383
OCHSNER-DIXON (CRILE-RANKIN) Feine Arterienklemmen	167
OCHSNER-KOCHER Arterienklemmen	177
OCHSNER-ROCHESTER Arterienklemmen	178
OCHSNER ATRAUMATIC-GRIP Aortaklemmen	539
OCHSNER Fadenpinzette	152
OCHSNER Gallenblasentrokare	318
OCHSNER Gallengangsonde	415
O'CONNOR-O'SULLIVAN Bauchdeckenhalter	304
O'CONNOR Hauthäkchen (Irishäkchen)	217
OEHLER TITE GRIP Chirurgische Pinzetten	118
Ohrhäkchen	213
Ohrkatheter	322
Ohrpinzetten	136-137
Öhrsonden	313
Öhrspritzen	332
OLDEBERG Hypophysenzange	719
OLIVECRONA-TOENNIS (SCOVILLE) Klammer-Anlegezangen für Silberklammern	690
OLIVECRONA Dura-Dissektoren	700
OLIVECRONA Hirnspatel	706
OLIVECRONA Trigemini-Schere	100
OLIVERCRONA (GIGLI) Drahtsägen	687
OLLIER Wundhaken	236
OLSEN-BABY-HEGAR TITE GRIP Nadelhalter	348
OLSEN-HEGAR Nadelhalter	370
OLSEN-HEGAR TITE GRIP Nadelhalter	348
OMBREDANNE Hammer	621
Operationsschere	80
Optiken für BERGER Kopfflupe	8
Organmesser	40
Oscillierende Gipsäge	680
Oscillierende Gipsäge - Ersatzteile	681
O'SHAUGNESSY-MIXTER Präparier- und Ligaturklemme	182
Osteotome	607-610
Osteotome mit Ferrozellgriff	611-613
O'SULLIVAN-O'CONNOR Bauchdeckenhalter	304
Ovarienzangen	457
OVERHOLT-BABY Präparier- und Ligaturklemme	183
OVERHOLT-GEISSENDOERFER Präparier- und Ligaturklemmen	184
OVERHOLT-MIOTTI Präparier- und Ligaturklemmen	185
OVERHOLT-MIXTER Präparier- und Ligaturklemme	183
OVERHOLT Präparier- und Ligaturklemmen	183-185

P

PACIFIC-KEVOURKIAN Uterus-Biopsiezange	464
Parametriummklemmen ATRAUMATIC-GRIP	197
Parametriumscheren DURACUT	60
PARK-ALAN Analspreizer	408
PARKER-LANGENBECK (US-ARMY) Wundhaken	231
PARKER-MOTT Wundhaken	228
PARKER Wundhaken	228
PASQUE EUFRATE TITE GRIP Nadelhalter	344
Patellazange	623
Patent-Ductusklemmen ATRAUMATIC-GRIP	531, 556
PAUFIQUE Feine chirurgische Pinzette	139
PAUL-MIXTER (HEISS) Präparier- und Ligaturklemme	182
PAUL Sehnenscheidenhaken	225
PAYR-BABY Darm- und Magenquetschklemme	403
PAYR Darm- und Magenquetschklemmen	403
PAYR Führungshohlsonden	377
PAYR Gefäßnadeln	354
PEAN-DE BAKEY ATRAUMATIC-GRIP Arterienklemmen	176
PEAN-DE BAKEY ATRAUMATIC-GRIP Gefäßklemmen	529
PEAN-ROCHESTER Arterienklemmen	175
PEAN (DIXON) Arterienklemmen	174
PEAN Arterienklemmen	173-174
PEDERSON Scheidenspekula	432-433
PEERS Tuckklemmen	202

PEET Splitterzangen	151
PEET TITE GRIP Splitterzangen	151
PELTESON Watteträger	317
Pelvishaken	258
PENFIELD Dura-Dissektoren	699
Penisklemmen	426
PENNINGTON Darm- und Gewebefaßzangen	387
PERCY Amputationsretraktoren	571
PERFECT-GRIP Mikro-Faßpinzetten	124
PERFECT-GRIP Mikro-Knüpfpinzetten	121-123
PERFECT-GRIP Mikro-Nadelhalter	359, 361-362
PERFECT-GRIP Nadelhalter	364-365
Perforatorium	485
Peripheralklemmen ATRAUMATIC-GRIP	534-536, 558
Peritoneal-Pneu-Kanülen	329
Peritoneumklemmen	192-193
Perkussionshämmer	2-3
PERMAN Bauchdeckenhalter	299
PERTHES Reibahnen	650
Phalangenmesser	39
PHANEUF Hysterektomieklappen	194
PIERCE Kieferhöhlentrockner	319
PIFFARD Lupusküretten	20
PINARD Stethoskop	5
Pinzetten, anatomisch	132-134
Pinzetten, Anlege-	154, 156
Pinzetten, ATRAUMATIC-GRIP, Gefäß-	135
Pinzetten, chirurgisch	144-148
Pinzetten, Cilien-	152
Pinzetten, Darm-	149
Pinzetten, Deckglas-	152
Pinzetten, Faden-	152
Pinzetten, Faß-	149
Pinzetten, fein, anatomisch	128-131
Pinzetten, fein, chirurgisch	138-143
Pinzetten, Gefäß-	148-149
Pinzetten, Gewebefaß-	126-127, 148
Pinzetten, Klammeranlage-	379
Pinzetten, Lungenfaß-	149
Pinzetten, Mikro-	125
Pinzetten, Mikro-, Faß-	124
Pinzetten, Mikro-, Knüpf-	121-123
Pinzetten, Mikro-, PERFECT-GRIP, Faß-	124
Pinzetten, Mikro- (Uhrmacher-Modelle)	120
Pinzetten, Mikroskopier-	121
Pinzetten, Nasen-	136-137
Pinzetten, Ohr-	136-137
Pinzetten, PERFECT-GRIP, Mikro-Knüpf-	121-123
Pinzetten, Splitter-	150
Pinzetten, TITE GRIP, anatomisch	113-115
Pinzetten, TITE GRIP, chirurgisch	117-118
Pinzetten, TITE GRIP, Gewebefaß-	116
Pinzetten, TITE GRIP, Knüpf-	113
Pinzetten, TITE GRIP, Mikro-	118
Pinzetten, TITE GRIP, Nadelzieh-	116
Pinzetten, Tumor-	148-149
Pinzetten, Tumorfaß-	126-127
Pinzetten, Wundnaht-	378
Pinzetten, zum Valvenwechsel	289
PIPER Geburtszange	480
Plazentarküretten	484
Plazentalöffel	484
Plazentanzangen	482-483
PLESTER Wundspreizer	275
Polypenzangen	457
POOLE Saugrohre	325
POTTS-DE BAKEY ATRAUMATIC-GRIP Patent-Ductusklemmen	531
POTTS-SMITH DURACUT Gefäßscheren	56
POTTS-SMITH Feine anatomische Pinzetten	130
POTTS-SMITH Feine chirurgische Pinzetten	143
POTTS-SMITH Gefäßscheren	96-97
POTTS-SMITH Präparierschere	98
POTTS-SMITH TITE GRIP Anatomische Pinzetten	114
POZZI Hakenzange	453
Präparierklemmen	180-189, 564
Präparierklemmen ATRAUMATIC-GRIP	186, 551
Präparierscheren	81-91, 95, 98
Präparierscheren DURACUT	47-54
Präparierscheren fein	92-93

Präparierscheren, Mikro-	65, 67
PRATT Fistelsonden (Krypthaken)	409
PRATT Hakenzangen	455
PRATT Mastdarm-Rektum-Spekulum	405
PREP-LUBE Instrumenten-Pflegemittel	733
PRESBYTERIAN Schlauchklemme	203
PRICE-THOMAS Bronchusklemmen	566
Profundaklemmen ATRAUMATIC-GRIP	534
Prostatahaken	422
Prostatektomie Instrumente	423
PROVIDENCE-HOSPITAL Feine Arterienklemmen	168
Proximalbeleuchtung-Kaltlicht für Amnioskop Tuben	472
Proximalbeleuchtung-Warmlicht für Amnioskop Tuben	472
Prüfinstrumente	6
PUTTI Raspeln	594
PVC-Schlauch zum Anschluß an Glaspipette	473
Pyloruspreizer	403
PYNCHON-ANDREW Saugrohr	325

Q

QUERVAIN Elevator	575
QUINBY Zahnfleischschere	94
QUINKE Kanülen zur Lumbalpunktion	328

R

RABINER Perkussionshammer	3
RAGNELL-DAVIS Haken für plastische Chirurgie	226
RAGNELL DURACUT Präparierscheren	49
RAGNELL Präparierscheren	83
RALK Handbohrapparat	653
RALKS (VIRTUS) Splitterzange	151
RAMPLEY Tupfer- und Schwammzangen	210
RANDALL Endometrium-Saug-Biopsiekürette	459
RANDALL Nierensteinzangen	420-421
RANEY Klammerbock	691
RANEY Kopfhautklammern	691
RANKIN-CRILE-DE BAKEY ATRAUMATIC-GRIP Feine Arterienklemmen	167
RANKIN-CRILE (OCHSNER-DIXON) Feine Arterienklemmen	167
RANKIN-CRILE Feine Arterienklemmen	167
RANKIN-KELLY Feine Arterienklemmen	169
Rasierklängen-Halter und -Brecher	36
Raspatorien	582-589, 694-695, 696-697
Raspatorien mit Ferrozellgriff	590-591
Raspatorien, Rippen-	495-497
Raspeln	592-595
Raspeln TITE GRIP	596-597
RAY Küretten	692
RECAMIER Plazentar- und Abortusküretten	484
RECAMIER Uterusküretten	468
REDO Darmklemmen	390
REDON Führungsadeln	334
Reflexhämmer	2-3
Reflexspiegel	10
Reibahnen	650
REINER Gipsmesser	679
Reinigungsbürste für Trachealkanülen	727
Reinigungsbürsten	756
Rektum-Spekula	405-406
Rektumklemmen	400-402
Rektumklemmen ATRAUMATIC-GRIP	400-401
Rektumschere	99
Repositionszangen	622-623
RESANO ATRAUMATIC-GRIP Rektum-Anastomosenklemme	401
Resektionssmesser	38-39
Resektionssägen	572-573
Retraktoren zur Fixation am OP-Tisch	704-705
Retraktoren zur Fixation am Schädell	702-703
Retraktoren, Amputations-	571
REVERDIN Bauch- und Darmspatel	267
REVERDIN Nadeln	373
REYNOLDS-COOLEY ATRAUMATIC-GRIP Anastomosenklemmen	559
REYNOLDS-DE BAKEY ATRAUMATIC-GRIP Anastomosenklemmen	542
REYNOLDS Feine Präparierscheren	93
REZEK-HEANEY Hysterektomieklappe	196
Rhinoskopspiegel	14

RICARD Bauchdeckenhalter	298
RICHARDSON-EASTMAN Wundhaken	250
RICHARDSON Wundhaken	251
RICHTER-HEATH Klammerentfernungszange	379
RICHTER Operationsschere	80
RIENHOFF-FINOCCHIETTO Rippensperrerr	506
Rippenfaßzangen	493
Rippenkontraktoren	508
Rippenraspatorien	495-497
Rippenscheren	492-493
Rippensperrerr	503-508
Rippensperrerr aus ALUMINIUM	500-502
ROBB Intima-Spatel und -Dilatatoren	512
ROBERTS Arterienklemmen	178
ROBSON-MAYO ATRAUMATIC-GRIP Darmklemmen	396
ROBSON-MAYO Darmklemmen	396
ROCHARD Bauchdeckenhaken	309
ROCHESTER-CARMALT Arterienklemmen	178
ROCHESTER-OCHSNER Arterienklemmen	178
ROCHESTER-PEAN Arterienklemmen	175
ROEDER Tuchklemme	201
ROGERS (HEANEY-DE BAKEY) ATRAUMATIC-GRIP Hysterektomieklammern	197
ROGERS (WERTHEIM-DE BAKEY) ATRAUMATIC-GRIP Parametriumklammern	197
ROGGE Sterilisierzangen	734
ROLLET Wundhäkchen	218
Röntgen-Maßstab	6
ROSCHKE Analspreizer	407
ROSE Wundhaken	227
ROSEGGER-KLIMA Kanülen zur Sternalpunktion	329, 518
ROSEN Saugkanülen	320
ROSER-KÖNIG Mundsperrerr	22
RÖTTGEN-RUSKIN Hohlmeißelzange	636
ROUX-BABY Wundhaken	228
ROUX Wundhaken	229
RUDD Hämorrhoiden-Ligatur	410
RUMEL-BELMONT Tourniquets	518
RUMEL-DE BAKEY ATRAUMATIC-GRIP Präparier- und Ligaturklemmen	186
RUMEL-DE BAKEY Präparier- und Ligaturklemmen	186
RUMEL Präparier- und Ligaturklemmen	186
Rundmeißelzange	494
RUSKIN-LISTON Knochensplitterzangen	638
RUSKIN-RÖTTGEN Hohlmeißelzange	636
RUSKIN-STILLE Hohlmeißelzange	636
RUSKIN Hohlmeißelzangen	633-634
RUSKIN Knochensplitterzangen	638
RUSS. MODELL Gefäß- und Tumorzangen	149
RUST Amputations- und Resektionssäge	573
RYDEL-SEIFFER Stimmgabel	4
RYDER-LANGENBECK TITE GRIP Nadelhalter	350
RYDER-VASCULAR TITE GRIP Nadelhalter	340
RYDER TITE GRIP Nadelhalter	340

S

SAALFELD Komedonenquetscher	19
SACHS Dura-Separatoren	698
SACHS Durahäkchen	217
SACHS Fistelhaken	221
SACHSE Meatotom	426
SAENGER Plazentar- und Abortuszangen	483
Sägen, Amputations-	572-573
Sägen, Draht-	687
Sägen, Fingerring-	645
Sägen, Gips-	679
Sägen, Resektions-	572-573
SALENIUS Meniskusmesser	642
SALING Amnioskop-Tuben	472
Salpingographie	474
SAMII-YASARGIL Tumor- und Gewebefaßpinzetten	126
SAMII Tumor- und Gewebefaßpinzetten	127
SANVENERO Scheren für plastische Chirurgie	70
SAROT Bronchusklemmen	566
SAROT Feine Arterienklemmen	171
SAROT TITE GRIP Nadelhalter	344
SATINSKY-BABY Anastomosen- (Vena Cava) Klemme	565
SATINSKY-DE BAKEY ATRAUMATIC-GRIP Bulldogklemmen	525

SATINSKY-DE BAKEY ATRAUMATIC-GRIP Gefäßklemmen	541
SATINSKY Anastomosen- (Vena Cava) Klemmen	565
SATINSKY Vena Cava-Schere	99
SATTERLEE Amputations- und Resektionssäge	572
SAUER Feine chirurgische Pinzetten	138
SAUERBRUCH-FREY Rippenschere	493
SAUERBRUCH-SCHNEIDER Raspatorium	588
SAUERBRUCH Abfallzange	735
SAUERBRUCH Nadel-Sterilisierdosen	357
SAUERBRUCH Rippenschere	492
SAUERBRUCH Wundhaken	242
Saughandgriff für ROSEN Saugkanülen	320
Saugkanülen	320-323
Saugrohre	324-327
Saugrohre, Nasen-	324
SCALP CONTOUR Wundspreizer	276
Scapula-Haken	260
SCHAAF Cilienpinzette	152
SCHÄDEL Tuchklemmen	200
Schädelhalter	689
Schädelöffnungsinstrumente	687
Schädelstanze	688
Schädelzangen	688
Schalen	748
Schalen, Dreieck-	750
Schalen, Nieren-	750
Schalen, Spül-	749
SCHAMBERG Komedonenquetscher	19
Scharfe Löffel	598-606, 695-696
Scharfe Löffel mit Ferrozellgriff	606
SCHUDE Scharfe Löffel	602
Scheidenhalter	434-437, 439
Scheidenspekula	430-442
SCHERBACK Scheidenspekula	442
Scheren, Arteriotomie-	95
Scheren, Bauchdecken-	106
Scheren, chirurgisch	71-83
Scheren, chirurgisch fein	68-70
Scheren, Coronararterien-	95
Scheren, Damm- (Episiotomie-)	107
Scheren, Darm-	109
Scheren, Draht-	665
Scheren, Dura-	100
Scheren, DURACUT, Adnex-	54
Scheren, DURACUT, chirurgisch	46
Scheren, DURACUT, Damm- (Episiotomie-)	60
Scheren, DURACUT, Draht-	665
Scheren, DURACUT fein	45
Scheren, DURACUT, Fistel-	45
Scheren, DURACUT für plastische Chirurgie	45
Scheren, DURACUT für Rektumchirurgie	59
Scheren, DURACUT, Gefäß-	45, 56-57
Scheren, DURACUT, Gips-	676
Scheren, DURACUT, Gynäkologische	60
Scheren, DURACUT, Iris-	45
Scheren, DURACUT, Ligatur-	353
Scheren, DURACUT, Nasen-	58
Scheren, DURACUT, Parametrium-	60
Scheren, DURACUT, Präparier-	47-54
Scheren, DURACUT, Septum-	59
Scheren, DURACUT, Uterus-	60
Scheren, DURACUT, Verband-	673
Scheren, DURACUT, Zahnfleisch-	55
Scheren, Faden-	352
Scheren, fein, Präparier-	92-93
Scheren, fein, Sehnen-	92
Scheren, Fistel-	80
Scheren für die Nervenpräparation	93
Scheren für Lungenlappen	99
Scheren für Neurochirurgie	100
Scheren für plastische Chirurgie	70, 82
Scheren für Vena Cava	99
Scheren, Gefäß-	80, 95-98
Scheren, Gips-	675-678
Scheren, Inzisions-	80
Scheren, Kephalotomie-	109
Scheren, Kleiderstoff-	674-675
Scheren, Knorpel-	82
Scheren, Ligatur-	352-353

Scheren, Mikro-	62-67
Scheren, Mikro-, Präparier-	65, 67
Scheren, Nabelschnur-	108
Scheren, Nagel-	16
Scheren, Nagelhaut-	16
Scheren, Nagelspalt-	81
Scheren, Nasen-	101-102
Scheren, Nasenflügel-	81
Scheren, Operations-	80
Scheren, Präparier-	81-91, 95, 98
Scheren, Rektum-	99
Scheren, Rippen-	492-493
Scheren, Septum-	103
Scheren, Tonsillen-	103
Scheren, Trigeminus-	100
Scheren, Uterus-	104-106
Scheren, Venen-	63
Scheren, Verband-	672-674
Scheren, Zahnfleisch-	94
Schieblehre	7
Schielhaken	213
Schilddrüsenhaken	243
SCHINK Dermatome	41
Schlauch- und Katheter-Führungszange	473
Schlauch, Stau-	570
Schlauch-PVC zum Anschluß an Gaspipette	473
Schlauchklemmen	203
Schlauchroller	203
Schlauchverbindungsstück für ROSEN Saugkanülen	320
SCHMID Gefäßspülkanülen	322
SCHMID Intima-Spatel	513
SCHMIEDEN-TAYLOR Duraschere	100
SCHMIEDEN Führungshohlsonde	378
SCHNEIDER-SAUERBRUCH Raspatorium	588
SCHNEIDER Raspatorium	588
Schneidezangen	666
SCHNIDT Arterien- und Tonsillenklemmen	179
SCHOEMAKER-LOTH Ligatur- und Fadenschere	352
Schreibgeräte	757
SCHRÖDER Hakenzangen	452, 454
SCHRÖDER Uteruslöffel	466
SCHUBERT Uterus-Biopsiezangen	461
SCHULTZE Salpingographie	474
SCHUMACHER Nabelschnurschere	108
SCHUMACHER Uterus-Biopsiezangen	463
Schüsseln, Wasch-	749
Schwammzangen	209-210
SCHWARTZ Anlegezange für Gefäßclips	155
SCHWARTZ Gefäßclips	155
Schwesterngarnitur	18
SCOVILLE-HAVERFIELD Laminektomie-Spreizer	286
SCOVILLE (OLIVECRONA-TOENNIS) Klammer-Anlegezangen für Silberklammern	690
SCOVILLE Haken für Wundspreizer	287
SCOVILLE Laminektomie-Spreizer	286
SCOVILLE Nervwurzelhaken	701
SCOVILLE Seitenvalven für Wundspreizer	287
SCUDDER ATRAUMATIC-GRIP Magenklammern	397
SEALY Feine chirurgische Scheren	68
SEBILEAU Elevator	575
SEDILLOT Raspatorien	586
SEGOND Hysterektomieklemmen	195-196
Sehnedurchziehungen	649
Sehneneinflechtungsklemmen	649
Sehnenfaßzangen	647
Sehnenführer	646
Sehnenführungszangen	648
Sehnenschäler	646
Sehnenscheidenhaken	225
Sehnenscheren fein	92
Seitenschneider	668
SEIFFER-RYDEL Stimmgabel	4
Seitenvalven für SCOVILLE Wundspreizer	287
Seitenvalven für TAYLOR Wundspreizer	287
Sekretlöffel	425
SELETZ-GELPI Vulva-Spreizer	281
SELLHEIM Geburtslöffel	481
SELLORS Rippensperrer und -kontraktor	508
SEMB Hohlmeißelzange	494
SEMB Knochensplitterzange	494
SEMB Lungenhaken	260
SEMB Präparier- und Ligaturklammern	564
SEMB Rippen- und Knochenfaßzangen	493
SEMB Rippenraspatorien	496
SEMKEN Feine anatomische Pinzetten	130
SEMKEN Feine chirurgische Pinzetten	142
SEMKEN TITE GRIP Anatomische Pinzette	113
SEMKEN TITE GRIP Chirurgische Pinzetten	117
SEMM Bauchdeckenhalter	305
SEMM Scheidenspekula	432
SENN-GREEN Wundhaken	224
SENN-MILLER Wundhaken	226
Sensibilitätsinstrumente	4
Separatoren-Dura	698
Septumkanülen	328
Septumschere	102
Septumscheren DURACUT	59
Sequesterzangen	623
SEUTIN Kleiderstoff- und Gipsscheren	675
SEWALL Raspatorien	582
Seziermesser	40
SHAMBAUGH Wundhaken	212
SIEBOLD-SIMS Uterusschere	106
SIEBOLD Uterusschere	106
Siebschalen für Sterilisation	744
Silberdraht	690
Silberklammern	690
SILVER Dermatome	41
SIMON-HEANEY Wundhaken	254
SIMON Fistelhaken	221
SIMON Scharfe Löffel	605
SIMON Uteruslöffel	466
SIMON Wundhaken	254
SIMPSON-BRAUN Geburtszangen	478
SIMPSON Uterussonden	446
SIMS-MAIER Korn- und Tupferzangen	205
SIMS-SIEBOLD Uterusschere	106
SIMS DURACUT Uterusscheren	60
SIMS Mastdarm-Rektum-Spekula	405-406
SIMS Scheidenspekula	438
SIMS Uterusküretten	467
SIMS Uterusscheren	104-105
SIMS Uterussonden	446
SINGLEY (TUTTLE) Lungenfaßpinzetten	149
Sinusklemmen	204
Skalpelloffeln	34-35
Skalpelloffeln	34-35
SMELLIE Perforatorium	485
SMILLIE Meniskusmesser	643
SMILLIE Wund- und Meniskushaken	641
SMITH-BUIE Analspreizer	408
SMITH-FERRIS-CUSHING Laminektomie-Zangen	713
SMITH-FERRIS Chirurgische Pinzetten	147
SMITH-HEYWOOD Zungenzangen	23
SMITH-KERRISON-FERRIS Laminektomie-Stanzen	709-710, 712
SMITH-POTTS DURACUT Gefäßscheren	56
SMITH-POTTS Feine anatomische Pinzetten	130
SMITH-POTTS Feine chirurgische Pinzetten	143
SMITH-POTTS Gefäßscheren	96-97
SMITH-POTTS Präparierschere	98
SMITH-POTTS TITE GRIP Anatomische Pinzetten	114
SMITH Verbandscheren	672
SOFT-GREGORY ATRAUMATIC-GRIP Karotisklemmen	527
SOMER Uterusfaßzange	458
Sonden	312-314
Sonden, Anal-	409
Sonden, Doppel-	694
Sonden, Fistel-	314, 409
Sonden, Führungshohl-	377-378
Sonden, für Laserchirurgie	450-451
Sonden, für Laserchirurgie, Meß-	450
Sonden, Gallengang-	415
Sonden, Gallenstein-	415
Sonden, Hohl-	314
Sonden, Knopf-	312-313, 694
Sonden, Kropf-	378
Sonden, Myrtenblatt-	313
Sonden, Ohr-	313

Sonden, Tränenkanal-	312
Sonden, Uterus-	446
Spatel, Bauch-	266-267
Spatel, Blasen-	268
Spatel, Darm-	266-267
Spatel, Hirn-	706
Spatel, Intima-	512-513
Spatel, Lungen-	260-265
Spekula für Laserchirurgie, Endo-	448
Spekula für lumbale Bandscheibenoperationen	295
Spekula für trans-sphenoidale Hypophysektomie	692
Spekula, Endo-	443
Spekula, Mastdarm-	405-406
Spekula, Rektum-	405-406
Spekula, Scheiden-	430-442
Spekulum für Laserchirurgie, Lateral-	448
SPENCER-WELLS Arterienklammern	173
SPENCER (NORTHBENT) Ligatur- und Fadenscheren	352
SPENCER Ligatur- und Fadenscheren	352
Spender, Bürsten-	752
Sperrer aus ALUMINIUM, Rippen-	500-502
Sperrer aus ALUMINIUM, Sternotomie-	498
Sperrer, Rippen-	503-508
Sperrer, Sternotomie-	499
Sperrer, Thorax-	507
Spezialkanülen	328
Sphinkteroskope	407
Spinal-Hohlmeißel mit Ferrozellgriff	616
Splitterpinzetten	150
Splitterzangen	151
Splitterzangen TITE GRIP	151
Spongiosa-Hohlmeißel mit Ferrozellgriff	615
Spornquetsche	403
SPRATT Scharfe Löffel	602
Spreizer, Anal-	407-408
Spreizer, Blasenhals-	423
Spreizer, Gips-	682
Spreizer, Pylorus-	403
Spreizer, Vulva-	281
Spreizer, Wirbelkörper-	296
Spreizer, Wund-	270-280, 282-285, 287-294
Spritzen	330-332
Spritzen, Insulin-	330
Spritzen, Ohr-	332
Spritzen, Tuberkulin-	330
Spritzen, Wund- und Blasen-	331
Spülschalen	749
SPURLING Laminektomie-Zangen	717
Sputumbecher	751
ST. MARKS Pelvishaken	258
ST. MARTIN feine chirurgische Pinzette	139
STACKE Knopfsonde	313
STADLER-BRAUN Damm- (Episiotomie-) Scheren	107
Stahlmaßband	6
Stahlmaßstäbe	6
STANDARD-YASARGIL Anlegepinzetten	154
STANDARD-YASARGIL Gefäßclips	154
Standgefäße	747
Stanzen, Haut-	20
Stanzen, Laminektomie-	707-712
Stanzen, Schädel-	688
Staubbinde	570
STAUDE-MOORE Hakenzange	452
Stauschlauch	570
Stechbecken	750
STEINMANN Nägel	654
STEINMANN Sehnenfaßzange	647
STELLBRING Hohlmeißelzangen	632
STELZNER (CRAFOORD) Lungenlappen- und Rektumschere	99
Sterilisier-Körbe	745
Sterilisier-Siebschalen	744
Sterilisierbehälter	738-742
Sterilisierdosen für Nadeln	357
Sterilisiergestelle für Nadeln	736
Sterilisiergestelle für Ringinstrumente	736
Sterilisierklammern	736
Sterilisierrahmen für Mikro-Instrumente	737
Sterilisiertrommeln	743
Sterilisierzangen	734

Sternotomie-Sperrer	499
Sternotomie-Sperrer aus ALUMINIUM	498
Sternnummeißel	492
Stethoskope	5
STEVENS Feine Präparier- und Sehnenscheren	92
STIEGLIZT (WILLIAMS) Splitterzangen	151
STILLE-BARRAYA Gefäß- und Tumorzinnetten	148
STILLE-CRAFOORD Feine Arterienklammern	170
STILLE-DOYEN Wundhaken	247
STILLE-GIERTZ Rippenschere	492
STILLE-LEKSELL Hohlmeißelzangen	635
STILLE-LUER Hohlmeißelzangen	634, 636
STILLE-MAYO DURACUT Präparierscheren	48
STILLE-MAYO Präparierscheren	85
STILLE-MINI Gipsscheren	677
STILLE-RUSKIN Hohlmeißelzange	636
STILLE-STRANDELL Sehnenscheidenhaken	225
STILLE Flachmeißel	610
STILLE Gipsscheren	677-678
STILLE Handbohrapparat	651
STILLE Hohlmeißel	610
STILLE Hohlmeißelzange	635
STILLE Osteotome	610
Stimmgabeln	4
Stirnbänder	10
Stirnlampen	11
Stirnspiegel	10
STOCKMANN Penisklemme	426
Stößel	606
Stößel mit Ferrozellgriff	606
STRANDELL-STILLE Sehnenscheidenhaken	225
STRATTE TITE GRIP Nadelhalter	347
STRAUSS Penisklemme	426
STRULLY Neurochirurgische Scheren	100
SUBRAMANIAN ATRAUMATIC-GRIP Aortaklammern	537
SULLIVAN (BROPHY) Feine Präparierscheren	93
SUPER Stethoskop	5
SWEET-LAHEY Präparier- und Ligaturklemme	189
SWITZERLAND MOD. Mikro-Pinzetten (Uhrmacher Modelle)	120
SYSTRUNK Nagelspaltschere	81

T

TAKAHASHI Laminektomie-Zangen	714
Tamponadeführer	447
Tamponzangen	208
TARNIER Geburtszange	480
TAYLOR-CUSHING Feine anatomische Pinzetten	130
TAYLOR-CUSHING Feine chirurgische Pinzette	143
TAYLOR-CUSHING Ohr- und Nasenpinzetten	136
TAYLOR-CUSHING TITE GRIP Anatomische Pinzette	114
TAYLOR-SCHMIEDEN Duraschere	100
TAYLOR Perkussionshammer	2
TAYLOR Seitenvälvn für Wundspreizer	287
TEALE Hakenzangen	456
Tenotom	37
THOMAS-PRICE Bronchusklemmen	566
THOMS-ALLIS Darm- und Gewebefaßzange	385
THOMS-GAYLOR Uterus-Biopsiezange	460
Thoraxklemme	564
Thoraxsperrer	507
THOREK-METZENBAUM DURACUT Adnexscheren	54
THOREK Präparierscheren	98
THORLAKSON ATRAUMATIC-GRIP Obere Verschlussklemme	398
THORLAKSON ATRAUMATIC-GRIP Untere Verschlussklemmen	399
THORLAKSON Wundhaken	230, 256-257
Tiefenmesser für Laserchirurgie	451
TISCHLER-BABY Uterus-Biopsiezange	464
TISCHLER-MORGAN Uterus-Biopsiezange	464
TISCHLER Uterus-Biopsiezangen	465
TITAN-LINE Bulldogklemmen aus Titan	160-161
TITAN-LINE Feine Arterienklammern	164, 166, 168
TITE GRIP Chirurgische Pinzetten	117-118
TITE GRIP Darmfaßzangen	388
TITE GRIP Drahtfaßzangen	663
TITE GRIP Drahtspannzangen	662
TITE GRIP Gewebefaß-Pinzetten	116
TITE GRIP Gewebefaßzangen	388
TITE GRIP Knüpfpinzetten	113

TITE GRIP Mikro-Nadelhalter	338-339
TITE GRIP Mikro-Pinzetten	118
TITE GRIP Nadelhalter	340-350
TITE GRIP Nadelhalter für Linkshänder	341
TITE GRIP Nadelzieh-Pinzetten	116
TITE GRIP Pinzetten, anatomisch	113-115
TITE GRIP Raspeln	596-597
TITE GRIP Splitterzangen	151
TOENNIS-ADSON DURACUT Präparierscheren	49
TOENNIS-ADSON Präparierscheren	89
TOENNIS-OLIVECRONA (SCOVILLE) Klammer-Anlegezangen für Silberklammern	690
TOENNIS Dura-Dissektoren	700
TOENNIS Nadelhalter	371
TOENNIS Präparierscheren	83
TOENNIS TITE GRIP Nadelhalter	350
TOHOKU Tuchklammern	202
TÖNNIS Duramesser	37
Tonsillenkanülen	328
Tonsillenklemmen	179
Tonsillenscheren	103
Tourniquets	518
TOWNSEND Uterus-Biopsiezangen	465
Trachealdilatator	728
Trachealhäkchen	217, 219-220, 728
Trachealhaken	226
Trachealkanülen	725-727
Tracheotomiebestecke	729-730
Tracheotomieinstrumente	728
Tracheotomietrokar für Notfälle	728
Tränenkanalsonden	312
Transformator	472
Transformator, klein für Stirnlampen	11
TRELAT Raspatorien	582
TRELAT Scheidenspekula	431
Trichter	751
Trigeminus-Schere	100
TROELTSCH (WILDE) Ohr- und Nasenpinzetten	137
TROELTSCH Ohr- und Nasenpinzetten	137
TROEMNER Perkussionshammer	3
Trokare	318
Trokare, Gallenblasen-	318
Trokare, Kieferhöhlen-	319-320
Trokare, Not-Tracheotomie-	728
TROUSSEAU Trachealdilatator	728
TROUTMAN-BARRAQUER Mikro-Nadelhalter	360
TROUTMANN Rasierklingen-Halter und -Brecher	36
TUBBS Aorta-Dilatator	511
Tuberkulin-Spritze	330
Tuchklammern	200-202
TUFFIER Bauch- und Darmspatel	267
TUFFIER Rippensperrer	506
Tumorfaspinzetten	126-127
Tumorpinzetten	148-149
Tunnelier-Instrumente	517
Tunnelier-Satz	516
TUOHY Kanülen zur Lumbalpunktion	328
Tupferträger	473
Tupferzangen	204-207, 209-210
TUTTLE (SINGLEY) Lungenfaspinzetten	149
TYRELL (GRAEFE) Hauthäkchen (Irishäkchen)	216

U

UCKERMANN Watteträger	317
UECKERMANN-DENKER Not-Tracheotomietrokare	728
UFFENORDE Scharfe Löffel	601
ULRICH Fistelmesser	37
ULRICH Knochenhalte-zangen	627
ULRICH Korn- und Tupferzangen	206
UNIVERSAL Drahtscheren	665
UNIVERSAL DURACUT Drahtscheren	665
UNIVERSAL Trokare	318
UNNA-VIDAL Komedonenquetscher	19
UNNA Komedonenquetscher	19
Unterarm-Wundspreizer	271
Unterbindungsnadeln	374-376
Untere Verschlussklemmen ATRAUMATIC-GRIP	399

Urethrographie-Instrument	426
Urologie-Instrumente	425-426
US-ARMY (PARKER-LANGENBECK) Wundhaken	231
USA MOD. Anatomische Pinzetten	133
USA MOD. Chirurgische Pinzetten	145
USA MOD. Gipsspreizer	682
USA MOD. Nabelschnurschere	108
USA MOD. Scharfe Löffel	601
Uterus-Biopsiezange	460-465
Uterus-Depressor	447
Uterus-Dilatatoren	443-445
Uterusfaßzangen	458
Uterusklemmzange	481
Uterusküretten	466-470
Uteruslöffel	466
Uterusscheren	104-106
Uterusscheren DURACUT	60
Uterussonden	446

V

VALLEIX Uterussonden	446
Valven für BALFOUR Bauchdeckenhalter	303
Valven für HENLEY Wundspreizer	283
Valven für KIRSCHNER-BALFOUR Bauchdeckenhalter	307
Valven für KIRSCHNER Bauchdeckenhalter	307
Valven für SCOVILLE Wundspreizer	287
Valven für Wundspreizer	289, 293
VAN BUREN Dilatationsbougies	424
VAN BUREN Sequesterzangen	623
VAN DOREN Uterus-Biopsiezange	461
VANNAS-YASARGIL Mikro-Scheren	66
VANNAS Mikro-Scheren	62-63, 65
VANNAS MOD. TÜBINGEN Mikro-Scheren	62
VARCO Feine Arterienklemme	170
VASCULAR-RYDER TITE GRIP Nadelhalter	340
VASCULAR PERFECT-GRIP Nadelhalter	364-365
Vena Cava-Klemmen ATRAUMATIC-GRIP	550
Vena Cava-Schere	99
Venenhaken	217, 222-223
Venenschere	63
Venenstripper	315
Ventil-Sprechkanülen	726-727
Verbandscheren	672-674
Verbandscheren DURACUT	673
Verbindungsstücke für Spritzen	333
VERBRUGGE-MÜLLER Knochenhebel	579
VERBRUGGE Knochenhalte-zangen	628
VERESS Peritoneal-Pneu-Kanülen	329
VERNET-GIL (MARBERGER) Venen- und Hilushaken	223
VICKERS Finger-Wundspreizer	270
VICKERS Hand- und Carpal- Tunnel-Wundspreizer	271
VICKERS Hand- und Unterarm-Wundspreizer	271
VICKERS Handhalter	644
VICKERS Mehrfach-Bohrdrahtspender	657
VIDAL-UNNA Komedonenquetscher	19
VIDAL Lupusschaber	19
VIRCHOW Hirnmesser	40
VIRTUS (RALKS) Splitterzange	151
WISE Mikro-Knüpfpinzetten	122
VOGEL Kieferhöhlenpunktionskanülen	319
VOLKMANN Scharfe Löffel	600, 602
VOLKMANN Scharfe Löffel mit Ferrozellgriff	606
VOLKMANN Wund- und Knochenhaken	232
VOLKMANN Wundhaken	233-234
VON PETZ Magen- und Darm-Nähapparat	404
Vorbohrer für Schädelhalter	689
Vulva-Spreizer	281

W

WAGENER Ohrhäkchen	213
WAGNER Hammer	620
WAGNER Knochenhebel	577
WAGNER Raspatorien mit Ferrozellgriff	591
WALB Organmesser	40
WALDMANN Damm- (Episiotomie-) Scheren	107
WALTON-LISTON (BÖHLER) Knochensplitterzangen	638

WANGENSTEEN Nadelhalter 369
WANGENSTEEN TITE GRIP Anatomische Pinzetten 115
WANGENSTEEN TITE GRIP Nadelhalter 347
 Warmlicht-Proximalbeleuchtung für Amnioskop Tuben 472
WARTENBERG Algesimeter 4
 Waschschüsseln 749
 Wasserstrahlreinigungspistole 754-755
WATSON-CHEYNE Dissektor 574
WATSON-WILLIAMS Raspel 593
 Watteträger 409, 316-317, 473
WAUGH Feine anatomische Pinzette 130
WAUGH Feine chirurgische Pinzette 143
WEBER Ästhesiometer 4
WEBER ATRAUMATIC-GRIP Aorta-Anastomosenklemmen 548
WEBSTER Nadelhalter 363
WEBSTER TITE GRIP Nadelhalter 342
WEIL-BLAKESLEY Laminektomie-Zangen 714
WEISSBARTH Scheidenspekulum 442
WEITLANER Wundspreizer 272-274
WELLS-SPENCER Arterienklemmen 173
WERTHEIM-CULLEN Nierenstiellklemme 191
WERTHEIM-DE BAKEY (ROGERS) ATRAUMATIC-GRIP
 Parametriumklemmen 197
WERTHEIM (BOZEMANN) TITE GRIP Nadelhalter 346
WERTHEIM Hysterektomieklammern 194-195
WERTHEIM Uterusscheren 105
WEST Flachmeißel 607
WEST Hohlmeißel 607
WIENER MOD. Fadenfänger 378
WIENER Raspeln 593
WILDE (TROELTSCH) Ohr- und Nasenpinzetten 137
WILLETT Kopfschwanzzange 481
WILLIAMS-WATSON Raspel 593
WILLIAMS (STIEGLITZ) Splitterzangen 151
WILLIAMS Darm- und Gewebefaßzange 388
WILLIGER Elevatorien 574
WILLIGER Hammer 617
WILLIGER Raspatorien 582
WILLIGER Scharfe Löffel 598, 600
 Winkelmesser 7
WINTER Plazentär- und Abortuszangen 482
WINTER Stethoskop 5
 Wirbelkörper-Biopsieinstrumentarium 720-721
 Wirbelkörperspreizer 296
WITTNER Uterus-Biopsiezangen 462
WOLFF Gipsabreißzangen 682
WOLFSON-DE MARTEL Dickdarm-Anastomosen-Klemmen 402
WOLFSON-DE MARTEL Klemmenhalter 402
WOLFSON-DE MARTEL Klemmenschließzange 402
WOOD-CRILE Nadelhalter 366, 368
WOOD-CRILE TITE GRIP Nadelhalter 343
WOOD-CRILE TITE GRIP Nadelhalter für Linkshänder 341
WRIGLEY Geburtszange 480
WULLSTEIN Mikro-Absaugrohr 321
WULLSTEIN Saugkanüle 322
WULLSTEIN Wundspreizer 275
 Wundhäkchen 212, 216-221
 Wundhaken 222-259, 261-265, 641
 Wundhaken, Kropf- 224
 Wundklammern 379
 Wundnahtbesteck 380
 Wundnahtpinzette 378
 Wundspreizer 270-280, 282-285, 287-294
 Wundspreizer für die Wirbelsäule 285, 288, 290-292, 294
 Wundspreizer, Appendektomie- 284
 Wundspreizer, Blasen- 310
 Wundspreizer, Finger- 270
 Wundspreizer, Hand- und Carpal- Tunnel- 271
 Wundspreizer, Hand- und Unterarm 271
 Wundspreizer, Hemilaminektomie- 277
 Wundspreizer, Laminektomie- 276, 279-280, 284, 286
 Wundspritzen 331
WYLIE ATRAUMATIC-GRIP Aorta-Anastomosenklemmen 549

Y

YANKAUER Saugrohre 325-326
YASARGIL-MINI Anlegepinzetten 154

YASARGIL-MINI Gefäßclips 154
YASARGIL-SAMII Tumor- und Gewebefaßpinzetten 126
YASARGIL-STANDARD Anlegepinzetten 154
YASARGIL-STANDARD Gefäßclips 154
YASARGIL-VANNAS Mikro-Scheren 66
YASARGIL Dissektoren 694
YASARGIL Fadenführer 697
YASARGIL Federhaken zur Galea-Fixation 691
YASARGIL Gefäßmesser 695
YASARGIL Hypophysenzange 719
YASARGIL Mikro-Pinzetten 125
YASARGIL Mikro-Präparierscheren 67
YASARGIL Mikro-Scheren 66-67
YASARGIL PERFECT-GRIP Mikro-Nadelhalter 362
YASARGIL Raspatorien 694-695
YASARGIL Saugrohre 324
YASARGIL Scharfer Löffel 695
YASARGIL Tumor- und Gewebefaßpinzetten 126
YEOMAN Mastdarm-Biopsiezangen 412
YOUNG-HRYNTSCHAK Bumerang-Nadelhalter 372
YOUNG-MILLIN Bumerang-Nadelhalter 372
YOUNG Bulbus-Haken 422
YOUNG Prostatahaken 422
YOUNG Zungenzange 23
YOUNGE-KEVOURKIAN Endocervix-Biopsieküretten 459
YOUNGE-KEVOURKIAN Uterus-Biopsiezange 463, 465

Z

Zahnfleischscheren 94
 Zahnfleischscheren DURACUT 55
 Zahnprothesenschale 751
 Zangen, Abfall- 735
 Zangen, Abortus- 482-483
 Zangen, Anlege- 155, 158, 160
 Zangen, ATRAUMATIC-GRIP, Darmfaß- 389
 Zangen, ATRAUMATIC-GRIP, Gewebefaß- 389
 Zangen, Darmfaß- 383-388
 Zangen, Drahtbiege- 666
 Zangen, Drahtfaß- 663-664
 Zangen, Drahtkneif- 666
 Zangen, DURACUT, Drahtkneif- 667
 Zangen, Entfernung- 160
 Zangen, Fadenführungs- 423
 Zangen, Faß- 423
 Zangen, für Bulldogklemmen, Anlege- 527
 Zangen, für Bulldogklemmen, Entfernung- 527
 Zangen, für Klammern, Abnehm- 691
 Zangen, für Klammern, Anlege- 690-691
 Zangen, für Wundklammern, Entfernung- 379
 Zangen, Gallenstein- 418-419
 Zangen, Gewebefaß- 383-388
 Zangen, Gipsabreiß- 682
 Zangen, Haken- 452-456
 Zangen, Hohlmeißel- 494, 631-636
 Zangen, Hypophysen- 719
 Zangen, IUP (Intrauterinpressar) Faß- 447
 Zangen, Kappen- 735
 Zangen, Kapsel- 423
 Zangen, Klammeranlege- 379
 Zangen, Klemmenschließ- 402
 Zangen, Knochenfaß- 493
 Zangen, Knochenhalte- 624-629
 Zangen, Knochensplitter- 494, 637-639
 Zangen, Knorpelfaß- 640
 Zangen, Kopfschwarten- 481
 Zangen, Korn- 204-207
 Zangen, Laminektomie- 713-719
 Zangen, Meniskusfaß- 640
 Zangen, Nagel- 17
 Zangen, Nagelauseiß- 645
 Zangen, Nagelhaut- 17
 Zangen, Nagelspalt- 17, 645
 Zangen, Nierenstein- 420-421
 Zangen, Ovarien- 457
 Zangen, Patella- 623
 Zangen, Plazentär- 482-483
 Zangen, Polypen- 457

Zangen, Repositions-	622-623
Zangen, Rippenfaß-	493
Zangen, Rundmeißel-	494
Zangen, Schädelstanz-	688
Zangen, Schneide-	666
Zangen, Schwamm-	209-210
Zangen, Sehnendurchzieh-	649
Zangen, Sehnenfaß-	647
Zangen, Sehnenführungs-	648
Zangen, Sequester-	623
Zangen, Splitter-	151
Zangen, Sterilisier-	734
Zangen, Tampon-	208
Zangen, TITE GRIP, Darmfaß-	388
Zangen, TITE GRIP, Drahtfaß-	663
Zangen, TITE GRIP, Drahtspann-	662
Zangen, TITE GRIP, Gewebefaß-	388
Zangen, TITE GRIP, Splitter-	151
Zangen, Tupfer-	204-207, 209-210
Zangen, Uterus-Biopsie-	460-465
Zangen, Uterusfaß-	458
Zangen, Uterusklemm-	481
Zangen, Zungen-	23
ZAUFAL-JANSEN Hohlmeißelzangen	633
ZENKER Präparier- und Ligaturklemmen	188
ZENKER Wundhaken	259
ZIEGLER Reflexspiegel	10
ZIEGLER Stirnband	10
ZIEGLER Stirnspiegel	10
ZIELKE Hohlmeißel mit Ferrozellgriff	614
Zirkel	7
ZOELLNER Mikro-Absaugrohr	321
Zubehör für LEYLA Retraktoren	703, 705
Zughebel für Geburtszangen	479
Zungenspatel	12
Zungenzangen	23
ZWEIFEL TITE GRIP Nadelhalter	349
Zwischenknochenmesser	39
Zylinder für Spritzen	330-331

A

- Abdominal Retractors 248-249, 297-309
 Abdominal Scissors 106
 Abdominal Spatulas 266-267
ABRAMS Pleura Puncture Needle 329, 518
 Accessory Lenses 9
ADAIR-ALLIS Intestinal and Tissue Grasping Forceps 384
ADAIR Uterine Tenaculum Forceps 452
ADAMS-MAYO Appendectomy Retractors 284
ADLERKREUTZ Vascular and Tumor Forceps 148
 Adnex Scissors, DURACUT 54
ADSON-ANDERSON Self-Retaining Retractor 276
ADSON-BABY Dissecting and Ligature Forceps 180
ADSON-BECKMANN Laminectomy Retractors 279
ADSON-BROWN Delicate Tissue Forceps 141
ADSON-BROWN TITE GRIP Tissue Forceps 117
ADSON-MICRO Delicate Dissecting Forceps 129
ADSON-MICRO Delicate Tissue Forceps 140-141
ADSON-MICRO TITE GRIP Tissue Forceps 117
ADSON-TOENNIS Dissecting Scissors 89
ADSON-TOENNIS DURACUT Dissecting Scissors 49
ADSON Delicate Dissecting Forceps 129
ADSON Delicate Haemostatic Forceps 169
ADSON Delicate Tissue Forceps 140-141
ADSON Drill Guide and Dura Protecting Forceps 650
ADSON Hemi-Laminectomy Retractors 277
ADSON Laminectomy Retractors 276, 280
ADSON Needle Holders 367
ADSON Nerve and Vessel Hooks 215
ADSON Raspatories 586
ADSON Self-Retaining Retractors 273, 276-278
ADSON Suction Cannulae 323
ADSON TITE GRIP Dissecting Forceps 113
ADSON TITE GRIP Tissue Forceps 117
ADSON Twist Drill 652
 Aesthesiometer 4
ALAN-PARK Rectal Retractor 408
ALDERDYCE Dissector 574
ALDINGER-HOHMANN Bone Lever 580
ALEXANDER-FARABEUF Rib Raspatories 497
ALEXANDER Cervical Biopsy and Specimen Forceps 463
ALEXANDER Chisels 609
ALEXANDER Gouges 609
ALEXANDER Osteotomes 609
 Algesimeters 4
ALLEN Intestinal Clamp Forceps 390
ALLIS-ADAIR Intestinal and Tissue Grasping Forceps 384
ALLIS-BABY Intestinal and Tissue Grasping Forceps 383
ALLIS-BOYS Intestinal and Tissue Grasping Forceps 384
ALLIS-JUDD Intestinal and Tissue Grasping Forceps 384
ALLIS-OCHSNER Intestinal and Tissue Grasping Forceps 383
ALLIS-THOMS Intestinal and Tissue Grasping Forceps 385
ALLIS ATRAUMATIC-GRIP Intestinal and Tissue Grasping Forceps 389
ALLIS Intestinal and Tissue Grasping Forceps 383-385
ALLISON Lung Spatula 260
ALM Self-Retaining Retractors 270
ALY Algesimeter 4
AMANN Uterine Gauze Packer 447
 Amnioscopic Tubes 472
 Amniotomy and Micro-Bloodletting Instruments 472-473
 Amniotomy 477
 Amputation and Resection Saws 572-573
 Amputation Knives 38-39
 Amputation Retractors 571
 Anastomosis (Vena Cava) Clamps 565
 Anastomosis and Intestinal Clamp Forceps 402
 Anastomosis Clamps, ATRAUMATIC-GRIP 520-523, 542-544, 559-560
 Anastomosis Clamps, Colon 402
 Anastomosis Sigmoid Forceps 400
ANDERSON-ADSON Self-Retaining Retractor 276
ANDREW-PYNCHON Suction Tube 325
 Anoscopes 407
 Antrum Trocar Needles 319
 Antrum Trocars 319-320
 Antrum Wash Cannulae 322
 Aorta-Anastomosis Clamps, ATRAUMATIC-GRIP 548-549
 Aorta-Aneurysma Clamps, ATRAUMATIC-GRIP 545-547
 Aortic Aneurysma Clamp, ATRAUMATIC-GRIP 561
 Aortic Clamps, ATRAUMATIC-GRIP 537-540, 561
 Aortic Dilators 511
 Apparatus and Pencils for Marking and Writing 757
 Appendectomy Clamp 403
 Appendectomy Retractors 284
 Applicators, Cotton 316-317
 Applying and Removing Forceps for Bulldog Clamps 160, 527
 Applying and Removing Forceps for Scalp Hemostasis Clips 691
 Applying Forceps for Approximators 158
 Applying Forceps for Vessel Clips 154-156
 Approximation Forceps 378
 Approximators 157-159
ARMY-US (PARKER-LANGENBECK) Retractors 231
ARMYTAGE-GREEN Caesarean Section Haemostatic Forceps 481
 Arteriotomy Scissors 95
ARTHUR Splinter Forceps 151
 Aspirating and Specimen Curettes 471
 Aspirating Curettes 471
 ATRAUMATIC-GRIP Anastomosis Clamps 520-523, 542-544, 559-560
 ATRAUMATIC-GRIP Aorta-Anastomosis Clamps 548-549
 ATRAUMATIC-GRIP Aorta-Aneurysma Clamps 545-547
 ATRAUMATIC-GRIP Aortic Aneurysma Clamp 561
 ATRAUMATIC-GRIP Aortic Clamps 537-540, 561
 ATRAUMATIC-GRIP Blood Vessel Clamps 556
 ATRAUMATIC-GRIP Bronchus Clamps 552
 ATRAUMATIC-GRIP Bulldog Clamps 525-528, 556
 ATRAUMATIC-GRIP Carotid Clamps 524, 527, 537
 ATRAUMATIC-GRIP Coarctation Clamps 532-533, 557
 ATRAUMATIC-GRIP Delicate Haemostatic Forceps 165, 167
 ATRAUMATIC-GRIP Dissecting and Ligature Forceps 551
 ATRAUMATIC-GRIP Hysterectomy Forceps 197
 ATRAUMATIC-GRIP Iliac Clamps 558
 ATRAUMATIC-GRIP Intestinal and Tissue Grasping Forceps 389
 ATRAUMATIC-GRIP Intestinal Clamp Forceps 391-393, 395-396
 ATRAUMATIC-GRIP Kidney Clamps 190
 ATRAUMATIC-GRIP Ligature and Dissecting Forceps 551
 ATRAUMATIC-GRIP Lower Occlusive Clamps 399
 ATRAUMATIC-GRIP Multi-Purpose Clamps 520-523, 530, 553-554, 556, 562
 ATRAUMATIC-GRIP Patent Ductus Clamps 531, 556
 ATRAUMATIC-GRIP Peripheral Vascular Clamps 534-536, 558
 ATRAUMATIC-GRIP Renal Artery Clamp 537, 558
 ATRAUMATIC-GRIP Sigmoid Anastomosis Forceps 400-401
 ATRAUMATIC-GRIP Stomach Clamp Forceps 397
 ATRAUMATIC-GRIP Tangential Occlusion Clamps 541, 562
 ATRAUMATIC-GRIP Upper Occlusive Clamp 398
 ATRAUMATIC-GRIP Vascular Clamps 520-523, 529-530, 534, 537, 555, 558, 561-562
 ATRAUMATIC-GRIP Vascular Forceps 135
 ATRAUMATIC-GRIP Vena-Cava Clamps 550
 ATRAUMATIC GRIP Dissecting and Ligature Forceps 186
 ATRAUMATIC GRIP Haemostatic Forceps 176
 ATRAUMATIC GRIP Profunda Clamps 534
 Atrium Retractors 509
AUFRICHT Plastic Surgery Scissors 82
AUFRICHT Rasps 593
 Auricle Clamps 564
AUSTIN Micro Suture Tying Forceps 122
 Autopsy Knife 40
AUVARD-BERLIND Vaginal Speculum 441
AUVARD Vaginal Specula 441

B

- BABCOCK** ATRAUMATIC-GRIP Intestinal and Tissue Grasping Forceps 389
BABCOCK Intestinal and Tissue Grasping Forceps 385
BABCOCK TITE GRIP Intestinal and Tissue Grasping Forceps 388
BABY-ADSON Dissecting and Ligature Forceps 180
BABY-ALLIS Intestinal and Tissue Grasping Forceps 383
BABY-BAILEY Rib Contractor 508
BABY-BALFOUR Abdominal Retractor 300
BABY-COLLIN Abdominal Retractor 297
BABY-CRILE Delicate Haemostatic Forceps 166
BABY-DOYEN ATRAUMATIC-GRIP Intestinal Clamp Forceps 391
BABY-DOYEN Intestinal Clamp Forceps 391
BABY-FINOCHIETTO-HAIGHT Rib Spreaders from ALUMINIUM 501
BABY-FINOCHIETTO Rib Spreaders 503

BABY-GELPI Vaginal Retractor	281	BERLIND-AUVAR Vaginal Speculum	441
BABY-GILLIES Needle Holders with Scissors	370	BERLINER Percussion Hammer	2
BABY-GILLIES TITE GRIP Needle Holder	348	BERNHARD Towel Clamps	201
BABY-GOSSET Abdominal Retractor	299	BETHUNE Rib Shears	493
BABY-KELLY Delicate Haemostatic Forceps	168	BEYER Bone Rongeurs	632-633
BABY-KOCHER ATRAUMATIC-GRIP Intestinal Clamp Forceps	391	BEYER Laminectomy Punch	707
BABY-KOCHER Intestinal Clamp Forceps	391	BIEMER-MÜLLER Approximators	157
BABY-LEXER Dissecting Scissors	87	BIEMER Vein Scissors	63
BABY-MEEKER Dissecting and Ligature Forceps	180	BIEMER Vessel Clips	156
BABY-METZENBAUM Dissecting Scissors	89	BIER Amputation and Resection Saw	573
BABY-MIKULICZ Peritoneum Forceps	192	Bile Duct Dilators, Common	416
BABY-MIXTER Dissecting and Ligature Forceps	180	BILL Traction Handle for Forceps	479
BABY-MOSQUITO (HARTMANN) Delicate Haemostatic Forceps	164	Binocular Head Magnifiers	8-9
BABY-OLSEN-HEGAR TITE GRIP Needle Holder	348	Binocular Magnifying Spectacles	9
BABY-OVERHOLT Dissecting and Ligature Forceps	183	Biopsy Curettes	459-460
BABY-PAYR Intestinal and Stomach Clamp	403	Biopsy Instruments, Bone	669
BABY-ROUX Retractors	228	Biopsy Instruments, Vertebral	720-721
BABY-SATINSKY Anastomosis (Vena Cava) Clamp	565	Biopsy Needles	329, 518
BABY-TISCHLER Cervical Biopsy and Specimen Forceps	464	Biopsy Specimen Forceps, Rectal	412
BACKHAUS Towel Clamps	201	BIRCHER-GANSKE Meniscus and Cartilage Grasping Forceps	640
BADGLEY Self-Retaining Retractors	286	BIRCHER Meniscus Knives	643
BAHNSON-DE BAKEY ATRAUMATIC-GRIP Aorta-Aneurysma Clamps	545	Bladder and Wound Syringes	331
BAILEY-BABY Rib Contractor	508	Bladder Neck Spreader	423
BAILEY-GIBBON Rib Contractor	508	Bladder Retractors	310
BAILEY (DE MARTEL) Conductor for Wire Saws	687	Bladder Spatulas	268
BAILEY ATRAUMATIC-GRIP Aortic Clamps	538	Blades	36
BAILEY Rib Contractor	508	Blades, Micro for Bloodletting	473
BAINBRIDGE-DE BAKEY ATRAUMATIC-GRIP Vascular Clamps	530	BLAKE-MAYO Gall Stone Forceps	418
BAINBRIDGE Intestinal Clamp Forceps	390	BLAKE Gall Stone Forceps	418
BAKES Common Bile Duct Dilators	416	BLAKE Uterine Curette	466
BALFOUR-BABY Abdominal Retractor	300	BLAKESLEY-WEIL Laminectomy Rongeurs	714
BALFOUR-KIRSCHNER Valve for Abdominal Retractors	307	BLESSING DURACUT Scissors for Rectal Surgery	59
BALFOUR Abdominal Retractors	300-301	Blood Vessel Clamps, ATRAUMATIC-GRIP	556
BALFOUR Central Valves for Abdominal Retractors	303	BLOUNT Hib Levers	580
BALFOUR Lateral Valves for Abdominal Retractors	303	BLOUNT Retractors for Knee	641
BALFOUR modif. Abdominal Retractors	302	BLUMENTHAL Bone Rongeurs	631
BALFOUR Side-Arms for Abdominal Retractors	303	BLUNT Safety Pin	736
BALLENGER-FOERSTER Dressing and Sponge Holding Forceps	209	BOETTCHER Tonsil Scissors	103
BALLENTINE-HEANEY Hysterectomy Forceps	196	BÖHLER (WALTON-LISTON) Bone Cutting Forceps	638
BALLENTINE Hysterectomy Forceps	196	BÖHLER Bone Rongeurs	633
Bandage and Cloth Scissors	674	BÖHLER Wire Traction Bows	654
Bandage Compressions	570	Bone Biopsy Instruments	669
Bandage Scissors	672-674	Bone Biopsy Trephines	669
Bandage Scissors, DURACUT	673	Bone Clamps	630
BARNES Suction Cannula	321	Bone Curettes	598-606
BARR Rectal Retractor	408	Bone Cutting Forceps	494, 637-639
BARRAQUER-TROUTMAN Micro Needle Holders	360	Bone Files	592, 594-595
BARRAQUER Cilia Forceps	152	Bone Holding and Rib Forceps	493
BARRAQUER Micro Needle Holders	360	Bone Holding Forceps	624-629
BARRAYA-STILLE Vascular and Tumor Forceps	148	Bone Levers	576-581
Barrels	330-331	Bone Retractors	232
BARRETT Uterine Tenaculum Forceps	452	Bone Rongeurs	631-636
BARTH Bone Curette	599	Bone Wires	660
Basins, Triangular	750	BONN MOD. Delicate Tissue Forceps	138
Baskets, Brush and Towel	753	BONNEY Dissecting Forceps	134
Baskets, Sterilizing	745	BONNEY Tissue Forceps	147
Baskets, Towel and Brush	753	BONNEY TITE GRIP Dissecting Forceps	115
BAUMGARTNER-HEGAR TITE GRIP Needle Holder	342	BONNEY TITE GRIP Tissue Forceps	118
BAUMGARTNER Needle Holders	366	Boomerang Needle Holders	372
BAUMGARTNER TITE GRIP Needle Holder	342	BOSE Trachea Retractors	728
BEACHAM Amniotome	477	Bougies, Dilating	424
BECK-COOLEY ATRAUMATIC-GRIP Anastomosis Clamps	560	Bowl for Dentures	751
BECK-DE BAKEY ATRAUMATIC-GRIP Anastomosis Clamps	543	Bowls, Kidney	750
BECK-DE BAKEY ATRAUMATIC-GRIP Aortic Clamps	537	Bowls, Solution	749
BECK-DE BAKEY ATRAUMATIC-GRIP Vena-Cava Clamps	550	Bowls, Wash	749
BECKMANN-ADSON Laminectomy Retractors	279	Boxes, Instrument	746
BECKMANN-EATON Laminectomy Retractors	280	Boxes, Sterilizing	739-742
BECKMANN Laminectomy Retractors	280	BOYS-ALLIS Intestinal and Tissue Grasping Forceps	384
Bed Pan	750	BOZEMANN-DOUGLAS Uterine Dresssing Forceps	208
BEEBEE Wire Cutting Scissors	665	BOZEMANN (WERTHEIM) TITE GRIP Needle Holders	346
BEER Cilia Forceps	152	BOZEMANN Uterine Dresssing Forceps	208
BELMONT-RUMEL Tourniquets	518	Brain Clips	690
BENGOLEA Delicate Haemostatic Forceps	172	Brain Knives	40
BENNETT Bone Levers	581	Brain Retractors, Self-Retaining	702-705
BENSON Pylorus Spreader	403	Brain Spatulas	706
BERGER Binocular Head Magnifiers	8	BRAND Tendon Holding Forceps	648
BERGER Cervical Biopsy and Specimen Forceps	462	BRAUN-SIMPSON Forceps	478
BERGMANN Cloth Scissors and Plaster-of-Paris Shears	675	BRAUN-STADLER Perineum (Episiotomy) Scissors	107
BERGMANN Mallets	621	BRAUN Cranioclast	485

BRAUN Decapitating Hook	485
BRAUN Uterine Depressor	447
BRAUN Uterine Tenaculum Forceps	452, 454
BRAWLEY Rasp	593
Breakers, Plaster	682
BREISKY Vaginal Specula	438, 440
BRIDGE Dissecting and Ligature Forceps	187
BRINKERHOFF Rectal Specula	406
Bronchus Clamps, ATRAUMATIC-GRIP	552
Bronchus Forceps	566
BROPHY (SULLIVAN) Delicate Dissecting Scissors	93
BROPHY Delicate Dissecting Forceps	131
BROPHY Delicate Tissue Forceps	143
BROWN-ADSON Delicate Tissue Forceps	141
BROWN-ADSON TITE GRIP Tissue Forceps	117
BROWN Needle Holders	366
BROWN Tissue Seizing Forceps	148
BROWNE-DENIS Abdominal Retractor	305
BRUENINGS Tongue Depressor	12
BRUNNER Retractors for Deep Surgery	252-253
BRUNNER Sigmoid Anastomosis Forceps	400
BRUNS Plaster-of-Paris Shears	676
BRUNS Bone Curettes	602-603
BRUNS DURACUT Plaster-of-Paris Shears	676
Brush and Towel Baskets	753
Brush Dispensers	752
Brushes, Cleaning	756
Brushes, Cleaning for Trachea Tubes	727
Brushes, Nail	752
BUCHWALD Tongue Depressor	12
BUCK-GRAMCKO Bone Lever	576
BUCK Percussion Hammer	3
BUELAU Empyema Trocar	318
BUIE-SMITH Rectal Retractor	408
BUIE Pressure Clamp	409
Bulbus Hooks	422
Bulldog Clamps	163
Bulldog Clamps, ATRAUMATIC-GRIP	525-528, 556
Bulldog Clamps, Micro	162
Bulldog Clamps, TITAN LINE	160-161
BUMM Placenta and Ovum Curettes	484
BUMM Uterine Curettes	470
BUNNELL Hand Drill	653
BUNNELL Tendon Passing Instrument	646
BUNNELL Tendon Strippers	646
BURFORD-FINOCCHIETTO Rib Spreaders	503
BURFORD-FINOCCHIETTO Rib Spreaders from ALUMINIUM	502
BURKE Cervical Biopsy and Specimen Forceps	464
Burrs	652
BUSH Umbilical Cord Scissors	108
Buttoned Probes	312-313, 694

C

Caesarean Section Haemostatic Forceps	481
Calipers	7
CALNE ATRAUMATIC-GRIP Vena-Cava Clamps	550
CANAD. MODELL Meniscus Knives	643
CANNON Endarterectomy Set	515
CANNON Endarterectomy Stripper	514
CANNON Intima Knife	513
CANNON Intima Spatula	513
Cannulae, Antrum Wash	322
Cannulae, Suction	320-323
Cannulae, Trocar	721
Cannulae, Vascular Irrigation	322
CAPLAN DURACUT Septum Scissors	59
Capsule Forceps	423
CARMALT-ROCHESTER Haemostatic Forceps	178
Carotid Clamps, ATRAUMATIC-GRIP	524, 527, 537
CAROTIS-DE BAKEY ATRAUMATIC-GRIP Bulldog Clamps	525
Carpal Tunnel and Hand Retractor	271
Carrier for Clips	690-691
Carrier for Micro Blades	473
CARROLL Needle Holders	366
CARROLL Tendon Holding Forceps	648
CARROLL TITE GRIP Needle Holder	344
Cartilage Grasping and Meniscus Forceps	640
Cartilage Scissors	82
Cases, Sterilizing and Storing	738
CASPAR Exploration and Coagulation Hooks	215
CASPAR Laminectomy Rongeurs	718-719
CASPAR Raspatories	585
CASPAR Retractor	245
CASPAR Self-Retaining Retractors	288-294
CASPAR Specula for Lumbar Vertebral Operations	295
CASTANEDA ATRAUMATIC-GRIP Anastomosis Clamps	520
CASTANEDA ATRAUMATIC-GRIP Multi-Purpose Clamps	520
CASTANEDA Rib Spreaders from ALUMINIUM	500
CASTROVIEJO-MICRO Micro Needle Holders	358
CASTROVIEJO Calipers	7
CASTROVIEJO Delicate Tissue Forceps	138
CASTROVIEJO Needle Holder	363
CASTROVIEJO Razor Blade Holders and Breakers	36
CASTROVIEJO TITE GRIP Micro Needle Holders	338-339
Catgut	353
Catheter Introducing Forceps	32
Catheter Introducing Instrument	425
Catheters, Eustachian	322
Catheters, Metal	424
Catheter Guides	425
CATLIN Amputation Knives	38
Cerclage Instruments	660
Cervical Biopsy and Specimen Forceps	460-465
Cervical Spine Retractors	285
Cervical Traction Tongs	689
Cervical Vertebral Column Retractors	290-292
CHAMPY Bone Biopsy Trephines	669
CHAPUT Intestinal and Tissue Grasping Forceps	383
CHARRIÈRE Amputation and Resection Saw	572-573
CHEATTLE Sterilizing Forceps	734
CHERON Sponge and Dressing Forceps	207
CHEVALIER-JACKSON Trachea Tubes	726
CHEVALIER Rib Spreaders	507
CHEYNE-WATSON Dissector	574
CHILDE Approximation Forceps	378
Chisel Blades, Interchangeable	611
Chisels	607, 609-611
Chisels, Sternum	492
Cilia Forceps	152
Circumcision Clamp	426
Circumcision Instruments	426
CITELLI Laminectomy Punches	707
Clamp Closing Forceps	402
Clamp Holders	402
Clamps, Anastomosis (Vena Cava)	565
Clamps, Appendectomy	403
Clamps, ATRAUMATIC-GRIP, Anastomosis	520-523, 542-544, 559-560
Clamps, ATRAUMATIC-GRIP, Aorta-Anastomosis	548-549
Clamps, ATRAUMATIC-GRIP, Aorta-Aneurysma	545-547
Clamps, ATRAUMATIC-GRIP, Aortic	537-540, 561
Clamps, ATRAUMATIC-GRIP, Aortic Aneurysma	561
Clamps, ATRAUMATIC-GRIP, Blood Vessel	556
Clamps, ATRAUMATIC-GRIP, Bronchus	552
Clamps, ATRAUMATIC-GRIP, Bulldog	525-528, 556
Clamps, ATRAUMATIC-GRIP, Carotid	524, 527, 537
Clamps, ATRAUMATIC-GRIP, Coarctation	532-533, 557
Clamps, ATRAUMATIC-GRIP, Iliac	558
Clamps, ATRAUMATIC-GRIP, Kidney	190
Clamps, ATRAUMATIC-GRIP, Lower Occlusive	399
Clamps, ATRAUMATIC-GRIP, Multi-Purpose Clamps	520-523, 530, 553-554, 556, 562
Clamps, ATRAUMATIC-GRIP, Patent Ductus	531, 556
Clamps, ATRAUMATIC-GRIP, Peripheral Vascular	534-536, 558
Clamps, ATRAUMATIC-GRIP, Profunda	534
Clamps, ATRAUMATIC-GRIP, Renal Artery	537, 558
Clamps, ATRAUMATIC-GRIP, Tangential Occlusion	541, 562
Clamps, ATRAUMATIC-GRIP, Upper Occlusive	398
Clamps, ATRAUMATIC-GRIP, Vascular	520-523, 529-530, 534, 537, 555, 558, 561-562
Clamps, ATRAUMATIC-GRIP, Vena Cava	550
Clamps, Auricle	564
Clamps, Bone	630
Clamps, Bulldog	163
Clamps, Circumcision	426
Clamps, Colon-Anastomosis	402
Clamps, Fixation for the Spermatic Cord	425

Clamps, Intestinal and Stomach	403
Clamps, Kidney	190
Clamps, Kidney Pedicle	191
Clamps, Micro Bulldog	162
Clamps, Muscular	728
Clamps, Penis	426
Clamps, Pressure	409
Clamps, Stomach and Intestinal	403
Clamps, TITAN LINE, Bulldog	160-161
Clamps, Towel	200-202
Clamps, Tubing	203
Clamps, Umbilical Cord	486
Clamps, Vascular, Semi-Flexible	563
Clamps, Vena Cava (Anastomosis)	565
CLAR Head Light	11
Cleaning Brush for Trachea Tubes	727
Cleaning Brushes	756
CLEVELAND Bone Cutting Forceps	637
Clip Applying and Removing Forceps	379
Clip Applying Forceps	690
Clip Carrier	690-691
Clip Instruments	690-691
Clips, Brain	690
Clips, Scalp Hemostasis	691
Clips, Suture	379
Clips, Suture	404
Cloth and Bandage Scissors	674
Cloth Scissors	674-675
CLOWARD Lamina Spreaders	296
CLOWARD Retractors for Cervical Spine	285
Coagulation and Exploration Hooks	215
COAKLEY Antrum Trocar	319
Coarctation Clamps, ATRAUMATIC-GRIP	532-533, 557
COBB Raspatories	589, 591
COBB Spinal Gouges	616
COLCLOUGH (KERRISON-LOVE) Laminectomy Punches	710-711
Cold-Light Proximal Illumination for Amnioscopic Tubes	472
COLLER-CRILE Delicate Haemostatic Forceps	167
COLLIER Needle Holder	363
COLLIN-BABY Abdominal Retractor	297
COLLIN-DUVAL Intestinal and Tissue Grasping Forceps	386
COLLIN-DUVAL Intestinal Forceps	149
COLLIN-FARABEUF Raspatories	588
COLLIN-HARTMANN Retractor	229
COLLIN-LANDAU Vaginal Specula	431
COLLIN Abdominal Retractors	297-298
COLLIN ATRAUMATIC-GRIP Intestinal and Tissue Grasping Forceps	389
COLLIN Clip Removing Forceps	379
COLLIN Dynamometer	6
COLLIN Intestinal and Tissue Grasping Forceps	386
COLLIN Mallet	617
COLLIN Retractors	227
COLLIN Sponge and Dressing Forceps	207
COLLIN Tongue Holding Forceps	23
COLLIN Umbilical Cord Clamp	486
COLLIN Uterine Elevating Forceps	458
COLLIN Vaginal Specula	431
Colon-Anastomosis Clamps	402
Comedo Extractors	19
Common Bile Duct Dilators	416
Compression Bandage	570
Compression Tube	570
Comprimeter	570
Conductors, Ligature	377-378
Conductors, Wire Saws	687
CONE Cranial Punch Rongeur	688
Conisation Pin	447
Connecting Pieces for Syringes	333
Containers	747
CONTOUR SCALP Self-Retaining Retractors	276
Contractors, Rib	508
CONVERSE (GILLIES) Dura and Skin Retractors	216
CONVERSE TITE GRIP Needle Holder	342
COOLEY-BECK ATRAUMATIC-GRIP Anastomosis Clamps	560
COOLEY-DERRA ATRAUMATIC-GRIP Anastomosis Clamps	559
COOLEY-REYNOLDS ATRAUMATIC-GRIP Anastomosis Clamps	559
COOLEY Aortic Dilator	511
COOLEY ATRAUMATIC-GRIP Anastomosis Clamps	560
COOLEY ATRAUMATIC-GRIP Aortic Aneurysma Clamp	561
COOLEY ATRAUMATIC-GRIP Aortic Clamp	561
COOLEY ATRAUMATIC-GRIP Bulldog Clamps	556
COOLEY ATRAUMATIC-GRIP Coarctation Clamps	557
COOLEY ATRAUMATIC-GRIP Iliac Clamps	558
COOLEY ATRAUMATIC-GRIP Multi-Purpose Clamps	556, 562
COOLEY ATRAUMATIC-GRIP Patent Ductus Clamps	556
COOLEY ATRAUMATIC-GRIP Peripheral Vascular Clamp	558
COOLEY ATRAUMATIC-GRIP Renal Artery Clamps	558
COOLEY ATRAUMATIC-GRIP Tangential Occlusion Clamps	562
COOLEY ATRAUMATIC-GRIP Vascular Clamps	555
COOLEY Atrium Retractors	509
COOLEY Intracardiac Suction Tube	327
COOLEY Left Ventricular Sump Suction Tube	327
COOLEY Sternotomy Spreaders	499
COOLEY Sternotomy Spreaders from ALUMINIUM	498
COOLEY Suction Tubes	327
COOLEY Vascular Dilators	510
COOLEY Vascular Suction Tube	327
COOPER Ligature Needle	374
Coronary Artery Scissors	95
CORWIN-HEGAR TITE GRIP Wire Twisting Forceps	662
CORYLLOS Retractors and Lung Spatulas	261
COTTLE-NEIVERT Hook for Posterior Nares	221
COTTLE Dura and Skin Retractor	217
COTTLE DURACUT Nasal Scissors	58
COTTLE Hook for Plastic Surgery	218
COTTLE Mallet	620
COTTLE Nasal Scissors	102
COTTLE Osteotomes	608
COTTLE Rasp	593
COTTLE Raspatory	583, 585
Cotton and Sponge Holder	473
Cotton Applicators	316-317
Cotton Carrier	409
Cover Glass Forceps	152
CRAFOORD-DE BAKEY ATRAUMATIC-GRIP Aorta-Aneurysma Clamps	546
CRAFOORD-STILLE Delicate Haemostatic Forceps	170
CRAFOORD (STELZNER) Lobectomy and Rectal Scissors	99
CRAFOORD Auricle Clamps	564
CRAFOORD Delicate Haemostatic Forceps	171
CRAIG-KOGLER Vertebral Biopsy Instruments	720-721
Cranial Opening Instruments	687
Cranial Punch Rongeur	688
Cranial Rongeur	688
Cranial Rongeur Forceps	688
Cranioclast	485
CRILE-BABY Delicate Haemostatic Forceps	166
CRILE-COLLER Delicate Haemostatic Forceps	167
CRILE-MICRO Delicate Haemostatic Forceps	166
CRILE-MURRAY Needle Holders	366
CRILE-RANKIN-DE BAKEY ATRAUMATIC-GRIP Delicate Haemostatic Forceps	167
CRILE-RANKIN (OCHSNER-DIXON) Delicate Haemostatic Forceps	167
CRILE-RANKIN Delicate Haemostatic Forceps	167
CRILE-WOOD Needle Holders	366, 368
CRILE-WOOD TITE GRIP Needle Holders	343
CRILE-WOOD TITE GRIP Needle Holders for Left-Hander	341
CRILE Delicate Haemostatic Forceps	166
CRILE Needle Holders	371
CRILE Nerve and Vessel Hooks	214
CRILE Retractor	227
CRILE TITAN LINE Delicate Haemostatic Forceps	166
CRUTCHFIELD Cervical Traction Tongs	689
CRUTCHFIELD Drill Point for Cervical Traction Tongs	689
Cryothyrotomy Trocars	728
Crypt Hooks	409
CULLEN-WERTHEIM Kidney Pedicle Clamp	191
Cups, Storing	737
Curettes	692
Curettes, Aspirating	471
Curettes, Aspirating and Specimen	471
Curettes, Biopsy	459-460
Curettes, Bone	598-606
Curettes, Endocervical Biopsy	459-460
Curettes, Endometrical Biopsy	459
Curettes, Endometrical Suction Biopsy	459
Curettes, Lupus	20
Curettes, Ovum and Placenta	484
Curettes, Placenta and Ovum	484

Curettes, Secretion	425
Curettes, Specimen and Aspirating	471
Curettes, Uterine	466-470
CURTIS Tissue Forceps	147
CUSCO Vaginal Specula	430-431
CUSHING-LANDOLT Specula for Trans-Sphenoidal Hypophysectomy	692
CUSHING-SMITH-FERRIS Laminectomy Rongeurs	713
CUSHING-TAYLOR Delicate Dissecting Forceps	131
CUSHING-TAYLOR Delicate Tissue Forceps	143
CUSHING-TAYLOR Ear and Nasal Dressing Forceps	136
CUSHING-TAYLOR TITE GRIP Dissecting Forceps	114
CUSHING Brain Spatulas	706
CUSHING Decompression Hook	701
CUSHING Delicate Dissecting Forceps	130
CUSHING Delicate Tissue Forceps	142
CUSHING Drills	652
CUSHING Dura Hook	218
CUSHING Laminectomy Rongeurs	715
CUSHING Nerve and Vessel Hooks	214
CUSHING TITE GRIP Dissecting Forceps	114
CUSHING Vein Retractors	222-223
Cuticle Nippers	17
Cuticle Scissors	16
Cutters	667-668
Cutters, DURACUT, Wire	667
CUZZI Placenta and Ovum Scoops	484
CZERNY Rectal Speculum	405
CZERNY Uterine Tenaculum Forceps	455

D

DAHLGREN Cranial Rongeur	688
DALE ATRAUMATIC-GRIP Peripheral Vascular Clamps	535
DANDY Delicate Haemostatic Forceps	165
DANDY Nerve and Vessel Hooks	214
DARDIK ATRAUMATIC-GRIP Multi-Purpose Clamps	554
DARTIGUES Kidney Elevating Forceps	421
DAUBENSPECK Bone Curette	604
DAVIDSON Scapula Retractors	260
DAVIS-RAGNELL Hook for Plastic Surgery	226
DAVIS Brain Spatulas	706
DAY Ear Hooklets	213
DE BAKEY-BAHNSON ATRAUMATIC-GRIP Aorta-Aneurysma Clamps	545
DE BAKEY-BAINBRIDGE ATRAUMATIC-GRIP Vascular Clamps	530
DE BAKEY-BECK ATRAUMATIC-GRIP Anastomosis Clamps	543
DE BAKEY-BECK ATRAUMATIC-GRIP Aortic Clamps	537
DE BAKEY-BECK ATRAUMATIC-GRIP Vena-Cava Clamps	550
DE BAKEY-CAROTIS ATRAUMATIC-GRIP Bulldog Clamps	525
DE BAKEY-CRAFOORD ATRAUMATIC-GRIP Aorta-Aneurysma Clamps	546
DE BAKEY-CRILE-RANKIN ATRAUMATIC-GRIP Delicate Haemostatic Forceps	167
DE BAKEY-DERRA ATRAUMATIC-GRIP Anastomosis Clamps	542
DE BAKEY-DIETRICH ATRAUMATIC-GRIP Bulldog Clamps	526
DE BAKEY-GLOVER ATRAUMATIC-GRIP Bulldog Clamps	525
DE BAKEY-GUYON ATRAUMATIC-GRIP Kidney Clamps	190
DE BAKEY-HALSTED-MOSQUITO ATRAUMATIC-GRIP Delicate Haemostatic Forceps	165
DE BAKEY-HARKEN ATRAUMATIC-GRIP Dissecting and Ligature Forceps	551
DE BAKEY-HEANY (ROGERS) Hysterectomy Forceps	197
DE BAKEY-MORRIS ATRAUMATIC-GRIP Aortic Clamps	540
DE BAKEY-PEAN ATRAUMATIC-GRIP Haemostatic Forceps	176
DE BAKEY-PEAN ATRAUMATIC-GRIP Vascular Clamps	529
DE BAKEY-POTTS ATRAUMATIC-GRIP Patent Ductus Clamps	531
DE BAKEY-REYNOLDS ATRAUMATIC-GRIP Anastomosis Clamps	542
DE BAKEY-RUMEL ATRAUMATIC-GRIP Dissecting and Ligature Forceps	186
DE BAKEY-SATINSKY ATRAUMATIC-GRIP Bulldog Clamps	525
DE BAKEY-SATINSKY ATRAUMATIC-GRIP Tangential Occlusion Clamps	541
DE BAKEY-WERTHEIM (ROGERS) Parametrium Forceps	197
DE BAKEY (GARRET) Vascular Dilators	510
DE BAKEY Arteriotomy Scissors	95
DE BAKEY ATRAUMATIC-GRIP Anastomosis Clamps	543
DE BAKEY ATRAUMATIC-GRIP Aorta-Aneurysma Clamps	545, 547
DE BAKEY ATRAUMATIC-GRIP Aortic Clamps	539
DE BAKEY ATRAUMATIC-GRIP Bulldog Clamps	526, 528
DE BAKEY ATRAUMATIC-GRIP Coarctation Clamps	532-533
DE BAKEY ATRAUMATIC-GRIP Dissecting and Ligature Forceps	551
DE BAKEY ATRAUMATIC-GRIP Multi-Purpose Clamps	530, 553
DE BAKEY ATRAUMATIC-GRIP Patent Ductus Clamps	531
DE BAKEY ATRAUMATIC-GRIP Peripheral Vascular Clamps	534-536
DE BAKEY ATRAUMATIC-GRIP Renal Artery Clamp	537
DE BAKEY ATRAUMATIC-GRIP Tangential Occlusion Clamps	541
DE BAKEY ATRAUMATIC-GRIP Vascular Clamps	529
DE BAKEY ATRAUMATIC-GRIP Vascular Forceps	135
DE BAKEY DURACUT Vascular Scissors	57
DE BAKEY Rib Spreaders	504-505
DE BAKEY Suction Tube	325
DE BAKEY TITE GRIP Needle Holders	343
DE BAKEY TITE GRIP Needlepulling Tissue Forceps	116
DE BAKEY Vascular Scissors	96
DE MARTEL-WOLFSON Clamp Closing Forceps	402
DE MARTEL-WOLFSON Clamp Holders	402
DE MARTEL-WOLFSON Colon-Anastomosis Clamps	402
DE MARTEL (BAILEY) Conductor for Wire Saws	687
DE VILBISS Cranial Rongeur	688
DE VILBISS Vaginal Specula	433
DEAN DURACUT Gum Scissors	55
DEAN Tonsil Scissors	103
DEAVER-FORD Retractors and Lung Spatulas	263
DEAVER Retractors and Lung Spatulas	264-265
DEAVER Surgical Scissors	71
Decapitating Hook	485
Decapitating Scissors	109
Decompression Hook	701
Deep Hand and Forearm Retractor	271
Delicate Dissecting Forceps	128-131
Delicate Dissecting Scissors	92-93
Delicate Haemostatic Forceps	164-172
Delicate Haemostatic Forceps, ATRAUMATIC-GRIP	165, 167
Delicate Haemostatic Forceps, TITAN LINE	164, 166, 168
Delicate Scissors, DURACUT	45
Delicate Surgical Scissors	68-70
Delicate Tissue Forceps	138-143
DEMEL Wire Guides	660
DENHARDT Mouth Gag	22
DENIS-BROWNE Abdominal Retractor	305
DENKER-UECKERMANN Cryothyrotomy Trocars	728
Deponettes	738
Depressors, Tongue	12
Depressors, Uterine	447
Depth Ruler for Laser Surgery	451
DERF Needle Holder	363
DERF TITE GRIP Needle Holder	342
DERJERINE Percussion Hammers	2
Dermal Punches	20
Dermatomes	41-42
DERRA-COOLEY ATRAUMATIC-GRIP Anastomosis Clamps	559
DERRA-DE BAKEY ATRAUMATIC-GRIP Anastomosis Clamps	542
DESCHAMPS Ligature Needles	374-376
DESJARDINS Gall Duct Probes	415
DESJARDINS Gall Stone Forceps	419
DESMARRES Vein Retractors	222
DEUCHER Abdominal Retractor	299
DEVIN ATRAUMATIC-GRIP Carotid Clamps	524
DIEFFENBACH Bulldog Clamps	163
DIETRICH-DE BAKEY ATRAUMATIC-GRIP Bulldog Clamps	526
DIETRICH-HEGEMANN DURACUT Vascular Scissors	56
DIETRICH-HEGEMANN Vascular Scissors	96
DIETRICH ATRAUMATIC-GRIP Aortic Clamps	539
DIETRICH Micro Bulldog Clamps	162
DIETRICH TITE GRIP Micro Needle Holders	339
DIETRICH Vascular Scissors	97
Dilating Bougies	424
Dilators and Intima Spatulas	512
Dilators, Aortic	511
Dilators, Common Bile Duct	416
Dilators, Trachea	728
Dilators, Uterine	443-445
Dilators, Vascular	510
DINGMANN Bone Holding Forceps	624
DINGMANN modif. Bone Holding Forceps	624
Directors	314
Directors, Enucleator	378
Dispensers, Brush	752
Dispensers, Wire Drills	656-657

Dissecting and Ligature Forceps	564
Dissecting and Ligature Forceps, ATRAUMATIC-GRIP	186, 551
Dissecting Forceps	132-134, 180-189
Dissecting Forceps, Delicate	128-131
Dissecting Forceps, TITE GRIP	113-115
Dissecting Scissors	81-91, 95, 98
Dissecting Scissors, Delicate	92-93
Dissecting Scissors, DURACUT	47-54
Dissecting Scissors, Micro	65, 67
Dissectors	574, 693-694, 696-697
Dissectors, Dura	699-700
DITTEL Catheter Guide	425
DIXON-LOVELACE Delicate Haemostatic Forceps	169
DIXON-OCHSNER (CRILE-RANKIN) Delicate Haemostatic Forceps	167
DIXON (PEAN) Haemostatic Forceps	174
DOCKHORN Retractors	245
Double Picks	212
DOUGLAS-BOZEMANN Uterine Dressing Forceps	208
DOUGLAS Antrum Trocar	320
DOUGLAS Cilia Forceps	152
DOYEN-BABY ATRAUMATIC-GRIP Intestinal Clamp Forceps	391
DOYEN-BABY Intestinal Clamp Forceps	391
DOYEN-STILLE Retractors	247
DOYEN Abdominal Retractors	248-249
DOYEN Abdominal Scissors	106
DOYEN ATRAUMATIC-GRIP Intestinal Clamp Forceps	392-393
DOYEN Director	314
DOYEN Intestinal Clamp Forceps	392-393
DOYEN Mallets	618
DOYEN Myoma Screws	458
DOYEN Polypus and Ovum Forceps	457
DOYEN Rib Raspatories	495
DOYEN Towel Clamps	200
DOYEN Vaginal Specula and Retractors	439
Dressing and Sponge Forceps	204-207
Dressing and Sponge Holding Forceps	209-210
Drill Guide Forceps	650
Drill Points for Cervical Traction Tongs	689
Drilling Chucks	653
Drills	652
Drills, Finger Nail	645
Drills, Hand	653
Drills, Hand Bone	651-653
Drills, Twist	652
Drills, Wire	655
Drums, Sterilizing	743
DUBOIS Decapitating (Embryotomy) Scissors	109
DUPLAY Uterine Tenaculum Forceps	453
Dura Dissectors	699-700
Dura Hooks	217-218
Dura Knives	37
Dura Protecting Forceps	650
Dura Retractors	212
Dura Scissors	100
Dura Separators	698
DURACUT Adnex Scissors	54
DURACUT Bandage Scissors	673
DURACUT Delicate Scissors	45
DURACUT Dissecting Scissors	47-54
DURACUT Episiotomy Scissors	60
DURACUT Gum Scissors	55
DURACUT Gynecological Scissors	60
DURACUT Iris Scissors	45
DURACUT Ligature Scissors	353
DURACUT Nasal Scissors	58
DURACUT Parametrium Scissors	60
DURACUT Perineum Scissors	60
DURACUT Plaster-of-Paris Shears	676
DURACUT Plastic Surgery Scissors	45
DURACUT Rectal Scissors	59
DURACUT Septum Scissors	59
DURACUT Surgical Scissors	46
DURACUT Uterine Scissors	60
DURACUT Vascular and Fistula Scissors	45
DURACUT Vascular Scissors	56-57
DURACUT Wire Cutters	667
DURACUT Wire Cutting Scissors	665
DURANTE Vascular and Tumor Forceps	149
DUVAL-COLLIN Intestinal and Tissue Grasping Forceps	386

DUVAL-COLLIN Intestinal Forceps	149
DUVAL Intestinal and Tissue Grasping Forceps	386-387
DUVAL Intestinal Forceps	149
DUVAL TITE GRIP Intestinal and Tissue Grasping Forceps	388
Dynamometers	6

E

Ear Dressing Forceps	136-137
Ear Hooklets	213
Ear Syringes	332
EASTMAN-RICHARDSON Retractors	250
EATON-BECKMANN Laminectomy Retractors	280
ECHLIN Bone Rongeurs	634
EDER Cotton Carrier	409
EICKEN-KILLIAN Antrum Wash Cannulae	322
EISELSBERG Ligature Scissors	352
Elevators	574-575
Embryotomy Scissors	109
EMMET Fistula Hook	221
EMMET Hook for Laser Surgery	449
EMMET Sponge and Dressing Forceps	207
Empyema Trocar	318
Enderectomy Set	515
Enderectomy Stripper	514-515
Endocervical Biopsy Curettes	459-460
Endometrial Biopsy Curette	459
Endometrial Suction Biopsy Curettes	459
Endospecula	443
Endospecula for Lasersurgery	448
ENGEL Plaster Saw	679
ENGL. MOD. Towel Clamps	200
Enterotomy Scissors	109
Enucleator Directors	378
Enucleators	693
Episiotomy Scissors	107
Episiotomy Scissors, DURACUT	60
ERRICO Burr	652
ESMARCH Cloth Scissors and Plaster-of-Paris Shears	675
ESMARCH Compression Bandage	570
ESMARCH Compression Tube	570
ESMARCH Plaster Knife	679
EUFRATE PASQUE TITE GRIP Needle Holders	344
Eustachian Catheters	322
EWALD Delicate Dissecting Forceps	129
EWALD Delicate Tissue Forceps	140
Examination & Measuring Instruments	6
Exploration and Coagulation Hooks	215
Extractors, Comedo	19
Eye Needles	354

F

FAHLBUSCH-HARDY Dissectors	693
FANSLER-IVES Anoscope	407
FARABEUF-ALEXANDER Rib Raspatories	497
FARABEUF-COLLIN Raspatories	588
FARABEUF-LAMBOTTE Bone Holding Forceps	626
FARABEUF Raspatories	588
FARABEUF Retractors	227
FARRELL (LATHBURY) Cotton Applicators	316
FAURE Peritoneum Forceps	193
FAVALORO Coronary Artery Scissors	95
FEHLAND ATRAUMATIC GRIP Sigmoid Anastomosis Forceps	400-401
FEILCHENFELD Splinter Forceps	150
FEIN Cotton Applicators	317
FERGUSON Operating Scissors	80
FERGUSON Surgical Suture Needles	356
FERGUSON (FRAZIER) Suction Cannulae	323
FERGUSON Bone Holding Forceps	624
FERRIS-SMITH-CUSHING Laminectomy Rongeurs	713
FERRIS-SMITH-KERRISON Laminectomy Punches	709-710, 712
FERRIS-SMITH Tissue Forceps	147
Files, Bone	592, 594-595
Finger Nail Drill	645
Finger Nail Instruments	645
Finger Retractors	271

- Finger Ring Saws 645
- FINOCHIETTO-BABY-HAIGHT** Rib Spreaders from ALUMINIUM 501
- FINOCHIETTO-BABY** Rib Spreaders 503
- FINOCHIETTO-BURFORD** Rib Spreaders 503
- FINOCHIETTO-BURFORD** Rib Spreaders from ALUMINIUM 502
- FINOCHIETTO-INFANT** Rib Spreaders from ALUMINIUM 501
- FINOCHIETTO-RIENHOFF** Rib Spreaders 506
- FINOCHIETTO modif.** Rid Spreaders from ALUMINIUM 500
- FINOCHIETTO** Needle Holders 369
- FINOCHIETTO** Rib Spreaders 503
- FINOCHIETTO** Rib Spreaders from ALUMINIUM 501
- FINOCHIETTO** Thoracic and Ligature Forceps 564
- FINOCHIETTO TITE GRIP** Needle Holders 346
- FINSEN** Self-Retaining Retractors 270
- FISCH** Dura Retractor 212
- FISCHER** Tendon Stripper 646
- Fistula Hooks 221
- Fistula Knife 37
- Fistula Probes 314, 409
- Fistula Scissors 80
- Fistula Scissors, DURACUT 45
- Fixation Clamp for the Spermatic Cord 425
- Fixation Device for Abdominal Retractors 309
- Flap Knife 39
- FLETCHER (JAVERTS)** Dressing and Sponge Holding Forceps 210
- FOERSTER-BALLENGER** Dressing and Sponge Holding Forceps 209
- FOERSTER (FORBES)** Dressing and Sponge Holding Forceps 210
- FOERSTER** Abdominal Retractors 308
- FOMON** Bone Files 595
- FOMON** DURACUT Nasal Scissors 58
- FOMON** Hooks for Posterior Nares 221
- FOMON** Lower Lateral Scissors 81
- FOMON** Nasal Scissors 102
- FOMON** Plastic Surgery Scissors 82
- FOMON** Rasps 595
- FOMON TITE GRIP** Rasps 597
- FORBES (FOERSTER)** Dressing and Sponge Holding Forceps 210
- Forceps 478-480
- Forceps, Anastomosis and Intestinal Clamp 402
- Forceps, Applying and Removing for Bulldog Clamps 160, 527
- Forceps, Applying and Removing for Scalp Hemostasis Clips 691
- Forceps, Applying for Approximators 158
- Forceps, Applying for Vessel Clips 154-156
- Forceps, Approximation 378
- Forceps, ATRAUMATIC-GRIP, Delicate Haemostatic 165, 167
- Forceps, ATRAUMATIC-GRIP, Dissecting and Ligature 186, 551
- Forceps, ATRAUMATIC-GRIP, Haemostatic 176
- Forceps, ATRAUMATIC-GRIP, Hysterectomy 197
- Forceps, ATRAUMATIC-GRIP, Intestinal and Tissue Grasping 389
- Forceps, ATRAUMATIC-GRIP, Intestinal Clamp 391-393, 395-396
- Forceps, ATRAUMATIC-GRIP, Ligature and Dissecting 186, 551
- Forceps, ATRAUMATIC-GRIP, Sigmoid Anastomosis 400-401
- Forceps, ATRAUMATIC-GRIP, Stomach Clamp 397
- Forceps, ATRAUMATIC-GRIP, Tissue and Intestinal Grasping 389
- Forceps, ATRAUMATIC-GRIP, Vascular 135
- Forceps, Bone and Rib Holding 493
- Forceps, Bone Cutting 494, 637-639
- Forceps, Bone Holding 624-629
- Forceps, Bronchus 566
- Forceps, Caesarean Section Haemostatic 481
- Forceps, Capsule 423
- Forceps, Cartilage Grasping and Meniscus 640
- Forceps, Catheter Introducing 32
- Forceps, Cervical Biopsy and Specimen 460-465
- Forceps, Cilia 152
- Forceps, Clamp Closing 402
- Forceps, Clip Applying 690
- Forceps, Clip Applying and Removing 379
- Forceps, Cover Glass 152
- Forceps, Cranial Rongeur 688
- Forceps, Dissecting 132-134, 180-189
- Forceps, Dissecting and Ligature 564
- Forceps, Dissecting, Delicate 128-131
- Forceps, Dressing and Sponge 204-207
- Forceps, Dressing and Sponge Holding 209-210
- Forceps, Drill Guide 650
- Forceps, Dura Protecting 650
- Forceps, Ear Dressing 136-137
- Forceps, Gall Stone 418-419
- Forceps, Grasping 149
- Forceps, Guide 473
- Forceps, Haemorrhoidal 410
- Forceps, Haemostatic 173-179
- Forceps, Haemostatic, Delicate 164-172
- Forceps, Hysterectomy 194-196
- Forceps, Intestinal 149
- Forceps, Intestinal and Anastomosis Clamp 402
- Forceps, Intestinal and Tissue Grasping 383-388
- Forceps, Intestinal Clamp 390-394, 396
- Forceps, Intra Uterine Device (IUP) 447
- Forceps, Kidney Elevating 421
- Forceps, Kidney Stone 420-421
- Forceps, Ligature 152, 180-189
- Forceps, Ligature and Dissecting 564
- Forceps, Ligature and Thoracic 564
- Forceps, Ligature Carrying 423
- Forceps, Lung Dissecting 149
- Forceps, Membrane Puncturing 477
- Forceps, Meniscus and Cartilage Grasping 640
- Forceps, Micro 120-125
- Forceps, Micro Grasping 124
- Forceps, Micro Suture Tying 121-123
- Forceps, Microscopic 121
- Forceps, Nail Extracting 645
- Forceps, Nail Splitter 17
- Forceps, Nail Splitting 645
- Forceps, Nasal Dressing 136-137
- Forceps, Ovum and Placenta 482-483
- Forceps, Ovum and Polypus 457
- Forceps, Parametrium 197
- Forceps, Patella 623
- Forceps, PERFECT GRIP, Micro Grasping 124
- Forceps, PERFECT GRIP, Micro Suture Tying 123
- Forceps, Peritoneum 192-193
- Forceps, Pick-Up 735
- Forceps, Placenta and Ovum 482-483
- Forceps, Polypus and Ovum 457
- Forceps, Prostatic Lobe Holding 423
- Forceps, Rectal Biopsy Specimen 412
- Forceps, Removing and Applying for Bulldog Clamps 160, 527
- Forceps, Removing and Applying for Scalp Hemostasis Clips 691
- Forceps, Reposition 622-623
- Forceps, Rib and Bone Holding 493
- Forceps, Scalp Flap 481
- Forceps, Sequestrum 623
- Forceps, Sigmoid Anastomosis 400
- Forceps, Sinus 204
- Forceps, Specimen and Cervical Biopsy 460-465
- Forceps, Splinter 150-151
- Forceps, Sponge and Dressing 204-207
- Forceps, Sponge Holding and Dressing 209-210
- Forceps, Sterilizing 734-735
- Forceps, Tendon Holding 648
- Forceps, Tendon Interlacing 649
- Forceps, Tendon Passing 649
- Forceps, Tendon Seizing 647
- Forceps, Thoracic and Ligature 564
- Forceps, Tissue 144-148
- Forceps, Tissue and Intestinal Grasping 383-388
- Forceps, Tissue Seizing 148
- Forceps, Tissue, Delicate 138-143
- Forceps, TITAN LINE Haemostatic, Delicate 164, 166, 168
- Forceps, TITE GRIP, Dissecting 113-115
- Forceps, TITE GRIP, Intestinal and Tissue Forceps 388
- Forceps, TITE GRIP, Micro 118
- Forceps, TITE GRIP, Needlepulling Tissue 116
- Forceps, TITE GRIP, Splinter 151
- Forceps, TITE GRIP, Suture Tying 113
- Forceps, TITE GRIP, Tissue 117
- Forceps, TITE GRIP, Tissue and Intestinal Forceps 388
- Forceps, TITE GRIP, Wire Holding 663
- Forceps, TITE GRIP, Wire Twisting 662
- Forceps, Tongue Holding 23
- Forceps, Tonsil 179
- Forceps, Tumor 148-149
- Forceps, Tumor and Tissue Grasping 126-127
- Forceps, Tunneling Tubes 517
- Forceps, Uterine Dressing 208

Forceps, Uterine Elevating	458
Forceps, Uterine Tenaculum	452-456
Forceps, Vascular	148-149
Forceps, Wire Holding	663-664
FORD-DEAVER Retractors and Lung Spatulas	263
Forearm and Deep Hand Retractor	271
Fork, Implant	693
FOSS Retractors and Lung Spatulas	263
FOX-GOLDMAN DURACUT Gum Scissors	55
FOX-GOLDMAN Gum Scissors	94
FOX Lupus Curettes	20
FRANZ Abdominal Retractor	304
FRAZIER (FERGUSSON) Suction Cannulae	323
FRAZIER Dura and Skin Retractor	216
FRAZIER Dura Separator	698
FRAZIER Suction Cannulae	323
FREER Chisels	607
FREER Raspatories	583
FREER Retractor	218
FRENCH EYE TITE GRIP Needle Holders	340
FRENZEL Tongue Depressor	12
FREY-SAUERBRUCH Rib Shears	493
FRIEDMAN-LUER Bone Rongeur	631
FRITSCH Retractors	250
FROHN Cotton Applicators	316
Front and Lateral Cutter	668
FRYKHOLM Bone Rongeurs	635
Funnels	751

G

Galea Hooks	691
Gall Bladder Scoop	417
Gall Bladder Trocars	318
Gall Duct Probes	415
Gall Stone Forceps	418-419
Gall Stone Probe	415
Gall Stone Scoops	417
GALLAHER Rasp	592
GANSKE-BIRCHER Meniscus and Cartilage Grasping Forceps	640
GARRET (DE BAKEY) Vascular Dilators	510
GAYLOR-THOMS Cervical Biopsy and Specimen Forceps	460
GEISSENDOERFER-OVERHOLT Dissecting and Ligature Forceps	184
GELPI-BABY Vaginal Retractor	281
GELPI-SELETZ Vaginal Retractors	281
GELPI Vaginal Retractors	281
GEMINI-MIXTER Dissecting and Ligature Forceps	181
GEMINI Dissecting and Ligature Forceps	181
Genito-Urinary Instruments	425-426
GERALD Delicate Dissecting Forceps	130
GERALD Delicate Tissue Forceps	142
GERALD TITE GRIP Dissecting Forceps	114
GERALD TITE GRIP Tissue Forceps	117
GERSTER Traction Bar for Bone Clamps	630
GERZOG Mallet	618
GIBBON-BAILEY Rib Contractor	508
GIERTZ-STILLE Rib Shears	492
GIGLI (OLIVECRONA) Wire Saws	687
GIGLI Hook Handles for Wire Saws	687
GIL-VERNET (MARBERGER) Vein and Hilar Retractors	223
GILLIES-BABY Needle Holders with Scissors	370
GILLIES-BABY TITE GRIP Needle Holder	348
GILLIES (CONVERSE) Dura and Skin Retractors	216
GILLIES Delicate Tissue Forceps	142
GILLIES Needle Holders with Scissors	370
GILLIES Skin Retractor	216
GILLIES TITE GRIP Needle Holders	348
GILLIES TITE GRIP Tissue Forceps	117
Glass Pipette for Micro-Bloodletting	473
GLASSMANN (KILNER) Surgical and Dissecting Scissors	83
GLOVER-DE BAKEY ATRAUMATIC-GRIP Bulldog Clamps	525
GLOVER ATRAUMATIC-GRIP Anastomosis Clamps	544
GLUCK Rib Shears	492
GOELET Retractor	229
Goitre Retractor	224
GOLDMAN-FOX DURACUT Gum Scissors	55
GOLDMAN-FOX Gum Scissors	94
Goniometer	7

GOOD Tonsil Scissors	103
GOODELL Uterine Dilator	443
GORNEY DURACUT Septum Scissors	59
GORNEY Plastic Surgery Scissors	82
GOSSET-BABY Abdominal Retractor	299
GOSSET Abdominal Retractors	299-300
Gouge Blades, Interchangeable	611
Gouges	607, 609-616
Gouges for Scoliosis Operations	614
Gouges, Spinal	616
Gouges, Spongiosa	615
GOURDET Uterine Scoops	466
GRAEFE (TYRELL) Skin Retractors	216
GRAEFE Delicate Dissecting Forceps	128
GRAEFE Delicate Tissue Forceps	139
GRAEFE Strabismus Hooks	213
GRAEFE Tissue Forceps	148
GRAHAM Dura Hook	217
GRAMCKO-BUCK Bone Lever	576
Grasping Forceps	149
GRAVE modif. Vaginal Specula	432
GRAVE Vaginal Specula	432-433
GREEN-ARMYTAGE Caesarean Section Haemostatic Forceps	481
GREEN-SENN Retractors	224
GREEN Thyroid Gland Retractor	243
GREEN Towel Clamps	200
GREGORY-SOFT ATRAUMATIC-GRIP Carotid Clamps	527
GREGORY ATRAUMATIC-GRIP Profunda Clamps	534
GRONINGEN Nerve and Vessel Hooks	215
GROSS Sponge and Dressing Forceps	204
GRUENWALD-LOVE Laminectomy Rongeurs	716
GRUENWALD (JANSEN) Ear and Nasal Dressing Forceps	136
GRUENWALD Ear and Nasal Dressing Forceps	136
Guide Forceps	473
Guide Needles	334
Guides, Catheter	425
Guides, Ligature	697
Guides, Wire	660-661
Gum Scissors	94
Gum Scissors, DURACUT	55
GUNNAR-HEY Tube Milking Roller	203
GUTHRIE Skin Retractors	218
GUYON-DE BAKEY ATRAUMATIC-GRIP Kidney Clamps	190
GUYON Catheter Guide	425
GUYON Catheter Introducing Instrument	425
GUYON Kidney Clamp	190
Gynecological Scissors, DURACUT	60

H

HABERER Abdominal and Intestinal Spatula	267
Haemorrhoidal Forceps	410
Haemorrhoidal Ligators	410
Haemorrhoidal Suction Ligators	411
Haemostatic Forceps	173-179
Haemostatic Forceps, ATRAUMATIC-GRIP	176
Haemostatic Forceps, Delicate	164-172
Haemostatic Forceps, TITAN LINE, Delicate	164, 166, 168
HAIGHT-FINOCHIETTO-BABY Rib Spreaders from ALUMINIUM	501
HAIGHT Rib Spreaders	506
HAJEK-KOFLER Laminectomy Punches	708
HAJEK Mallets	617
HALLE Bone Curettes	604
HALLE Dura Knife	37
HALLE Intima Spatulas	512
HALLE Raspatory	582
HALSEY Needle Holder	363
HALSEY TITE GRIP Needle Holder for Left-Hander	341
HALSEY TITE GRIP Needle Holders	342
HALSTED-MICRO Delicate Haemostatic Forceps	164
HALSTED-MOSQUITO-DE BAKEY ATRAUMATIC-GRIP Delicate Haemostatic Forceps	165
HALSTED-MOSQUITO (HEISS) Delicate Haemostatic Forceps	170
HALSTED-MOSQUITO Delicate Haemostatic Forceps	164-165
HALSTED-MOSQUITO TITAN LINE Delicate Haemostatic Forceps	164
HALSTED Delicate Haemostatic Forceps	169, 171
Hammers	2-3
Hand and Carpal Tunnel Retractor	271

- Hand Bone Drill 651-653
 Hand Drill 653
 Handles for Interchangeable Chisel Blades 611
 Handles for Interchangeable Gouge Blades 611
 Handles for Interchangeable Osteotome Blades 611
 Handles, Hook for Wire Saws 687
 Handles, Laryngeal Mirrors 13
 Handles, Scalpel 34-35
 Handles, Traction for Forceps 479
 Handrestrainer 644
 Hands, Lead 644
HARDY-FAHLBUSCH Dissectors 693
HARDY Curettes 692
HARDY Dissectors 693
HARDY Enucleators 693
HARDY Implant Fork 693
HARKEN-DE BAKEY ATRAUMATIC-GRIP Dissecting and
 Ligature Forceps 551
HARRINGTON-MAYO Dissecting Scissors 86
HARRINGTON Retractors and Lung Spatulas 262
HARTMANN-COLLIN Retractor 229
HARTMANN (BABY-MOSQUITO) Delicate Haemostatic Forceps 164
HARTMANN Cervical Biopsy and Specimen Forceps 462
HARTMANN Eustachian Catheters 322
HARTMANN Tuning Forks 4
HASSETLINE Umbilical Cord Clamps 486
HAVERFIELD-SCOVILLE Self-Retaining Retractors 286
HAYES ATRAUMATIC-GRIP Sigmoid Anastomosis Forceps 400
 Head Bands 10-11
 Head Extractor 481
 Head Lamps 11
 Head Light 11
 Head Mirrors 10
HEANEY-BALLENTINE Hysterectomy Forceps 196
HEANEY-DE BAKEY (ROGERS) Hysterectomy Forceps 197
HEANEY-REZEK Hysterectomy Forceps 196
HEANEY-SIMON Retractor for Deep Surgery 254
HEANEY Hysterectomy Forceps 196
HEANEY Needle Holders 369
HEANEY Tissue Forceps 147
HEANEY TITE GRIP Needle Holders 346
HEATH-RICHTER Clip Removing Forceps 379
HEATH Mallet 620
HEGAR-BAUMGARTNER TITE GRIP Needle Holder 342
HEGAR-CORWIN TITE GRIP Wire Twisting Forceps 662
HEGAR-MAYO Needle Holders 367
HEGAR-MAYO TITE GRIP Needle Holders 345
HEGAR-MAYO TITE GRIP Needle Holders for Left-Hander 341
HEGAR-OLSEN-BABY TITE GRIP Needle Holder 348
HEGAR-OLSEN Needle Holders with Scissors 370
HEGAR-OLSEN TITE GRIP Needle Holders 348
HEGAR Uterine Dilators 444-445
HEGEMANN-DIETRICH DURACUT Vascular Scissors 56
HEGEMANN-DIETRICH Vascular Scissors 96
HEGENBARTH Clip Applying Forceps 379
HEIFETZ Brain Spatulas 706
HEIFETZ Tumor and Tissue Grasping Forceps 127
HEISS (HALSTED-MOSQUITO) Delicate Haemostatic Forceps 170
HEISS (MIXTER-PAUL) Dissecting and Ligature Forceps 182
HEISTER Mouth Gag 22
 Hemi-Laminectomy Retractors 277
HEMINGWAY Bone Curettes 599
HENLEY Self-Retaining Retractors 282-283
HENNIG Plaster Spreader 682
HERRICK Kidney Pedicle Clamp 191
HEY-GUNNAR Tube Milking Roller 203
HEYMANN DURACUT Nasal Scissors 58
HEYMANN Nasal Scissors 101
HEYWOOD-SMITH Polypus and Ovum Forceps 457
HEYWOOD-SMITH Tongue Holding Forceps 23
 Hib Levers 580
HIBBS Retractors 231
HIBBS Spinal Retractors 231
 Hilar Retractors 223
HIRSCHMANN Anoscopes 407
HOEN Raspatories 586
HOGLUND-LOWMAN Bone Clamp 630
HOHMANN-ALDINGER Bone Lever 580
HOHMANN-LANGE Bone Lever 577
HOHMANN-LANGE modif. Bone Lever 577
HOHMANN-MINI Bone Levers 576
HOHMANN Bone Levers 578-580
HOKE Osteotomes 607
HOLSHER Nerve Root Retractor 701
HOLZBACH Hysterectomy Forceps 194
 Hook Handles for Wire Saws 687
 Hooklets, Ear 213
 Hooks 696
 Hooks, Bulbus 422
 Hooks, **CASPAR** Self-Retaining Retractors 289
 Hooks, Coagulation and Exploration 215
 Hooks, Crypt 409
 Hooks, Decapitating 485
 Hooks, Decompression 701
 Hooks, Dura 217-218
 Hooks, Exploration and Coagulation 215
 Hooks, Fistula 221
 Hooks, Galea 691
 Hooks, Laser Surgery 449
 Hooks, Nerve 213-215
 Hooks, Plastic Surgery 217-218, 226
 Hooks, Posterior Nares 221
 Hooks, **SCOVILLE** Self-Retaining Retractors 287
 Hooks, Spring for Galea Fixation 691
 Hooks, Strabismus 213
 Hooks, Suture 518
 Hooks, Vessel 213-215
HOPKINS-JOHNS Applying and Removing Forceps for Bulldog Clamps 527
HOPKINS-JOHNS Bulldog Clamps 163
HOPKINS Plaster Knives 679
HORGAN Central Valve for Abdominal Retractors 303
HORNE-JOBSON Cotton Applicators 317
HORSLEY-LISTON-KEY Bone Cutting Forceps 494
HORSLEY Dura Separator 698
HÖSEL Retractors 246
HOSPITAL-PROVIDENCE Delicate Haemostatic Forceps 168
HOUSE Bone Curettes 598
HOWARD Raspatory 583
HRYNTSCHAK-YOUNG Boomerang Needle Holder 372
HUDSON Hand Bone Drill 652
HULKA-KENWICK Uterine Tenaculum Forceps 453
HULKA Uterine Tenaculum Forceps 453
HUMBY Dermatome 42
HUNTER Splinter Forceps 150
HURD Ligature Needles 374
 Hysterectomy Forceps 194-196
 Hysterectomy Forceps ATRAUMATIC-GRIP 197
 Hystero-Salpingography Instrumentation 474
- I
- Identification Labels 743
 Iliac Clamps, ATRAUMATIC-GRIP 558
 Implant Fork 693
 Incision Scissors 80
INFANT-FINOCHIETTO Rib Spreaders from ALUMINIUM 501
INGE Lamina Spreaders 296
 Injection Needle 486
 Instrument Boxes 746
 Instrument Care Lubricant 733
 Instrument Storing Trays 748
 Insuline Syringes 330
 Interosseous Knife 39
 Intestinal and Anastomosis Clamp Forceps 402
 Intestinal and Stomach Clamps 403
 Intestinal and Stomach Suturing Apparatus 404
 Intestinal and Tissue Grasping Forceps 383-388
 Intestinal and Tissue Grasping Forceps, ATRAUMATIC-GRIP 389
 Intestinal and Tissue Grasping Forceps, TITE GRIP 388
 Intestinal Clamp Forceps 390-394, 396
 Intestinal Clamp Forceps, ATRAUMATIC GRIP 391-393, 395-396
 Intestinal Forceps 149
 Intestinal Needles 354
 Intestinal Spatulas 266-267
 Intima Knife 513
 Intima Spatulas 512-513
 Intima Spatulas and Dilators 512

Intra Uterine Device (IUP) Forceps	447
Intracardiac Suction Tube	327
IOWA Injection Needle	486
IOWA Membrane Puncturing Forceps	477
IOWA Trumpet Needle Guide	486
Iris Scissors, DURACUT	45
Irrigators	751
ISRAEL Retractors	237
IUD (Intra Uterine Device) Forceps	447
IVES-FANSLER Anoscope	407

J

JACKSON-CHEVALIER Trachea Tubes	726
JACKSON Tendon Seizing Forceps	647
JACKSON Trachea Retractor	217, 226
JACKSON Vaginal Specula	438
JACOBS Uterine Tenaculum Forceps	456
JACOBSON Buttoned Probe	694
JACOBSON Micro Scissors	64
JACOBSON PERFECT GRIP Micro Needle Holders	359
JACOBSON Suture Pusher	694
JACOBSON TITE GRIP Micro Needle Holders	338
JACOBSON Twin Probe	694
JACOBSON Vessel Knife	694
JAMESON Delicate Dissecting Scissors	93
JAMESON Needle Holders	368
JANET Barrels	331
JANET Wound and Bladder Syringes	331
JANSEN-ZAUFAL Bone Rongeur	633
JANSEN (GRUENWALD) Ear and Nasal Dressing Forceps	136
JANSEN Bone Curettes	599
JANSEN Bone Rongeurs	632
JANSEN Ear and Nasal Dressing Forceps	136
JANSEN Head Lamp	11
JANSEN Raspatory	587
JANSEN Self-Retaining Retractors	272
Jars	747
JAVERTS (FLECHTER) Dressing and Sponge Holding Forceps	210
JAVID ATRAUMATIC-GRIP Carotid Clamps	537
JOHNSON-HORNE Cotton Applicators	317
JOHNS-HOPKINS Applying and Removing Forceps for Bulldog Clamps	527
JOHNS-HOPKINS Bulldog Clamps	163
JONES-LELAND ATRAUMATIC-GRIP Peripheral Vascular Clamps	534
JONES Towel Clamps	200
JORGENSON Dissecting Scissors	98
JOSEPH Bone File	592
JOSEPH DURACUT Plastic Surgery Scissors	45
JOSEPH Hooks for Plastic Surgery	217, 219
JOSEPH Plastic Surgery Scissors	70
JOSEPH Raspatory	582
JOSEPH Rhinoplastic Knife	37
JUDD-ALLIS Intestinal and Tissue Grasping Forceps	384
JUDD-MASSON Bladder Retractor	310

K

KADER Abdominal and Intestinal Spatulas	267
KALLMORGEN Vaginal Specula and Retractors	434
KALT Needle Holder	363
KALT Vascular Suture Needles	354
KATSCH Comedo Extractor	19
KAY-LAMBERT ATRAUMATIC-GRIP Aorta-Anastomosis Clamps	549
KAZANJIAN Bone Cutting Forceps	637
KELLY-BABY Delicate Haemostatic Forceps	168
KELLY-RANKIN Delicate Haemostatic Forceps	169
KELLY Delicate Haemostatic Forceps	168
KELLY DURACUT Vascular and Fistula Scissors	45
KELLY Polypus and Ovum Forceps	457
KELLY Retractors	251, 255
KELLY Retractors for Deep Surgery	255
KELLY Sphincteroscopes	407
KELLY TITAN LINE Delicate Haemostatic Forceps	168
KELLY Vascular and Fistula Scissors	80
KENWICK-HULKA Uterine Tenaculum Forceps	453
KERN-LANE Bone Holding Forceps	625
KERN-MINI Bone Holding Forceps	625

KERRISON-LOVE (COLCLOUGH) Laminectomy Punches	710-711
KERRISON-SMITH-FERRIS Laminectomy Punches	709-710, 712
KERRISON Laminectomy Punches	707
KEVOURKIAN-PACIFIC Cervical Biopsy and Specimen Forceps	464
KEVOURKIAN-YOUNGE Cervical Biopsy and Specimen Forceps	463, 465
KEVOURKIAN-YOUNGE Endocervical Biopsy Curettes	459
KEY-LISTON-HORSLEY Bone Cutting Forceps	494
KEY Raspatories	589
KEYES Dermal Punch Set	20
KEYES Dermal Punches	20
Kidney Bowls	750
Kidney Clamps	190
Kidney Clamps, ATRAUMATIC-GRIP	190
Kidney Elevating Forceps	421
Kidney Pedicle Clamps	191
Kidney Stone Forceps	420-421
KIELAND-LUIKART Forceps	479
KIELAND Forceps	479
KILLIAN-EICKEN Antrum Wash Cannulae	322
KILLIAN (MÜHLING) Septum Scissors	102
KILLIAN Raspatories	583
KILNER (GLASSMANN) Surgical and Dissecting Scissors	83
KILNER Delicate Dissecting Scissors	93
KILNER Skin Retractors	216
KILNER TITE GRIP Needle Holder	342
KIRK Mallet	618
KIRKLIN Vein Retractors	223
KIRSCHNER-BALFOUR Valve for Abdominal Retractors	307
KIRSCHNER Abdominal Retractors	306
KIRSCHNER Ligature Conductor	377
KIRSCHNER Valves for Abdominal Retractors	307
KIRSCHNER Wire Drills	655
KIRSCHNER Wire Traction Bows	658-659
KLAPP Tendon Sheath Retractor	225
KLEINERT-KUTZ Tendon Passing Forceps	649
KLEINSCHMIDT Spur Crusher and Appendectomy Clamp	403
KLIMA-ROSEGGER Sternum Puncture Needles	329, 518
KLINGENBERGH-LOTH Dissecting Scissors	98
KNAPP Delicate Surgical Scissors	68
KNAPP Retractors	218
KNIGHT DURACUT Nasal Scissors	58
KNIGHT Nasal Scissors	101
Knives, Amputation	38-39
Knives, Autopsy	40
Knives, Brain	40
Knives, Dura	37
Knives, Fistula	37
Knives, Flap	39
Knives, Interosseous	39
Knives, Intima	513
Knives, Meniscus	642-643
Knives, Periosteum	39
Knives, Phalangeal	39
Knives, Plaster	679
Knives, Post Mortem	40
Knives, Resection	38-39
Knives, Rhinoplastic	37
Knives, Vessel	694-695
Knot Tier and Ligature Adjuster	378
KNOWLES Bandage Scissors	673
KNUTSON Urethrography Instrument	426
KOCHER-BABY ATRAUMATIC-GRIP Intestinal Clamp Forceps	391
KOCHER-BABY Intestinal Clamp Forceps	391
KOCHER-LANGENBECK Retractors	240
KOCHER-OCHSNER Haemostatic Forceps	177
KOCHER ATRAUMATIC-GRIP Intestinal Clamps	395
KOCHER Bladder Spatula	268
KOCHER Director Eucleator	378
KOCHER Haemostatic Forceps	176
KOCHER Intestinal Clamp Forceps	392-394
KOCHER Retractors	235, 242, 244
KOCHER Retractors and Bone Retractors	232
KOENIG Ligature Conductors	377
KOERTE-LUER Gall Stone Scoops	417
KOERTE Retractors	236
KOFLER-HAJEK Laminectomy Punches	708
KOGAN Endospecula	443
KOGAN Endospecula for Laser Surgery	448
KOGLER-CRAIG Vertebral Biopsy Instruments	720-721

KÖLN MOD. Scalp Hemostasis Clips	691
KÖNIG-ROSER Mouth Gag	22
KÖNIG Raspatory	582
KONRICH Sterilizing Drums	743
KOOS Vessel Knives	695
KRAUS Vessel Knife	695
KRAUSE Antrum Trocar	319
KRAYENBÜHL Nerve and Vessel Hooks	215
KRISTELLER Vaginal Specula and Retractors	434-437
KROENLEIN Haemostatic Forceps	173
KRONECKER Ligature Needles	374
KÜHNE Cover Glass Forceps	152
KUTZ-KLEINERT Tendon Passing Forceps	649

L

LA GRANGE Gum Scissors	94
Labels, Identification	743
Lable Rack	743
LABORDE Trachea Dilator	728
Lachrymal Probes	312
LAHEY-SWEET Dissecting and Ligature Forceps	189
LAHEY Dissecting and Ligature Forceps	189
LAHEY Goitre Retractor	224
LAHEY Retractors	219
LAHEY Uterine Tenaculum Forceps	454
LAMBERT-KAY ATRAUMATIC-GRIP Aorta-Anastomosis Clamps	549
LAMBERT-LOWMAN Bone Clamp	630
LAMBOTTE-FARABEUF Bone Holding Forcpes	626
LAMBOTTE-MINI Osteotomes	608
LAMBOTTE Bone Holding Forcpes	626-627
LAMBOTTE Osteotomes	608
LAMBOTTE Rib Raspatories	497
Lamina Spreaders	296
Laminectomy Punches	707-712
Laminectomy Retractors	276, 279-280, 284, 286
Laminectomy Rongeurs	713-719
LANDAU-COLLIN Vaginal Specula	431
LANDAU Vaginal Specula	440
LANDOLT-CUSHING Specula for Trans-Sphenoidal Hypophysectomy	692
LANDOLT Raspatory	585
LANE-KERN Bone Holding Forcpes	625
LANE-MURPHY Luxation Lever	581
LANE Bone Holding Forcpes	625
LANE Towel Clamps	201
LANGE-HOHMANN Bone Lever	577
LANGE-HOHMANN modif. Bone Lever	577
LANGE Bandage Scissors	672
LANGENBECK-KOCHER Retractors	240
LANGENBECK-MINI Retractors	224
LANGENBECK-PARKER (US-ARMY) Retractors	231
LANGENBECK-RYDER TITE GRIP Needle Holders	350
LANGENBECK Amputation and Resection Saw	572
LANGENBECK Bone Holding Forcpes	624
LANGENBECK Elevators	575
LANGENBECK Flap Knife	39
LANGENBECK Raspatories	587
LANGENBECK Resection Knives	38
LANGENBECK Retractors	238-239
LANGENBECK TITE GRIP Needle Holders	350
Laryngeal Mirrors	13-14
Laryngoscopes	24-31
Laser Surgery Instruments	448-451
Lateral and Front Cutter	668
Lateral Speculum for Lasersurgery	448
Lateral Valves for SCOVILLE Self-Retaining Retractors	287
Lateral Valves for TAYLOR Self-Retaining Retractors	287
LATHBURY (FARRELL) Cotton Applicators	316
LAWRENCE Dissecting and Ligature Forceps	187
LAWTON-MATHIEU TITE GRIP Needle Holder	349
LAWTON TITE GRIP Needle Holder	349
LAZAR Micro Suture Tying Forceps	121
Lead Hands	644
LEBSCHKE Sternum Chisel	492
LEES ATRAUMATIC-GRIP Bronchus Clamps	552
Left-Hander Needle Holders, TITE GRIP	341
Left Ventricular Sump Suction Tube	327
LEGUEU Bladder Spatula	268
LEKSELL-STILLE Bone Rongeurs	635
LELAND-JONES ATRAUMATIC-GRIP Peripheral Vascular Clamps	534
LEMMON Intima Spatulas	512
LEMPERT Bone Curettes	604
LEMPERT Bone Rongeurs	631-632
LEMPERT Raspatories	584
Lenses, Accessory	9
LERICHE Delicate Haemostatic Forceps	165
Levers, Bone	576-581
Levers, Hib	580
Levers, Luxation	581
Levers, Obstetric	481
LEWIN Reposition Forceps	622
LEWIS Rasps	592
LEXER-BABY Dissecting Scissors	87
LEXER-MAYO Dissecting Scissors	87
LEXER-MAYO DURACUT Dissecting Scissors	48
LEXER-MINI Osteotomes	612
LEXER Dissecting Scissors	87
LEXER DURACUT Dissecting Scissors	49
LEXER Gouges	613
LEXER Osteotomes	612-613
LEXER Spongiosa Gouges	615
LEYLA Self-Retaining Brain Retractors	702-705
LICHTENBERG TITE GRIP Needle Holder	349
LICHTWITZ Antrum Trocar Needles	319
LICHTWITZ Antrum Trocars	320
LICHTWITZ V. EICKEN Antrum Trocar Needles	319
Ligators, Haemorrhoidal	410
Ligature Adjuster and Knot Tier	378
Ligature and Dissecting Forceps	564
Ligature and Dissecting Forceps, ATRAUMATIC-GRIP	186, 551
Ligature and Thoracic Forceps	564
Ligature Carrying Forceps	423
Ligature Conductors	377-378
Ligature Forceps	152, 180-189
Ligature Guides	697
Ligature Needles	374-376
Ligature Rubber Rings	410
Ligature Scissors	352
Ligature Scissors, DURACUT	353
LINDORF TITE GRIP Wire Twisting Forceps	662
Liquid Concentrate for Surgical Instrument Care	733
LISTER Bandage and Cloth Scissors	674
LISTER Bandage Scissors	673
LISTER DURACUT Bandage Scissors	673
LISTER modif. Bandage Scissors	673
LISTER Sinus Forceps	204
LISTON-KEY-HORSLEY Bone Cutting Forceps	494
LISTON-LITTAUER Bone Cutting Forceps	637
LISTON-RUSKIN Bone Cutting Forceps	638
LISTON-WALTON (BÖHLER) Bone Cutting Forceps	638
LISTON Amputation Knives	38
LISTON Bone Cutting Forceps	637, 639
LITTAUER-LISTON Bone Cutting Forceps	637
LITTAUER Cilia Forceps	152
LITTAUER Ligature Scissors	352
LITTLER Dissecting Scissors	81
Liver Blind Puncture Needles	329
Liver Puncture Controlled Needles	329
Liver Retractors	255
Lobectomy Scissors	99
LOCKHART-MUMMERY Fistula Probe	314
LOCKLIN DURACUT Gum Scissors	55
LOCKLIN Gum Scissors	94
LOCKWOOD Intestinal and Tissue Grasping Forceps	386
LONG Hysterectomy Forceps	194
LORNA Towel Clamps	202
LOTH-KLINGENBERGH Dissecting Scissors	98
LOTH-SCHOEMAKER Ligature Scissors	352
LOUTE Wire Tightener	660
LOVE-GRUENWALD Laminectomy Rongeurs	716
LOVE-KERRISON (COLCLOUGH) Laminectomy Punches	710-711
LOVE Nerve Root Retractors	701
LOVELACE-DIXON Delicate Haemostatic Forceps	169
LOVELACE Intestinal and Tissue Grasping Forceps	387
LOWER Dissecting and Ligature Forceps	189
Lower Lateral Scissors	81
Lower Occlusive Clamps, ATRAUMATIC-GRIP	399

LOWMAN-HOGLUND Bone Clamp 630
LOWMAN Bone Clamps 630
LOWMANN-LAMBERT Bone Clamp 630
LUCAE Ear and Nasal Dressing Forceps 136
LUCAE Ear Hooklets 213
LUCAE Mallet 617
LUCAE Tuning Fork 4
LUCAS Bone Curettes 599
LUER-FRIEDMAN Bone Rongeur 631
LUER-KOERTE Gall Stone Scoops 417
LUER-STILLE Bone Rongeurs 634, 636
LUER Bone Rongeurs 631-632
LUER Retractor 227
LUER Trachea Tubes 725
LUIKART-KIELAND Forceps 479
Lumbar Puncture Needles 328
Lumbar Vertebral Column, Retractors 294
Lumbar Vertebral Operations, Specula 295
Lung Dissecting Forceps 149
Lung Retractors 260
Lung Spatulas 260-265
Lupus Curettes 20
Lupus Scraper 19
Luxation Lever 581

M

MAGILL Catheter Introducing Forceps 32
Magnifying Glass 9
MAIER-SIMS Sponge and Dressing Forceps 205
MAIER Sponge and Dressing Forceps 205
Mallets 617-621
MALTZ Rasp 593
MALTZ TITE GRIP Rasps 596
MARBACH Perineum (Episiotomy) Scissors 107
MARBERGER (GIL-VERNET) Vein and Hilar Retractors 223
Marking and Writing Pencils and Marking Apparatus 757
MARKS ST. Pelvis Retractors 258
MARKWALDER Rib Rongeur 494
MARQUARDT Bone Rongeur 634
MARTIN Meniscus and Cartilage Grasping Forceps 640
MARTIN Pelvimeter 477
MARTIN Retractor for Deep Surgery 254
MARTIN ST. Delicate Tissue Forceps 139
MARTINI Bone Curettes 598
MASSON-JUDD Bladder Retractor 310
MASSON Needle Holders 368
MASSON TITE GRIP Needle Holder 347
MASTIN Muscular Clamp 728
MATHIEU-LAWTON TITE GRIP Needle Holder 349
MATHIEU Needle Holders 371
MATHIEU Rectal Speculum 405
MATHIEU Retractors 226, 231
MATHIEU TITE GRIP Needle Holders 349
MATHIEU Vaginal Specula and Retractors 439
MATSON Rib Raspatories 497
MATZENAUER Vaginal Specula 440
MAUNDER Oral Screw 22
MAYFIELD Bone Rongeur 633
MAYO-ADAMS Appendectomy Retractors 284
MAYO-BLAKE Gall Stone Forceps 418
MAYO-HARRINGTON Dissecting Scissors 86
MAYO-HEGAR Needle Holders 367
MAYO-HEGAR TITE GRIP Needle Holders 345
MAYO-HEGAR TITE GRIP Needle Holders for Left-Hander 341
MAYO-LEXER Dissecting Scissors 87
MAYO-LEXER DURACUT Dissecting Scissors 48
MAYO-NOBLE Dissecting Scissors 86
MAYO-ROBSON ATRAUMATIC-GRIP Intestinal Clamp Forceps 396
MAYO-ROBSON Intestinal Clamp Forceps 396
MAYO-STILLE Dissecting Scissors 85
MAYO-STILLE DURACUT Dissecting Scissors 48
MAYO Abdominal Retractor 249
MAYO Dissecting Scissors 84
MAYO DURACUT Dissecting Scissors 47
MAYO Gall Stone Scoop 417
MAYO Safety Pins 736
MAYO Tongue Depressor 12

MAYO Vascular and Tumor Forceps 149
MC DONALD Dissector 574
MC GIVNEY Haemorrhoidal Forceps 410
MC INDOE Bone Cutting Forceps 638
MC INDOE Cartilage Scissors 82
MC INDOE Delicate Dissecting Forceps 130
MC INDOE TITE GRIP Dissecting Forceps 113
MC INTOSH Laryngoscopes 24-27
MC KENTY Raspatory 582
MC KENZIE Burr 652
MC KENZIE Clip Applying Forceps 690
MC KENZIE Silver Brain Clips 690
MC KENZIE Silver Clip Carrier 690
MC KENZIE Silver Wire 690
MC PHERSON Micro Suture Tying Forceps 122
MEAD Bone Rongeurs 631
MEAD Mallet 618
Measuring & Examination Instruments 6
Measuring Instruments 7
Measuring Instruments for Laser Surgery 448
Measuring Jugs 751
Measuring Probe for Laser Surgery 450
Meatotome 426
Medicine Cup 751
Medicine Spoon 751
MEEKER-BABY Dissecting and Ligature Forceps 180
MEEKER Dissecting and Ligature Forceps 187
Membrane Puncturing Forceps 477
MENGHINI Liver Blind Puncture Needles 329
MENGHINI Needles for Controlled Liver Puncture 329
Meniscus and Cartilage Grasping Forceps 640
Meniscus Knives 642-643
MERCEDES Thoracic Retractor 507
Metal Catheters 424
Metal Handles for Laryngeal Mirrors 13
METZENBAUM-BABY Dissecting Scissors 89
METZENBAUM-NELSON Dissecting Scissors 91
METZENBAUM-NELSON DURACUT Dissecting Scissors 53
METZENBAUM-THOREK DURACUT Adnex Scissors 54
METZENBAUM Dissecting Scissors 88-90
METZENBAUM DURACUT Dissecting Scissors 49-52, 54
MEYERDING Laminectomy Retractors 284
MEYERDING Retractors 225
MICHEL Clip Applying and Removing Forceps 379
MICHEL Clip Applying Forceps 379
MICHEL Rhinoscopic Mirrors 14
MICHEL Suture Clips 379
MICRO-ADSON Delicate Dissecting Forceps 129
MICRO-ADSON Delicate Tissue Forceps 140-141
MICRO-ADSON TITE GRIP Tissue Forceps 117
MICRO-CASTROVIEJO Micro Needle Holders 358
MICRO-CRILE Delicate Haemostatic Forceps 166
MICRO-HALSTED Delicate Haemostatic Forceps 164
Micro Blades for Bloodletting 473
Micro Bloodletting and Amnioscopy Instruments 472-473
Micro Bulldog Clamps 162
Micro Dissecting Scissors 65, 67
Micro Forceps 120-125
Micro Forceps (Jeweler Patterns) 120
Micro Forceps, TITE GRIP 118
Micro Grasping Forceps 124
Micro Grasping Forceps, PERFECT GRIP 124
Micro Instruments 694-697
Micro Needle Holders 358-362
Micro Needle Holders, PERFECT GRIP 359, 361-362
Micro Needle Holders, TITE GRIP 338-339
Micro Scissors 62-67
Micro Suction Tubes 321
Micro Suture Tying Forceps 121-123
Micro Suture Tying Forceps, PERFECT GRIP 123
Microscopic Forceps 121
MIDDELDORF Retractors 243
MIKULICZ-BABY Peritoneum Forceps 192
MIKULICZ Liver Retractors 255
MIKULICZ Peritoneum Forceps 192-193
MIKULICZ Retractors for Deep Surgery 255
MILAN Endocervical Biopsy Curettes 460
MILLER-SENN Retractors 226
MILLER Laryngoscopes 28-31

- MILLER** Rasps 592
MILLER TITE GRIP Rasps 596
MILLES Micro Scissors 64
MILLIGAN Dura Separator 698
MILLIN-YOUNG Boomerang Needle Holder 372
MILLIN Bladder Neck Spreader 423
MILLIN Bladder Retractors 310
MILLIN Capsule Forceps 423
MILLIN Ligature Carrying Forceps 423
MILLIN Prostatic Lobe Holding Forceps 423
MINI-HOHMANN Bone Levers 576
MINI-KERN Bone Holding Forceps 625
MINI-LAMBOTTE Osteotomes 608
MINI-LANGENBECK Retractors 224
MINI-LEXER Osteotomes 612
MINI-STILLE Plaster-of-Paris Shears 677
Mini-Transformer 11
MINI-YASARGIL Applying Forceps for Vessel Clips 154
MINI-YASARGIL Vessel Clips 154
MIOTTI-OVERHOLT Dissecting and Ligature Forceps 185
Mirrors 11, 13-14
Mirrors, Head 10
Mirrors, Laryngeal 13-14
Mirrors, Rhinoscopic 14
MIXTER-BABY Dissecting and Ligature Forceps 180
MIXTER-GEMINI Dissecting and Ligature Forceps 181
MIXTER-O'SHAUGNESSY Dissecting and Ligature Forceps 182
MIXTER-OVERHOLT Dissecting and Ligature Forceps 183
MIXTER-PAUL (HEISS) Dissecting and Ligature Forceps 182
MIXTER Dissecting and Ligature Forceps 182, 188-189
MIXTER Gall Stone Forceps 419
MIXTER Surgical Scissors 79
MOBERG Retractors 224
MOD. BONN Delicate Tissue Forceps 138
MOD. ENGL. Towel Clamps 200
MOD. KÖLN Scalp Hemostasis Clips 691
MOD. MÜNCHEN Endometrial Biopsy Curette 459
MOD. SWITZERLAND Micro Forceps (Jeweler Patterns) 120
MOD. TÜBINGEN VANNAS Micro Scissors 62
MOD. USA Bone Curettes 601
MOD. USA Dissecting Forceps 133
MOD. USA Plaster Spreader 682
MOD. USA Tissue Forceps 145
MOD. USA Umbilical Cord Scissors 108
MOD. WIENER Suture Catcher 378
MODELL CANAD. Meniscus Knives 643
MODELL RUSS. Vascular and Tumor Forceps 149
MOGEN Circumcision Clamp 426
MOLDESTAD Vein Retractor 217
MÖLTGEN Goniometer 7
MOORE-STAUDE Uterine Tenaculum Forceps 452
MOORE Gall Bladder Scoop 417
MORGAN-TISCHLER Cervical Biopsy and Specimen Forceps 464
MORRIS-DE BAKEY ATRAUMATIC-GRIP Aortic Clamps 540
MORSE Sternotomy Spreaders 499
MOSQUITO-BABY (HARTMANN) Delicate Haemostatic Forceps 164
MOSQUITO-HALSTED-DE BAKEY ATRAUMATIC-GRIP Delicate Haemostatic Forceps 165
MOSQUITO-HALSTED (HEISS) Delicate Haemostatic Forceps 170
MOSQUITO-HALSTED Delicate Haemostatic Forceps 164-165
MOSQUITO-HALSTED TITAN LINE Delicate Haemostatic Forceps 164
MOTT-PARKER Retractors 228
Mounting Frame for Abdominal Retractors 309
Mouth Gags 22
MOYNIHAN Gall Stone Probe 415
MOYNIHAN Haemostatic Forceps 178
MÜHLING (KILLIAN) Septum Scissors 102
MÜHLING Raspatories 584
MÜLLER-BIEMER Approximators 157
MÜLLER-VERBRUGGE Bone Levers 579
MÜLLER Approximators 158
Multi Purpose Clamps, ATRAUMATIC-GRIP 520-523, 530, 553-554, 556, 562
MUMMERY-LOCKHART Fistula Probe 314
MÜNCHEN MOD. Endometrial Biopsy Curette 459
MURLESS Head Extractor 481
MURPHY-LANE Luxation Lever 581
MURPHY Head Band 10
MURRAY-CRILE Needle Holders 366
Muscular Clamp 728
MUSEUX Uterine Tenaculum Forceps 456
MYERS Vein Strippers 315
Myoma Screws 458
Myrtle Leaf Probes 313
- ## N
- NABATOFF** Vein Strippers 315
NAEGELE Forceps 478
NAGEL Micro Scissors 67
Nail Extracting Forceps 645
Nail Files 18
Nail Nippers 17
Nail Scissors 16
Nail Splitter Forceps 17
Nail Splitting Forceps 645
Nail Splitting Scissors 81
Nailbrush 752
Nasal Dressing Forceps 136-137
Nasal Scissors 101-102
Nasal Scissors, DURACUT 58
Nasal Suction Tubes 324
Needle Guide, Trumpet 486
Needle Holders 363-371
Needle Holders with Scissors 370
Needle Holders, Boomerang 372
Needle Holders, Micro 358-362
Needle Holders, PERFECT GRIP 364
Needle Holders, PERFECT GRIP, Micro 359, 361-362
Needle Holders, PERFECT GRIP, TITAN LINE 365
Needle Holders, TITAN LINE, PERFECT GRIP 365
Needle Holders, TITE GRIP 340-350
Needle Holders, TITE GRIP, for Left-Hander 341
Needle Holders, TITE GRIP, Micro 338-339
Needle Sterilizing Boxes 357
Needlepulling Tissue Forceps, TITE GRIP 116
Needles, Antrum Trocar 319
Needles, Biopsy 329, 518
Needles, Controlled Liver Puncture 329
Needles, Eye 354
Needles, Guide 334
Needles, Injection 486
Needles, Intestinal 354
Needles, Ligature 374-376
Needles, Liver Blind Puncture 329
Needles, Lumbar Puncture 328
Needles, Pleura Puncture 329, 518
Needles, Pneumoperitoneum 329
Needles, REVERDIN 373
Needles, Septum 328
Needles, Special 328
Needles, Sternum Puncture 329, 518
Needles, Surgical, Suture 354-356
Needles, Suture Sterilizing Rack 736
Needles, Tonsil 328
Needles, Vascular Suture 354
NEFF Meniscus Knives 642
NEGUS Haemostatic and Tonsil Forceps 179
NEIVERT-COTTLE Hook for Posterior Nares 221
NEIVERT Needle Holder 363
NEIVERT TITE GRIP Needle Holder 342
NELATON Director 314
NELSON-METZENBAUM Dissecting Scissors 91
NELSON-METZENBAUM DURACUT Dissecting Scissors 53
NELSON Tissue Forceps 148
NELSON Trocars 318
Nerve Dissecting Scissors 93
Nerve Hooks 213-215
Nerve Root Retractors 701
Neurosurgical Scissors 100
NEW ORLEANS Needle Holders 367
NEW ORLEANS TITE GRIP Needle Holder 344
NEWS Trachea Retractor 217
NOBLE-MAYO Dissecting Scissors 86
NORTHBENT (SPENCER) Ligature Scissors 352
NOTO Polypus and Ovum Forceps 457
NOTT Vaginal Specula 433

NOVAK Endometrical Suction Biopsy Curette 459
Nurses, Set for 18
Nursing Articles 751

O

O'BRIEN Ligature Scissors 352
Obstetric Instruments 481, 486
Obstetric Lever 481
Obturator 721
OBWEGESER Soft Tissue Retractors 241
OBWEGESER TITE GRIP Suture Tying Forceps 113
OCHSNER-ALLIS Intestinal and Tissue Grasping Forceps 383
OCHSNER-DIXON (CRILE-RANKIN) Delicate Haemostatic Forceps 167
OCHSNER-KOCHER Haemostatic Forceps 177
OCHSNER-ROCHESTER Haemostatic Forceps 178
OCHSNER ATRAUMATIC-GRIP Aortic Clamps 539
OCHSNER Gall Bladder Trocars 318
OCHSNER Gall Duct Probe 415
OCHSNER Ligature Forceps 152
O'CONNOR-O'SULLIVAN Abdominal Retractor 304
O'CONNOR Skin Retractor 217
OEHLER TITE GRIP Tissue Forceps 118
OLDBERG Pituitary Rongeur 719
OLIVECRONA-TOENNIS (SCOVILLE) Clip Applying Forceps 690
OLIVECRONA (GIGLI) Wire Saws 687
OLIVECRONA Brain Spatulas 706
OLIVECRONA Dura Dissectors 700
OLIVECRONA Trigeminal Scissors 100
OLLIER Retractor 236
OLSEN-HEGAR-BABY TITE GRIP Needle Holder 348
OLSEN-HEGAR Needle Holders with Scissors 370
OLSEN-HEGAR TITE GRIP Needle Holders 348
OMBREDANNE Mallet 621
Operating Scissors 80
Oral Screw 22
Oscillating Plaster Saw 680-681
O'SHAUGNESSY-MIXTER Dissecting and Ligature Forceps 182
Osteotome Blades, Interchangeable 611
Osteotomes 607-613
O'SULLIVAN-O'CONNOR Abdominal Retractor 304
OVERHOLT-BABY Dissecting and Ligature Forceps 183
OVERHOLT-GEISSENDOERFER Dissecting and Ligature Forceps 184
OVERHOLT-MIOTTI Dissecting and Ligature Forceps 185
OVERHOLT-MIXTER Dissecting and Ligature Forceps 183
OVERHOLT Dissecting and Ligature Forceps 183, 185
Ovum and Placenta Curettes 484
Ovum and Placenta Forceps 482-483
Ovum and Placenta Scoops 484
Ovum and Polypus Forceps 457

P

PACIFIC-KEVOURKIAN Cervical Biopsy and Specimen Forceps 464
Pan, Bed 750
Parametrium Forceps 197
Parametrium Scissors, DURACUT 60
PARK-ALAN Rectal Retractor 408
PARKER-LANGENBECK (US-ARMY) Retractors 231
PARKER-MOTT Retractors 228
PARKER Retractors 228
PASQUE EUFRATE TITE GRIP Needle Holders 344
Patella Forceps 623
Patent Ductus Clamps, ATRAUMATIC-GRIP 531, 556
PAUFIQUE Delicate Tissue Forceps 139
PAUL-MIXTER (HEISS) Dissecting and Ligature Forceps 182
PAUL Tendon Sheath Retractor 225
PAYR-BABY Intestinal and Stomach Clamp 403
PAYR Intestinal and Stomach Clamp 403
PAYR Ligature Conductors 377
PAYR Vascular Suture Needles 354
PEAN-DE BAKEY ATRAUMATIC-GRIP Haemostatic Forceps 176
PEAN-DE BAKEY ATRAUMATIC-GRIP Vascular Clamps 529
PEAN-ROCHESTER Haemostatic Forceps 175
PEAN (DIXON) Haemostatic Forceps 174
PEAN Haemostatic Forceps 173-174
PEDERSON Vaginal Specula 432-433

PEERS Towel Clamps 202
PEET Splinter Forceps 151
PEET TITE GRIP Splinter Forceps 151
PELTESON Cotton Applicators 317
Pelvimeter 477
Pelvis Retractors 256-258
Pencils and Apparatus for Marking and Writing 757
PENFIELD Dura Dissectors 699
Penis Clamps 426
PENNINGTON Intestinal and Tissue Grasping Forceps 387
Percussion Hammers 2-3
PERCY Amputation Retractors 571
PERFECT GRIP Micro Grasping Forceps 124
PERFECT GRIP Micro Needle Holders 359, 361-362
PERFECT GRIP Micro Suture Tying Forceps 123
PERFECT GRIP Needle Holders 364
PERFECT GRIP TITAN LINE Needle Holders 365
Perforator 485
Perineum Scissors 107
Perineum Scissors, DURACUT 60
Periosteum Knife 39
Peripheral Vascular Clamps, ATRAUMATIC-GRIP 534-536, 558
Peritoneum Forceps 192-193
PERMAN Abdominal Retractor 299
PERTHES Reamers 650
PETZ VON Stomach and Intestinal Suturing Apparatus 404
Phalangeal Knife 39
PHANEUF Hysterectomy Forceps 194
Pick-Up Forceps 735
Picks, Double 212
PIERCE Antrum Trocar 319
PIFFARD Lupus Curettes 20
PINARD Stethoscope 5
Pins 654
Pins, Conisation 447
Pins, Safety for Holding Ring Handle Instruments 736
PIPER Forceps 480
Pistol, Water Jet with Several Tips 754-755
Pituitary Instruments 692-693
Pituitary Rongeurs 719
Placenta and Ovum Curettes 484
Placenta and Ovum Forceps 482-483
Placenta and Ovum Scoops 484
Plaster-of-Paris Shears 675-678
Plaster-of-Paris Shears, DURACUT 676
Plaster Breakers 682
Plaster Knives 679
Plaster Saw 679
Plaster Saw, Oscillating 680-681
Plaster Spreaders 682
Plastic Surgery Hook 217-218, 226
Plastic Surgery Scissors 70, 82
Plastic Surgery Scissors, DURACUT 45
PLESTER Self-Retaining Retractors 275
Pleura Puncture Needle 518
Pneumoperitoneum Needles 329
Polypus and Ovum Forceps 457
POOLE Suction Tubes 325
Post Mortem Knives 40
POTTS-DE BAKEY ATRAUMATIC-GRIP Patent Ductus Clamps 531
POTTS-SMITH Delicate Dissecting Forceps 131
POTTS-SMITH Delicate Tissue Forceps 143
POTTS-SMITH Dissecting Scissors 98
POTTS-SMITH DURACUT Vascular Scissors 56
POTTS-SMITH TITE GRIP Dissecting Forceps 114
POTTS-SMITH Vascular Scissors 96-97
POZZI Uterine Tenaculum Forceps 453
PRATT Fistula Probes (Crypt Hooks) 409
PRATT Rectal Speculum 405
PRATT Uterine Tenaculum Forceps 455
PREP LUBE Instrument Care Lubricant 733
PRESBYTERIAN Tubing Clamp 203
Pressure Clamp 409
PRICE-THOMAS Bronchus Forceps 566
Probes 312-314
Probes with eye 313
Probes, Buttoned 312-313, 694
Probes, Fistula 314, 409
Probes, Gall Duct 415

Probes, Gall Stone 415
 Probes, Lachrymal 312
 Probes, Laser Surgery 450-451
 Probes, Measuring, for Laser Surgery 450
 Probes, Myrtle Leaf 313
 Probes, Rectal 409
 Probes, Twin 694
 Probes, Uterine 446
 Profunda Clamps, ATRAUMATIC GRIP 534
 Prostatectomy Instruments 423
 Prostatic Lobe Holding Forceps 423
 Prostatic Retractors 422
PROVIDENCE-HOSPITAL Delicate Haemostatic Forceps 168
 Punches, Dermal 20
 Punches, Laminectomy 707-712
 Pusher, Suture 694
PUTTI Rasps 594
 PVC-Tubing for Micro-Bloodletting 473
 Pylorus Spreader 403
PYNCHON-ANDREW Suction Tube 325

Q

QUERVAIN Elevator 575
QUINBY Gum Scissors 94
QUINKE Lumbar Puncture Needles 328

R

RABINER Percussion Hammer 3
 Racks, Lable 743
 Racks, Safety for Holding Ring Handle Instruments 736
 Racks, Sterilizing 736-737
 Racks, Sterilizing for Suture Needles 736
RADOLF Nail Extracting Forceps 645
RAGNELL-DAVIS Hook for Plastic Surgery 226
RAGNELL DURACUT Dissecting Scissors 49
RAGNELL Surgical and Dissecting Scissors 83
RALK Hand Drill 653
RALKS (VIRTUS) Splinter Forceps 151
RAMPLEY Dressing and Sponge Holding Forceps 210
RANDALL Endometrial Suction Biopsy Curette 459
RANDALL Kidney Stone Forceps 420-421
RANEY Applying and Removing Forceps 691
RANEY Scalp Hemostasis Clip Carrier 691
RANEY Scalp Hemostasis Clips 691
RANKIN-CRILE-DE BAKEY ATRAUMATIC-GRIP Delicate Haemostatic Forceps 167
RANKIN-CRILE (OCHSNER-DIXON) Delicate Haemostatic Forceps 167
RANKIN-CRILE Delicate Haemostatic Forceps 167
RANKIN-KELLY Delicate Haemostatic Forceps 169
 Raspatories 582-591, 694-697
 Raspatories, Rib 495-497
 Rasps 592-595
 Rasps, TITE GRIP 596-597
RAY Curettes 692
 Razor Blade Holders and Breakers 36
 Reamers 650
RECAMIER Placenta and Ovum Curettes 484
RECAMIER Uterine Curettes 468
 Rectal Biopsy Specimen Forceps 412
 Rectal Probes 409
 Rectal Retractor 407-408
 Rectal Scissors 99
 Rectal Scissors, DURACUT 59
 Rectal Specula 405-406
REDO Intestinal Clamp Forceps 390
REDON Guide Needles 334
REINER Plaster Knife 679
 Removing and Applying Forceps for Bulldog Clamps 160, 527
 Removing and Applying Forceps for Scalp Hemostasis Clips 691
 Renal Artery Clamp, ATRAUMATIC-GRIP 537, 558
 Reposition Forceps 622-623
RESANO ATRAUMATIC-GRIP Sigmoid Anastomosis Forceps 400-401
 Resection and Amputation Saws 572-573
 Resection Knives 38-39
 Retractors 212, 216-251, 261-265, 721

Retractors, Abdominal 248-249, 297-309
 Retractors, Amputation 571
 Retractors, Appendectomy 284
 Retractors, Atrium 509
 Retractors, Bladder 310
 Retractors, Bone 232
 Retractors, Cervical Spine 285
 Retractors, Cervical Vertebral Column 290-292
 Retractors, Deep Hand and Forearm 271
 Retractors, Deep Surgery 252-259
 Retractors, double-ended 226-230
 Retractors, Dura 212, 216-217
 Retractors, Finger 271
 Retractors, Goitre 224
 Retractors, Hand and Carpal Tunnel 271
 Retractors, Hemi-Laminectomy 277
 Retractors, Hilar 223
 Retractors, Knee 641
 Retractors, Laminectomy 276, 279-280, 284, 286
 Retractors, Liver 255
 Retractors, Lumbar Vertebral Column 294
 Retractors, Lung 260
 Retractors, Micro Surgery 212
 Retractors, Nerve Root 701
 Retractors, Pelvis 256-258
 Retractors, Prostatic 422
 Retractors, Rectal 407-408
 Retractors, Scapula 260
 Retractors, Self-Retaining 270-285
 Retractors, Self-Retaining for Brain 702-705
 Retractors, Self-Retaining for Fixation to Operating Table 704
 Retractors, Self-Retaining for Skull Mounting 702
 Retractors, Skin 216-218
 Retractors, Soft Tissue 241
 Retractors, Spinal 231
 Retractors, Tendon Sheath 225
 Retractors, Thoracic 507
 Retractors, Thyroid Gland 243
 Retractors, Trachea 217, 219-220, 226
 Retractors, Trachea 728
 Retractors, Vaginal 281
 Retractors, Vaginal and Specula 434-437, 439
 Retractors, Vein 217, 222-223
 Retractors, Vertebral Column 288
REVERDIN Abdominal and Intestinal Spatula 267
REVERDIN Needles 373
REYNOLDS-COOLEY ATRAUMATIC-GRIP Anastomosis Clamps 559
REYNOLDS-DE BAKEY ATRAUMATIC-GRIP Anastomosis Clamps 542
REYNOLDS Delicate Dissecting Scissors 93
REZEK-HEANEY Hysterectomy Forceps 196
 Rhinoplastic Knives 37
 Rhinoscopic Mirrors 14
 Rib and Bone Holding Forcpes 493
 Rib Contractors 508
 Rib Raspatories 495-497
 Rib Rongeurs 494
 Rib Shears 492-493
 Rib Spreaders 503-508
 Rib Spreaders from ALUMINIUM 500-502
RICARD Abdominal Retractors 298
RICHARDSON-EASTMAN Retractors 250
RICHARDSON Retractors 251
RICHTER-HEATH Clip Removing Forceps 379
RICHTER Operating Scissors 80
RIENHOFF-FINOCHIETTO Rib Spreaders 506
ROBB Intima Spatulas and Dilators 512
ROBERTS Haemostatic Forceps 178
ROBSON-MAYO ATRAUMATIC-GRIP Intestinal Clamp Forceps 396
ROBSON-MAYO Intestinal Clamp Forceps 396
ROCHARD Abdominal Retractors 309
ROCHARD Fixation Device for Abdominal Retractors 309
ROCHARD Mounting Frame for Abdominal Retractors 309
ROCHESTER-CARMALT Haemostatic Forceps 178
ROCHESTER-OCHSNER Haemostatic Forceps 178
ROCHESTER-PEAN Haemostatic Forceps 175
ROEDER Towel Clamps 201
ROGERS (DE BAKEY-HEANY) Hysterectomy Forceps 197
ROGERS (DE BAKEY-WERTHEIM) Parametrium Forceps 197
ROGGE Sterilizing Forceps 734

Roller, Tube Milking	203
ROLLET Retractor	218
Rongeurs, Bone	631-636
Rongeurs, Cranial	688
Rongeurs, Cranial Punch	688
Rongeurs, Laminectomy	713-719
Rongeurs, Pituitary	719
Rongeurs, Rib	494
ROSCHKE Rectal Retractor	407
ROSE Retractors	227
ROSEGGER-KLIMA Sternum Puncture Needles	329, 518
ROSEN Suction Cannulae	320
ROSER-KÖNIG Mouth Gag	22
RÖTTGEN-RUSKIN Bone Rongeur	636
ROUX-BABY Retractors	228
ROUX Retractors	229
RUDD Haemorrhoidal Ligator	410
Ruler	6
RUMEL-BELMONT Tourniquets	518
RUMEL-DE BAKEY ATRAUMATIC-GRIP Dissecting and Ligature Forceps	186
RUMEL Dissecting and Ligature Forceps	186
RUSKIN-LISTON Bone Cutting Forceps	638
RUSKIN-RÖTTGEN Bone Rongeur	636
RUSKIN-STILLE Bone Rongeur	636
RUSKIN Bone Cutting Forceps	638
RUSKIN Bone Rongeurs	633-634
RUSS, MODELL Vascular and Tumor Forceps	149
RUST Amputation and Resection Saw	573
RYDEL-SEIFFER Tuning Fork	4
RYDER-LANGENBECK TITE GRIP Needle Holders	350
RYDER-VASCULAR TITE GRIP Needle Holders	340
RYDER TITE GRIP Needle Holders	340

S

SAALFELD Comedo Extractors	19
SACHS Dura Hook	217
SACHS Dura Separators	698
SACHS Fistula Hook	221
SACHSE Meatotome	426
SAENGER Placenta and Ovum Forceps	483
Safety Pins for Holding Ring Handle Instruments	736
Safety Racks for Holding Ring Handle Instruments	736
SALENIUS Meniscus Knives	642
SALING Amnioscopic Tubes	472
Salpingograph	474
SAMII-YASARGIL Tumor and Tissue Grasping Forceps	126
SAMII Tumor and Tissue Grasping Forceps	127
SANVENERO Plastic Surgery Scissors	70
SAROT Bronchus Forceps	566
SAROT Delicate Haemostatic Forceps	171
SAROT TITE GRIP Needle Holder	344
SATINSKY-BABY Anastomosis (Vena Cava) Clamp	565
SATINSKY-DE BAKEY ATRAUMATIC-GRIP Bulldog Clamps	525
SATINSKY-DE BAKEY ATRAUMATIC-GRIP Tangential Occlusion Clamps	541
SATINSKY Anastomosis (Vena Cava) Clamps	565
SATINSKY Vena Cava Scissors	99
SATTERLEE Amputation and Resection Saws	572
SAUER Delicate Tissue Forceps	138
SAUERBRUCH-FREY Rib Shears	493
SAUERBRUCH-SCHNEIDER Raspatory	588
SAUERBRUCH Needle Sterilizing Boxes	357
SAUERBRUCH Pick-Up Forceps	735
SAUERBRUCH Retractors	242
SAUERBRUCH Rib Shears	492
Saws, Amputation and Resection	572-573
Saws, Finger Ring	645
Saws, Plaster	679
Saws, Plaster, Oscillating	680-681
Saws, Resection and Amputation	572-573
Saws, Wire	687
SCALP CONTOUR Self-Retaining Retractors	276
Scalp Flap Forceps	481
Scalp Hemostasis Clips	691
Scalpel Blades, Sterile	34-35
Scalpel Handles	34-35

Scapula Retractors	260
SCHAAF Cilia Forceps	152
SCHÄDEL Towel Clamps	200
SCHAMBERG Comedo Extractor	19
SCHEDE Bone Curettes	602
SCHERBACK Vaginal Specula	442
SCHINK Dermatome	41
SCHMID Intima Spatulas	513
SCHMID Vascular Irrigation Cannulae	322
SCHMIEDEN-TAYLOR Dura Scissors	100
SCHMIEDEN Ligature Conductor	378
SCHNEIDER-SAUERBRUCH Raspatory	588
SCHNEIDER Raspatory	588
SCHNIDT Haemostatic and Tonsil Forceps	179
SCHOEMAKER-LOTH Ligature Scissors	352
SCHRÖDER Uterine Scoops	466
SCHRÖDER Uterine Tenaculum Forceps	452, 454
SCHUBERT Cervical Biopsy and Specimen Forceps	461
SCHULTZE Salpingograph	474
SCHUMACHER Cervical Biopsy and Specimen Forceps	463
SCHUMACHER Umbilical Cord Scissors	108
SCHWARTZ Applying Forceps for Vessel Clips	155
SCHWARTZ Vessel Clips	155
Scissors, Abdominal	106
Scissors, Arteriotomy	95
Scissors, Bandage	672-674
Scissors, Bandage and Cloth	674
Scissors, Cartilage	82
Scissors, Cloth	674-675
Scissors, Cloth and Bandage	674
Scissors, Coronary Artery	95
Scissors, Cuticle	16
Scissors, Decapitating	109
Scissors, Dissecting	81-91, 95, 98
Scissors, Dissecting, Delicate	92-93
Scissors, Dura	100
Scissors, DURACUT, Adnex	54
Scissors, DURACUT, Bandage	673
Scissors, DURACUT, Delicate	45
Scissors, DURACUT, Dissecting	47-54
Scissors, DURACUT, Episiotomy	60
Scissors, DURACUT, Fistula	45
Scissors, DURACUT, Gum	55
Scissors, DURACUT, Gynecological	60
Scissors, DURACUT, Iris	45
Scissors, DURACUT, Ligature	353
Scissors, DURACUT, Nasal	58
Scissors, DURACUT, Parametrium	60
Scissors, DURACUT, Perineum	60
Scissors, DURACUT, Plastic Surgery	45
Scissors, DURACUT, Rectal	59
Scissors, DURACUT, Septum	59
Scissors, DURACUT, Surgical	46
Scissors, DURACUT, Uterine	60
Scissors, DURACUT, Vascular	45, 56-57
Scissors, DURACUT, Wire Cutting	665
Scissors, Embryotomy	109
Scissors, Enterotomy	109
Scissors, Episiotomy	107
Scissors, Fistula	80
Scissors, Gum	94
Scissors, Incision	80
Scissors, Ligature	352
Scissors, Lobectomy	99
Scissors, Lower Lateral	81
Scissors, Micro	62-67
Scissors, Micro Dissecting	65, 67
Scissors, Nail	16
Scissors, Nail Splitting	81
Scissors, Nasal	101-102
Scissors, Nerve Dissecting	93
Scissors, Neurosurgical	100
Scissors, Operating	80
Scissors, Perineum	107
Scissors, Plastic Surgery	70, 82
Scissors, Rectal	99
Scissors, Septum	102
Scissors, Surgical	71-83
Scissors, Surgical, Delicate	68-70

- Scissors, Tendon 92
 Scissors, Tonsil 103
 Scissors, Trigeminal 100
 Scissors, Umbilical Cord 108
 Scissors, Uterine 104-106
 Scissors, Vascular 80, 95-98
 Scissors, Vein 63
 Scissors, Vena Cava 99
 Scissors, Wire Cutting 665
 Scoops 695-696
 Scoops, Gall Bladder 417
 Scoops, Gall Stone 417
 Scoops, Ovum and Placenta 484
 Scoops, Placenta and Ovum 484
 Scoops, Uterine 466
SCOVILLE-HAVERFIELD Self-Retaining Retractors 286
SCOVILLE (OLIVECRONA-TOENNIS) Clip Applying Forceps 690
SCOVILLE Hooks for Self-Retaining Retractors 287
SCOVILLE Lateral Valves for Self-Retaining Retractors 287
SCOVILLE Nerve Root Retractors 701
SCOVILLE Self-Retaining Retractors 286
 Scrapers, Lupus 19
 Screws, Myoma 458
 Screws, Oral 22
SCUDDER ATRAUMATIC-GRIP Stomach Clamp Forceps 397
SEALY Delicate Surgical Scissors 68
SEBILEAU Elevator 575
 Secretion Curette 425
SEDILLOT Raspatories 586
SEGD Hysterectomy Forceps 195-196
SEIFFER-RYDEL Tuning Fork 4
SELETZ-GELPI Vaginal Retractors 281
 Self-Retaining Brain Retractors 702-705
 Self-Retaining Retractors 270-285
 Self-Retaining Retractors for Fixation to Operating Table 704
 Self-Retaining Retractors for Skull Mounting 702
SELLHEIM Obstetric Lever 481
SELLORS Rib Spreader 508
SEMB Bone Cutting Forceps 494
SEMB Dissecting and Ligature Forceps 564
SEMB Lung Retractors 260
SEMB Rib and Bone Holding Forceps 493
SEMB Rib Raspatories 496
SEMB Rib Rongeur 494
SEMKEN Delicate Dissecting Forceps 130
SEMKEN Delicate Tissue Forceps 142
SEMKEN TITE GRIP Dissecting Forceps 113
SEMKEN TITE GRIP Tissue Forceps 117
SEMM Abdominal Retractor 305
SEMM Vaginal Specula 432
SENN-GREEN Retractors 224
SENN-MILLER Retractors 226
 Sensibility Instruments 4
 Separators, Dura 698
 Septum Needles 328
 Septum Scissors 102
 Septum Scissors, DURACUT 59
 Sequestrum Forceps 623
 Set for Nurses 18
SEUTIN Cloth Scissors and Plaster-of-Paris Shears 675
SEWALL Raspatory 582
SHAMBAUGH Retractors for Micro Surgery 212
 Shears, DURACUT, Plaster-of-Paris 676
 Shears, Plaster-of-Paris 675-678
 Shears, Rib 492-493
 Side-Arms for **BALFOUR** Abdominal Retractors 303
SIEBOLD-SIMS Uterine Scissors 106
SIEBOLD Uterine Scissors 106
 Sigmoid Anastomosis Forceps 400
 Sigmoid Anastomosis Forceps, ATRAUMATIC-GRIP 400-401
SILVER Dermatome 41
 Silver Wire 690
SIMON-HEANEY Retractor for Deep Surgery 254
SIMON Bone Curettes 605
SIMON Fistula Hook 221
SIMON Retractors for Deep Surgery 254
SIMON Uterine Scoops 466
SIMPSON-BRAUN Forceps 478
SIMPSON Uterine Probes 446
SIMS-MAIER Sponge and Dressing Forceps 205
SIMS-SIEBOLD Uterine Scissors 106
SIMS DURACUT Uterine Scissors 60
SIMS Rectal Specula 405-406
SIMS Uterine Curettes 467
SIMS Uterine Probes 446
SIMS Uterine Scissors 104-105
SIMS Vaginal Specula 438
SINGLEY (TUTTLE) Lung Dissecting Forceps 149
 Sinus Forceps 204
 Skin Retractors 216-218
 Skin Straightening Plate for **SCHINK** Dermatome 41
SMELLIE Perforator 485
SMILLIE Meniscus Knives 643
SMILLIE Retractors for Knee 641
SMITH-BUIE Rectal Retractor 408
SMITH-FERRIS-CUSHING Laminectomy Rongeurs 713
SMITH-FERRIS-KERRISON Laminectomy Punches 709-710, 712
SMITH-FERRIS Tissue Forceps 147
SMITH-HEYWOOD Polypus and Ovum Forceps 457
SMITH-HEYWOOD Tongue Holding Forceps 23
SMITH-POTTS Delicate Dissecting Forceps 131
SMITH-POTTS Delicate Tissue Forceps 143
SMITH-POTTS Dissecting Scissors 98
SMITH-POTTS DURACUT Vascular Scissors 56
SMITH-POTTS TITE GRIP Dissecting Forceps 114
SMITH-POTTS Vascular Scissors 96-97
SMITH Bandage Scissors 672
SOFT-GREGORY ATRAUMATIC-GRIP Carotid Clamps 527
 Soft Tissue Retractors 241
 Solution Bowls 749
SOMER Uterine Elevating Forceps 458
 Spare Blade for **HUMBY** Dermatome 42
 Spare Blade for **SCHINK** Dermatome 41
 Spare Bulbs for Head Lamps 11
 Spatulas, Abdominal 266-267
 Spatulas, Bladder 268
 Spatulas, Brain 706
 Spatulas, Intestinal 266-267
 Spatulas, Intima 512-513
 Spatulas, Intima and Dilators 512
 Spatulas, Lung 260-265
 Speaking Tubes, Valve 726-727
 Special Needles 328
 Specimen and Aspirating Curettes 471
 Specimen and Cervical Biopsy Forceps 460-465
 Specula, Endo- 443
 Specula, Endo- for Lasersurgery 448
 Specula, Lateral for Lasersurgery 448
 Specula, Lumbar Vertebral Operations 295
 Specula, Rectal 405-406
 Specula, Trans-Sphenoidal Hypophysectomy 692
 Specula, Vaginal 430-442
 Specula, Vaginal and Retractors 434-437, 439
SPENCER-WELLS Haemostatic Forceps 173
SPENCER (NORTHBENT) Ligature Scissors 352
SPENCER Ligature Scissors 352
 Sphincteroscopes 407
 Spinal Gouges 616
 Spinal Retractors 231
 Splinter Forceps 150-151
 Splinter Forceps, TITE GRIP 151
 Sponge and Cotton Holder 473
 Sponge and Dressing Forceps 204-207
 Sponge Holding and Dressing Forceps 209-210
 Spongiosa Gouges 615
SPRATT Bone Curettes 602
 Spreaders, Bladder Neck 423
 Spreaders, Lamina 296
 Spreaders, Plaster 682
 Spreaders, Pylorus 403
 Spreaders, Rib 503-508
 Spreaders, Rib, from ALUMINIUM 500-502
 Spring Hooks for Galea Fixation 691
 Spur Crusher 403
SPURLING Laminectomy Rongeurs 717
 Sputum Cup 751
ST. MARKS Pelvis Retractors 258
ST. MARTIN Delicate Tissue Forceps 139

STADLER-BRAUN Perineum (Episiotomy) Scissors 107
STANDARD-YASARGIL Applying Forceps for Vessel Clips 154
STANDARD-YASARGIL Vessel Clips 154
STAUDE-MOORE Uterine Tenaculum Forceps 452
Steel Rules 6
Steel Tape Measure 6
STEINMANN Pins 654
STEINMANN Tendon Seizing Forceps 647
STELLBRING Bone Rongeurs 632
STELZNER (CRAFOORD) Lobectomy and Rectal Scissors 99
Sterile Scalpel Blades 34-35
Sterilizing and Storing Cases 738
Sterilizing Baskets 745
Sterilizing Boxes 739-742
Sterilizing Boxes for Needles 357
Sterilizing Drums 743
Sterilizing Forceps 734-735
Sterilizing Rack for Suture Needles 736
Sterilizing Racks 736-737
Sterilizing Trays 744
Sternotomy Spreaders 499
Sternotomy Spreaders from ALUMINIUM 498
Sternum Chisel 492
Sternum Puncture Needles 329, 518
Stethoscopes 5
STEVENS Delicate Dissecting and Tendon Scissors 92
STIEGLITZ (WILLIAMS) Splinter Forceps 151
STILLE-BARRAYA Vascular and Tumor Forceps 148
STILLE-CRAFOORD Delicate Haemostatic Forceps 170
STILLE-DOYEN Retractors 247
STILLE-GIERTZ Rib Shears 492
STILLE-LEKSELL Bone Rongeurs 635
STILLE-LUER Bone Rongeurs 634, 636
STILLE-MAYO Dissecting Scissors 85
STILLE-MAYO DURACUT Dissecting Scissors 48
STILLE-MINI Plaster-of-Paris Shears 677
STILLE-RUSKIN Bone Rongeur 636
STILLE-STRANDELL Tendon Sheath Retractor 225
STILLE Bone Rongeurs 635
STILLE Chisels 610
STILLE Gouges 610
STILLE Hand Bone Drill 651
STILLE Osteotomes 610
STILLE Plaster-of-Paris Shears 677-678
STOCKMANN Penis Clamp 426
Stomach and Intestinal Clamps 403
Stomach and Intestinal Suturing Apparatus 404
Stomach Clamp Forceps, ATRAUMATIC-GRIP 397
Stopcocks for Syringes 333
Storing and Sterilizing Cases 738
Storing Cup 737
Strabismus Hooks 213
STRANDELL-STILLE Tendon Sheath Retractor 225
STRATTE TITE GRIP Needle Holders 347
STRAUSS Penis Clamp 426
Strippers, Endarterectomy 514-515
Strippers, Tendon 646
Strippers, Vein 315
STRULLY Neurosurgical Scissors 100
SUBRAMANIAN ATRAUMATIC-GRIP Aortic Clamps 537
Suction Adapter 320
Suction Cannulae 320-323
Suction Handle 320
Suction Tubes 324-327
Suction Tubes, Intracardiac 327
Suction Tubes, Left Ventricular Sump 327
Suction Tubes, Micro 321
Suction Tubes, Nasal 324
Suction Tubes, Vascular 327
SULLIVAN (BROPHY) Delicate Dissecting Scissors 93
SUPER Stethoscope 5
Surgical Scissors 71-83
Surgical Scissors, Delicate 68-70
Surgical Scissors, DURACUT 46
Surgical Suture Needles 354-356
Suture Catcher 378
Suture Clips 379, 404
Suture Hooks 518
Suture Instruments 378

Suture Material 353
Suture Needle Sterilizing Rack 736
Suture Needles, Surgical 354-356
Suture Needles, Vascular 354
Suture Pusher 694
Suture Silk 353
Suture Tying Forceps, TITE GRIP 113
Suturing Apparatus, Intestinal and Stomach 404
Suturing Instrument Set 380
SWEET-LAHEY Dissecting and Ligature Forceps 189
SWITZERLAND MOD. Micro Forceps (Jeweler Patterns) 120
Syringes 330-332
Syringes, Connecting Pieces 333
Syringes, Ear 332
Syringes, Insuline 330
Syringes, Stopcocks 333
Syringes, Tuberkuline 330
Syringes, Wound and Bladder 331
SYSTRUNK Nail Splitting Scissors 81

T

TAKAHASHI Laminectomy Rongeurs 714
Tampers 606
Tangential Occlusion Clamps, ATRAUMATIC-GRIP 541, 562
Tape Measure 6
TARNIER Forceps 480
TAYLOR-CUSHING Delicate Dissecting Forceps 131
TAYLOR-CUSHING Delicate Tissue Forceps 143
TAYLOR-CUSHING Ear and Nasal Dressing Forceps 136
TAYLOR-CUSHING TITE GRIP Dissecting Forceps 114
TAYLOR-SCHMIEDEN Dura Scissors 100
TAYLOR Lateral Valves for Self-Retaining Retractors 287
TAYLOR Percussion Hammers 2
TEALE Uterine Tenaculum Forceps 456
Tenaculum Forceps, Uterine 452-456
Tendon Holding Forceps 648
Tendon Interlacing Forceps 649
Tendon Passing and Tunneling Instrument 646
Tendon Passing Forceps 649
Tendon Passing Instruments 646
Tendon Scissors 92
Tendon Seizing Forceps 647
Tendon Sheath Retractors 225
Tendon Strippers 646
Tenotome 37
THOMAS-PRICE Bronchus Forceps 566
THOMS-ALLIS Intestinal and Tissue Grasping Forceps 385
THOMS-GAYLOR Cervical Biopsy and Specimen Forceps 460
Thoracic and Ligature Forceps 564
Thoracic Retractor 507
THOREK-METZENBAUM DURACUT Adnex Scissors 54
THOREK Dissecting Scissors 98
THORLAKSON ATRAUMATIC-GRIP Lower Occlusive Clamps 399
THORLAKSON ATRAUMATIC-GRIP Upper Occlusive Clamp 398
THORLAKSON Pelvis Retractors 256-257
THORLAKSON Retractors 230, 256
Thyroid Gland Retractor 243
TISCHLER-BABY Cervical Biopsy and Specimen Forceps 464
TISCHLER-MORGAN Cervical Biopsy and Specimen Forceps 464
TISCHLER Cervical Biopsy and Specimen Forceps 465
Tissue and Intestinal Grasping Forceps 383-388
Tissue and Intestinal Grasping Forceps, ATRAUMATIC-GRIP 389
Tissue and Intestinal Grasping Forceps, TITE GRIP 388
Tissue Forceps 144-148
Tissue Forceps, Delicate 138-143
Tissue Forceps, TITE GRIP 117
Tissue Grasping Forceps 126-127
Tissue Seizing Forceps 148
TITAN LINE Bulldog Clamps 160-161
TITAN LINE Delicate Haemostatic Forceps 164, 166, 168
TITAN LINE PERFECT GRIP Needle Holders 365
TITE GRIP Dissecting Forceps 113-115
TITE GRIP Intestinal and Tissue Grasping Forceps 388
TITE GRIP Micro Forceps 118
TITE GRIP Micro Needle Holders 338-339
TITE GRIP Needle Holders 340-350
TITE GRIP Needle Holders for Left-Hander 341

- TITE GRIP Needlepulling Tissue Forceps 116
 TITE GRIP Rasps 596-597
 TITE GRIP Splinter Forceps 151
 TITE GRIP Suture Tying Forceps 113
 TITE GRIP Tissue Forceps 117
 TITE GRIP Wire Holding Forceps 663
 TITE GRIP Wire Twisting Forceps 662
TOENNIS-ADSON Dissecting Scissors 89
TOENNIS-ADSON DURACUT Dissecting Scissors 49
TOENNIS-OLIVECRONA (SCOVILLE) Clip Applying Forceps 690
TOENNIS Dura Dissectors 700
TOENNIS Dura Knives 37
TOENNIS Needle Holders 371
TOENNIS Surgical and Dissecting Scissors 83
TOENNIS TITE GRIP Needle Holders 350
TOHOKU Towel Clamps 202
 Tongue Depressors 12
 Tongue Holding Forceps 23
 Tonsil Forceps 179
 Tonsil Needles 328
 Tonsil Scissors 103
 Tourniquets 518
 Towel and Brush Baskets 753
 Towel Clamps 200-202
TOWNSEND Cervical Biopsy and Specimen Forceps 465
 Trachea Dilators 728
 Trachea Retractors 217, 219-220, 226, 728
 Trachea Tubes 725-727
 Tracheotomy Instruments 728
 Tracheotomy Set 729-730
 Traction Bar for Bone Clamps 630
 Traction Handle for Forceps 479
 Trans-Sphenoidal Hypophysectomy Specula 692
 Transformer 11
 Trays 748
 Trays, Instrument Storing 748
 Trays, Sterilizing 744
TRELAT Raspatory 582
TRELAT Vaginal Specula 431
 Trephines 721
 Trephines, Bone Biopsy 669
 Triangular Basins 750
 Trigeminal Scissors 100
 Trocar Antrum Needles 319
 Trocar Cannula 721
 Trocars 318, 721
 Trocars, Antrum 319-320
 Trocars, Cryothyreotomy 728
 Trocars, Empyema 318
 Trocars, Gall Bladder 318
TROELTSCH (WILDE) Ear and Nasal Dressing Forceps 137
TROELTSCH Ear and Nasal Dressing Forceps 137
TROEMNER Percussion Hammer 3
TROUSSEAU Trachea Dilator 728
TROUTMAN-BARRAQUER Micro Needle Holders 360
TROUTMAN Razor Blade Holder and Breaker 36
 Trumpet Needle Guide 486
TUBBS Aortic Dilator 511
 Tube Milking Roller 203
 Tuberkuline Syringe 330
 Tubes, Amnioscopic 472
 Tubes, Compression 570
 Tubes, Suction 324-327
 Tubes, Trachea 725-727
 Tubes, Tunneling 517
 Tubes, Valve Speaking 726-727
 Tubing Clamps 203
TÜBINGEN MOD. VANNAS Micro Scissors 62
TUFFIER Abdominal and Intestinal Spatula 267
TUFFIER Rib Spreaders 506
 Tumor Forceps 148-149
 Tumor Grasping Forceps 126-127
 Tuning Forks 4
 Tunneling and Tendon Passing Instrument 646
 Tunneling Instruments for Bypass Grafting 517
 Tunneling Set 516
 Tunneling Tubes 517
TUOHY Lumbar Puncture Needles 328
TUTTLE (SINGLEY) Lung Dissecting Forceps 149
 Twin Probe 694
 Twinlenses for **BERGER** Binocular Head Magnifiers 8
 Twist Drill 652
TYRELL (GRAEFE) Skin Retractors 216
- U**
- UCKERMANN** Cotton Applicators 317
UECKERMANN-DENKER Cryothyreotomy Trocars 728
UFFENORDE Bone Curettes 601
ULRICH Bone Holding Forceps 627
ULRICH Fistula Knife 37
ULRICH Sponge and Dressing Forceps 206
 Umbilical Cord Clamps 486
 Umbilical Cord Scissors 108
UNIVERSAL DURACUT Wire Cutting Scissors 665
UNIVERSAL Trocars 318
UNIVERSAL Wire Cutting Scissors 665
UNNA-VIDAL Comedo Extractor 19
UNNA Comedo Extractors 19
 Upper Occlusive Clamp, ATRAUMATIC-GRIP 398
 Urethrography Instrument 426
 Urinary-Genito Instruments 425-426
US-ARMY (PARKER-LANGENBECK) Retractors 231
USA MOD. Bone Curettes 601
USA MOD. Dissecting Forceps 133
USA MOD. Plaster Spreader 682
USA MOD. Tissue Forceps 145
USA MOD. Umbilical Cord Scissors 108
 Uterine Curettes 466-470
 Uterine Depressor 447
 Uterine Dilator 443-445
 Uterine Dressing Forceps 208
 Uterine Elevating Forceps 458
 Uterine Gauze Packer 447
 Uterine Probes 446
 Uterine Scissors 104-106
 Uterine Scissors, DURACUT 60
 Uterine Scoops 466
 Uterine Tenaculum Forceps 452-456
- V**
- V. EICKEN LICHTWITZ** Antrum Trocar Needles 319
 Vaginal Retractors 281
 Vaginal Retractors and Specula 434-437, 439
 Vaginal Specula 430-442
 Vaginal Specula and Retractors 434-437, 439
VALLEIX Uterine Probes 446
 Valve Ejector for **CASPAR** Self-Retaining Retractors 289
 Valve Speaking Tubes 726-727
 Valves for **KIRSCHNER-BALFOUR** Abdominal Retractors 307
 Valves for **KIRSCHNER** Abdominal Retractors 307
 Valves, Blunt for **CASPAR** Self-Retaining Retractors 293
 Valves, Central for **BALFOUR** Abdominal Retractors 303
 Valves, Central for **HORGAN** Abdominal Retractors 303
 Valves, Lateral for **BALFOUR** Abdominal Retractors 303
 Valves, Lateral for **CASPAR** Self-Retaining Retractors 289, 293
 Valves, Medial for **CASPAR** Self-Retaining Retractors 293
VAN BUREN Dilating Bougies 424
VAN BUREN Sequestrum Forceps 623
VAN DOREN Cervical Biopsy and Specimen Forceps 461
VANNAS MOD. TÜBINGEN Micro Scissors 62
VANNAS-YASARGIL Micro Scissors 66
VANNAS Micro Scissors 62-63, 65
VARCO Delicate Haemostatic Forceps 170
VASCULAR-RYDER TITE GRIP Needle Holders 340
 Vascular Clamps, ATRAUMATIC-GRIP 520-523, 529-530, 534, 537, 555, 558, 561-562
 Vascular Clamps, Semi-Flexible 563
 Vascular Dilators 510
 Vascular Forceps 148-149
 Vascular Forceps, ATRAUMATIC-GRIP 135
 Vascular Irrigation Cannulae 322
VASCULAR PERFECT GRIP Needle Holders 364
 Vascular Scissors 80, 95-98
 Vascular Scissors, DURACUT 45, 56-57

Vascular Suction Tube	327
Vascular Suture Needles	354
VASCULAR TITAN LINE PERFECT GRIP Needle Holders	365
Vein Retractor	217, 222-223
Vein Scissors	63
Vein Strippers	315
Vena-Cava (Anastomosis) Clamps	565
Vena-Cava Clamps, ATRAUMATIC-GRIP	550
Vena Cava Scissors	99
VERBRUGGE-MÜLLER Bone Levers	579
VERBRUGGE Bone Holding Forceps	628
VERESS Pneumoperitoneum Needles	329
VERNET-GIL (MARBERGER) Vein and Hilar Retractors	223
Vertebral Biopsy Instruments	720-721
Vertebral Column Retractors	288
Vessel Clips	154-156
Vessel Hooks	213-215
Vessel Knives	694-695
VICKERS Deep Hand and Forearm Retractor	271
VICKERS Finger Retractors	271
VICKERS Hand and Carpal Tunnel Retractor	271
VICKERS Handrestrainer	644
VICKERS Wire Drill Dispenser	657
VIDAL-UNNA Comedo Extractor	19
VIDAL Lupus Scraper	19
VIRCHOW Brain Knives	40
VIRTUS (RALKS) Splinter Forceps	151
WISE Micro Suture Tying Forceps	122
VOGEL Antrum Trocar Needles	319
VOLKMANN Bone Curettes	600, 602, 606
VOLKMANN Retractors	233-234
VOLKMANN Retractors and Bone Retractors	232
VON PETZ Stomach and Intestinal Suturing Apparatus	404

W

WAGENER Ear Hooklets	213
WAGNER Bone Lever	577
WAGNER Mallet	620
WAGNER Raspatories	591
WALB Post Mortem Knives	40
WALDMANN Perineum (Episiotomy) Scissors	107
WALTON-LISTON (BÖHLER) Bone Cutting Forceps	638
WANGENSTEEN Needle Holders	369
WANGENSTEEN TITE GRIP Dissecting Forceps	115
WANGENSTEEN TITE GRIP Needle Holder	347
Warm-Light Proximal Illumination for Amnioscopic Tubes	472
WARTENBERG Algesimeter	4
Wash Bowls	749
Water Jet Pistol with Several Tips	754-755
WATSON-CHEYNE Dissector	574
WATSON-WILLIAMS Rasp	593
WAUGH Delicate Dissecting Forceps	131
WAUGH Delicate Tissue Forceps	143
WEBER Aesthesiometer	4
WEBER ATRAUMATIC-GRIP Aorta-Anastomosis Clamps	548
WEBSTER Needle Holder	363
WEBSTER TITE GRIP Needle Holder	342
WEIL-BLAKESLEY Laminectomy Rongeurs	714
WEISSBARTH Vaginal Speculum	442
WEITLANER Self-Retaining Retractors	272-274
WELLS-SPENCER Haemostatic Forceps	173
WERTHEIM-CULLEN Kidney Pedicle Clamp	191
WERTHEIM-DE BAKEY (ROGERS) Parametrium Forceps	197
WERTHEIM (BOZEMANN) TITE GRIP Needle Holders	346
WERTHEIM Hysterectomy Forceps	194-195
WERTHEIM Uterine Scissors	105
WEST Chisels	607
WEST Gouges	607
WIENER MOD. Suture Catcher	378
WIENER Rasps	593
WILDE (TROELTSCH) Ear and Nasal Dressing Forceps	137
WILLETT Scalp Flap Forceps	481
WILLIAMS-WATSON Rasp	593
WILLIAMS (STIEGLITZ) Splinter Forceps	151
WILLIAMS Intestinal and Tissue Grasping Forceps	388
WILLIGER Bone Curettes	598, 600
WILLIGER Elevators	574

WILLIGER Mallet	617
WILLIGER Raspatories	582
WINTER Placenta and Ovum Forceps	482
WINTER Stethoscope	5
Wire Bending and Cutting Pliers	666
Wire Cutters, DURACUT	667
Wire Cutting Pliers	666
Wire Cutting Scissors	665
Wire Cutting Scissors, DURACUT	665
Wire Drill Dispenser	656-657
Wire Drills	655
Wire Guides	660-661
Wire Holding Forceps	663-664
Wire Holding Forceps, TITE GRIP	663
Wire Saws	687
Wire Tightener	660
Wire Traction Bows	654, 658-659
Wire Twisting Forceps, TITE GRIP	662
Wires, Bone	660
Wires, Silver	690
WITTNER Cervical Biopsy and Specimen Forceps	462
WOLFF Plaster Breakers	682
WOLFSON-DE MARTEL Clamp Closing Forceps	402
WOLFSON-DE MARTEL Clamp Holders	402
WOLFSON-DE MARTEL Colon-Anastomosis Clamps	402
WOOD-CRILE Needle Holders	366, 368
WOOD-CRILE TITE GRIP Needle Holders	343
WOOD-CRILE TITE GRIP Needle Holders for Left-Hander	341
Wound and Bladder Syringes	331
WRIGLEY Forceps	480
Writing and Marking Pencils and Marking Apparatus	757
WULLSTEIN Micro Suction Tube	321
WULLSTEIN Self-Retaining Retractors	275
WULLSTEIN Suction Cannula	322
WYLIE ATRAUMATIC-GRIP Aorta-Anastomosis Clamps	549

Y

YANKAUER Suction Tubes	325-326
YASARGIL-MINI Applying Forceps for Vessel Clips	154
YASARGIL-MINI Vessel Clips	154
YASARGIL-SAMIII Tumor and Tissue Grasping Forceps	126
YASARGIL-STANDARD Applying Forceps for Vessel Clips	154
YASARGIL-STANDARD Vessel Clips	154
YASARGIL-VANNAS Micro Scissors	66
YASARGIL Dissector	694
YASARGIL Ligature Guides	697
YASARGIL Micro Dissecting Scissors	67
YASARGIL Micro Forceps	125
YASARGIL Micro Scissors	66
YASARGIL PERFECT GRIP Micro Needle Holders	362
YASARGIL Pituitary Rongeur	719
YASARGIL Raspatories	694-695
YASARGIL Scoop	695
YASARGIL Spring Hooks for Galea Fixation	691
YASARGIL Suction Tubes	324
YASARGIL Tumor and Tissue Grasping Forceps	126
YASARGIL Vessel Knives	695
YEOMAN Rectal Biopsy Specimen Forceps	412
YOUNG-HRYNTSCHAK Boomerang Needle Holder	372
YOUNG-MILLIN Boomerang Needle Holder	372
YOUNG Bulbus Hooks	422
YOUNG Tongue Holding Forceps	23
YOUNGE-KEVOURKIAN Cervical Biopsy and Specimen Forceps	463, 465
YOUNGE-KEVOURKIAN Endocervical Biopsy Curettes	459

Z

ZAUFAL-JANSEN Bone Rongeur	633
ZENKER Dissecting and Ligature Forceps	188
ZENKER Retractors for Deep Surgery	259
ZIEGLER Head Band	10
ZIEGLER Head Mirrors	10
ZIELKE Gouges for Scoliosis Operations	614
ZOELLNER Micro Suction Tube	321
ZWEIFEL TITE GRIP Needle Holder	349

A

ABRAMS Aguja 518
ABRAMS Aguja para la punción de la pleura 329
 Abre-bocas 22
ADAIR Pinza para coger el cuello del útero 452
ADAIR-ALLIS Pinza intestinal y para tejidos 384
ADAMS-MAYO Separadores para apendectomía 284
 Adaptador de tubo para curetas de aspiración 471
ADLERKREUTZ Pinzas para vasos y tumores 148
ADSON Cánulas para aspiración 323
ADSON Ganchos para nervios y vasos 215
ADSON Periostótomos 586
ADSON Pinza-guía para taladros 650
ADSON Pinzas de disección TITE GRIP 113
ADSON Pinzas finas de disección 129
ADSON Pinzas finas quirúrgicas 140-141
ADSON Pinzas hemostáticas finas 169
ADSON Pinzas quirúrgicas TITE GRIP 117
ADSON Porta-agujas 367
ADSON Separadores con retenida automática 273, 278
ADSON Separadores para hemi-laminectomía 277
ADSON Separadores para laminectomía 276, 280
ADSON Taladro espiral 652
ADSON-ANDERSON Separador con retenida automática 276
ADSON-BABY Pinzas de disección y ligaduras 180
ADSON-BECKMANN Separadores para laminectomía 279
ADSON-BROWN Pinza quirúrgica TITE GRIP 117
ADSON-BROWN Pinzas finas quirúrgicas 141
ADSON-MICRO Pinzas finas de disección 129
ADSON-MICRO Pinzas finas quirúrgicas 140-141
ADSON-MICRO Pinzas quirúrgicas TITE GRIP 117
ADSON-TOENNIS Tijeras de disección 89
ADSON-TOENNIS Tijeras DURACUT de disección 49
 Agrafes (Grapas) 379
 Agrafes para suturar de plata alemana 404
 Agujas de biopsia 518
 Agujas de guía 334, 486
 Agujas de repuesto 372
 Agujas de **REVERDIN** 373
 Agujas especiales 328
 Agujas hipodérmica 486
 Agujas **KIRSCHNER** 655
 Agujas para amígdalas 328
 Agujas para biopsia 329
 Agujas para el neumoperitoneo 329
 Agujas para el tabique nasal 328
 Agujas para la punción de la pleura 329
 Agujas para la punción del esternón 329
 Agujas para la punción del hígado 329
 Agujas para ligaduras 374-376
 Agujas para punción lumbar 328
 Agujas para suturas intestinales 354
 Agujas para suturas oculares 354
 Agujas pasa-hilos 660-661
 Agujas quirúrgicas para sutura 354-356
 Agujas vasculares 354
ALAN-PARK Separador para el recto 408
ALDERDYCE Disecador 574
ALDINGER-HOHMANN Elevador para huesos 580
ALEXANDER Cinceles 609
ALEXANDER Gubias 609
ALEXANDER Osteótomos 609
ALEXANDER Pinza saca-bocados para biopsia 463
ALEXANDER-FARABEU Periostótomos costales 497
 Algesímetros 4
 Alicates corta y cierra-alambres 666-668
 Alicates corta-alambres 666-668
 Alicates corta-alambres DURACUT 667
 Alicates de corte frontal y lateral 668
ALLEN Pinzas-clamps intestinales 390
ALLIS ATRAUMATIC-GRIP Pinzas intestinales y para tejidos 389
ALLIS Pinzas intestinales y para tejidos 383-385
ALLIS-ADAIR Pinza intestinal y para tejidos 384
ALLIS-BABY Pinzas intestinales y para tejidos 383
ALLIS-BOYS Pinza intestinal y para tejidos 384
ALLIS-JUDD Pinzas intestinales y para tejidos 384
ALLIS-OCHSNER Pinza intestinal y para tejidos 383

ALLISON Espátula para el pulmón 260
ALLIS-THOMS Pinza intestinal y para tejidos 385
ALM Separadores con retenida automática 270
ALY Algesímetro 4
AMANN Conductor de tapones 447
 Amniótomo 477
 Amputación 570
ANDERSON-ADSON Separador con retenida automática 276
ANDREW-PYNCHON Tubos para aspiración 325
 Anillos de goma para ligadura 410
 Anoscopios 407
 Aparato para marcar y escribir sobre metal 757
 Aparato para suturar estomacal e intestinal 404
 Aproximadores 157-159
 Aproximadores para costillas 508
ARMYTAGE-GREEN Pinza-clamp uterina para hemostasis 481
ARTHUR Pinza para espinas 151
 Artículos para enfermería 751
 Aspiradores micro 321
ATRAUMATIC GRIP Pinzas vasculares 135
ATRAUMATIC-GRIP Clamps Bulldog 525-528, 556
ATRAUMATIC-GRIP Pinza-clamp oclusiva superior 398
ATRAUMATIC-GRIP Pinza-clamp para arteria renal 537
ATRAUMATIC-GRIP Pinza-clamp para vasos periféricos 558
ATRAUMATIC-GRIP Pinzas de disección y ligaduras 186
ATRAUMATIC-GRIP Pinzas hemostáticas 176
ATRAUMATIC-GRIP Pinzas hemostáticas finas 165, 167
ATRAUMATIC-GRIP Pinzas intestinales y para tejidos 389
ATRAUMATIC-GRIP Pinzas para anastomosis del recto 400-401
ATRAUMATIC-GRIP Pinzas para disección y ligaduras 551
ATRAUMATIC-GRIP Pinzas patente de conducto 531, 556
ATRAUMATIC-GRIP Pinzas-clamps bronquiales 552
ATRAUMATIC-GRIP Pinzas-clamps de varias aplicaciones 520-523, 530, 553-556
ATRAUMATIC-GRIP Pinzas-clamps estomacales 397
ATRAUMATIC-GRIP Pinzas-clamps intestinales 391, 395-396
ATRAUMATIC-GRIP Pinzas-clamps oclusiva inferior 399
ATRAUMATIC-GRIP Pinzas-clamps para anastomosis 520-523, 542-544, 548-549, 559-560
ATRAUMATIC-GRIP Pinzas-clamps para anastomosis de aorta 548-549
ATRAUMATIC-GRIP Pinzas-clamps para aneurisma de aorta 545-547, 561
ATRAUMATIC-GRIP Pinzas-clamps para aorta 537-540, 561
ATRAUMATIC-GRIP Pinzas-clamps para arterias renales 558
ATRAUMATIC-GRIP Pinzas-clamps para carótida 524, 537
ATRAUMATIC-GRIP Pinzas-clamps para coarctación 532-533, 557
ATRAUMATIC-GRIP Pinzas-clamps para histerectomía 197
ATRAUMATIC-GRIP Pinzas-clamps para iliaca 558
ATRAUMATIC-GRIP Pinzas-clamps para la profunda 534
ATRAUMATIC-GRIP Pinzas-clamps para oclusión tangencial 541, 562
ATRAUMATIC-GRIP Pinzas-clamps para renal 190
ATRAUMATIC-GRIP Pinzas-clamps para vasos periféricos 534-536
ATRAUMATIC-GRIP Pinzas-clamps para vena cava 550
ATRAUMATIC-GRIP Pinzas-clamps vasculares 520-523, 530, 534, 537, 555-556, 558, 561-562
AUFRIEHT Escofina 593
AUFRIEHT Tijeras para la cirugía plástica 82
AUSTIN Micro-pinzas de ligadura 122
AUVARD Espéculos vaginales 441
AUVARD-BERLIND Espéculo vaginal 441

B

BABCOCK ATRAUMATIC-GRIP Pinzas intestinales y para tejidos 389
BABCOCK Pinzas intestinales y para tejidos 385
BABCOCK TITE GRIP Pinzas intestinales y para tejidos 388
BABY-ADSON Pinzas de disección y ligaduras 180
BABY-ALLIS Pinzas intestinales y para tejidos 383
BABY-BAILEY Aproximador para costillas 508
BABY-BALFOUR Separador abdominal 300
BABY-COLLIN Separadores abdominales 297
BABY-CRIE Pinzas hemostáticas finas 166
BABY-DOYEN ATRAUMATIC-GRIP Pinzas-clamps intestinales 391
BABY-DOYEN Pinzas-clamps intestinales 391
BABY-FINOCCHIETTO Separador costal 503
BABY-GELPI Separador para la vulva 281
BABY-GILLIES Porta-agujas con tijera 370
BABY-GILLIES TITE GRIP Porta-agujas 348
BABY-GOSSET Separador abdominal 299

BABY-HAIGHT-FINOCHIETTO Separador costal	501
BABY-KELLY Pinzas hemostáticas finas	168
BABY-KOCHER ATRAUMATIC-GRIP Pinzas-clamps intestinales	391
BABY-KOCHER Pinzas-clamps intestinales	391
BABY-LEXER Tijeras de disección	87
BABY-MEEKER Pinzas de disección y ligaduras	180
BABY-METZENBAUM Tijeras de disección	89
BABY-MIKULICZ Pinza-clamp para peritoneo	192
BABY-MIXTER Pinzas de disección y ligaduras	180
BABY-MOSQUITO Pinzas hemostáticas finas	164
BABY-OLSEN-HEGAR TITE GRIP Porta-agujas	348
BABY-OVERHOLT Pinza de disección y ligaduras	183
BABY-PAYR Pinzas-clamps intestinales y estomacales	403
BABY-ROUX Separadores	228
BABY-SATINSKY Pinza-clamp para anastomosis (vena cava)	565
BABY-TISCHLER Pinza saca-bocados para biopsia	464
BACKHAUS Pinzas de campo	201
BADGLEY Separador para laminectomía	286
BAHNSON-DE BAKEY ATRAUMATIC-GRIP Pinzas-clamps para aneurisma de aorta	545
BAILEY (DE MARTEL) Conductor para sierras de hilo	687
BAILEY Aproximador para costillas	508
BAILEY ATRAUMATIC-GRIP Pinzas-clamps para aorta	538
BAILEY-BABY Aproximador para costillas	508
BAILEY-GIBBON Aproximador para costillas	508
BAINBRIDGE Pinzas-clamps intestinales	390
BAINBRIDGE-DE BAKEY ATRAUMATIC-GRIP Pinzas-clamps vasculares	530
BAKES Dilatadores para el conducto biliar	416
BALFOUR modif. Separadores abdominales	302
BALFOUR Separadores abdominales	300-301, 303
BALFOUR-BABY Separador abdominal	300
BALFOUR-KIRSCHNER Valvas para separadores abdominales	307
BALLENGER-FOERSTER Pinzas para torundas y esponjas	209
BALLENTINE Pinza-clamp para histerectomía	196
BALLENTINE-HEANEY Pinza-clamp para histerectomía	196
Bandeja rectangular	748
Bandejas	748
Bandejas de esterilización	744
Bandejas para instrumentos	748
Bandejas universales	748
BARNES Cánula para aspiración	321
BARR Separador para el recto	408
Barra de tracción para pinzas porta-huesos	630
BARRAQUER Micro-Porta-agujas	360
BARRAQUER Pinza depilatoria	152
BARRAQUER-TROUTMAN Micro-Porta-agujas	360
BARRAYA-STILLE Pinzas para vasos y tumores	148
BARRETT Pinza para coger el cuello del útero	452
BARTH Cucharilla cortante	599
Bastidores para la fijación a las barras laterales	309
BAUMGARTNER Porta-agujas	366
BAUMGARTNER TITE GRIP Porta-agujas	342
BAUMGARTNER-HEGAR TITE GRIP Porta-agujas	342
BEACHAM Amniótomo	477
BECK-COOLEY ATRAUMATIC-GRIP Pinzas-clamps para anastomosis	560
BECK-DE BAKEY ATRAUMATIC-GRIP Pinza-clamp para aorta	537
BECK-DE BAKEY ATRAUMATIC-GRIP Pinzas-clamps para anastomosis	543
BECK-DE BAKEY ATRAUMATIC-GRIP Pinzas-clamps para vena cava	550
BECKMAN Separador para laminectomía	280
BECKMANN-ADSON Separadores para laminectomía	279
BECKMANN-EATON Separador para laminectomía	280
BEEBEE Cizallas corta-alambres	665
BEER Pinza depilatoria	152
BELMONT-RUMEL Torniquetes	518
BENGOLEA Pinzas hemostáticas finas	172
BENNETT Elevadores para huesos	581
BENSON Separador para píloro	403
BERGER Lupas frontales binoculares	8
BERGER Pinza saca-bocados para biopsia	462
BERGMANN Tijera para tela, cizalla para escayolas	675
BERLIND-AUVARD Espéculo vaginal	441
BERLINER Martillos de percusión	2
BERMANN Martillos	621
BERNHARD Pinza de campo	201
BETHUNE Costótomo	493
BEYER Pinza cortante para laminectomía	707
BEYER Pinzas-gubias	632-633

BIEMER Clips vasculares	156
BIEMER Tijeras para venas	63
BIEMER-MÜLLER Aproximadores	157
BIER Sierra para amputación y resección	573
BILL Tractor	479
BIRCHER Bisturíes para menisco	643
BIRCHER-GANSKE Pinzas para menisco y cartilago	640
Bisturíes para menisco	642-643
Bisturíes para rinoplastia	37
BLAKE Cureta uterina	466
BLAKE Pinzas para los cálculos biliares	418
BLAKE-MAYO Pinzas para los cálculos biliares	418
BLAKESLEY-WEIL Pinzas cortantes para laminectomía	714
BLESSING Tijera DURACUT para la cirugía del recto	59
BLOUNT Elevadores para caderas	580
BLOUNT Separadores para rodilla	641
BLUMENTHAL Pinza-gubia	631
BLUNT Imperdible para instrumentos	736
BOETTCHER Tijera para amígdalas	103
BÖHLER (LISTON-WALTON) Pinzas cortantes para huesos	638
BÖHLER Estribos para extensión	654
BÖHLER Pinzas-gubias	633
Bombilla de repuesto	472
BONNEY Pinza de disección	134
BONNEY Pinza de disección TITE GRIP	115
BONNEY Pinzas quirúrgicas	147
BONNEY Pinzas quirúrgicas TITE GRIP	118
BOSE Separadores para la tráquea	728
BOYS-ALLIS Pinza intestinal y para tejidos	384
BOZEMANN (WERTHEIM) TITE GRIP Porta-agujas	346
BOZEMANN Pinzas para tapones	208
BOZEMANN-DOUGLAS Pinza para tapones	208
BRAND Pinzas-conductoras de tendón	648
BRAUN Craneoclasto	485
BRAUN Depresor uterino	447
BRAUN Gancho para decapitación	485
BRAUN Pinza para coger el cuello del útero	452, 454
BRAUN-SIMPSON Fórceps	478
BRAUN-STADLER Tijera para perineo (episiotomía)	107
BRAWLEY Escofina	593
BREISKY Espéculos vaginales	438, 440
BRIDGE Pinza de disección y ligaduras	187
BRINKERHOFF Espéculo para el recto	406
BROPHY (SULLIVAN) Tijeras finas de disección	93
BROPHY Pinzas finas de disección	131
BROPHY Pinzas finas quirúrgicas	143
BROWN Pinzas agarre de tejidos	148
BROWN Porta-agujas	366
BROWN-ADSON Pinza quirúrgica TITE GRIP	117
BROWN-ADSON Pinzas finas quirúrgicas	141
BROWNE-DENIS Separador abdominal	305
BRUENINGS Depresor lingual	12
BRUNNER Pinza para anastomosis del recto	400
BRUNNER Separadores para cirugía profunda	252-253
BRUNS Cizallas para escayolas	676
BRUNS Cucharillas cortantes	602-603
BRUNS DURACUT Cizalla para escayolas	676
BUCHWALD Depresor lingual	12
BUCK Martillos de percusión	3
BUCK-GRAMCKO Elevador para huesos	576
BUELAU Trocar para punción torácica	318
BUIE Pinza-clamp de presión progresiva	409
BUIE-SMITH Separador para el recto	408
Bujías dilatadoras	424
Bulldog clamps TITAN-LINE	160-161
Bulldog Micro-Clamps	162
BUMM Curetas para aborto y placenta	484
BUMM Curetas uterinas	470
BUNNELL Conductor de tendones	646
BUNNELL Mondador de tendones	646
BUNNELL Perforador de mano	653
BURFORD-FINOCHIETTO Separadores costales	502-503
BURKE Pinza saca-bocados para biopsia	464
BUSH Tijeras umbilicales	108

C

Cajas de esterilización	738-743
-------------------------	---------

Cajas para conservación	738	CLOWARD Separadores para la columna cervical	285
Cajas para instrumentos	746	COAKLEY Cánula para punción del seno maxilar	319
Calibrador	7	COBB Gubias espinales	616
CALNE ATRAUMATIC-GRIP Pinza-clamp para vena cava	550	COBB Periostótomos	589, 591
CANAD. MOD. Bisturíes para menisco	643	COLCLOUGH (LOVE-KERRISON) Pinzas cortantes para laminectomía	710-711
CANNON Cuchillo para la íntima	513	COLLER-CRILE Pinzas hemostáticas finas	167
CANNON Espátula para la íntima	513	COLLIER Porta-agujas	363
CANNON Juego para endarterectomía	515	COLLIN ATRAUMATIC-GRIP Pinzas intestinales y para tejidos	389
CANNON Sondas para endarterectomía	514	COLLIN Clamp umbilical	486
Cánulas para aspiración	320-323	COLLIN Dinamómetro	6
Cánulas para irrigación	322	COLLIN Espéculos vaginales	431
Cánulas para irrigación del seno maxilar	322	COLLIN Martillo	617
Cánulas para punción del seno maxilar	319-320	COLLIN Pinza intestinal y para tejidos	386
Cánulas traqueales	725-727	COLLIN Pinza para el útero	458
Cánulas vasculares para irrigación	322	COLLIN Pinza para quitar agrafes	379
CAPLAN Tijera DURACUT para el tabique nasal	59	COLLIN Pinza para vendajes y torundas	207
CARMALT-ROCHESTER Pinzas hemostáticas	178	COLLIN Pinza tira-lengua	23
CAROTIS-DE BAKEY ATRAUMATIC-GRIP Clamp Bulldog	525	COLLIN Separadores	227
CARROLL Pinza-conductora de tendón	648	COLLIN Separadores abdominales	297-298
CARROLL Porta-agujas	366	COLLIN-BABY Separadores abdominales	297
CARROLL TITE GRIP Porta-agujas	344	COLLIN-DUVAL Pinza intestinal	149
CASPAR Espéculos para la cirugía lumbar vertebral	295	COLLIN-DUVAL Pinzas intestinales y para tejidos	386
CASPAR Ganchos para exploración y coagulación	215	COLLIN-FARABEUF Periostótomos	588
CASPAR Periostótomos	585	COLLIN-HARTMANN Separador	229
CASPAR Pinzas cortantes para laminectomía	718-719	COLLIN-LANDAU Espéculos vaginales	431
CASPAR Separador	245	Combinación tapa/pinza	735
CASPAR Separador para la cirugía lumbar vertebral	294	Compases	7
CASPAR Separador para la columna cervical	290-292	Compresores uretrales	426
CASPAR Separador para la columna vertebral	288	Conductor de tapones	447
CASTANEDA ATRAUMATIC-GRIP Pinzas-clamps de varias aplicaciones	520	Conductor de tendones	646
CASTANEDA ATRAUMATIC-GRIP Pinzas-clamps para anastomosis	520	Conductor para sierras de hilo	687
CASTANEDA Separadores costales	500	CONE Pinza saca-bocado craneal	688
CASTROVIEJO Compás	7	CONTOUR SCALP Separadores con retenida automática	276
CASTROVIEJO Pinza para sujetar y romper hojas de afeitar	36	CONVERSE (GILLIES) Ganchos para piel y dura-madre	216
CASTROVIEJO Pinzas finas quirúrgicas	138	CONVERSE TITE GRIP Porta-agujas	342
CASTROVIEJO Porta-agujas	363	COOLEY ATRAUMATIC-GRIP Clamps Bulldog	556
CASTROVIEJO TITE GRIP Micro-Porta-agujas	338-339	COOLEY ATRAUMATIC-GRIP Pinzas patente de conducto	556
CASTROVIEJO-MICRO Micro-Porta-agujas	358	COOLEY ATRAUMATIC-GRIP Pinzas-clamps de varias aplicaciones	562
Catéter de eustaquio	322	COOLEY ATRAUMATIC-GRIP Pinzas-clamps para anastomosis	560
Catgut	353	COOLEY ATRAUMATIC-GRIP Pinzas-clamps para aneurisma de aorta	561
CATLIN Cuchillo para amputación	38	COOLEY ATRAUMATIC-GRIP Pinzas-clamps para aorta	561
Cepillo de uñas	752	COOLEY ATRAUMATIC-GRIP Pinzas-clamps para arterias renales	558
Cepillos de limpieza	756	COOLEY ATRAUMATIC-GRIP Pinzas-clamps para coarctación	557
Cestas de esterilización	744-745	COOLEY ATRAUMATIC-GRIP Pinzas-clamps para iliaca	558
Cestas para cepillos	753	COOLEY ATRAUMATIC-GRIP Pinzas-clamps para la pediatría	555
Cestas para toallas	753	COOLEY ATRAUMATIC-GRIP Pinzas-clamps para oclusión tangencial	562
CHAMPY Trépanos	669	COOLEY ATRAUMATIC-GRIP Pinzas-clamps para varias aplicaciones	556
CHAPUT Pinza intestinal y para tejidos	383	COOLEY ATRAUMATIC-GRIP Pinzas-clamps para vasos periféricos	558
CHARRIÈRE Sierras para amputación y resección	572-573	COOLEY Dilatadores de aorta	511
CHEATTLE Pinzas para esterilización	734	COOLEY Dilatadores vasculares	510
CHERON Pinza para vendajes y torundas	207	COOLEY Separadores atrium	509
CHEVALIER Separador costal	507	COOLEY Separadores para esternotomía	498-499
CHEVALIER-JACKSON Cánula traqueal	726	COOLEY Tubo para aspiración	327
CHEYNE-WATSON Disecador	574	COOLEY Tubo para aspiración intracardiaco	327
CHILDE Pinzas aproximadoras sin porta-clips	378	COOLEY Tubo para aspiración vascular	327
Cilindros	330-331	COOLEY-BECK ATRAUMATIC-GRIP Pinzas-clamps para anastomosis	560
Cinceles	607, 609-611, 613-614	COOLEY-DERRA ATRAUMATIC-GRIP Pinzas-clamps para anastomosis	559
Cinceles para esternón	492	COOLEY-REYNOLDS ATRAUMATIC-GRIP Pinzas-clamps para anastomosis	559
Cinceles, hojas intercambiables	611	COOPER Agujas para ligaduras	374
Cintas	10	Copas graduadas	751
Cintas métricas	6	CORWIN-HEGAR TITE-GRIP Pinza cierra-hilos	662
CITELLI Pinza cortante para laminectomía	707	CORYLLOS Separadores y espátulas para el pulmón	261
Cizallas corta-alambres	665	Costótomos	492-493
Cizallas corta-alambres DURACUT	665	COTTLE Escofina	593
Cizallas para escayolas	675-678	COTTLE Gancho para la cirugía plástica	218
Cizallas para escayolas DURACUT	676	COTTLE Gancho para piel y dura-madre	217
Clamps Bulldog	160-163	COTTLE Martillo	620
Clamps Bulldog ATRAUMATIC-GRIP	525-528, 556	COTTLE Osteótomos	608
Clamps Bulldog TITAN-LINE	160-161	COTTLE Periostótomo	583, 585
Clamps para anastomosis del colon	402	COTTLE Tijera nasal	102
Clamps umbilicales	486	COTTLE Tijeras DURACUT nasales	58
Clamps-Micro Bulldog	162	COTTLE-NEIVERT Gancho para las coanas	221
CLAR Lámpara frontale para corriente de baja tensión	11	CRAFOORD (STELZNER) Tijera para lobectomía y recto	99
Clavija cónica	447	CRAFOORD Pinza hemostática fina	171
Clavos	654	CRAFOORD Pinzas para la aurícula atril	564
CLEVELAND Pinzas cortantes para huesos	637		
Clips vasculares	154-156		
CLOWARD Separadores para cuerpos vertebrales	296		

CRAFOORD-DE BAKEY ATRAUMATIC-GRIP Pinzas-clamps para aneurisma de aorta 546

CRAFOORD-STILLE Pinzas hemostáticas finas 170

CRAIG-KOGLER Juego para la biopsia vertebral 720-721

Craneoclasto 485

CRILE Ganchos para nervios y vasos 214

CRILE Pinzas hemostáticas finas TITAN-LINE 166

CRILE Porta-agujas 371

CRILE Separadores 227

CRILE-BABY Pinzas hemostáticas finas 166

CRILE-COLLER Pinzas hemostáticas finas 167

CRILE-MICRO Pinzas hemostáticas finas 166

CRILE-MURRAY Porta-agujas 366

CRILE-RANKIN (OCHSNER-DIXON) Pinzas hemostáticas finas 167

CRILE-RANKIN-DE BAKEY ATRAUMATIC-GRIP Pinzas hemostáticas finas 167

CRILE-WOOD Porta-agujas 366, 368

CRILE-WOOD TITE GRIP Porta-agujas 343

CRILE-WOOD TITE GRIP Porta-agujas para zurdos 341

CRUTCHFIELD Perforadores iniciales 689

CRUTCHFIELD Pinzas de tracción craneal 689

Cubetas 750

Cubetas para soluciones 749

Cubetas triangulares 750

Cuchara graduada 751

Cucharillas cortantes 598-606, 695-696

Cucharillas para aborto 484

Cucharillas para la vesícula biliar 417

Cucharillas para los cálculos biliares 417

Cucharillas para placenta 484

Cucharillas para secreción 425

Cucharillas uterinas 466

Cuchillos interóseos 39

Cuchillos para amputación 38-39

Cuchillos para autopsia 40

Cuchillos para cerebro 40

Cuchillos para dura-madre 37

Cuchillos para escayolas 679

Cuchillos para falanges 39

Cuchillos para la íntima 513

Cuchillos para lóbulos 39

Cuchillos para periostio 39

Cuchillos para resección 38-39

Cuchillos para vasos 694-695

Cuchillos post mortem 40

CULLEN-WERTHEIM Pinza-clamp para pedículo renal 191

Cuñas 750

Curetas 692

Curetas aspiradora para biopsia endo-uterina 459

Curetas de aspiración 471

Curetas de biopsia de aspiración 471

Curetas para aborto 484

Curetas para biopsia 459-460

Curetas para biopsia endo-cerviz 459

Curetas para biopsia endo-uterina 459

Curetas para lupus 20

Curetas para placenta 484

Curetas uterinas 466-470

CURTIS Pinza quirúrgica 147

CUSCO Espéculos vaginales 431

CUSCO Espéculos vaginales para vírgenes 430

CUSHING Espátula cerebral 706

CUSHING Gancho para decompresión 701

CUSHING Gancho para dura-madre 218

CUSHING Ganchos para nervios y vasos 214

CUSHING Pinzas cortantes para laminectomía 715

CUSHING Pinzas de disección TITE GRIP 114

CUSHING Pinzas finas de disección 130

CUSHING Pinzas finas quirúrgicas 142

CUSHING Separadores para venas 222-223

CUSHING Taladro 652

CUSHING-FERRIS-SMITH Pinzas cortantes para laminectomía 713

CUSHING-LANDOLT Espéculos para la hipofisectomía 692

CUSHING-TAYLOR Pinza de disección TITE GRIP 114

CUSHING-TAYLOR Pinza fina de disección 131

CUSHING-TAYLOR Pinza fina quirúrgica 143

CUSHING-TAYLOR Pinzas auriculares y nasales 136

CUZZI Cucharilla para aborto y placenta 484

CZERNY Espéculo para el recto 405

CZERNY Pinza para coger el cuello útero 455

D

DAHLGREN Pinza saca-bocado craneal 688

DALE ATRAUMATIC-GRIP Pinzas-clamps para vasos periféricos 535

DANDY Ganchos para nervios y vasos 214

DANDY Pinzas hemostáticas finas 165

DARDIK ATRAUMATIC-GRIP Pinzas-clamps de varias aplicaciones 554

DARTIGUES Pinza para sostener el riñón 421

DAUBENSPECK Cucharilla cortante 604

DAVIDSON Separadores para scápula 260

DAVIS Espátula cerebral 706

DAVIS-RAGNELL Gancho para cirugía plástica 226

DAY Ganchitos auriculares 213

DE BAKEY (GARRETT) Dilatadores vasculares 510

DE BAKEY ATRAUMATIC-GRIP Clamps Bulldog 526, 528

DE BAKEY ATRAUMATIC-GRIP Pinzas para disección y ligaduras 551

DE BAKEY ATRAUMATIC-GRIP Pinzas patente de conducto 531

DE BAKEY ATRAUMATIC-GRIP Pinzas-clamps de varias aplicaciones 530, 553

DE BAKEY ATRAUMATIC-GRIP Pinzas-clamps para anastomosis 543

DE BAKEY ATRAUMATIC-GRIP Pinzas-clamps para aneurisma de aorta 545, 547

DE BAKEY ATRAUMATIC-GRIP Pinzas-clamps para aorta 539

DE BAKEY ATRAUMATIC-GRIP Pinzas-clamps para arteria renal 537

DE BAKEY ATRAUMATIC-GRIP Pinzas-clamps para coarctación 532-533

DE BAKEY ATRAUMATIC-GRIP Pinzas-clamps para oclusión tangencial 541

DE BAKEY ATRAUMATIC-GRIP Pinzas-clamps para vasos periféricos 535-536

DE BAKEY ATRAUMATIC-GRIP Pinzas-clamps vasculares 529

DE BAKEY ATRAUMATIC GRIP Pinzas vasculares 135

DE BAKEY Pinzas para tejidos y tirar uñas TITE GRIP 116

DE BAKEY Separadores costales 504-505

DE BAKEY Tijera para arteriotomía 95

DE BAKEY Tijeras DURACUT vasculares 57

DE BAKEY Tijeras vasculares 96

DE BAKEY TITE GRIP Porta-agujas 343

DE BAKEY Tubos para aspiración 325

DE BAKEY-BAHNSON ATRAUMATIC-GRIP Pinzas-clamps para aneurisma de aorta 545

DE BAKEY-BAINBRIDGE ATRAUMATIC-GRIP Pinzas-clamps vasculares 530

DE BAKEY-BECK ATRAUMATIC-GRIP Pinza-clamp para aorta 537

DE BAKEY-BECK ATRAUMATIC-GRIP Pinzas-clamps para anastomosis 543

DE BAKEY-BECK ATRAUMATIC-GRIP Pinzas-clamps para vena cava 550

DE BAKEY-CAROTIS ATRAUMATIC-GRIP Clamp Bulldog 525

DE BAKEY-CRAFOORD ATRAUMATIC-GRIP Pinzas-clamps para aneurisma de aorta 546

DE BAKEY-CRILE-RANKIN ATRAUMATIC-GRIP Pinzas hemostáticas finas 167

DE BAKEY-DERRA ATRAUMATIC-GRIP Pinzas-clamps para anastomosis 542

DE BAKEY-DIETRICH ATRAUMATIC-GRIP Clamps Bulldog 526

DE BAKEY-GLOVER ATRAUMATIC-GRIP Clamps Bulldog 525

DE BAKEY-GUYON ATRAUMATIC-GRIP Pinzas-clamps para renal 190

DE BAKEY-HARKEN ATRAUMATIC-GRIP Pinzas para disección y ligaduras 551

DE BAKEY-HEANEY (ROGERS) ATRAUMATIC-GRIP Pinzas-clamps para histerectomía 197

DE BAKEY-MORRIS ATRAUMATIC-GRIP Pinzas-clamps para aorta 540

DE BAKEY-MOSQUITO-HALSTED ATRAUMATIC-GRIP Pinzas hemostáticas finas 165

DE BAKEY-PEAN ATRAUMATIC-GRIP Pinzas-clamps vasculares 529

DE BAKEY-PEAN ATRAUMATIC-GRIP Pinzas hemostáticas 176

DE BAKEY-POTTS ATRAUMATIC-GRIP Pinzas patente de conducto 531

DE BAKEY-REYNOLDS ATRAUMATIC-GRIP Pinzas-clamps para anastomosis 542

DE BAKEY-RUMEL ATRAUMATIC-GRIP Pinzas de disección y ligaduras 186

DE BAKEY-SATINSKY ATRAUMATIC-GRIP Clamps Bulldog 525

DE BAKEY-SATINSKY ATRAUMATIC-GRIP Pinzas-clamps para oclusión tangencial 541

DE BAKEY-WERTHEIM (ROGERS) ATRAUMATIC-GRIP Pinzas-clamps parametrium 197

DE MARTEL (BAILEY) Conductor para sierras de hilo 687

DE MARTEL-WOLFSON Clamps para anastomosis del colón 402
DE MARTEL-WOLFSON Pinza para cerrar los clamps 402
DE MARTEL-WOLFSON Porta-clamp 402
DE VILBISS Espéculo vaginal 433
DE VILBISS Pinza saca-bocado craneal 688
DEAN Tijera para amígdalas 103
DEAN Tijeras DURACUT para encías 55
DEAVER Separadores y espátulas para el pulmón 264-265
DEAVER Tijeras para cirugía 71
DEAVER-FORD Separador y espátula para el pulmón 263
DEJERINE Martillos de percusión 2
DEMEL Agujas pasa-hilos 660
DENHARDT Abre-boca 22
DENIS-BROWNE Separador abdominal 305
DENKER-UECKERMANN Trocares traqueales 728
 Deponette 738
 Depresores linguales 12
 Depresores uterinos 447
DERF Porta-agujas 363
DERF TITE GRIP Porta-agujas 342
 Dermátomos 41-42
 Dermátomos para hojas de afeitar corrientes 41
DERRA-COOLEY ATRAUMATIC-GRIP Pinzas-clamps para anastomosis 559
DERRA-DE BAKEY ATRAUMATIC-GRIP Pinzas-clamps para anastomosis 542
DESCHAMPS Agujas para ligaduras 374-376
DESJARDINS Pinzas para los cálculos biliares 419
DESJARDINS Sonda para el conducto biliar 415
DESMARRES Separadores para venas (separadores para párpados) 222
 Detergente para instrumentos 733
DEUCHER Separador abdominal 299
DEVIN ATRAUMATIC-GRIP Pinzas-clamps para carótida 524
 Diapasónes 4
DIFFENBACH Clamps Bulldog 163
DIETRICH ATRAUMATIC-GRIP Pinza-clamp para aorta 539
DIETRICH Micro-Clamps Bulldog 162
DIETRICH Tijera vascular 97
DIETRICH TITE GRIP Micro-Porta-agujas 339
DIETRICH-DE BAKEY ATRAUMATIC-GRIP Clamps Bulldog 526
DIETRICH-HEGEMANN Tijeras DURACUT vasculares 56
DIETRICH-HEGEMANN Tijeras vasculares 96
 Dilatador para el cuello vesical 423
 Dilatadores de aorta 511
 Dilatadores para el conducto biliar 416
 Dilatadores para la íntima 512
 Dilatadores para la tráquea 728
 Dilatadores uterinos 443-445
 Dilatadores vasculares 510
 Dinamómetros 6
DINGMANN modif. Pinzas para huesos 624
DINGMANN Pinzas para huesos 624
 Disecadores 574, 693-694, 696-697
 Disecadores para dura-madre 698-700
 Dispensadores de agujas 656-657
 Distribuidores de cepillos 752
DITTEL Guía para catéteres (introducción) 425
DIXON-LOVELACE Pinzas hemostáticas finas 169
DIXON-OCHSNER (CRILE-RANKIN) Pinzas hemostáticas finas 167
DOCKHORN Separadores 245
DOUGLAS Cánula para punción del seno maxilar 320
DOUGLAS Pinza depilatoria 152
DOUGLAS-BOZEMANN Pinza para tapónes 208
DOYEN ATRAUMATIC-GRIP Pinzas-clamps intestinales 392-393
DOYEN Martillos 618
DOYEN Periostótomos costales 495
DOYEN Pinza de campo 200
DOYEN Pinza para pólipos uterinos y ovarios 457
DOYEN Pinzas-clamps intestinales 392-393
DOYEN Separadores abdominales 248-249
DOYEN Sonda acanalada 314
DOYEN Tijeras abdominales 106
DOYEN Tirabuzón para mioma 458
DOYEN Valvas vaginales 439
DOYEN-BABY ATRAUMATIC-GRIP Pinzas-clamps intestinales 391
DOYEN-BABY Pinzas-clamps intestinales 391
DOYEN-STILLE Separadores 247
DUBOIS Tijeras para decapitación 109
DUPLAY Pinza para coger el cuello del útero 453

DURACUT Alicates corta-alambres 667
DURACUT Cizallas corta-alambres 665
DURACUT Cizallas para escayolas 676
DURACUT Tijeras 59
DURACUT Tijeras adnex 54
DURACUT Tijeras de disección 47-53
DURACUT Tijeras finas 45
DURACUT Tijeras nasales 58
DURACUT Tijeras para cirugía 46
DURACUT Tijeras para el tabique nasal 59
DURACUT Tijeras para encías 55
DURACUT Tijeras para ginecología 60
DURACUT Tijeras para iridectomía 45
DURACUT Tijeras para la cirugía plástica 45
DURACUT Tijeras para la cirugía del recto 59
DURACUT Tijeras para ligaduras 353
DURACUT Tijeras para perineo 60
DURACUT Tijeras para vasos y fístulas 45
DURACUT Tijeras para vendajes 673
DURACUT Tijeras parametrium 60
DURACUT Tijeras uterinas 60
DURACUT Tijeras vasculares 56-57
DURANTE Pinzas para vasos y tumores 149
DUVAL Pinza intestinal 149
DUVAL Pinzas intestinales y para tejidos 386-387
DUVAL TITE GRIP Pinza intestinal y para tejidos 388
DUVAL-COLLIN Pinza intestinal 149
DUVAL-COLLIN Pinzas intestinales y para tejidos 386

E

EASTMAN-RICHARDSON Separadores 250
EATON-BECKMANN Separador para laminectomía 280
ECHLIN Pinzas-gubias 634
EDER Porta-algodón 409
EICKEN-KILLIAN Cánulas para irrigación del seno maxilar 322
EISELBERG Tijera para ligadura 352
 Elevadores 574-575
 Elevadores para cabeza 481
 Elevadores para caderas 580
 Elevadores para huesos 576-581
 Elevadores para luxación 581
 Embudos 751
EMMET Gancho para fistulas 221
EMMET Pinza para vendajes y torundas 207
 Empujador de sutura 694
 Enchufe de conexión 320
 Endoespéculos 443
 Endoespéculos para cerviz y uretra 448
ENGEL Sierra para escayolas 679
ENGL. MOD. Pinza de campo 200
 Enucleadores 693
ERRICO Fresa 652
 Escariadores 650
 Escofinas 592-595
 Escofinas TITE GRIP 596-597
 Escupideras 751
 Esfinteroscopios 407
ESMARCH Cuchillo para escayolas 679
ESMARCH Tijeras para tela, cizallas para escayolas 675
ESMARCH Tubo-compresión 570
ESMARCH Venda-compresión 570
 Espátulas abdominales e intestinales 266-267
 Espátulas cerebrales 706
 Espátulas para el pulmón 260-265
 Espátulas para la íntima 512-513
 Espátulas para la vesícula 268
 Espátulas y dilatadores para la íntima 512
 Espéculo lateral 448
 Espéculos para el recto 405-406
 Espéculos para la cirugía lumbar vertebral 295
 Espéculos para la hipofisectomía 692
 Espéculos vaginales 430-442
 Espéculos vaginales para la cirugía con laser 433
 Espejos frontales 10
 Espejos laríngeos 13-14
 Estesiómetros 4
 Estetoscopios 5

Estiletos para el canal lacrimonal	312
Estribos para extensión	654, 658-659
Estuches para esterilizar agujas	357
Estuches para sutura	380
EUFRATE PASQUE TITE GRIP Porta-agujas	344
EWALD Pinza fina de disección	129
EWALD Pinza fina quirúrgica	140

F

FAHLBUSCH-HARDY Disecadores	693
FANSLER-IVES Anoscopios	407
FARABEUF Periostótomos	588
FARABEUF Separadores	227
FARABEUF-ALEXANDER Periostótomos costales	497
FARABEUF-COLLIN Periostótomos	588
FARABEUF-LAMBOTTE Pinza para huesos	626
FARRELL (LATHBURY) Porta-algodones	316
FAURE Pinza-clamp para peritoneo	193
FAVALORO Tijera para arteria coronar	95
FEHLAND ATRAUMATIC-GRIP Pinzas para anastomosis del recto	401
FEILCHENFELD Pinza para espinas	150
FEIN Porta-algodones	317
FERGUSON Agujas quirúrgicas para sutura	356
FERGUSON (FRAZIER) Cánulas para aspiración	323
FERGUSON Pinza para huesos	624
FERRIS-SMITH Pinzas quirúrgicas	147
FERRIS-SMITH-CUSHING Pinzas cortantes para laminectomía	713
FERRIS-SMITH-KERRISON Pinzas cortantes para laminectomía	709-710, 712
Finas pinzas de disección	128-131
Finas pinzas hemostáticas	164
Finas pinzas hemostáticas ATRAUMATIC-GRIP	165, 167
Finas pinzas hemostáticas TITAN-LINE	166, 168
Finas tijeras de disección	93
Finas tijeras de disección y tenotomía	92
Finas tijeras DURACUT	45
Finas tijeras para cirugía	68-70
FINOCHIETTO modif. Separadores costales	500
FINOCHIETTO Pinza de torácica y ligadura	564
FINOCHIETTO Porta-agujas	369
FINOCHIETTO Separadores costales	501, 503
FINOCHIETTO TITE GRIP Porta-agujas	346
FINOCHIETTO-BABY Separador costal	503
FINOCHIETTO-BABY-HAIGHT Separador costal	501
FINOCHIETTO-BURFORD Separadores costales	502-503
FINOCHIETTO-INFANT Separador costal	501
FINOCHIETTO-RIENHOFF Separador costal	506
FINSEN Separadores con retenida automática	270
FISCH Ganchito para dura-madre	212
FISCHER Mondador de tendones	646
FLETCHER (JAVERTS) Pinza para torundas y esponjas	210
FOERSTER Separador abdominal	308
FOERSTER Valvas para separadores	308
FOERSTER-(FORBES) Pinza para torundas y esponjas	210
FOERSTER-BALLENGER Pinzas para torundas y esponjas	209
FOMON Escofinas con filo de lima y filo de escofina	595
FOMON Gancho para las coanas	221
FOMON Tijera para ala nasal	81
FOMON Tijeras DURACUT nasales	58
FOMON Tijeras nasales	102
FOMON Tijeras para la cirugía plástica	82
FOMON TITE GRIP Escofinas	597
FORBES (FOERSTER) Pinza para torundas y esponjas	210
Fórceps	478-480
FORD-DEAVER Separador y espátula para el pulmón	263
FOSS Separador y espátula para el pulmón	263
FOX Curetas para lupus	20
FOX-GOLDMANN Tijeras DURACUT para encías	55
FOX-GOLDMANN Tijeras para encías	94
FRANZ Separador abdominal	304
FRAZIER (FERGUSON) Cánulas para aspiración	323
FRAZIER Cánulas para aspiración	323
FRAZIER Disecador para dura-madre	698
FRAZIER Gancho para piel y dura-madre	216-217
FREER Cinceles	607
FREER Periostótomos	583
FREER Separador	218

FRENCH EYE TITE GRIP Micro-Porta-agujas	340
FRENZEL Depresor lingual	12
Fresas	652
FREY-SAUERBRUCH Costótomo	493
FRIEDMAN-LUER Pinza-gubia	631
FRICTSCH Separadores	250
FROHN Porta-algodones	316
FRYKHOLM Pinzas-gubias	635

G

Gafas de lupa binocular	9
GALLAHER Escofina	592
Ganchitos auriculares	213
Ganchitos para dura-madre	212
Ganchos	449, 696
Ganchos con muelle para la fijación de la galea	691
Ganchos para cirugía plástica	271-218, 226
Ganchos para cripta (Sondas para fistula)	409
Ganchos para decapitación	485
Ganchos para decompresión	701
Ganchos para dura-madre	217-218
Ganchos para el bulbus	422
Ganchos para estrabismo	213
Ganchos para exploración y coagulación	215
Ganchos para fistulas	221
Ganchos para galea	691
Ganchos para iris	216-218
Ganchos para la microcirugía	212
Ganchos para las coanas	221
Ganchos para nervios y vasos	213-215
Ganchos para piel	216-218
Ganchos para piel y dura-madre	216-217
Ganchos para separadores	287, 289
GANSKE-BIRCHER Pinzas para menisco y cartilago	640
GARRETT (DE BAKEY) Dilatadores vasculares	510
Garrotes	22
Garrotes de madera	22
GAYLOR-THOMS Pinza saca-bocados para biopsia	460
GEISSENDOERFER-OVERHOLT Pinzas de disección y ligaduras	184
GELPI Separadores para la vulva	281
GELPI-BABY Separador para la vulva	281
GELPI-SELETZ Separador para la vulva	281
GEMINI Pinzas de disección y ligaduras	181
GEMINI-MIXTER Pinzas de disección y ligaduras	181
GERALD Pinza de disección TITE GRIP	114
GERALD Pinza quirúrgica TITE GRIP	117
GERALD Pinzas finas de disección	130
GERALD Pinzas finas quirúrgicas	142
GERSTER Barra de tracción para pinzas porta-huesos	630
GERZOG Martillo	618
GIBBON-BAILEY Aproximador para costillas	508
GIERTZ-STILLE Costótomo	492
GIGLI (OLIVECRONA) Sierras de hilo	687
GIGLI Mango con gancho	687
GILLIES (CONVERSE) Ganchos para piel y dura madre	216
GILLIES Gancho para piel	216
GILLIES Pinza quirúrgica TITE GRIP	117
GILLIES Pinzas finas quirúrgicas	142
GILLIES Porta-agujas con tijera	370
GILLIES TITE GRIP Porta-agujas	348
GILLIES-BABY Porta-agujas con tijera	370
GILLIES-BABY TITE GRIP Porta-agujas	348
GIL-VERNET (MARBERGER) Separadores para venas y hilares	223
GLASSMANN (KILNER) Tijeras para la cirugía y disección	83
GLOVER ATRAUMATIC-GRIP Pinzas-clamps para anastomosis	544
GLOVER-DE BAKEY ATRAUMATIC-GRIP Clamps Bulldog	525
GLUCK Costótomo	492
GOELET Separador	229
GOLDMANN-FOX Tijeras DURACUT para encías	55
GOLDMANN-FOX Tijeras para encías	94
Goniómetro para extremidades	7
GOOD Tijera para amígdalas	103
GOODELL Dilatador uterino	443
GORNEY Tijera DURACUT para el tabique nasal	59
GORNEY Tijeras para la cirugía plástica	82
GOSSET Separador abdominal	299-300
GOSSET-BABY Separador abdominal	299

GOURDET Cucharillas uterinas	466
GRAEFE (TYRELL) Ganchos para iris	216
GRAEFE (TYRELL) Ganchos para piel	216
GRAEFE Ganchos para estrabismo	213
GRAEFE Pinza quirúrgica	148
GRAEFE Pinzas finas de disección	128
GRAEFE Pinzas finas quirúrgicas	139
GRAHAM Gancho para dura-madre	217
GRAMCKO-BUCK Elevador para huesos	576
Grapas (Agrafes)	379
Grapas de plata en tubo de plástico	690
GRAVE Espéculos vaginales	432
GRAVE Espéculos vaginales para la cirugía con laser	433
GRAVE modif. Espéculos vaginales	432
GREEN Pinza de campo	200
GREEN Separador para la glándula tiroidea	243
GREEN-ARMYTAGE Pinza-clamp uterina para hemostasis	481
GREEN-SENN Separadores	224
GREGORY ATRAUMATIC-GRIP Pinzas-clamps para la profunda	534
GREGORY-SOFT ATRAUMATIC-GRIP Clamps Bulldog	527
GRONINGEN Ganchos para nervios y vasos	215
GROSS Pinzas para vendajes y torundas	204
GRUENWALD (JANSEN) Pinzas auriculares y nasales	136
GRUENWALD-LOVE Pinzas cortantes para laminectomía	716
Gubias	607, 609-616
Gubias de esponjosa	615
Gubias espinales	616
Gubias, hojas intercambiables	611
Guía-ligadura	697
Guías para catéteres (introductor)	425
GUNNAR-HEY Rodillo para tubos	203
GUTHRIE Ganchos para piel	218
GUYON Guía para catéteres (introductor)	425
GUYON Instrumento para introducir catéteres	425
GUYON Pinza-clamp para renal	190
GUYON-DE BAKEY ATRAUMATIC-GRIP Pinzas-clamps para renal	190

H

HABERER Espátula abdominal e intestinal	267
HAIGHT Separador costal	506
HAIGHT-FINOCCHIETTO-BABY Separador costal	501
HAJEK Martillos	617
HAJEK-KOFLER Pinzas cortantes para laminectomía	708
HALLE Cucharillas cortantes	604
HALLE Cuchillo para dura-madre	37
HALLE Espátula para la íntima	512
HALLE Perióstótomo	582
HALSEY Porta-agujas	363
HALSEY TITE GRIP Porta-agujas	342
HALSEY TITE GRIP Porta-agujas para zurdos	341
HALSTED Pinzas hemostáticas finas	169, 171
HALSTED-MICRO Pinzas hemostáticas finas	164
HALSTED-MOSQUITO (HEISS) Pinzas hemostáticas finas	170
HALSTED-MOSQUITO Pinzas hemostáticas finas	164-165, 170
HALSTED-MOSQUITO-DE BAKEY ATRAUMATIC-GRIP Pinzas hemostáticas finas	165
HARDY Curetas	692
HARDY Disecadores	693
HARDY Enucleadores	693
HARDY Horquilla para implantar	693
HARDY-FAHLBUSCH Disecadores	693
HARKEN-DE BAKEY ATRAUMATIC-GRIP Pinzas para disección y ligaduras	551
HARRINGTON Separadores y espátulas para el pulmón	262
HARRINGTON-MAYO Tijeras de disección	86
HARTMANN Cateter de eustaquio	322
HARTMANN Diapasónes	4
HARTMANN Pinza saca-bocados para biopsia	462
HARTMANN Pinzas hemostáticas finas	164
HARTMANN-COLLIN Separador	229
HASSELTINE Clamps umbilicales	486
HAVERFIELD-SCOVILLE Separador para laminectomía	286
HAYES ATRAUMATIC-GRIP Pinza para anastomosis del recto	400
HEANEY Pinzas quirúrgicas	147
HEANEY Pinzas-clamps para histerectomía	196
HEANEY Porta-agujas	369
HEANEY TITE GRIP Porta-agujas	346

HEANEY-BALLENTINE Pinza-clamp para histerectomía	196
HEANEY-DE BAKEY (ROGERS) ATRAUMATIC-GRIP Pinzas-clamps para histerectomía	197
HEANEY-REZEK Pinza-clamp para histerectomía	196
HEANEY-SIMON Separador para cirugía profunda	254
HEATH Martillo	620
HEATH-RICHTER Pinza para quitar agrafes	379
HEGAR Dilatadores uterinos	444-445
HEGAR-BABY-OLSEN TITE GRIP Porta-agujas	348
HEGAR-BAUMGARTNER TITE GRIP Porta-agujas	342
HEGAR-CORWIN TITE-GRIP Pinza cierra-hilos	662
HEGAR-MAYO Porta-agujas	367
HEGAR-MAYO TITE GRIP Porta-agujas	345
HEGAR-MAYO TITE GRIP Porta-agujas para zurdos	341
HEGAR-OLSEN Porta-agujas con tijera	370
HEGAR-OLSEN TITE GRIP Porta-agujas	348
HEGEMANN-DIETRICH Tijeras DURACUT vasculares	56
HEGEMANN-DIETRICH Tijeras vasculares	96
HEGENBARTH Pinza para poner agrafes	379
HEIFETZ Espátulas cerebrales	706
HEIFETZ Pinzas de agarre para tejido y tumor	127
HEISS (HALSTED-MOSQUITO) Pinzas hemostáticas finas	170
HEISS (MIXTER-PAUL) Pinza de disección y ligaduras	182
HEISTER Abre-boca	22
HEMINGWAY Cucharillas cortantes	599
HENLEY Separadores con retenida automática	282-283
HENNIG Separador para escayolas	682
HERRICK Pinza-clamp para pedúnculo renal	191
HEY-GUNNAR Rodillo para tubos	203
HEYMANN Tijeras DURACUT nasales	58
HEYMANN Tijeras nasales	101
HEYWOOD-SMITH Pinza para pólipos uterinos y ovarios	457
HEYWOOD-SMITH Pinza tira-lengua	23
HIBBS Separadores	231
HIBBS Separadores espinales	231
Hilo de plata	690
Hilos de cerclaje	660
HIRSCHMANN Anoscopios	407
Histerómetros	446
HOEN Perióstótomos	586
HOGLUND-LOWMAN Pinza porta-huesos	630
HOHMANN Elevadores para huesos	578-580
HOHMANN-ALDINGER Elevador para huesos	580
HOHMANN-LANGE Elevadores para huesos	577
HOHMANN-LANGE modif. Elevadores para huesos	577
HOHMANN-MINI Elevadores para huesos	576
Hojas	36
Hojas de afeitar	36
Hojas de bisturíes	34-35
Hojas de micro-bisturí	473
Hojas intercambiables	611
HOKE Osteótomos	607
HOLSHER Separador para la raíz de nervios	701
HOLZBACH Pinzas-clamps para histerectomía	194
HOPKINS Cuchillos para escayolas	679
HOPKINS-JOHNS ATRAUMATIC-GRIP Pinza para poner y quitar clamps Bulldog	527
HOPKINS-JOHNS Clamps Bulldog	163
HORGAN Separador abdominal	303
HORNE-JOBSON Porta-algodones	317
Horquilla para implantar	693
Horquilla para ligadura	378
HORSLEY Disecador para dura-madre	698
HORSLEY-LISTON-KEY Pinza cortante para huesos	494
HÖSEL Separadores	246
HOSPITAL-PROVIDENCE Pinzas hemostáticas finas	168
HOUSE Cucharillas cortantes	598
HOWARD Perióstótomos	583
HRYNTSCHAK-YOUNG Porta-agujas de bumerang	372
HUDSON Perforador de mano	652
HULKA Pinza para coger el cuello del útero	453
HULKA-KENWICK Pinza para coger el cuello del útero	453
HUMBY Dermátomo	42
HUNTER Pinzas para espinas	150
HURD Aguja para ligaduras	374

I

Iluminaciones-proximales	472
Imperdibles para esterilización, Porta-instrumentos	736
INFANT-FINOCCHIETTO Separador costal	501
INGE Separadores para cuerpos vertebrales	296
Instrumental para grapar	690-691
Instrumental para histero-salpingografía	474
Instrumental para la amniocopia	472-473
Instrumental para la micro-extracción de sangre	472-473
Instrumentos de cerclaje	660
Instrumentos de medición	7
Instrumentos de uretrografía	426
Instrumentos para apertura craneana	687
Instrumentos para biopsia ósea	669
Instrumentos para circuncisión	426
Instrumentos para exámenes y medición	6
Instrumentos para examinar la sensibilidad	4
Instrumentos para introducir catéteres	425
Instrumentos para la cirugía laser	448-451
Instrumentos para la hipofisectomía	692-693
Instrumentos para la prostatectomía	423
Instrumentos para la urología	425-426
Instrumentos para medir	448
Instrumentos para microcirugía	694-697
Instrumentos para obstétrica	481, 486
Instrumentos para sutura	378
Instrumentos para traqueotomía	728
Instrumentos para tunelar e injertar Bypass	517
Instrumentos para uñas	645
IOWA Aguja de guía	486
IOWA Aguja hipodérmica	486
IOWA Pinza para la vejiga amniótica	477
Irrigadores	751
ISRAEL Separadores	237
IVES-FANSLER Anoscopios	407

J

JACKSON Espéculos vaginales	438
JACKSON Pinza para agarrar el tendón	647
JACKSON Separador para la tráquea	217, 226
JACKSON-CHEVALIER Cánula traqueal	726
JACOBS Pinza para coger el cuello útero	456
JACOBSON Cuchillo para vasos	694-695
JACOBSON Empujador de sutura	694
JACOBSON Micro-tijeras	64
JACOBSON PERFECT-GRIP Micro-Porta-agujas	359
JACOBSON Sonda abotonada	694
JACOBSON Sonda doble	694
JACOBSON TITE GRIP Micro-Porta-agujas	338
JAMESON Porta-agujas	368
JAMESON Tijeras finas de disección	93
JANET Cilindros	331
JANET Jeringas para enjuagar la vejiga y heridas	331
JANSEN (GRUENWALD) Pinzas auriculares y nasales	136
JANSEN Cucharillas cortantes	599
JANSEN Lámpara frontal para corriente de baja tensión	11
JANSEN Periostótomo	587
JANSEN Pinzas-gubias	632
JANSEN Separadores con retenida automática	272
JANSEN-ZAUFAL Pinza-gubia	633
JAVERTS (FLETCHER) Pinza para torundas y esponjas	210
DAVID ATRAUMATIC-GRIP Pinzas-clamps para carótida	537
Jeringa para tuberculina	330
Jeringas	330-332
Jeringas auriculares	332
Jeringas para enjuagar la vejiga y heridas	331
Jeringas para insulina	330
JOBSON-HORNE Porta-algodones	317
JOHNS-HOPKINS ATRAUMATIC-GRIP Pinza para poner y quitar clamps Bulldog	527
JOHNS-HOPKINS Clamps Bulldog	163
JONES Pinzas de campo	200
JONES-LELAND ATRAUMATIC-GRIP Pinzas-clamps para vasos periféricos	534
JORGENSON Tijera de disección	98

JOSEPH Bisturí para rinoplastia	37
JOSEPH Gancho para cirugía plástica	217, 219
JOSEPH Lima para huesos	592
JOSEPH Periostótomo	582
JOSEPH Tijeras DURACUT para la cirugía plástica	45
JOSEPH Tijeras para la cirugía plástica	70
JUDD-ALLIS Pinzas intestinales y para tejidos	384
JUDD-MASSON Separador para la vejiga	310
Juego para biopsia vertebral	720-721
Juego para endarterectomía	515
Juego para traqueotomía	729-730
Juego para tunelar	516
Juego para várices	315

K

KADER Espátulas abdominales e intestinales	267
KALLMORGEN Espéculos vaginales	434
KALLMORGEN Juego de espéculos y valvas vaginales	434
KALLMORGEN Valvas vaginales	434
KALT Agujas vasculares	354
KALT Porta-agujas	363
KATSCH Sacacomedones	19
KAY-LAMBERT ATRAUMATIC-GRIP Pinzas-clamps para anastomosis de aorta	549
KAZANJIAN Pinza cortante para huesos	637
KELLY Esfinteroscopios	407
KELLY Pinza para pólipos uterinos y ovarios	457
KELLY Pinzas hemostáticas finas	168
KELLY Pinzas hemostáticas finas TITAN-LINE	168
KELLY Separadores	251
KELLY Separadores para cirugía profunda	255
KELLY Tijeras DURACUT para vasos y fístulas	45
KELLY Tijeras para vasos y fístulas	80
KELLY-BABY Pinzas hemostáticas finas	168
KELLY-RANKIN Pinzas hemostáticas finas	169
KENWICK-HULKA Pinza para coger el cuello del útero	453
KERN-LANE Pinza para huesos	625
KERN-MINI Pinza para huesos	625
KERRISON Pinza cortante para laminectomía	707
KERRISON-FERRIS-SMITH Pinzas cortantes para laminectomía	709-710, 712
KERRISON-LOVE (COLCLOUGH) Pinzas cortantes para laminectomía	710-711
KEVOURKIAN-PACIFIC Pinza saca-bocados para biopsia	464
KEVOURKIAN-YOUNGE Curetas para biopsia endo-cerviz	459
KEVOURKIAN-YOUNGE Pinzas saca-bocados para biopsia	463, 465
KEY Periostótomos	589
KEYES Trépanos cutáneos	20
KEY-HORSLEY-LISTON Pinza cortante para huesos	494
KIELAND Fórceps	479
KIELAND-LUIKART Fórceps	479
KILLIAN (MÜHLING) Tijera para el tabique nasal	102
KILLIAN Periostótomos	583
KILLIAN-EICKEN Cánulas para irrigación del seno maxilar	322
KILNER (GLASSMANN) Tijeras para la cirugía y disección	83
KILNER Ganchos para piel	216
KILNER Tijeras finas de disección	93
KILNER TITE GRIP Porta-agujas	342
KIRK Martillo	618
KIRKLIN Separadores para venas	223
KIRSCHNER Agujas	655
KIRSCHNER Estribos para extensión	658-659
KIRSCHNER Separadores abdominales	306
KIRSCHNER Sondas conductoras	377
KIRSCHNER Valvas para separadores abdominales	307
KIRSCHNER-BALFOUR Valvas para separadores abdominales	307
KLAPP Separadores para vainas tendinosas	225
KLEINERT-KUTZ Pinza para pasar tendones	649
KLEINSCHMIDT Machacadora para espora y clamp para apendectomía	403
KLIMA-ROSEGGGER Agujas	518
KLIMA-ROSEGGGER Agujas para la punción del esternón	329
KLINGENBERGH-LOTH Tijera de disección	98
KNAPP Separadores	218
KNAPP Tijeras finas para cirugía	68
KNIGHT Tijeras DURACUT nasales	58
KNIGHT Tijeras nasales	101

KNOWLES Tijera para vendajes	673
KNUTSON Instrumento de uretrografía	426
KOCHER ATRAUMATIC-GRIP Pinzas-clamps intestinales	395
KOCHER Espátula para la vesícula	268
KOCHER Pinzas hemostáticas	176
KOCHER Pinzas-clamps intestinales	392-394
KOCHER Separadores	235, 242, 244
KOCHER Sondas para bocio	378
KOCHER Separadores y separadores para huesos	232
KOCHER-BABY ATRAUMATIC-GRIP Pinzas-clamps intestinales	391
KOCHER-BABY Pinzas-clamps intestinales	391
KOCHER-LANGENBECK Separadores	240
KOCHER-OCHSNER Pinzas hemostáticas	177
KOENIG Sondas conductoras	377
KOERTE Separadores	236
KOERTE-LUER Cucharillas para los cálculos biliares	417
KOFLER-HAJEK Pinzas cortantes para laminectomía	708
KOGAN Endoespéculos para cerviz y uretra	443, 448
KÖLN MOD. Pinza hemostática para cuero cabelludo	691
KÖNIG Periostótomo	582
KÖNIG-ROSER Abre-boca	22
KONRICH Tambores de esterilización	743
KOOS Cuchillos para vasos	695
KRAUS Cuchillo para vasos	695
KRAUSE Cánula para punción del seno maxilar	319
KRAYENBÜHL Ganchos para nervios y vasos	215
KRISTELLER Espéculos y valvas vaginales	434-437
KRISTELLER Espéculos vaginales	434-437
KRISTELLER Valvas vaginales	434-437
KROENLEIN Pinza hemostática	173
KRONECKER Agujas para ligaduras	374
KÜHNE Pinza porta-laminilla	152
KUTZ-KLEINERT Pinza para pasar tendones	649

L

LA GRANGE Tijera para encías	94
LABORDE Dilatador para la tráquea	728
LAHEY Pinza de disección y ligaduras	189
LAHEY Pinza para coger el cuello útero	454
LAHEY Separador para bocio	224
LAHEY Separadores	219
LAHEY-SWEET Pinza de disección y ligaduras	189
LAMBERT-KAY ATRAUMATIC-GRIP Pinzas-clamps para anastomosis de aorta	549
LAMBERT-LOWMAN Pinza porta-huesos	630
LAMBOTTE Osteótomos	608
LAMBOTTE Periostótomos costales	497
LAMBOTTE Pinzas para huesos	626-627
LAMBOTTE-FARABEUF Pinza para huesos	626
LAMBOTTE-MINI Osteótomos	608
Lámparas frontales para corriente de baja tensión	11
LANDAU Espéculos vaginales	440
LANDAU-COLLIN Espéculos vaginales	431
LANDOLT Periostótomo	585
LANDOLT-CUSHING Espéculos para la hipofisectomía	692
LANE Pinza de campo	201
LANE Pinza para huesos	625
LANE-KERN Pinza para huesos	625
LANE-MURPHY Elevador para luxación	581
LANGE Tijera para vendajes	672
LANGE-HOHMANN Elevadores para huesos	577
LANGE-HOHMANN modif. Elevadores para huesos	577
LANGENBECK Cuchillo para lóbulos	39
LANGENBECK Cuchillo para resección	38
LANGENBECK Elevadores	575
LANGENBECK Periostótomos	587
LANGENBECK Pinza para huesos	624
LANGENBECK Separadores	238-239
LANGENBECK Sierra para amputación y resección	572
LANGENBECK TITE GRIP Porta-agujas	350
LANGENBECK-KOCHER Separadores	240
LANGENBECK-MINI Separadores	224
LANGENBECK-PARKER (US-ARMY) Separadores	231
LANGENBECK-RYDER TITE GRIP Porta-agujas	350
Lápiz para marcar y escribir sobre metal	757
Laringoscopios	24-31
LATHBURY (FARRELL) Porta-algodones	316

LAWRENCE Pinza de disección y ligaduras	187
LAWTON TITE GRIP Porta-agujas	349
LAWTON-MATHIEU TITE GRIP Porta-agujas	349
LAZAR Micro-pinzas de ligadura	121
LEBSCHKE Cíncel para esternón	492
LEES ATRAUMATIC-GRIP Pinzas-clamps bronquiales	552
Legra para lupus	19
Legras	694-697
LEGUEU Espátula para la vesícula	268
LEKSELL-STILLE Pinzas-gubias	635
LELAND-JONES ATRAUMATIC-GRIP Pinzas-clamps para vasos periféricos	534
LEMMON Espátulas para la íntima	512
LEMPERT Cucharillas cortantes	604
LEMPERT Periostótomos	584
LEMPERT Pinzas-gubias	631-632
LERICHE Pinzas hemostáticas finas	165
LEWIN Pinza para reducción	622
LEWIS Escofina	592
LEXER Gubias	612-613
LEXER Gubias de esponjosa	615
LEXER Osteótomos	612-613
LEXER Tijeras de disección	87
LEXER Tijeras DURACUT de disección	49
LEXER-BABY Tijeras de disección	87
LEXER-MAYO Tijeras de disección	87
LEXER-MAYO Tijeras DURACUT de disección	48
LEXER-MINI Gubias	612
LEXER-MINI Osteótomos	612
LEYLA Separadores automáticos para el cerebro	702
LEYLA Separadores para la fijación a la mesa de operaciones	704
LICHTENBERG TITE GRIP Porta-agujas	349
LICHTWITZ Cánulas para punción del seno maxilar	319-320
LICHTWITZ V.EICKEN Cánula para punción del seno maxilar	319
Ligadores de aspiración para hemorroides	411
Ligadores para hemorroides	410
Limas para huesos	592, 594-595
Limas para uñas	18
LINDORF TITE-GRIP Pinza cierra-hilos	662
LISTER DURACUT Tijera para vendajes	673
LISTER modif. Tijeras para vendajes	673
LISTER Pinzas para senos	204
LISTER Tijera universal para vendajes y tela	674
LISTER Tijeras para vendajes	673
LISTON Cuchillos para amputación	38
LISTON Pinzas cortantes para huesos	637, 639
LISTON-KEY-HORSLEY Pinza cortante para huesos	494
LISTON-LITTAUER Pinza cortante para huesos	637
LISTON-RUSKIN Pinzas cortantes para huesos	638
LISTON-WALTON (BÖHLER) Pinzas cortantes para huesos	638
LITTAUER Pinza depilatoria	152
LITTAUER Tijera para ligadura	352
LITTAUER-LISTON Pinza cortante para huesos	637
LITTLER Tijera de disección	81
Llaves	333
LOCKHART-MUMMERY Sondas para fistulas	314
LOCKLIN Tijeras DURACUT para encías	55
LOCKLIN Tijeras para encías	94
LOCKWOOD Pinza intestinal y para tejidos	386
LONG Pinza-clamp para histerectomía	194
LORNA Pinzas de campo	202
LOTH-KLINGENBERGH Tijera de disección	98
LOTH-SCHOEMAKER Tijera para ligadura	352
LOUTE Tensor cierra-hilo	660
LOVE Separadores para la raíz de nervios	701
LOVE-GRUENWALD Pinzas cortantes para laminectomía	716
LOVE-KERRISON (COLCLOUGH) Pinzas cortantes para laminectomía	710-711
LOVELACE Pinza intestinal y para tejidos	387
LOVELACE-DIXON Pinzas hemostáticas finas	169
LOWER Pinza de disección y ligaduras	189
LOWMAN Pinzas porta-huesos	630
LOWMAN-HOGLUND Pinza porta-huesos	630
LOWMAN-LAMBERT Pinza porta-huesos	630
LUCAE Diapasón	4
LUCAE Ganchitos auriculares	213
LUCAE Martillo	617
LUCAE Pinzas auriculares y nasales	136
LUCAS Cucharillas cortantes	599

LUER Cánulas traqueales	725
LUER Pinzas-gubias	631-632
LUER Separadores	227
LUER-FRIEDMAN Pinza-gubia	631
LUER-KOERTE Cucharillas para los cálculos biliares	417
LUER-STILLE Pinzas-gubias	634, 636
LUIKART-KIELAND Fórceps	479
Lupas frontales binoculares	8-9

M

Machacadora para espora	403
MAGILL Pinzas para introducir catéteres	32
MAIER Pinzas para vendajes y torundas	205
MAIER-SIMS Pinzas para vendajes y torundas	205
MALTZ Escofina	593
MALTZ TITE GRIP Escofinas	596
Mandriles	653
Mango con gancho	687
Mango para aspiración	320
Mango para hojas intercambiables	611
Mangos de bisturíes	34-35
Mangos metálicos para espejos laríngeos	13
Manos de plomo	644
MARBACH Tijera para perineo (episiotomía)	107
MARBERGER (GIL-VERNET) Separadores para venas y hilares	223
MARKWALDER Pinza gubia redonda	494
MARQUARDT Pinza-gubia	634
Martillos	2-3, 617-621
Martillos de percusión	2-3
MARTIN Pelvímetro	477
MARTIN Pinzas para menisco y cartilago	640
MARTIN Separador para cirugía profunda	254
MARTINI Cucharillas cortantes	598
MASSON Porta-agujas	368
MASSON TITE GRIP Porta-agujas	347
MASSON-JUDD Separador para la vejiga	310
MASTIN Pinza-clamp para músculos	728
Material para sutura	353
MATHIEU Espéculo para el recto	405
MATHIEU Espéculos vaginales	439
MATHIEU Porta-agujas	371
MATHIEU Separadores	226, 231
MATHIEU TITE GRIP Porta-agujas	349
MATHIEU Valvas vaginales	439
MATHIEU-LAWTON TITE GRIP Porta-agujas	349
MATSON Perióstotomo costal	497
MATZNAUER Espéculos vaginales	440
MAUNDER Garrote de madera	22
MAYFIELD Pinza-gubia	633
MAYO Cucharilla para los cálculos biliar	417
MAYO Depresor lingual	12
MAYO Imperdibles para instrumentos	736
MAYO Pinza para vasos y tumores	149
MAYO Separador abdominal	249
MAYO Tijeras de disección	84
MAYO Tijeras DURACUT de disección	47
MAYO-ADAMS Separadores para apendectomía	284
MAYO-BLAKE Pinzas para los cálculos biliares	418
MAYO-HARRINGTON Tijeras de disección	86
MAYO-HEGAR Porta-agujas	367
MAYO-HEGAR TITE GRIP Porta-agujas	345
MAYO-HEGAR TITE GRIP Porta-agujas para zurdos	341
MAYO-LEXER Tijeras de disección	87
MAYO-LEXER Tijeras DURACUT de disección	48
MAYO-NOBLE Tijeras de disección	86
MAYO-ROBSON ATRAUMATIC-GRIP Pinzas-clamps intestinales	396
MAYO-ROBSON Pinzas-clamps intestinales	396
MAYO-STILLE Tijeras de disección	85
MAYO-STILLE Tijeras DURACUT de disección	48
MC DONALD Disecador	574
MC GIVNEY Pinza-clamp para hemorroides	410
MC INDOE Pinza cortante para huesos	638
MC INDOE Pinza de disección TITE GRIP	113
MC INDOE Pinza fina de disección	130
MC INDOE Tijera para cartilago	82
MC INTOSH Laringoscopios	24-27
MC KENTY Perióstotomo	582

MC KENZIE Fresa	652
MC KENZIE Grapas de plata en tubo de plástico	690
MC KENZIE Hilo de plata	690
MC KENZIE Pinzas clipadoras	690
MC KENZIE Porta-grapas	690
MC PHERSON Micro-pinzas de ligadura	122
MEAD Martillo	618
MEAD Pinzas-gubias	631
Meatótomo	426
MEEKER Pinza de disección y ligaduras	187
MEEKER-BABY Pinzas de disección y ligaduras	180
MENGHINI Agujas para la punción ciega del hígado	329
MENGHINI Agujas para la punción del hígado	329
MERCEDES Separador torácico	507
METZENBAUM Tijeras de disección	88-90
METZENBAUM Tijeras DURACUT	54
METZENBAUM Tijeras DURACUT de disección	49-52
METZENBAUM-BABY Tijeras de disección	89
METZENBAUM-NELSON Tijeras de disección	91
METZENBAUM-NELSON Tijeras DURACUT de disección	53
METZENBAUM-THOREK Tijeras DURACUT adnex	54
MEYERDING Separadores	225
MEYERDING Separadores para laminectomía	284
MICHEL Agrafes (grapas)	379
MICHEL Espejos rinoscópicos	14
MICHEL Pinza para poner agrafes	379
MICHEL Pinza para poner y quitar agrafes	379
MICRO-ADSON Pinzas finas de disección	129
MICRO-ADSON Pinzas finas quirúrgicas	140-141
MICRO-ADSON Pinzas quirúrgicas TITE GRIP	117
MICRO-CASTROVIEJO Micro-Porta-agujas	358
Micro-Clamps Bulldog	162
MICRO-CRILE Pinzas hemostáticas finas	166
MICRO-HALSTED Pinzas hemostáticas finas	164
Micro-pinzas	120-125
Micro-pinzas (modelos de relojero)	120
Micro-pinzas de agarre	124
Micro-Pinzas de agarre PERFECT-GRIP	124
Micro-pinzas de ligadura	121-123
Micro-pinzas de ligadura PERFECT-GRIP	123
Micro-pinzas TITE GRIP	118
Micro-Porta-agujas	358-362
Micro-Porta-agujas PERFECT-GRIP	359, 361-362
Micro-Porta-Agujas TITE GRIP	338-339
Micro-tijeras	62-67
Micro-tijeras de disección	65
MIDDELDORF Separadores	243
MIKULICZ Pinzas-clamps para peritoneo	192-193
MIKULICZ Separadores para cirugía profunda	255
MIKULICZ-BABY Pinza-clamp para peritoneo	192
MILAN Cureta para biopsia endo-cerviz	460
MILLER Escofinas	592
MILLER Laringoscopios	28-31
MILLER TITE GRIP Escofinas	596
MILLER-SENN Separadores	226
MILLESÍ Micro-tijeras	64
MILLIGAN Disecador para dura-madre	698
MILLIN Dilatador para el cuello vesical	423
MILLIN Pinza capsular	423
MILLIN Pinza para coger los lóbulos anteriores	423
MILLIN Pinza porta-ligaduras supra-pubiana	423
MILLIN Separadores para la vejiga	310
MILLIN-YOUNG Porta-agujas de bumerang	372
MINI-HOHMANN Elevadores para huesos	576
MINI-KERN Pinza para huesos	625
MINI-LAMBOTTE Osteótomos	608
MINI-LANGENBECK Separadores	224
MINI-LEXER Gubias	612
MINI-LEXER Osteótomos	612
MINI-STILLE Cizalla para escayolas	677
MINI-YASARGIL Clips vasculares	154
MINI-YASARGIL Pinzas para aplicar clips vasculares	154
MIOTTI-OVERHOLT Pinzas de disección y ligaduras	185
MIXTER Pinza para los cálculos biliar	419
MIXTER Pinzas de disección y ligaduras	182, 188-189
MIXTER Tijeras para cirugía	79
MIXTER-BABY Pinzas de disección y ligaduras	180
MIXTER-GEMINI Pinzas de disección y ligaduras	181
MIXTER-O'SHAUGNESSY Pinza de disección y ligaduras	182

MIXTER-OVERHOLT Pinza de disección y ligaduras	183
MIXTER-PAUL (HEISS) Pinza de disección y ligaduras	182
MOBERG Separadores	224
MOD. BONN Pinzas finas quirúrgicas	138
MOD. CANAD. Bisturíes para menisco	643
MOD. KÖLN Pinza hemostática para cuero cabelludo	691
MOD. MÜNCHEN Cureta para biopsia endo-uterina	459
MOD. RUSS. Pinzas para vasos y tumores	149
MOD. SWITZERLAND Micro-pinzas (modelos de relojero)	120
MOD. TÜBINGEN VANNAS Micro-tijeras	62
MOD. USA Cucharillas cortantes	601
MOD. USA Pinzas de disección	133
MOD. USA Pinzas quirúrgicas	145
MOD. USA Separador para escayolas	682
MOD. USA Tijera umbilical	108
MOD. WIENER Porta-ligadura	378
MOGEN Instrumento para circuncisión	426
MOLDESTAD Separador para venas	217
MÖLTGEN Goniómetro para extremidades	7
Mondador de tendones	646
MOORE Cucharilla para la vesícula biliar	417
MOORE-STAUDE Pinza para coger el cuello del útero	452
MORGAN-TISCHLER Pinza saca-bocados para biopsia	464
MORRIS-DE BAKEY ATRAUMATIC-GRIP Pinzas-clamps para aorta	540
MORSE Separador para esternotomía	499
MOSQUITO-BABY Pinzas hemostáticas finas	164
MOSQUITO-HALSTED Pinzas hemostáticas finas	164-165, 170
MOSQUITO-HALSTED-DE BAKEY ATRAUMATIC-GRIP Pinzas hemostáticas finas	165
MOTT-PARKER Separadores	228
MOYNIHAN Pinzas hemostáticas	178
MOYNIHAN Sonda y cucharilla para los cálculos biliares	415
MÜHLING (KILLIAN) Tijera para el tabique nasal	102
MÜHLING Periostótomos	584
MÜLLER Aproximadores	158
MÜLLER-BIEMER Aproximadores	157
MÜLLER-VERBRUGGE Elevadores para huesos	579
MUMMERY-LOCKHART Sondas para fistulas	314
MÜNCHEN MOD. Cureta para biopsia endo-uterina	459
MURLESS Elevador para cabeza	481
MURPHY Cinta	10
MURPHY-LANE Elevador para luxación	581
MURRAY-CRILE Porta-agujas	366
MUSEUX Pinzas para coger el cuello útero	456
MYERS Sondas para várices	315

N

NABATOFF Juego para várices	315
NAEGLE Fórceps	478
NAGEL Micro-tijeras	67
NEFF Bisturíes para menisco	642
NEGUS Pinzas hemostáticas y para amígdalas	179
NEIVERT Porta-agujas	363
NEIVERT TITE GRIP Porta-agujas	342
NEIVERT-COTTLE Gancho para las coanas	221
NELATON Sonda acanalada	314
NELSON Pinza quirúrgica	148
NELSON Trocares para hidrocele y punción abdominal	318
NELSON-METZENBAUM Tijeras de disección	91
NELSON-METZENBAUM Tijeras DURACUT de disección	53
NEW ORLEANS Porta-agujas	367
NEW ORLEANS TITE GRIP Porta-agujas	344
NEWS Separador para la tráquea	217
NOBLE-MAYO Tijeras de disección	86
NORTHBENT (SPENCER) Tijeras para ligaduras	352
NOTO Pinza para pólipos uterinos y ovarios	457
NOTT Espéculos vaginales	433
NOVAK Cureta aspiradora para biopsia endo-uterina	459

O

O'BRIEN Tijera para ligadura	352
O'CONNOR Gancho para piel	217
O'CONNOR-O'SULLIVAN Separador abdominal	304
O'SHAUGNESSY-MIXTER Pinza de disección y ligaduras	182
O'SULLIVAN-O'CONNOR Separador abdominal	304

OBWEGESER Pinza de ligadura TITE GRIP	113
OBWEGESER Separadores para tejido blando	241
OCHSNER ATRAUMATIC-GRIP Pinza-clamp para aorta	539
OCHSNER Pinza para ligadura	152
OCHSNER Sonda para el conducto biliar	415
OCHSNER Trócares para vesícula biliar	318
OCHSNER-ALLIS Pinza intestinal y para tejidos	383
OCHSNER-DIXON (CRILE-RANKIN) Pinzas hemostáticas finas	167
OCHSNER-KOCHER Pinzas hemostáticas	177
OCHSNER-ROCHESTER Pinzas hemostáticas	178
OEHLER Pinzas TITE GRIP	118
OLDBERG Pinza para hipófisis	719
OLIVECRONA (GIGLI) Sierras de hilo	687
OLIVECRONA Disecadores para dura-madre	700
OLIVECRONA Espátulas cerebrales	706
OLIVECRONA Tijera para nervio trigémino	100
OLIVECRONA-TOENNIS (SCOVILLE) Pinza para colocar grapas	690
OLLIER Separador	236
OLSEN-HEGAR Porta-agujas con tijera	370
OLSEN-HEGAR TITE GRIP Porta-agujas	348
OLSEN-HEGAR-BABY TITE GRIP Porta-agujas	348
OMBREDANNE Martillo	621
Osteótomos	607-614
Osteótomos, hojas intercambiables	611
OVERHOLT Pinzas de disección y ligaduras	183, 185
OVERHOLT-BABY Pinza de disección y ligaduras	183
OVERHOLT-GEISSENDOERFER Pinzas de disección y ligaduras	184
OVERHOLT-MIOTTI Pinzas de disección y ligaduras	185
OVERHOLT-MIXTER Pinza de disección y ligaduras	183

P

PACIFIC-KEVOURKIAN Pinza saca-bocados para biopsia	464
Palanganas	749
PARK-ALAN Separador para el recto	408
PARKER Separadores	228
PARKER-LANGENBECK (US-ARMY) Separadores	231
PARKER-MOTT Separadores	228
PASQUE EUFRATE TITE GRIP Porta-agujas	344
PAUFIQUE Pinza fina quirúrgica	139
PAUL Separador para vainas tendinosas	225
PAUL-MIXTER (HEISS) Pinza de disección y ligaduras	182
PAYR Aguja vascular	354
PAYR Pinzas-clamps intestinales y estomacales	403
PAYR Sondas conductoras	377
PAYR-BABY Pinzas-clamps intestinales y estomacales	403
PEAN Pinzas hemostáticas	173-174
PEAN-DE BAKEY ATRAUMATIC-GRIP Pinzas-clamps vasculares	529
PEAN-DE BAKEY ATRAUMATIC-GRIP Pinzas hemostáticas	176
PEAN-ROCHESTER Pinzas hemostáticas	175
PEDERSON Espéculos vaginales	432
PEDERSON Espéculos vaginales para la cirugía con laser	433
PEERS Pinza de campo	202
PEET Pinza para espinas	151
PEET Pinzas para espinas TITE GRIP	151
PELTESON Porta-algodones	317
Pelvímetro	477
PENFIELD Disecadores para dura-madre	699
PENNINGTON Pinzas intestinales y para tejidos	387
PERCY Retractores para amputación	571
PERFECT-GRIP Micro-pinzas de agarre	124
PERFECT-GRIP Micro-pinzas de ligadura	123
PERFECT-GRIP Micro-Porta-agujas	359, 361-362
PERFECT-GRIP Porta-agujas	364
PERFECT-GRIP TITAN-LINE Porta-agujas	365
Perfora-cráneos	485
Perforador de mano	651-653
Perforadores iniciales	689
Periostótomos	582-591
Periostótomos costales	495-497
PERMAN Separador abdominal	299
PERTHES Escariadores	650
PHANEUF Pinza-clamp para histerectomía	194
PIERCE Cánula para punción del seno maxilar	319
Piezas de conexión	333
Piezas de repuesto para la sierra oscilante	681
PIFFARD Curetas para lupus	20
PINARD Estetoscopio	5

Pinzas agarre de tejidos	148
Pinzas agarre del pulmón	149
Pinzas aproximadoras sin porta-clips	378
Pinzas auriculares y nasales	136-137
Pinzas capsular	423
Pinzas cierra-hilos TITE GRIP	662
Pinzas clipadoras	690
Pinzas conductora para catéteres	473
Pinzas cortantes para huesos	494, 637-639
Pinzas cortantes para laminectomía	707-719
Pinzas corta-uñas	17, 645
Pinzas cuticulares	17
Pinzas de agarre	149
Pinzas de agarre para tejido y tumor	126-127
Pinzas de campo	200-202
Pinzas de disección	132-134, 180-189
Pinzas de disección TITE GRIP	113-115
Pinzas de disección y ligaduras	180-189, 564
Pinzas de disección y ligaduras ATRAUMATIC-GRIP	186
Pinzas de ligadura TITE GRIP	113
Pinzas de torácica y ligadura	564
Pinzas de tracción craneal	689
Pinzas depilatorias	152
Pinzas DIU (Dispositivo Intra-Uterino)	447
Pinzas finas de disección	128-131
Pinzas finas quirúrgicas	138-143
Pinzas gubias	494
Pinzas hemostáticas	164-179
Pinzas hemostáticas ATRAUMATIC-GRIP	176
Pinzas hemostáticas finas	164-172
Pinzas hemostáticas finas ATRAUMATIC-GRIP	165, 167
Pinzas hemostáticas finas TITAN-LINE	166, 168
Pinzas hemostáticas para cuero cabelludo	691
Pinzas intestinales	149
Pinzas intestinales y para tejidos	383-389
Pinzas intestinales y para tejidos ATRAUMATIC-GRIP	389
Pinzas intestinales y para tejidos TITE GRIP	388
Pinzas para aborto	482-483
Pinzas para agarrar el tendón	647
Pinzas para amígdalas	179
Pinzas para anastomosis del recto	400-401
Pinzas para anastomosis del recto ATRAUMATIC-GRIP	400-401
Pinzas para aplicar aproximadores	158
Pinzas para aplicar clips vasculares	154-156
Pinzas para aplicar y quitar clips hemostáticas	691
Pinzas para cerrar los clamps	402
Pinzas para coger el cuello del útero	452-456
Pinzas para coger los lóbulos anteriores	423
Pinzas para colocar grapas	690
Pinzas para desechos	735
Pinzas para disección y ligaduras ATRAUMATIC-GRIP	551
Pinzas para el útero	458
Pinzas para entrelazar tendones	649
Pinzas para espinas	150-151
Pinzas para espinas TITE GRIP	151
Pinzas para esterilización	734
Pinzas para extraer alambres	663-664
Pinzas para extraer alambres TITE GRIP	663
Pinzas para fijar el cordón espermático	425
Pinzas para fragmentos pequeños	622
Pinzas para hipófisis	719
Pinzas para huesos	493, 624-629
Pinzas para introducir catéteres	32
Pinzas para la aurícula atril	564
Pinzas para la reducción maxilar	622
Pinzas para la vejiga amniótica	477
Pinzas para ligaduras	152, 180-189
Pinzas para los cálculos biliares	418-419
Pinzas para los cálculos renales	420-421
Pinzas para menisco y cartilago	640
Pinzas para microscopia	121
Pinzas para pasar tendones	649
Pinzas para pericráneo	481
Pinzas para placenta	482-483
Pinzas para pólipos uterinos y ovarios	457
Pinzas para poner agrafes	379
Pinzas para poner y quitar agrafes	379
Pinzas para poner y quitar TITAN-LINE clamps Bulldog	160
Pinzas para quitar agrafes	379
Pinzas para reducción	622-623
Pinzas para romper escayolas	682
Pinzas para rotula	623
Pinzas para secuestro	623
Pinzas para senos	204
Pinzas para sostener el riñón	421
Pinzas para sujetar y romper hojas de afeitar	36
Pinzas para tapones	208
Pinzas para tejidos y tirar uñas TITE GRIP	116
Pinzas para torundas y esponjas	209-210
Pinzas para tubos	203
Pinzas para vasos y tumores	148-149
Pinzas para vendajes y torundas	204-207
Pinzas pasadoras	517
Pinzas patente de conducto ATRAUMATIC-GRIP	531, 556
Pinzas porta-huesos	630
Pinzas porta-laminillas	152
Pinzas porta-ligaduras supra-pubiana	423
Pinzas quirúrgicas	144-148
Pinzas quirúrgicas TITE GRIP	117-118
Pinzas saca-bocado craneal	688
Pinzas saca-bocado para biopsia	460-465
Pinzas saca-bocado para biopsia rectal	412
Pinzas tira-lenguas	23
Pinzas TITE GRIP	118
Pinzas vasculares ATRAUMATIC GRIP	135
Pinzas-clamps bronquiales	566
Pinzas-clamps bronquiales ATRAUMATIC-GRIP	552
Pinzas-clamps de presión progresiva	409
Pinzas-clamps de varias aplicaciones ATRAUMATIC-GRIP	520-523, 530, 553-556
Pinzas-clamps estomacales	403
Pinzas-clamps estomacales ATRAUMATIC-GRIP	397
Pinzas-clamps intestinales	390-396, 403
Pinzas-clamps intestinales ATRAUMATIC-GRIP	391, 395-396
Pinzas-clamps intestinales y estomacales	403
Pinzas-clamps intestinales y para anastomosis	402
Pinzas-clamps oclusiva inferior ATRAUMATIC-GRIP	399
Pinzas-clamps oclusiva superior ATRAUMATIC-GRIP	398
Pinzas-clamps para anastomosis (vena cava)	565
Pinzas-clamps para anastomosis ATRAUMATIC-GRIP	520-523, 542-544, 548-549, 559-560
Pinzas-clamps para anastomosis de aorta ATRAUMATIC-GRIP	548-549
Pinzas-clamps para aneurisma de aorta ATRAUMATIC-GRIP	545-547, 561
Pinzas-clamps para aorta ATRAUMATIC-GRIP	537-540, 561
Pinzas-clamps para arteria renal ATRAUMATIC-GRIP	537
Pinzas-clamps para arterias renales ATRAUMATIC-GRIP	558
Pinzas-clamps para carótida ATRAUMATIC-GRIP	524, 537
Pinzas-clamps para coarctación ATRAUMATIC-GRIP	532-533, 557
Pinzas-clamps para hemorroides	410
Pinzas-clamps para histerectomía	194-197
Pinzas-clamps para histerectomía ATRAUMATIC-GRIP	197
Pinzas-clamps para iliaca ATRAUMATIC-GRIP	558
Pinzas-clamps para la pediatría ATRAUMATIC-GRIP	555
Pinzas-clamps para la profunda ATRAUMATIC-GRIP	534
Pinzas-clamps para músculos	728
Pinzas-clamps para oclusión tangencial ATRAUMATIC-GRIP	541, 562
Pinzas-clamps para pedúnculo renal	191
Pinzas-clamps para peritoneo	192-193
Pinzas-clamps para renal	190
Pinzas-clamps para renal ATRAUMATIC-GRIP	190
Pinzas-clamps para vasos periféricos ATRAUMATIC-GRIP	534-536, 558
Pinzas-clamps para vena cava ATRAUMATIC-GRIP	550
Pinzas-clamps uterina para hemostasis	481
Pinzas-clamps vasculares ATRAUMATIC-GRIP	520-523, 530, 534, 537, 555-556, 558, 561-562
Pinzas-clamps vasculares semi-flexibles	563
Pinzas-conductoras de tendón	648
Pinzas-gubias	631-636
Pinzas-guías para taladros	650
PIPER Fórceps	480
Pipeta de vidrio	473
Pisón	606
Pistola-lavatoria de chorro de agua	754-755
Placas de identificación de color	743
PLESTER Separadores con retenida automática	275
POOLE Tubos para aspiración	325
Porta-agujas	363, 366-371
Porta-agujas con tijera	370

Porta-agujas de bumerang	372
Porta-agujas para zurdos TITE GRIP	341
Porta-agujas PERFECT-GRIP	364
Porta-agujas PERFECT-GRIP micro	359, 361-362
Porta-agujas PERFECT-GRIP TITAN-LINE	365
Porta-agujas TITE GRIP	340-350
Porta-agujas TITE GRIP micro	338-339
Porta-agujas-micro	358-362
Porta-algodón y -tapónes	473
Porta-algodones	316-317, 409
Porta-clamp	402
Porta-grapas	690-691
Porta-hoja micro-bisturí	473
Porta-instrumentos	736-737
Porta-ligadura	378
Porta-placas	743
POTTS-DE BAKEY ATRAUMATIC-GRIP Pinzas patente de conducto	531
POTTS-SMITH Pinzas de disección TITE GRIP	114
POTTS-SMITH Pinzas finas de disección	131
POTTS-SMITH Pinzas finas quirúrgicas	143
POTTS-SMITH Tijera de disección	98
POTTS-SMITH Tijeras DURACUT vasculares	56
POTTS-SMITH Tijeras vasculares	96-97
POZZI Pinza para coger el cuello del útero	453
PRATT Espéculo para el recto	405
PRATT Pinzas para coger el cuello útero	455
PRATT Sondas para fístula (gancho para cripta)	409
PREP LUBE Detergente para instrumentos	733
PRESBYTERIAN Pinza para tubos	203
PRICE-THOMAS Pinzas-clamps bronquiales	566
PROVIDENCE-HOSPITAL Pinzas hemostáticas finas	168
PUTTI Escofinas	594
PYNCHON-ANDREW Tubos para aspiración	325

Q

QUERVAIN Elevador	575
QUINBY Tijera para encías	94
QUINKE Agujas para punción lumbar	328

R

RABINER Martillos de percusión	3
RADOLF Pinza arranca-uñas	645
RAGNELL Tijeras DURACUT de disección	49
RAGNELL Tijeras para la cirugía y disección	83
RAGNELL-DAVIS Gancho para cirugía plástica	226
RALK Perforador de mano	653
RALKS (VIRTUS) Pinza para espinas	151
RAMPLEY Pinzas para torundas y esponjas	210
RANDALL Cureta aspiradora para biopsia endo-uterina	459
RANDALL Pinzas para los cálculos renales	420-421
RANEY Pinza hemostática para cuero cabelludo	691
RANEY Pinza para aplicar y quitar clips hemostáticas	691
RANEY Porta-grapas	691
RANKIN-CRILE (OCHSNER-DIXON) Pinzas hemostáticas finas	167
RANKIN-CRILE-DE BAKEY Pinzas hemostáticas finas ATRAUMATIC-GRIP	167
RANKIN-KELLY Pinzas hemostáticas finas	169
RAY Curetas	692
RECAMIER Curetas para aborto y placenta	484
RECAMIER Curetas uterinas	468
Recipientes	747
REDO Pinzas-clamps intestinales	390
REDON Agujas de guía	334
Reglas	6
REINER Cuchillo para escayolas	679
RESANO ATRAUMATIC-GRIP Pinza para anastomosis del recto	401
Retractores para amputación	571
REVERDIN Agujas	373
REVERDIN Espátula abdominal e intestinal	267
REYNOLDS Tijeras finas de disección	93
REYNOLDS-COOLEY ATRAUMATIC-GRIP Pinzas-clamps para anastomosis	559
REYNOLDS-DE BAKEY ATRAUMATIC-GRIP Pinzas-clamps para anastomosis	542
REZEK-HEANEY Pinza-clamp para histerectomía	196

RICARD Separadores abdominales	298
RICHARDSON Separadores	251
RICHARDSON-EASTMAN Separadores	250
RICHTER Tijera para operaciones	80
RICHTER-HEATH Pinza para quitar agrafes	379
RIENHOFF-FINOCHIETTO Separador costal	506
ROBB Espátulas y dilatadores para la íntima	512
ROBERTS Pinzas hemostáticas	178
ROBSON-MAYO ATRAUMATIC-GRIP Pinzas-clamps intestinales	396
ROBSON-MAYO Pinzas-clamps intestinales	396
ROCHARD Bastidores para la fijación a las barras laterales	309
ROCHARD Separadores abdominales	309
ROCHESTER-CARMALT Pinzas hemostáticas	178
ROCHESTER-OCHSNER Pinzas hemostáticas	178
ROCHESTER-PEAN Pinzas hemostáticas	175
Rodillo para tubos	203
ROEDER Pinza de campo	201
ROGERS (HEANEY-DE BAKES) ATRAUMATIC-GRIP Pinzas-clamps para histerectomía	197
ROGERS (WERTHEIM-DE BAKEY) ATRAUMATIC-GRIP Pinzas-clamps parametrium	197
ROGGE Pinza para esterilización	734
ROLLET Separador	218
ROSCHKE Separador para el recto	407
ROSE Separadores	227
ROSEGGER-KLIMA Agujas	518
ROSEGGER-KLIMA Agujas para la punción del esternón	329
ROSEN Cánulas para aspiración	320
ROSER-KÖNIG Abre-boca	22
RÖTTGEN-RUSKIN Pinza-gubia	636
ROUX Separadores	229
ROUX-BABY Separadores	228
RUDD Ligador para hemorroides	410
RUMEL Pinzas de disección y ligaduras	186
RUMEL-BELMONT Torniquetes	518
RUMEL-DE BAKEY ATRAUMATIC-GRIP Pinzas de disección y ligaduras	186
RUSKIN Pinzas cortantes para huesos	638
RUSKIN Pinzas-gubias	633-634
RUSKIN-LISTON Pinzas cortantes para huesos	638
RUSKIN-RÖTTGEN Pinza-gubia	636
RUSKIN-STILLE Pinza-gubia	636
RUSS. MODELL Pinzas para vasos y tumores	149
RUST Sierra para amputación y resección	573
RYDEL-SEIFFER Diapasón	4
RYDER TITE GRIP Micro-Porta-agujas	340
RYDER-LANGENBECK TITE GRIP Porta-agujas	350
RYDER-VASCULAR TITE GRIP Micro-Porta-agujas	340

S

SAALFELD Saca-comedones	19
Saca-comedones	19
SACHS Disecadores para dura-madre	698
SACHS Gancho para dura-madre	217
SACHS Gancho para fístulas	221
SACHSE Meatótomo	426
SAENGER Pinzas para aborto y placenta	483
SALENIUS Bisturíes para menisco	642
SALING Amnioscopios	472
SALING Amnioscopios para la micro-extracción de sangre	472
SAMII Pinza de agarre para tejido y tumor	127
SAMII-YASARGIL Pinza de agarre para tejido y tumor	126
SANVENERO Tijeras para la cirugía plástica	70
SAROT Pinzas hemostáticas finas	171
SAROT Pinzas-clamps bronquiales	566
SAROT TITE GRIP Porta-agujas	344
SATINSKY Pinzas-clamps para anastomosis (vena cava)	565
SATINSKY Tijera para la vena cava	99
SATINSKY-BABY Pinza-clamp para anastomosis (vena cava)	565
SATINSKY-DE BAKEY ATRAUMATIC-GRIP Clamps Bulldog	525
SATINSKY-DE BAKEY ATRAUMATIC-GRIP Pinzas-clamps para oclusión tangencial	541
SATTERLEE Sierra para amputación y resección	572
SAUER Pinza fina quirúrgica	138
SAUERBRUCH Costótomo	492
SAUERBRUCH Estuches para esterilizar agujas	357
SAUERBRUCH Pinza para desechos	735

SAUERBRUCH Separadores	242	Separadores para la fijación a la mesa de operaciones	704
SAUERBRUCH-FREY Costótomo	493	Separadores para la fijación del cráneo	702-705
SAUERBRUCH-SCHNEIDER Periestótomo	588	Separadores para la glándula tiroidea	243
SCALP CONTOUR Separadores con retenida automática	276	Separadores para la prostata	422
SCHAAF Pinza depilatoria	152	Separadores para la raíz de nervios	701
SCHÄDEL Pinzas de campo	200	Separadores para la salida de cabeza	481
SCHAMBERG Saca-comedones	19	Separadores para la tráquea	728
SCHEDE Cucharillas cortantes	602	Separadores para la vejiga	310
SCHERBACK Espéculos vaginales	442	Separadores para la vulva	281
SCHINK Dermátomo	41	Separadores para laminectomía	276, 279-280, 284, 286
SCHMID Cánulas vasculares para irrigación	322	Separadores para párpados	222
SCHMID Espátulas para la íntima	513	Separadores para pelvis	256-258
SCHMIEDEN Sonda conductora	378	Separadores para píloro	403
SCHMIEDEN-TAYLOR Tijera para dura-madre	100	Separadores para rodilla	641
SCHNEIDER Periestótomo	588	Separadores para scápula	260
SCHNEIDER-SAUERBRUCH Periestótomo	588	Separadores para tejido blando	241
SCHNIDT Pinzas hemostáticas y para amígdalas	179	Separadores para tráquea	217, 219-220
SCHOEMAKER-LOTH Tijera para ligadura	352	Separadores para vainas tendinosas	225
SCHRÖDER Cucharillas uterinas	466	Separadores para venas	217, 222-223
SCHRÖDER Pinzas para coger el cuello del útero	452, 454	Separadores para venas (separadores para párpados)	222
SCHUBERT Pinzas saca-bocados para biopsia	461	Separadores profundo para mano y antebrazo	271
SCHULTZE Salpingógrafos	474	Separadores torácico	507
SCHUMACHER Pinzas saca-bocados para biopsia	463	Separadores y contractor costal	508
SCHUMACHER Tijera umbilical	108	Separadores y separadores para huesos	232
SCHWARTZ Clips vasculares	155	Separadores abdominales	248-249
SCHWARTZ Pinzas para aplicar clips vasculares	155	SEUTIN Tijera para tela, cizalla para escayolas	675
SCOVILLE (OLIVECRONA-TOENNIS) Pinza para colocar grapas	690	SEWALL Periestótomo	582
SCOVILLE Ganchos para separadores	287	SHAMBAUGH Ganchos para la microcirugía	212
SCOVILLE Separadores para la raíz de nervios	701	SIEBOLD Tijera uterina	106
SCOVILLE Separadores para laminectomía	286	SIEBOLD-SIMS Tijera uterina	106
SCOVILLE Valvas laterales para separadores	287	Sierra oscilante para escayolas	680
SCOVILLE-HAVERFIELD Separador para laminectomía	286	Sierras de hilo	687
SCUDDER ATRAUMATIC-GRIP Pinzas-clamps estomacales	397	Sierras para abrir anillos	645
SEALY Tijeras finas para cirugía	68	Sierras para amputación y resección	572-573
SEBILEAU Elevador	575	Sierras para escayolas	679
Seda para sutura	353	SILVER Dermátomo para hojas de afeitar corrientes	41
SEDILLOT Periestótomos	586	SIMON Cucharillas cortantes	605
SEGOND Pinzas-clamps para histerectomía	195-196	SIMON Cucharillas uterinas	466
SEIFFER-RYDEL Diapasón	4	SIMON Gancho para fistulas	221
SELETZ-GELPI Separador para la vulva	281	SIMON Separadores para cirugía profunda	254
SELLHEIM Separador para la salida de cabeza	481	SIMON-HEANEY Separador para cirugía profunda	254
SELLORS Separador y contractor costal	508	SIMPSON Histerómetros	446
SEMB Periestótomos costales	496	SIMPSON-BRAUN Fórceps	478
SEMB Pinza cortante para huesos	494	SIMS Curetas uterinas	467
SEMB Pinza gubia	494	SIMS Espéculos para el recto	405-406
SEMB Pinzas de disección y ligaduras	564	SIMS Espéculos vaginales	438
SEMB Pinzas para huesos	493	SIMS Histerómetros	446
SEMB Separadores para el pulmón	260	SIMS Tijeras DURACUT uterinas	60
SEMKEN Pinza de disección TITE GRIP	113	SIMS Tijeras uterinas	104-105
SEMKEN Pinza quirúrgica TITE GRIP	117	SIMS-MAIER Pinzas para vendajes y torundas	205
SEMKEN Pinzas finas de disección	130	SIMS-SIEBOLD Tijera uterina	106
SEMKEN Pinzas finas quirúrgicas	142	SINGLEY (TUTTLE) Pinzas agarre del pulmón	149
SEMM Espéculos vaginales	432	SMELLIE Perfora-cráneos	485
SEMM Separador abdominal	305	SMILLIE Bisturries para menisco	643
SENN-GREEN Separadores	224	SMILLIE Separadores para rodilla	641
SENN-MILLER Separadores	226	SMITH Tijeras para vendajes	672
Separadores	212, 216-265	SMITH-BUIE Separador para el recto	408
Separadores abdominales	297-309	SMITH-CUSHING-FERRIS Pinzas cortantes para laminectomía	713
Separadores atrium	509	SMITH-FERRIS Pinzas quirúrgicas	147
Separadores con retenida automática	270-276, 278, 282-283	SMITH-HEYWOOD Pinza para pólipos uterinos y ovarios	457
Separadores costales	500-508	SMITH-HEYWOOD Pinza tira-lengua	23
Separadores de mano y túnel de carpo	271	SMITH-KERRISON-FERRIS Pinzas cortantes para laminectomía	709-710, 712
Separadores espinales	231	SMITH-POTTS Pinza fina de disección	131
Separadores para apendectomía	284	SMITH-POTTS Pinzas de disección TITE GRIP	114
Separadores para bocio	224	SMITH-POTTS Pinzas finas quirúrgicas	143
Separadores para cirugía profunda	252-259	SMITH-POTTS Tijeras de disección	98
Separadores para cuerpos vertebrales	296	SMITH-POTTS Tijeras DURACUT vasculares	56
Separadores para dedos	271	SMITH-POTTS Tijeras vasculares	96-97
Separadores para dedos y pequeñas heridas	271	SOFT-GREGORY ATRAUMATIC-GRIP Clamps Bulldog	527
Separadores para el pulmón	260	SOMER Pinza para el útero	458
Separadores para el recto	407-408	Sondas	312-314, 450-451
Separadores para escayolas	682	Sondas abotonadas	312-313, 694
Separadores para esternotomía	498-499	Sondas con oje	313
Separadores para hemi-laminectomía	277	Sondas conductoras de plástico	378
Separadores para hilares	223	Sondas conductoras	377-378
Separadores para huesos	232	Sondas dobles	694
Separadores para la cirugía lumbar vertebral	294	Sondas forma mirto	313
Separadores para la columna cervical	285, 290-292	Sondas metálicas	424
Separadores para la columna vertebral	288		

Sondas para bocio.	378
Sondas para el conducto biliar.	415
Sondas para el recto	409
Sondas para endarterectomía	514
Sondas para fistula (gancho para cripta)	409
Sondas para medir	450
Sondas para medir la profundidad	451
Sondas para várices	315
Sondas y cucharilla para los cálculos biliares	415
SPENCER (NORTHBENT) Tijeras para ligaduras	352
SPENCER Tijeras para ligadura.	352
SPENCER-WELLS Pinzas hemostáticas	173
SPRATT Cucharillas cortantes.	602
SPURLING Pinzas cortantes para laminectomía	717
ST. MARKS Separadores para pelvis	258
ST. MARTIN Pinza fina quirúrgica	139
STADLER-BRAUN Tijera para perineo (episiotomía)	107
STANDARD-YASARGIL Clips vasculares	154
STANDARD-YASARGIL Pinzas para aplicar clips vasculares	154
STAUDE-MOORE Pinza para coger el cuello del útero	452
STEINMANN Clavos	654
STEINMANN Pinza para agarrar el tendón	647
STELLBRING Pinzas-gubias	632
STELZNER (CRAFOORD) Tijera para lobectomía y recto	99
STEVENS Tijeras finas de disección y tenotomía.	92
STIEGLITZ (WILLIAMS) Pinza para espinas	151
STILLE Cinceles	610
STILLE Cizallas para escayolas	677-678
STILLE Gubias	610
STILLE Osteótomos	610
STILLE Perforador de mano	651
STILLE Pinza-gubia	635
STILLE-BARRAYA Pinzas para vasos y tumores.	148
STILLE-CRAFOORD Pinzas hemostáticas finas	170
STILLE-DOYEN Separadores	247
STILLE-GIERTZ Costótomo	492
STILLE-LEKSELL Pinzas-gubias	635
STILLE-LUER Pinzas-gubias.	634, 636
STILLE-MAYO Tijeras de disección.	85
STILLE-MAYO Tijeras DURACUT de disección	48
STILLE-MINI Cizalla para escayolas	677
STILLE-RUSKIN Pinza-gubia	636
STILLE-STRANDELL Separadores para vainas tendinosas.	225
STOCKMANN Compresor uretral	426
STRANDELL-STILLE Separadores para vainas tendinosas.	225
STRATTE TITE GRIP Porta-agujas	347
STRAUSS Compresor uretal	426
STRULLY Tijera para neurocirugía	100
SUBRAMANIAN ATRAUMATIC-GRIP Pinzas-clamps para aorta	537
Sujetadores de mano.	644
SULLIVAN (BROPHY) Tijeras finas de disección.	93
SUPER Estetoscopio.	5
Surtido para enfermeras	18
SWEET-LAHEY Pinza de disección y ligaduras	189
SYSTRUNK Tijera para hender las uñas	81

T

TAKAHASHI Pinzas cortantes para laminectomía	714
Taladro para uñas	645
Taladros	652
Tambores de esterilización	743
TARNIER Fórceps	480
Tarros	737, 747
Tarros para prótesis dental.	751
TAYLOR Martillos de percusión	2
TAYLOR Valvas laterales para separadores.	287
TAYLOR-CUSHING Pinza de disección TITE GRIP	114
TAYLOR-CUSHING Pinza fina de disección.	131
TAYLOR-CUSHING Pinza fina quirúrgica.	143
TAYLOR-CUSHING Pinzas auriculares y nasales	136
TAYLOR-SCHMIEDEN Tijera para dura-madre	100
TEALE Pinza para coger el cuello útero	456
Tenotomos.	37
Tensor tierra-hilo	660
Tensor de alambres	658
THOMAS-PRICE Pinzas-clamps bronquiales.	566
THOMS-ALLIS Pinza intestinal y para tejidos	385

THOMS-GAYLOR Pinza saca-bocados para biopsia	460
THOREK Tijeras de disección	98
THOREK-METZENBAUM Tijeras DURACUT adnex	54
THORLAKSON ATRAUMATIC-GRIP Pinzas-clamps oclusiva inferior.	399
THORLAKSON ATRAUMATIC-GRIP Pinzas-clamps oclusiva superior.	398
THORLAKSON Separadores.	230
THORLAKSON Separadores para pelvis	256-257
Tijeras abdominales.	106
Tijeras cuticulares	16
Tijeras de disección	81-93, 95, 98
Tijeras DURACUT	54, 59
Tijeras DURACUT adnex	54
Tijeras DURACUT de disección	47-53
Tijeras DURACUT modelos standard.	46
Tijeras DURACUT nasales.	58
Tijeras DURACUT para cirugía	46
Tijeras DURACUT para el tabique nasal	59
Tijeras DURACUT para encías	55
Tijeras DURACUT para ginecología.	60
Tijeras DURACUT para iridectomía	45
Tijeras DURACUT para la cirugía del recto	59
Tijeras DURACUT para la cirugía plástica	45
Tijeras DURACUT para perineo	60
Tijeras DURACUT para vasos y fistulas.	45
Tijeras DURACUT parametrium	60
Tijeras DURACUT uterinas	60
Tijeras DURACUT vasculares	56-57
Tijeras enterótomos	109
Tijeras enterótomos para anatomía	109
Tijeras finas de disección.	93
Tijeras finas de disección y tenotomía	92
Tijeras finas DURACUT.	45
Tijeras finas para cirugía.	68-70
Tijeras nasales	101-102
Tijeras para ala nasal	81
Tijeras para amígdalas	103
Tijeras para arteria coronar	95
Tijeras para arteriotomía	95
Tijeras para cartílago	82
Tijeras para cirugía	71-83
Tijeras para decapitación	109
Tijeras para dura-madre.	100
Tijeras para el tabique nasal	102
Tijeras para encías	94
Tijeras para episiotomía.	107
Tijeras para hender las uñas	81
Tijeras para incisión.	80
Tijeras para la cirugía plástica.	70,82
Tijeras para la vena cava.	99
Tijeras para ligaduras	352-353
Tijeras para ligaduras DURACUT.	353
Tijeras para lobectomía y recto	99
Tijeras para nervio trigémio	100
Tijeras para nervios.	93
Tijeras para neurocirugía	100
Tijeras para operaciones	80
Tijeras para perineo	107
Tijeras para tela	674-675
Tijeras para uñas.	16
Tijeras para vasos y fistulas.	80
Tijeras para vendajes	672-674
Tijeras para vendajes DURACUT.	673
Tijeras para vendajes y tela	674
Tijeras umbilicales	108
Tijeras uterinas	104-106
Tijeras vasculares.	95-98
Tijeras-micro.	62-67
Tijeras-micro de disección	65
Tirabuzones para mioma	458
TISCHLER Pinzas saca-bocados para biopsia.	465
TISCHLER-BABY Pinza saca-bocados para biopsia	464
TISCHLER-MORGAN Pinza saca-bocados para biopsia	464
TITAN-LINE Clamps Bulldog.	160-161
TITAN-LINE Pinzas hemostáticas finas	166, 168
TITAN-LINE Porta-agujas PERFECT-GRIP	365
TITE GRIP Escofinas	596-597
TITE GRIP Micro-pinzas	118
TITE GRIP Micro-Porta-agujas	338-339
TITE GRIP Pinza de ligadura	113

TITE GRIP Pinzas	118
TITE GRIP Pinzas cierra-hilos	662
TITE GRIP Pinzas de disección	113-115
TITE GRIP Pinzas intestinales y para tejidos	388
TITE GRIP Pinzas para espinas	151
TITE GRIP Pinzas para extraer alambres	663
TITE GRIP Pinzas para tejidos y tirar uñas	116
TITE GRIP Pinzas quirúrgicas	117-118
TITE GRIP Porta-agujas	340-350
TITE GRIP Porta-agujas para zurdos	341
TOENNIS Cuchillo para dura-madre	37
TOENNIS Disecadores para dura-madre	700
TOENNIS Porta-agujas	371
TOENNIS Tijera para la cirugía y disección	83
TOENNIS TITE GRIP Porta-agujas	350
TOENNIS-ADSON Tijeras de disección	89
TOENNIS-ADSON Tijeras DURACUT de disección	49
TOENNIS-OLIVECRONA (SCOVILLE) Pinza para colocar grapas	690
TOHOKU Pinzas de campo	202
Torniquetes	518, 570
TOWNSEND Pinzas saca-bocados para biopsia	465
Tractor	479
Transformador	472
Transformador eléctrico pequeño para 220 voltios	11
Traqueotomía, juego	729-730
TRELAT Espéculos vaginales	431
TRELAT Periostótomo	582
Trépanos	669
Trépanos cutáneos	20
Trocars	318-320
Trocars para hidrocele y punción abdominal	318
Trocars para punción torácica	318
Trocars para vesícula biliar	318
Trocars traqueales	728
TROELTSCH (WILDE) Pinzas auriculares y nasales	137
TROEMNER Martillos de percusión	3
TROUSSEAU Dilatador para la tráquea	728
TROUTMAN Pinza para sujetar y romper hojas de afeitar	36
TROUTMAN-BARRAQUER Micro-Porta-agujas	360
TUBBS Dilatador de aorta	511
Tubos de plástico	473
Tubos nasales para aspiración	324
Tubos para aspiración	324-327
Tubos para aspiración intracardiaco	327
Tubos para aspiración vascular	327
Tubos para tunelar	517
Tubos-compresión	570
TUFFIER Espátula abdominal e intestinal	267
TUFFIER Separador costal	506
TUOHY Agujas para punción lumbar	328
TUTTLE (SINGLEY) Pinzas agarre del pulmón	149
TYRELL (GRAEFE) Ganchos para iris	216
TYRELL (GRAEFE) Ganchos para piel	216

U

UCKERMANN Porta-algodones	317
UECKERMANN-DENKER Trocars traqueales	728
UFFENORDE Cucharillas cortantes	601
ULRICH Cuchillo para fístulas	37
ULRICH Pinza para huesos	627
ULRICH Pinzas para vendajes y torundas	206
UNIVERSAL Cizalla corta-alambres	665
UNIVERSAL DURACUT Cizalla corta-alambres	665
UNIVERSAL Trocars	318
UNNA Saca-comedones	19
UNNA-VIDAL Saca-comedones	19
USA MOD. Cucharillas cortantes	601
USA MOD. Pinzas de disección	133
USA MOD. Separador para escayolas	682
USA MOD. Tijera umbilical	108
US-ARMY (PARKER-LANGENBECK) Separadores	231

V

VALLEIX Histerómetros	446
Valvas	293

Valvas laterales	287, 289
Valvas para separadores	308
Valvas para separadores abdominales KIRSCHNER	307
Valvas vaginales	434-437, 439
VAN BUREN Bujías dilatadoras	424
VAN BUREN Pinza para secuestro	623
VAN DOREN Pinza saca-bocados para biopsia	461
VANNAS Micro-tijeras	62-63, 65
VANNAS MOD. TÜBINGEN Micro-tijeras	62
VANNAS-YASARGIL Micro-tijeras	66
VARCO Pinzas hemostática finas	170
VASCULAR PERFECT-GRIP Porta-agujas	364
VASCULAR PERFECT-GRIP TITAN-LINE Porta-agujas	365
VASCULAR-RYDER TITE GRIP Micro-Porta-agujas	340
Vasos graduados	751
Venda-compresión	570
VERBRUGGE Pinzas para huesos	628
VERBRUGGE-MÜLLER Elevadores para huesos	579
VERESS Agujas para el neumoperitoneo	329
VERNET-GIL (MARBERGER) Separadores para venas y hilares	223
VICKERS Dispensador de agujas	657
VICKERS Separador de mano y túnel de carpo	271
VICKERS Separador para dedos	271
VICKERS Separador profundo para mano y antebrazo	271
VICKERS Sujetador de mano	644
VIDAL Legra para lupus	19
VIDAL-UNNA Saca-comedones	19
VIRCHOW Cuchillos para cerebro	40
VIRTUS (RALKS) Pinza para espinas	151
WISE Micro-pinzas de ligadura	122
VOGEL Cánula para punción del seno maxilar	319
VOLKMANN Cucharillas cortantes	600, 602, 606
VOLKMANN Separadores	233-234
VOLKMANN Separadores y separadores para huesos	232
VON PETZ Aparato para sutura estomacal e intestinal	404

W

WAGENER Ganchitos auriculares	213
WAGNER Elevador para huesos	577
WAGNER Martillo	620
WAGNER Periostótomos	591
WALB Cuchillo post mortem	40
WALDMANN Tijera para perineo (episiotomía)	107
WALTON-LISTON (BÖHLER) Pinzas cortantes para huesos	638
WANGENSTEEN Pinza de disección TITE GRIP	115
WANGENSTEEN Porta-agujas	369
WANGENSTEEN TITE GRIP Porta-agujas	347
WARTENBERG Algesímetro	4
WATSON-CHEYNE Disecador	574
WATSON-WILLIAMS Escofina	593
WAUGH Pinza fina de disección	131
WAUGH Pinza fina quirúrgica	143
WEBER ATRAUMATIC-GRIP Pinzas-clamps para anastomosis de aorta	548
WEBER Estesiometro	4
WEBSTER Porta-agujas	363
WEBSTER TITE GRIP Porta-agujas	342
WEIL-BLAKESLEY Pinzas cortantes para laminectomía	714
WEISSBARTH Espéculo vaginal	442
WEITLANER Separadores con retenida automática	272-274
WELLS-SPENCER Pinzas hemostáticas	173
WERTHEIM (BOZEMANN) TITE GRIP Porta-agujas	346
WERTHEIM Pinzas-clamps para histerectomía	194-195
WERTHEIM Tijeras uterinas	105
WERTHEIM-CULLEN Pinza-clamp para pedículo renal	191
WERTHEIM-DE BAKEY (ROGERS) ATRAUMATIC-GRIP Pinzas-clamps parametrium	197
WEST Cinceles	607
WEST Gubias	607
WIENER Escofinas	593
WIENER MOD. Porta-ligadura	378
WILLIAMS Pinza intestinal y para tejidos	388
WILDE (TROELTSCH) Pinzas auriculares y nasales	137
WILLETT Pinza para pericráneo	481
WILLIAMS (STIEGLITZ) Pinza para espinas	151
WILLIAMS-WATSON Escofina	593
WILLIGER Cucharillas cortantes	598, 600
WILLIGER Elevadores	574

WILLIGER Martillo	617
WILLIGER Periostótomos	582
WINTER Estetoscopio	5
WINTER Pinzas para aborto y placenta	482
WITTNER Pinza saca-bocados para biopsia	462
WOLFF Pinza para romper escayolas	682
WOLFSON-DE MARTEL Clamps para anastomosis del colón	402
WOLFSON-DE MARTEL Pinza para cerrar clamps	402
WOLFSON-DE MARTEL Porta-clamp	402
WOOD-CRILE Porta-agujas	366, 368
WOOD-CRILE TITE GRIP Porta-agujas	343
WOOD-CRILE TITE GRIP Porta-agujas para zurdos	341
WRIGLEY Fórceps	480
WULLSTEIN Aspirador micro	321
WULLSTEIN Cánula para aspiración	322
WULLSTEIN Separadores con retenida automática	275
WYLLIE ATRAUMATIC-GRIP Pinzas-clamps para anastomosis de aorta	549

Y

YANKAUER Tubos para aspiración	325-326
YASARGIL Cucharilla cortante	695
YASARGIL Cuchillo para vasos	695
YASARGIL Disecador	694
YASARGIL Ganchos con muelle para la fijación de la galea	691
YASARGIL Guía-ligadura	697
YASARGIL Legras	694-695
YASARGIL Micro-pinzas	125
YASARGIL Micro-tijeras de disección	67
YASARGIL Mirco-tijeras	66
YASARGIL PERFECT-GRIP Micro-Porta-agujas	362
YASARGIL Pinza para hipófisis	719
YASARGIL Pinzas de agarre para tejido y tumor	126
YASARGIL Tubos para aspiración	324
YASARGIL-MINI Clips vasculares	154
YASARGIL-MINI Pinzas para aplicar clips vasculares	154
YASARGIL-SAMII Pinza de agarre para tejido y tumor	126
YASARGIL-STANDARD Clips vasculares	154
YASARGIL-STANDARD Pinzas para aplicar clips vasculares	154
YASARGIL-VANNAS Micro-tijeras	66
YEOMAN Pinzas saca-bocado para biopsia rectal	412
YOUNG Gancho para el bulbus	422
YOUNG Pinza tira-lengua	23
YOUNG Separadores para la prostata	422
YOUNGE-KEVOURKIAN Curetas para biopsia endo-cerviz	459
YOUNGE-KEVOURKIAN Pinzas saca-bocados para biopsia	463, 465
YOUNG-HRYNTSCHAK Porta-agujas de bumerang	372
YOUNG-MILLIN Porta-agujas de bumerang	372

Z

ZAUFAL-JANSEN Pinza-gubia	633
ZENKER Pinzas de disección y ligaduras	188
ZENKER Separadores para cirugía profunda	259
ZIEGLER Cinta	10
ZIEGLER Espejo frontal	10
ZIELKE Gubias	614
ZOELLNER Aspirador micro	321
ZWEIFEL TITE GRIP Porta-agujas	349

A

- Abaisse-langue en bois 12
 Abaisse-langues 12
 Abdominaux et intestinaux, Spatules 266-267
 Abdominaux, Ecarterus 297-309
ABRAMS Aiguille à ponction pleurale 518
ABRAMS Aiguille pour la ponction de la plèvre 329
 Accessoires pour écarteurs autofixants de **LEYLA** 703, 705
 Accessoires pour écarteurs **LEYLA** 705
ADAIR-ALLIS Pince à préhension de l'intestin 384
ADAIR Pince pour abaissement du col de l'utérus 452
ADAMS-MAYO Ecarteurs pour appendicectomie 284
ADLERKREUTZ Pincers vaisseaux et tumeurs 148
 Adnex, Ciseaux **DURACUT** 54
ADSON-ANDERSON Ecarteur autostatique 276
ADSON-ANDERSON Ecarteur pour laminectomie 276
ADSON-BABY Pincers à disséquer et à ligatures 180
ADSON-BECKMANN Ecarteurs autostatiques 279
ADSON-BROWN Pincers fines chirurgicales 141
ADSON-BROWN TITE GRIP Pincers à dissection à griffes 117
ADSON-MICRO Pincers fines à dissection 129
ADSON-MICRO Pincers fines chirurgicales 140-141
ADSON-MICRO TITE GRIP Pincers à dissection à griffes 117
ADSON-TOENNIS Ciseaux à dissection 89
ADSON-TOENNIS Ciseaux à dissection **DURACUT** 49
ADSON Canules d'aspiration 323
ADSON Crochets à nerfs et à vaisseaux 215
ADSON Ecarteur pour laminectomie 280
ADSON Ecarteurs autostatiques 273, 276, 278
ADSON Ecarteurs pour hemilaminectomie 277
ADSON Mèche hélicoidales 652
ADSON Pince-guide et pour protéger la dure-mère 650
ADSON Pincers fines à dissection 129
ADSON Pincers fines chirurgicales 140-141
ADSON Pincers hémostatiques fines 169
ADSON Porte-aiguilles 367
ADSON Rugine-raspatoire 586
ADSON TITE GRIP Pincers à dissection 113
ADSON TITE GRIP Pincers à dissection à griffes 117
 Aesthésiomètre 4
 Agrafes 379, 404
 Agrafes en argent 690
 Agrafes hémostatiques pour cuir chevelu 691
 Agrafes, Fil d'argent pour fabriquer des agrafes 690
 Agrafes, Pincers à poser 379
 Aiguille à hypodermique 486
 Aiguille à ponction pleurale 518
 Aiguille pour la ponction aveugle du foie 329
 Aiguille pour la ponction contrôlée du foie 329
 Aiguille pour la ponction du la plèvre 329
 Aiguille trompette guide 486
 Aiguilles à biopsie 518
 Aiguilles à ligatures 374-376
 Aiguilles à ponction sternale 518
 Aiguilles à suture, Support pour stériliser 736
 Aiguilles à sutures 354-356
 Aiguilles de **REVERDIN** 373
 Aiguilles et tissus, TITE GRIP Pincers pour saisir et tirer 116
 Aiguilles guides 334
 Aiguilles intestinales 354
 Aiguilles passe-fils 660
 Aiguilles pour amygdales 328
 Aiguilles pour la cloison nasale 328
 Aiguilles pour la pneumopéritone 329
 Aiguilles pour ophtalmologie 354
 Aiguilles pour ponction lombaire 328
 Aiguilles spéciales 328
 Aiguilles vasculaires 354
 Aiguilles vasculaires pour irrigation 322
 Ailes du nez, Ciseaux 81
ALAN-PARK Ecarteur rectal 408
ALDERDYCE Dissecteur 574
ALDINGER-HOHMANN Levier à os 580
 Alésiors pour étrier traction crânienne de **CRUTCHFIELD** 689
ALEXANDER-FARABEUF Rugines à costales 497
ALEXANDER Ciseaux-burins 609
ALEXANDER Gouges 609
ALEXANDER Ostéotomes 609
ALEXANDER Pince emporte-pièces à biopsie 463
 Algésimètres 4
ALLEN Pincers-clamps intestinales 390
ALLIS-ADAIR Pince à préhension de l'intestin 384
ALLIS-BABY Pince à préhension de l'intestin 383
ALLIS-BOYS Pince à préhension de l'intestin 384
ALLIS-JUDD Pincers à préhension de l'intestin 384
ALLIS-OCBSNER Pince à préhension de l'intestin 383
ALLIS-THOMS Pince à préhension de l'intestin 385
ALLIS ATRAUMATIC-GRIP Pincers à préhension de l'intestin 389
ALLIS Pincers à préhension de l'intestin 383-385
ALLISON Spatule pulmonaire 260
ALM Ecarteurs autostatiques 270
ALY Algésimètre 4
AMANN Conducteur porte-tampon 447
 Amnioscopes 472
 Amnioscopie, Instrumentation 472-473
 Amniotome 477
 Amputation 570
 Amputation et résection, Scies 572, 573
 Amygdales et hémostatiques, Pincers 179
 Amygdales, Aiguilles 328
 Amygdales, ciseaux 103
 Anastomose de l'aorte, Pincers-clamps avec denture **DE BAKEY** 548, 549
 Anastomose du rectum, Pincers-clamps 400
 Anastomose du rectum, Pincers-clamps ATRAUMATIC-GRIP 401
 Anastomose et intestinales, Pincers-clamps 402
 Anastomose, Clamps 402
 Anastomose, Pincers-clamps 520-523
 Anastomose, Pincers-clamps (veine cave) 565
 Anastomose, Pincers-clamps avec denture **COOLEY** 559-560
 Anastomose, Pincers-clamps avec denture **DE BAKEY** 542-544
 Anatomie, Ciseaux-entérotomes 109
ANDERSON-ADSON Ecarteur autostatique 276
ANDERSON-ADSON Ecarteur pour laminectomie 276
ANDREW-PYNCHON Canule d'aspiration 325
 Anévrisme de l'aorte, Pince-clamp 561
 Anévrisme de l'aorte, Pincers-clamps avec denture **DE BAKEY** 545-547
 Anus et rectum, Dilatateurs 407-408
 Anusscopes 407
 Aorte, Pince-clamp 561
 Aorte, Pince-clamp pour anévrisme 561
 Aorte, Pincers-clamps 537
 Aorte, Pincers-clamps avec denture **DE BAKEY** 538-540
 Aortiques, Dilatateurs 511
 Appareil à suture 404
 Appareil compressif 570
 Appareil et crayons pour marquer et écrire sur métal, verre, plastique etc. 757
 Appareils pâtés, Couteaux 679
 Appareils plâtrés et étoffes d'habillement, Cisailles 675
 Appareils plâtrés, Cisailles 676-678
 Appareils plâtrés, Scie 679
 Appendicectomie, Ecarteurs 284
 Appendicectomie, Ecraseur et clamp 403
 Applicateurs pour clips vasculaires 154-155
 Approximateurs 157-159
 Approximateurs, Pincers 158
ARMY-US (PARKER-LANGENBECK) Ecarteurs 231
ARMYTAGE-GREEN Pince-clamp utérine pour hémostase 481
 Artériotomie, Ciseaux 95
ARTHUR Pince à échardes 151
 Articles pour infirmières 751
 Articulation sphérique pour fixation du bras 705
 Aspirateurs ligateurs pour hémorroïdes 411
 Aspiration et biopsie, Curettes 471
 Aspiration, Canules 320-327
 Aspiration, Curettes 471
 ATRAUMATIC-GRIP Clamps Bulldog avec denture **DE BAKEY** 525-528
 ATRAUMATIC-GRIP Clamps patent-ductus avec denture **DE BAKEY** 531
 ATRAUMATIC-GRIP Pince à préhension de l'intestin 389
 ATRAUMATIC-GRIP Pincers-clamps à anastomose
 avec denture **COOLEY** 559-560
 ATRAUMATIC-GRIP Pincers-clamps à anastomose avec
 denture **DE BAKEY** 542-544
 ATRAUMATIC-GRIP Pincers-clamps à anastomose du rectum 401
 ATRAUMATIC-GRIP Pincers-clamps à bronches avec
 denture **DE BAKEY** 552
 ATRAUMATIC-GRIP Pincers-clamps à occlusion 398-399

ATRAUMATIC-GRIP Pincés-clamps intestinales	391-393, 395-396
ATRAUMATIC-GRIP Pincés-clamps pour anastomose de l'aorte avec denture DE BAKEY	548-549
ATRAUMATIC-GRIP Pincés-clamps pour anévrisme de l'aorte avec denture DE BAKEY	545-547
ATRAUMATIC-GRIP Pincés-clamps pour aorte avec denture DE BAKEY	538-540
ATRAUMATIC-GRIP Pincés-clamps pour coarctation avec denture COOLEY	557
ATRAUMATIC-GRIP Pincés-clamps pour coarctation avec denture DE BAKEY	532-533
ATRAUMATIC-GRIP Pincés-clamps pour la carotide avec denture LAWTON	524
ATRAUMATIC-GRIP Pincés-clamps pour veine cave avec denture DE BAKEY	550
ATRAUMATIC-GRIP Pincés-clamps stomacales	397
ATRAUMATIC-GRIP Pincés-clamps universelles avec denture DARDIK	554
ATRAUMATIC-GRIP Pincés-clamps universelles avec denture DE BAKEY	553
ATRAUMATIC-GRIP Pincés-clamps vasculaires périphériques avec denture DE BAKEY	535-536
ATRAUMATIC-GRIP Pincés à disséquer et à ligatures avec denture DE BAKEY	551
ATRAUMATIC-GRIP Pincés vasculaires	135
ATRAUMATIC-GRIP Pincés vasculaires	520
ATRAUMATIC-GRIP Pincés vasculaires avec denture COOLEY	555-562
ATRAUMATIC-GRIP Pincés vasculaires avec denture DE BAKEY	529-530, 537, 554
ATRAUMATIC-GRIP Pincés vasculaires avec denture LAWTON	521-523
ATRAUMATIC-GRIP Pincés vasculaires pour occlusion tangentielle	541
Atrium, Ecarteurs	509
AUFRICHT Ciseaux pour chirurgie plastique	82
AUFRICHT Râpes	593
Aiguilles à biopsie	329
Auriculaires et nasales, Pincés	136-137
Auriculaires, Pincés-clamps	564
Auriculaires, Sondes	322
AUSTIN Micro-pincés à ligatures	122
AUVARD-BERLIND Spéculum vaginal	441
AUVARD Spéculums vaginaux	441
Avortement et placenta, Curettes	484

B

BABCOCK ATRAUMATIC-GRIP Pincés à préhension de l'intestin	389
BABCOCK Pincés à préhension de l'intestin	385, 388-398
BABY-ADSON Pincés à disséquer et à ligatures	180
BABY-ALLIS Pince à préhension de l'intestin	383
BABY-BAILEY Rapprocheur de côtes	508
BABY-BALFOUR Ecarteur abdominal	300
BABY-COLLIN Ecarteur abdominal	297
BABY-CRILE Pincés hémostatiques fines	166
BABY-DOYEN ATRAUMATIC-GRIP Pincés-clamps intestinales	391
BABY-FINOCHIETTO-HAIGHT Ecarteur à côtes en ALUMINIUM	501
BABY-FINOCHIETTO Ecarteur à côtes	503
BABY-GILLIES Porte-aiguilles avec ciseaux	370
BABY-GILLIES TITE-GRIP Porte-aiguilles	348
BABY-GOSSET Ecarteur abdominal	299
BABY-KELLY Pincés hémostatiques fines	168
BABY-KOCHER ATRAUMATIC-GRIP Pincés-clamps intestinales	391
BABY-LEXER Ciseaux à dissection	87
BABY-MEEKER Pincés à disséquer et à ligatures	180
BABY-METZENBAUM Ciseaux à dissection	89
BABY-MIKULICZ Pincés-clamps pour péritoine	192
BABY-MIXTER Pincés à disséquer et à ligatures	180
BABY-MOSQUITO (HARTMANN) Pincés hémostatiques fines	164
BABY-OLSEN-HEGAR TITE-GRIP Porte-aiguilles	348
BABY-OVERHOLT Pincés à disséquer et à ligatures	183
BABY-PAYR Pince-clamp et écreuseur pour l'intestin et l'estomac	403
BABY-ROUX Ecarteur double	228
BABY-SATINSKI Pincés-clamps à anastomose (veine cave)	565
BABY-TISCHLER Pince emporte-pièces à biopsie	464
BACKHAUS Pincés à compresses	201
BADGLEY Ecarteur pour laminectomie	286
BAHNSON-DE BAKEY ATRAUMATIC-GRIP Pincés-clamps pour anévrisme de l'aorte	545
BAILEY-BABY Rapprocheur de côtes	508
BAILEY-GIBBON Rapprocheur de côtes	508

BAILEY ATRAUMATIC-GRIP Pincés-clamp pour aorte avec denture DE BAKEY	538
BAILEY Rapprocheur de côtes	508
Bâillon	22
BAINBRIDGE-DE BAKEY ATRAUMATIC-GRIP Pincés vasculaires	530
BAINBRIDGE Pincés-clamps intestinales	390
BAKES Jeux de dilateurs biliaires	416
BALFOUR-BABY Ecarteur abdominal	300
BALFOUR-KIRSCHNER Valves pour écarteurs abdominaux	307
BALFOUR Ecarteurs abdominaux	300-303
BALFOUR modif. Ecarteurs abdominaux	302
BALLENGER-FOERSTER Pincés à tampons et éponges	209
BALLENTINE-HEANEY Pince à hystérectomie	196
BALLENTINE Pincés à hystérectomie	196
Bande compressive	570
Bandeau frontal en celluloid blanc	10
Bandeau frontal plastique noir	10
Bandeaux frontaux	10
BARNES Canule d'aspiration	321
BARR Dilatateur pour anus et rectum	408
BARRAQUER-TROUTMAN Micro-Porte-aiguilles	360
BARRAQUER Micro-Porte-aiguilles	360
BARRAQUER Pince à épiler	152
BARRAYA-STILLE Pincés vaisseaux et tumeurs	148
BARRETT Pince pour abaissement du col de l'utérus	452
BARTH Curette	599
Bases de fixation	703
Bassins	748
Bassins de lit	750
Bassins réniformes	750
Bassins triangulaires	750
BAUMGARTNER-HEGAR TITE GRIP Porte-aiguilles	342
BAUMGARTNER Porte-aiguilles	366
BAUMGARTNER TITE GRIP Porte-aiguilles	342
BEACHAM Amniotome	477
BECK-COOLEY ATRAUMATIC-GRIP Pincés-clamps à anastomose	560
BECK-DE BAKEY ATRAUMATIC-GRIP Pincés-clamps à anastomose	543
BECK-DE BAKEY ATRAUMATIC-GRIP Pincés-clamps pour veine cave	550
BECK-DE BAKEY Pince-clamp pour aorte	537
BECKMANN-ADSON Ecarteurs autostatiques	279
BECKMANN-EATON Ecarteur pour laminectomie	280
BECKMANN Ecarteur pour laminectomie	280
BEEBEE Pincés coupe-fils	665
BEER Pince à épiler	152
BELMONT-RUMEL Tourniquets	518
BENGOLEA Pincés hémostatiques fines	172
BENNETT Leviers à os	581
BENSON Ecarteur du pylore	403
BERGER Loupes binoculaires frontales	8
BERGER Pince emporte-pièces à biopsie	462
BERGMANN Cisailles pour étoffes d'habillement et appareils plâtrés	675
BERGMANN Maillets	621
BERLIND-AUVARD Spéculum vaginal	441
BERLINER Marteaux à réflexes	2
BERNHARD Pincés à compresses	201
BETHUNE Costotome	493
BEYER Pince emporte-pièces à laminectomie	707
BEYER Pincés-gouges	632-633
BIEMER-MÜLLER Approximateurs	157
BIEMER Micro-ciseaux pour veines	63
BIEMER Serre-Fines	156
BIER Scie à amputation et résection	573
Biliaires, Dilatateurs	416
Biliaires, Dilatateurs à voies	415
BILL Forceps	479
Billes, Manche	721
Biopsie endo-cervicale, Curettes	460
Biopsie et aspiration, Curettes	471
Biopsie osseuse, Instruments	669
Biopsie rectale, Pincés	412
Biopsie vertébral, Set CRAIG-KOLGER	720-721
Biopsie, Aiguilles	329
Biopsie, Aiguilles	518
Biopsie, Curettes	459-460
Biopsie, Pince emporte-pièces	460-465
BIRCHER-GANSKE Pincés à ménisque et cartilage	640
BIRCHER Bistouris à ménisque	643
Bistouris	37, 40
Bistouris à autopsie	40

- Bistouris à ménisque. 642-643
 Bistouris pour plastie du nez 37
BLAKE-MAYO Pincés pour calculs biliaires 418
BLAKE Curette utérine 466
BLAKE Pincés pour calculs biliaires 418
BLAKESLEY-WEIL Pincés emporte-pièces à laminectomie 714
BLESSING Ciseaux pour chirurgie rectale DURACUT 59
BLOUNT Ecarteurs pour genou 641
BLOUNT Elévateur pour la hanche 580
BLUMENTAHL Pincés-gouges 631
BLUNT Epingle à instruments 736
BOETTCHER Ciseaux pour les amygdales 103
BÖHLER (LISTON-WALTON) Pincés coupantes 638
BÖHLER Etriers à extension 654
BÖHLER Pincés-gouges 633
 Boîte ronde pour instruments de micro-chirurgie 737
 Boîtes pour instruments 746
 Boîtes pour stérilisation 739-741
 Boîtes pour stérilisation en plastique 742
 Boîtes pour stérilisation et coservation 738
 Boîtes pour stériliser des aiguilles de suture 357
 Boîtes rondes pour stérilisation 743
BONN (MOD.) Pincés fines chirurgicales 138
BONNEY Pincés à dissection 134
BONNEY Pincés chirurgicales 147
BONNEY TITE GRIP Pince 118
BONNEY TITE GRIP Pince à dissection 115
 Boomerangs, Porte-aiguilles 372
BOSE Ecarteurs pour trachéotomie 728
 Bougies dialatatrices 424
BOYS-ALLIS Pince à préhension de l'intestin 384
BOZEMANN-DOUGLAS Pincés à pansements 208
BOZEMANN (WERTEHIM) TITE GRIP Porte-aiguilles 346
BOZEMANN Pincés à pansements 208
BRAND Conducteurs à tendons 648
 Bras de fixation à l'articulation sphérique 705
 Bras flexible pour fixation aux têtes d'accouplement 703
BRAUN-SIMPSON Forceps 478
BRAUN-STADLER Ciseaux à périnée 107
BRAUN Cranioclaste 485
BRAUN Crochet pour décapitation 485
BRAUN Dépresseur utérin 447
BRAUN Pincés pour abaissement du col de l'utérus 452, 454
BRAWLEY Râpe 593
BREISKY Spécimens vaginaux 438, 440
BRIDGE Pincés à disséquer et à ligatures 187
BRINKERHOFF Spécimens rectaux 406
 Broches-tire, Pincés 663-664
 Broches filiformes, Distributeurs 657
 Broches, Distributeurs 656
BROHPY Pincés fines à dissection 131
 Bronches, Pincés-clamps 566
 Bronches, pincés-clamps ATRAUMATIC-GRIP 552
BROPHY (SULLIVAN) Ciseaux fins à dissection 93
BROPHY Pincés fines chirurgicales 143
 Brosse à nettoyer les canules trachéales 727
 Brosse à ongles 752
 Brosses et essuie-mains, Paniers 753
 Brosses, Distributeurs 752
BROWN-ADSON Pince fine chirurgicale 141
BROWN-ADSON TITE GRIP Pincés à dissection à griffes 117
BROWN Pincés chirurgicales 148
BROWN Porte-aiguilles 366
BROWNE-DENIS Ecarteur abdominal 305
BRUENINGS Abaisse-langue 12
BRUNNER Ecarteurs pour interventions en profondeur 252-253
BRUNNER Pince-clamp à anastomose du rectum 400
BRUNS Cisailles pour appareils plâtrés 676
BRUNS Curettes 602-603
BUCHWALD Abaisse-langue 12
BUCK-GRAMCKO Levier à os 576
BUCK Marteaux à réflexes 3
BUIE-SMITH Dilatateur pour anus et rectum 408
BUIE Pince-clamp à pression 409
 Bulbus, Crochet 422
BULEAU Trocart 318
 Bulldog Clamps 163, 556
 Bulldog, Clamps avec denture **DE BAKEY ATRAUMATIC-GRIP** 525-528
 Bulldog, Clamps TITAN-LINE 160-161
 Bulldog, Micro Clamps 162
BUMM Curettes à avortement et placenta 484
BUMM Curettes utérines 470
BUNNELL Conducteur à tendons 646
BUNNELL Perforateur à mainvèle 653
BUNNELL Strippers à tendons 646
BURFORD-FINOCHIETTO Ecarteurs à côtes 503
BURFORD-FINOCHIETTO Ecarteurs à côtes en ALUMINIUM 502
 Burins-ciseaux 607, 609-610, 613-614
 Burins-ciseaux et gouges avec manche en „Ferrozell“ 614
 Burins-ciseaux spongieuse 615
 Burins-ciseaux, ostéotomes et gouges avec manche en „Ferrozell“ 611-613
BURKE Pince emporte-pièces à biopsie 464
BUSH Ciseaux pour le cordon ombilical 108
 Bypass, Tunnelisateur 517

C

- Cadres de Stérilisation 737
 Calculs biliaires, Curettes 417
 Calculs biliaires, Pincés 418-419
 Calculs rénaux, Pincés 420-421
CALNE ATRAUMATIC-GRIP Pincés-clamps pour veine cave 550
CANAD.MODELL Bistouris à ménisque 643
 Canal lacrymal, Stylets 312
CANNON Couteau pour la tunique interne 513
CANNON Sondes à endartérectomie 514
CANNON Spatule pour la tunique interne 513
 Canule de trocart 721
 Canules d'aspiration 320-327
 Canules d'irrigation 322
 Canules parlantes 726-727
 Canules pour la trachéotomie 725-727
CAPLAN Ciseaux pour septum DURACUT 59
 Capsules, Pince pour saisir 423
CARMALT-ROCHESTER Pincés hémostatiques 178
CAROLL Porte-aiguilles 366
 Carotide, Pincés-clamps 527, 537
 Carotide, Pincés-clamps avec denture **LAWTON ATRAUMATIC-GRIP** 524
CAROTIS-DE BAKEY ATRAUMATIC-GRIP Clamp Bulldog 525
 Carrées-pointes 650
CARROLL Conducteur à tendons 648
CARROLL TITE GRIP Porte-aiguilles 344
 Cartilage et ménisque, Pincés 640
 Cartilage, Ciseaux 82
CASPAR Crochets à nerfs et à vaisseaux 215
CASPAR Ecarteur pour chirurgie lombaire 294-295
CASPAR Ecarteurs 245
CASPAR Ecarteurs pour colonne vertébrale 288, 290-292
CASPAR Pincés emporte-pièces à laminectomie 718-719
CASPAR Rugines-raspatoires 585
CASTANEDA Ecarteurs à côtes en ALUMINIUM 500
CASTANEDA Pincés-clamps pour anastomose 520
CASTANEDA Pincés-clamps universelles 520
CASTROVIEJO-MICRO Micro-Porte-aiguilles 358
CASTROVIEJO Compas 7
CASTROVIEJO Pincés fines chirurgicales 138
CASTROVIEJO Pincettes pour saisir et casser les lames de rasoir 36
CASTROVIEJO Porte-aiguilles 363
CASTROVIEJO TITE GRIP Micro-Porte-aiguilles 338-339
 Catgut, fils 353
 Cathéters et tubes, Pince conductrice 473
CATLIN Couteau à amputation 38
 Cérébrales, Spatules 706
 Cerlage, Fil 660
 Cerlage, Instruments 660
 Césarienne, Levier à tête utilisé 481
 Champs en papier, Pincés 202
CHAMPY Instruments pour biopsie osseuse 669
CHAPUT Pince à préhension de l'intestin 383
CHARRIERE Scies à amputation et résection 572-573
 Chasse-greffons 606
CHEATTLE Pincés à stérilisation 734
CHERON Pincés à pansements et tampons 207
 Chevalets de stérilisation 737
CHEVALIER-JACKSON Canules pour la trachéotomie 726
CHEVALIER Ecarteur à côtes 507
CHEYNE-WATSON Dissecteur 574

CHILDE Pincés à affronter	378	Ciseaux vasculaires et pour fistules	80
Chirurgicales, Pincés	144-148	Ciseaux vasculaires et pour fistules DURACUT	45
Chirurgicales, Pincés fines	138-143	Ciseaux, Porte-aiguilles	370
Chirurgie laser, Instruments	448-451	CITELLI Pincés emporte-pièces à laminectomie	707
Chirurgie lombaire, Ecarteurs	294-295	Clamp-pince à pression	409
Chirurgie plastique, Ciseaux	70, 82	Clamp-pince musculaire	728
Chirurgie plastique, Crochet	217-218	Clamp-pince périphérique	558
Chirurgie, Ciseaux	71-83	Clamp-pince pour anévrisme de l'aorte	561
Chirurgie, Ciseaux modèles fins	78-79	Clamp-pince pour aorte	561
Chirurgie, Ciseaux modèles standard	72-77	Clamp-pince pour la carotide	537
Circoncision, Instruments	426	Clamp et écreuseur à appendicectomie	403
Cisaille et ciseau-burins à sternum	492	Clamp patent-ductus droit	556
Cisailles à pansements et étoffes d'habillement	674	Clamps-pincés à anastomose (veine cave)	565
Cisailles pour appareils plâtrés	676-678	Clamps-pincés à anastomose avec denture COOLEY	559-560
Cisailles pour étoffes d'habillement et appareils plâtrés	675	Clamps-pincés à anastomose avec denture DE BAKEY	542-544
Ciseau-burins et cisaille à sternum	492	Clamps-pincés à anastomose du rectum	400
Ciseaux-burins	607, 609-610, 613-614	Clamps-pincés à anastomose du rectum ATRAUMATIC-GRIP	401
Ciseaux-burins et gouges avec manche en „Ferrozell“	614	Clamps-pincés à bronches	566
Ciseaux-burins spongieuse	615	Clamps-pincés à bronches ATRAUMATIC-GRIP	552
Ciseaux-burins, ostéotomes et gouges avec manche en „Ferrozell“	611-613	Clamps-pincés à occlusion ATRAUMATIC-GRIP	398-399
Ciseaux-entérotomes	109	Clamps-pincés auriculaires	564
Ciseaux-entérotomes pour l'anatomie	109	Clamps-pincés avec denture DE BAKEY ATRAUMATIC-GRIP	538-540
Ciseaux-Micro	62-67	Clamps-pincés iliaques	558
Ciseaux-micro pour veines	63	Clamps-pincés intestinales	390-394
Ciseaux (à épisiotomie) et à périnée	107	Clamps-pincés intestinales ATRAUMATIC-GRIP	395
Ciseaux à artériotomie	95	Clamps-pincés intestinales et à anastomose	402
Ciseaux à chirurgie	71-83	Clamps-pincés pour anastomose	520-523
Ciseaux à chirurgie DURACUT	46	Clamps-Pincés pour anastomose de l'aorte ATRAUMATIC-GRIP	548-549
Ciseaux à chirurgie et à dissection	81-83	Clamps-pincés pour anévrisme de l'aorte ATRAUMATIC-GRIP	545-547
Ciseaux à chirurgie modèles fins	78-79	Clamps-pincés pour aorte	537
Ciseaux à chirurgie modèles standard	72-77	Clamps-pincés pour coarctation ATRAUMATIC-GRIP	557
Ciseaux à chirurgie modèles standard DURACUT	46	Clamps-pincés pour fémorale	534
Ciseaux à détroncation	109	Clamps-pincés pour hémorroïdes	410
Ciseaux à dissection	81-93, 98	Clamps-pincés pour la carotide	527
Ciseaux à dissection avec grands anneaux ergonomiques	88	Clamps-pincés pour la carotide ATRAUMATIC-GRIP	524
Ciseaux à dissection des nerfs	93	Clamps-pincés pour l'intestin et l'estomac	403
Ciseaux à dissection DURACUT	47-54	Clamps-pincés pour occlusion tangentielle	562
Ciseaux à dissection et à chirurgie	81-83	Clamps-pincés pour pédicules rénaux	191
Ciseaux à envies	16	Clamps-pincés pour péritoine	192-193
Ciseaux à épisiotomie DURACUT	60	Clamps-pincés pour veine cave ATRAUMATIC-GRIP	550
Ciseaux à fendre les ongles	81	Clamps-pincés universelles	520-523, 530, 562
Ciseaux à incision	80	Clamps-pincés universelles ATRAUMATIC-GRIP	553-554
Ciseaux à ligaments larges DURACUT	60	Clamps-pincés vasculaires périphériques	534
Ciseaux à ligatures	352-353	Clamps-pincés vasculaires périphériques ATRAUMATIC-GRIP	535-536
Ciseaux à lobectomie et pour le rectum	99	Clamps Bulldog	163, 556
Ciseaux à ongles	16	Clamps Bulldog avec denture DE BAKEY ATRAUMATIC-GRIP	525-528
Ciseaux à pansements	672-673	Clamps Bulldog TITAN-LINE	160-161
Ciseaux à périnée (à épisiotomie)	107	Clamps Bulldog, Pince pour poser et retirer	527
Ciseaux chirurgicaux fins	68-70	Clamps Micro Bulldog	162
Ciseaux coronaires	95	Clamps patent-ductus avec denture DE BAKEY ATRAUMATIC-GRIP	531
Ciseaux DURACUT à iridectomie	45	Clamps pour anastomose	402
Ciseaux fins à dissection	92-93	Clamps pour le cordon ombilical	486
Ciseaux fins à dissection avec grands anneaux ergonomiques	92	Clamps rénaux	190
Ciseaux fins à dissection et à ténctomie	92	CLAR Eclairéur frontal complet	11
Ciseaux fins DURACUT	45	Clef plate pour étrier à extension	659
Ciseaux fistule et vasculaire DURACUT	45	Clés à vis pour scie oscillante	681
Ciseaux nasaux	101-102	CLEVELAND Pincés coupantes	637
Ciseaux nasaux DURACUT	58	Clips vasculaires, Applicateurs	154-155
Ciseaux pour ailes du nez	81	Clips vasculaires, Pincés	156
Ciseaux pour cartilage	82	Cloison des fosses nasales, Ciseaux	102
Ciseaux pour chirurgie plastique	70, 82	Cloison nasale, Aiguilles	328
Ciseaux pour chirurgie rectale DURACUT	59	Clous	654
Ciseaux pour gencive	94	CLOWARD Ecarteurs pour colonne cervicale	285
Ciseaux pour gencive DURACUT	55	CLOWARD Ecarteurs pour corps vertébraux	296
Ciseaux pour gynécologie DURACUT	60	COAKLEY Trocart pour la ponction du sinus maxillaire	319
Ciseaux pour interventions en profondeur	106	Coarctation, Pincés-clamps avec denture COOLEY	557
Ciseaux pour la chirurgie plastique DURACUT	45	Coarctation, Pincés-clamps avec denture DE BAKEY	532-533
Ciseaux pour la cloison des fosses nasales	102	COBB Gouge spinale	616
Ciseaux pour la neuro-chirurgie	100	COBB Rugines-raspatoires	589
Ciseaux pour la veine cave	99	COBB Rugines-raspatoires avec manche en „Ferrozell“	591
Ciseaux pour le cordon ombilical	108	Col de l'utérus, Pincés pour abaissement	452-456
Ciseaux pour le nerf trigéminal	100	COLCLOUGH (LOVE-KERRISON) Pincés emporte-pièces à laminectomie	710-711
Ciseaux pour les amygdales	103	COLLER-CRILE Pincés hémostatiques fines	167
Ciseaux pour opérations	80	COLLIER Porte-aiguilles	363
Ciseaux pour septum DURACUT	59	COLLIN-BABY Ecarteur abdominal	297
Ciseaux utérins	104-106	COLLIN-DUVAL Pince intestinale	149
Ciseaux utérins DURACUT	60	COLLIN-DUVAL Pincés à préhension de l'intestin	386
Ciseaux vasculaires	95-98	COLLIN-FARABEUF Rugines-raspatoires	588
Ciseaux vasculaires DURACUT	56-57		

- COLLIN-HARTMANN** Ecarteur double 229
COLLIN-LANDAU Spéculum vaginaux 431
COLLIN ATRAUMATIC-GRIP Pincés à préhension de l'intestin 389
COLLIN Clamp pour le cordon ombilical 486
COLLIN Dynamomètre pour adultes 6
COLLIN Ecarteurs abdominaux 297-298
COLLIN Ecarteurs doubles 227
COLLIN Maillets 617
COLLIN Pince à préhension de l'intestin 386
COLLIN Pince à retirer les agrafes 379
COLLIN Pince hystérolabe 458
COLLIN Pince tire-langue 23
COLLIN Pincés à pansements et tampons 207
COLLIN Spéculum vaginaux 431
 Colonne cervicale, Ecarteurs 285
 Colonne vertébrale, Ecarteurs 288, 290-292
 Combinaison couvercle/pince 735
 Compas 7
 Compresses, Pincés 200-202
 Compresseur de l'urètre 426
 Compressif, Appareil 570
 Compressif, Tube 570
 Compressive, Bande 570
 Conducteur porte-tampon 447
 Conducteur pour scies 687
 Conducteurs à tendons 646, 648
CONE Pince crânienne 688
CONTOUR SCALP Ecarteurs autostatiques 276
CONVERSE GILLIES Crochets à peau 216
CONVERSE TITE-GRIP Porte-aiguilles 342
COOLEY-BECK ATRAUMATIC-GRIP Pincés-clamps à anastomose 560
COOLEY-DERRA ATRAUMATIC-GRIP Pincés-clamps à anastomose 559
COOLEY-REYNOLDS ATRAUMATIC-GRIP Pincés-clamps à anastomose 559
COOLEY ATRAUMATIC-GRIP Pincés-clamps à anastomose 560
COOLEY ATRAUMATIC-GRIP Pincés-clamps pour coarctation 557
COOLEY ATRAUMATIC-GRIP Pincés vasculaires 555
COOLEY Canules d'aspiration 327
COOLEY Clamps Bulldog 556
COOLEY Clamps patent-ductus droit 556
COOLEY Dilatateur aortique 511
COOLEY Dilatateurs vasculaires 510
COOLEY Ecarteur à sternotomie 499
COOLEY Ecarteurs à sternotomie en ALUMINIUM 498
COOLEY Ecarteurs atrium 509
COOLEY Pince-clamp périphérique 558
COOLEY Pince-clamp pour anévrisme de l'aorte 561
COOLEY Pince-clamp pour aorte 561
COOLEY Pincés-clamps iliaques 558
COOLEY Pincés-clamps pour occlusion tangentielle 562
COOLEY Pincés-clamps universelles 562
COOLEY Pincés hémostatiques rénales 558
COOPER Aiguille à ligatures 374
 Cordon ombilical, Ciseaux 108
 Cordon ombilical, Clamps 486
 Cordon, Pince pour fixer 425
 Coronaire, Ciseaux 95
 Corps vertébraux, Ecarteurs 296
CORWIN-HEGAR TITE GRIP Pince serre-fils 662
CORYLLOS Ecarteurs et spatules pulmonaires 261
 Coservation et stérilisation, Boîtes 738
 Costales, Rugines 495
 Costotomes 492-493
 Côtes, Ecarteurs 502-508
 Côtes, Ecarteurs en ALUMINIUM 500-502
 Côtes, Rapprocheurs 508
COTTLE-NEIVERT Crochet nasal 221
COTTLE Ciseaux nasaux DURACUT 102
COTTLE Ciseaux nasaux DURACUT 58
COTTLE Crochet à peau 217
COTTLE Crochet pour la chirurgie plastique 218
COTTLE Maillets 620
COTTLE Ostéotomes 608
COTTLE Râpe 593
COTTLE Rugines-raspatoires 583, 585
 Coupantes, Pincés 637-639
 Coupe-fils, Pincés 665-666
 Coupes limes 595
 Coupes râpes 595
 Coussin en caoutchouc de rechange pour bandeau frontal de **CLAR** 11
 Couteau à cerveau 40
 Couteau à lobe 39
 Couteau à périoste 39
 Couteau à phalanges 39
 Couteau interosseux 39
 Couteau pour la tunique interne 513
 Couteaux à amputation 38
 Couteaux à autopsie 40
 Couteaux à résection 38
 Couteaux à résection et amputation 39
 Couteaux pour appareils pâtés 679
 Couteaux pour dure-mère 37
 Couteaux pour vaisseaux 694-695
 Couvercle/pince, Combinaison 735
 Crachoir 751
CRAFOORD-DE BAKEY ATRAUMATIC-GRIP Pincés-clamps pour anévrisme de l'aorte 546
CRAFOORD-STILLE Pincés hémostatiques fines 170
CRAFOORD (STELZNER) Ciseaux à lobectomie et pour le rectum 99
CRAFOORD Pincés-clamps auriculaires 564
CRAFOORD Pincés hémostatiques fines 171
CRAIG-KOLGER Set pour la biopsie vertébrale 720-721
 Crâne, Ecarteurs autofixants 702
 Crâne, Instruments pour l'ouverture 687
 Crânienne, Pince 688
 Crâniens, Rongeurs 688
 Cranioclaste 485
 Crayons et Appareil pour marquer et écrire sur métal, verre, plastique etc. 757
CRILE-BABY Pincés hémostatiques fines 166
CRILE-COLLER Pincés hémostatiques fines 167
CRILE-MICRO Pincés hémostatiques fines 166
CRILE-MURRAY Porte-aiguilles 366
CRILE-RANKIN-DE BAKEY Pincés hémostatiques fines 167
CRILE-RANKIN (OCHSNER-DIXON) Pincés hémostatiques fines 167
CRILE-RANKIN Pincés hémostatiques fines 167
CRILE-WOOD Porte-aiguilles 366, 368
CRILE-WOOD TITE GRIP Porte-aiguilles 343
CRILE-WOOD TITE GRIP Porte-aiguilles pour gauchers 341
CRILE Crochets à nerfs et à vaisseaux 214
CRILE Ecarteur double 227
CRILE Pincés hémostatiques fines 166
CRILE Pincés hémostatiques fines en TITANE 166
CRILE Porte-aiguilles 371
 Crochet double pour saisir et soulever la peau, les tissus 212
 Crochet en bulbus 422
 Crochets 287, 289, 449, 696
 Crochets à microchirurgie 212
 Crochets à molle pour fixer la galea 691
 Crochets à nerfs et à vaisseaux 213-215
 Crochets à peau 216-217
 Crochets à plaies 218
 Crochets de galea 691
 Crochets de traction 659
 Crochets nasaux 221
 Crochets pour décapitation 485
 Crochets pour décompression 701
 Crochets pour fistules 221
 Crochets pour la chirurgie plastique 217-218
 Crochets pour la dure-mère 212, 217-218
CRUTCHFIELD Alésoir pour étrier traction crânienne de **CRUTCHFIELD** 689
CRUTCHFIELD Etrier traction crânienne 689
 Cuiller pour vésicule biliaire 417
 Cuillère pour médicaments 751
 Cuillère pour prélèvements des sécrétions 425
 Cuir chevelu, Pince 481
CULLEN-WERTHEIM Pincés-clamps pour pédicules rénaux 191
 Cupules 749
 Curette-sonde pour vésicule biliaire 415
 Curettes 598-606, 692
 Curettes à avortement et placenta 484
 Curettes à biopsie et d'aspiration 471
 Curettes d'aspiration 471
 Curettes pour biopsie 459-460
 Curettes pour biopsie endo-cervicale 460
 Curettes pour calculs biliaires 417
 Curettes pour les lupus 20
 Curettes tranchantes 695-696

Curettes utérines	466-470
CURTIS Pince chirurgicale	147
CUSCO Spéculum vaginal	430-431
CUSHING-FERRIS-SMITH Pincettes emporte-pièces à laminectomie	713
CUSHING-LANDOLT Spécule pour la hypophysectomie	692
CUSHING-TAYLOR Pince auriculaire et nasale	136
CUSHING-TAYLOR Pince fine à dissection	131
CUSHING-TAYLOR Pince fine chirurgicale	143
CUSHING-TAYLOR TITE GRIP Pince à dissection	114
CUSHING Crochet pour décompression	701
CUSHING Crochet pour la dure-mère	218
CUSHING Crochets à nerfs et à vaisseaux	214
CUSHING Ecarteurs à veines	222-223
CUSHING Perforateur	652
CUSHING Pince fine chirurgicale	142
CUSHING Pincettes emporte-pièces à laminectomie	715
CUSHING Pincettes fines à dissection	130
CUSHING Spatule cérébrale	706
CUSHING TITE GRIP Pincettes à dissection	114
Cuvettes	749
CUZZI Curettes à avortement et placenta	484
Cylindres pour seringues	330-331
Cylindriques, Réceptifs	747
CZERNY Pince pour abaissement du col de l'utérus	455
CZERNY Spéculum rectal	405

D

DAHLGREN Rongeur crânien	688
DALE ATRAUMATIC-GRIP Pincettes-clamps vasculaires périphériques avec denture DE BAKEY	535
DANDY Crochets à nerfs et à vaisseaux	214
DANDY Pincettes hémostatiques fines	165
DARDIK ATRAUMATIC-GRIP Pincettes-clamps universelles	554
DARTIGUES Hystérolabe	421
DAUBENSPECK Curettes	604
DAVIDSON Ecarteurs à scapula	260
Daviers	624-630
Daviers à os	493
DAVIS-RAGNELL Ecarteurs pour la chirurgie plastique	226
DAVIS Spatules cérébrales	706
DAY Crochets à nerfs et à vaisseaux	213
DE BAKEY-BAINBRIDGE ATRAUMATIC-GRIP Pincettes vasculaires	530
DE BAKEY-BAHNSON ATRAUMATIC-GRIP Pincettes-clamps pour anévrisme de l'aorte	545
DE BAKEY-BECK ATRAUMATIC-GRIP Pincettes-clamps à anastomose	543
DE BAKEY-BECK ATRAUMATIC-GRIP Pincettes-clamps pour veine cave	550
DE BAKEY-BECK Pince-clamp pour aorte	537
DE BAKEY-CAROTIS ATRAUMATIC-GRIP Clamp Bulldog	525
DE BAKEY-CRAFOORD ATRAUMATIC-GRIP Pincettes-clamps pour anévrisme de l'aorte	546
DE BAKEY-CRILE-RANKIN Pincettes hémostatiques fines	167
DE BAKEY-DERRA ATRAUMATIC-GRIP Pincettes-clamps à anastomose	542
DE BAKEY-DIETRICH ATRAUMATIC-GRIP Clamps Bulldog	526
DE BAKEY-GLOVER ATRAUMATIC-GRIP Clamps Bulldog	525
DE BAKEY-GUYON Clamps rénaux	190
DE BAKEY-HALSTED-MOSQUITO Pincettes hémostatiques fines	165
DE BAKEY-HARKEN ATRAUMATIC-GRIP Pincettes à disséquer et à ligatures	551
DE BAKEY-HEANEY (ROGERS) Pincettes à hystérectomie	197
DE BAKEY-MORRIS ATRAUMATIC-GRIP Pincettes-clamps pour aorte	540
DE BAKEY-PEAN ATRAUMATIC-GRIP Pincettes vasculaires	529
DE BAKEY-PEAN Pincettes hémostatiques	176
DE BAKEY-POTTS Patent-ductus, Clamps ATRAUMATIC-GRIP	531
DE BAKEY-REYNOLDS ATRAUMATIC-GRIP Pincettes-clamps à anastomose	542
DE BAKEY-RUMEL Pincettes à disséquer et à ligatures	186
DE BAKEY-SATINSKY ATRAUMATIC-GRIP Clamps Bulldog	525
DE BAKEY-SATINSKY ATRAUMATIC-GRIP Pincettes vasculaires pour occlusion tangentielle	541
DE BAKEY-WERTHEIM (ROGERS) Pincettes à hystérectomie	197
DE BAKEY (GARRETT) Dilatateurs vasculaires	510
DE BAKEY ATRAUMATIC-GRIP Clamps Bulldog	526, 528
DE BAKEY ATRAUMATIC-GRIP Clamps patent-ductus	531
DE BAKEY ATRAUMATIC-GRIP Pince-clamp pour aorte	539
DE BAKEY ATRAUMATIC-GRIP Pincettes-clamps pour anévrisme de l'aorte	545, 547
DE BAKEY ATRAUMATIC-GRIP Pincettes-clamps pour coarctation	532-533

DE BAKEY ATRAUMATIC-GRIP Pincettes-clamps universelles	553
DE BAKEY ATRAUMATIC-GRIP Pincettes-clamps vasculaires périphériques	535-536
DE BAKEY ATRAUMATIC-GRIP Pincettes à disséquer et à ligatures	551
DE BAKEY ATRAUMATIC-GRIP Pincettes vasculaires	135
DE BAKEY ATRAUMATIC-GRIP Pincettes vasculaires	529-530
DE BAKEY ATRAUMATIC-GRIP Pincettes vasculaires pour occlusion tangentielle	541
DE BAKEY Canule d'aspiration	325
DE BAKEY Ciseaux à artériotomie	95
DE BAKEY Ciseaux vasculaires	96
DE BAKEY Ciseaux vasculaires DURACUT	57
DE BAKEY Ecarteurs à côtes	504, 505
DE BAKEY Pince hémostatique rénale	537
DE BAKEY Pincettes-clamps universelles	530
DE BAKEY Pincettes-clamps vasculaires périphériques	534
DE BAKEY TITE GRIP Pincettes pour saisir les tissus et tirer les aiguilles	116
DE BAKEY TITE GRIP Porte-aiguilles	343
DE MARTEL-WOLFSON Clamps pour anastomose	402
DE MARTEL-WOLFSON Pince pour fermer les clamps	402
DE MARTEL Conducteur pour scies	687
DE MARTELL-WOLFSON Porte-clamps	402
DE VILBISS Rongeur crânien	688
DE VILBISS Spéculum vaginal	433
DEAN Ciseaux pour gencive DURACUT	55
DEAN Ciseaux pour les amygdales	103
DEAVER-FORD Ecarteur et spatule pulmonaire	263
DEAVER Ciseaux à chirurgie	71
DEAVER Ecarteurs et spatules pulmonaires	264-265
Décapitation, Crochet	485
Déchets, Pincettes	735
Décompression, Crochets	701
DEJERINE Marteaux à réflexes	2
DEMEL Aiguilles passe-fils	660
DENHARDT Ouvre-bouches	22
DENIS-BROWNE Ecarteur abdominal	305
DENKER-JECKERMANN Trocarts pour la trachéotomie avec canule argent	728
Dentaires, récipient à prothèses	751
Deponettes	738
Dépresseur utérin	447
DERF Porte-aiguilles	363
DERF TITE GRIP Porte-aiguilles	342
Dermatomes	41, 42
DERRA-COOLEY ATRAUMATIC-GRIP Pincettes-clamps à anastomose	559
DERRA-DE BAKEY ATRAUMATIC-GRIP Pincettes-clamps à anastomose	542
DESCHAMPS Aiguilles à ligatures	374-376
DESJARDINS Dilatateurs à voies biliaires	415
DESJARDINS Pincettes pour calculs biliaires	419
DESMARRES Ecarteurs à veines	222
Détergent pour instruments	733
Détroncation, Ciseaux	109
DEUCHER Ecarteur abdominal	299
DEVIN ATRAUMATIC-GRIP Pincettes-clamps pour la carotide avec denture LAWTON	524
Diapasons	4
Diapasons pour neurologie	4
DIEFFENBACH Clamps Bulldog	163
DIETRICH-DE BAKEY ATRAUMATIC-GRIP Clamps Bulldog	526
DIETRICH-HEGEMANN Ciseaux vasculaires	96
DIETRICH-HEGEMANN Ciseaux vasculaires DURACUT	56
DIETRICH ATRAUMATIC-GRIP Pince-clamp pour aorte avec denture DE BAKEY	539
DIETRICH Ciseaux vasculaires	97
DIETRICH Micro Clamps Bulldog	162
DIETRICH TITE GRIP Micro-Porte-aiguilles	339
Dilatateur vésicale	423
Dilatateurs à voies biliaires	415
Dilatateurs aortiques	511
Dilatateurs biliaires	416
Dilatateurs du col de l'utérus	443-445
Dilatateurs et spatules pour la tunique interne	512
Dilatateurs pour anus et rectum	407-408
Dilatateurs pour la trachéotomie	728
Dilatateurs vasculaires	510
Dilatation, bougies	424
DINGMANN Daviers	624
Disques de fixation avec fente	659
Dissecteurs	574, 693, 696-697

- Dissecteurs pour la dure-mère 698-700
 Dissection des poumons, Pincés 149
 Dissection et à ligatures, Pincés 564
 Dissection et à ligatures, Pincés avec denture **DE BAKEY ATRAUMATIC-GRIP** 551
 Dissection et ténatomie, Ciseaux fins 92
 Dissection, Ciseaux 81-93, 98
 Dissection, Ciseaux **DURACUT** 47-54
 Dissection, Pincés 132-134
 Dissection, Pincés fines 128-131
 Dissection, Pincés **TITE GRIP** 113-115, 117
 Dissection, **TITE-GRIP** Pincés à dissection à griffes 117
 Dissection, **TITE-GRIP** Pincés modèles standard 115
 Disséquer et ligatures, Pincés 180-189
 Distributeurs de broches 656
 Distributeurs de broches filiformes 657
 Distributeurs de broches 752
DITTEL Mandrin pour sondes 425
DIU-Pincés 447
DIXON-LOVELACE Pincés hémostatiques fines 169
DIXON-UCHSNER CRILE-RANKIN Pincés hémostatiques fines 167
DOCKHORN Ecarteurs 245
 Doigts, Ecarteurs 271
 Double griffe pour extraction des tissus mous 721
DOUGLAS-BOZEMANN Pincés à pansements 208
DOUGLAS Pince à épiler 152
DOUGLAS Trocarts pour le sinus maxillaire 320
DOYEN-BABY ATRAUMATIC-GRIP Pincés-clamps intestinales 391
DOYEN-STILLE Ecarteurs 247
DOYEN ATRAUMATIC-GRIP Pincés-clamps intestinales 392-393
DOYEN Ciseaux pour interventions en profondeur 106
DOYEN Ecarteur intra abdominal 248-249
DOYEN Maillets 618
DOYEN Pince à compresses 200
DOYEN Pince à polypes et ovaires 457
DOYEN Rugines à costales 495
DOYEN Sonde cannelée 314
DOYEN Spéculums vaginaux 439
DOYEN Tracteurs pour fibrome 458
 Drains, Pincés à traire 203
DUBOIS Ciseaux à détroncation 109
DUPLAY Pince pour abaissement du col de l'utérus 453
DURACUT Ciseaux à chirurgie 46
DURACUT Ciseaux à chirurgie modèles standard 46
DURACUT Ciseaux à dissection 47-54
DURACUT Ciseaux à épisiotomie 60
DURACUT Ciseaux à iridectomie 45
DURACUT Ciseaux à ligaments larges 60
DURACUT Ciseaux adnex 54
DURACUT Ciseaux fins 45
DURACUT Ciseaux nasaux 58
DURACUT Ciseaux pour gencive 55
DURACUT Ciseaux pour gynécologie 60
DURACUT Ciseaux pour la chirurgie plastique 45
DURACUT Ciseaux pour septum 59
DURACUT Ciseaux utérins 60
DURACUT Ciseaux vasculaires 56-57
DURACUT Ciseaux vasculaires et pour fistules 45
DURACUT Pincés à couper le fil 667
DURANTE Pincés pour vaisseaux et tumeurs 149
 Dure-mère, Crochet 217-218
 Dure-mère, Dissecteurs 698-700
DUVAL-COLLIN Pince intestinale 149
DUVAL-COLLIN Pincés à préhension de l'intestin 386
DUVAL Pince intestinale 149
DUVAL Pincés à préhension de l'intestin 386-388
 Dynamomètre pour adultes 6
 Dynamomètres 6
- E**
- EASTMAN-RICHARDSON** Ecarteurs 250
EATON-BECKMANN Ecarteur pour laminectomie 280
 Ecarteur à goitre 224
 Ecarteur à poumons 260
 Ecarteur à veines et à hile rénal 223
 Ecarteur des côtes 508
 Ecarteur du pylore 403
 Ecarteur et rapprocheur 508
 Ecarteur pour la trachée 226
 Ecarteur pour mains 271
 Ecarteur rectal 408
 Ecarteur thoracique 507
 Ecarteurs 212-310
 Ecarteurs à côtes 502-507
 Ecarteurs à côtes en **ALUMINIUM** 500-502
 Ecarteurs à gaines tendineuses 225
 Ecarteurs à scapula 260
 Ecarteurs à sternotomie 499
 Ecarteurs à sternotomie en **ALUMINIUM** 498
 Ecarteurs à veines 217, 222-223
 Ecarteurs abdomiaux 297-309
 Ecarteurs atrium 509
 Ecarteurs autofixants au crâne 702
 Ecarteurs autofixants de **LEYLA**, accessoires 703, 705
 Ecarteurs autostatiques 270-276, 278, 282-283
 Ecarteurs doubles 226-231
 Ecarteurs du cerveau autofixants 704
 Ecarteurs et écarteurs à os 232
 Ecarteurs et spatules pulmonaires 261-265
 Ecarteurs intra abdominaux 248
 Ecarteurs **LEYLA**, Accessoires 705
 Ecarteurs pour appendicectomie 284
 Ecarteurs pour chirurgie lombaire 294-295
 Ecarteurs pour colonne cervicale 285
 Ecarteurs pour colonne vertébrale 288, 290-292
 Ecarteurs pour corps vertébraux 296
 Ecarteurs pour doigts 271
 Ecarteurs pour fixation à la table d'opération 704
 Ecarteurs pour genou 641
 Ecarteurs pour hemilaminectomie 277
 Ecarteurs pour interventions en profondeur 252-259
 Ecarteurs pour laminectomie 276, 279-280, 286
 Ecarteurs pour trachéotomie 217, 219-220, 728
 Ecarteurs prostatiques 422
 Ecarteurs spinaux 231
 Ecarteurs vésicaux 310
 Ecarteurs vulvaires 281
 Echardes, Pincés 150-151
ECHLIN Pincés-gouges 634
 Eclaireurs frontaux 11
 Eclaireurs frontaux pour courant à basse tension 11
 Ecouvillons 756
 Ecraseur et clamp à appendicectomie 403
 Ecraseurs intestinaux 403
EDER Porte-cotons 409
EICKEN-KILLIAN Canules d'irrigation 322
EICKEN (V.) LICHTWITZ Trocarts pour ponction du sinus maxillaire 319
EISELSBERG Ciseaux à ligatures 352
 Elévateurs 574-575
 Elévateurs pour la hanche 580
 Embouts pour pistolet-laveur à jet d'eau 755
EMMET Crochet 449
EMMET Crochet pour fistules 221
EMMET Pincés à pansements et tampons 207
 Emporte-pièce, Pincés à biopsie 460-465
 Endartérectomie, Jeu 515
 Endartérectomie, Sondes 514
 Endospéculums 443
ENGEL Scie pour appareils plâtrés 679
ENGL. MOD. Pincés à compresses 200
 Entonnoirs 751
 Entretien des instruments, Liquide concentré **PREP LUBE** 733
 Epiler, Pincés 152
 Epingles à instruments 736
 Episiotomie et périnée, Ciseaux 107
 Episiotomie, Ciseaux **DURACUT** 60
 Eponges et tampons, Pincés 209-210
ERRICO Fraise 652
ESMARCH Bande compressive 570
ESMARCH Cisailles pour étoffes d'habillement et appareils plâtrés 675
ESMARCH Couteau pour appareils plâtrés 679
ESMARCH Tube compressif 570
 Essuie-mains et broches, Paniers 753
 Estomac et intestin, Pincés-clamps 403
 Etiquettes d'identification, en couleur 743
 Etoffes d'habillement et appareils plâtrés, Cisailles 675

Etoffes d'habillement et pansements, Cisailles	674
Etriers à extension	654, 658-659
Etriers traction crânienne	689
Etui pour infirmières.	18
EUFRATE PASQUE TITE GRIP Porte-aiguilles	344
EWALD Pince fine chirurgicale	140
EWALD Pince fine pour dissection.	129
Extension, Etriers	654, 658-659
Extraction des tissus moux, Double griffe.	721

F

FAHLBUSCH-HARDY Dissecteurs	693
FANSLER-IVES Anusscopes	407
FARABEUF-ALEXANDER Rugines à costales	497
FARABEUF-COLLIN Rugines-raspatoires	588
FARABEUF-LAMBOTTE Davier	626
FARABEUF Ecarteurs doubles	227
FARABEUF Rugines-raspatoires	588
FARELL LATHBURY Porte-cotons	316
FAURE Pincés-clamps pour péritoine	193
FAVALORO Ciseaux coronaires	95
FEHLAND ATRAUMATIC-GRIP Pincés-clamps à anastomose du rectum	401
FEILCHENFELD Pincés à échardes	150
FEIN Porte-cotons	317
Fémorale, Pincés-clamps.	534
FERGUSON Aiguilles à sutures	356
FERGUSON Ciseaux pour opération	80
FERGUSON Davier.	624
FERGUSON FRAZIER Canules d'aspiration	323
FERRIS-SMITH-CUSHING Pincés emporte-pièces à laminectomie	713
FERRIS-SMITH-KERRISON Pincés emporte-pièces à laminectomie 709-711	713
FERRIS-SMITH Pincés chirurgicales	147
Fibrome, Tracteurs.	458
Fil d'argent pour fabriquer des agrafes.	690
Fil pour ceilage	660
Fils, Catgut	353
Fils-coupe, Pincés	665-666
Fils-scies	687
FINOCHIETTO-BABY-HAIGHT Ecarteur à côtes en ALUMINIUM	501
FINOCHIETTO-BABY Ecarteur à côtes	503
FINOCHIETTO-BURFORD Ecarteurs à côtes	503
FINOCHIETTO-BURFORD Ecarteurs à côtes en ALUMINIUM	502
FINOCHIETTO-INFANT Ecarteur à côtes en ALUMINIUM	501
FINOCHIETTO-RIENHOFF Ecarteur à côtes	506
FINOCHIETTO Ecarteurs à côtes	503
FINOCHIETTO Ecarteurs à côtes en ALUMINIUM	501
FINOCHIETTO modif. Ecarteurs à côtes en ALUMINIUM.	500
FINOCHIETTO Pince thoracique et pour ligatures	564
FINOCHIETTO Porte-aiguilles	369
FINOCHIETTO TITE-GRIP Porte-aiguilles	346
FINSEN Ecarteurs autostatiques	270
FISCH Crochet pour la dure-mère	212
FISCHER Strippers à tendons	646
Fistules et vasculaires, Ciseaux.	80
Fistules, Crochets	221
Fistules, Sondes	314
Fistules, Sondes	409
Fixation, Bases	703
FLETCHER (JAVERTS) Pince à tampons et éponges	210
FLUHRER Sonde boutonée.	313
FOERSTER-BALLENGER Pincés à tampons et éponges	209
FOERSTER Ecarteur abdominal en VINYL	308
FOERSTER FORBES Pincés à tampons et éponges	210
FOERSTER Valves en VINYL pour écarteur abdominal	308
FOMOM Ciseaux nasaux DURACUT.	58
FOMON Ciseaux nasaux.	102
FOMON Ciseaux pour ailes du nez	81
FOMON Ciseaux pour chirurgie plastique	82
FOMON Crochets nasaux	221
FOMON TITE-GRIP Râpes	597
FORBES (FOERSTER) Pince à tampons et éponges	210
Forceps	478-480
FORD-DEAVER Ecarteur et spatule pulmonaire.	263
FOSS Ecarteur et spatule pulmonaire	263
Fourche à fil	694
Fourchette pour implants	693
FOX-GOLDMANN Ciseaux pour gencive.	94

FOX-GOLDMANN Ciseaux pour gencive DURACUT.	55
FOX Curettes pour les lupus	20
FRANZ Ecarteur abdominal	304
FRAZIER (FERGUSON) Canules d'aspiration	323
FRAZIER Canules d'aspiration	323
FRAZIER Crochet à peau	216
FRAZIER Dissecteur pour la dure-mère.	698
FREER Ciseaux-burins	607
FREER Ecarteur	218
FREER Rugines-raspatoires	583
FRENCH EYE TITE GRIP Porte-aiguilles.	340
FRENZEL Abaisse-langue	12
FREY-SAUERBRUCH Costotome	493
FRIEDMAN-LUER Pince-gouge.	631
FRITSCH Ecarteurs	250
FROHN Porte-cotons.	316
FRYKHOLM Pincés-gouges	635

G

Gaines tendineuses, Ecarteurs	225
Galea, Crochets.	691
Galea, Crochets à molle pour fixer.	691
GALLAHER Râpe	592
GANSKE-BIRCHER Pincés à ménisque et cartilage	640
GARRETT-DE BAKEY Dilatateurs vasculaires.	510
Gauchers, Porte-aiguilles TITE GRIP.	341
GAYLOR-THOMS Pince emporte-pièces à biopsie	460
GEISSENDOERFER -OVERHOLT Pincés à disséquer et à ligatures	184
GELPI-BABY Ecarteur vulvaire	281
GELPI-SELETZ Ecarteur vulvaire	281
GELPI Ecarteurs vulvaires.	281
GEMINI-MIXTER Pincés à disséquer et à ligatures	181
GEMINI Pincés à disséquer et à ligatures	181
Gencive, Ciseaux	94
Gencive, Ciseaux DURACUT.	55
Genou, Ecarteurs	641
GERALD Pince fine chirurgicale	142
GERALD Pincés fines pour dissection	130
GERALD TITE GRIP Pince à dissection	114
GERALD TITE GRIP Pince à dissection à griffes	117
GERSTER Davier	630
GERZOG Maillets	618
GIBBON-BAILEY Rapprocheur de côtes	508
GIERTZ-STILLE Costotome	492
GIGLI (OLIVECRONA) Fils-scies.	687
GIGLI Poignées pour scies	687
GIL-VERNET MARBERGER Ecarteur à veines et à hile rénal	223
GILLIES-BABY Porte-aiguilles avec ciseaux	370
GILLIES-BABY TITE GRIP Porte-aiguilles.	348
GILLIES (CONVERSE) Crochets à peau	216
GILLIES Crochets à peau	216
GILLIES Pince fine chirurgicale	142
GILLIES Porte-aiguilles avec ciseaux	370
GILLIES TITE GRIP Pince à dissection à griffes	117
GILLIES TITE GRIP Porte-aiguilles	348
GLASSMANN KILNER Ciseaux à chirurgie et à dissection	83
GLOVER-DE BAKEY ATRAUMATIC-GRIP Clamps Bulldog.	525
GLOVER ATRAUMATIC-GRIP Pincés-clamps à anastomose avec denture DE BAKEY	544
GLUCK Costotome	492
Gobelets gradués	751
Goblet	737, 751
GOELET Ecarteur double	229
Goitre, Ecarteur.	224
GOLDMANN-FOX Ciseaux pour gencive.	94
GOLDMANN-FOX Ciseaux pour gencive DURACUT.	55
Goniomètre	7
Goniomètre pour les membres.	7
GOOD Ciseaux pour les amygdales.	103
GOODELL Dilatateur du col de l'utérus	443
GORNEY Ciseaux pour chirurgie plastique	82
GORNEY Ciseaux pour septum DURACUT.	59
GOSSET-BABY Ecarteur abdominal	299
GOSSET Ecarteurs abdominaux.	299-300
Gouge spinale	616
Gouges	607, 609-610, 612, 614
Gouges avec manche en „Ferrozell“	615-616

- Gouges et ciseaux-burins avec manche en „Ferrozell“ 614
 Gouges et ostéotomes avec manche en „Ferrozell“ 612
 Gouges, ostéotomes et ciseaux-burins avec manche en „Ferrozell“ 611-613
 Gouges, Pincés 631-636
GOURDET Curettes utérines 466
GRAEFE (TYRELL) Crochets à peau 216
GRAEFE Crochets à nerfs et à vaisseaux 213
GRAEFE Pince chirurgicale 148
GRAEFE Pincés fines à dissection 128
GRAEFE Pincés fines chirurgicales 139
GRAHAM Crochet pour la dure-mère 217
GRAMCKO-BUCK Levier à os 576
 Grattoir pour lupus 19
GRAVE modif. Spéculum vaginal 432
GRAVE Spéculum vaginaux 432-433
GREEN-ARMYTAGE Pince-clamp utérine pour hémostase 481
GREEN-SENN Ecarteurs 224
GREEN Ecarteurs 243
GREEN Pince à compresses 200
 Greffons-chasse 606
GREGORY-SOFT ATRAUMATIC-GRIP Clamps Bulldog
 avec denture **DE BAKEY** 527
GREGORY-SOFT Pincés-clamps pour la carotide 527
GREGORY Pincés-clamps pour fémorale 534
 Griffes (double) pour extraction des tissus moux 721
GRONINGEN Crochets à nerfs et à vaisseaux 215
GROSS Pincés à pansements et tampons 204
GRUENWALD-LOVE Pincés emporte-pièces à laminectomie 716
GRUENWALD (JANSEN) Pince auriculaire et nasale 136
GRUENWALD Pincés auriculaires et nasales 136
 Guides-pincés 650
GUNNAR-HEY Pince à traire les drains 203
GUTHRIE Crochets à plaies 218
GUYON -DE BAKEY Clamps rénaux 190
GUYON Clamps rénaux 190
GUYON Mandrin pour sondes 425
GUYON Mandrin pour sondes en gomme 425
 Gynécologie, Ciseaux DURACUT 60
- ## H
- HABERER** Spatules abdominaux et intestinaux 267
HAIGHT-BABY-FINOCCHIETTO Ecarteur à côtes en ALUMINIUM 501
HAIGHT Ecarteur à côtes 506
HAJEK-KOFLER Pincés emporte-pièces à laminectomie 708
HAJEK Maillets 617
HALLE Couteau pour dure-mère 37
HALLE Curettes 604
HALLE Rugine-raspatoire 582
HALLE Spatule pour la tunique interne 512
HALSEY Porte-aiguilles 363
HALSEY TITE GRIP Porte-aiguilles 342
HALSEY TITE GRIP Porte-aiguilles pour gauchers 341
HALSTED-MICRO Pincés hémostatiques fines 164
HALSTED-MOSQUITO-DE BAKEY Pincés hémostatiques fines 165
HALSTED-MOSQUITO HEISS Pincés hémostatiques fines 170
HALSTED-MOSQUITO Pincés hémostatiques fines 164-165
HALSTED Pincés hémostatiques fines 169, 171
 Hanche, Elévateurs 580
HARDY-FAHLBUSCH Dissecteurs 693
HARDY Curettes 692
HARDY Enucléateurs 693
HARDY Fourchette pour implants 693
HARKEN-DE BAKEY ATRAUMATIC-GRIP Pincés à
 disséquer et à ligatures 551
HARRINGTON-MAYO Ciseaux à dissection 86
HARRINGTON Ecarteurs et spatules pulmonaires 262
HARTMANN-COLLIN Ecarteur double 229
HARTMANN BABY-MOSQUITO Pincés hémostatiques fines 164
HARTMANN Diapason 4
HARTMANN Pincés emporte-pièces à biopsie 462
HARTMANN Sondes auriculaires 322
HASSETTINE Clamp pour le cordon ombilical 486
HAVERFIELD-SCOVILLE Ecarteur pour laminectomie 286
HAYES ATRAUMATIC-GRIP Pince-clamp à anastomose du rectum 400
HEANEY-BALLENTINE Pince à hystérectomie 196
HEANEY-DE BAKEY (ROGERS) Pincés à hystérectomie 197
HEANEY-REZEK Pincés à hystérectomie 196
HEANEY-SIMON Ecarteur pour interventions en profondeur 254
HEANEY Pincés à hystérectomie 196
HEANEY Pincés chirurgicales 147
HEANEY Porte-aiguilles 369
HEANEY TITE GRIP Porte-aiguilles 346
HEATH-RICHTER Pince à retirer les agrafes 379
HEATH Maillet 620
HEGAR-BAUMGARTNER TITE GRIP Porte-aiguilles 342
HEGAR-CORWIN TITE GRIP Pince serre-fils 662
HEGAR-MAYO Porte-aiguilles 367
HEGAR-MAYO TITE GRIP Porte-aiguilles 345
HEGAR-MAYO TITE GRIP Porte-aiguilles pour gauchers 341
HEGAR-OLSEN-BABY TITE GRIP Porte-aiguilles 348
HEGAR-OLSEN Porte-aiguilles avec ciseaux 370
HEGAR-OLSEN TITE GRIP Porte-aiguilles 348
HEGAR Dilatateurs du col de l'utérus 444
HEGAR Jeux de dilateurs du col de l'utérus 445
HEGEMANN-DIETRICH Ciseaux vasculaires 96
HEGEMANN-DIETRICH Ciseaux vasculaires DURACUT 56
HEIFETZ Pincés pour saisir tumeurs et tissus 127
HEIFETZ Spatules cérébrales 706
HEISS (HALSTED-MOSQUITO) Pincés hémostatiques fines 170
HEISS MIXTER-PAUL Pincés à disséquer et à ligatures 182
HEISTER Ouvre-bouches 22
 Hémi laminectomie, Ecarteurs 277
HEMINGWAY Curettes 599
 Hémorroïdaux, Ligateurs 410
 Hémorroïdes, Ligateurs aspirateurs 411
 Hémorroïdes, Pincés-clamps 410
 Hémostase, Pince-clamp utérine 481
 Hémostatiques et pour amygdales, Pincés 179
 Hémostatiques rénales, Pincés 537, 558
 Hémostatiques, Pincés 173-178
 Hémostatiques, Pincés fines 164-172
 Hémostatiques, Pincés fines en TITANE 164, 166, 168
HENLEY Ecarteurs autostatiques 282-283
HENNING Pince écartante à plâtre 682
HERRICK Pincés-clamps pour pédicules rénaux 191
HEY-GUNNAR Pince à traire les drains 203
HEYMANN Ciseaux nasaux 101
HEYMANN Ciseaux nasaux DURACUT 58
HEYWOOD-SMITH Pince à polypes et ovaires 457
HEYWOOD-SMITH Pincés tire-langue 23
HIBBS Ecarteurs 231
HIBBS Ecarteurs spinaux 231
 Hile rénal et veines, Ecarteurs 223
HIRSCHMANN Anuscopes 407
HOEN Rugines-raspatoires 586
HOGLUND-LOWMAN Davier 630
HOHMANN-ALDINGER Levier à os 580
HOHMANN-LANGE Leviers à os 577
HOHMANN-MINI Leviers à os 576
HOHMANN Leviers à os 578-580
HOKE Ostéotomes 607
HOLSHER Rétracteur pour racines nerveuses 701
HOLZBACH Pincés à hystérectomie 194
HOPKINS-JOHN Clamps Bulldog 163
HOPKINS-JOHN Pince pour poser et retirer les clamps Bulldog 527
HOPKINS Couteau pour appareils plâtrés 679
HORGAN Ecarteurs abdominaux 303
HORNE-JOHNSON Porte-cotons 317
HORSLEY-KEY-LISTON Pince coupante à os 494
HORSLEY Dissecteur pour la dure-mère 698
HÖSEL Ecarteurs 246
HOSPITAL-PROVIDENCE Pincés hémostatiques fines 168
HOUSE Curettes 598
HOWARD Rugine-raspatoire 583
HRYNTSCHAK-YOUNG Porte-aiguilles boomerangs 372
HUDSON Perforateur à main 652
HULKA-KENWICK Pince pour abaissement du col de l'utérus 453
HULKA Pince pour abaissement du col de l'utérus 453
HUMBY Dermatome 42
HUNTER Pincés à échardes 150
HURD Aiguilles à ligatures 374
 Hypodermique, Aiguille 486
 Hypophyse, Pincés 719
 Hypophysectomie, Instruments 692-693
 Hypophysectomie, Spécula 692
 Hystérectomie, Pincés 194-197

Hystéro-salpingographie, Instrumentation	474
Hystérolabe	421
Hystérolabes, Pincés	458
Hystéromètre	446

I

Identifications, Etiquettes	743
Iliques, Pincés-clamps	558
Implants, Fourchette	693
Incision, Ciseaux	80
INFANT-FINOCHIETTO Ecarteur à côtes en ALUMINIUM	501
Infirmières, Articles	751
INGE Ecarteurs pour corps vertébraux	296
Instrumentation pour amnioscopie	472-473
Instrumentation pour hystéro-salpingographie	474
Instruments à ongles	645
Instruments à suture	378, 690-691
Instruments de circoncision	426
Instruments de mesure pour profondeur	451
Instruments pour biopsie osseuse	669
Instruments pour cerlage	660
Instruments pour examiner et mesurer	6
Instruments pour la chirurgie laser	448-451
Instruments pour la hypophysectomie	692-693
Instruments pour l'ouverture du crâne	687
Instruments pour l'urologie	425-426
Instruments pour mesurer	7, 448
Instruments pour mesurer la sensibilité	4
Instruments pour microchirurgie	694-697
Instruments pour obstétrique	481
Instruments pour prostatectomie	423
Instruments pour trachéotomie	728-730
Instruments, Boîtes	746
Instruments, Détergent	733
Instruments, Entretien, Liquide concentré PREP LUBE	733
Instruments, Epingles	736
Instruments, Plateaux	748
Interventions en profondeur, Ciseaux	106
Interventions en profondeur, Ecarteurs	252-259
Intestin et estomac, Pincés-clamps	403
Intestin, Pincés à préhension	383-389
Intestin, Pincés à préhension ATRAUMATIC-GRIP	389
Intestinales et anastomose, Pincés-clamps	402
Intestinales, Aiguilles	354
Intestinales, Pincés	149
Intestinales, Pincés-clamps	390-394
Intestinales, Pincés-clamps ATRAUMATIC-GRIP	391-393, 395-396
Intestinaux et abdominaux, Spatules	266-267
Intestinaux, Ecraseurs	403
Intra abdominaux, Ecarteurs	248
IOWA Aiguille à hypodermique	486
IOWA Aiguille trompette guide	486
IOWA Pince perce membrane	477
Iridectomie, Ciseaux DURACUT	45
Irrigateurs	751
Irrigation, Aiguilles vasculaires	322
Irrigation, Canules	322
ISRAEL Ecarteurs	237
IVES-FANSLER Anusscopes	407

J

JACKSON-CHEVALIER Canules pour la trachéotomie	726
JACKSON Ecarteur pour la trachée	226
JACKSON Ecarteur pour trachéotomie	217
JACKSON Pince à saisir les tendons	647
JACKSON Spéculum vaginaux	438
JACOBS Pince pour abaissement du col de l'utérus	456
JACOBSON Couteau pour vaisseaux	694
JACOBSON Fourche à fil	694
JACOBSON Micro-ciseaux	64
JACOBSON Micro-Porte-aiguilles	359
JACOBSON Sonde boutonée	694
JACOBSON Sonde double	694
JACOBSON TITE GRIP Micro-Porte-aiguilles	338
JAMESON Porte-aiguilles	368

JAMSON Ciseaux fins à dissection	93
JANET Cylindres pour seringues	331
JANET Seringues vésicales	331
JANSEN-ZAUFAL Pince-gouge	633
JANSEN Curette	599
JANSEN Ecarteurs autostatiques	272
JANSEN Eclairer frontal complet	11
JANSEN GRUENWALD Pince auriculaire et nasale	136
JANSEN Pince auriculaire et nasale	136
JANSEN Pincés-gouges	632
JANSEN Rugine-raspatoire	587
JAVERTS FLETCHER Pince à tampons et éponges	210
JAVID Pince-clamps pour la carotide	537
Jeu de trépan cutanés	20
Jeu d'instruments pour trachéotomie	729-730
Jeu pour endartérectomie	515
Jeu pour tunneler	516
Jeux de dilateurs biliaires	416
JOHN-HOPKINS Clamps Bulldog	163
JOHNS-HOPKINS Pince pour poser et retirer les clamps Bulldog	527
JOHNSON-HORNE Porte-cotons	317
JONES-LELAND Pincés-clamps vasculaires périphériques	534
JONES Pincés à compresses	200
JORGENSEN Ciseaux à dissection	98
JOSEPH Bistouris pour plastie du nez	37
JOSEPH Ciseaux pour chirurgie plastique	70
JOSEPH Crochet pour la chirurgie plastique	217, 219
JOSEPH DURACUT Ciseaux pour la chirurgie plastique	45
JOSEPH Lime à os	597
JOSEPH Rugine-raspatoire	582
JUDD-ALLIS Pincés à préhension de l'intestin	384
JUDD-MASSON Ecarteur vésical	310

K

KADER Spatules abdominaux et intestinaux	267
KALLMORGEN Jeux de spéculums et valves vaginaux	434
KALT Aiguilles vasculaires	354
KALT Porte-aiguilles	363
KATSCH Tire-comédons	19
KAY-LAMBERT ATRAUMATIC-GRIP Pincés-clamps pour anastomose de l'aorte avec denture DE BAKEY	549
KAZANJIAN Pince coupante	637
KELLY-BABY Pincés hémostatiques fines	168
KELLY-RANKIN Pincés hémostatiques fines	169
KELLY Ciseaux vasculaires et pour fistules	80
KELLY DURACUT Ciseaux vasculaires et pour fistules	45
KELLY Ecarteur pour interventions en profondeur	255
KELLY Ecarteurs	251
KELLY Pince à polypes et ovaires	457
KELLY Pincés hémostatiques fines	168
KELLY Pincés hémostatiques fines en TITANE	168
KELLY Sphinctérosopes	407
KENWICK-HULKA Pince pour abaissement du col de l'utérus	453
KERN-LANE Davier	625
KERN-MINI Davier	625
KERRISON-LOVE (COLCLOUGH) Pincés emporte-pièces à laminectomie	710-711
KERRISON-SMITH-FERRIS Pincés emporte-pièces à laminectomie 709-711	707
KERRISON Pincés emporte-pièces à laminectomie	707
KEVOURKIAN-PACIFIC Pince emporte-pièces à biopsie	464
KEVOURKIAN-YOUNGE Curettes pour biopsie	459
KEVOURKIAN-YOUNGE Pince emporte-pièces à biopsie	463, 465
KEY-LISTON-HORSLEY Pince coupante à os	494
KEY Rugines-raspatoires	589
KEYES Jeu de trépan cutanés	20
KEYES Trépan cutanés	20
KIELAND-LUIKART Forceps	479
KIELAND Forceps	479
KILLIAN-EICKEN Canules d'irrigation	322
KILLIAN MÜHLING Ciseaux pour cloison des fosses nasales	102
KILLIAN Rugines-raspatoires	583
KILNER (GLASSMANN) Ciseaux à chirurgie et à dissection	83
KILNER Ciseaux fins à dissection	93
KILNER Crochet à peau	216
KILNER TITE GRIP Porte-aiguilles	342
KIRK Maillets	618
KIRKLIN Ecarteurs à veines	223

- KIRSCHNER** Etriers à extension. 658-659
KIRSCHNER, Broches 655
KIRSCHNER-BALFOUR Valves pour écarteurs abdominaux. 307
KIRSCHNER Ecarteurs abdominaux 306
KIRSCHNER Valves pour écarteurs abdominaux. 307
KLEINERT-KUTZ Pince passe-tendons. 649
KLEINSCHMIDT Ecraseur et clamp à appendicectomie. 403
KLIMA-ROSEGGER Aiguilles à ponction sternale 329, 518
KLINGENBERGH-LOTH Ciseaux à dissection 98
KNAPP Ciseaux chirurgicaux fins 68
KNAPP Ecarteurs 218
KNAPP Ecarteurs à gaines tendineuses 225
KNIGHT Ciseaux nasaux. 101
KNIGHT Ciseaux nasaux DURACUT. 58
KNOWLES Ciseaux à pansements 673
KNUTSON Uréthrographe 426
KOCHER-BABY ATRAUMATIC-GRIP Pincés-clamps intestinales 391
KOCHER-LANGENBECK Ecarteurs 240
KOCHER-OCHSNER Pincés hémostatiques 177
KOCHER ATRAUMATIC-GRIP Pincés-clamps intestinales. 395
KOCHER Ecarteurs 235, 242, 244
KOCHER Ecarteurs et écarteurs à os 232
KOCHER Pincés-clamps intestinales 392-394
KOCHER Pincés hémostatiques 176
KOCHER Spatule vésicale 268
KOCHER Spatules à goitre 378
KOENIG Sondes conductrices. 377
KOERTE-LUER Curettes pour calculs biliaires. 417
KOERTE Ecarteurs 236
KOFLER-HAJEK Pincés emporte-pièces à laminectomie 708
KOGAN Endospéculum 443
KOGAN Spéculum pour urètre et col utérin 448
KOGLER-CRAIG Set pour la biopsie vertébrale 720-721
KÖLN MOD. Agrafes hémostatiques pour cuir chevelu 691
KÖNIG-ROSER Ouvre-bouches 22
KÖNIG Rugine-raspatoire 582
KONRICH Boîtes rondes pour stérilisation 743
KOOS Couteaux pour vaisseaux 695
KRAUS Couteau pour vaisseaux. 695
KRAUSE Trocart pour la ponction du sinus maxillaire 319
KRAYENBÜHL Crochets à nerfs et à vaisseaux 215
KRISCHNER Sonde conductrice 377
KRISTELLER Jeux de spéculum et valves vaginaux 434-437
KRISTELLER Spéculum vaginaux 434-437
KRISTELLER Valves vaginales 434-437
KROENLEIN Pince hémostatique 173
KRONECKER Aiguilles à ligatures. 374
KÜHNE Pince porte-laminaires 152
KUTZ-KLEINERT Pince passe-tendons. 649
- L**
- LA GRANGE** Ciseaux pour gencive. 94
LABORDE Dilatateur pour la trachéotomie 728
LAHEY-SWEET Pincés à disséquer et à ligatures 189
LAHEY Ecarteur 219
LAHEY Ecarteur à goitre. 224
LAHEY Pince pour abaissement du col de l'utérus. 454
LAHEY Pincés à disséquer et à ligatures. 189
Lambeaux antérieur, Pince pour saisir 423
LAMBERT-KAY ATRAUMATIC-GRIP Pincés-clamps pour anastomose de l'aorte avec denture **DE BAKEY**. 549
LAMBERT-LOWMAN Davier. 630
LAMBOTE-MINI Ostéotomes. 608
LAMBOTE Ostéotomes. 608
LAMBOTTE-FARABEUF Davier 626
LAMBOTTE Daviers. 626-627
LAMBOTTE Rugines à costales 497
Lame de rechange pour scie oscillante 681
Lame de rechange seule pour dermatome de **HUMBY**. 42
Lame de rechange seule pour dermatome de **SCHINK** 41
Lames 36
Lames-ciseaux-burins interchangeables. 611
Lames-gouges interchangeables 611
Lames-ostéotomes interchangeables 611
Lames de bistouris, stériles. 34-35
Lames de rasoir. 36
Laminectomie, Ecarteurs. 276, 279-280
Laminectomie, Pincés emporte-pièces 707-719
Lampe de rechange (halogène) pour spatules de laryngoscopie 27, 31
Lampe de rechange pour bandeau frontal de **CLAR**. 11
Lampe de rechange pour bandeau frontal de **JANSEN** 11
Lampes de rechange pour spatules de laryngoscopie de **MC INTOSH** 25, 27, 29
LANDAU-COLLIN Spéculum vaginaux 431
LANDAU Spéculum vaginaux 440
LANDOLT-CUSHING Spécula pour la hypophysectomie 692
LANDOLT Rugine-raspatoire 585
LANE-KERN Davier 625
LANE-MURPHY Levier pour luxation. 581
LANE Davier 625
LANE Pincés à compresses 201
LANGE-HOHMANN Leviers à os. 577
LANGE Ciseaux à pansements 672
LANGENBECK-KOCHER Ecarteurs 240
LANGENBECK-MINI Ecarteurs 224
LANGENBECK-PARKER US-ARMY Ecarteurs 231
LANGENBECK-RYDER TITE GRIP Porte-aiguilles 350
LANGENBECK Couteaux à résection 38
LANGENBECK Davier 624
LANGENBECK Ecarteurs. 238-239
LANGENBECK Elévateurs 575
LANGENBECK Rugines-raspatoires 587
LANGENBECK Scie à amputation et résection 572
LANGENBECK TITE GRIP Porte-aiguilles. 350
Laryngoscopes 24-31
Laryngoscopes lumière froide 26, 30
Laser, Instruments pour la chirurgie 448-451
LATHBURY (FARRELL) Porte-cotons 316
LAWRENCE Pincés à disséquer et à ligatures. 187
LAWTON-MATHIEU TITE GRIP Porte-aiguilles 349
LAWTON TITE GRIP Porte-aiguilles 349
LAZAR Micro-pincés à ligatures 121
LEBSCHKE Cisaille et ciseaux-burins à sternum 492
LEES ATRAUMATIC-GRIP Pincés-clamps à bronches avec denture **DE BAKEY** 552
LEGUEU Spatule vésicale 268
LEKSELL-STILLE Pincés-gouges 635
LELAND-JONES Pincés-clamps vasculaires périphériques 534
LEMMON Spatules pour la tunique interne 512
LEMPERT Curettes 604
LEMPERT Pincés-gouges 631-632
LEMPERT Rugines-raspatoires 584
Lentilles supplémentaires 9
LERICHE Pincés hémostatiques fines 165
Levier à tête utilisé en cas de césarienne 481
Levier obstétrique 481, 486
Leviers à os 576-581
Leviers pour luxation 581
LEWIN Pince à réduction. 622
LEWIS Râpes 592
LEXER-BABY Ciseaux à dissection 87
LEXER-MAYO Ciseaux à Dissection 87
LEXER-MAYO Ciseaux à dissection DURACUT 48
LEXER-MINI Gouges. 612
LEXER-MINI Ostéotomes 612
LEXER Ciseaux-burins spongieuse 615
LEXER Ciseaux à dissection 87
LEXER Ciseaux à dissection DURACUT 49
LEXER Gouges 612-613
LEXER Ostéotomes 612-613
LEYLA Articulation sphérique pour fixation du bras 705
LEYLA Base de fixation. 703
LEYLA Bras de fixation à l'articulation sphérique 705
LEYLA Bras flexible pour fixation aux têtes d'accouplement 703
LEYLA Ecarteurs autofixant au crâne 702, 704
LEYLA Ecarteurs autofixants, Accessoires. 703, 705
LEYLA Ecarteurs du cerveau autofixants 704
LEYLA Supports pour spatules 703
LEYLA Tête d'accouplement 705
LICHTENBERG TITE GRIP Porte-aiguilles 349
LICHTWITZ Trocarts pour la ponction du sinus maxillaire 319-320
LICHTWITZ VEICKEN Trocarts pour ponction du sinus maxillaire. 319
Ligaments, Ciseaux DURACUT 60
Ligateurs aspirateurs pour hémorroïdes 411
Ligateurs hémorroïdaux. 410
Ligatures et dissection, Pincés 180-189, 564

Ligatures et dissection, Pincés avec denture DE BAKEY	551
Ligatures et thoracique, Pince	564
Ligatures, Aiguilles	374-376
Ligatures, Ciseaux	352-353
Ligatures, Micro-pincés	121-123
Ligatures, Micro-pincés en titane	123
Ligatures, Pince	152
Ligatures, Pincés TITE GRIP	113
Limes à ongles	18
Limes à os	592, 594-595
Limes, Coupés	595
LINDORF TITE GRIP Pince serre-fils	662
Liquide concentré pour entretien des instruments PREP LUBE	733
LISTER Cisailles à pansements et étoffés d'habillement	674
LISTER Ciseaux à pansements	673
LISTER Pincés à pansements et tampons	204
LISTON-KEY-HORSLEY Pince coupante à os	494
LISTON-LITTAUER Pince coupante	637
LISTON-RUSKIN Pincés coupantes	638
LISTON-WALTON (BÖHLER) Pincés coupantes	638
LISTON Couteau à amputation	38
LISTON Pincés coupantes	637, 639
Lit, Bassins	750
LITTAUER-LISTON Pince coupante	637
LITTAUER Ciseaux à ligatures	352
LITTAUER Pince à épiler	152
LITTER Ciseaux à dissection avec chas	81
Lobectomie et rectum, Ciseaux	99
LOCKHART-MUMMERY Sondés pour fistules	314
LOCKLIN Ciseaux pour gencive	94
LOCKLIN Ciseaux pour gencive DURACUT	55
LOCKWOOD Pince à préhension de l'intestin	386
LONG Pince à hystérectomie	194
LORNA Pincés pour champs en papier	202
LOTH-KLINGENBERGH Ciseaux à dissection	98
LOTH-SCHOEMAKER Ciseaux à ligatures	352
Loupe seule	9
Loupes binoculaires	8
Loupes binoculaires frontales	8-9
LOUTE Serre-fil	660
LOVE-GRUENWALD Pincés empore-pièces à laminectomie	716
LOVE-KERRISON (COLCLOUGH) Pincés emporte-pièces à laminectomie	710-711
LOVE Rétracteurs pour racines nerveuses	701
LOVELACE-DIXON Pincés hémostatiques fines	169
LOVELACE Pince à préhension de l'intestin	387
LOWER Pincés à disséquer et à ligatures	189
LOWMAN-HOGLUND Davier	630
LOWMAN-LAMBERT Davier	630
LOWMAN Daviers	630
LUCAE Crochets à nerfs et à vaisseaux	213
LUCAE Diapason pour neurologie	4
LUCAE Maillet	617
LUCAE Pince auriculaire et nasale	136
LUCAS Curettes	599
LUER-FRIEDMAN Pince-gouge	631
LUER-KOERTE Curettes pour calculs biliaires	417
LUER-STILLE Pincés-gouges	634, 636
LUER Canules pour la trachéotomie	725
LUER Ecarteur double	227
LUER Pincés-gouges	631-632
LUIKART-KIELAND Forceps	479
Lunettes	9
Lunettes à loupes binoculaires	9
Luxation, Leviers	581

M

MAGILL Pincés pour intubation	32
MAIER-SIMS Pincés à pansements et tampons	205
MAIER Pincés à pansements et tampons	205
Maillets	617-618
Maillets avec manche en „Ferrozell“	619
Main de plomb	644
Main, Perforateur	651-653
Mains, Ecarteurs	271
MALTZ Râpe	593
MALTZ TITE-GRIP Râpes	596

Manche à billes	721
Manche pour lames interchangeables	611
Manches démontables	571
Manches en métal pour miroirs laryngiens	13
Manches pour bistouris	34-35
Manches réversibles	571
Mandrin pour sondés	425
Mandrin pour sondés en gomme	425
MARBACH Ciseaux à épisiotomie	107
MARBERGER (GIL-VERNET) Ecarteurs à veines et à hile rénal	223
MARKWALDER Pince coupante pour la base des côtes	494
MARQUARDT Pince-gouge	634
Marteaux	2-3
MARTIN Curettes	598
MARTIN Ecarteur pour interventions en profondeur	254
MARTIN Pelvimètre	477
MARTIN Pincés à ménisque et cartilage	640
MASSON-JUDD Ecarteur vésical	310
MASSON Porte-aiguilles	368
MASSON TITE GRIP Porte-aiguilles	347
MASTIN Pince-clamp musculaire	728
MATHIEU-LAWTON TITE GRIP Porte-aiguilles	349
MATHIEU Ecarteurs	231
MATHIEU Ecarteurs doubles	226
MATHIEU Porte-aiguilles	371
MATHIEU Spéculum rectal	405
MATHIEU Spéculums vaginaux	439
MATHIEU TITE GRIP Porte-aiguilles	349
MATHIEU Valves vaginaux	439
MATSON Rugine à costales	497
MATZENAUER Spéculums vaginaux	440
MAUNDER Baillon en bois	22
MAYFIELD Pince-gouge	633
MAYO-ADAMS Ecarteurs pour appendicectomie	284
MAYO-BLAKE Pincés pour calculs biliaires	418
MAYO-HARRINGTON Ciseaux à dissection	86
MAYO-HEGAR Porte-aiguilles	367
MAYO-HEGAR TITE GRIP Porte-aiguilles	345
MAYO-HEGAR TITE GRIP Porte-aiguilles pour gauchers	341
MAYO-LEXER Ciseaux à dissection DURACUT	48
MAYO-LEXER Ciseaux à dissection	87
MAYO-NOBLE Ciseaux à dissection	86
MAYO-ROBSON ATRAUMATIC-GRIP Pincés-clamps intestinales	396
MAYO-ROBSON Pincés-clamps intestinales	396
MAYO-STILLE Ciseaux à dissection	85
MAYO-STILLE Ciseaux à dissection DURACUT	48
MAYO Abaisse-langue	12
MAYO Ciseaux à dissection	84
MAYO Ciseaux à dissection DURACUT	47
MAYO Curette pour calculs biliaires	417
MAYO Ecarteur intra-abdominaux	249
MAYO Epingles à instruments	736
MAYO Pince pour vaisseaux et tumeurs	149
MC DONALD Dissecteur	574
MC GIVNEY Pince-clamp pour hémorroïdes	410
MC INDOE Ciseaux pour cartilage	82
MC INDOE Pince coupante	638
MC INDOE Pince fine à dissection	130
MC INDOE TITE GRIP Pince à dissection	113
MC INTOSH Laryngoscopes	24-27
MC INTOSH Laryngoscopes lumière froide	26
MC INTOSH Spatules de laryngoscopie	25, 27
MC INTOSH Spatules de laryngoscopie avec lumière froide	27
MC INTOSH Troussés à laryngoscopie	24, 28
MC INTOSH Troussés à laryngoscopie lumière froide	26
MC KENTY Rugine-raspatoire	582
MC KENZIE Agrafes en argent	690
MC KENZIE Fil d'argent pour fabriquer des agrafes	690
MC KENZIE Fraise	652
MC KENZIE Pince pose clips	690
MC KENZIE Support porte-agraves	690
MC PHERSON Micro-pincés à ligatures	122
MEAD Maillet	618
MEAD Pincés-gouges	631
Méatotome	426
Médicaments, Cuillère	751
MEEKER-BABY Pincés à disséquer et à ligatures	180
MEEKER Pincés à disséquer et à ligatures	187
MENGHINI Aiguille pour la ponction aveugle du foie	329

MENGHINI Aiguille pour la ponction contrôlée du foie	329
Ménisque et cartilage, Pincés	640
Ménisque, Bistouris	642-643
MERCEDES Ecarteur thoracique	507
METZENBAUM-BABY Ciseaux à dissection	89
METZENBAUM-NELSON Ciseaux à dissection	91
METZENBAUM-NELSON Ciseaux à dissection modèles fins DURACUT	53
METZENBAUM-NELSON Ciseaux à dissection modèles standard DURACUT	53
METZENBAUM-THOREK Ciseaux adnex DURACUT	54
METZENBAUM Ciseaux à dissection	88-90
METZENBAUM Ciseaux à dissection DURACUT	49
METZENBAUM Ciseaux à dissection modèles fins	90
METZENBAUM Ciseaux à dissection modèles standard	90
METZENBAUM Ciseaux à dissection modèles standard DURACUT	50-52, 54
MEYERDING Ecarteurs	225
MEYERDING Ecarteurs pour appendicéctomie	284
MICHEL Agrafes	379
MICHEL Miroirs pour rhinoscopie	14
MICHEL Pince à poser et à retirer les agrafes	379
MICHEL Pince à poser les agrafes	379
MICRO-ADSON Pincés fines à dissection	129
MICRO-ADSON Pincés fines chirurgicales	140-141
MICRO-ADSON TITE GRIP Pincés à dissection à griffes	117
MICRO-CASTROVIEJO Micro-Porte-aiguilles	358
Micro-chirurgie, Boîte ronde pour instruments	737
Micro-ciseaux	62-67
Micro-ciseaux à disséquer	65
MICRO-CRILE Pincés hémostatiques fines	166
MICRO-HALSTED Pincés hémostatiques fines	164
Micro-pincés	125
Micro-pincés (modèles horloger)	120
Micro-pincés à ligatures	121-123
Micro-pincés à ligatures en titane	123
Micro-pincés en titane pour saisir les tissus	124
Micro-pincés pour saisir les tissus	124
Micro-Pincés TITE GRIP	118
Micro-Porte-aiguilles	358-362
Micro-Porte-aiguilles en TITANE	362
Micro-Porte-aiguilles TITE GRIP	338-339
Micro Clamps Bulldog	162
Micro lames	473
Microchirurgie, Crochets	212
Microchirurgie, Instruments	694-697
Microscopie, Pincés	121
MIDDELDOFF Ecarteurs	243
MIKULICZ-BABY Pincés-clamps pour péritoine	192
MIKULICZ Ecarteurs pour interventions en profondeur	255
MIKULICZ Pincés-clamps pour péritoine	192-193
MILAN Curettes pour biopsie endo-cervicale	460
MILLER-SENN Ecarteurs doubles	226
MILLER Laryngoscopes	28, 30-31
MILLER Râpes	592
MILLER Spatules de laryngoscopie	29, 31
MILLER Spatules de laryngoscopie avec lumière froide	31
MILLER TITE-GRIP Râpes	596
MILLER Trousse à laryngoscopie avec lumière froide	30
MILLER Trousses à laryngoscopie	28, 30
MILLES Micro-ciseaux	64
MILLIGAN Dissecteur pour la dure-mère	698
MILLIN-YOUNG Porte-aiguilles boomerangs	372
MILLIN Dilatateur vésicale	423
MILLIN Ecarteurs vésicaux	310
MILLIN Pince porte-fil	423
MILLIN Pince pour saisir les capsules	423
MILLIN Pince pour saisir les lambeaux antérieurs	423
MINI-HOHMANN Leviers à os	576
MINI-KERN Davier	625
MINI-LAMBOTTE Ostéotomes	608
MINI-LANGENBECK Ecarteurs	224
MINI-LEXER Gouges	612
MINI-LEXER Ostéotomes	612
MINI-STILLE Cisailles pour appareils plâtrés	677
MINI-YASARGIL Applicateurs pour clips vasculaires	154
MINI-YASARGIL Serre-Fines	154
MIOTTI-OVERHOLT Pincés à disséquer et à ligatures	185
Miroir frontal seul	10
Miroirs	10

Miroirs frontaux	10
Miroirs laryngiens avec manche fixe	14
Miroirs laryngiens sans manche	13
Miroirs pour rhinoscopie	14
MIXTER-BABY Pincés à disséquer et à ligatures	180
MIXTER-GEMINI Pincés à disséquer et à ligatures	181
MIXTER-O'SHAUGNESSY Pincés à disséquer et à ligatures	182
MIXTER-OVERHOLT Pincés à disséquer et à ligatures	183
MIXTER-PAUL (HEISS) Pincés à disséquer et à ligatures	182
MIXTER Ciseaux à chirurgie	79
MIXTER Pince pour calculs biliaires	419
MIXTER Pincés à disséquer et à ligatures	182, 188-189
MOBERG Ecarteurs	224
MOD. ENGL. Pincés à compresses	200
MOD. KÖLN Agrafes hémostatiques pour cuir chevelu	691
MOD. MÜNCHEN Curette pour biopsie	459
MOD. SWITZERLAND Micro-pincés (modèles horloger)	120
MOD. USA Ciseaux pour le cordon ombilical	108
MOD. USA Curettes	601
MOD. USA Pince écartantes à plâtre	682
MOD. USA Pincés à dissection modèles étroits	133
MOD. USA Pincés à dissection modèles standard	133
MODELL CANAD. Bistouris à ménisque	643
MODELL RUSS. Pincés pour vaisseaux et tumeurs	149
MOGEN Instrument de circoncision	426
MOLDESTAD Ecarteur à veines	217
MÖLTGEN Goniomètre pour les membres	7
MOORE-STAUDE Pince pour abaissement du col de l'utérus	452
MOORE Cuillère pour vésicule biliaire	417
MORGAN-TISCHLER Pince emporte-pièces à biopsie	464
MORRIS-DE BAKEY ATRAUMATIC-GRIP Pincés-clamps pour aorte	540
MORSE Ecarteur à sternotomie	499
MOSQUITO-BABY (HARTMANN) Pincés hémostatiques fines	164
MOSQUITO-HALSTED-DE BAKEY Pincés hémostatiques fines	165
MOSQUITO-HALSTED HEISS Pincés hémostatiques fines	170
MOSQUITO-HALSTED Pincés hémostatiques fines	164-165
MOTT-PARKER Ecarteurs doubles	228
MOYNIHAN Pincés hémostatiques	178
MOYNIHAN Sonde-curette pour vésicule biliaire	415
MÜHLING (KILLIAN) Ciseaux pour cloison des fosses nasales	102
MÜHLING Rugines-raspatoires	584
MÜLLER-BIEMER Approximateurs	157
MÜLLER-VERBRUGGE Leviers à os	579
MÜLLER Approximateurs	158
MUMMERY-LOCKHART Sondes pour fustules	314
MÜNCHEN MOD. Curette pour biopsie	459
MURLESS Levier à tête utilisé en cas de césarienne	481
MURPHY-LANE Levier pour luxation	581
MURPHY Bandeau frontal en celluloid blanc	10
MURRAY-CRILE Porte-aiguilles	366
Musculaire, Pince-clamp	728
MUSEUX Pincés pour abaissement du col de l'utérus	456
MYERS Strippers à varices	315

N

NABATOFF Strippers à varices	315
NAEGELE Forceps	478
NAGEL Micro-ciseaux	67
Nasales et auriculaires, Pincés	136-137
Nasaux, Ciseaux	101-102
Nasaux, Ciseaux DURACUT	58
Nasaux, Crochets	221
NEALTON Sonde boutonnée cannelée	314
Nécessaire à suture	380
NEFF Bistouris à ménisque	642
NEGUS Pincés hémostatiques et pour amygdales	179
NEIVERT-COTTLE Crochet nasal	221
NEIVERT Porte-aiguilles	363
NEIVERT TITE GRIP Porte-aiguilles	342
NELSON-METZENBAUM Ciseaux à dissection	91
NELSON-METZENBAUM Ciseaux à dissection modèles fins DURACUT	53
NELSON-METZENBAUM Ciseaux à dissection modèles standard DURACUT	53
NELSON Pince chirurgicale	148
NELSON Trocart	318
Nerf trigéminal, Ciseaux	100
Nerfs et vaisseaux, Crochets	213-215

Nerfs, Ciseaux à dissection	93
Neuro-chirurgie, Ciseaux	100
NEW ORLEANS Porte-aiguilles	367
NEW ORLEANS TITE-GRIP Porte-aiguilles	344
NEWS Ecarteur pour trachéotomie	217
NOBLE-MAYO Ciseaux à dissection	86
NORTHBENT SPENCER Ciseaux à ligatures	352
NOTO Pince à polypes et ovaires	457
NOTT Spéculum vaginaux	433
NOVAK Curette pour biopsie	459

O

O'BRIEN Ciseaux à ligatures	352
Obstétrique, Instruments	481
Obstétrique, Levier	481, 486
Obturbateur mou pour pousser les échantillons de tissu	721
OBWEGESER Ecarteurs	241
OBWEGESER TITE-GRIP Pincés à ligatures	113
Occlusion tangentielle, vasculaires, Pincés ATRAUMATIC-GRIP	541
Occlusion tangentielle, pincés-clamps	562
Occlusion, Pincés-clamps ATRAUMATIC-GRIP	398-399
OCHSNER-ALLIS Pince à préhension de l'intestin	383
OCHSNER-DIXON CRILE-RANKIN Pincés hémostatiques fines	167
OCHSNER-KOCHER Pincés hémostatiques	177
OCHSNER-ROCHESTER Pincés hémostatiques	178
OCHSNER ATRAUMATIC-GRIP Pince-clamp pour aorte avec denture DE BAKEY	539
OCHSNER Dilatateur à voies biliaires	415
OCHSNER Pince pour ligatures	152
OCHSNER trocarts	318
O'CONNOR-O'SULLIVAN Ecarteur abdominal	304
O'CONNOR Crochet à peau	217
OEHLER TITE GRIP Pincés	118
Og, Aiguilles pour ophtalmologie	354
OLDBERG Pince pour l'hypophyse	719
OLIVECRONA-TOENNIS (SCOVILLE) Pince pose clips	690
OLIVECRONA (GIGLI) Fils-scies	687
OLIVECRONA Ciseaux pour le nerf trigéminal	100
OLIVECRONA Dissecteurs pour la dure-mère	700
OLIVECRONA Spatules cérébrales	706
OLLIER Ecarteurs	236
OLSEN-HEGAR-BABY TITE GRIP Porte-aiguilles	348
OLSEN-HEGAR Porte-aiguilles avec ciseaux	370
OLSEN-HEGAR TITE GRIP Porte-aiguilles	348
OMBREDANNE Maillet	621
Ongles, Ciseaux à fendre	81
Ongles, Instruments	645
Ongles, Perceuse	645
Ongles, Pince	645
Ongles, Pince pour extraction	645
Opération, Ciseaux	80
Ophtalmologie, Aiguilles	354
Os, Daviers	493
Os, Ecarteurs	232
Os, Leviers	576-581
Os, Limes	592, 594-595
Os, Pincés coupantes	494
Os, Ponction, Tréphine	721
O'SHAUGNESSY-MIXTER Pincés à disséquer et à ligatures	182
Osseuse biopsie, Instruments	669
Ostéotomes	607-610, 612
Ostéotomes et gouges avec manche en „Ferrozell“	612
Ostéotomes, ciseaux-burins et gouges avec manche en „Ferrozell“	611-613
O'SULLIVAN-O'CONNOR Ecarteur abdominal	304
Ouvre-bouches	22
Ovaires et polypes, Pincés	457
OVERHOLT-BABY Pincés à disséquer et à ligatures	183
OVERHOLT-GEISSENDOERFER Pincés à disséquer et à ligatures	184
OVERHOLT-MIOTTI Pincés à disséquer et à ligatures	185
OVERHOLT-MIXTER Pincés à disséquer et à ligatures	183
OVERHOLT Pincés à disséquer et à ligatures	183, 185

P

PACIFIC-KEVOURKIAN Pince emporte-pièces à biopsie	464
Paniers de stérilisation	745

Paniers pour brosses et pour essuie-mains	753
Pansements et étoffes d'habillement, Cisailles	674
Pansements et tampons, Pincés	204-207
Pansements, Ciseaux	672-673
Pansements, Pincés	208
Papier, Pincés à champs	202
PARK-ALAN Ecarteur rectal	408
PARKER-LANGENBECK US-ARMY Ecarteurs	231
PARKER-MOTT Ecarteurs doubles	228
PARKER Ecarteurs doubles	228
PASQUE EUFRATE TITE GRIP Porte-aiguilles	344
Passe-fils	697
Passe-fils, Aiguilles	660-661
Patella, Pince	623
Patent-ductus, Clamps avec denture DE BAKEY ATRAUMATIC-GRIP	531
PAUFIQUE Pince fine chirurgicale	139
PAUL-MIXTER (HEISS) Pincés à disséquer et à ligatures	182
PAUL Ecarteur à gaines tendineuses	225
PAYR-BABY Pince-clamp et écraseur pour l'intestin et l'estomac	403
PAYR Aiguilles vasculaires	354
PAYR Pincés-clamps et écraseur pour l'intestin et l'estomac	403
PAYR Sondes conductrices	377
Pb Aiguilles intestinales	354
PEAN-DE BAKEY ATRAUMATIC-GRIP Pincés vasculaires	529
PEAN-DE BAKEY Pincés hémostatiques	176
PEAN-ROCHESTER Pincés hémostatiques	175
PEAN Pincés hémostatiques	173-174
Peau et tissus, Crochet double pour saisir et soulever	212
Peau, Crochets	216-217
PEDERSON Spéculum vaginaux	432-433
Pédicules rénaux, Pincés-clamps	191
PEERS Pince pour champs en papier	202
PEET Pincés à échardes	151
PELTESON Porte-cotons	317
Pelvimètre	477
PENFIELD Dissecteur pour la dure-mère	699
PENNINGTON Pincés à préhension de l'intestin	387
Perce-crâne	485
Perce membrane, Pince	477
Perceuse à ongles	645
PERCY Manches démontables	571
PERCY Manches reversibles	571
Perforateur	652
Perforateur à main	651-653
Périnée (épisiotomie), Ciseaux	107
Périphérique, Pince-clamp	558
Périphériques, vasculaires, Pincés-clamps	534
Périphériques, vasculaires, Pincés-clamps avec denture DE BAKEY ATRAUMATIC-GRIP	535-536
Péritoine, Pincés-clamps	192-193
PERMAN Ecarteur abdominal	299
PERTHES Pointes-carrées	650
PHANEUF Pincés à hystérectomie	194
Pièces de raccord	333
Pièces de rechange pour BERGER loupes binoculaires	8
Pièces de rechange pour éclairer frontal de CLAR	11
Pièces de rechange pour loupes binoculaires	9
Pied à coulisse	7
PIERCE Trocart pour la ponction du sinus maxillaire	319
PIFFARD Curettes pour les lupus	20
PINARD Stéthoscopes en aluminium	5
Pince-clamp à pression	409
Pince-clamp périphérique	558
Pince-clamp pour anévrisme de l'aorte	561
Pince-clamp pour aorte	561
Pince-clamp pour la carotide	537
Pince-clamp utérine pour hémostase	481
Pince-guide et pour protéger la dure-mère	650
Pince à ligatures TITE GRIP	113
Pince à ongles	645
Pince à poser et à retirer les agrafes	379
Pince à préhension de l'intestin ATRAUMATIC-GRIP	389
Pince conductrice pour cathéters et tubes	473
Pince crânienne	688
Pince emporte-pièces à biopsie	460-465
Pince hémostatique rénale	537
Pince patella	623
Pince perce membrane	477
Pince porte-fil	423

Pince porte-laminaires	152
Pince pose clips	690
Pince pour changer les valves	289
Pince pour extraction des ongles	645
Pince pour fixer le cordon	425
Pince pour la préhension du rein	421
Pince pour le cuir chevelu	481
Pince pour ligatures	152
Pince pour poser et retirer les clamps Bulldog	527
Pince pour poser et retirer les clips hémostatiques du cuir chevelu	691
Pince pour poser et retirer les clamps Bulldog TITAN-LINE	160
Pince pour saisir les capsules	423
Pince pour saisir les lambeaux antérieurs	423
Pince pour tunnelisateur	517
Pince thoracique et pour ligatures	564
Pince/couvercle, Combinaison	735
Pince-clamp musculaire	728
Pince à déchets	735
Pinces	668
Pinces-clamps à anastomose (veine cave)	565
Pinces-clamps à anastomose avec denture COOLEY	559, 560
Pinces-clamps à anastomose avec denture DE BAKEY	542-544
Pinces-clamps à anastomose du rectum	400
Pinces-clamps à anastomose du rectum ATRAUMATIC-GRIP	401
Pinces-clamps à bronches	566
Pinces-clamps à bronches ATRAUMATIC-GRIP	552
Pinces-clamps à occlusion ATRAUMATIC-GRIP	398-399
Pinces-clamps auriculaires	564
Pinces-clamps iliaques	558
Pinces-clamps intestinales	390-394
Pinces-clamps intestinales ATRAUMATIC-GRIP	391-393, 395-396
Pinces-clamps intestinales et à anastomose	402
Pinces-clamps pour anastomose	520-523
Pinces-clamps pour anastomose de l'aorte ATRAUMATIC-GRIP	548-549
Pinces-clamps pour anévrisme de l'aorte ATRAUMATIC-GRIP	545-547
Pinces-clamps pour aorte	537
Pinces-clamps pour aorte ATRAUMATIC-GRIP	538-540
Pinces-clamps pour coarctation avec denture COOLEY	557
Pinces-clamps pour coarctation avec denture DE BAKEY	532-533
Pinces-clamps pour fémorale	534
Pinces-clamps pour hémorroïdes	410
Pinces-clamps pour la carotide	527
Pinces-clamps pour la carotide avec denture LAWTON ATRAUMATIC-GRIP	524
Pinces-clamps pour l'intestin et l'estomac	403
Pinces-clamps pour occlusion tangentielle	562
Pinces-clamps pour pédicules rénaux	191
Pinces-clamps pour péritoine	192-193
Pinces-clamps pour veine cave ATRAUMATIC-GRIP	550
Pinces-clamps stomacales ATRAUMATIC-GRIP	397
Pinces-clamps universelles	520-523, 530, 562
Pinces-clamps universelles avec denture DARDIK	554
Pinces-clamps universelles avec denture DE BAKEY	553
Pinces-clamps vasculaires périphériques	534
Pinces-clamps vasculaires périphériques ATRAUMATIC-GRIP	535-536
Pinces- DIU	447
Pinces-gouges	631-636
Pinces-gouges	494
Pinces-guides	650
Pinces-micro	125
Pinces-micro (modèles horloger)	120
Pinces-micro à ligatures	121-123
Pinces-micro à ligatures en titane	123
Pinces-micro en titane pour saisir les tissus	124
Pinces-micro pour saisir les tissus	124
Pinces-Micro TITE GRIP	118
Pinces à affronter	378
Pinces à biopsie rectale	412
Pinces à compresses	200-202
Pinces à couper le fil	668
Pinces à couper le fil DURACUT	667
Pinces à dissection	132-134
Pinces à dissection à griffes TITE GRIP	117
Pinces à dissection TITE GRIP	113-115, 117
Pinces à dissection TITE GRIP modèles standard	115
Pinces à disséquer et à ligatures	180-189, 564
Pinces à disséquer et à ligatures ATRAUMATIC-GRIP	551
Pinces à échardes	150-151
Pinces à envies	17
Pinces à épiler	152
Pinces à hystérectomie	194-197
Pinces à ménisque et cartilage	640
Pinces à ongles	17
Pinces à pansements	208
Pinces à pansements et tampons	204-207
Pinces à polypes et ovaires	457
Pinces à poser les agrafes	379
Pinces à préhension de l'intestin	383-389
Pinces à réduction	622-623
Pinces à retirer les agrafes	379
Pinces à saisir les tendons	647
Pinces à séquestre	623
Pinces à stérilisation	734
Pinces à tampons et éponges	209-210
Pinces à traire les drains	203
Pinces auriculaires et nasales	136-137
Pinces chirurgicales	144-148
Pinces coupantes	637-639
Pinces coupantes à os	494
Pinces coupe-fils	665-666
Pinces de traction crânienne	689
Pinces écartantes à plâtre	682
Pinces écrasantes pour plâtre	682
Pinces emporte-pièces à laminectomie	707-719
Pinces fines à dissection	128-131
Pinces fines chirurgicales	138-143
Pinces hémostatiques	173-178
Pinces hémostatiques et pour amygdales	179
Pinces hémostatiques fines	164-172
Pinces hémostatiques fines en TITANE	164, 166, 168
Pinces hémostatiques rénales	558
Pinces hystérolabes	458
Pinces intestinales	149
Pinces passe-tendos	649
Pinces placentaires et pour poste-abortum	482-483
Pinces pour abaissement du col de l'utérus	452-456
Pinces pour calculs biliaires	418-419
Pinces pour champs en papier	202
Pinces pour dissection des poumons	149
Pinces pour entrelacer les tendons	649
Pinces pour intubation	32
Pinces pour les calculs rénaux	420-421
Pinces pour l'hypophyse	719
Pinces pour microscopie	121
Pinces pour poser les approximateurs	158
Pinces pour poser les clips vasculaires	156
Pinces pour saisir les tissus	149
Pinces pour saisir les tissus et tirer les aiguilles TITE GRIP	116
Pinces pour saisir tumeurs et tissus	126-127
Pinces pour vaisseaux et tumeurs	148-149
Pinces presse-tubes	203
Pinces serre-fils TITE GRIP	662
Pinces tire-broches	663-664
Pinces tire-langue	23
Pinces TITE GRIP	118
Pinces vasculaires ATRAUMATIC-GRIP	520
Pinces vasculaires avec denture COOLEY	555-562
Pinces vasculaires avec denture DE BAKEY	529-530, 537, 554
Pinces vasculaires avec denture LAWTON ATRAUMATIC-GRIP	521-523
Pinces vasculaires pour occlusion tangentielle ATRAUMATIC-GRIP	541
Pinces vasculaires semi flexible	563
Pinces vasculaires, ATRAUMATIC-GRIP	135
Pincettes pour saisir et casser les lames de rasoir	36
PIPER Forceps	480
Pipette en verre	473
Pistolet-laveur à jet d'eau avec plusieurs embouts	754
Pistolet-laveur à jet d'eau, Embouts	755
Placenta et avortement, Curettes	484
Placentaires et pour poste-abortum, Pinces	482-483
Plaies, Crochets	218
Plaque pour tendre la peau seule pour dermatome de SCHINK	41
Plateaux de stérilisation	744
Plateaux pour instruments	748
Plâtre, Pinces écartantes	682
Plâtre, Scie oscillante	680
PLESTER Ecarteurs autostatiques	275
Plomb, Main	644
Pneumopéritoine, Aiguilles	329

Poignées à piles pour spatules de laryngoscopie de MC INTOSH	25, 27, 29, 31
Poignées pour scies	687
Pointes-carrées	650
Polypes et ovaies, Pincés	457
Ponction lombaire, Aiguilles	328
Ponction pleurale, Aiguille	518
Ponction pour os, Tréphine	721
Ponction pour tissu mou, Tréphine	721
Ponction sternale, Aiguilles	518
POOLE Canules d'aspiration	325
Porte-aiguilles	358-372
Porte-aiguilles-Micro	358-362
Porte-aiguilles-Micro en TITANE	362
Porte-aiguilles-Micro TITE GRIP	338-339
Porte-aiguilles avec ciseaux	370
Porte-aiguilles boomerangs	372
Porte-aiguilles pour gauchers TITE GRIP	341
Porte-aiguilles TITAN-LINE	365
Porte-aiguilles TITE GRIP	340-350
Porte-clamps	402
Porte-cotons	316-317, 409, 473
Porte-fil, Pince	423
Porte-lames	473
Porte-laminaires, Pince	152
Porte-ligature	378
Porte-tampon, Conducteur	447
Portes instruments	736
Poste-abortum et placentaires, Pincés	482-483
POTTS-DE BAKEY Patent-ductus, Clamps ATRAUMATIC-GRIP	531
POTTS-SMITH Ciseaux à dissection	98
POTTS-SMITH Ciseaux vasculaires	96-98
POTTS-SMITH Ciseaux vasculaires DURACUT	56
POTTS-SMITH Pincés fines à dissection	131
POTTS-SMITH Pincés fines chirurgicales	143
POTTS-SMITH TITE GRIP Pincés à dissection	114
Poumons, Ecarteur	260
Poumons, Pincés pour dissection	149
Pousse fil	378
POZZI Pince pour abaissement du col de l'utérus	453
PRATT Pincés pour abaissement du col de l'utérus	455
PRATT Sondes pour fistules	409
PRATT spéculum rectal	405-406
Préhension du rein, Pince	421
Prélèvements des sécrétions, Cuillère	425
PREP LUBE Liquide concentré pour entretien des instruments	733
PRESBYTERIAN Pince presse-tubes	203
Presse-tubes, Pincés	203
PRICE-THOMAS Pincés-clamps à bronches	566
Prostatectomie, Instruments	423
Prostatiques, Ecarteurs	422
Prothèses dentaires, récipient	751
PROVIDENCE-HOSPITAL Pincés hémostatiques fines	168
Pulmonaire, Spatule	260
Pulmonaires, Ecarteurs et spatules	261-265
PUTTI Limes à os	594
Pylore, Ecarteur	403
PYNCHON-ANDREW Canule d'aspiration	325

Q

QUERVAIN Elévateur	575
QUINBY Ciseaux pour gencive	94
QUINKE Aiguilles pour ponction lombaire	328

R

RABINER Marteaux à réflexes	3
Racines nerveuses, Rétracteurs	701
RAGNELL-DAVIS Ecarteurs pour la chirurgie plastique	226
RAGNELL Ciseaux à chirurgie et à dissection	83
RAGNELL Ciseaux à dissection DURACUT	49
RAGNELL Ciseaux à dissection et à chirurgie	83
RALK Perforateur à manivelle	653
RALKS Pince à échardes	151
RAMPLEY Pincés à tampons et éponges	210
RANDALL Curette pour biopsie	459

RANDALL Pincés pour les calculs rénaux	420-421
RANEY Agrafes hémostatiques pour cuir chevelu	691
RANEY Pince pour poser et retirer les clips hémostatiques du cuir chevelu	691
RANEY Support porte-agrales	691
RANKIN-CRILE-DEBAKEY Pincés hémostatiques fines	167
RANKIN-CRILE (OCHSNER-DIXON) Pincés hémostatiques fines	167
RANKIN-CRILE Pincés hémostatiques fines	167
RANKIN-KELLY Pincés hémostatiques fines	169
Râpes	592-595
Râpes TITE GRIP	596-597
Râpes, Coupes	595
Rapprocheurs de côtes	508
Raspatoires-rugines	582-591
Raspatoires-rugines avec manche en „Ferrozell“	590-591
RAY Curettes	692
RECAMIER Curettes à avortement et placenta	484
RECAMIER Curettes utérines	468
Récipient à prothèses dentaires	751
Récipients	747
Récipients cylindriques	747
Rectal, Ecarteur	408
Rectale, Ciseaux pour chirurgie DURACUT	59
Rectales, Sondes	409
Rectaux, Spéculums	405-406
Rectum et anus, Dilatateurs	407-408
Rectum et lobectomie, Ciseaux	99
Rectum, Pincés-clamps à anastomose	400
Rectum, Pincés-clamps à anastomose ATRAUMATIC-GRIP	401
REDO Pincés-clamps intestinales	390
REDON Aiguilles guides	334
Réduction, Pincés	622-623
Réflecteur pour bandeaux frontaux de CLAR	11
Règle	6
Règle en acier	6
Règle radiologique	6
REINER Couteau pour appareils plâtrés	679
Rénales, Pincés hémostatiques	537, 558
Rénaux, Clamps	190
Réniformes, Bassins	750
RESANO ATRAUMATIC-GRIP Pince-clamp à anastomose du rectum	401
Réséction et amputation, Scies	572-573
Retracteurs	571
Rétracteurs pour racines nerveuses	701
REVERDIN Aiguilles	373
REVERDIN Spatules abdominaux et intestinaux	267
REYNOLDS-COOLEY ATRAUMATIC-GRIP Pincés-clamps à anastomose avec denture COOLEY	559
REYNOLDS-DE BAKEY ATRAUMATIC-GRIP Pincés-clamps à anastomose avec denture DE BAKEY	542
REYNOLDS Ciseaux fins à dissection	93
REZEK-HEANEY Pincés à hystérectomie	196
RICARD Ecarteurs abdomiaux	298
RICHARDSON-EASTMAN Ecarteurs	250
RICHARDSON Ecarteurs	251
RICHTER-HEATH Pince à retirer les agrafes	379
RICHTER Ciseaux pour opération	80
RIENHOFF-FINOCHIETTO Ecarteur à côtes	506
ROBB Spatules et dilatateurs pour la tunique interne	512
ROBERTS Pincés hémostatiques	178
Robinets	333
ROBSON-MAYO ATRAUMATIC-GRIP Pincés-clamps intestinales	396
ROBSON-MAYO Pincés-clamps intestinales	396
ROCHARD Compas articulé	309
ROCHARD Ecarteurs abdomiaux	309
ROCHESTER-CARMALT Pincés hémostatiques	178
ROCHESTER-OCHSNER Pincés hémostatiques	178
ROCHESTER-PEAN Pincés hémostatiques	175
ROEDER Pincés à compresses	201
ROGERS HEANEY-DE BAKEY Pincés à hystérectomie	197
ROGERS WERTHEIM-DE BAKEY Pincés à hystérectomie	197
ROGGE Pince à stérilisation	734
ROLLET Ecarteur	218
Rongeurs crâniens	688
ROSCHKE Dilatateur pour anus	407
ROSE Ecarteur double	227
ROSEGGER-KLIMA Aiguilles à ponction sternale	329, 518
ROSEN Canules d'aspiration	320
ROSER-KÖNIG Ouvre-bouches	22

RÖTTGEN-RUSKIN Pince-gouge	636
ROUX Ecarteurs doubles	229
Ruban	6
Ruban métrique	6
Ruban métrique acier	6
Ruban métrique toile cirée	6
RUDD Ligateur hémorroïdal	410
Rugines-raspatoires	582-591, 694-697
Rugines-raspatoires avec manche en „Ferrozell“	590-591
Rugines à costales	495, 497
Rugines à périostomie	496
RUMEL-BELMONT Tourniquets	518
RUMEL-DE BAKEY Pincés à disséquer et à ligatures	186
RUMEL Pincés à disséquer et à ligatures	186
RUSKIN-LISTON Pincés coupantes	638
RUSKIN-RÖTTGEN Pince-gouge	636
RUSKIN-STILLE Pince-gouge	636
RUSKIN Pince coupante	638
RUSKIN Pincés-gouges	633-634
RUSS. MODELL Pincés pour vaisseaux et tumeurs	149
RUST Scie à amputation et résection	573
RYDER-LANGENBECK TITE GRIP Porte-aiguilles	350
RYDER-SEIFFER Diapason pour neurologie	4
RYDER-VASCUALR TITE GRIP Porte-aiguilles	340
RYDER TITE GRIP Porte-aiguilles	340

S

SAALFELD Tire-comédons	19
SACHS Crochet pour fistules	221
SACHS Crochet pour la dure-mère	217
SACHS Dissecteurs pour la dure-mère	698
SACHSE Méatotome	426
SAENGER Pincés placentaires et pour poste-abortum	483
SALENIUS Bistouris à ménisque	642
SALING Amnioscopes	472
SAMII-YASARGIL Pincés pour saisir tumeurs et tissus	126
SAMII Pincés pour saisir tumeurs et tissus	127
SANVENERO Ciseaux pour chirurgie plastique	70
SAROT Pincés-clamps à bronches	566
SAROT Pincés hémostatiques fines	171
SAROT TITE-GRIP Porte-aiguilles	344
SATINSIKY Ciseaux pour la veine cave	99
SATINSKI-BABY Pincés-clamps à anastomose (veine cave)	565
SATINSKI Pincés-clamps à anastomose (veine cave)	565
SATINSKY-DE BAKEY ATRAUMATIC-GRIP Clamps Bulldog	525
SATINSKY-DE BAKEY ATRAUMATIC-GRIP Pincés vasculaires pour occlusion tangentielle	541
SATTERLEE Scie à amputation et résection	572
SAUER Pince fine chirurgicale	138
SAUERBRUCH-FREY Costotome	493
SAUERBRUCH-SCHNEIDER Rugine-raspatoire	588
SAUERBRUCH Boîtes pour stériliser des aiguilles de suture	357
SAUERBRUCH Costotome	492
SAUERBRUCH Ecarteurs	242
SAUERBRUCH Pincés à déchets	735
SCALP CONTOUR Ecarteurs autostatiques	276
Scapula, Ecarteurs	260
SCHAAF Pince à épiler	152
SCHÄDEL Pincés à compresses	200
SCHAMBERG Tire-comédons	19
SCHUDE Curettes	602
SCHERBACK Spéculums vaginaux	442
SCHINK Dermatome	41
SCHMID Aiguilles vasculaires pour irrigation	322
SCHMID Spatules pour la tunique interne	513
SCHMIEDEN-TAYLOR Ciseaux pour dure-mère	100
SCHMIEDEN Spatules conductrices	378
SCHNEIDER-SAUERBRUCH Rugine-raspatoire	588
SCHNEIDER Rugine-raspatoires	588
SCHNIDT Pincés hémostatiques et pour amygdales	179
SCHOEMAKER-LOTH Ciseaux à ligatures	352
SCHRÖDER Curettes utérines	466
SCHRÖDER Pincés pour abaissement du col de l'utérus	452, 454
SCHUBERT Pincés emporte-pièces à biopsie	461
SCHULTZE Salpingographie	474
SCHUMACHER Ciseaux pour le cordon ombilical	108
SCHUMACHER Pincés emporte-pièces à biopsie	463

SCHWARTZ Applicateur pour clips vasculaires	155
SCHWARTZ Serre-Fines	155
Scie oscillante à plâtre	680
Scie pour appareils plâtrés	679
Scie, Fils	687
Scie, Poignées	687
Scies à amputation et résection	572-573
Scies pour bagues	645
Scies, Conducteur	687
SCOVILLE-HAVERFIELD Ecarteur pour laminectomie	286
SCOVILLE (TOENNIS-OLIVECRONA) Pince pose clips	690
SCOVILLE Ecarteur pour laminectomie	286
SCOVILLE Rétracteurs pour racines nerveuses	701
SCOVILLE Valves latérales	287
SCUDDER ATRAUMATIC-GRIP Pincés-clamps stomacales	397
SEALY Ciseaux chirurgicaux fins	68
SEBILEAU Élévateur	575
SEDILLOT Rugines-raspatoires	586
SEGOND Pincés à hystérectomie	195-196
SEIFFER-RYDER Diapason pour neurologie	4
SELETZ-GELPI Ecarteur vulvaire	281
SELLHEIM Levier obstétrique	481
SELLORS Ecarteur et rapprocheur	508
SEMB Daviers à os	493
SEMB Ecarteur à poumons	260
SEMB Pincés-gouges	494
SEMB Pincés à disséquer et à ligatures	564
SEMB Pincés coupantes à os	494
SEMB Rugines à périostomie	496
SEMKEN Pincés fines à dissection	130
SEMKEN Pincés fines chirurgicales	142
SEMKEN TITE-GRIP Pince à dissection	113
SEMKEN TITE-GRIP Pincés à dissection à griffes	117
SEMM Ecarteur abdominal	305
SEMM Spéculums vaginaux	432
SENN-GREEN Ecarteurs	224
SENN-MILLER Ecarteurs doubles	226
Septum, Ciseaux DURACUT	59
Séquestre, Pincés	623
Seringue pour tuberculine	330
Seringues	330-332
Seringues auriculaires	332
Seringues pour insuline	330
Seringues vésicales	331
Serre-fil	660
Serre-fils, pincés TITE GRIP	662
Serre-Fines	154-156
Set pour la biopsie vertébrale CRAIG-KOLGER	720-721
SEUTIN Cisailles pour étoffes d'habillement et appareils plâtrés	675
SEWALL Rugine-raspatoire	582
SIEBOLD-SIMS Ciseaux utérins	106
SIEBOLD Ciseaux utérins	106
SILVER Dermatome	41
SIMON-HEANEY Ecarteur pour interventions en profondeur	254
SIMON Crochet pour fistules	221
SIMON Curettes	605
SIMON Curettes utérines	466
SIMON Ecarteur pour interventions en profondeur	254
SIMPSON-BRAUN Forceps	478
SIMPSON Hystéromètre	446
SIMS-MAIER Pincés à pansements et tampons	205
SIMS-SIEBOLD Ciseaux utérins	106
SIMS Ciseaux pour gynécologie DURACUT	60
SIMS Ciseaux utérins	104-105
SIMS Ciseaux utérins DURACUT	60
SIMS Curettes utérines	467
SIMS Hystéromètres	446
SIMS Spéculums rectaux	405-406
SIMS Spéculums vaginaux	438
SINGLEY TUTTLE Pincés à dissection des poumons	149
Sinus maxillaire, Trocarts	319-320
SMELLIE Perce-crâne	485
SMILLIE Bistouris à ménisque	643
SMILLIE Ecarteurs pour genou	641
SMITH-BUIE Dilatateur pour anus et rectum	408
SMITH-FERRIS-CUSHING Pincés emporte-pièces à laminectomie	713
SMITH-FERRIS Pincés chirurgicales	147
SMITH-HEYWOOD Pince à polypes et ovaires	457
SMITH-HEYWOOD Pincés tire-langue	23

SMITH-KERRISON-FERRIS Pincés emporte-pièces à laminectomie 709-711
SMITH-POTTS Ciseaux vasculaires DURACUT 56
SMITH-POTTS Ciseaux à dissection 98
SMITH-POTTS Ciseaux vasculaires 96-98
SMITH-POTTS Pincés fines à dissection 131
SMITH-POTTS Pincés fines chirurgicales 143
SMITH Ciseaux à pansements 672
SOFT-GREGORY ATRAUMATIC-GRIP Clamps Bulldog
avec denture **DE BAKEY** 527
SOFT-GREGORY Pincés-clamps pour la carotide 527
Soie à suture 353
SOMER Pince hystérolabe 458
Sonde-curette pour vésicule biliaire 415
Sonde boutonée 694
Sonde double 694
Sonde pour mesurer 450
Sondes 314, 450-451
Sondes à endartérectomie 514
Sondes auriculaires 322
Sondes boutonées 312-313
Sondes boutonées cannelées 314
Sondes cannelées 314
Sondes conductrices 377
Sondes pour fistules 314, 409
Sondes rectales 409
Sondes vésicales métalliques 424
Spatule pour la tunique interne 513
Spatule pulmonaire 260
Spatules à goitres 378
Spatules abdominales et intestinales 266-267
Spatules cérébrales 706
Spatules conductrices 378
Spatules de laryngoscopie 25, 27, 29, 31
Spatules de laryngoscopie avec lumière froide 27, 31
Spatules et dilataeurs pour la tunique interne 512
Spatules et écarteurs pulmonaires 261-265
Spatules vésicales 268
Spatules, support 703
Spécula pour la hypophysectomie 692
Spéculum latéral 448
Spéculums et valves vaginaux 434-437, 439
Spéculums pour urètre et col utérin 448
Spéculums rectaux 405-406
Spéculums vaginaux 430-442
SPENCER-WELLS Pincés hémostatiques 173
SPENCER (NORTHBENT) Ciseaux à ligatures 352
SPENCER Ciseaux à ligatures 352
Sphinctéoscopes 407
Spinale, Gouge 616
Spongiose, Ciseaux-burins 615
SPRATT Curettes 602
SPURLING Pincés emporte-pièces à laminectomie 717, 719
ST. MARKS Ecarteurs pour interventions en profondeur 258
ST. MARTIN Pince fine chirurgicale 139
STACKE Sonde boutonée 313
STADLER-BRAUN Ciseaux à périmée 107
STANDARD-YASARGIL Applicateurs pour clips vasculaires 154
STANDARD-YASARGIL Serre-Fines 154
STAUDE-MOORE Pince pour abaissement du col de l'utérus 452
STEINMANN Clous 654
STEINMANN Pince à saisir les tendons 647
STELLBRING Pincés-gouges 632
STELZNER CRAFOORD Ciseaux à lobectomie et pour le rectum 99
Stérilisation des aiguilles à suture, Support 736
Stérilisation et coservation, Boîtes 738
Stérilisation, Boîtes 739-741
Stérilisation, Boîtes en plastigue 742
Stérilisation, Boîtes rondes 743
Stérilisation, Cadres 737
Stérilisation, Chevalets 737
Stérilisation, Paniers 745
Stérilisation, Plateaux 744
Sternotomie, Ecarteurs 499
Sternotomie, Ecarteurs en ALUMINIUM 498
Sternum, Ciseau-burins et cisaille 492
Stéthoscopes 5
Stéthoscopes combiné en métal léger 5
Stéthoscopes en aluminium 5
Stéthoscopes en bois 5

STEVENS Ciseaux fins à dissection 92
STEVENS Ciseaux fins à dissection avec grands anneaux ergonomiques 92
STIEGLITZ (WILLIAMS) Pincés à échardes 151
STILLE-BARRAYA Pincés vaisseaux et tumeurs 148
STILLE-CRAFOORD Pincés hémostatiques fines 170
STILLE-DOYEN Ecarteurs 247
STILLE-GIERTZ Costotome 492
STILLE-LEKSELL Pincés-gouges 635
STILLE-LUER Pincés-gouges 634, 636
STILLE-MAYO Ciseaux à dissection 85
STILLE-MAYO Ciseaux à dissection DURACUT 48
STILLE-MINI Cisailles pour appareils plâtrés 677
STILLE-RUSKIN Pince-gouge 636
STILLE-STRANDELL Ecarteurs à gaines tendineuses 225
STILLE Cisailles pour appareils plâtrés 677, 678
STILLE Ciseaux-burins 610
STILLE Gouges 610
STILLE Ostéotomes 610
STILLE Perforateur à main 651
STILLE Pince-gouge 635
STOCKMANN Compresseur de l'urètre 426
Stomacales, Pincés-clamps ATRAUMATIC-GRIP 397
STRANDELL-STILLE Ecarteurs à gaines tendineuses 225
STRATTE TITE GRIP Porte-aiguilles 347
STRAUSS Compresseur de l'urètre 426
Strippers à tendons 646
Strippers à varices 315
STRULLY Ciseaux pour la neuro-chirurgie 100
Styler feuille de sauge 313
Stylets 312-313
Stylets aiguillés 313
Stylets pour le canal lacrymal 312
SUBRAMANIAN Pincés-clamps pour aorte 537
SULLIVAN BROPHY Ciseaux fins à dissection 93
SUPER Stéthoscopes combiné en métal léger 5
Support de main 644
Support pour stériliser les aiguilles à suture 736
Supports porte-agrafes 690-691
Supports pour spatules 703
Suture, Appareil 404
Suture, Instruments 378, 690-691
Suture, Soie 353
Sutures, Aiguilles 354-356
Sutures, Nécessaire 380
SWEET-LAHEY Pincés à disséquer et à ligatures 189
SWITZERLAND (MOD.) Micro-pincés (modèles horloger) 120
SYSTRUNK Ciseaux à fendre les ongles 81

T

Table d'opération, Ecarteurs pour fixation 704
TAKAHASHI Pincés emporte-pièces à laminectomie 714
Tampons et éponges, Pincés 209-210
Tampons et pansement, Pincés 204-207
TARNIER Forceps 480
TAYLOR-CUSHING Pince fine pour dissection 131
TAYLOR-CUSHING Pincés auriculaires et nasales 136
TAYLOR-CUSHING TITE-GRIP Pince à dissection 114
TAYLOR-CUSING Pince fine chirurgicale 143
TAYLOR-SCHMIEDEN Ciseaux pour dure-mère 100
TAYLOR Marteaux à réflexes 2
TAYLOR Valves latérales 287
TEALE Pincés pour abaissement du col de l'utérus 456
Tendeur de broches 658
Tendons, Conducteurs 646, 648
Tendons, Pincés à saisir 647
Tendons, pincés pour entrelacer 649
Tendons, Strippers 646
Tendons-passe, Pincés 649
Ténotome 37
Ténotomie et dissection, Ciseaux fins 92
Têtes d'accouplement 705
THOMAS-PRICE Pincés-clamps à bronches 566
THOMS-ALLIS Pince à préhension de l'intestin 385
THOMS-GAYLOR Pince emporte-pièces à biopsie 460
Thoracique et pour ligatures, Pince 564
Thoracique, Ecarteur 507
THOREK-METZENBAUM Ciseaux adnex DURACUT 54

- THOREK** Ciseaux à dissection 98
THORLAKSON ATRAUMATIC-GRIP Pincés-clamps à occlusion 398-399
THORLAKSON Ecarteurs doubles 230
THORLAKSON Ecarteurs pour interventions en profondeur 256-257
 Tire-broches, Pincés 663-664
 Tire-comédons 19
TISCHLER-MORGAN Pince emporte-pièces à biopsie 464
TISCHLER-BABY Pince emporte-pièces à biopsie 464
TISCHLER Pincés emporte-pièces à biopsie 465
 Tissu mou, Tréphine de ponction 721
 Tissus et aiguilles, TITE GRIP Pincés pour saisir et tirer 116
 Tissus et peau, Crochet double pour saisir et soulever 212
 Tissus et tumeurs, Pincés pour saisir 126-127
 Tissus moux, Double griffe pour extraction 721
 Tissus, Micro-pincés 124
 Tissus, Pincés 149
TITAN-LINE Clamps Bulldog 160-161
TITAN-LINE Pince pour poser et retirer les clamps Bulldog en titane 160
TITAN-LINE Porte-aiguilles 365
TITANE CRILE Pincés hémostatiques fines 166
TITANE HALSTED-MOSQUITO Pincés hémostatiques fines 164
TITANE KELLY Pincés hémostatiques fines 168
TITANE Pincés hémostatiques fines 164, 166, 168
TITANE, Micro-pincés à ligatures 123
TITANE, Micro-pincés pour saisir les tissus 124
TITANE, Micro-Porte-aiguilles 362
TITE GRIP Micro-Pincés 118
TITE GRIP Pincés 118
TITE GRIP Pincés-Micro 118
TITE GRIP Pincés à dissection 113-115, 117
TITE GRIP Pincés à dissection à griffes 117
TITE GRIP Pincés à dissection modèles standard 115
TITE GRIP Pincés à ligatures 113
TITE GRIP Pincés pour saisir les tissus et tirer les aiguilles 116
TITE GRIP Micro-Porte-aiguilles 338-339
TITE GRIP Pincés serre-fils 662
TITE GRIP Porte-aiguilles 340-350
TITE GRIP Porte-aiguilles pour gauchers 341
TITE GRIP Râpes 596-597
TOENNIS-ADSON Ciseaux à dissection 89
TOENNIS-ADSON Ciseaux à dissection DURACUT 49
TOENNIS-OLIVECRONA (SCOVILLE) Pince pose clips 690
TOENNIS Ciseaux à chirurgie et à dissection 83
TOENNIS Ciseaux à dissection et à chirurgie 83
TOENNIS Dissecteurs pour la dure-mère 700
TOENNIS Porte-aiguilles 371
TOENNIS TITE GRIP Porte-aiguilles 350
TOHOKU Pincés pour champs en papier 202
TÖNNIS Couteaux pour dure-mère 37
 Tourniquets 518
TOWNSEND Pincés emporte-pièces à biopsie 465
 Trachée, Ecarteur 226
 Trachéotomie, Canules 725-727
 Trachéotomie, Dilatateurs 728
 Trachéotomie, Ecarteurs 217, 219-220, 728
 Trachéotomie, Instruments 728-730
 Trachéotomie, Jeu d'instruments 729-730
 Trachéotomie, Trocarts avec canule argent 728
 Tracteurs pour fibrome 458
 Traction crânienne, Alésoirs pour étirer 689
 Traction crânienne, Etriers 689
 Traction crânienne, Pincés 689
 Transformateur pour bandeaux frontaux 11
 Transformateurs 11, 472
TRELAT Rugine-raspatoire 582
TRELAT Spéculum vaginaux 431
 Trépan cutané 20
 Tréphine de ponction pour os 721
 Tréphine de ponction pour tissu mou 721
 Triangulaires, Bassins 750
 Trocart, Canule 721
 Trocarts 318, 721
 Trocarts pour la trachéotomie avec canule argent 728
 Trocarts pour le sinus maxillaire 319-320
TROELTSCH (WILDE) Pincés auriculaires et nasales 137
TROELTSCH Pincés auriculaires et nasales 137
TROEMNER Marteaux à réflexes 3
TROUSSEAU Dilatateur pour la trachéotomie 728
 Trousses à laryngoscopie 24, 26, 30
 Trousses à laryngoscopie lumière froide 26, 30
TROUTMAN-BARRAQUER Micro-Porte-aiguilles 360
TROUTMAN Pincette pour saisir et casser les lames de rasoir 36
TUBBS Dilatateur aortique 511
 Tube compressif 570
 Tube plastique 473
 Tubes et cathéters, Pince conductrice 473
TÜBINGEN (MOD.) VANNAS Micro-ciseaux 62
TUFFIER Ecarteur à côtes 506
TUFFIER Spatules abdominaux et intestinaux 267
 Tumeurs et tissus, Pincés pour saisir 126-127
 Tumeurs et vaisseaux, Pincés 148-149
 Tunique interne, Couteau 513
 Tunique interne, Spatules 513
 Tunique interne, Spatules et dilatateurs 512
 Tunnelisateur avec manche 517
 Tunnelisateur pour bypass 517
 Tunneliser, Jeu 516
 Tunnelisateur, Pince 517
TUOHY Aiguilles pour ponction lombaire 328
TUTTLE (SINGLEY) Pincés à dissection des poumons 149
TYRELL GRAEFE Crochets à peau 216
- U**
- UCKERMANN** Porte-cotons 317
UECKERMANN-DENKER Trocarts pour la trachéotomie
 avec canule argent 728
UFFENORDE Curettes 601
ULRICH Bistouris pour fistules 37
ULRICH Daviers 627
ULRICH Pincés à pansements et tampons 206
UNIVERSAL Pincés coupe-fils 665
UNIVERSAL Trocarts 318
UNNA-VIDAL Tire-comédons 19
UNNA Tire-comédons 19
 Uréthrographe 426
 Urètre, Compresseur 426
 Urologie, Instruments 425-426
US-ARMY (PARKER-LANGENBECK) Ecarteurs 231
USA (MOD.) Ciseaux pour le cordon ombilical 108
USA (MOD.) Pincés à dissection modèles étroits 133
USA (MOD.) Pincés à dissection modèles standard 133
USA (MOD.) Pincés chirurgicales 145
USA MOD. Curettes 601
USA MOD. Pince écartantes à plâtre 682
 Utérine, Pince-clamp pour hémostase 481
 Utérines, Curettes 466-470
 Utérins, Ciseaux 104-106
 Utérins, Ciseaux DURACUT 60
 Utérus, Dilatateurs du col 443-445
- V**
- V.EICKEN LICHTWITZ** Trocarts pour ponction du sinus maxillaire 319
 Vaisseaux et nerf, Crochets 213-215
 Vaisseaux et tumeurs, Pincés 148-149
 Vaisseaux, Couteaux 694-695
VALLEIX Hystéromètre 446
 Valves 293
 Valves en VINYL pour écarteurs abdominal **FOERSTER** 308
 Valves et spéculum vaginaux 434-437, 439
 Valves latérales 287, 289, 293
 Valves pour écarteurs abdominaux **KIRSCHNER-BALFOUR** 307
 Valves pour écarteurs abdominaux **KIRSCHNER** 307
VAN BUREN Bougies dialatatrices 424
VAN BUREN Pince à séquestre 623
VAN DOREN Pince emporte-pièces à biopsie 461
VANNAS-YASARGIL Micro-ciseaux 66
VANNAS Micro-ciseaux 62, 63, 65
VANNAS MOD. TÜBINGEN Micro-ciseaux 62
VARCO Pincés hémostatiques fines 170
 Varices, Strippers 315
 Vasculaires et Fistules, Ciseaux 80
 Vasculaires périphériques, Pincés-clamps 534
 Vasculaires périphériques, Pincés-clamps avec
 denture **DE BAKEY** ATRAUMATIC-GRIP 535-536

Vasculaires, Aiguilles	354
Vasculaires, Applicateurs pour clips	154-155
Vasculaires, Ciseaux	95-98
Vasculaires, Ciseaux DURACUT	56-57
Vasculaires, Dilatateurs	510
Vasculaires, Pincés ATRAUMATIC-GRIP	520
Vasculaires, Pincés avec denture COOLEY ATRAUMATIC-GRIP	555-562
Vasculaires, Pincés avec denture DE BAKEY ATRAUMATIC-GRIP	529-530, 537, 554
Vasculaires, Pincés avec denture LAWTON ATRAUMATIC-GRIP	521-523
Vasculaires, Pincés pour occlusion tangentielle ATRAUMATIC-GRIP	541
Vasculaires, Pincés pour poser les clips vasculaires	156
Vasculaires, Pincés semi flexible	563
VASCULAR Porte-aiguilles	364
VASCULAR TITAN-LINE Porte-aiguilles	365
Veine cave, Ciseaux	99
Veine cave, Pincés-clamps avec denture DE BAKEY ATRAUMATIC-GRIP	550
Veines et hile rénal, Ecarteurs	223
Veines, Ciseaux-micro	63
Veines, Ecarteurs	217, 222-223
VERBRUGGE-MÜLLER Leviers à os	579
VERBRUGGE Daviers	628
VERESS Aiguilles pour le pneumopéritoine	329
VERNET-GIL MARBERGER Ecarteur à veines et à hile rénal	223
Vésicale, Dilatateur	423
Vésicales, Sondes métalliques	424
Vésicales, Spatules	268
Vésicaux, Ecarteurs	310
Vésicule biliaire, Cuiller	417
Vésicule biliaire, Sonde-curette	415
VICKERS Distributeur de broches filiformes	657
VICKERS Ecarteurs pour doigts	271
VICKERS Ecarteurs pour mains	271
VICKERS Support de main	644
VIDAL-UNNA Tire-comédons	19
VIDAL Grattoir pour lupus	19
VIRCHOW Couteau à cerveau	40
Vis pour fixation des disques	659
WISE Micro-pincés à ligatures	122
VOGEL Trocart pour la ponction du sinus maxillaire	319
Voies biliaires, Dilatateurs	415
VOLKMANN Curettes	600, 602, 606
VOLKMANN Ecarteurs	232-234
VOLKMANN Ecarteurs et Ecarteurs à os	232
VON PETZ Appareils pour la suture gastro-intestinale	404
Vulvaires, Ecarteurs	281

W

WAGENER Crochets à nerfs et à vaisseaux	213
WAGNER Levier à os	577
WAGNER Maillets	620
WAGNER Rugines-raspatoires avec manche en „Ferrozell“	591
WALB Couteau à autopsie	40
WALDMANN Ciseaux à périnée	107
WALTON-LISTON (BÖHLER) Pincés coupantes	638
WANGENSTEEN Porte-aiguilles	369
WANGENSTEEN TITE GRIP Pincés à dissection	115
WANGENSTEEN TITE GRIP Porte-aiguilles	347
WARTENBERG Algésimètre	4
WATSON-CHEYNE Dissecteur	574
WATSON-WILLIAMS Râpe	593
WAUGH Pince fine à dissection	131
WAUGH Pince fine chirurgicale	143
WEBER Aesthésiomètre	4
WEBER ATRAUMATIC-GRIP Pincés-clamps pour anastomose de l'aorte avec denture DE BAKEY	548
WEBSTER Porte-aiguilles	363
WEBSTER TITE-GRIP Porte-aiguilles	342
WEIL-BLAKESLEY Pincés emporte-pièces à laminectomie	714
WEISSBARTH Spéculum vaginal	442
WEITLANER Ecarteurs autostatiques	272-274
WELLS-SPENCER Pincés hémostatiques	173
WERTEHIM-DE BAKEY (ROGERS) Pincés à hystérectomie	197
WERTEHIM BOZEMANN TITE-GRIP Porte-aiguilles	346
WERTHEIM-CULLEN Pincés-clamps pour pédicules rénaux	191
WERTHEIM Ciseaux utérins	105

WERTHEIM Pincés à hystérectomie	194-195
WEST Ciseaux-burins	607
WEST Gouges	607, 612, 614
WIENER MOD. Porte-ligature	378
WIENER Râpes	593
WILDE TROELTSCH Pince auriculaires et nasales	137
WILLETT Pince pour le cuir chevelu	481
WILLIAMS-WATSON Râpe	593
WILLIAMS Pince à préhension de l'intestin	388
WILLIAMS STIEGLITZ Pincés à échardes	151
WILLIGER Curettes	598, 600
WILLIGER Elévateurs	574
WILLIGER Maillet	617
WILLIGER Rugine-raspatoire	582
WINTER Pincés placentaires et pour poste-abortum	482
WINTER Stéthoscopes en bois	5
WITTNER Pincés emporte-pièces à biopsie	462
WOLFF Pincés écrasantes pour plâtre	682
WOLFSON-DE MARTEL Clamps pour anastomose	402
WOLFSON-DE MARTEL Pince pour fermer les clamps	402
WOLFSON-DE MARTEL Porte-clamps	402
WOOD-CRILE Porte-aiguilles	366, 368
WOOD-CRILE TITE GRIP Porte-aiguilles	343
WOOD-CRILE TITE GRIP Porte-aiguilles pour gauchers	341
WRIGLEY Forceps	480
WULLSTEIN Canules d'aspiration	321-322
WULLSTEIN Ecarteurs autostatiques	275
WYLLIE ATRAUMATIC-GRIP Pincés-clamps pour anastomose de l'aorte avec denture DE BAKEY	549

Y

YANKAUER Canule d'aspiration	325-326
YASARGIL-MINI Applicateurs pour clips vasculaires	154
YASARGIL-MINI Serre-Fines	154
YASARGIL-SAMII Pincés pour saisir tumeurs et tissus	126
YASARGIL-STANDARD Applicateurs pour clips vasculaires	154
YASARGIL-STANDARD Serre-Fines	154
YASARGIL-VANNAS Micro-ciseaux	66
YASARGIL Canules d'aspiration	324
YASARGIL Couteaux pour vaisseaux	695
YASARGIL Crochet à molle pour fixer la galea	691
YASARGIL Curette tranchante	695
YASARGIL Dissecteur	694
YASARGIL Micro-ciseaux	66-67
YASARGIL Micro-pincés	125
YASARGIL Passe-fils	697
YASARGIL Pince pour l'hypophyse	719
YASARGIL Pincés pour saisir tumeurs et tissus	126
YASARGIL Rugines-raspatoires	694-695
YEOMAN Pincés à biopsie rectale	412
YOUNG-HRYNTSCHAK Porte-aiguilles boomerangs	372
YOUNG-MILLIN Porte-aiguilles boomerangs	372
YOUNG Crochet en bulbus	422
YOUNG Ecarteurs prostatiques	422
YOUNG Pince tire-langue	23
YOUNGE-KEVOURKIAN Curettes pour biopsie	459
YOUNGE-KEVOURKIAN Pince emporte-pièces à biopsie	463, 465

Z

ZAUFAL-JANSEN Pince-gouge	633
ZENKER Ecarteurs pour interventions en profondeur	259
ZENKER Pincés à disséquer et à ligatures	188
ZIEGLER Bandeau frontal plastique noir	10
ZIEGLER Miroir frontal complet	10
ZOELLNER Canule d'aspiration	321
ZWEIFEL TITE GRIP Porte-aiguilles	349

A

- Abbassalingua 12
 Abbassare il collo dell'utero, Pinze 452-456
ABRAMS Ago per la puntura della pleura 329, 518
 Accessori per autofissatori di retrattori di **LEYLA** 703, 705
 Accoppiamento, Porta asta per teste 705
ADAIR-ALLIS Pinza da presa per intestino e tessuti 384
ADAIR Pinza per abbassare il collo dell'utero 452
ADAMS-MAYO Divaricatori per appendicectomia 284
 Adattatore per la connessione delle curette per aspirazione 471
 Addominali e intestinali, Spatole 266-267
 Addominali, Divaricatori 297-306, 308
 Addominali, Forbici 106
ADLERKREUTZ Pinze per chirurgia 148
 Adnex, Forbici **DURACUT** 54
ADSON-ANDERSON Divaricatore autostatico 276
ADSON-BABY Pinze per preparazioni e legature 180
ADSON-BECKMANN Divaricatori per laminectomia 279
ADSON-BROWN Pinze fini per chirurgia 141
ADSON-BROWN Pinze per dissezione con denti 117
ADSON-MICRO Pinze anatomiche per dissezione, fini 129
ADSON-MICRO Pinze fini per chirurgia 140-141
ADSON-MICRO Pinze per dissezione con denti 117
ADSON-TOENNIS **DURACUT** Forbici per dissezione 49
ADSON-TOENNIS Forbici per dissezione 89
ADSON Cannule per aspirazione con interruttore e stiletto 323
ADSON Divaricatore per laminectomia 276
ADSON Divaricatore per laminectomia 280
ADSON Divaricatori autostatici 273, 278
ADSON Divaricatori per emilaminectomia 277
ADSON Periostotomi 586
ADSON Pinza guida sonda e per la protezione della dura-madre 650
ADSON Pinze anatomiche per dissezione, fini 129
ADSON Pinze emostatiche fini 169
ADSON Pinze fini per chirurgia 140-141
ADSON Pinze per dissezione con denti 117
ADSON Portaghi 367
ADSON Punta a spirale 652
ADSON TITE GRIP Pinze anatomiche per dissezione 113
ADSON Uncini per nervi e vasi 215
 Aghi chirurgici per sutura 354-356
 Aghi di **REVERDIN** 373
 Aghi di ricambio per portaghi a boomerang 372
 Aghi e tessuti, Pinze **TITE GRIP** 116
 Aghi passafili 661
 Aghi per biopsia 329, 518
 Aghi per il pneumo-peritoneo 329
 Aghi per introduzione 334
 Aghi per la puntura cieca del fegato 329
 Aghi per la puntura dello sterno 329, 518
 Aghi per legatura 374-376
 Aghi per oftalmologia 354
 Aghi per punture lombari 328
 Aghi per sutura intestinale 354
 Aghi per sutura vascolare 354
 Aghi special 328
 Aghi vascolari per irrigazione 322
 Ago per iniezione 486
 Ago per la puntura della pleura 329, 518
 Ago per setto nasale 328
 Ago per tonsille 328
 Ago, Guida 486
ALAN-PARK Dilatatore rettale con chiusura a scatto 408
ALDERDYCE Dissettori 574
ALDINGER-HOHMANN Leve per ossa 580
 Alesatore per pinze di trazione craniale 689
 Aletta nasale, Forbici 81
ALEXANDER-FARABEUF Periostotomi costali 497
ALEXANDER Osteotomi 609
ALEXANDER Pinza per la biopsia cervicale e da prelievo 463
ALEXANDER Scalpelli 609
ALEXANDER Sgorbie 609
 Algesiometro 4
ALLEN Pinze intestinali 390
ALLIS-ADAIR Pinza da presa per intestino e tessuti 384
ALLIS-BABY Pinze da presa per intestino e tessuti 383
ALLIS-BOYS Pinza da presa per intestino e tessuti 384
ALLIS-JUDD Pinza da presa per intestino e tessuti 384
ALLIS-THOMS Pinza da presa per intestino e tessuti 385
ALLIS ATRAUMATIC-GRIP Pinza da presa per intestino e tessuti 389
ALLIS Pinze da presa per intestino e tessuti 383-385
ALLISON Divaricatore per polmone 260
ALM Divaricatori autostatici 270
ALY Algesiometro 4
AMANN Porta garza uterino 447
 Amnioscopia e il salasso, Strumentario 472-473
 Amnioscopio conico 472
 Amnioscopio per salasso, conico 472
 Amnioscopio, Illuminatore prossimale a luce calda con lampada 472
 Amnioscopio, Illuminatore prossimale a luce fredda 472
 Amniotica, Pinza per la puntura 477
 Amniotomo 477
 Amputazione 570
 Amputazione e resezione, Coltello 39
 Amputazione e resezione, Seghe 572-573
 Amputazione, Coltelli 38
 Amputazione, Retrattore 571
AN BUREN Candelette dilatatrici 424
 Anastomosi del colon, Pinze 402
 Anastomosi del retto, Pinze 400-401
 Anastomosi del retto, Pinze ATRAUMATIC-GRIP 400-401
 Anastomosi dell'aorta, Pinze ATRAUMATIC-GRIP 548-549
 Anastomosi, Pinze (vena cava) 565
 Anastomosi, Pinze ATRAUMATIC-GRIP 520-523
 Anastomosi, Pinze con dentatura **COOLEY** ATRAUMATIC-GRIP 559-560
 Anastomosi, Pinze con dentatura **DE BAKEY** ATRAUMATIC-GRIP 542-544
 Anastomosi, Pinze intestinali 402
 Anatomiche, Pinze per dissezione 132-134
 Anatomiche, Pinze per dissezione **TITE GRIP** 112-115
ANDERSON-ADSON Divaricatore autostatico 276
ANDREW-PYNCHON Tubo aspirazione 325
 Anelli di gomma per legatori 410
 Anelli, Seghe 645
 Aneurisma dell'aorta, Pinza ATRAUMATIC-GRIP 561
 Aneurisma dell'aorta, Pinza con dentatura
DE BAKEY ATRAUMATIC-GRIP 545-547
 Ano ed il retto, Dilatatori 407-408
 Anoscopi 407
 Anoscopi con otturatore di plastica 407
 Aorta, Dilatatori 511
 Aorta, Pinza per l'aneurisma ATRAUMATIC-GRIP 561
 Aorta, Pinze ATRAUMATIC-GRIP 561
 Aorta, Pinze con dentatura **DE BAKEY** ATRAUMATIC-GRIP 537-540
 Aorta, Pinze per l'anastomosi ATRAUMATIC-GRIP 548-549
 Aorta, Pinze per l'aneurisma ATRAUMATIC-GRIP 545-547
 Apertura del cranio, Strumenti 687
 Apparecchiatura di sutura gastro-intestinale 404
 Apparecchio e lapis per marcare e scrivere 757
 Apparecchio elettrico per marcare e scrivere 757
 Apparecchio per arrestare il sangue nelle estremità 570
 Appendicectomia, Clamp e pinza schiaccia sperone 403
 Appendicectomia, Divaricatori 284
 Applicare e rimuovere clamps, Pinze 527
 Applicare le agrafe emostatiche al cuoio capelluto, Pinza 691
 Applicatori per clips vascolari 154-156
 Approssimatori 157-159
 Approssimatori costali 508
 Apri gesso 682
 Apriboccas 22
 Archi per trazione 654, 658-659
 Archi per trazione, Chiave 659
 Arco di trazione, Cavo 654
ARMYTAGE-GREEN Pinza emostatica per tagli cesarei 481
 Arteria coronaria, Forbici 95
 Arterie renali, Pinze emostatiche ATRAUMATIC-GRIP 558
 Arteriotomia, Forbici 95
ARTHUR Pinza per schegge 151
 Articoli per infermeria 751
 Asciugamani e spazzole, Cestelli 753
 Aspirazione e prelievo, Curette 471
 Aspirazione intracardiaca, Tubo 327
 Aspirazione nasale, Tubo 324
 Aspirazione, Cannule 320-322
 Aspirazione, Cannule con interruttore e stiletto 323
 Aspirazione, Curette 470
 Aspirazione, Manico 320

Aspirazione, Micro-tubo	321
Aspirazione, Tubi	324-327
Astuccio per varici	315
ATRAUMATIC-GRIP Clamp patent-ductus	556
ATRAUMATIC-GRIP Pinza-clamp per occlusione superiore del retto	398-399
ATRAUMATIC-GRIP Pinza da presa per intestino e tessuti	389
ATRAUMATIC-GRIP Pinza iliaca	558
ATRAUMATIC-GRIP Pinza per aorta	561
ATRAUMATIC-GRIP Pinze-clamps per parametrio	197
ATRAUMATIC-GRIP Pinze-clamps per rene	190
ATRAUMATIC-GRIP Pinze Bulldog	556
ATRAUMATIC-GRIP Pinze Bulldog con dentatura DE BAKEY	525-528
ATRAUMATIC-GRIP Pinze coartazione con dentatura COOLEY	557
ATRAUMATIC-GRIP Pinze emostatica per arteria renale	537
ATRAUMATIC-GRIP Pinze emostatiche	176
ATRAUMATIC-GRIP Pinze emostatiche fini	167
ATRAUMATIC-GRIP Pinze emostatiche per arterie renale	558
ATRAUMATIC-GRIP Pinze intestinali	391-393, 395-396
ATRAUMATIC-GRIP Pinze multiuso	520-523, 530, 556, 562
ATRAUMATIC-GRIP Pinze multiuso con dentatura DARDIK	554
ATRAUMATIC-GRIP Pinze multiuso con dentatura DE BAKEY	553
ATRAUMATIC-GRIP Pinze patent-ductus con dentatura DE BAKEY	531
ATRAUMATIC-GRIP Pinze per anastomosi	520-523
ATRAUMATIC-GRIP Pinze per anastomosi con dentatura COOLEY	559-560
ATRAUMATIC-GRIP Pinze per anastomosi con dentatura DE BAKEY	542-544
ATRAUMATIC-GRIP Pinze per anastomosi del retto	400-401
ATRAUMATIC-GRIP Pinze per aorta con dentatura DE BAKEY	537-540
ATRAUMATIC-GRIP Pinze per bronchi con dentatura DE BAKEY	552
ATRAUMATIC-GRIP Pinze per carotide	537
ATRAUMATIC-GRIP Pinze per coartazione con dentatura DE BAKEY	532-533
ATRAUMATIC-GRIP Pinze per dissezione e legature con dentatura DE BAKEY	551
ATRAUMATIC-GRIP Pinze per isterectomia	197
ATRAUMATIC-GRIP Pinze per la carotide	527
ATRAUMATIC-GRIP Pinze per la carotide con dentatura LAWTON	524
ATRAUMATIC-GRIP Pinze per l'anastomosi dell'aorta	548-549
ATRAUMATIC-GRIP Pinze per l'aneurisma dell'aorta	561
ATRAUMATIC-GRIP Pinze per l'aneurisma dell'aorta con dentatura DE BAKEY	545-547
ATRAUMATIC-GRIP Pinze per occlusione tangenziale	562
ATRAUMATIC-GRIP Pinze per preparazioni e legature	186
ATRAUMATIC-GRIP Pinze per profondità	534
ATRAUMATIC-GRIP Pinze per stomaco	397
ATRAUMATIC-GRIP Pinze per vasi periferici	558
ATRAUMATIC-GRIP Pinze per vasi periferici con dentatura DE BAKEY	534-536
ATRAUMATIC-GRIP Pinze per vena cava con dentatura DE BAKEY	550
ATRAUMATIC-GRIP Pinze vascolari	135, 520
ATRAUMATIC-GRIP Pinze vascolari con dentatura COOLEY	555-556, 558, 561-562
ATRAUMATIC-GRIP Pinze vascolari con dentatura DE BAKEY	529-530, 534, 537
ATRAUMATIC-GRIP Pinze vascolari con dentatura LAWTON	521-523
ATRAUMATIC-GRIP Pinze vascolari per occlusione tangenziale	541
AUFRIEHT Forbici per la chirurgia plastica	82
AUFRIEHT Raspa	593
Auricolari e nasali, Pinze	136-137
Auricolari, Sonde	322
Auricolari, Uncini	213
AUSTIN Micro-Pinze per legature	122
Autofissatore per retrattori cervicale	704
Autofissatori di retrattori di LEYLA , Accessori	703, 705
Autofissatori per retrattori, da fissare alla tavola operatoria	704
Autofissatori per retrattori, per il sopporto del cranio	702
Autopsia, Coltello	40
AUVARD-BERLIND Speculi vaginali	441
AUVARD Speculi vaginali	441
Avambraccio e divaricatore per la mano	271

B

BABCOCK ATRAUMATIC-GRIP Pinze da presa per intestino e tessuti	389
BABCOCK Pinze da presa per intestino e tessuti	385, 388
BABY-ADSON Pinze per preparazioni e legature	180
BABY-ALLIS Pinze da presa per intestino e tessuti	383
BABY-BAILEY Approssimatori costali	508
BABY-BALFOUR Divaricatore addominale	300
BABY-COLLIN Divaricatore addominale	297

BABY-CRILE Pinze emostatiche fini	166
BABY-DOYEN ATRAUMATIC-GRIP Pinze intestinali	391
BABY-DOYEN Pinze intestinali	391
BABY-FINOCCHIETTO Divaricatori costali	503
BABY-GELPI Divaricatore per vulva	281
BABY-GILLIES Portaghi con forbici	370
BABY-GILLIES TITE GRIP Portaghi	348
BABY-GOSSET Divaricatore addominale	299
BABY-HAIGHT-FINOCCHIETTO Divaricatori costali in ALLUMINIO	501
BABY-KELLY Pinze emostatiche fini	168
BABY-KOCHER ATRAUMATIC-GRIP Pinze intestinali	391
BABY-KOCHER Pinze intestinali	391
BABY-LEXER Forbici per dissezione	87
BABY-MEEKER Pinze per preparazioni e legature	180
BABY-METZENBAUM Forbici per dissezione	89
BABY-MIKULICZ Pinza per peritoneo	192
BABY-MIXTER Pinze per preparazioni e legature	180
BABY-MOSQUITO (HARTMANN) Pinze emostatiche fini	164
BABY-OLSEN-HEGAR TITE GRIP Portaghi	348
BABY-OVERHOLT Pinza per preparazioni e legature	183
BABY-PAYR Clamp per intestino e stomaco con perno	403
BABY-ROUX Divaricatore, doppio	228
BABY-SATINSKY Pinze per anastomosi (vena cava)	565
BABY-TSCHLER Pinza per la biopsia cervicale e da prelievo	464
Bacinelle	748
Bacinelle reniformi	750
Bacinelle rettangolari	748
Bacinelle triangolari	750
Bacinelle universali	748
BACKHAUS Pinze per fissare le compresse	201
BADGLEY Divaricatori per laminectomia	286
BAHNSON-DE BAKEY ATRAUMATIC-GRIP Pinze per l'aneurisma dell'aorta con dentatura DE BAKEY	545
BAILEY-BABY Approssimatori costali	508
BAILEY-GIBBON Approssimatori costali	508
BAILEY (DE MARTEL) Guida per fili per sega	687
BAILEY ATRAUMATIC-GRIP Pinze per aorta con dentatura DE BAKEY	538
BAINBRIDGE-DE BAKEY ATRAUMATIC-GRIP Pinze vascolari	530
BAINBRIDGE Pinze intestinali	390
BAKES Dilatore per coledoco	416
BALFOUR-BABY Divaricatori addominale	300
BALFOUR-KIRSCHNER Valva per divaricatori addominali	307
BALFOUR Braccio laterale per divaricatori addominali	303
BALFOUR Divaricatori addominali	300-303
BALFOUR modif. Divaricatori addominali	302
BALFOUR Valve centrali per divaricatori addominali	303
BALFOUR Valve laterali per divaricatori addominali	303
BALLENGER-FOERSTER Pinze per tamponi e spugne	209
BALLENTINE-HEANEY Pinza per isterectomia	196
BALLENTINE Pinza per isterectomia	196
BARNES Cannula per aspirazione	321
BARR Dilatori per l'ano ed il retto	408
BARRAQUER-TROUTMAN Micro portaghi	360
BARRAQUER Micro portaghi	360
BARRAQUER Pinza per ciglia	152
BARRAYA-STILLE Pinze per chirurgia	148
BARRETT Pinza per abbassare il collo dell'utero	452
BARTH Curette per ossa	599
Base di fissaggio	703
BAUMGARTNER-HEGAR TITE GRIP Portaghi	342
BAUMGARTNER Portaghi	366
BAUMGARTNER TITE GRIP Portaghi	342
BEACHAM Amniotomo	477
BECK-COOLEY ATRAUMATIC-GRIP Pinze per anastomosi	560
BECK-DE BAKEY ATRAUMATIC-GRIP Pinze aorta	537
BECK-DE BAKEY ATRAUMATIC-GRIP Pinze per anastomosi	543
BECK-DE BAKEY ATRAUMATIC-GRIP Pinze per vena cava	550
BECKMANN-ADSON Divaricatori per laminectomia	279
BECKMANN-EATON Divaricatore per laminectomia	280
BECKMANN Divaricatore per laminectomia	280
BEEBEE Forbici taglia cavo	665
BEER Pinza per ciglia	152
BELMONT-RUMEL Tourniquets	518
Bendaggi e vestiti, Cesoie	674
Bendaggi, Forbici	672-673
BENGOLEA Pinze emostatiche fini	172
BENNETT Leve per ossa	581
BENSON Divaricatore per piloro	403
BERGER Lente binoculare frontale	8

BERGER Pinza per la biopsia cervicale e da prelievo	462
BERGMANN Cesioie per vestiti e gessi	675
BERGMANN Martelli	621
BERLIND-AUVARD Speculi vaginali	441
BERLINER Martelli percussori	2
BERNHARD Pinza per fissare le compresse	201
BETHUNE Costotomo	493
BEYER Pinze per laminectomia	707
BEYER Pinze per ossa	632-633
Bicchieri per medicinali	751
BIEMER-MÜLLER Approssimatori	157
BIEMER Clips vascolari	156
BIEMER Forbici per vene	63
BIER Seghe per amputazione e resezione	573
BILL Manico a trazione	479
Binoculare frontale, Lente	8-9
Biopsia cervicale e da prelievo, Pinza	460
Biopsia dell'endometrio, Curetta	459
Biopsia dell'endometrio, Curetta aspirante	459
Biopsia endo-cervicale, Curetta	459-465
Biopsia ossea, Strumenti	669
Biopsia rettale, Pinze taglienti	412
Biopsia vertebrale, Set	720
Biopsia vertebrale, Strumenti CRAIG-KOGLER	720-721
Biopsia, Aghi	329, 518
Biopsia, Curette	459-460
Biopsia, Strumento per trucoli dell'iliaco	669
BIRCHER-GANSKE Pinze da presa per menisco e cartilagine	640
BIRCHER Bisturi per menisco	643
Bisturi per fistole	37
Bisturi per intima	513
Bisturi per menisco	642-643
Bisturi per rinoplastica	37
Bisturi per vasi	694-695
Bisturi, Lame	34-35
Bisturi, Manici	34-35
BLAKE-MAYO Pinze per calcoli biliari	418
BLAKE Curette unterine	466
BLAKE Pinze per calcoli biliari	418
BLAKESLEY-WEIL Pinze per laminectomia	714
BLESSING DURACUT Forbici per la chirurgia rettale	59
BLOUNT Leve per sciatica	580
BLOUNT Retrattori per ginocchio	641
BLUMENTHAL Pinze per ossa	631
BLUNT Spillo di sicurezza	736
BOETTCHER Forbici per tonsille	103
BÖHLER (LISTON-WALTER) Cesioie per ossa	638
BÖHLER Cavo per arco di trazione	654
BÖHLER Pinze per ossa	633
BONN MOD. Pinze fini per chirurgia	138
BONNEY Pinza anatomica per dissezione	134
BONNEY Pinze per chirurgia	147
BONNEY TITE GRIP Pinza anatomica per dissezione	115
BONNEY TITE GRIP Pinza chirurgica a denti di topo	118
Boomerang, Portaghi	372
BOSE Uncino tracheale	728
BOYS-ALLIS Pinza da presa per intestino e tessuti	384
BOZEMANN-DOUGLAS Pinza per medicature	208
BOZEMANN (WERTHEIM) TITE GRIP Portaghi	346
BOZEMANN Pinze per medicature	208
Braccio flessibile per il fissaggio delle teste di accoppiamento	703
Braccio laterale per divaricatori addominali	303
BRAND Pinza ferma tendine	648
BRAUN-SIMPSON Forcipi	478
BRAUN-STADLER Forbici per perineo	107
BRAUN Cranioclasto	485
BRAUN Depressore uterino	447
BRAUN Pinza per abbassare il collo dell'utero	452, 454
BRAUN Uncino per detroncazione	485
BRAWLEY Raspa	593
BREISKY Speculi vaginali	440
BREISKY Speculi vaginali, doppi	438
BRIDGE Pinza per preparazioni e legature	187
BRINKERHOFF Speculi rettali	406
Bronchi, Pinze con dentatura DE BAKEY ATRAUMATIC-GRIP	552
BROPHY (SULLIVAN) Forbici fine per dissezione	93
BROPHY Pinze anatomiche per dissezione, fini	131
BROPHY Pinze fini per chirurgia	143
BROWN-ADSON Pinze fini per chirurgia	141
BROWN-ADSON Pinze per dissezione con denti	117
BROWN Pinze per chirurgia	148
BROWN Portaghi	366
BROWNE-DENIS Divaricatori addominali	305
BRUENINGS Abbassalingua	12
BRUNER Divaricatori per interventi in profondità	252-253
BRUNNER Pinze per anastomosi del retto	400
BRUNS Cesioie per gessi	676
BRUNS Curette per ossa	602-603
BRUNS DURACUT Cesioie per gessi	676
BUCHWALD Abbassalingua	12
BUCK-GRAMCKO Leve per ossa	576
BUCK Martelli percussori	3
BUELAU Trequarti per empiema	318
BUIE-SMITH Dilatatori per l'ano ed il retto	408
BUIE Pinza-clamp a pressione	409
Bulbo ad uncino	422
Bulldog, Micro Pinze	162
Bulldog, Pinza ATRAUMATIC-GRIP	556
Bulldog, Pinze	163
Bulldog, Pinze con dentatura DE BAKEY ATRAUMATIC-GRIP	525-528
Bulldog, Pinze TITAN-LINE	160-161
BUMM Curette per placenta e ovaie	484
BUMM Curette uterine	470
BUNNELL Eucleatore per tendine	646
BUNNELL Guida per tendine	646
BUNNELL Trapano a mano per ossa	653
BURFORD-FINOCHIETTO Divaricatori costali	503
BURFORD-FINOCHIETTO Divaricatori costali in ALLUMINIO	502
BURKE Pinza per la biopsia cervicale e da prelievo	464
BUSH Forbici ombelicali	108
Bypass, Strumenti per scanalare per trapiantare	517

C

Calcoli biliari, Cucchiari	417
Calcoli biliari, Pinze	418-419
Calibratore	7
CALNE ATRAUMATIC-GRIP Pinze per vena cava con dentatura DE BAKEY	550
CANAD. MODELL Bisturi per menisco	643
Canale lacrimale, Stiletti	312
Candelette dilatatrici	424
CANNON Bisturi per intima	513
CANNON Set per endarterectomia	515
CANNON spatola per intima	513
CANNON Tiravene per endarterectomia	514
Cannula per trocar	721
Cannule parlanti	726-727
Cannule per aspirazione	320-322
Cannule per aspirazione con interruttore e stiletto	323
Cannule per irrigazione del seno mascellare	322
Cannule tracheali	725-727
Cannule tracheali, Spazzolino per pulire	727
CAPLAN DURACUT Forbici per il setto nasale	59
CARMALT-ROCHESTER Pinze emostatiche	178
Carotide, Pinze ATRAUMATIC-GRIP	527, 537
Carotide, Pinze con dentatura LAWTON ATRAUMATIC-GRIP	524
CAROTIS-DE BAKEY ATRAUMATIC-GRIP Pinze Bulldog	525
CARROLL Pinza ferma tendine	648
CARROLL Portaghi	366
CARROLL TITE GRIP Portaghi	344
Cartilagine e menisco, Pinze per presa	640
Cartilagine, Forbici	82
CASPAR Divaricatore per colonna lombo vertebrale	294
CASPAR Divaricatore per colonna vertebrale	288
CASPAR Divaricatori	245
CASPAR Divaricatori per colonna cervicale	290-292
CASPAR Periototomi	585
CASPAR Pinze per laminectomia	718-719
CASPAR Speculi per chirurgia lombo vertebrale	295
CASPAR Uncini per nervi e vasi	215
Cassette per strumenti	746
CASTANEDA Divaricatori costali in ALLUMINIO	500
CASTANEDA Pinze multiuso ATRAUMATIC-GRIP	520
CASTANEDA Pinze per anastomosi ATRAUMATIC-GRIP	520
Castelli in acciaio perforato per la sterilizzazione	744
Castello in rete metallica per la sterilizzazione	744

CASTROVIEJO-MICRO Micro portaghi	358	CLAR Lampada	11
CASTROVIEJO Compasso	7	CLEVELAND Cesioie per ossa	637
CASTROVIEJO Pinza per afferrare e rompere le lamette da rasoio	36	Clips vascolari	154-156
CASTROVIEJO Pinze fini per chirurgia	138	Clips vascolari, Applicatori	154-156
CASTROVIEJO Poptaghi	363	CLOWARD Divaricatori per colonna cervicale	285
CASTROVIEJO TITE GRIP Micro-Portaghi	338-339	CLOWARD Separatori per vertebre	296
Catetere guida	425	COAKLEY Tre quarti per puntura del seno mascellare	319
Cateteri e tubi, Pinza guida	473	Coartazione, Pinze con dentatura COOLEY ATRAUMATIC-GRIP	557
Cateteri metallici	424	Coartazione, Pinze con dentatura DE BAKEY ATRAUMATIC-GRIP	532-533
Cateteri o sonde, Strumento per introdurre	425	COBB Periostotomi	589, 591
Catetri, Pinze introduttrici	32	COBB Sgorbie spinali	616
Catgut	353	COLCLOUGH (LOVE-KERRISON) Pinze per laminectomia	710-711
CATLIN Coltello per amputazione	38	Colecisti, Cucchiaino	417
Cava vena, Pinze con dentatura DE BAKEY ATRAUMATIC-GRIP	550	Coledoco, Dilatatore	416
Cavità, Divaricatori	509	COLLER-CRILE Pinze emostatiche fini	167
Cavo per arco di trazione	654	COLLIER Portaghi	363
Cavo, Forbici taglia	665	COLLIN-BABY Divaricatore addominale	297
Cavo, Forbici taglia DURACUT	665	COLLIN-DUVAL Pinza per intestino	149
Cavo, guida	660	COLLIN-DUVAL Pinze da presa per intestino e tessuti	386
Cavo, Pinze gira TITE GRIP	662	COLLIN-FARABEUF Periostotomi	588
Cavo, Pinze porta	663-664	COLLIN-HARTMANN Divaricatore, doppio	229
Cavo, Pinze porta TITE GRIP	663	COLLIN-LANDAU Speculi vaginali	431
Cerchiaggio, Strumenti	660	COLLIN ATRAUMATIC-GRIP Pinze da presa per intestino e tessuti	389
Cervello, Coltello	40	COLLIN Clamp ombelicale	486
Cervicale e prelievo, Pinza per la biopsia	460	COLLIN Dinamometro	6
Cervicale, Autofissatore per retrattori	704	COLLIN Divaricatori addominali	297-298
Cervice e uretra, Endospeculi	443, 448	COLLIN Divaricatori doppi	227
Cesioia con taglio frontale e laterale	668	COLLIN Martello	617
Cesioie	668	COLLIN Pinza da presa per intestino e tessuti	386
Cesioie per bendaggi e vestiti	674	COLLIN Pinza per afferrare l'utero	458
Cesioie per gessi	676-678	COLLIN Pinza per medicatura e tamponi	207
Cesioie per gessi DURACUT	676	COLLIN Pinza per togliere clips	379
Cesioie per ossa	494, 637-639	COLLIN Pinze tiralingua	23
Cesioie per vestiti e gessi	675	COLLIN Speculi vaginali	431
Cestelli in plastica per sterilizzazione	742	Collo vescicale, Dilatatore	423
Cestelli per spazzole	753	Colonna cervicale, Divaricatori	285, 290-292
Cestelli per spazzole e asciugamani	753	Colonna lombo vertebrale, Divaricatori	294
Cestelli per sterilizzazione	739-741, 744-745	Colonna vertebrale, Divaricatori	288
Cestelli per sterilizzazione e conservazione	738	Coltelli per amputazione	38
Cestelli rotondi per sterilizzazione	743	Coltelli per dura-madre	37
CHAMPY Strumento biopsia per trucioli dell'iliaco	669	Coltelli per resezione	38
CHAPUT Pinza da presa per intestino e tessuti	383	Coltello inter-osseo	39
CHARRIERE Seghe per amputazione e resezione	572-573	Coltello per autopsia	40
CHEATTLE Pinze per sterilizzazione	734	Coltello per falangi	39
CHERON Pinza per medicatura e tamponi	207	Coltello per gessi	679
CHEVALIER-JACKSON Cannule tracheali	726	Coltello per il cervello	40
CHEVALIER Divaricatore costale	507	Coltello per lobi	39
CHEYNE-WATSON Dissettori	574	Coltello per periostio con raschiatoio	39
Chiave per archi per trazione	659	Coltello per resezione e amputazione	39
Chiavi	681	Combinazione stetoscopica	5
CHILDE Pinze con porta clips	378	Compasso	7
CHILDE Pinze senza porta clips	378	Compresses, Pinze per fissare	200-202
Chiodi STEINMANN	654	Condotti biliari, Dilatatori	415
Chirurgia laser, Strumenti	448-451	Conduttrici, Sonde	377-378
Chirurgia lombo vertebrale, Speculi	295	CONE Pinze per ossa per cranio	688
Chirurgia plastica, Divaricatori	26	Conservazione e sterilizzazione, Cestelli	738
Chirurgia plastica, Forbici	82	Contenitore per micro-strumenti	737
Chirurgia plastica, Forbici DURACUT	45	Contenitore per spazzole usate	753
Chirurgia plastica, Uncino	217-219	CONTOUR SCALP Divaricatori autostatici	276
Chirurgia plastica, Uncino	219	CONVERSE GILLIES Divaricatori per pelle e dura-madre	216
Chirurgia rettale, Forbici DURACUT	59	CONVERSE TITE GRIP Portaghi	342
Chirurgia, Pinze	144-148	COOLEY-BECK ATRAUMATIC-GRIP Pinze per anastomosi	560
Chirurgia, Pinze a denti di topo	118	COOLEY-DERRA ATRAUMATIC-GRIP Pinze per anastomosi	559
Chirurgia, Pinze, fini	138-143	COOLEY-REYNOLDS ATRAUMATIC-GRIP Pinze per anastomosi	559
Ciglia, Pinze	152	COOLEY ATRAUMATIC-GRIP Clamp patent-ductus	556
Cilindri per siringhe	330-331	COOLEY ATRAUMATIC-GRIP Pinza Bulldog	556
Cilindri, Recipienti	747	COOLEY ATRAUMATIC-GRIP Pinza iliaca	558
Circoncisione, Strumento	426	COOLEY ATRAUMATIC-GRIP Pinza per aorta	561
CITELLI Pinze per laminectomia	707	COOLEY ATRAUMATIC-GRIP Pinza per l'aneurisma dell'aorta	561
Clamp-pinza a pressione	409	COOLEY ATRAUMATIC-GRIP Pinza per vasi periferici	558
Clamp-pinze per intestino e stomaco	403	COOLEY ATRAUMATIC-GRIP Pinze coartazione	557
Clamp ombelicali	486	COOLEY ATRAUMATIC-GRIP Pinze emostatiche per arterie renale	558
Clamp patent-ductus ATRAUMATIC-GRIP	556	COOLEY ATRAUMATIC-GRIP Pinze multiuso	556, 562
Clamp per appendicectomia e pinza schiaccia sperone	403	COOLEY ATRAUMATIC-GRIP Pinza per anastomosi	560
Clamp per intestino e stomaco con perno	403	COOLEY ATRAUMATIC-GRIP Pinze per occlusione tangenziale	562
Clamps-pinze per parametrio ATRAUMATIC-GRIP	197	COOLEY ATRAUMATIC-GRIP Pinze vascolari	555
Clamps-pinze per rene	190	COOLEY Dilatatori per l'aorta	511
Clamps-pinze per rene ATRAUMATIC-GRIP	190	COOLEY Dilatatori vascolari	510
Clamps Bulldog, Pinze metti-rimuovi TITAN-LINE	160	COOLEY Divaricatore per sternotomia	499

COOLEY Divaricatore per sternotomia in ALLUMINIO	498
COOLEY Divaricatori per cavità	509
COOLEY Tubo aspirazione	327
COOLEY Tubo aspirazione intracardiaca	327
COOLEY Tubo aspirazione vascolare	327
COOPER Aghi per legatura	374
Copertura verificata, Pinze	152
Cordone spermatico, Pinza per fissare	425
CORWIN-HEGAR TITE GRIP Pinza gira cavo	662
CORYLLOS Divaricatori e spatole per polmone	261
Costali, Approssimatori	508
Costali, Divaricatori	503-508
Costali, Divaricatori in ALLUMINIO	500-502
Costali, Periostotomi	495, 497
Costole e ossa, Pinze	493
Costole, Pinze	494
Costotomi	492-493
Cotone/spugne, porta	473
COTTLE-NEIVERT Uncino per narici posteriori	221
COTTLE DURACUT Forbici nasali	58
COTTLE Forbici nasali	102
COTTLE Martello	620
COTTLE Osteotomi	608
COTTLE Periostotomi	583, 585
COTTLE Raspa	593
COTTLE Uncino per chirurgia plastica, acuto	218
COTTLE Uncino per pelle e dura-madre	217
CRAFOORD-DE BAKEY ATRAUMATIC-GRIP Pinze per l'aneurisma dell'aorta con dentatura DE BAKEY	546
CRAFOORD-STILLE Pinza emostatica fine	170
CRAFOORD (STELZNER) Forbici per lobo polmonare e per il retto	99
CRAFOORD Pinza emostatica fine	171
CRAFOORD Pinze ventricolari	564
CRAIG-KOGLER Strumenti per biopsia vertebrale	720-721
Craniale, Alesatore per pinze di trazione	689
Craniale, Pinze per trazione	689
Cranio, Pinze per ossa	688
Cranio, Strumenti per l'apertura	687
Cranioclasto	485
CRILE-BABY Pinze emostatiche fini	166
CRILE-COLLER Pinze emostatiche fini	167
CRILE-MICRO Pinze emostatiche fini	166
CRILE-MURRAY Portaghi	366
CRILE-RANKIN-DE BAKEY ATRAUMATIC-GRIP Pinze emostatiche fini	167
CRILE-RANKIN (OCHSNER-DIXON) Pinze emostatiche fini	167
CRILE-RANKIN Pinze emostatiche fini	167
CRILE-WOOD Portaghi	366, 368
CRILE-WOOD TITE GRIP Portaghi	341, 343
CRILE Divaricatore, doppio	227
CRILE Portaghi	371
CRILE TITAN-LINE Pinze emostatiche fini	166
CRILE Uncini per nervi e vasi	214
CRUTCHFIELD Alesatore per pinze di trazione craniale	689
CRUTCHFIELD Pinze per trazione craniale	689
Cucchiai per calcoli biliari	417
Cucchiai per colecisti	417
Cucchiai per placenta e ovaie	484
Cucchiaio per lupus	19
Cucchiaio per medicinali	751
Culicola, Forbici	16
CULLEN-WERTHEIM Pinza per peduncoli renali	191
Cuoio capelluto, Graffe emostatiche	691
Cuoio capelluto, Pinza	481
Cura degli strumenti chirurgici, Liquido concentrato PREP LUBE	733
Curetta per secrezioni	425
Curette	692
Curette aspiranti per la biopsia dell'endometrio	459
Curette per aspirazione, Adattatore per la connessione	471
Curette per aspirazione	470
Curette per biopsia	459-460
Curette per la biopsia dell'endometrio	459
Curette per la biopsia endo-cervicale	459-465
Curette per ossa	598-606
Curette per placenta e ovaie	484
Curette per prelievo ed aspirazione	471
Curette taglianti	606, 695-696
Curette uterine	466-470
CURTIS Pinza per chirurgia	147
Curva/taglia, Tenaglie	666

CUSCO Speculi vaginali	430-431
CUSHING-FERRIS-SMITH Pinze per laminectomia	713
CUSHING-LANDOLT Speculo per ipofidectomia transsfenoidale	692
CUSHING-TAYLOR Pinza anatomica per dissezione, fine	131
CUSHING-TAYLOR TITE GRIP Pinze anatomiche per dissezione	114
CUSHING-TAYLOR Pinza fine per chirurgia	143
CUSHING-TAYLOR Pinze auricolari e nasali	136
CUSHING Divaricatori per vene	222-223
CUSHING Gancio per decompressione	701
CUSHING Pinza fine per chirurgia	142
CUSHING Pinze anatomiche per dissezione, fini	130
CUSHING Pinze per laminectomia	715
CUSHING Punta	652
CUSHING Spatole cerebrali	706
CUSHING TITE GRIP Pinze anatomiche per dissezione	114
CUSHING Uncini per nervi e vasi	214
CUSHING Uncino per dura-madre, acuto	218
Cutaneo, Divaricatori	216, 218
Cutaneo, Uncino	217
Cuticola, Tronchesine	17
CUZZI Cucchiai per placenta e ovaie	484
CZERNY Pinza per abbassare il collo dell'utero	455
CZERNY Speculi rettali	405

D

DAHLGREN Pinze per ossa per cranio	688
DALE ATRAUMATIC-GRIP Pinze per vasi periferici con dentatura DE BAKEY	535
DANDY Pinze emostatiche fini	165
DANDY Uncini per nervi e vasi	214
DARDIK ATRAUMATIC-GRIP Pinze multiuso	554
DARTIGUES Pinza per afferrare il rene	421
DAUBENSPECK Curette per ossa	604
DAVIDSON Divaricatori per scapola	260
DAVIS-RAGNELL Divaricatori per chirurgia plastica	226
DAVIS Spatole cerebrali	706
DAY Uncini auricolari	213
DE BAKEY-BAHNSON ATRAUMATIC-GRIP Pinze per l'aneurisma dell'aorta con dentatura DE BAKEY	545
DE BAKEY-BAINBRIDGE ATRAUMATIC-GRIP Pinze vascolari	530
DE BAKEY-BECK ATRAUMATIC-GRIP Pinze aorta	537
DE BAKEY-BECK ATRAUMATIC-GRIP Pinze per anastomosi	543
DE BAKEY-BECK ATRAUMATIC-GRIP Pinze per vena cava	550
DE BAKEY-CAROTIS ATRAUMATIC-GRIP Pinze Bulldog	525
DE BAKEY-CRAFOORD ATRAUMATIC-GRIP Pinze per l'aneurisma dell'aorta con dentatura DE BAKEY	546
DE BAKEY-CRILE-RANKIN Pinze emostatiche fini	167
DE BAKEY-DERRA ATRAUMATIC-GRIP Pinze per anastomosi	542
DE BAKEY-DIETRICH ATRAUMATIC-GRIP Pinze Bulldog	526
DE BAKEY-GLOVER ATRAUMATIC-GRIP Pinze Bulldog	525
DE BAKEY-GUYON ATRAUMATIC-GRIP Pinze clamps per rene	190
DE BAKEY-HALSTED-MOSQUITO Pinze emostatiche fini	165
DE BAKEY-HARKEN ATRAUMATIC-GRIP Pinze per dissezione e legature con dentatura DE BAKEY	551
DE BAKEY-HEANEY (ROGERS) ATRAUMATIC-GRIP Pinze per isterectomia	197
DE BAKEY-MORRIS ATRAUMATIC-GRIP Pinze per aorta	540
DE BAKEY-PEAN ATRAUMATIC-GRIP Pinze emostatiche	176
DE BAKEY-PEAN ATRAUMATIC-GRIP Pinze vascolari	529
DE BAKEY-POTTS ATRAUMATIC-GRIP Pinze patent-ductus	531
DE BAKEY-REYNOLDS ATRAUMATIC-GRIP Pinze per anastomosi	542
DE BAKEY-RUMEL ATRAUMATIC-GRIP Pinze per preparazioni e legature	186
DE BAKEY-SATINSKY ATRAUMATIC-GRIP Pinze Bulldog	525
DE BAKEY-WERTHEIM (ROGERS) ATRAUMATIC-GRIP Pinze-clamps per parametrio	197
DE BAKEY (GARRETT) Dilatatori vascolari	510
DE BAKEY ATRAUMATIC-GRIP Pinze vascolari	135
DE BAKEY ATRAUMATIC-GRIP Pinza emostatica per arteria renale	537
DE BAKEY ATRAUMATIC-GRIP Pinze Bulldog	526
DE BAKEY ATRAUMATIC-GRIP Pinze Bulldog	528
DE BAKEY ATRAUMATIC-GRIP Pinze multiuso	553
DE BAKEY ATRAUMATIC-GRIP Pinze patent-ductus	531
DE BAKEY ATRAUMATIC-GRIP Pinze per anastomosi	543
DE BAKEY ATRAUMATIC-GRIP Pinze per aorta	539
DE BAKEY ATRAUMATIC-GRIP Pinze per coartazione	532-533
DE BAKEY ATRAUMATIC-GRIP Pinze per dissezione e legature	551

DE BAKEY ATRAUMATIC-GRIP Pinze per l'aneurisma dell'aorta	545
DE BAKEY ATRAUMATIC-GRIP Pinze per l'aneurisma dell'aorta	547
DE BAKEY ATRAUMATIC-GRIP Pinze per vasi periferici	534
DE BAKEY ATRAUMATIC-GRIP Pinze per vasi periferici	535-536
DE BAKEY ATRAUMATIC-GRIP Pinze vascolari	529
DE BAKEY ATRAUMATIC-GRIP Pinze vascolari per occlusione tangenziale	541
DE BAKEY Divaricatori costali	504-505
DE BAKEY DURACUT Forbici vascolari	57
DE BAKEY Forbici per arteriotomia	95
DE BAKEY Forbici vascolari	96
DE BAKEY Pinza multiuso ATRAUMATIC-GRIP	530
DE BAKEY Pinze per tessuti e per aghi	116
DE BAKEY TITE GRIP Portaghi	343
DE BAKEY Tubo aspirazione	325
DE MARTEL-WOLFSON Pinze per anastomosi del colon	402
DE MARTEL-WOLFSON Portapinze	402
DE MARTEL-WOLFSON Serrapinze	402
DE MARTEL (BAILEY) Guida per fili per sega	687
DE VILBISS Pinze per ossa per cranio	688
DE VILBISS Speculo vaginale	433
DEAN DURACUT Forbici per gengiva	55
DEAN Forbici per tonsille	103
DEAVER-FORD Divaricatore e spatola per polmone	263
DEAVER Divaricatori e spatole per polmone	264-265
DEAVER Forbici per chirurgia	71
Decapitazione, Forbici	109
Decompressione, Ganci	701
DEJERINE Martelli percussori	2
DEMEL Guida cavo	660
DENHARDT Apribocca	22
DENIS-BROWNE Divaricatori addominali	305
DENKER-UECKERMANN Tre quarti per tracheotomia	728
Deponette	738
Depressori uterini	447
DERF Portaghi	363
DERF TITE GRIP Portaghi	342
Dermatici, Trapani	20
Dermatomi	41-42
DERRA-COLEY ATRAUMATIC-GRIP Pinze per anastomosi	559
DERRA-DE BAKEY ATRAUMATIC-GRIP Pinze per anastomosi	542
DESCHAMPS Aghi per legatura	374-376
DESJARDINS Dilatatori per condotti biliari	415
DESJARDINS Pinze per calcoli biliari	419
DESMARRES Divaricatori per vene	222
Dissezione, Forbici	98
Detergente per strumenti	733
Detroncazione, Uncino	485
DEUCHER Divaricatore addominale	299
DEVIN ATRAUMATIC-GRIP Pinze per la carotide con dentatura LAWTON	524
Diapason	4
DIEFFENBACH Pinze Bulldog	163
DIETRICH-DE BAKEY ATRAUMATIC-GRIP Pinze Bulldog	526
DIETRICH-HEGEMANN DURACUT Forbici vascolari	56
DIETRICH-HEGEMANN Forbici vascolari	96
DIETRICH ATRAUMATIC-GRIP Pinze per aorta con dentatura DE BAKEY	539
DIETRICH Forbici vascolari	97
DIETRICH TITE GRIP Micro-Portaghi	339
Dilatatore per coledoco	416
Dilatatore per collo vescicale	423
Dilatatore per tracheotomia	728
Dilatatore rettale con chiusura a scatto	408
Dilatatori e spatole intima	512
Dilatatori per condotti biliari	415
Dilatatori per l'ano ed il retto	407-408
Dilatatori per l'aorta	511
Dilatatori uterini	443-445
Dilatatrici candelette	424
Dinamometro	6
DINGMANN modif. Tenaglia per ossa	624
DINGMANN Tenaglia per ossa	624
Dischi di fissaggio	659
Dischi di fissaggio, Vite guida	659
Dispositivo di fissaggio	309
Dissettori	574, 693-694, 696-700
Dissettori per la dura-madre	698-700
Dissezione dei nervi, Forbici	93
Dissezione e legature, Pinze	564
Dissezione e legature, Pinze ATRAUMATIC-GRIP	551
Dissezione e tenotomia, Forbici fine	92
Dissezione, Forbici	81, 84-91
Dissezione, Forbici DURACUT	47-53
Dissezione, Forbici fine	93
Dissezione, Pinze anatomiche	132-134
Dissezione, Pinze anatomiche TITE GRIP	112-115
Dissezione, Pinze anatomiche, fini	128-131
Dissezione, Pinze con denti TITE GRIP	117
Distributore multiplo per punte filiformi	657
Distributore per punte filiformi	656
Distributori di spazzole	752
Dita, Divaricatore	271
Dita, Impugnatura a molla e piccolo divaricatore per ferite	271
DITTEL Catetere guida	425
Divaricatore (piccolo) per ferite e impugnatura a molla per dita	271
Divaricatore per dita	271
Divaricatore per gozzo	224
Divaricatore per la mano	271
Divaricatore per la mano e l'avambraccio	271
Divaricatore per laminectomia	277, 279-280
Divaricatore per piloro	403
Divaricatore per sternotomia	499
Divaricatore per sternotomia in ALLUMINIO	498
Divaricatore per trachea	226
Divaricatore per vene	217, 222
Divaricatore vescicale	310
Divaricatori	212-310
Divaricatori addominali	297-306, 308-309
Divaricatori addominali, Braccio laterale	303
Divaricatori autostatici	270-276, 278, 282-283
Divaricatori costali	503-508
Divaricatori costali in ALLUMINIO	500-502
Divaricatori cutaneo	216, 218
Divaricatori e divaricatori per ossa	232
Divaricatori e spatole per polmone	261-265
Divaricatori per appendicectomia	284
Divaricatori per cavità	509
Divaricatori per chirurgia plastica	226
Divaricatori per colonna cervicale	285, 290-292
Divaricatori per colonna lombo vertebrale	294
Divaricatori per colonna vertebrale	288
Divaricatori per emilaminectomia	277
Divaricatori per fegato	255
Divaricatori per guaina tendinea	225
Divaricatori per il torace	507
Divaricatori per interventi in profondità	252-259
Divaricatori per laminectomia	284, 286
Divaricatori per pelle e dura-madre	216
Divaricatori per pelvis	256-258
Divaricatori per polmone	260
Divaricatori per scapola	260
Divaricatori per tessuti molli	241
Divaricatori per vene	222-223
Divaricatori per vulva	281
Divaricatori spinali	231
Divaricatori vascolari	510
Divaricatori, doppi	226-230
Divaricatori, Ganci	287
Divaricatori per veni e hilus	223
Divaricatore per la tiroide	243
DIXON-LOVELACE Pinze emostatiche fini	169
DIXON-OCHSNER CRILE-RANKIN Pinze emostatiche fini	167
DOCKHORN Divaricatori	245
Doppia, Sonda	694
DOUGLAS-BOZEMANN Pinza per medicature	208
DOUGLAS Pinza per ciglia	152
DOUGLAS Tre quarti per puntura del seno mammellare	320
DOYEN-BABY ATRAUMATIC-GRIP Pinze intestinali	391
DOYEN-BABY Pinze intestinali	391
DOYEN-STILLE Divaricatori	247
DOYEN ATRAUMATIC-GRIP Pinze intestinali	392-393
DOYEN Divaricatori	248-249
DOYEN Forbici per pareti addominali	106
DOYEN Martelli	618
DOYEN Periototomi costali	495
DOYEN Pinza per fissare le compresse	200
DOYEN Pinza per polipi e ovaie	457

DOYEN Pinze intestinali	392-393
DOYEN Sonda scanalata.	314
DOYEN Speculi e valve vaginali	439
DOYEN Succhielli per fibroma	458
DUBOIS Forbici per decapitazione.	109
DUPLAY Pinza per abbassare il collo dell'utero	453
Dura-madre e pelle, Divaricatori.	216
Dura-madre e pelle, Uncino	217
Dura-madre, Coltelli.	37
Dura-madre, Dissettori	698-700
Dura-madre, Pinza guida sonda e protezione.	650
Dura-madre, Uncini.	212, 217-218
Dura madre, Forbici.	100
DURACUT Cesoie per gessi	676
DURACUT Forbici	44-60
DURACUT Forbici adnex.	54
DURACUT Forbici fini	45
DURACUT Forbici nasali	58
DURACUT Forbici per chirurgia	46
DURACUT Forbici per dissezione	47-53
DURACUT Forbici per episiotomia.	60
DURACUT Forbici per gengiva	55
DURACUT Forbici per ginecologia.	60
DURACUT Forbici per il setto nasale	59
DURACUT Forbici per iridectomia	45
DURACUT Forbici per la chirurgia rettale.	59
DURACUT Forbici per legature	353
DURACUT Forbici taglia cavo	665
DURACUT Forbici uterine	60
DURACUT Forbici vascolari	56-57
DURACUT Parametrium forbici	60
DURACUT Tenaglie tagliafili	667
DURANTE Pinze vascolari e per tumori.	149
DUVAL-COLLIN Pinza per intestino.	149
DUVAL-COLLIN Pinze da presa per intestino e tessuti	386
DUVAL Pinza per intestino	149
DUVAL Pinze da presa per intestino e tessuti.	386-387
DUVAL TITE GRIP Pinza da presa per intestino e tessuti	388

E

EASTMAN-RICHARDSON Divaricatori	250
EATON-BECKMANN Divaricatore per laminectomia	280
ECHLIN Pinze per ossa.	634
EDER Portacotone	409
EICKEN-KILLIAN Cannule per irrigazione del seno mascellare	322
EISELSBERG Forbici per legature.	352
Elevatore per testa in interventi con taglio cesareo.	481
Elevatori.	574-575
Emilaminectomia, Divaricatori	277
EMMET Pinza per medicatura e tamponi	207
EMMET Uncino	449
EMMET Uncino per fistole	221
Emorroidi, Legatori con aspiratore	411
Emorroidi, Legatori con carica	410
Emorroidi, Pinze	410
Emostatica, Pinze per arteria renale ATRAUMATIC-GRIP	537
Emostatiche e tonsille, Pinze	179
Emostatiche, Pinze	173-179
Emostatiche, Pinze ATRAUMATIC-GRIP	176
Emostatiche, Pinze fini ATRAUMATIC-GRIP	167
Emostatiche, Pinze fini TITAN-LINE.	166
Emostatiche, Pinze TITAN-LINE.	168
Emostatici, Pinze fini.	164-173
Empiema, Tre quarti	318
Enderectomia, Set	515
Enderectomia, Tiravene.	514
Endo-cervicale, Curetta per la biopsia.	459-465
Endometrio, Curetta aspirante per la biopsia	459
Endometrio, Curetta per la biopsia	459
Endospeculi.	443
Endospeculi per cervice e uretra	443, 448
ENGEL Seghe per gessi	679
ENGL. MOD. Pinze per fissare le compresse.	200
Enterotomia, Forbici.	109
Enucleatore	693
Enucleatore per tendine.	646
Episiotomia e perineo, Forbici	107

Episiotomia, Forbici DURACUT	60
ERRICO Fresa	652
ESMARCH Cesoie per vestiti e gessi.	675
ESMARCH Coltello per gessi.	679
ESMARCH Fascia per ischemia	570
ESMARCH Tubo per ischemia.	570
Espellere il tessuto campione, Otturatore smusso	721
Estensiometro	4
Estrarre il tessuto molle, Retrattore doppio.	721
EUFRATE PASQUE TITE GRIP Portaghi.	344
EWALD Pinze anatomiche per dissezione, fini	129
EWALD Pinze fini per chirurgia	140

F

FAHLBUSCH-HARDY Dissettori	693
Falangi, Coltello.	39
FANSLER-IVES Anoscopi con otturatore di plastica.	407
FARABEUF-ALEXANDER Periototomi costali	497
FARABEUF-COLLIN Periototomi.	588
FARABEUF-LAMBOTTE Tenaglia per ossa.	626
FARABEUF Divaricatori, doppi	227
FARABEUF Periototomi.	588
FARRELL LATHBURY Portacotone.	316
Fascia frontale.	10
Fascia per ischemia.	570
FAURE Pinze per peritoneo.	193
FAVALORO Forbici per arteria coronaria	95
Fegato, Aghi per la puntura cieca.	329
Fegato, Divaricatori	255
FEHLAND ATRAUMATIC-GRIP Pinze per anastomosi del retto	401
FEILCHENFELD Pinze per schegge	150
FEIN Portacotone	317
FERGUSON Aghi chirurgici per sutura	356
FERGUSON Forbici per chirurgia	80
FERGUSON FRAZIER Cannule per aspirazione con interruttore e stiletto	323
FERGUSON Tenaglia per ossa	624
Ferite e vescica, Siringhe.	331
Ferite, Impugnatura a molla e piccolo divaricatore	271
FERRIS-SMITH-CUSHING Pinze per laminectomia	713
FERRIS-SMITH-KERRISON Pinze per laminectomia	709-710, 712
FERRIS-SMITH Pinze per chirurgia	147
Fibroma, Succhielli	458
Fili per sega.	687
Fili per sega, Guida	687
Fili per sega, Manico ad uncino	687
Filo di argento	690
Filo per ossa	660
FINOCHIETTO-BABY-HAIGHT Divaricatori costali in ALLUMINIO	501
FINOCHIETTO-BABY Divaricatori costali	503
FINOCHIETTO-BURFORD Divaricatori costali	503
FINOCHIETTO-BURFORD Divaricatori costali in ALLUMINIO	502
FINOCHIETTO-INFANT Divaricatori costali in ALLUMINIO.	501
FINOCHIETTO-RIENHOFF Divaricatori costali.	506
FINOCHIETTO Divaricatori costali	503
FINOCHIETTO Divaricatori costali in ALLUMINIO	501
FINOCHIETTO modif. Divaricatori costali in ALLUMINIO	500
FINOCHIETTO Pinza per torace e legature	564
FINOCHIETTO Portaghi	369
FINOCHIETTO TITE GRIP Portaghi.	346
FINSEN Divaricatori autostatici	270
FISCH Uncino per dura-madre.	212
FISCHER Eucleatore per tendine.	646
Fistole e vascolare, Forbici DURACUT	45
Fistole, Bisturi	37
Fistole, Sonde	314, 409
Fistole, Uncini	221
FLETCHER (JAVERTS) Pinza per tamponi e spugne	210
FLUHRER Sonde bottonute.	313
FOERSTER-BALLENGER Pinze per tamponi e spugne	209
FOERSTER Divaricatore addominale.	308
FOERSTER FORBES Pinza per tamponi e spugne	210
FOERSTER Valve in NYLON per divaricatori addominali	308
FOMON DURACUT Forbici nasali	58
FOMON Forbici con aletta nasale	81
FOMON Forbici nasali	102
FOMON Forbici per la chirurgia plastica.	82

FOMON Taglio di lima / taglio di raspa	595
FOMON TITE GRIP Raspe	597
FOMON Uncino per narici posteriori	221
FORBES (FOERSTER) Pinza per tamponi e spugne	210
Forbici-micro	62-67
Forbici con aletta nasale	81
Forbici con portaghi	370
Forbici da utero	104-106
Forbici DURACUT	44-66
Forbici fine per chirurgia	68-70
Forbici fine per dissezione	93
Forbici fine per dissezione e per tenotomia	92
Forbici fini DURACUT	45
Forbici nasali	101-102
Forbici nasali DURACUT	58
Forbici ombelicali	108
Forbici per arteria coronaria	95
Forbici per arteriotomia	95
Forbici per bendaggi	672-673
Forbici per chirurgia	71-84
Forbici per chirurgia DURACUT	46
Forbici per chirurgia e per dissezione	82
Forbici per decapitazione	109
Forbici per dissezione	81, 84-91, 98
Forbici per dissezione, DURACUT	47-53
Forbici per dura madre	100
Forbici per enterotomia	109
Forbici per episiotomia DURACUT	60
Forbici per fissurare le unghie	81
Forbici per gengiva	94
Forbici per gengiva DURACUT	55
Forbici per ginecologia DURACUT	60
Forbici per il setto nasale	102
Forbici per il setto nasale DURACUT	59
Forbici per la cartilagine	82
Forbici per la chirurgia plastica	82
Forbici per la chirurgia plastica DURACUT	45
Forbici per la cuticola	16
Forbici per la dissezione dei nervi	93
Forbici per legature	352-353
Forbici per legature, DURACUT	353
Forbici per lobo polmonare e per il retto	99
Forbici per nervo trigemino	100
Forbici per neurochirurgia	100
Forbici per parametrium DURACUT	60
Forbici per pareti addominali	106
Forbici per perineo (episiotomia)	107
Forbici per tonsille	103
Forbici per unghie	16
Forbici per vena cava	99
Forbici per vene	63
Forbici taglia cavo	665
Forbici taglia cavo DURACUT	665
Forbici uterine DURACUT	60
Forbici vascolari	95-98
Forbici vascolari DURACUT	56-57
Forbici vascolari e per fistole DURACUT	45
Forchetta da sutura	378
Forchetta per impiantare	693
Forcipi	478-480
Forcipi per tagli cesarei	480
FORD-DEAVER Divaricatore e spatola per polmone	263
FOSS Divaricatore e spatola per polmone	263
FOX-GOLDMANN DURACUT Forbici per gengiva	55
FOX-GOLDMANN Forbici per gengiva	94
FOX Raschiatoio per lupus	20
FRAIZER Divaricatore per pelle e dura-madre	216
FRANZ Divaricatori addominali	304
FRAZIER (FERGUSON) Cannule per aspirazione con interruttore e stiletto	323
FRAZIER Cannule per aspirazione con interruttore e stiletto	323
FRAZIER Dissettore per la dura-madre	698
FREER Divaricatore	218
FREER Periostotomi	583
FREER Scalpelli	607
FRENCH EYE TITE GRIP Portaghi	340
FRENZEL Abbassalingua	12
Fresa	652
FRIEDMAN-LUER Pinza per ossa	631

FRITSCH Divaricatori	250
FROHN Portacotone	316
FRYKHOLM Pinze per ossa	635

G

Galea, Ganci	691
GALLAHER Raspa	592
Ganci di trazione	659
Ganci galea	691
Ganci per decompressione	701
Gancio per divaricatori	287
GANSKE-BIRCHER Pinze da presa per menisco e cartilagine	640
GARRETT (DE BAKEY) Dilatatori vascolari	510
Gastro-intestinale, Apparecchiatura di sutura	404
Gastro-intestinale, Graffe per sutura	404
GAYLOR-THOMS Pinza per la biopsia cervicale e da prelievo	460
GEISSENDOERFER-OVERHOLT Pinze per preparazioni e legature	184
GELPI-BABY Divaricatori per vulva	281
GELPI-SELETZ Divaricatore per vulva	281
GELPI Divaricatori per vulva	281
GEMINI-MIXTER Pinze per preparazioni e legature	181
GEMINI Pinze per preparazioni e legature	181
Gengiva, Forbici	94
Gengiva, Forbici DURACUT	55
GERALD Pinza per dissezione con denti	117
GERALD Pinze anatomiche per dissezione, fini	130
GERALD Pinze fini per chirurgia	142
GERALD TITE GRIP Pinza anatomica per dissezione	114
GERSTER Tenaglia per ossa	630
GERZOG Martello	618
Gessi e vestiti, Cesioie	675
Gessi, Cesioie	676-678
Gessi, Cesioie DURACUT	676
Gessi, Coltello	679
Gessi, Seghe	679
Gesso, Apri	682
Gesso, Rompi	682
GIBBON-BAILEY Approssimatori costali	508
GIERTZ-STILLE Costotomo	492
GIGLI (OLIVECRONA) Fili per sega	687
GIGLI Manico ad uncino per fili per sega	687
GIL-VERNET MARBERGER Divaricatori per veni e hilus	223
GILLIES-BABY Portaghi con forbici	370
GILLIES-BABY TITE GRIP Portaghi	348
GILLIES (CONVERSE) Divaricatori per pelle e dura-madre	216
GILLIES Divaricatore cutaneo	216
GILLIES Pinza fine per chirurgia	142
GILLIES Pinza per dissezione con denti	117
GILLIES Portaghi con forbici	370
GILLIES TITE GRIP Portaghi	348
Ginecologia, Forbici DURACUT	60
Ginocchio, Retrattori	641
Giunto a sfera ad incastro	705
Giunto a sfera, Porta asta per fissaggio	705
GLASSMANN (KILNER) Forbici	83
GLOVER-DE BAKEY ATRAUMATIC-GRIP Pinze Bulldog	525
GLOVER ATRAUMATIC-GRIP Pinze per anastomosi con dentatura DE BAKEY	544
GLUCK Costotomo	492
GOLET Divaricatore, doppio	229
GOLDMANN-FOX DURACUT Forbici per gengiva	55
GOLDMANN-FOX Forbici per gengiva	94
Goniometro per le membra	7
GOOD Forbici per tonsille	103
GOODELL Dilatatore uterino	443
GORNEY DURACUT Forbici per il setto nasale	59
GORNEY Forbici per la chirurgia plastica	82
GOSSET-BABY Divaricatore addominale	299
GOSSET Divaricatore addominale	299-300
GOURDET Curette uterine	466
Gozzo, Divaricatore	224
Gozzo, Sonda	378
Graduati, Misurini	751
GRAEFE (TYRELL) Divaricatori cutaneo	216
GRAEFE Pinza per chirurgia	148
GRAEFE Pinze anatomiche per dissezione, fini	128
GRAEFE Pinze fini per chirurgia	139
GRAEFE Uncini per strabismo	213

Graffe	379
Graffe di argento	690
Graffe emostatici per cuoio capelluto	691
Graffe in argento per sutura gastro-intestinale	404
Graffe, Pinza metti	690
Graffe, Pinza per applicare e togliere	691
GRAHAM Uncino per dura-madre	217
GRAMCKO-BUCK Leve per ossa	576
GRAVE modif. Speculo vaginale	432
GRAVE Speculi vaginali	432-433
GREEN-ARMYTAGE Pinza emostatica per tagli cesarei	481
GREEN-SENN Divaricatori	224
GREEN Divaricatore per la tiroide	243
GREEN Pinza per fissare le compresse	200
GREGORY-SOFT Pinze per la carotide ATRAUMATIC-GRIP	527
GREGORY Pinza per profondità ATRAUMATIC-GRIP	534
GRONINGEN Uncini per nervi e vasi	215
GROSS Pinze per medicatura e tamponi	204
GRUENWALD-LOVE Pinze per laminectomia	716
GRUENWALD (JANSEN) Pinze auricolari e nasali	136
GRUENWALD Pinze auricolari e nasali	136
Guaina tendinea, Divaricatori	225
Guida ago a tromba	486
Guida cavo	660
Guida e scanalare, Strumento	646
Guida per fili per sega	687
Guida per legatura, bottonuta	697
Guida per tendine	646
Guida sonda e per la protezione della dura-madre, Pinza	650
GUNNAR-HEY Pinza pressa tubi con rulli	203
GUTHRIE Divaricatore	218
GUYON-DE BAKEY ATRAUMATIC-GRIP Pinze-clamps per rene	190
GUYON Catetere guida	425
GUYON Pinze-clamps per rene	190
GUYON Strumento per introdurre cateteri o sonde	425

H

HABERE Spatola addominale e intestinale	267
HAETH-RICHTER Pinza per togliere clips	379
HAIGHT-FINOCHIETTO-BABY Divaricatori costali in ALLUMINIO	501
HAIGHT Divaricatori costali	506
HAJEK-KOFLER Pinze per laminectomia	708
HAJEK Martelli	617
HALLE Coltello per dura-madre	37
HALLE Curette per ossa	604
HALLE Periostotomo	582
HALLE Spatola intima	512
HALSEY Portaghi	363
HALSEY TITE GRIP Portaghi	341-342
HALSTED-MICRO Pinze emostatiche fini	164
HALSTED-MOSQUITO-DE BAKEY Pinze emostatiche fini	165
HALSTED-MOSQUITO (HEISS) Pinze emostatiche fini	170
HALSTED-MOSQUITO Pinze emostatiche fini	164-165
HALSTED Pinze emostatiche fini	169, 171
HARDY-FAHLBUSCH Dissettori	693
HARDY Curette	692
HARDY Dissettori	693
HARDY Enuclatore	693
HARDY Forchetta per impiantare	693
HARKEN-DE BAKEY ATRAUMATIC-GRIP Pinze per dissezione e legature con dentatura DE BAKEY	551
HARRINGTON-MAYO Forbici per dissezione	86
HARRINGTON Divaricatori e spatole per polmone	262
HARTMAN (MOSQUITO-BABY) Pinze emostatiche fini	501
HARTMANN-COLLIN Divaricatore, doppio	229
HARTMANN Diapason	4
HARTMANN Pinze per la biopsia cervicale e da prelievo	462
HARTMANN Sonda auricolare	322
HASSELLTINE Pinze ombelicali	486
HAVERFIELD-SCOVILLE Divaricatore per laminectomia	286
HAYES ATRAUMATIC-GRIP Pinze per anastomosi del retto	400
HEANEY-BALLENTINE Pinza per isterectomia	196
HEANEY-DE BAKEY (ROGERS) ATRAUMATIC-GRIP Pinze per isterectomia	197
HEANEY-REZEK Pinza per isterectomia	196
HEANEY-SIMON Divaricatori per interventi in profondità	254
HEANEY Pinze per chirurgia	147

HEANEY Pinze per isterectomia	196
HEANEY Portaghi	369
HEANEY TITE GRIP Portaghi	346
HEATH Martello	620
HEGAR-BABY-OLSEN TITE GRIP Portaghi	348
HEGAR-BAUMGARTNER TITE GRIP Portaghi	342
HEGAR-CORWIN TITE GRIP Pinza gira cavo	662
HEGAR-MAYO Portaghi	367
HEGAR-MAYO TITE GRIP Portaghi	341, 345
HEGAR-OLSEN Portaghi con forbici	370
HEGAR-OLSEN TITE GRIP Portaghi	348
HEGAR Dilatatori uterini	444-445
HEGEMANN-DIETRICH DURACUT Forbici vascolari	56
HEGEMANN-DIETRICH Forbici vascolari	96
HEGENBARTH Pinza per mettere clips	379
HEIFETZ Pinze per afferare tessuti e tumori, a baionetta	127
HEIFETZ Spatole cerebrali	706
HEISS (HALSTED-MOSQUITO) Pinze emostatiche fini	170
HEISTER Apribocca	22
HEMINGWAY Curette per ossa	599
HENLEY Divaricatori autostatici	282-283
HENNIG Apri gesso	682
HERRICK Pinza per peduncoli renali	191
HEY-GUNNAR Pinza pressa tubi con rulli	203
HEYMANN DURACUT Forbici nasali	58
HEYMANN Forbici nasali	101
HEYWOOD-SMITH Pinza per polipi e ovaie	457
HEYWOOD-SMITH Pinze tirilingua	23
HIBBS Divaricatori	231
HIBBS Divaricatori spinali	231
Hilus e veni, Divaricatori	223
HIRSCHMANN Anoscopi	407
HOEN Periostotomi	586
HOGLUND-LOWMAN Tenaglie per ossa	630
HOHMANN-ALDINGER Leve per ossa	580
HOHMANN-LANGE Leve per ossa	577
HOHMANN-LANGE modif. Leve per ossa	577
HOHMANN-MINI Leve per ossa	576
HOHMANN Leve per ossa	578-580
HOKE Osteotomi	607
HOLSHER Separatore per la radici dei nervi	701
HOPKINS-JOHNS Pinza per applicare e rimuovere clamps	527
HOPKINS-JOHNS Pinze Bulldog	163
HOPKINS Coltelli per gessi	679
HORGAN Valva centrale per divaricatori addominali	303
HORNE-JOBSON Portacotone	317
HORSLEY-LISTON-KEY Cesiole per ossa	494
HORSLEY Dissetto per la dura-madre	698
HÖSEL Divaricatori	246
HOSPITAL-PROVIDENCE Pinze emostatiche fini	168
HOUSE Curette per ossa	598
HOWARD Periostotomo	583
HOZBACH Pinze per isterectomia	194
HRYNTSCHAK-YOUNG Portaghi a boomerang con 1 ago	372
HUDSON Trapano a mano per ossa	652
HULKA-KENWICK Pinza per abbassare il collo dell'utero	453
HULKA Pinza per abbassare il collo dell'utero	453
HUMBY Dermatomo	42
HUNTER Pinze per schegge	150
HURD Aghi per legatura	374

I

Idrocele e puntura addominale, Tre quarti	318
Iliaca, Pinza ATRAUMATIC-GRIP	558
Illuminatore prossimale per amnioscopio a luce calda con lampada	472
Illuminatore prossimale per amnioscopio a luce fredda	472
Imbuti	751
Impiantare, Forchetta	693
Impugnatura a molla per dita e piccolo divaricatore per ferite	271
INFANT-FINOCHIETTO Divaricatori costali in ALLUMINIO	501
Infermeria, Articoli	751
Infermiera, Set	18
INGE Separatori per vertebre	296
Iniezione, Ago	486
Insulina, Siringhe	330
Inter-osseo, Coltello	39
Interventi in profondità, Divaricatori	252-259

Intestinale, Aghi per sutura	354
Intestinale-gastro, Apparecchiatura di sutura	404
Intestinale-gastro, Graffe per sutura	404
Intestinali e addominali, Spatole	266-267
Intestinali, Anastomosi, Pinze	402
Intestinali, Pinze	390-396
Intestinali, Pinze ATRAUMATIC-GRIP	391-393, 395-396
Intestino e stomaco, Clamp-pinze	403
Intestino e stomaco, Clamp con perno	403
Intestino e tessuti, Pinze da presa	383-389
Intestino e tessuti, Pinze da presa ATRAUMATIC-GRIP	389
Intestino e tessuti, Pinze da presa TITE GRIP	388
Intestino, Pinze	149
Intima, Bisturi	513
Intima, Spatole	512-513
Intima, Spatole e dilatatori	512
Intra-uterina, Pinza	447
Introduzione, Aghi	334
IOWA Ago per iniezione	486
IOWA Guida ago a tromba	486
IOWA Pinza per puntura amniotica	477
Ipfisectomia transsfenoidale, Speculo	692
Ipfis, Strumenti	692-693
Iridectomie, Forbici DURACUT	45
Irrigatori	751
Ischemia, Fascia	570
Ischemia, Tubo	570
ISRAEL Divaricatori	237
Isterectomia, Pinze	194-196
Isterectomia, Pinze ATRAUMATIC-GRIP	197
Isterometri	446
Isterosalpingografia, Strumentario	474
IVES-FANSLER Anoscopi con otturatore di plàstico	407

J

JACKSON-CHEVALIER Cannule tracheali	726
JACKSON Divaricatore per trachea	226
JACKSON Pinza per la presa del tendine	647
JACKSON Speculi vaginali	438
JACKSON Uncino tracheale	217
JACOBS Pinza per abbassare il collo dell'utero	456
JACOBSON Micro portaghi	359
JACOBSON Bisturi per vasi	694-695
JACOBSON Micro-forbici	64
JACOBSON Punzone per sutura	694
JACOBSON Sonda bottonuta	694
JACOBSON Sonda doppia	694
JACOBSON TITE GRIP Micro-Portaghi	338
JAMESON Forbici fine per dissezione	93
JAMESON Portaghi	368
JANSEN-ZAUFAL Pinza per ossa	633
JANSEN (GRUENWALD) Pinze auricolari e nasali	136
JANSEN Curette per ossa	599
JANSEN Divaricatori autostatici	272
JANSEN Lampada	11
JANSEN Periostotomo	587
JANSEN Pinze auricolari e nasali	136
JANSEN Pinze per ossa	632
JAVERTS FLETCHER Pinza per tamponi e spugne	210
JAVID ATRAUMATIC-GRIP Pinze per carotide	537
JOBSON-HORNE Portacotone	317
JOHNS-HOPKINS Pinza per applicare e rimuovere clamps	527
JOHNS-HOPKINS Pinze Bulldog	163
JONES-LELAND Pinze per vasi periferici ATRAUMATIC-GRIP	534
JONES Pinze per fissare le compresse	200
JORGENSON Forbici per dissezione	98
JOSEPH Bisturi per rinoplastica	37
JOSEPH DURACUT Forbici per la chirurgia plastica	45
JOSEPH Forbici fine per chirurgia	70
JOSEPH Lima per ossa	592
JOSEPH Periostotomo	582
JOSEPH Uncini per chirurgia plastica	217, 219
JUDD-ALLIS Pinza da presa per intestino e tessuti	384
JUDD-MASSON Divaricatore vescicale	310

K

KADER Spatole addominali e intestinali	267
KALLMORGEN Speculi e valve vaginali	434
KALT Aghi per sutura vascolare	354
KALT Portaghi	363
KATSCH Tiracomedoni	19
KAY-LAMBERT ATRAUMATIC-GRIP Pinze per anastomosi dell'aorta	549
KAZANJIAN Cesoie per ossa	637
KELLY-BABY Pinze emostatiche fini	168
KELLY-RANKIN Pinze emostatiche fini	169
KELLY Divaricatori	251
KELLY Divaricatori per interventi in profondità	255
KELLY DURACUT Forbici vascolari e per fistole	45
KELLY Forbici per chirurgia	80
KELLY Pinza per polipi e ovaie	457
KELLY Pinze emostatiche fini	168
KELLY Pinze emostatiche fini TITAN-LINE	168
KELLY Sfinteroscopi	407
KENWICK-HULKA Pinza per abbassare il collo dell'utero	453
KERN-LANE Tenaglia per ossa	625
KERN-MINI Tenaglia per ossa	625
KERRISON-FERRIS-SMITH Pinze per laminectomia	709-710, 712
KERRISON-LOVE (COLCLOUGH) Pinze per laminectomia	710-711
KERRISON Pinze per laminectomia	707
KEVOURKIAN-PACIFIC Pinza per la biopsia cervicale e da prelievo	464
KEVOURKIAN-YOUNGE Curette per la biopsia endo-cervicale	459
KEVOURKIAN-YOUNGE Pinze per la biopsia cervicale e da prelievo	463,465
KEY-HORSLEY-LISTON Cesoie per ossa	494
KEY Periostotomi	589
KEYES Strumentario per trapanazione della cute	20
KEYES Trapani dermatici	20
KIELAND-LUIKART Forcipi	479
KIELAND Forcipi	479
KILLIAN-EICKEN Cannule per irrigazione del seno mascellare	322
KILLIAN (MÜHLING) Forbici per il setto nasale	102
KILLIAN Periostotomi	583
KILNER (GLASSMANN) Forbici	83
KILNER Divaricatore cutaneo	216
KILNER Forbici fine per dissezione	93
KILNER TITE GRIP Portaghi	342
KIRK Martello	618
KIRKLIN Divaricatori per vene	223
KIRSCHNER-BALFOUR Valva per divaricatori addominali	307
KIRSCHNER Archi per trazione	658-659
KIRSCHNER Divaricatori addominali	306
KIRSCHNER Punta filiformi	655
KIRSCHNER Sonde conduttrici	377
KIRSCHNER Valve per divaricatori addominali	307
KLAPP Divaricatori per guaina tendinea	225
KLEINERT-KUTZ Pinza passa tendine	649
KLEINSCHMIDT Pinza schiaccia sperone e clamp per appendicectomia	403
KLIMA-ROSEGGER Aghi per la puntura dello sterno	329, 518
KLINGENBERG-LOTH Forbici per dissezione	98
KNAPP Divaricatore	218
KNAPP Forbici fine per chirurgia	68
KNIGHT DURACUT Forbici nasali	58
KNIGHT Forbici nasali	101
KNOWLES Forbici per bendaggi	673
KNUTSON Strumento per ureterografia	426
KOCHER-BABY ATRAUMATIC-GRIP Pinze intestinali	391
KOCHER-BABY Pinze intestinali	391
KOCHER-LANGENBECK Divaricatori	240
KOCHER-OCHSNER Pinze emostatiche	177
KOCHER ATRAUMATIC-GRIP Pinza intestinali	395
KOCHER Divaricatori	232, 235, 242, 244
KOCHER Pinze emostatiche	176
KOCHER Pinze intestinali	392-394
KOCHER Sonda per gozzo	378
KOCHER Spatola vescicale	268
KOENIG Sonde conduttrici	377
KOERTE-LUER Cucchiari per calcoli biliari	417
KOERTE Divaricatori	236
KOFLER-HAJEK Pinze per laminectomia	708
KOGAN Endospeculi per cervice e uretra	443, 448
KÖLN MOD. Graffe emostatiche per cuoio capelluto	691
KÖNIG-ROSER Apribocca	22

KÖNIG Periostotomo	582
KONRICH Cestelli rotondi per sterilizzazione	743
KOOS Bisturi per vasi	695
KRAUS Bisturi per vasi	695
KRAUSE Tre quarti per puntura del seno mascellare	319
KRAYENBÜHL Uncini per nervi e vasi	215
KRISTELLER Speculi e valve vaginali	434-437
KROENLEIN Pinza emostatica	173
KRONECKER Aghi per legatura	374
KÜHNE Pinza con copertura vetrificata	152
KUTZ-KLEINERT Pinza passa tendine	649

L

LA GRANGE Forbici per gengiva	94
LABORDE Dilatatore per tracheotomia	728
LAHEY-SWEET Pinza per preparazioni e legature	189
LAHEY Divaricatore	219
LAHEY Divaricatore per gozzo	224
LAHEY Pinze per abbassare il collo dell'utero	454
LAHEY Pinze per preparazioni e legature	189
LAMBERT-KAY ATRAUMATIC-GRIP Pinze per anastomosi dell'aorta	549
LAMBERT-LOWMAN Tenaglia per ossa	630
LAMBOTTE-FARABEUF Tenaglia per ossa	626
LAMBOTTE-MINI Osteotomi	608
LAMBOTTE Osteotomi	608
LAMBOTTE Periostotomi costali	497
LAMBOTTE Tenaglie per ossa	626-627
Lame a scalpello intercambiabili	611
Lame a sgorbia intercambiabili	611
Lame di ricambio	681
Lame intercambiabili manico, con chiave	611
Lame intercambiabili per osteotomo	611
Lame per bisturi, sterili	34-35
Lamette	36
Laminectomia, Divaricatori	277, 279-280, 284, 286
Laminectomia, Pinze	707-719
Lampada di ricambio	472
Lampade frontali	11
LANDAU-COLLIN Speculi vaginali	431
LANDAU Speculi vaginali	440
LANDOLT-CUSHING Speculo per ipofisectomia transsfenoidale	692
LANDOLT Periostotomo	585
LANE-KERN Tenaglia per ossa	625
LANE-MURPHY Leve per lussazione	581
LANE Pinza per fissare le compresse	201
LANE Tenaglia per ossa	625
LANGE-HOHMANN Leve per ossa	577
LANGE-HOHMANN modif. Leve per ossa	577
LANGE Forbici per bendaggi	672
LANGENBECK- KOCHER Divaricatori	240
LANGENBECK-MINI Divaricatori	224
LANGENBECK-PARKER US-ARMY Divaricatori	231
LANGENBECK-RYDER TITE GRIP Portaghi	350
LANGENBECK Tenaglia per ossa	624
LANGENBECK Coltello per lobi	39
LANGENBECK Coltello per resezione	38
LANGENBECK Divaricatori	238-239
LANGENBECK Elevatori	575
LANGENBECK Periostotomi	587
LANGENBECK Seghe per amputazione e resezione	572
LANGENBECK TITE GRIP Portaghi	350
Lapis e apparecchio per marcare e scrivere	757
Lapis per marcare e scrivere	757
Laringoscopi	24-31
Laringoscopi luce fredda	26
Laringoscopia, Spatole	25
Laser chirurgia, Strumenti	448-451
Laterale, Speculo	448
LATHBURY (FARRELL) Portacotone	316
LAWRENCE Pinza per preparazioni e legature	187
LAWTON-MATHIEU TITE GRIP Portaghi	348
LAWTON TITE GRIP Portaghi	349
LAZAR Pinze microscopia	121
LEBSCHKE Scalpello per sterno	492
LEES ATRAUMATIC-GRIP Pinze per bronchi con dentatura DE BAKEY	552
Legatori emorroidali con aspiratore	411
Legatori, Anelli di gomma	410
Legatorri emorroidali con carica	410
Legatura, Aghi	374-376
Legatura, Guida	697
Legature e dissezione, Pinze	564
Legature e dissezione, Pinze ATRAUMATIC-GRIP	551
Legature e preparazioni, Pinze	180-189
Legature e preparazioni, Pinze ATRAUMATIC-GRIP	186
Legature e torace, Pinze	564
Legature, Forbici	352-353
Legature, Forbici, DURACUT	353
Legature, Micro-pinze	122-123
Legature, Micro-pinze in TITANIO	123
Legature, Pinza TITE GRIP	113
Legature, Pinze	152, 566
LEGUEU Spatola vescicale	268
LEKSELL-STILLE Pinze per ossa	635
LELAND-JONES Pinze per vasi periferici ATRAUMATIC-GRIP	534
LEMMON Spatole intima	512
LEMPERT Curette per ossa	604
LEMPERT Periostotomi	584
LEMPERT Pinze per ossa	631-632
Lenti binoculari frontali	8-9
LERICHE Pinze emostatiche fini	165
Leva ostetrica	481
Leve per lussazione	581
Leve per ossa	576-581
Leve per sciatica	580
LEWIN Pinza per riposizioni	622
LEWIS Raspa	592
LEXER-BABY Forbici per dissezione	87
LEXER-MAYO DURACUT Forbici per dissezione	48
LEXER-MAYO Forbici per dissezione	87
LEXER-MINI Osteotomi	612
LEXER-MINI Sgorbie	612
LEXER DURACUT Forbici per dissezione	49
LEXER Forbici per dissezione	87
LEXER Osteotomi	612-613
LEXER Sgorbie	612-613
LEXER Sgorbie per tessuto osseo spongioso	615
LEYLA Accessori per autofissatori di retrattori	703, 705
LEYLA Autofissatori per retrattori cervicale	704
LEYLA Autofissatori per retrattori, per il supporto del cranio	702
LEYLA Base di fissaggio	703
LEYLA Braccio flessibile per il fissaggio delle teste di accoppiamento	703
LEYLA Giunto a sfera ad incastro	705
LEYLA Porta asta per fissaggio al giunto a sfera e alle teste di accoppiamento	705
LEYLA Supporto per spatola craniale	703
LEYLA Testa accoppiamento	705
LICHTENBERG TITE GRIP Portaghi	349
LICHTWITZ Tre quarti per puntura del seno mascellare	319, 320
LICHTWITZ VEICKEN Tre quarti per puntura del seno mascellare	319
Lima, Taglio, Raspa	595
Lime per le unghie	18
Lime per ossa	592, 594-595
LINDORF TITE GRIP Pinza gira cavo	662
Liquidi, Scodelle	749
Liquido concentrato per la cura degli strumenti chirurgici PREP LUBE	733
LISTER Cesioie per bendaggi e vestiti	674
LISTER Forbici per bendaggi	673
LISTER modif. Forbici per bendaggi	673
LISTER Pinza per medicatura e tamponi	204
LISTON-KEY-HORSLEY Cesioie per ossa	494
LISTON-LITTAUER Cesioie per ossa	637
LISTON-RUSKIN Cesioie per ossa	638
LISTON-WALTON (BÖHLER) Cesioie per ossa	638
LISTON Cesioie per ossa	637, 639
LISTON Coltello per amputazione	38
LITTAUER-LISTON Cesioie per ossa	637
LITTAUER Forbici per legature	352
LITTAUER Pinza per ciglia	152
LITTLER Forbici per dissezione	81
Lobi, Coltelli	39
Lobo polmonare e retto, Forbici	99
LOCKHART-MUMMERY Sonda per fistole	314
LOCKLIN DURACUT Forbici per gengiva	55
LOCKLIN Forbici per gengiva	94
LOCKWOOD Pinza da presa per intestino e tessuti	386
Lombo vertebrale, Chirurgia, Speculi	295

LONG Pinza per isterectomia	194
LORNA Pinze per fissare le compresse	202
LOTH-KLINGENBERG Forbici per dissezione	98
LOTH-SCHOEMAKER Forbici per legature	352
LOUTE Trenditore serra filo	660
LOVE-GRUENWALD Pinze per laminectomia	716
LOVE-KERRISON (COLCLOUGH) Pinze per laminectomia	710-711
LOVE Separatori per le radici dei nervi	701
LOVELACE-DIXON Pinze emostatiche fini	169
LOVELACE Pinza da presa per intestino e tessuti	387
LOWER Pinza per preparazioni e legature	189
LOWMAN-HOGLUND Tenaglia per ossa	630
LOWMAN-LAMBERT Tenaglia per ossa	630
LOWMAN Tenaglie per ossa	630
LUCAE Diapason per neurologia	4
LUCAE Martello	617
LUCAE Pinze auricolari e nasali	136
LUCAE Uncini auricolari	213
LUCAS Curette per ossa	599
Luce fredda, Laringoscopi	26
Luce fredda, Spatole per laringoscopia	27
LUER-FRIEDMAN Pinza per ossa	631
LUER-KOERTE Cucchiali per calcoli biliari	417
LUER-STILLE Pinze per ossa	634
LUER-STILLE Pinze per ossa	636
LUER Cannule tracheali	725
LUER Divaricatori, doppi	227
LUER Pinze per ossa	631-632
LUIKART-KIELAND Forcipi	479
Lupus, Cucchiaino	19
Lupus, Raschiatoio	20
Lussazione, Leve	581

M

MAGILL Pinze introduttrici di cateteri	32
MAIER-SIMS Pinze per medicatura e tamponi	205
MAIER Pinze per medicatura e tamponi	205
MALTZ Raspa	593
MALTZ TITE GRIP Raspe	596
Manici metallici	13
Manici metallici per specchi laringei	13
Manici per bisturi	34-35
Manico a trazione	479
Manico ad uncino per fili per sega	687
Manico per aspirazione	320
Manico per lame intercambiabili, con chiave	611
Manico per meccanismo sferico di sgancio per inserire ed estrarre, Trapani	721
Mano di piombo	644
Mano, Divaricatore	271
Mano, Divaricatore e avambraccio	271
MARBACH Forbici per perineo	107
MARBERGER (GIL-VERNET) Divaricatori per veni e hilus	223
Marcare e scrivere, Lapis e apparecchio	757
MARKWALDER Pinza per costole	494
MARQUARDT Pinza per ossa	634
Martelli	2-3, 617-621
Martelli percussori	2-3
MARTIN Divaricatore per interventi in profondità	254
MARTIN Pelvimetro	477
MARTIN Pinze da presa per menisco e cartilagine	640
MARTINI Curette per ossa	598
MASSON-JUDD Divaricatore vescicale	310
MASSON Portaghi	368
MASSON TITE GRIP Portaghi	347
MASTIN Pinza muscolare	728
MATHIEU-LAWTON TITE GRIP Portaghi	349
MATHIEU Divaricatori	231
MATHIEU Divaricatori, doppi	226
MATHIEU Portaghi	371
MATHIEU Speculi rettali	405
MATHIEU Speculi vaginali	439
MATHIEU TITE GRIP Portaghi	349
MATHIEU Valve vaginali	439
MATSON Periostotomi costali	497
MATZENAUER Speculi vaginali	440
MAUNDER Apribocca	22

MAYFIELD Pinza per ossa	633
MAYO-ADAMS Divaricatori per appendicectomia	284
MAYO-BLAKE Pinze per calcoli biliari	418
MAYO-HARRINGTON Forbici per dissezione	86
MAYO-HEGAR Portaghi	367
MAYO-HEGAR TITE GRIP Portaghi	341, 345
MAYO-LEXER DURACUT Forbici per dissezione	48
MAYO-LEXER Forbici per dissezione	87
MAYO-NOBLE Forbici per dissezione	86
MAYO-ROBSON ATRAUMATIC-GRIP Pinze intestinali	396
MAYO-ROBSON Pinze intestinali	396
MAYO-STILLE DURACUT Forbici per dissezione	48
MAYO-STILLE Forbici per dissezione	85
MAYO Abbassalingua	12
MAYO Cucchiali per calcoli biliari	417
MAYO Divaricatori	249
MAYO DURACUT Forbici per dissezione	47
MAYO Forbici per dissezione	84
MAYO Pinza vascolare e per tumori	149
MAYO Spilli di sicurezza	736
MC KENTY Periostotomo	582
MC DONALD Dissettori	574
MC GIVNEY Pinze per emorroidi	410
MC INDOE Cesioie per ossa	638
MC INDOE Forbici per la cartilagine	82
MC INDOE Pinza anatomica per dissezione, fine	130
MC INDOE TITE GRIP Pinze anatomiche per dissezione	113
MC INTOSH Laringoscopi	24-27
MC INTOSH Laringoscopi luce fredda	26
MC INTOSH Spatole per laringoscopi	25
MC INTOSH Spatole per laringoscopia, Luce fredda	27
MC KENZIE Filo di argento	690
MC KENZIE Fresa	652
MC KENZIE Graffe di argento	690
MC KENZIE Pinza metti graffe	690
MC KENZIE Supporto porta-graffe	690
MC PHERSON Micro-Pinze per legature	122
MEAD Martello	618
MEAD Pinze per ossa	631
Meatotomo	426
Medicatura e tamponi, Pinze	204-207
Medicature, Pinze	208
Medicinali, Bicchieri	751
Medicinali, Cucchiaino	751
MEEKER-BABY Pinze per preparazioni e legature	180
MEEKER Pinza per preparazioni e legature	187
MENGHINI Aghi per la puntura cieca del fegato	329
Menisco e cartilagine, Pinze da presa	640
Menisco, Bisturi	642-643
MERCEDES Divaricatori per il torace	507
Mettere clips, Pinza	379
METZENBAUM-BABY Forbici per dissezione	89
METZENBAUM-NELSON DURACUT Forbici per dissezione	53
METZENBAUM-NELSON Forbici per dissezione	91
METZENBAUM -THOREK DURACUT Forbici adnex	54
METZENBAUM DURACUT Forbici per dissezione	49-54
METZENBAUM Forbici per dissezione	88-91
MEYERDING Divaricatori	225
MEYERDING Divaricatori per laminectomia	284
MICHEL Graffe	379
MICHEL Pinza per mettere clips	379
MICHEL Pinza per mettere e togliere clips	379
MICHEL Specchi per rinoscopia	14
MICRO-ADSON Pinze anatomiche per dissezione, fini	129
MICRO-ADSON Pinze fini per chirurgia	140-141
MICRO-ADSON Pinze per dissezione con denti	117
MICRO-CASTROVIEJO Micro portaghi	358
MICRO-CRILE Pinze emostatiche fini	166
Micro-forbici	62-67
MICRO-HALSTED Pinze emostatiche fini	164
Micro-Pinza TITE GRIP	118
Micro-pinze	120-125
Micro-pinze per afferare tessuti	124
Micro-pinze per afferare tessuti in TITANIO	124
Micro-pinze per legature	122
Micro-Pinze per legature	122-123
Micro-pinze per legature in TITANIO	123
Micro-Portaghi TITE GRIP	338-339
Micro-strumenti, Contenitore	737

Micro-strumenti, Telaio per sterilizzazione	737
Micro-tubo per aspirazione	321
Micro lame per salasso	473
Micro lame, Porta	473
Micro Pinze Bulldog	162
Micro portaghi	358-362
Micro portaghi in TITANIO	362
Micro salasso, Pipetta di vetro eparinizzata	473
Microchirurgia, Strumenti	694-697
Microchirurgia, Uncini	212-213
Microscopia, Pinze	121
MIDDELDORPF Divaricatori	243
MIKULICZ-BABY Pinza per peritoneo	192-193
MIKULICZ Divaricatore per interventi profondità	255
MIKULICZ Divaricatori per fegato	255
MIKULICZ Pinze per peritoneo	192-193
MILAN Curetta per la biopsia endo-cervicale	460
MILLER-SENN Divaricatori, doppi	226
MILLER Laringoscopi	28-31
MILLER Laringoscopi luce fredda	30
MILLER Raspe	592
MILLER Spatole per laringoscopi	29
MILLER Spatole per laringoscopia, Luce fredda	31
MILLER TITE GRIP Raspe	596
MILLESII Micro-forbici	64
MILLIGAN Dissetore per la dura-madre	698
MILLIN-YOUNG Portaghi a boomerang	372
MILLIN Dilatatore per collo vescicale	423
MILLIN Divaricatore vescicale	310
MILLIN Pinza per afferrare i lobi prostatici anteriori	423
MILLIN Pinza per prendere capsule, per prostatectomia retropubica	423
MILLIN Pinza portafilo	423
MINI-HOHMANN Leve per ossa	576
MINI-KERN Tenaglia per ossa	625
MINI-LAMBOTTE Osteotomi	608
MINI-LANGENBECK Divaricatori	224
MINI-LEXER Osteotomi	612
MINI-LEXER Sgorbie	612
MINI-STILLE Cesioie per gessi	677
Mini-trasformatore elettrico	11
MINI-YASARGIL Applicatori per clips vascolari	154
MINI-YASARGIL Clips vascolari	154
MIOTTI-OVERHOLT Pinze per preparazioni e legature	185
Misurare la profondità, Sonda	451
Misure, Sonda	450
Misure, Strumenti	448
Misurini graduati	751
MIXTER-BABY Pinze per preparazioni e legature	180
MIXTER-GEMINI Pinze per preparazioni e legature	181
MIXTER-O'SHAUGNESSY Pinze per preparazioni e legature	182
MIXTER-OVERHOLT Pinza per preparazioni e legature	183
MIXTER-PAUL Pinze per preparazioni e legature	182
MIXTER Forbici per chirurgia	79
MIXTER Pinza per preparazioni e legature	188
MIXTER Pinze per calcoli biliari	419
MIXTER Pinze per preparazioni e legature	182
MIXTER Pinze per preparazioni e legature	189
MOBERG Divaricatori	224
MOD. BONN Pinze fini per chirurgia	138
MOD. ENGL. Pinza per fissare le compresse	200
MOD. KÖLN Graffe emostatiche per cuoio capelluto	691
MOD. MÜNCHEN Curetta per la biopsia dell'endometrio	459
MOD. SCHWITZERLAND Micro-pinze	120
MOD. USA Apri gesso	682
MOD. USA Curette per ossa	601
MOD. USA Forbici ombelicali	108
MOD. USA Pinze anatomiche per dissezione	133
MOD. USA Pinze per chirurgia	145
MOD. WIENER Portalegature	378
MODELL CANAD. Bisturi per menisco	643
MODELL RUSS. Pinze vascolari e per tumori	149
MOGEN Strumento per circoncisione	426
MOLDESTAD Divaricatore per vene	217
MÖLTGEN Goniometro per le membra	7
MOORE-STAUDE Pinza per abbassare il collo dell'utero	452
MOORE Cucchiaino per colecisti	417
MORGAN-TISCHLER Pinza per la biopsia cervicale e da prelievo	464
MORRIS-DE BAKEY ATRAUMATIC-GRIP Pinze per aorta	540
MORSE Divaricatore per sternotomia	499

MOSQUITO-BABY (HARTMAN) Pinze emostatiche fini	164
MOSQUITO-HALSTED-DE BAKEY Pinze emostatiche fini	165
MOSQUITO-HALSTED (HEISS) Pinze emostatiche fini	170
MOSQUITO-HALSTED Pinze emostatiche fini	164-165
MOTT-PARKER Divaricatori, doppi	228
MOYNIHAN Pinze emostatiche	178
MOYNIHAN Sonda con cucchiaio per calcoli biliari	415
MÜHLING (KILLIAN) Forbici per il setto nasale	102
MÜHLING Periostotomi	584
MÜLLER-BIEMER Approssimatori	157
MÜLLER-VERBRUGGE Leve per ossa	579
MÜLLER Approssimatori	158
Multiuso, Pinze ATRAUMATIC-GRIP	520-523, 530, 556, 562
Multiuso, Pinze con dentatura DARDIK ATRAUMATIC-GRIP	554
Multiuso, Pinze con dentatura DE BAKEY ATRAUMATIC-GRIP	553
MUMMERY-LOCKHART Sonda per fistole	314
MÜNCHEN MOD. Curetta per la biopsia dell'endometrio	459
MURLESS Elevatore per testa in interventi con taglio cesareo	481
MURPHY-LANE Leve per lussazione	581
MURPHY Fascia frontale	10
MURRAY-CRILE Portaghi	366
Muscolare, Pinza	728
MUSEUX Pinze per abbassare il collo dell'utero	456
MYERS Sonde per vene	315

N

NABATOFF Astuccio per varici	315
NAEGELE Forcipi	478
NAGEL Micro-forbici	67
Narici posteriori, Uncini	221
Nasale, Aspirazione, Tubo	324
Nasali e auricolari, Pinze	136-137
Nasali, Forbici	101-102
Nasali, Forbici DURACUT	58
Nastro metrico di acciaio	6
Nastro metrico di tela	6
NEFF Bisturi per menisco	642
NEGUS Pinze emostatiche e per tonsille	179
NEIVERT-COTTLE Uncino per narici posteriori	221
NEIVERT TITE GRIP Portaghi	342
NEIVERTT Portaghi	363
NELATON Sonda bottonuta scanalata	314
NELSON-METZENBAUM DURACUT Forbici per dissezione	53
NELSON-METZENBAUM Forbici per dissezione	91
NELSON Pinza per chirurgia	148
NELSON Trequarti per idrocele e puntura addominale	318
Nervi e vasi, Uncini	213-215
Nervi, Forbici per dissezione	93
Neurochirurgia, Forbici	100
NEW ORLEANS Portaghi	367
NEW ORLEANS TITE GRIP Portaghi	344
NEWS Uncino tracheale	217
NOBLE-MAYO Forbici per dissezione	86
NORTHBENT SPENCER Forbici per legature	352
NOTO Pinza per polipi e ovaie	457
NOTT Speculi vaginali	433
NOVAK Curetta aspirante per la biopsia dell'endometrio	459

O

O'BRIEN Forbici per legature	352
OBWEGESER Divaricatori per tessuti molli	241
OBWEGESER TITE GRIP Pinza per legatura	113
Occhiali a lenti binoculari	9
Occlusione superiore del retto, Pinza-clamp ATRAUMATIC-GRIP	398-399
Occlusione tangenziale, Pinze ATRAUMATIC-GRIP	562
Occlusione tangenziale, Pinze vascolari ATRAUMATIC-GRIP	541
OCHSNER-DIXON CRILE-RANKIN Pinze emostatiche fini	167
OCHSNER-KOCHER Pinze emostatiche	177
OCHSNER-ROCHESTER Pinze emostatiche	178
OCHSNER ATRAUMATIC-GRIP Pinze per aorta	539
OCHSNER Dilatatori per condotti biliari	415
OCHSNER Pinza per legature	152
OCHSNER Trequarti per vescica biliare	318
O'CONNOR-O'SULLIVAN Divaricatori addominali	304
O'CONNOR Uncino cutaneo	217

OEHLER Pinze chirurgiche a denti di topo	118
Oftalmologia, Aghi	354
OG Aghi per oftalmologia	354
OLDBERG Pinza ipofisaria	719
OLIVECRONA-TOENNIS (SCOVILLE) Pinza metti Graffe	690
OLIVECRONA (GIGLI) Fili per sega	687
OLIVECRONA Dissettori per la dura-madre	700
OLIVECRONA Forbici per nervo trigemino	100
OLIVECRONA Spatole cerebrali	706
OLLIER Divaricatore	236
OLSEN-HEGAR Portaghi con forbici	370
OLSEN-HEGAR TITE GRIP Portaghi	348
OLSER-BABY-HEGAR TITE GRIP Portaghi	348
Ombelicali, Clamp	486
Ombelicali, Forbici	108
Ombelicali, Pinze	486
OMBREDANNE Martello	621
Orecchio ad autoriempimento, Siringa	332
Orecchio, Siringa	332
Oscillante, Segna	680
O'SHAUGNESSY-MIXTER Pinze per preparazioni e legature	182
Ossa e costole, Pinze	493
Ossa, Cesioie	494, 637-639
Ossa, Cranio, Pinze	688
Ossa, Curette	598-606
Ossa, Divaricatori	232
Ossa, Filo	660
Ossa, Leve	576-580
Ossa, Pinze	631-636
Ossa, Tenaglie	624-630
Ossa, Trapano a mano	651-653
Ossea, Strumenti per biopsia	669
Osseo spongioso, Sgorbie per tessuto	615
Osseo, Pinze per frammento	623
Osso, Trapano	721
Osteotomi	607-613
Osteotomi, Lame intercambiabili	611
Ostetrica, Leva	481
Ostetrica, Strumenti	481, 486
O'SULLIVAN-O'CONNOR Divaricatori addominali	304
Otturatore smusso per espellere il tessuto campione	721
Ovaie e placenta, Cucchiari	484
Ovaie e placenta, Curette	484
Ovaie e placenta, Pinza	482-483
Ovaie e polipi, Pinze	457
OVERHOLT-BABY Pinza per preparazioni e legature	183
OVERHOLT-GEISSENDOERFER Pinze per preparazioni e legature	184
OVERHOLT-MIOTTI Pinze per preparazioni e legature	185
OVERHOLT-MIXTER Pinza per preparazioni e legature	183
OVERHOLT Pinze per preparazioni e legature	183, 185

P

PACIFIC-KEVOURKIAN Pinza per la biopsia cervicale e da prelievo	464
Padelle	750
Parametrio, Pinze-clamps ATRAUMATIC-GRIP	197
Parametrium, Forbici DURACUT	60
PARK-ALAN Dilatore rettale con chiusura a scatto	408
PARKER-LANGENBECK US-ARMY Divaricatori	231
PARKER-MOTT Divaricatori, doppi	228
PARKER Divaricatori, doppio	228
PASQUE EUFRATE TITE GRIP Portaghi	344
Passafili, Aghi	661
Patent-ductus, Clamp ATRAUMATIC-GRIP	556
Patent-ductus, Pinze con dentatura DE BAKEY ATRAUMATIC-GRIP	531
PAUFIQUE Pinze fini per chirurgia	139
PAUL-MIXTER Pinze per preparazioni e legature	182
PAUL Divaricatore per guaina tendinea	225
PAYR-BABY Clamp per intestino e stomaco con perno	403
PAYR Aghi per sutura vascolare	354
PAYR Sonde conduttrici	377
Pb Aghi per sutura intestinale	354
PEAN-DE BAKEY ATRAUMATIC-GRIP Pinze emostatiche	176
PEAN-DE BAKEY ATRAUMATIC-GRIP Pinze vascolari	529
PEAN-ROCHESTER Pinze emostatiche	175
PEAN Pinze emostatiche	173-174
PEDERSON Speculi vaginali	432-433
PEERS Pinza per fissare le compresse	202

PEET Pinze per schegge	151
Pelle e dura-madre, Divaricatori	216
Pelle e dura-madre, Uncino	217
Pelle e tessuti, Uncino doppio per afferrare e sollevare	212
PELTESON Portacotone	317
Pelvometro	477
Pelvis, Divaricatori	256-258
PENFIELD Dissettori per la dura-madre	699
PENNINGTON Pinze da presa per intestino e tessuti	387
PERCY Retrattore per amputazione	571
Periducoli renali, Pinze	191
Perineo e (episiotomia), Forbici	107
Periostio con raschiatoio, Coltello	39
Periostotomi	496, 582-591, 694-697
Periostotomi costali	495, 497
Peritoneo, Pinze	192-193
PERMAN Divaricatore addominale	299
PERTHES Punteruolo	650
Pezzi di ricambio per lenti binoculari	8-9
PHANEUF Pinze per isterectomia	194
PIERCE Tre quarti per puntura del seno mascellare	319
PIFFARD Raschiatoio per lupus	20
Piloro, Divaricatore	403
PINARD Stetoscopio	5
Pinza-clamp per occlusione superiore del retto ATRAUMATIC-GRIP	398-399
Pinza-Micro TITE GRIP	118
Pinza Bulldog ATRAUMATIC-GRIP	556
Pinza con copertura vetrificata	152
Pinza da presa per intestino e tessuti	383-389
Pinza da presa per intestino e tessuti ATRAUMATIC-GRIP	389
Pinza da presa per instino e tessuti TITE GRIP	388
Pinza emostatica per tagli cesarei	481
Pinza guida per cateteri e tubi, con manico a molla	473
Pinza guida sonda e per la protezione della dura-madre	650
Pinza iliaca ATRAUMATIC-GRIP	558
Pinza intra-uterina	447
Pinza metti graffe	690
Pinza multiuso ATRAUMATIC-GRIP	530
Pinza muscolare	728
Pinza per afferrare i lobi prostatici anteriori	423
Pinza per afferrare il rene	421
Pinza per applicare e rimuovere clamps	527
Pinza per applicare le graffe emostatiche al cuoio capelluto	691
Pinza per fissare il cordone spermatico	425
Pinza per il cuoio capelluto	481
Pinza per intestino	149
Pinza per la biopsia cervicale e da prelievo	460
Pinza per la puntura amniotica	477
Pinza per l'aneurisma dell'aorta ATRAUMATIC-GRIP	561
Pinza per legatura	152
Pinza per legature, TITE GRIP	113
Pinza per mettere clips	379
Pinza per placenta e per ovaie	482-483
Pinza per prendere capsule, per prostatectomia retropubica	423
Pinza per rotula	623
Pinza per togliere le graffe emostatiche al cuoio capelluto	691
Pinza per tubo per scanalare	517
Pinza per unghie	645
Pinza per vase periferici ATRAUMATIC-GRIP	558
Pinza portafilo	423
Pinza raccogliatrice	735
Pinza schiaccia sperone	403
Pinza schiaccia sperone e clamp per appendicectomia	403
Pinza/clamp a pressione	409
Pinze	154-156
Pinze-clamps per parametrio ATRAUMATIC-GRIP	197
Pinze-clamps per rene	190
Pinze-clamps per rene ATRAUMATIC-GRIP	190
Pinze-micro	120-125
Pinze-micro per afferare tessuti	124
Pinze-micro per afferare tessuti in TITANIO	124
Pinze-micro per legature	122-123
Pinze-micro per legature in TITANIO	123
Pinze anatomiche per dissezione	132-134
Pinze anatomiche per dissezione TITE GRIP	112-115
Pinze anatomiche per dissezione, fini	128-131
Pinze auricolari e nasali	136-137
Pinze Bulldog	163
Pinze Bulldog con dentatura DE BAKEY ATRAUMATIC-GRIP	525-528

Pinze Bulldog in Titanio TITAN-LINE	160-161
Pinze chirurgiche a denti di topo	118
Pinze coartazione con dentatura COOLEY ATRAUMATIC-GRIP	557
Pinze con porta clips	378
Pinze da presa per menisco e cartilagine	640
Pinze di trazione craniale, Alesatore	689
Pinze emostatica per arteria renale ATRAUMATIC-GRIP	537
Pinze emostatiche	173-179
Pinze emostatiche ATRAUMATIC-GRIP	176
Pinze emostatiche e per tonsille	179
Pinze emostatiche fini	164-173
Pinze emostatiche fini TITAN-LINE	166, 168
Pinze emostatiche per arterie renale ATRAUMATIC-GRIP	558
Pinze ferma tendine	648
Pinze fini per chirurgia	138-143
Pinze gira cavo TITE GRIP	662
Pinze guida sonda	650
Pinze intestinali	390-396
Pinze intestinali ATRAUMATIC-GRIP	391-393, 395-396
Pinze intestinali e per anastomosi	402
Pinze introduttrici di cateteri	32
Pinze ipofisaria	719
Pinze metti-rimuovi clamps Bulldog TITAN-LINE	160
Pinze Micro Bulldog	162
Pinze multiuso ATRAUMATIC-GRIP	520-523, 556, 562
Pinze multiuso con dentatura DARDIK ATRAUMATIC-GRIP	554
Pinze multiuso con dentatura DE BAKEY ATRAUMATIC-GRIP	553
Pinze ombelicali	486
Pinze passa tendine	649
Pinze patent-ductus con dentatura DE BAKEY ATRAUMATIC-GRIP	531
Pinze per abbassare il collo dell'utero	452-456
Pinze per afferrare tessuti e tumori	126-127
Pinze per afferrare e rompere le lamette da rasoio	36
Pinze per afferrare l'utero	458
Pinze per afferrare tessuti	149
Pinze per allacciare tendini	649
Pinze per anastomosi (vena cava)	565
Pinze per anastomosi ATRAUMATIC-GRIP	520-523
Pinze per anastomosi con dentatura COOLEY	559-560
Pinze per anastomosi con dentatura DE BAKEY	542-544
Pinze per anastomosi del colon	402
Pinze per anastomosi del retto	400-401
Pinze per anastomosi del retto ATRAUMATIC-GRIP	400-401
Pinze per aorta ATRAUMATIC-GRIP	561
Pinze per aorta con dentatura DE BAKEY ATRAUMATIC-GRIP	537-540
Pinze per bronchi con dentatura DE BAKEY ATRAUMATIC-GRIP	552
Pinze per calcoli biliari	418-419
Pinze per calcoli renali	420-421
Pinze per carotide ATRAUMATIC-GRIP	537
Pinze per chirurgia	144-148
Pinze per ciglia	152
Pinze per coartazione ATRAUMATIC-GRIP	532-533
Pinze per costole	494
Pinze per dissezione con denti TITE GRIP	117
Pinze per dissezione del polmone	149
Pinze per dissezione e legature	564
Pinze per dissezione e legature ATRAUMATIC-GRIP	551
Pinze per emorroidi	410
Pinze per estrazione delle unghie	645
Pinze per fissare le compresse	200-202
Pinze per frammento osseo	623
Pinze per isterectomia	194-196
Pinze per isterectomia ATRAUMATIC-GRIP	197
Pinze per la carotide ATRAUMATIC-GRIP	527
Pinze per la carotide con dentatura LAWTON ATRAUMATIC-GRIP	524
Pinze per la presa del tendine	647
Pinze per laminectomia	707-719
Pinze per l'anastomosi dell'aorta ATRAUMATIC-GRIP	548-549
Pinze per l'aneurisma dell'aorta ATRAUMATIC-GRIP	545-547
Pinze per legature	566
Pinze per medicatura e tamponi	204-207
Pinze per medicature	208
Pinze per microscopia	121
Pinze per occlusione tangenziale ATRAUMATIC-GRIP	562
Pinze per ossa	631-636
Pinze per ossa e costole	493
Pinze per ossa per cranio	688
Pinze per peduncoli renali	191
Pinze per peritoneo	192-193
Pinze per polipi e ovaie	457
Pinze per preparazioni e legature	180-189
Pinze per preparazioni e legature ATRAUMATIC-GRIP	186
Pinze per pressa tubi con rulli	203
Pinze per profondità ATRAUMATIC-GRIP	534
Pinze per riposizioni	622-623
Pinze per schegge	150-151
Pinze per sterilizzazione	734
Pinze per stomaco ATRAUMATIC-GRIP	397
Pinze per tamponi e spugne	209-210
Pinze per tessuti e per aghi TITE GRIP	116
Pinze per torace e legature	564
Pinze per trazione craniale	689
Pinze per tubi	203
Pinze per vasi periferici ATRAUMATIC-GRIP	534-536
Pinze per vena cava ATRAUMATIC-GRIP	550
Pinze porta cavo	663-664
Pinze porta cavo TITE GRIP	663
Pinze senza porta clips	378
Pinze taglianti per biopsia rettale	412
Pinze tiralingua	23
Pinze TITE GRIP	118
Pinze vascolare e per tumori	149
Pinze vascolari ATRAUMATIC-GRIP	135, 520
Pinze vascolari con dentatura COOLEY	555-556, 558, 561-562
Pinze vascolari con dentatura DE BAKEY	529-530, 534, 537
Pinze vascolari con dentatura LAWTON ATRAUMATIC-GRIP	521-523
Pinze vascolari e per tumori	149
Pinze vascolari per occlusione tangenziale ATRAUMATIC-GRIP	541
Pinze vascolari semi flessibili	563
Pinze ventricolari	564
Pinze, Sterilizzatore	735
Pinze/clamp per intestino e stomaco	403
PIPER Forcipi	480
Pipetta di vetro eparinizzata per micro salasso	473
Pistola a getto d'acqua con vari raccordi	754
Placenta e ovaie, Cucchiari	484
Placenta e ovaie, Curette	484
Placenta e ovaie, Pinza	482-483
PLESTER Divaricatori autostatici	275
Pleura, Ago per la puntura	329, 518
Pneumo-peritoneo, Aghi	329
Polipi e ovaie, Pinze	457
Polmone, Divaricatori	260
Polmone, Divaricatori e spatole	261
Polmone, Pinze per dissezione	149
POOLE Tubi aspirazione	325
Porta-graffe, Supporto	690-691
Porta asta per fissaggio al giunto a sfera	705
Porta asta per fissaggio al giunto a sfera e alle teste di accoppiamento	705
Porta asta per teste di accoppiamento	705
Porta garza uterino	447
Porta micro lame	473
Porta spugne/cotone	473
Porta targhette	743
Portacotone	316-317, 409
Portafilo, Pinza	423
Portaghi	363-372
Portaghi-Micro TITE GRIP	338-339
Portaghi a boomerang	372
Portaghi con forbici	370
Portaghi Micro	358-362
Portaghi TITAN-LINE	365
Portaghi TITE GRIP	340-350
Portalegature	378
Portapinze	402
Potrighi a boomerang, Aghi di ricambio	372
POTTS-DE BAKEY ATRAUMATIC-GRIP Pinze patent-ductus	531
POTTS-SMITH DURACUT Forbici vascolari	56
POTTS-SMITH Forbici per dissezione	98
POTTS-SMITH Forbici vascolari	96-97
POTTS-SMITH Pinze anatomiche per dissezione, fini	131
POTTS-SMITH Pinze fini per chirurgia	143
POTTS-SMITH TITE GRIP Pinze per dissezione	114
POZZI Pinza per abbassare il collo dell'utero	453
PRATT Pinze per abbassare il collo dell'utero	455
PRATT Sonde per fistola	409
PRATT Speculi retali	405
Prelievo e cervicale, Pinza per la biopsia	460

Prelievo ed aspirazione, Curette	471
PREP LUBE Detergente per strumenti	733
PREP LUBE Liquido concentrato per la cura degli strumenti chirurgici	733
Preparazioni e legature, Pinze	180-189
Preparazioni e legature, Pinze ATRAUMATIC-GRIP	186
PRESBYTERIAN Pinza per tubi	203
Pressa tubi con rotoli, Pinze	203
PRICE-THOMAS Pinze per legature	566
Profondità, Pinze ATRAUMATIC-GRIP	534
Prostata, Strumenti	423
Prostatectomia retropubica, Pinza per prendere capsule	423
Prostatici anteriori, Pinza per afferrare i lobi	423
Prostatici, Retrattori	422
Protesi dentarie, Recipienti	751
Protezione della dura-madre e guida sonda, Pinza	650
PROVIDENCE-HOSPITAL Pinze emostatiche fini	168
Pulizia, spazzole	756
Punta	652
Punta a spirale	652
Punte filiformi di KIRSCHNER	655
Punte filiformi, Distributore	656
Punte filiformi, Distributore multiplo	657
Punteruoli	650
Puntura addominale e idrocele, Tre quarti	318
Puntura amniotica, Pinza	477
Puntura cieca del fegato, Aghi	329
Puntura della pleura, Ago	329, 518
Puntura dello sterno, Aghi	329, 518
Punture lombari, Aghi	328
Punzone per sutura	694
Punzoni	606
PUTTI Raspe	594
PYNCHON-ANDREW Tubo aspirazione	325

Q

QUERVAIN Elevatori	575
QUINBY Forbici per gengiva	94
QUINKE Aghi per punture lombari	328

R

RABINER Martelli percussori	3
Raccogliatrice, Pinze	735
Raccordi	333
Raccordi per pistola a getto d'acqua	755
Radici dei nervi separatori	701
RADOLF Pinza per estrazione delle unghie	645
RAGNEL DURACUT Forbici per dissezione	49
RAGNEL Forbici per chirurgia e per dissezione	83
RAGNELL-DAVIS Divaricatori per chirurgia plastica	226
RALK Trapano a mano per ossa	653
RALKS (VIRTUS) Pinza per schegge	151
RAMPLEY Pinze per tamponi e spugne	210
RANDALL Curetta aspirante per la biopsia dell'endometrio	459
RANDALL Pinze per calcoli renali	420-421
RANEY Graffe emostatiche per cuoio capelluto	691
RANEY Pinza per applicare e togliere le graffe emostatiche al cuoio capelluto	691
RANEY Supporto porta-graffe	691
RANKIN-CRILE-DE BAKEY ATRAUMATIC-GRIP Pinze emostatiche fini	167
RANKIN-CRILE (OCHSNER-DIXON) Pinze emostatiche fini	167
RANKIN-CRILE Pinze emostatiche fini	167
RANKIN-KELLY Pinze emostatiche fini	169
Raschiatoio per lupus	20
Raspa, Taglio di lima	595
Raspe	592-597
Raspe TITE GRIP	596-597
RAY Curette	692
RECAMIER Curette per placenta e ovaie	484
RECAMIER Curette uterine	468
Recipienti	747
Recipienti cilindri	747
Recipienti per protesi dentarie	751
REDO Pinze intestinali	390
REDON Aghi per introduzione	334
REINER Coltello per gessi	679

Renale, Pinze emostatica per arteria ATRAUMATIC-GRIP	537
Renali, Pinze per calcoli	420-421
Rene, Pinza per afferrare	421
Rene, Pinze-clamps	190
Rene, Pinze-clamps ATRAUMATIC-GRIP	190
Reniformi, Bacinelle	750
RESANO ATRAUMATIC-GRIP Pinze per anastomosi del retto	401
Resezione e amputazione, Coltello	39
Resezione e amputazione, Seghe	572-573
Resezione, Coltelli	38
Retratore doppio per estrarre il tessuto molle	721
Retratore per amputazione	571
Retrattori per ginocchio	641
Retrattori prostatici	422
Retrattori, Autofissatori per fissare alla tavola operatoria	704
Retrattori, Autofissatori per sopporto del cranio	702
Rettali, Speculi	405-406
Rettangolari, Bacinelle	748
Retto e lobo polmonare, Forbici	99
Retto, Pinze per anastomosi	400-401
REVERDIN Spatola addominale e intestinale	267
REVERDIN , Aghi	373
REYNOLDS-COOLEY ATRAUMATIC-GRIP Pinze per anastomosi	559
REYNOLDS-DE BAKEY ATRAUMATIC-GRIP Pinze per anastomosi	542
REYNOLDS Forbici fine per dissezione	93
REZEK-HEANEY Pinza per isterectomia	196
Ricambi per sega oscillante	681
Ricambio per portaghi a boomerang, Aghi	372
Ricambio, Lama	681
Ricambio, Lampada	472
RICARD Divaricatori addominali	298
RICHARDSON-EASTMAN Divaricatori	250
RICHARDSON Divaricatori	251
RICHTER-HEATH Pinza per togliere clips	379
RICHTER Forbici per chirurgia	80
RIENHOFF-FINOCHIETTO Divaricatori costali	506
Riga graduata per misure radiologiche	6
Righe graduate in acciaio	6
Rimuovere e applicare clamps, Pinze	527
Rinoplastica, Bisturi	37
Riposizioni, Pinze	622-623
ROBB Spatole e dilatatori intima	512
ROBERTS Pinze emostatiche	178
ROBSON-MAYO ATRAUMATIC-GRIP Pinze intestinali	396
ROBSON-MAYO Pinze intestinali	396
ROCHARD Dispositivo di fissaggio	309
ROCHARD Divaricatori addominali	309
ROCHARD Telaio di supporto per il fissaggio alla barra laterale del tavolo operatorio	309
ROCHESTER-CARMALT Pinze emostatiche	178
ROCHESTER-OCHSNER Pinze emostatiche	178
ROCHESTER-PEAN Pinze emostatiche	175
ROEDER Pinza per fissare le compresse	201
ROGERS DE BAKEY-HEANEY ATRAUMATIC-GRIP Pinze per isterectomia	197
ROGERS DE BAKEY-WERTHEIM ATRAUMATIC-GRIP Pinze-clamps per parametrio	197
ROGGE Pinza per sterilizzazione	734
ROLLET Divaricatore	218
Rompi gesso	682
ROSCHKE Dilatatori per l'ano	407
ROSE Divaricatori, doppi	227
ROSEGGER-KLIMA Aghi per la puntura dello sterno	329, 518
ROSEN Cannule per aspirazione	320
ROSER-KÖNIG Apribocca	22
Rotonde, Scodelle	749
RÖTTGEN-RUSKIN Pinza per ossa	636
Rotula, Pinza	623
ROUX-BABY Divaricatore, doppio	228
ROUX Divaricatori, doppi	229
Rubinetti	333
RUDD Legatori emorroidali con carica	410
RUMEL-BELMONT Tourniquets	518
RUMEL-DE BAKEY ATRAUMATIC-GRIP Pinze per preparazioni e legature	186
RUMEL Pinze per preparazioni e legature	186
RUSKIN-LISTON Cesole per ossa	638
RUSKIN-RÖTTGEN Pinza per ossa	636
RUSKIN-STILLE Pinza per ossa	636

RUSKIN Cesoie per ossa 638
RUSKIN Pinze per ossa 633-634
RUSS. MODELL Pinze vascolari e per tumori 149
RUST Seghe per amputazione e resezione 573
RYDEL-SEIFFER Diapason per neurologia 4
RYDER-LANGENBECK TITE GRIP Portaghi 350
RYDER-VASCULAP TITE GRIP Portaghi 340
RYDER TITE GRIP Portaghi 340

S

SAALFELD Tiracomedoni 19
SACHS Dissettori per la dura-madre 698
SACHS Uncino per dura-madre 217
SACHS Uncino per fistole 221
SACHSE Meatotomo 426
SAENGER Pinza per placenta e per ovaie 483
 Salasso e l'amnioscopia, Strumentario 472-473
 Salasso micro, Pipetta di vetro eparinizzata 473
 Salasso, amnioscopio, conico 472
 Salasso, Micro lame 473
SALENIUS Bisturi per menisco 642
SALING Amnioscopio conico 472
SALING Amnioscopio per salasso, conico 742
SAMII-YASARGIL Pinze per afferrare tessuti e tumori, a baionetta 126
SAMII Pinza per afferrare tessuti e tumori, a baionetta 127
SANVENERO Forbici fine per chirurgia 70
SAROT Pinze emostatiche fini 171
SAROT Pinze per legature 566
SAROT TITE GRIP Portaghi 344
SATINSKI Forbici per vena cava 99
SATINSKY-BABY Pinze per anastomosi (vena cava) 565
SATINSKY-DE BAKEY ATRAUMATIC-GRIP Pinze Bulldog 525
SATINSKY Pinze per anastomosi (vena cava) 565
SATTERLEE Seghe per amputazione e resezione 572
SAUER Pinze fini per chirurgia 138
SAUERBRUCH-FREY Costotomo 493
SAUERBRUCH-SCHNEIDER Periostotomo 588
SAUERBRUCH Divaricatori 242
SAUERBRUCH Pinza raccogliatrice 735
SAUERBRUCH Scatole per sterilizzare aghi da sutura 357
SCALP CONTOUR Divaricatori autostatici 276
 Scalpelli 607, 609-611, 613-614
 Scalpello per sterno 492
 Scalpello, Lame intercambiabili 611
 Scanalare e guida, Strumento 646
 Scanalare, Pinza per tubo 517
 Scanalare, Set 516
 Scanalare, trapiantare, bypass, Strumenti 517
 Scanalare, Tubo per manico 517
 Scapola, Divaricatori 260
 Scatole per sterilizzare aghi da sutura 357
SCHAAF Pinza per ciglia 152
SCHÄDEL Pinze per fissare le compresse 200
SCHAMBERG Tiracomedoni 19
SCHEDE Curette per ossa 602
 Schegge, Pinze 150-151
SCHERBACK Speculi vaginali 442
 Schiaccia sperone, Pinza 403
 Schiaccia sperone, Pinza e clamp per appendicectomia 403
SCHINK Dermatomo 41
SCHMID Aghi vascolari per irrigazione 322
SCHMID Spatole intima 513
SCHMIEDEN-TEYLOR Forbici per dura madre 100
SCHMIEDEN Sonde conduttrici 378
SCHNEIDER-SAUERBRUCH Periostotomo 588
SCHNEIDER Periostotomi 588
SCHNIDT Pinze emostatiche e per tonsille 179
SCHOEMAKER-LOTH Forbici per legature 352
SCHRÖDER Curette uterine 466
SCHRÖDER Pinze per abbassare il collo dell'utero 452, 454
SCHUBERT Pinza per la biopsia cervicale e da prelievo 461
SCHULTZE Salpingografo 474
SCHUMACHER Forbici ombelicali 108
SCHUMACHER Pinza per la biopsia cervicale e da prelievo 463
SCHWARTZ Applicatore per clips vascolari 155
SCHWARTZ Clips vascolari 155
SCHWITZERLAND MOD. Micro-pinze 120

Sciatica, Leve 580
 Scodelle per liquidi 749
 Scodelle per soluzioni 749
 Scodelle rotonde 749
SCOVILLE-HAVERFIELD Divaricatore per laminectomia 286
SCOVILLE (TOENNIS-OLIVECRONA) Pinza metti graffe 690
SCOVILLE Divaricatore per laminectomia 286
SCOVILLE Gancio per divaricatori 287
SCOVILLE Separatori per la radici dei nervi 701
SCOVILLE Valve laterali per divaricatori 287
 Scrivere e marcare, Lapis e apparecchio 757
SCUDDER ATRAUMATIC-GRIP Pinze per stomaco 397
SEALY Forbici fine per chirurgia 68
SEBILEAU Elevatori 575
 Secrezioni, Curetta 425
SEDILLOT Periostotomi 586
 Sega oscillante 680
 Sega oscillante, Ricambi 681
 Sega, Fili 687
 Sega, Manico ad uncino 687
 Seghe per amputazione e resezione 572-573
 Seghe per anelli 645
 Seghe per gessi 679
SEOND Pinze per isterectomia 195-196
SEIFFER-RYDEL Diapason per neurologia 4
SELETZ-GELPI Divaricatore per vulva 281
SELLHEIM Leva osteretrica 481
SELLORS Divaricatore ed approssimatore costale 508
SEMB Cesoia per ossa 494
SEMB Divaricatori per polmone 260
SEMB Periostotomi 496
SEMB Pinza per ossa 494
SEMB Pinze per dissezione e legature 564
SEMB Pinze per ossa e costole 493
SEMKEN Pinza per dissezione con denti 117
SEMKEN Pinze anatomiche per dissezione, fini 130
SEMKEN Pinze fini per chirurgia 142
SEMKEN TITE GRIP Pinze anatomiche per dissezione 113
SEMM Divaricatore addominale 305
SEMM Speculi vaginali 432
SENN-GREEN Divaricatori 224
SENN-MILLER Divaricatori, doppi 226
 Seno mascellare, Cannule per irrigazione 322
 Seno mascellare, Tre quarti per puntura 319-320
 Separatori per le radici dei nervi 701
 Separatori per vertebre 296
 Serra filo, Trenditore 660
 Serrapene 426
 Serrapinze 402
 Set per biopsia vertebrale 720
 Set per endarterectomia 515
 Set per infermiera 18
 Set per scanalare 516
 Set per sutura 380
 Set per tracheotomia 729-730
 Seta intrecciata 353
 Setto nasale, Ago 328
 Setto nasale, Forbici 102
 Setto nasale, Forbici DURACUT 59
SEUTIN Cesoie per vestiti e gessi 675
SEWALL Periostotomo 582
 Sfinteroscopi 407
 Sgorbia, Lame intercambiabili 611
 Sgorbie 607, 609-616
 Sgorbie per tessuto osseo spongioso 615
 Sgorbie spinali 616
SHAMBAUGH Uncini per microchirurgia 212
 Sicurezza, Spilli 736
SIEBOLD-SIMS Forbici da utero 106
SIEBOLD Forbici da utero 106
SILVER Dermatomo 41
SIMON-HEANEY Divaricatori per interventi in profondità 254
SIMON Curette per ossa 605
SIMON Curette uterine 466
SIMON Divaricatori per interventi in profondità 254
SIMON Uncino per fistole 221
SIMPSON-BRAUN Forcipi 478
SIMPSON Isterometri 446
SIMS-MAIER Pinze per medicatura e tamponi 205

SIMS-SIEBOLD Forbici da utero	106	Sperone, Schiaccia, Pinza	403
SIMS Curette uterine	467	Spezzacrano	485
SIMS DURACUT Forbici uterine	60	Spilli di sicurezza	736
SIMS Forbici da utero	104-105	Spinali, Divaricatori	231
SIMS Isterometri	446	Spinali, Sgorbie	616
SIMS Speculi rettali	405-406	SPRATT Curette per ossa	602
SIMS Speculi vaginali, doppi	438	Spugne e tamponi, Pinze	209-210
SINGLEY (TUTTLE) Pinze per dissezione del polmone	149	Spugne/cotone, Porta	473
Siringhe da insulina	330	SPURLING Pinze per laminectomia	717
Siringa da tuberculina	330	Sputacchiera	751
Siringa per orecchio	332	ST. MARKUS Divaricatori per pelvis	258
Siringa per orecchio ad autorimpimento	332	ST. MARTIN Pinze fini per chirurgia	139
Siringhe	330-333	STACKE Sonda bottonuta	313
Siringhe per ferite e vescica	331	STADLER -BRAUN Forbici per perineo	107
SMELLIE Spezzacrano	485	STANDART-YASARGIL Applicatori per clips vascolari	154
SMILLIE Bisturi per menisco	643	STANDART-YASARGIL Clips vascolari	154
SMILLIE Retrattori per ginocchio	641	STAUDE-MOORE Pinza per abbassare il collo dell'utero	452
SMITH-BUIE Dilatatori per l'ano ed il retto	408	STEINMANN Chiodi	654
SMITH-CUSHING-FERRIS Pinze per laminectomia	713	STEINMANN Pinza per la presa del tendine	647
SMITH-FERRIS Pinze per chirurgia	147	STELLBRING Pinze per ossa	632
SMITH-HEYWOOD Pinza per polipi e ovaie	457	STELZNER (CRAFOORD) Forbici per lobo polmonare e per il retto	99
SMITH-HEYWOOD Pinze tiralingua	23	Sterilizzatore per pinze	735
SMITH-KERRISON-FERRIS Pinze per laminectomia	709-710, 712	Sterilizzazione e conservazione, Cestelli	738
SMITH-POTTS DURACUT Forbici vascolari	56	Sterilizzazione, Cestelli in acciaio perforato	744
SMITH-POTTS Forbici per dissezione	98	Sterilizzazione, Castello in rete metallica	744
SMITH-POTTS Forbici vascolari	96-97	Sterilizzazione, Cestelli	739-741, 744-745
SMITH-POTTS Pinze anatomiche per dissezione, fini	131	Sterilizzazione, Cestelli in plastica	742
SMITH-POTTS Pinze fini per chirurgia	143	Sterilizzazione, Cestelli rotondi	743
SMITH-POTTS TITE GRIP Pinze per dissezione	114	Sterilizzazione, Pinze	734
SMITH Forbici per bendaggi	672	Sterilizzazione, Scatole per aghi da sutura	357
SOFT-GREGORY Pinze per la carotide ATRAUMATIC-GRIP	527	Sterilizzazione, Telai	737
Soluzioni, Scodelle	749	Sterilizzazione, Telaio per aghi per sutura	736
SOMER Pinza per afferrare l'utero	458	Sterilizzazione, Telaio per micro-strumenti	737
Sonda con cucchiaio per calcoli biliari	415	Sterno, Aghi per la puntura	518
Sonda doppia	694	Sterno, Scalpello	492
Sonda per gozzo	378	Sternotomia, Divaricatore	499
Sonda per misurare la profondità	451	Sternotomia, Divaricatore in ALLUMINIO	498
Sonda per misure	450	Stetoscopi	5
Sonda, Pinze guida	650	STEVENS Forbici fine per dissezione e per tenotomia	92
Sonde	312-314, 450-451	STIEGLITZ (WILLIAMS) Pinze per schegge	151
Sonde a foglia mirto	313	Stilette per canale lacrimale	312
Sonde auricolari	322	STILLE-BARRAYA Pinze per chirurgia	148
Sonde bottonute	312-313, 694	STILLE-CRAFOORD Pinza emostatica fine	170
Sonde bottonute scanalate	314	STILLE-DOYEN Divaricatori	247
Sonde con occhio	313	STILLE-GIERTZ Costotomo	492
Sonde conduttrici	377-378	STILLE-LEKSELL Pinze per ossa	635
Sonde per fistole	314, 409	STILLE-LUER Pinze per ossa	634
Sonde per vene	315	STILLE-LUER Pinze per ossa	636
Sonde rettali	409	STILLE-MAYO DURACUT Forbici per dissezione	48
Sonde scanalate	314	STILLE-MAYO Forbici per dissezione	85
Sopporto per spatola craniale	703	STILLE-MINI Cesioie per gessi	677
Spatola craniale, Sopporto	703	STILLE-RUSKIN Pinza per ossa	636
Spatole addominali e intestinali	266-267	STILLE-STRANDELL Divaricatori per guaina tendinea	225
Spatole cerebrali	706	STILLE Cesioie per gessi	677-678
Spatole e dilatatori intima	512	STILLE Osteotomi	610
Spatole e divaricatori per polmone	261	STILLE Pinza per ossa	635
Spatole intima	512-513	STILLE Scalpelli	610
Spatole per laringoscopi	25	STILLE Sgorbie	610
Spatole per laringoscopia, Luce fredda	27	STILLE Trapano a mano per ossa	651
Spatole vescicali	268	STOCKMANN Serrapene	426
Spazzola per unghie	752	Stomaco e intestino, Clamp con perno	403
Spazzole e asciugamani, Cestelli	753	Stomaco e intestino, Clamp/pinze	403
Spazzole per pulizia	756	Stomaco, Pinze ATRAUMATIC-GRIP	397
Spazzole, Cestelli	753	Strabismo, Uncini	213
Spazzole, Contenitore	753	STRANDELL-STILLE Divaricatori per guaina tendinea	225
Spazzole, Distributori	752	STRATTE TITE GRIP Portagli	347
Spazzolino per pulire per cannule tracheali	727	STRAUSS Serrapene	426
Specchi frontali	10	STRULLY Forbici per neurochirurgia	100
Specchi laringei	13-14	Strumentario per isterosalpingografia	474
Specchi per rinoscopia	14	Strumentario per l'amnioscopia e il salasso	472-473
Speculi e valve vaginali	434-437, 439	Strumentario per trapanazione della cute	20
Speculi per chirurgia lombo vertebrale	295	Strumenti per biopsia ossea	669
Speculi rettali	405-406	Strumenti per biopsia vertebrale CRAIG-KOGLER	720-721
Speculi vaginali	430-442	Strumenti per cerchiaggio	660
Speculo laterale	448	Strumenti per chirurgia laser	448-451
Speculo per ipofisectomia transsfenoidale	692	Strumenti per esaminare e misurare	6
SPENCER-WELLS Pinze emostatiche	173	Strumenti per ipofisi	692-693
SPENCER (NORTHBENT) Forbici per legature	352	Strumenti per l'apertura del cranio	687
SPENCER Forbici per legature	352	Strumenti per l'urologia	425-426

Strumenti per mettere i punti	690-691
Strumenti per microchirurgia	694-697
Strumenti per misurare	7, 448
Strumenti per misurare la sensibilità	4
Strumenti per operazioni della prostata	423
Strumenti per ostetricia	481, 486
Strumenti per scanalare per trapiantare, Bypass	517
Strumenti per sutura	378
Strumenti per tracheotomia	728
Strumenti, Cassette	746
Strumenti, Detergente PREP LUBE	733
Strumenti, Vassoi porta	748
Strumento biopsia per truciolli dell'iliaco	669
Strumento guida e per scanalare	646
Strumento per circoncisione	426
Strumento per introdurre cateteri o sonde	425
Strumento per ureterografia	426
SUBRAMANIAN ATRAUMATIC-GRIP Pinze per aorta	537
Succhielli per fibroma	458
Succhiello unghie	645
SULLIVAN (BROPHY) Forbici fine per dissezione	93
SUPER Combinazione stetoscopica	5
Supporto-mano	644
Supporto porta-graffe	690-691
Sutura intestinale, Aghi	354
Sutura vascolare, Aghi	354
Sutura, Aghi chirurgici	354-356
Sutura, Apparecchiatura per gastro-intestinale	404
Sutura, Forchetta	378
Sutura, Punzone	694
Sutura, Set	380
Sutura, Strumenti	378
Suture	353
SWEET-LAHEY Pinza per preparazioni e legature	189
SYSTRUNK Forbici per fissurare le unghie	81

T

Tagli cesarei, Pinza emostatica	481
Taglia/curva, Tenaglie	666
Taglienti, Curette	606
Taglio cesarei, Forcipi	480
Taglio cesareo, Elevatore per testa	481
Taglio di lima, Taglio di raspa	595
TAKAHASHI Pinze per laminectomia	714
Tamponi e medicatura, Pinze	204-207
Tamponi e spugne, Pinze	209-210
Tangenziale occlusione, Pinze ATRAUMATIC-GRIP	562
Targhette di identificazione colorate	743
Targhette, Porta	743
TARNIER Forcipi	480
Tavola operatoria, Autofissatori per retrattori	704
TAYLOR-CUSHING Pinza anatomica per dissezione, fine	131
TAYLOR-CUSHING Pinza fine per chirurgia	143
TAYLOR-CUSHING Pinze auricolari e nasali	136
TAYLOR-CUSHING TITE GRIP Pinze anatomiche per dissezione	114
TAYLOR Martelli percussori	2
TAYLOR Valvola laterale per divaricatori	287
TEALE Pinze per abbassare il collo dell'utero	456
Telai per sterilizzazione	737
Telai per trattenere gli strumenti	736
Telaio	736
Telaio di supporto per il fissaggio alla barra laterale del tavolo operatorio	309
Telaio per sterilizzare aghi per sutura	736
Telaio per sterilizzazione per micro-strumenti	737
Tenaglie curva/taglia	666
Tenaglie per ossa	624-630
Tenaglie tagliafili	666
Tenaglie tagliafili DURACUT	667
Tendine, Enuclatore	646
Tendine, Guida	646
Tendine, Pinze ferma	648
Tendine, Pinze passa	649
Tendine, Pinze per la presa	647
Tendinea, Guaina, Dovaricatori	225
Tendini, Pinza per allacciare	649
Tenotomia e dissezione, Forbici fine	92
Tenotomo	37

Tessuti e aghi, Pinze TITE GRIP	116
Tessuti e intestino, Pinza da presa	383-389
Tessuti e intestino, Pinza da presa ATRAUMATIC-GRIP	389
Tessuti e intestino, Pinza da presa TITE GRIP	388
Tessuti e pelle, Uncino doppio per afferrare e sollevare	212
Tessuti e tumori, Pinze per afferrare	126-127
Tessuti molli, Divaricatori	241
Tessuti, Micro-pinze	124
Tessuti, Micro-pinze in TITANIO	124
Tessuti, Pinze per afferrare	149
Tessuto campione, Otturatore smusso per espellere	721
Tessuto molle, Retrattore doppio per estrarre	721
Tessuto molle, Trapano	721
Testa accoppiamento	705
TEYLOR-SCHMIEDEN Forbici per dura-madre	100
THOMAS-PRICE Pinze per legature	566
THOMS-ALLIS Pinza da presa per intestino e tessuti	385
THOMS-GAYLOR Pinza per la biopsia cervicale e da prelievo	460
THOREK-METZENBAUM DURACUT Forbici adnex	54
THOREK Forbici per dissezione	98
THORLAKSON ATRAUMATIC-GRIP Pinza-clamp per occlusione superiore del retto	398-399
THORLAKSON Divaricatori per pelvis	256-257
THORLAKSON Divaricatori, doppi	230
Tiracomedoni	19
Tiralingua, Pinze	23
Tiravene per endarterectomia	514
Tiroide, Divaricatore	243
TISCHLER-BABY Pinza per la biopsia cervicale e da prelievo	464
TISCHLER-MORGAN Pinza per la biopsia cervicale e da prelievo	464
TISCHLER Pinza per la biopsia cervicale e da prelievo	465
TITAN-LINE KELLY Pinze emostatiche fini	168
TITAN-LINE Pinze Bulldog in Titanio	160-161
TITAN-LINE Pinze emostatiche fini	166, 168
TITAN-LINE Pinze metti-rimuovi clamps Bulldog	160
TITAN-LINE Portaghi	365
TITANIO Micro-pinze per afferrare tessuti	124
TITANIO Micro-pinze per legature	123
TITANIO Micro portaghi	362
TITE GRIP Micro-Pinze	118
TITE GRIP Micro-Portaghi	338-339
TITE GRIP Pinza da presa per intestino e tessuti	388
TITE GRIP Pinze	118
TITE GRIP Pinze anatomiche per dissezione	112-115
TITE GRIP Pinze gira cavo	662
TITE GRIP Pinze per dissezione con denti	117
TITE GRIP Pinze per tessuti e per aghi	116
TITE GRIP Pinze porta cavo	663
TITE GRIP Portaghi	340-350
TITE GRIP Raspe	596-597
TOENNIS-ADSON DURACUT Forbici per dissezione	49
TOENNIS-ADSON Forbici per dissezione	89
TOENNIS-OLIVECRONA (SCOVILLE) Pinza metti graffe	690
TOENNIS Dissettori per la dura-madre	700
TOENNIS Forbici per chirurgia e per dissezione	83
TOENNIS Portaghi	371
TOENNIS TITE GRIP Portaghi	350
Togliere le graffe emostatiche al cuoio capelluto, Pinza	691
TOHOKU Pinze per fissare le compresse	202
TÖNNIS Coltello per dura-madre	37
Tonsille e emostatiche, Pinze	179
Tonsille, Ago	328
Tonsille, Forbici	103
Torace e legature, Pinze	564
Torace, Divaricatori	507
Tourniquets	518
TOWNSEND Pinza per la biopsia cervicale e da prelievo	465
Trachea, Divaricatore	226
Tracheali, Cannule	725-727
Tracheali, Uncini	217, 219-220
Tracheotomia, Dilatatore	728
Tracheotomia, Set	729-730
Tracheotomia, Strumenti	728
Tracheotomia, Tre quarti	728
Tracheotomia, Uncino	728
Transformatore, regolabile da 0-5 v.	472
Transsfenoidale ipofisectomia, Speculo	692
Trapanazione della cute, Strumentario	20
Trapani dermatici	20

Trapani, Manico per meccanismo sferico di sgancio per inserire ed estrarre	721
Trapano a mano per ossa	651-653
Trapano per osso	721
Trapano per tessuto molle	721
Trapiantare, Scanalare, Bypass, Strumenti	517
Trasformatore-Mini elettrico	11
Trazione, Archi	654, 658-659
Trazione, Manico	479
TRELAT Periostotomo	582
TRELAT Speculi vaginali	431
Trenditore serra filo	660
Trequarti	318
Trequarti per empiema	318
Trequarti per idrocele e puntura addominale	318
Trequarti per puntura del seno mascellare	319-320
Trequarti per tracheotomia	728
Trequarti per vescica biliare	318
Trequarti semi smusso	721
Triangolari, Bacinelle	750
Trigemino, Forbici	100
Trocar, Cannula	721
TROELTSCH (WILDE) Pinze auricolari e nasali	137
TROELTSCH Pinze auricolari e nasali	137
TROEMNER Martelli percussori	3
Tronchesine per la cuticola	17
Tronchesine per unghie	17
TROUSSEAU Dilatatore per tracheotomia	728
TROUTMAN-BARRAQUER Micro portaghi	360
TROUTMAN Pinza per afferrare e rompere le lamette da rasoio	36
Trucoli dell'iliaco, Strumento biopsia	669
TUBBS Dilatatori per l'aorta	511
Tubercolina, Siringhe	330
Tubi aspirazione	324-327
Tubi e cateteri, Pinza guida con manico a milla	473
Tubi, Pinze	203
Tubo aspirazione intracardiaca	327
Tubo aspirazione vascolare	327
Tubo per aspirazione nasale	324
Tubo per ischemia	570
Tubo per scanalare con manico	517
Tubo per scanalare, Pinza	517
TUFFIER Divaricatori costali	506
TUFFIER Spatola addominale e intestinale	267
Tumori e tessuti, Pinze per afferrare	126-127
Tumori e vascolari, Pinze	149
TUOHY Aghi per punture lombari	328
TUTTLE (SINGLEY) Pinze per dissezione del polmone	149
TYRELL GRAEFE Divaricatori cutaneo	216

U

UCKERMANN Portacotone	317
UECKERMANN-DENKER Trequarti per tracheotomia	728
UFFENORDE Curette per ossa	601
ULRICH Bisturi per fistole	37
ULRICH Pinze per medicatura e tamponi	206
ULRICH Tenaglie per ossa	627
Uncini	449
Uncini auricolare	213
Uncini per dura-madre	212
Uncini per fistole	221
Uncini per microchirurgia	212-213
Uncini per narici posteriori	221
Uncini per nervi e vasi	213-215
Uncini per strabismo	213
Uncini tracheali	217, 219-220
Uncino	696
Uncino cutaneo	217
Uncino doppio per afferrare e sollevare pelle e tessuti	212
Uncino per chirurgia plastica	217-219
Uncino per chirurgia plastica, acuti	219
Uncino per detroncazione	485
Uncino per dura-madre	217-218
Uncino per pelle e dura-madre	217
Uncino tracheale	728
Uncino, Bulbo	422
Unghie, Forbici	16

Unghie, Forbici per fissurare	81
Unghie, Lime	18
Unghie, Pinza	645
Unghie, Pinza per estrazione	645
Unghie, Spazzola	752
Unghie, Succhiello	645
Unghie, Tronchesine	17
UNIVERSAL DURACUT Forbici taglia cavo	665
UNIVERSAL Forbici taglia cavo	665
UNIVERSAL Trequarti	318
Universali, Bacinelle	748
UNNA-VIDAL Tiracomedoni	19
UNNA Tiracomedoni	19
Ureterografia, Strumento	426
Uretra e cervice, Endospeculi	443, 448
Urologia, Strumenti	425-426
US-ARMY (PARKER-LANGENBECK) Divaricatori	231
USA MOD. Apri gesso	682
USA MOD. Curette per ossa	601
USA MOD. Forbici ombelicali	108
USA MOD. Pinze anatomiche per dissezione	133
USA MOD. Pinze per chirurgia	145
Uterina-intra, Pinza	447
Uterine, Curette	466-470
Uterine, Forbici DURACUT	60
Uterini, Depressori	447
Uterini, Dilatatori	443-445
Uterino, Porta garza	447
Utero, Forbici	104-106
Utero, Pinze per afferrare	458

V

Vaginali, Speculi	430-442
Vaginali, Speculi e valve	434-437, 439
VALLEIX Isterometri	446
Valva centrale per divaricatori addominali	303
Valve	293
Valve e speculi vaginali	434-437, 439
Valve in NYLON per divaricatori addominali	308
Valve laterali	289
Valve laterali per divaricatori addominali	303
Valve laterali per divaricatori SCOVILLE	287
Valve laterali per divaricatori TAYLOR	287
Valve per divaricatori addominali KIRSCHNER	307
VAN BUREN Pinza per frammento osseo	623
VAN DOREN Pinza per la biopsia cervicale e da prelievo	461
VANNAS-YASARGIL Micro-forbici	66
VANNAS Micro-forbici	62-64
VARCO Pinza emostatica fine	170
Varici, Astuccio	315
Vascolare e fistole, Forbici DURACUT	45
Vascolare, Aghi per sutura	354
Vascolare, Tubo aspirazione	327
Vascolari e tumori, Pinze	149
Vascolari, Clips	154-156
Vascolari, Divaricatori	510
Vascolari, Forbici	95
Vascolari, Forbici DURACUT	56-57
Vascolari, Pinze ATRAUMATIC-GRIP	135, 520
Vascolari, Pinze con dentatura COOLEY	555-556, 558, 561-562
Vascolari, Pinze con dentatura DE BAKEY	529-530, 534, 537
Vascolari, Pinze con dentatura LAWTON	521-523
Vascolari, Pinze per occlusione tangenziale ATRAUMATIC-GRIP	541
Vascolari, Pinze semi flessibili	563
VASCULAP-RYDER TITE GRIP Portaghi	340
VASCULAR Portaghi	364
VASCULAR TITAN-LINE Portaghi	365
Vascolari, Aghi per irrigazione	322
Vase periferici, Pinza ATRAUMATIC-GRIP	558
Vasi e nervi, Uncini	213-215
Vasi periferici, Pinze ATRAUMATIC-GRIP	534-536
Vasi, Bisturi	694-695
Vassoi porta strumenti	748
Vena cava, Forbici	99
Vena cava, Pinze con dentatura DE BAKEY ATRAUMATIC-GRIP	550
Vena, Sonde	315
Vene, Divaricatori	217, 222-223

Vene, Forbici	63
Veni e hilus, Divaricatori	223
Ventricolari, Pinze	564
VERBRUGGE-MÜLLER Leve per ossa	579
VERBRUGGE Tenaglie per ossa	628
VERESS Aghi per il pneumo-peritoneo	329
VERNET-GIL MARBERGER Divaricatori per veni e hilus	223
Vertebre, Separatori	296
Vescica biliara, Tre quarti	318
Vescica e ferite, Siringhe	331
Vescicale, Divaricatore	310
Vesicali, Spatole	268
Vestiti e bendaggi, Cesioie	674
Vestiti e gessi, Cesioie	675
VICKERS Distributore multiplo per punte filiformi	657
VICKERS Divaricatore per dita	271
VICKERS Divaricatore per la mano	271
VICKERS Divaricatore per la mano e l'avambraccio	271
VICKERS Impugnatura a molla per dita e piccolo divaricatore per ferite	271
VICKERS Supporto-mano	644
VIDAL-UNNA Tiracomedoni	19
VIDAL Cucchiaino per lupus	19
VIRCHOW Coltello per il cervello	40
VIRTUS (RALKS) Pinza per schegge	151
WISE Micro-Pinze per legature	122
Vite guida, per dischi di fissaggio	659
VOGEL Tre quarti per puntura del seno mascellare	319
VOLKMANN Curette per ossa	600, 602
VOLKMANN Curette taglienti	606
VOLKMANN Divaricatori	232-234
Vulva, Divaricatori	281

W

WAGNER Leve per ossa	577
WAGNER Martello	620
WAGNER Periostotomi	591
WAGNER Uncini auricolare	213
WALB Coltello per autopsia	40
WALDMANN Forbici per perineo	107
WALTON-LISTON (BÖHLER) Cesioie per ossa	638
WANGENSTEEN Pinze anatomiche per dissezione	115
WANGENSTEEN Portaghi	369
WANGENSTEEN TITE GRIP Portaghi	347
WARTENBERG Algesiometro	4
WATSON-CHEYNE Dissettori	574
WATSON-WILLIAMS Raspa	593
WAUGH Pinza anatomica per dissezione, fine	131
WAUGH Pinze fini per chirurgia	143
WEBER ATRAUMATIC-GRIP Pinze per l'anastomosi dell'aorta con dentatura DE BAKEY	548
WEBER Estensiometro	4
WEBSTER Portaghi	363
WEBSTER TITE GRIP Portaghi	342
WEIL-BLAKESLEY Pinze per laminectomia	714
WEISSBARTH Speculo vaginale	442
WEITLANER Divaricatori autostatici	272-274
WELLS-SPENCER Pinze emostatiche	173
WERTHEIM-CULLEN Pinze per peduncoli renali	191
WERTHEIM-DE BAKEY (ROGERS) ATRAUMATIC-GRIP Pinze-clamps per parametrio	197
WERTHEIM (BOZEMANN) TITE GRIP Portaghi	346
WERTHEIM Forbici da utero	105
WERTHEIM Pinze per isterectomia	194-195
WEST Scalpelli	607
WEST Sgorbie	607
WIENER MOD. Portalegature	378
WIENER Raspe	593
WILDE (TROELTSCH) Pinze auricolari e nasali, angolate	137
WILLETT Pinza per il cuoio capelluto	481
WILLIAMS-WATSON Raspa	593
WILLIAMS (STIEGLITZ) Pinze per schegge	151
WILLIAMS Pinze da presa per intestino e tessuti	388
WILLIGER Curette per ossa	598, 600
WILLIGER Elevatori	574
WILLIGER Martello	617
WILLIGER Periostotomo	582
WINTER Pinza per placenta e per ovaie	482

WINTER Stetoscopio	5
WITNER Pinza per la biopsia cervicale e da prelievo	462
WOLFF Rompi gesso	682
WOLFSON-DE MARTEL Pinze per anastomosi del colon	402
WOLFSON-DE MARTEL Portapinze	402
WOLFSON-DE MARTEL Serrapinze	402
WOOD-CRILE Portaghi	366, 368
WOOD-CRILE TITE GRIP Portaghi	341, 343
WRIGLEY Forcipi per tagli cesarei	480
WULLSTEIN Cannula per aspirazione	322
WULLSTEIN Divaricatori autostatici	275
WULLSTEIN Micro-tubo per aspirazione	321
WYLLIE ATRAUMATIC-GRIP Pinze per l'anastomosi dell'aorta con dentatura DE BAKEY	549

Y

YANKAUER Tubi aspirazione	325-326
YASARGIL-MINI Applicatori per clips vascolari	154
YASARGIL-MINI Clips vascolari	154
YASARGIL-SAMII Pinze per afferare tessuti e tumori, a baionetta	126
YASARGIL-STANDARD Applicatori per clips vascolari	154
YASARGIL-STANDARD Clips vascolari	154
YASARGIL-VANNAS Micro-forbici	66
YASARGIL Curetta tagliente	695
YASARGIL Dissettore	694
YASARGIL Ganci galea	691
YASARGIL Guida per legatura, bottonuta	697
YASARGIL Micro-forbici	66-67
YASARGIL Micro-pinze con manici a baionetta	125
YASARGIL Micro portaghi	362
YASARGIL Periostotomi	694-695
YASARGIL Pinza ipofisaria	719
YASARGIL Pinze per afferare tessuti e tumori, a baionetta	126
YASARGIL Tubi aspirazione	324
YEOMAN Pinze taglienti per biopsia rettale	412
YOUNG-HRYNTSCHAK Portaghi a boomerang con 1 ago	372
YOUNG-MILLIN Portaghi a boomerang	372
YOUNG Bulbo ad uncino	422
YOUNG Pinze tiralingua	23
YOUNG Retrattori prostatici	422
YOUNGE-KEVOURKIAN Curette per la biopsia endo-cervicale	459
YOUNGE-KEVOURKIAN Pinza per la biopsia cervicale e da prelievo	463, 465

Z

ZAUFAL-JANSEN Pinza per ossa	633
ZENKER Divaricatori per interventi in profondità	259
ZENKER Pinze per preparazioni e legature	188
ZIEGLER Fascia frontale	10
ZIEGLER Specchio frontale	10
ZIELKE Sgorbie	614
ZOELLNER Micro-tubo per aspirazione	321
ZWEIFEL TITE GRIP Portaghi	349

Nummernverzeichnis

Index of Numbers

Indice de números de referencias

Index des numéros de références

Indice dei codici

Kat. -Nr.	Seite	Kat. -Nr.	Seite	Kat. -Nr.	Seite	Kat. -Nr.	Seite
Cat. No.	Page	Cat. No.	Page	Cat. No.	Page	Cat. No.	Page
Núm. Ref.	Página	Núm. Ref.	Página	Núm. Ref.	Page	Núm. Ref.	Página
No. Réf.	Page	No. Réf.	Page	No. Réf.	Page	No. Réf.	Page
No. Cat.	Página	No. Cat.	Página	No. Cat.	Página	No. Cat.	Página
04		05-0030	63	05-0167	80	05-0340	92
04-0500	733	05-0031	63	05-0173	108	05-0341	92
04-0502	733	05-0034	64	05-0174	108	05-0364	95
04-0504	733	05-0035	64	05-0177	80	05-0366	95
04-0506	733	05-0038	64	05-0185	77	05-0400	86
04-0508	733	05-0039	64	05-0186	77	05-0401	86
04-1010	34	05-0050	65	05-0188	77	05-0416	87
04-1011	34	05-0051	65	05-0197	81	05-0417	87
04-1012	34	05-0060	65	05-0198	81	05-0420	87
04-1013	34	05-0061	65	05-0200	78	05-0421	87
04-1015	34	05-0062	65	05-0201	78	05-0431	105
04-1018	35	05-0063	65	05-0202	78	05-0433	105
04-1020	35	05-0093	65	05-0203	78	05-0435	98
04-1021	35	05-0095	65	05-0204	79	05-0440	94
04-1022	35	05-0097	65	05-0205	79	05-0441	94
04-1023	35	05-0099	65	05-0210	78	05-0443	94
04-1024	35	05-0100	72	05-0211	78	05-0445	94
04-1025	35	05-0101	72	05-0212	78	05-0450	84
04-1050	34	05-0102	72	05-0213	78	05-0451	84
04-1051	34	05-0103	72	05-0214	79	05-0452	84
04-1055	35	05-0104	72	05-0215	79	05-0453	84
04-1056	35	05-0105	73	05-0220	71	05-0460	84
04-1057	34	05-0106	73	05-0221	71	05-0461	84
04-1058	34	05-0107	73	05-0222	71	05-0464	84
04-1059	34	05-0108	73	05-0223	71	05-0465	84
04-1112	34	05-0109	73	05-0224	71	05-0470	86
04-1136	35	05-0110	74	05-0225	71	05-0471	86
04-1225	37	05-0111	74	05-0230	79	05-0482	85
04-1228	37	05-0112	74	05-0231	79	05-0483	85
04-1250	37	05-0113	74	05-0234	70	05-0490	85
04-1252	37	05-0114	74	05-0235	70	05-0491	85
04-1260	37	05-0115	75	05-0236	70	05-0492	85
04-1270	37	05-0116	75	05-0237	70	05-0493	85
04-1352	40	05-0117	75	05-0240	80	05-0495	85
04-1355	40	05-0118	75	05-0241	80	05-0499	98
04-1356	40	05-0119	75	05-0250	78	05-0541	83
04-1357	40	05-0120	76	05-0251	78	05-0543	83
04-1360	40	05-0121	76	05-0252	78	05-0549	81
04-1361	40	05-0122	76	05-0253	78	05-0550	87
04-1362	40	05-0123	76	05-0254	79	05-0551	87
04-1385	41	05-0124	76	05-0255	79	05-0554	88
04-1390	41	05-0125	77	05-0308	69	05-0555	88
04-1391	41	05-0126	77	05-0309	69	05-0560	89
04-1392	41	05-0127	77	05-0310	69	05-0561	89
04-1395	42	05-0128	77	05-0311	69	05-0567	93
04-1396	42	05-0129	77	05-0314	69	05-0572	83
04-5800	674	05-0135	74	05-0315	69	05-0573	83
04-5810	674	05-0136	74	05-0320	69	05-0575	89
		05-0138	74	05-0321	69	05-0585	83
05		05-0145	75	05-0322	69	05-0587	83
05-0020	63	05-0146	75	05-0323	69	05-0591	93
05-0021	63	05-0148	75	05-0324	69	05-0593	93
05-0023	63	05-0155	76	05-0325	69	05-0595	93
05-0026	63	05-0156	76	05-0326	69	05-0601	93
05-0027	63	05-0158	76	05-0330	68	05-0603	93
05-0028	63	05-0166	80	05-0331	68	05-0607	89

Kat. -Nr.	Seite	Kat. -Nr.	Seite	Kat. -Nr.	Seite	Kat. -Nr.	Seite
Cat. No.	Page	Cat. No.	Page	Cat. No.	Page	Cat. No.	Page
Núm. Ref.	Página	Núm. Ref.	Página	Núm. Ref.	Página	Núm. Ref.	Página
No. Réf.	Page	No. Réf.	Page	No. Réf.	Page	No. Réf.	Page
No. Cat.	Pagina	No. Cat.	Pagina	No. Cat.	Pagina	No. Cat.	Pagina
05-0608	89	05-1466	49	05-2000	50	06-0031	163
05-0609	89	05-1470	55	05-2001	50	06-0032	163
05-0610	89	05-1471	55	05-2002	50	06-0033	163
05-0619	90	05-1472	55	05-2003	50	06-0035	527
05-0620	90	05-1473	55	05-2004	50	06-0050	164
05-0621	90	05-1474	55	05-2005	50	06-0051	164
05-0622	90	05-1476	55	05-2006	50	06-0054	164
05-0640	90	05-1477	55	05-2007	50	06-0055	164
05-0641	90	05-1481	45	05-2010	51	06-0064	162
05-0642	91	05-1480	45	05-2011	52	06-0065	162
05-0643	91	05-1491	49	05-2012	51	06-0066	162
05-0644	91	05-1500	46	05-2013	52	06-0067	162
05-0645	91	05-1501	46	05-2020	51	06-0068	162
05-0655	98	05-1502	46	05-2021	52	06-0069	162
05-0657	98	05-1503	46	05-2022	51	06-0070	162
05-0660	90	05-1504	46	05-2023	52	06-0071	162
05-0661	90	05-1505	46	05-2040	51	06-0072	162
05-0662	90	05-1550	47	05-2041	52	06-0075	162
05-0663	90	05-1551	47	05-2042	51	06-0076	162
05-0664	90	05-1552	353	05-2043	52	06-0077	162
05-0665	90	05-1553	353	05-2060	51	06-0082	526
05-0740	104	05-1554	353	05-2061	52	06-0083	526
05-0741	104	05-1555	48	05-2062	51	06-0084	526
05-0742	104	05-1556	48	05-2063	52	06-0085	526
05-0743	104	05-1560	47	05-2064	54	06-0086	526
05-0744	105	05-1561	47	05-2066	54	06-0087	526
05-0745	105	05-1565	48	05-2068	54	06-0090	164
05-0752	104	05-1566	48	05-2072	53	06-0091	164
05-0753	104	05-1570	47	05-2073	53	06-0094	164
05-0754	105	05-1571	47	05-2074	53	06-0095	164
05-0755	105	05-1579	49	05-2075	53	06-0100	164
05-0770	106	05-1580	48	05-2076	53	06-0101	164
05-0773	106	05-1581	48	05-2077	53	06-0110	151
05-0780	106	05-1582	48	05-2082	53	06-0120	164
05-0781	106	05-1583	48	05-2083	53	06-0121	164
05-0785	80	05-1584	49	05-2084	53	06-0122	165
05-0802	672	05-1585	49	05-2085	53	06-0123	165
05-0804	672	05-1600	59			06-0136	165
05-0806	672	05-1621	60	06		06-0137	165
05-0820	673	05-1630	60	06-0010	163	06-0138	165
05-0830	673	05-1631	60	06-0011	163	06-0139	165
05-0835	673	05-1650	60	06-0012	163	06-0140	154
05-0850	673	05-1652	60	06-0013	163	06-0141	154
05-0860	673	05-1656	54	06-0014	163	06-0142	154
05-0864	675	05-1657	54	06-0015	163	06-0143	154
05-0895	673	05-1658	54	06-0020	163	06-0145	154
05-0950	675	05-1660	58	06-0021	163	06-0146	154
05-0952	675	05-1662	58	06-0022	163	06-0147	154
05-0970	676	05-1664	58	06-0023	163	06-0148	154
05-0975	676	05-1666	58	06-0024	163	06-0155	165
05-1450	45	05-1668	59	06-0025	163	06-0156	165
05-1455	45	05-1670	59	06-0026	163	06-0157	165
05-1459	45	05-1680	60	06-0027	163	06-0158	165
05-1460	45	05-1810	665	06-0028	163	06-0170	168
05-1461	45	05-1850	673	06-0029	163	06-0171	168
05-1465	49	05-1970	676	06-0030	163	06-0180	154

Nummernverzeichnis

Index of Numbers

Índice de números de referencias

Index des numéros de références

Indice dei codici

LAWTON
Medizintechnik

Kat. -Nr.	Seite	Kat. -Nr.	Seite	Kat. -Nr.	Seite	Kat. -Nr.	Seite
Cat. No.	Page	Cat. No.	Page	Cat. No.	Page	Cat. No.	Page
Núm. Ref.	Página	Núm. Ref.	Página	Núm. Ref.	Página	Núm. Ref.	Página
No. Réf.	Page	No. Réf.	Page	No. Réf.	Page	No. Réf.	Page
No. Cat.	Pagina	No. Cat.	Pagina	No. Cat.	Pagina	No. Cat.	Pagina
06-0181	154	06-0285	172	06-0410	177	06-0685	173
06-0182	154	06-0286	172	06-0411	177	06-0700	180
06-0183	154	06-0287	172	06-0412	177	06-0701	180
06-0184	154	06-0291	187	06-0413	177	06-0702	180
06-0185	154	06-0294	187	06-0414	177	06-0703	180
06-0190	154	06-0297	187	06-0416	177	06-0705	183
06-0191	154	06-0299	175	06-0420	176	06-0706	180
06-0192	154	06-0300	175	06-0421	176	06-0707	180
06-0193	154	06-0301	175	06-0422	176	06-0709	182
06-0200	168	06-0302	175	06-0423	529	06-0710	182
06-0201	168	06-0303	175	06-0425	176	06-0711	182
06-0203	165	06-0304	175	06-0426	176	06-0712	182
06-0204	165	06-0305	175	06-0427	176	06-0713	170
06-0206	168	06-0306	175	06-0428	529	06-0715	182
06-0207	168	06-0308	175	06-0433	529	06-0716	183
06-0210	166	06-0309	175	06-0434	529	06-0717	189
06-0211	166	06-0310	175	06-0435	529	06-0718	189
06-0212	166	06-0311	175	06-0436	529	06-0719	188
06-0213	166	06-0312	175	06-0450	167	06-0720	189
06-0214	166	06-0313	175	06-0451	167	06-0721	182
06-0215	166	06-0314	175	06-0458	176	06-0723	189
06-0216	176	06-0315	175	06-0459	176	06-0725	189
06-0217	176	06-0316	175	06-0460	176	06-0730	179
06-0218	166	06-0318	175	06-0461	176	06-0731	179
06-0219	166	06-0320	174	06-0470	156	06-0732	179
06-0220	167	06-0321	174	06-0470	158	06-0733	179
06-0221	167	06-0322	174	06-0471	156	06-0740	184
06-0222	167	06-0323	174	06-0471	158	06-0741	184
06-0223	167	06-0326	174	06-0475	156	06-0742	184
06-0224	167	06-0327	174	06-0476	156	06-0743	184
06-0225	167	06-0335	178	06-0477	156	06-0744	184
06-0230	169	06-0336	178	06-0480	157	06-0745	184
06-0231	169	06-0342	173	06-0481	157	06-0746	184
06-0240	169	06-0343	173	06-0482	157	06-0761	188
06-0241	169	06-0344	173	06-0483	157	06-0762	188
06-0242	171	06-0345	173	06-0484	157	06-0763	181
06-0243	171	06-0346	173	06-0485	158	06-0764	181
06-0244	169	06-0347	173	06-0486	158	06-0765	181
06-0245	169	06-0348	173	06-0487	158	06-0766	181
06-0250	169	06-0349	173	06-0488	158	06-0767	181
06-0251	169	06-0350	178	06-0489	159	06-0768	181
06-0260	170	06-0352	178	06-0490	159	06-0769	181
06-0261	170	06-0353	173	06-0491	159	06-0770	181
06-0263	170	06-0354	173	06-0492	159	06-0771	181
06-0264	170	06-0360	178	06-0493	159	06-0772	181
06-0265	170	06-0362	178	06-0494	159	06-0773	181
06-0270	171	06-0370	178	06-0500	169	06-0800	183
06-0271	171	06-0371	178	06-0501	169	06-0801	183
06-0275	171	06-0377	178	06-0510	390	06-0802	183
06-0276	170	06-0379	178	06-0511	390	06-0803	183
06-0277	170	06-0400	177	06-0520	390	06-0804	183
06-0280	172	06-0401	177	06-0521	390	06-0805	183
06-0281	172	06-0402	177	06-0620	387	06-0806	183
06-0282	172	06-0403	177	06-0680	173	06-0807	183
06-0283	172	06-0404	177	06-0682	173	06-0820	184
06-0284	172	06-0406	177	06-0684	173	06-0821	184

Kat. -Nr. Seite
Cat. No. Page
Núm. Ref. Página
No. Réf. Page
No. Cat. Pagina

06-0822 184
06-0823 184
06-0824 184
06-0825 184
06-0826 184
06-0830 185
06-0831 185
06-0832 185
06-0833 185
06-0834 185
06-0835 185
06-0836 185
06-0837 185
06-0838 185
06-1100 164
06-1101 164
06-1120 164
06-1121 164
06-1200 168
06-1201 168
06-1210 166
06-1211 166

07

07-0017 203
07-0018 203
07-0019 203
07-0020 203
07-0021 203
07-0022 203
07-0029 203
07-0030 203
07-0100 201
07-0102 201
07-0103 200
07-0105 201
07-0106 201
07-0108 201
07-0109 201
07-0110 201
07-0111 200
07-0112 202
07-0113 202
07-0114 202
07-0120 202
07-0122 203
07-0126 202
07-0127 202
07-0130 200
07-0131 200
07-0135 200
07-0138 200
07-0139 200
07-0140 200
07-0143 200
07-0150 209

Kat. -Nr. Seite
Cat. No. Page
Núm. Ref. Página
No. Réf. Page
No. Cat. Pagina

07-0151 209
07-0155 209
07-0156 209
07-0160 209
07-0161 209
07-0165 209
07-0166 209
07-0167 210
07-0168 210
07-0170 210
07-0208 204
07-0209 204
07-0212 205
07-0213 205
07-0214 205
07-0215 205
07-0216 206
07-0217 206
07-0218 206
07-0219 206
07-0221 204
07-0222 204
07-0226 204
07-0227 204
07-0230 204
07-0231 204
07-0236 205
07-0237 205
07-0243 207
07-0245 207
07-0248 207
07-0260 734
07-0261 734
07-0265 734
07-0270 734
07-0282 734
07-0288 734
07-0295 736
07-0296 736
07-0297 736
07-0300 735
07-0302 735
07-0303 735
07-0304 735
07-0306 735
07-0307 735
07-0308 735
07-0350 736
07-0352 736
07-0400 736
07-0401 736
07-0607 739
07-0609 739
07-0613 739
07-0614 739
07-0618 739
07-0619 739

Kat. -Nr. Seite
Cat. No. Page
Núm. Ref. Página
No. Réf. Page
No. Cat. Pagina

07-0626 739
07-0627 739
07-0700 738
07-0701 738
07-0702 738
07-0703 720
07-0705 738
07-0706 738
07-0707 740
07-0709 740
07-0710 738
07-0711 738
07-0712 738
07-0713 740
07-0714 740
07-0715 738
07-0716 738
07-0718 740
07-0719 740
07-0726 740
07-0727 740
07-0728 738
07-0730 744
07-0732 744
07-0740 744
07-0747 744
07-0748 744
07-0765 745
07-0766 744
07-0767 744
07-0768 744
07-0769 745
07-0782 515
07-0786 744
07-0787 744
07-0788 744
07-0825 516
07-0826 516
07-0846 743
07-0847 743
07-0850 743
07-0851 743
07-0852 743
07-0853 743
07-0854 743
07-0855 743
07-0856 743
07-0857 743
07-0858 743
07-0860 743
07-0861 743
07-0871 738
07-0872 738
07-0873 738
07-0895 743
07-0897 743

Kat. -Nr. Seite
Cat. No. Page
Núm. Ref. Página
No. Réf. Page
No. Cat. Pagina

07-0899 743
07-0900 742
07-0902 742
07-0904 742
07-0906 742
07-0916 742
07-0930 750
07-0931 750
07-0932 750
07-0933 750
07-0936 750
07-0938 750
07-0942 750
07-0944 750
07-0952 751
07-0953 751
07-0954 751
07-0957 751
07-0958 751
07-0960 729
07-0962 730
07-0964 751
07-0965 751
07-0966 751
07-0967 751
07-0968 751
07-0990 751
07-0991 751
07-0992 751
07-1000 749
07-1001 749
07-1002 749
07-1003 749
07-1004 749
07-1010 749
07-1011 749
07-1012 749
07-1013 749
07-1015 749
07-1018 749
07-1019 749
07-1020 749
07-1021 749
07-1022 749
07-1023 749
07-1030 751
07-1031 751
07-1032 751
07-1034 751
07-1035 751
07-1036 751
07-1037 751
07-1038 751
07-1041 747
07-1042 747
07-1043 747

Nummernverzeichnis

Index of Numbers

Índice de números de referencias

Index des numéros de références

Indice dei codici

LAWTON
Medizintechnik

Kat. -Nr.	Seite	Kat. -Nr.	Seite	Kat. -Nr.	Seite	Kat. -Nr.	Seite
Cat. No.	Page	Cat. No.	Page	Cat. No.	Page	Cat. No.	Page
Núm. Ref.	Página	Núm. Ref.	Página	Núm. Ref.	Page	Núm. Ref.	Página
No. Réf.	Page	No. Réf.	Page	No. Réf.	Page	No. Réf.	Page
No. Cat.	Página	No. Cat.	Página	No. Cat.	Página	No. Cat.	Página
07-1044	747	07-1144	749	07-2020	756	08-0017	342
07-1045	747	07-1260	746	07-2022	756	08-0020	363
07-1046	747	07-1261	746	07-2024	756	08-0021	342
07-1047	747	07-1262	746	07-2026	756	08-0022	342
07-1050	747	07-1263	746	07-2028	756	08-0024	363
07-1051	747	07-1264	746	07-2030	756	08-0025	342
07-1054	747	07-1265	746	07-2032	756	08-0027	342
07-1055	747	07-1266	746	07-2034	756	08-0030	363
07-1056	747	07-1267	746	07-2036	756	08-0036	363
07-1057	747	07-1270	746	07-2038	756	08-0040	367
07-1058	747	07-1271	746	07-2100	754	08-0043	338
07-1059	747	07-1272	746	07-2102	754	08-0044	338
07-1061	747	07-1273	746	07-2104	755	08-0049	339
07-1066	737	07-1274	746	07-2106	755	08-0050	366
07-1067	737	07-1275	746	07-2108	755	08-0051	340
07-1071	747	07-1276	746	07-2110	755	08-0052	366
07-1072	747	07-1277	746	07-2112	755	08-0054	343
07-1073	747	07-1280	746	07-2114	755	08-0056	343
07-1074	747	07-1700	738	07-2116	755	08-0057	340
07-1075	747	07-1701	738	07-2118	755	08-0058	340
07-1076	747	07-1702	738	07-2120	755	08-0059	340
07-1077	747	07-1705	738	07-2122	754	08-0060	366
07-1078	747	07-1706	738	07-2124	754	08-0062	366
07-1081	747	07-1710	738	07-2126	754	08-0064	366
07-1082	747	07-1711	738	07-2128	754	08-0065	343
07-1083	747	07-1712	738	07-2130	755	08-0066	343
07-1084	747	07-1715	738	07-2132	755	08-0068	343
07-1085	747	07-1716	738	07-2134	755	08-0071	368
07-1086	747	07-1728	738	07-2150	757	08-0072	343
07-1087	747	07-1846	743	07-2151	757	08-0073	344
07-1088	747	07-1847	743	07-2152	757	08-0074	344
07-1100	748	07-1850	743	07-2153	757	08-0075	368
07-1101	748	07-1851	743	07-2154	757	08-0076	343
07-1102	748	07-1852	743	07-2156	757	08-0077	344
07-1103	748	07-1853	743	07-2707	741	08-0080	340
07-1104	748	07-1854	743	07-2709	741	08-0081	340
07-1105	748	07-1855	743	07-2713	741	08-0082	366
07-1106	748	07-1856	743	07-2714	741	08-0084	340
07-1110	748	07-1857	743	07-2718	741	08-0085	340
07-1111	748	07-1858	743	07-2719	741	08-0087	340
07-1112	748	07-1860	743	07-2726	741	08-0090	367
07-1113	748	07-1861	743	07-2727	741	08-0092	371
07-1114	748	07-1871	738			08-0096	338
07-1120	748	07-1872	738	08		08-0097	338
07-1130	749	07-1873	738	08-0001	339	08-0100	343
07-1131	749	07-2000	752	08-0002	339	08-0101	343
07-1132	749	07-2002	752	08-0003	339	08-0102	343
07-1133	749	07-2003	752	08-0004	339	08-0103	343
07-1134	749	07-2004	752	08-0005	339	08-0111	348
07-1135	749	07-2006	752	08-0010	363	08-0112	370
07-1136	749	07-2007	752	08-0011	342	08-0113	348
07-1137	749	07-2008	752	08-0012	342	08-0114	370
07-1140	749	07-2010	753	08-0013	342	08-0115	348
07-1141	749	07-2011	753	08-0014	366	08-0116	370
07-1142	749	07-2012	753	08-0015	342	08-0117	348
07-1143	749	07-2014	753	08-0016	363	08-0118	348

Kat. -Nr.	Seite	Kat. -Nr.	Seite	Kat. -Nr.	Seite	Kat. -Nr.	Seite
Cat. No.	Page	Cat. No.	Page	Cat. No.	Page	Cat. No.	Page
Núm. Ref.	Página	Núm. Ref.	Página	Núm. Ref.	Página	Núm. Ref.	Página
No. Réf.	Page	No. Réf.	Page	No. Réf.	Page	No. Réf.	Page
No. Cat.	Pagina	No. Cat.	Pagina	No. Cat.	Pagina	No. Cat.	Pagina
08-0119	348	08-0287	346	08-0600	379	08-1204	355
08-0124	349	08-0288	346	08-0605	379	08-1205	355
08-0127	349	08-0294	662	08-0610	379	08-1206	355
08-0128	349	08-0296	662	08-0611	379	08-1207	355
08-0129	349	08-0297	662	08-0612	379	08-1208	355
08-0132	348	08-0298	662	08-0614	379	08-1209	355
08-0136	349	08-0299	662	08-0616	379	08-1210	355
08-0144	348	08-0337	371	08-0618	379	08-1211	355
08-0145	349	08-0338	371	08-0620	379	08-1212	355
08-0147	349	08-0339	371	08-0622	379	08-1213	355
08-0151	350	08-0340	368	08-0650	379	08-1214	355
08-0152	350	08-0342	371	08-0652	379	08-1215	355
08-0155	350	08-0350	369	08-0772	378	08-1216	355
08-0156	350	08-0356	369	08-0775	378	08-1218	355
08-0157	350	08-0364	369	08-0800	665	08-1219	355
08-0158	344	08-0401	373	08-0801	665	08-1220	355
08-0159	344	08-0402	373	08-0804	665	08-1221	355
08-0160	344	08-0403	373	08-0805	665	08-1222	355
08-0162	350	08-0404	373	08-0810	665	08-1223	355
08-0163	350	08-0406	373	08-0840	352	08-1224	355
08-0173	344	08-0407	373	08-0844	352	08-1225	355
08-0175	344	08-0408	373	08-0845	352	08-1226	355
08-0176	370	08-0409	373	08-0846	352	08-1227	355
08-0177	370	08-0412	374	08-0847	352	08-1228	355
08-0179	345	08-0413	374	08-0848	352	08-1229	355
08-0180	367	08-0421	374	08-0850	352	08-1230	355
08-0181	345	08-0422	374	08-0851	352	08-1231	355
08-0182	367	08-0423	374	08-0875	352	08-1232	355
08-0183	345	08-0424	374	08-0888	666	08-1233	355
08-0184	367	08-0425	375	08-0890	666	08-1234	355
08-0185	345	08-0426	375	08-0910	380	08-1235	355
08-0186	345	08-0427	375	08-1020	364	08-1236	355
08-0187	345	08-0428	375	08-1022	364	08-1258	356
08-0188	345	08-0437	375	08-1024	364	08-1259	356
08-0189	345	08-0438	375	08-1026	364	08-1260	356
08-0190	349	08-0462	376	08-1028	364	08-1261	356
08-0195	345	08-0463	376	08-1030	365	08-1262	356
08-0196	345	08-0464	375	08-1032	365	08-1263	356
08-0197	345	08-0465	375	08-1034	365	08-1264	356
08-0198	345	08-0476	376	08-1036	365	08-1265	356
08-0208	367	08-0477	376	08-1038	365	08-1266	356
08-0210	367	08-0478	376	08-1131	356	08-1309	354
08-0221	340	08-0479	376	08-1132	356	08-1310	354
08-0223	340	08-0484	374	08-1133	356	08-1311	354
08-0225	340	08-0491	374	08-1134	356	08-1312	354
08-0227	340	08-0520	377	08-1135	356	08-1313	354
08-0230	346	08-0521	377	08-1136	356	08-1314	354
08-0231	346	08-0522	377	08-1137	356	08-1315	354
08-0232	346	08-0525	378	08-1138	356	08-1316	354
08-0241	347	08-0540	377	08-1139	356	08-1317	354
08-0245	347	08-0541	377	08-1198	355	08-1318	354
08-0247	344	08-0542	377	08-1199	355	08-1341	356
08-0255	346	08-0548	377	08-1200	355	08-1342	356
08-0257	346	08-0552	378	08-1201	355	08-1343	356
08-0261	347	08-0570	378	08-1202	355	08-1344	356
08-0263	347	08-0572	378	08-1203	355	08-1345	356

Nummernverzeichnis

Index of Numbers

Índice de números de referencias

Index des numéros de références

Indice dei codici

LAWTON
Medizintechnik

Kat. -Nr.	Seite	Kat. -Nr.	Seite	Kat. -Nr.	Seite	Kat. -Nr.	Seite
Cat. No.	Page	Cat. No.	Page	Cat. No.	Page	Cat. No.	Page
Núm. Ref.	Página	Núm. Ref.	Página	Núm. Ref.	Página	Núm. Ref.	Página
No. Réf.	Page	No. Réf.	Page	No. Réf.	Page	No. Réf.	Page
No. Cat.	Pagina	No. Cat.	Pagina	No. Cat.	Pagina	No. Cat.	Pagina
08-1346	356	09-0091	133	09-0204	144	09-0532	148
08-1410	354	09-0092	133	09-0205	144	09-0533	148
08-1411	354	09-0093	133	09-0216	146	09-0537	149
08-1412	354	09-0094	133	09-0221	146	09-0538	149
08-1413	354	09-0109	132	09-0226	146	09-0539	149
08-1414	354	09-0110	133	09-0231	146	09-0540	149
08-1415	354	09-0111	132	09-0232	121	09-0542	149
08-1489	354	09-0115	133	09-0236	146	09-0544	149
08-1490	354	09-0116	132	09-0239	131	09-0548	149
08-1491	354	09-0117	133	09-0241	146	09-0555	149
08-1492	354	09-0120	133	09-0261	146	09-0556	149
08-1493	354	09-0121	132	09-0266	146	09-0560	131
08-1509	354	09-0123	134	09-0276	146	09-0565	131
08-1510	354	09-0124	133	09-0277	146	09-0570	131
08-1511	354	09-0125	133	09-0280	134	09-0572	131
08-1512	354	09-0127	134	09-0284	131	09-0575	143
08-1513	354	09-0128	132	09-0285	131	09-0580	143
08-1632	380	09-0129	134	09-0286	143	09-0585	143
08-1641	357	09-0130	133	09-0287	143	09-0587	143
08-1643	357	09-0131	132	09-0351	148	09-0610	130
08-1644	357	09-0135	133	09-0370	129	09-0611	130
08-1650	357	09-0136	132	09-0371	140	09-0616	142
08-1651	357	09-0140	133	09-0375	129	09-0617	142
08-1659	357	09-0141	132	09-0376	129	09-0660	148
08-1660	357	09-0146	132	09-0377	129	09-0679	122
08-1662	357	09-0149	144	09-0378	129	09-0680	122
08-1665	353	09-0150	145	09-0380	140	09-0700	131
08-1669	353	09-0151	144	09-0383	140	09-0705	143
08-1670	353	09-0155	145	09-0385	140	09-0710	136
08-1671	353	09-0156	144	09-0390	141	09-0715	136
08-2011	341	09-0160	145	09-0391	141	09-0740	130
08-2065	341	09-0161	144	09-0395	129	09-0742	130
08-2068	341	09-0165	145	09-0396	140	09-0745	142
08-2181	341	09-0168	144	09-0397	141	09-0800	137
08-2183	341	09-0170	145	09-0398	141	09-0801	137
		09-0171	144	09-0399	141	09-0804	137
09		09-0175	145	09-0400	141	09-0806	137
09-0006	128	09-0176	144	09-0410	148	09-0808	137
09-0007	128	09-0180	145	09-0415	148	09-0809	137
09-0009	128	09-0181	144	09-0420	148	09-0812	136
09-0010	128	09-0186	144	09-0422	131	09-0814	136
09-0011	128	09-0188	132	09-0423	143	09-0815	136
09-0013	128	09-0189	132	09-0425	142	09-0818	136
09-0016	128	09-0190	132	09-0438	130	09-0819	136
09-0017	128	09-0191	134	09-0489	147	09-0830	150
09-0019	128	09-0192	132	09-0490	147	09-0832	150
09-0020	139	09-0193	144	09-0495	147	09-0870	151
09-0021	139	09-0194	145	09-0496	147	09-0871	151
09-0023	139	09-0195	144	09-0497	147	09-0901	121
09-0026	139	09-0196	144	09-0499	147	09-0902	121
09-0027	139	09-0197	145	09-0500	147	09-0903	121
09-0029	139	09-0198	144	09-0501	147	09-0920	150
09-0040	130	09-0200	132	09-0520	148	09-0921	150
09-0042	130	09-0201	132	09-0525	148	09-0922	150
09-0044	142	09-0202	132	09-0530	148	09-0923	150
09-0046	142	09-0203	132	09-0531	148	09-0924	150

Kat. -Nr.	Seite	Kat. -Nr.	Seite	Kat. -Nr.	Seite	Kat. -Nr.	Seite
Cat. No.	Page	Cat. No.	Page	Cat. No.	Page	Cat. No.	Page
Núm. Ref.	Página	Núm. Ref.	Página	Núm. Ref.	Página	Núm. Ref.	Página
No. Réf.	Page	No. Réf.	Page	No. Réf.	Page	No. Réf.	Page
No. Cat.	Pagina	No. Cat.	Pagina	No. Cat.	Pagina	No. Cat.	Pagina
09-0925	150	09-1185	118	10		10-0440	390
09-0926	150	09-1376	113	10-0102	383	10-0442	391
09-0927	150	09-1377	113	10-0105	383	10-0443	391
09-0931	150	09-1379	113	10-0106	383	10-0456	393
09-0933	150	09-1380	113	10-0110	384	10-0457	393
09-0940	150	09-1382	113	10-0115	384	10-0458	392
09-0941	150	09-1384	113	10-0120	383	10-0459	392
09-0950	120	09-1386	114	10-0125	384	10-0460	393
09-0952	120	09-1559	113	10-0127	383	10-0461	393
09-0954	120	09-1574	114	10-0130	384	10-0464	393
09-0955	120	09-1576	114	10-0132	385	10-0465	393
09-0956	120	09-1581	114	10-0135	385	10-0466	395
09-0957	120	09-1586	114	10-0138	385	10-0467	395
09-0958	120	09-1591	114	10-0140	384	10-0468	395
09-0959	120	09-1710	114	10-0143	385	10-0469	395
09-0968	121	09-1740	114	10-0145	385	10-0470	395
09-0969	121	09-1741	114	10-0150	385	10-0471	395
09-0971	121	09-1800	115	10-0155	385	10-0475	396
09-0972	121	09-1802	115	10-0160	385	10-0476	396
09-0974	121	09-1804	115	10-0166	384	10-0482	396
09-0975	121	09-1880	151	10-0168	403	10-0483	396
09-0980	151	09-1881	151	10-0168	403	10-0488	397
09-0981	121	09-3000	122	10-0170	388	10-0489	397
09-0982	121	09-3006	122	10-0188	452	10-0489	397
09-0984	121	09-3006	122	10-0190	386	10-0490	400
09-0984	121	09-3007	122	10-0193	386	10-0562	401
09-0985	121	09-3010	122	10-0195	386	10-0563	401
09-0988	151	09-3030	123	10-0200	386	10-0565	401
09-0990	152	09-3031	123	10-0201	149	10-0566	400
09-0994	152	09-3032	123	10-0203	149	10-0567	400
09-1050	116	09-3033	123	10-0220	389	10-0622	402
09-1051	116	09-3034	123	10-0221	389	10-0623	402
09-1060	116	09-3035	123	10-0222	389	10-0624	402
09-1061	116	09-3036	123	10-0223	389	10-0625	402
09-1070	116	09-3037	123	10-0240	389	10-0630	402
09-1071	116	09-3052	123	10-0241	389	10-0640	402
09-1100	117	09-3053	123	10-0245	389	10-0648	403
09-1102	117	09-3054	123	10-0246	389	10-0660	398
09-1104	117	09-3055	123	10-0250	389	10-0670	399
09-1106	117	09-3056	123	10-0251	389	10-0671	399
09-1110	117	09-3057	123	10-0410	394	10-0700	404
09-1112	117	09-3062	124	10-0411	394	10-0701	404
09-1116	115	09-3064	124	10-0412	394	10-0702	404
09-1118	117	09-3066	124	10-0413	394	10-0710	404
09-1120	117	09-3132	124	10-0414	394	10-0711	404
09-1121	115	09-3134	124	10-0415	394	10-0712	404
09-1122	117	09-3136	124	10-0420	391	10-0713	404
09-1126	115	09-3142	124	10-0421	391	10-0714	404
09-1131	115	09-3144	124	10-0422	391	10-0715	404
09-1136	115	09-3146	124	10-0423	391	10-0716	404
09-1141	115	09-3172	124	10-0426	392	10-0717	404
09-1145	115	09-3174	124	10-0427	392	10-0718	404
09-1161	118	09-3176	124	10-0428	392	10-0790	390
09-1168	118	09-3182	124	10-0429	392	10-0792	390
09-1171	118	09-3184	124	10-0436	391	10-0849	403
09-1176	118	09-3186	124	10-0437	391	10-0850	403
09-1181	118			10-0438	390	10-0855	403

Nummernverzeichnis

Index of Numbers

Indice de números de referencias

Index des numéros de références

Indice dei codici

LAWTON
Medizintechnik

Kat. -Nr.	Seite	Kat. -Nr.	Seite	Kat. -Nr.	Seite	Kat. -Nr.	Seite
Cat. No.	Page	Cat. No.	Page	Cat. No.	Page	Cat. No.	Page
Núm. Ref.	Página	Núm. Ref.	Página	Núm. Ref.	Page	Núm. Ref.	Página
No. Réf.	Page	No. Réf.	Page	No. Réf.	Page	No. Réf.	Page
No. Cat.	Página	No. Cat.	Página	No. Cat.	Página	No. Cat.	Página
10-0860	403	11-0431	189	15-0344	312	16-0270	327
10-1146	388	11-0480	387	15-0345	312	16-0271	327
10-1151	388	11-0610	318	15-0346	312	16-0272	327
10-1156	388	11-0612	318	15-0347	312	16-0273	327
10-1195	388	11-0614	318	15-0348	312	16-0274	325
		11-0616	318	15-0349	312	16-0275	325
		11-0618	318	15-0350	312	16-0276	325
11				15-0504	313	16-0276	326
11-0100	415			15-0505	313	16-0277	326
11-0110	415	12		15-0506	313	16-0279	325
11-0115	415	12-0175	728	15-0507	313	16-0284	325
11-0120	415	12-0200	378	15-0508	313	16-0289	326
11-0139	416	12-0201	378	15-0508	313	16-0291	326
11-0140	416	12-0275	454	15-0550	313	16-0292	326
11-0141	416	12-0300	226	15-0551	313	16-0293	326
11-0142	416	12-0301	226	15-0552	313	16-0293	326
11-0143	416	12-0310	226	15-0555	313	16-0294	326
11-0144	416	12-0311	226	15-0557	313	16-0296	326
11-0145	416	12-0330	243	15-0560	313	16-0300	23
11-0146	416	12-0340	224	15-0575	313	16-0305	23
11-0147	416	12-0350	227	15-0576	313	16-0306	457
11-0148	416	12-0352	227	15-0577	313	16-0320	23
11-0149	416	12-0354	227	15-0578	313	16-0325	23
11-0170	416	12-0355	227	15-0579	313	16-0338	23
11-0171	416	12-0410	280	15-0601	315	16-0340	23
11-0172	416			15-0602	315	16-0380	32
11-0173	416	15		15-0603	315	16-0381	32
11-0174	416	15-0203	314	15-0604	315	16-0382	32
11-0175	416	15-0204	314	15-0605	315		
11-0176	416	15-0205	314	15-0606	315	17	
11-0177	416	15-0206	314	15-0607	315	17-0110	318
11-0178	416	15-0214	314	15-0608	315	17-0115	318
11-0179	416	15-0215	314	15-0609	315	17-0170	318
11-0180	416	15-0216	314	15-0610	315		
11-0181	416	15-0223	314	15-0635	315	18	
11-0182	416	15-0225	314	15-0636	315	18-0100	3
11-0183	416	15-0230	314	15-0637	315	18-0103	2
11-0186	416	15-0231	314	15-0638	315	18-0104	2
11-0200	417	15-0232	314	15-0639	315	18-0105	3
11-0230	417	15-0233	314	15-0640	315	18-0106	3
11-0231	417	15-0304	313	15-0792	317	18-0110	2
11-0232	417	15-0305	313	15-0793	317	18-0115	2
11-0233	417	15-0306	313			18-0117	2
11-0234	417	15-0307	313	16		18-0130	4
11-0235	417	15-0308	313	16-0200	324	18-0132	4
11-0236	417	15-0310	313	16-0202	324	18-0134	4
11-0237	417	15-0315	312	16-0204	324	18-0140	7
11-0240	417	15-0316	312	16-0210	324	18-0147	7
11-0265	415	15-0317	312	16-0212	324	18-0148	7
11-0300	419	15-0318	312	16-0214	324	18-0150	6
11-0301	419	15-0319	312	16-0216	324	18-0155	6
11-0305	419	15-0335	312	16-0250	325	18-0158	6
11-0309	418	15-0336	312	16-0255	325	18-0160	6
11-0310	418	15-0337	312	16-0265	325	18-0161	6
11-0314	418	15-0338	312	16-0267	327	18-0162	6
11-0315	418	15-0339	312	16-0268	327	18-0163	6
11-0420	189	15-0340	312	16-0269	327	18-0164	6

Kat. -Nr.	Seite	Kat. -Nr.	Seite	Kat. -Nr.	Seite	Kat. -Nr.	Seite
Cat. No.	Page	Cat. No.	Page	Cat. No.	Page	Cat. No.	Page
No. Réf.	Página	Núm. Ref.	Página	Núm. Ref.	Página	Núm. Ref.	Página
No. Réf.	Page	No. Réf.	Page	No. Réf.	Page	No. Réf.	Page
No. Cat.	Pagina	No. Cat.	Pagina	No. Cat.	Pagina	No. Cat.	Pagina
18-0165	6	18-0522	334	19-0358	17	20-0211	220
18-0167	7	18-0523	334	19-0360	17	20-0212	220
18-0170	5	18-0524	334	19-0399	16	20-0213	220
18-0190	5	18-0525	334	19-0400	16	20-0214	220
18-0191	5	18-0530	334	19-0402	16	20-0220	232
18-0200	10	18-0531	334	19-0403	16	20-0221	233
18-0210	10	18-0532	334	19-0410	18	20-0222	233
18-0211	10	18-0533	334	19-0460	16	20-0223	233
18-0213	10	18-0534	334	19-0467	645	20-0224	233
18-0220	10	18-0535	334	19-0470	645	20-0230	232
18-0221	10	18-0540	334	19-0483	16	20-0231	233
18-0241	8	18-0541	334	19-0487	16	20-0232	233
18-0243	8	18-0542	334	19-0517	18	20-0233	233
18-0244	8	18-0543	334	19-0521	18	20-0234	233
18-0245	8	18-0544	334	19-0522	18	20-0251	219
18-0246	8	18-0545	334	19-0530	18	20-0252	219
18-0247	8					20-0253	219
18-0250	9	19		20		20-0254	219
18-0252	9	19-0100	19	20-0100	218	20-0261	219
18-0255	9	19-0101	19	20-0101	218	20-0262	219
18-0257	9	19-0110	19	20-0102	224	20-0263	219
18-0260	9	19-0120	19	20-0103	224	20-0264	219
18-0301	11	19-0125	19	20-0105	218	20-0272	235
18-0303	11	19-0130	19	20-0106	224	20-0273	235
18-0304	11	19-0135	19	20-0107	224	20-0274	235
18-0305	11	19-0140	645	20-0108	224	20-0276	235
18-0307	11	19-0141	645	20-0109	224	20-0280	232
18-0308	11	19-0145	645	20-0110	224	20-0281	232
18-0325	11	19-0146	645	20-0111	224	20-0282	235
18-0335	11	19-0160	645	20-0112	224	20-0283	235
18-0407	328	19-0161	645	20-0114	225	20-0284	235
18-0408	328	19-0162	645	20-0115	225	20-0286	235
18-0409	328	19-0163	645	20-0120	221	20-0290	232
18-0420	329	19-0202	20	20-0132	225	20-0292	235
18-0420	518	19-0203	20	20-0133	225	20-0293	235
18-0421	329	19-0204	20	20-0134	225	20-0294	235
18-0421	518	19-0205	20	20-0135	225	20-0296	235
18-0422	328	19-0206	20	20-0136	225	20-0300	232
18-0423	328	19-0207	20	20-0137	225	20-0302	234
18-0424	328	19-0208	20	20-0171	219	20-0303	234
18-0425	328	19-0210	20	20-0172	219	20-0304	234
18-0426	328	19-0230	19	20-0176	225	20-0306	234
18-0427	328	19-0250	20	20-0177	225	20-0308	234
18-0428	328	19-0251	20	20-0179	225	20-0310	232
18-0481	329	19-0252	20	20-0191	220	20-0312	234
18-0482	329	19-0253	20	20-0192	220	20-0313	234
18-0483	329	19-0260	20	20-0193	220	20-0314	234
18-0484	329	19-0261	20	20-0194	220	20-0316	234
18-0485	329	19-0262	20	20-0195	220	20-0318	234
18-0486	329	19-0300	17	20-0196	220	20-0352	234
18-0487	329	19-0302	17	20-0197	220	20-0353	234
18-0488	329	19-0305	17	20-0198	220	20-0354	234
18-0490	329	19-0307	17	20-0201	220	20-0356	234
18-0491	329	19-0310	17	20-0202	220	20-0402	227
18-0520	334	19-0315	17	20-0203	220	20-0406	229
18-0521	334	19-0325	17	20-0204	220	20-0410	229

Nummernverzeichnis

Index of Numbers

Índice de números de referencias

Index des numéros de références

Indice dei codici

LAWTON
Medizintechnik

Kat. -Nr.	Seite	Kat. -Nr.	Seite	Kat. -Nr.	Seite	Kat. -Nr.	Seite
Cat. No.	Page	Cat. No.	Page	Cat. No.	Page	Cat. No.	Page
Núm. Ref.	Página	Núm. Ref.	Página	Núm. Ref.	Page	Núm. Ref.	Página
No. Réf.	Page	No. Réf.	Page	No. Réf.	Page	No. Réf.	Page
No. Cat.	Página	No. Cat.	Página	No. Cat.	Página	No. Cat.	Página
20-0411	229	20-0586	242	20-0721	251	20-0920	267
20-0412	229	20-0587	242	20-0722	251	20-0921	267
20-0413	229	20-0589	242	20-0723	251	20-0922	267
20-0415	228	20-0607	244	20-0731	250	20-0930	255
20-0420	231	20-0608	244	20-0732	250	20-0931	255
20-0424	231	20-0614	244	20-0733	250	20-0932	255
20-0430	227	20-0615	244	20-0734	250	20-0933	255
20-0431	227	20-0616	244	20-0735	250	20-0940	255
20-0440	230	20-0617	244	20-0742	252	20-0941	255
20-0442	230	20-0618	244	20-0743	252	20-0990	258
20-0444	230	20-0619	244	20-0744	252	20-0991	258
20-0460	228	20-0620	244	20-0745	252	20-0992	258
20-0465	228	20-0624	243	20-0746	252	20-0995	259
20-0470	228	20-0625	243	20-0747	252	20-0996	259
20-0490	229	20-0626	243	20-0748	252	20-0997	259
20-0495	223	20-0627	243	20-0750	236	20-0999	259
20-0507	241	20-0628	243	20-0751	236	20-1010	309
20-0508	241	20-0629	243	20-0753	236	20-1011	309
20-0509	241	20-0635	244	20-0754	236	20-1013	309
20-0510	241	20-0636	245	20-0760	236	20-1015	309
20-0511	241	20-0637	245	20-0774	237	20-1016	309
20-0512	241	20-0638	245	20-0775	237	20-1017	309
20-0514	241	20-0641	242	20-0776	237	20-1018	309
20-0515	241	20-0642	242	20-0777	237	20-1019	309
20-0516	241	20-0643	242	20-0792	253	20-1730	249
20-0517	241	20-0644	246	20-0793	253	20-1792	263
20-0518	241	20-0645	246	20-0794	253	20-1816	265
20-0519	241	20-0646	246	20-0795	253	20-1831	265
20-0530	238	20-0647	246	20-0796	253	20-1836	265
20-0531	238	20-0648	246	20-0797	253	20-1841	265
20-0532	238	20-0649	246	20-0803	264	20-1862	256
20-0533	238	20-0650	247	20-0804	264	20-1864	256
20-0534	238	20-0651	247	20-0805	264	20-1866	256
20-0535	238	20-0652	247	20-0806	264	20-1872	263
20-0536	238	20-0655	247	20-0807	264	20-1877	262
20-0551	238	20-0656	247	20-0808	264	20-1878	262
20-0552	238	20-0659	247	20-0809	265	20-2862	257
20-0553	238	20-0665	249	20-0810	264	20-2864	257
20-0555	238	20-0680	248	20-0811	265	20-2866	257
20-0556	238	20-0681	248	20-0812	265	20-2868	257
20-0557	239	20-0682	248	20-0847	266	20-2869	257
20-0558	239	20-0683	248	20-0848	266		
20-0559	239	20-0684	248	20-0849	266	21	
20-0561	238	20-0685	248	20-0850	266	21-0128	271
20-0562	238	20-0686	248	20-0852	266	21-0147	270
20-0570	240	20-0687	248	20-0853	266	21-0148	270
20-0571	240	20-0688	248	20-0855	266	21-0149	270
20-0572	240	20-0689	248	20-0860	266	21-0150	270
20-0573	240	20-0699	248	20-0861	266	21-0151	270
20-0574	240	20-0705	251	20-0862	266	21-0152	270
20-0575	240	20-0708	250	20-0865	266	21-0153	270
20-0581	240	20-0709	250	20-0871	267	21-0155	270
20-0582	240	20-0710	250	20-0873	267	21-0156	270
20-0583	240	20-0711	251	20-0874	267	21-0157	270
20-0584	242	20-0712	251	20-0880	262	21-0158	270
20-0585	242	20-0713	251	20-0881	262	21-0159	270

Kat. -Nr.	Seite	Kat. -Nr.	Seite	Kat. -Nr.	Seite	Kat. -Nr.	Seite
Cat. No.	Page	Cat. No.	Page	Cat. No.	Page	Cat. No.	Page
Núm. Ref.	Página	Núm. Ref.	Página	Núm. Ref.	Página	Núm. Ref.	Página
No. Réf.	Page	No. Réf.	Page	No. Réf.	Page	No. Réf.	Page
No. Cat.	Pagina	No. Cat.	Pagina	No. Cat.	Pagina	No. Cat.	Pagina
21-0170	271	21-0352	297	21-0502	301	22-0610	174
21-0172	271	21-0356	297	21-0503	301	22-0611	174
21-0174	271	21-0357	297	21-0505	301	22-0612	174
21-0176	271	21-0358	297	21-0507	300	22-0613	174
21-0179	271	21-0361	298	21-0507	301	22-0910	129
21-0195	272	21-0362	298	21-0509	301	22-0911	140
21-0196	272	21-0365	283	21-0510	301	22-0912	129
21-0200	272	21-0366	283	21-0512	301		
21-0205	273	21-0367	283	21-0550	304	23	
21-0210	273	21-0368	283	21-0552	304	23-1800	521
21-0215	274	21-0369	283	21-0553	304	23-1802	520
21-0216	274	21-0374	283	21-0554	304	23-1804	520
21-0217	274	21-0378	297	21-0556	305	23-1806	520
21-0220	272	21-0379	297	21-0557	305	23-1808	520
21-0225	273	21-0380	298	21-0558	305	23-1810	521
21-0230	273	21-0381	298	21-0559	305	23-1812	520
21-0235	274	21-0382	297	21-0560	305	23-1814	520
21-0240	278	21-0383	297	21-0562	305	23-1816	520
21-0241	278	21-0384	298	21-0563	305	23-1818	520
21-0242	278	21-0387	298	21-0564	305	23-1820	521
21-0243	278	21-0388	298	21-0564	305	23-1820	521
21-0245	278	21-0388	298	21-0565	305	23-1830	521
21-0246	278	21-0389	298	21-0566	305	23-1840	521
21-0252	280	21-0396	298	21-0566	305	23-1840	521
21-0260	273	21-0397	298	21-0567	305	23-1850	524
21-0261	276	21-0398	298	21-0568	305	23-1852	524
21-0263	273	21-0398	298	21-0570	306	23-1860	522
21-0266	276	21-0399	298	21-0571	307	23-1861	522
21-0267	277	21-0401	284	21-0572	307	23-1862	522
21-0268	277	21-0402	284	21-0573	307	23-1863	522
21-0270	275	21-0403	284	21-0574	307	23-1864	522
21-0271	275	21-0420	299	21-0574	307	23-1864	522
21-0280	275	21-0420	299	21-0575	306	23-1865	522
21-0281	275	21-0425	299	21-0576	307	23-1866	522
21-0282	275	21-0426	300	21-0576	307	23-1866	522
21-0282	275	21-0427	300	21-0577	307	23-1867	522
21-0283	275	21-0428	300	21-0578	307	23-1868	522
21-0300	281	21-0428	300	21-0579	306	23-1870	522
21-0301	281	21-0429	300	21-0581	306	23-1871	522
21-0305	281	21-0430	302	21-0584	306	23-1872	522
21-0306	281	21-0431	302	21-0585	306	23-1873	522
21-0310	284	21-0432	302	21-0587	307	23-1874	522
21-0311	284	21-0435	302	21-0588	307	23-1875	522
21-0320	284	21-0436	302	21-0620	304	23-1876	522
21-0325	282	21-0441	303	21-0621	304	23-1877	522
21-0326	282	21-0442	303	21-0622	304	23-1878	522
21-0327	283	21-0443	303	21-0623	304	23-1880	523
21-0328	283	21-0444	303	21-0624	304	23-1881	523
21-0329	283	21-0445	303	21-0625	304	23-1882	523
21-0335	282	21-0446	303	21-0650	308	23-1883	523
21-0336	282	21-0447	303	21-0651	308	23-1884	523
21-0340	297	21-0448	303	21-0652	308	23-1885	523
21-0341	297	21-0449	303	21-0653	308	23-1886	523
21-0345	297	21-0465	299	21-0654	308	23-1887	523
21-0346	297	21-0470	299			23-1888	523
21-0350	297	21-0471	299	22		23-1890	523
21-0351	297	21-0472	299	22-0600	174	23-1891	523
		21-0473	299	22-0601	174	23-1892	523
		21-0500	300	22-0602	174	23-1893	523
		21-0501	300	22-0603	174	23-1894	523

Nummernverzeichnis

Index of Numbers

Índice de números de referencias

Index des numéros de références

Indice dei codici

LAWTON
Medizintechnik

Kat. -Nr. Seite
Cat. No. Page
Núm. Ref. Página
No. Réf. Page
No. Cat. Pagina

23-1895 523
23-1896 523
23-1897 523
23-1898 523
23-1900 559
23-1905 559
23-1910 559
23-1911 555
23-1912 555
23-1913 555
23-1914 555
23-1915 555
23-1916 555
23-1917 555
23-1918 555
23-1925 556
23-1930 556
23-1935 556
23-1950 559
23-1955 559
23-1960 559
23-1965 559
23-1976 560
23-2000 556
23-2005 556
23-2025 557
23-2030 557
23-2035 557
23-2036 557
23-2037 537
23-2038 537
23-2050 560
23-2055 560
23-2075 560
23-2080 560
23-2085 560
23-2090 558
23-2091 558
23-2092 558
23-2520 531
23-2521 531
23-2522 532
23-2523 532
23-2524 532
23-2528 543
23-2529 543
23-2530 543
23-2535 530
23-2537 530
23-2539 530
23-2550 537
23-2555 532
23-2565 542
23-2566 542
23-2567 542
23-2580 542

Kat. -Nr. Seite
Cat. No. Page
Núm. Ref. Página
No. Réf. Page
No. Cat. Pagina

23-2581 542
23-2585 542
23-2586 542
23-2590 543
23-2591 543
23-2593 543
25
25-0210 359
25-0211 359
25-0212 359
25-0213 359
25-0216 359
25-0217 359
25-0218 359
25-0219 359
25-0275 339
25-0276 339
25-0277 339
25-0278 339
25-0294 338
25-0296 338
25-0297 338
25-0299 338
25-0320 359
25-0321 359
25-0322 359
25-0323 359
25-0326 359
25-0327 359
25-0328 359
25-0329 359
25-0330 64
25-0331 64
25-0335 64
25-0336 64
25-0337 64
25-0338 64
25-0339 64
25-0420 361
25-0421 361
25-0422 361
25-0423 361
25-0424 361
25-0425 361
25-0426 361
25-0427 361
25-0428 361
25-0429 361
25-0430 361
25-0431 361
25-0432 361
25-0433 361
25-0434 361
25-0435 361
25-0436 361

Kat. -Nr. Seite
Cat. No. Page
Núm. Ref. Página
No. Réf. Page
No. Cat. Pagina

25-0437 361
25-0438 361
25-0439 361
25-0461 362
25-0462 362
25-0463 362
25-0466 362
25-0467 362
25-0468 362
25-0471 362
25-0472 362
25-0473 362
25-0476 362
25-0477 362
25-0478 362
30
30-0010 135
30-0020 135
30-0021 135
30-0022 135
30-0023 135
30-0024 135
30-0030 135
30-0031 135
30-0032 135
30-0033 135
30-0040 222
30-0041 222
30-0042 222
30-0043 222
30-0044 222
30-0045 222
30-0050 135
30-0051 135
30-0055 135
30-0060 135
30-0061 135
30-0065 135
30-0070 135
30-0071 135
30-0075 135
30-0090 222
30-0091 222
30-0092 222
30-0093 222
30-0094 222
30-0095 222
30-0100 217
30-0130 509
30-0131 509
30-0132 509
30-0135 223
30-0136 223
30-0137 223
30-0138 223

Kat. -Nr. Seite
Cat. No. Page
Núm. Ref. Página
No. Réf. Page
No. Cat. Pagina

30-0139 223
30-0160 223
30-0161 223
30-0162 223
30-0163 223
30-0164 223
30-0165 223
30-0185 95
30-0187 95
30-0189 97
30-0190 97
30-0200 96
30-0205 96
30-0208 96
30-0210 96
30-0211 96
30-0212 96
30-0213 96
30-0214 96
30-0216 96
30-0221 96
30-0224 96
30-0227 96
30-0236 97
30-0240 99
30-0247 98
30-0260 99
30-0690 564
30-0693 564
30-0695 564
30-0800 565
30-0801 565
30-0810 565
30-0811 565
30-0960 160
30-0961 161
30-0962 160
30-0963 161
30-0964 160
30-0965 161
30-0966 160
30-0967 161
30-0971 161
30-0973 161
30-0975 161
30-0977 161
30-0980 160
30-0981 161
30-0982 160
30-0983 161
30-0984 160
30-0985 161
30-0986 160
30-0987 161
30-0991 161
30-0993 161

Kat. -Nr.	Seite	Kat. -Nr.	Seite	Kat. -Nr.	Seite	Kat. -Nr.	Seite
Cat. No.	Page	Cat. No.	Page	Cat. No.	Page	Cat. No.	Page
Núm. Ref.	Página	Núm. Ref.	Página	Núm. Ref.	Página	Núm. Ref.	Página
No. Réf.	Page	No. Réf.	Page	No. Réf.	Page	No. Réf.	Page
No. Cat.	Pagina	No. Cat.	Pagina	No. Cat.	Pagina	No. Cat.	Pagina
30-0995	161	30-1263	530	30-1728	554	30-2154	556
30-0997	161	30-1267	530	30-1730	554	30-2158	556
30-0999	160	30-1270	535	30-1732	554	30-2300	557
30-1000	525	30-1272	535	30-1734	554	30-2303	557
30-1001	525	30-1274	535	30-1736	554	30-2310	557
30-1005	525	30-1276	535	30-1738	554	30-2313	557
30-1006	525	30-1280	536	30-1800	550	30-2335	558
30-1010	525	30-1282	536	30-1825	541	30-2602	561
30-1011	525	30-1284	536	30-1826	541	30-2660	562
30-1015	525	30-1286	536	30-1827	541	30-2662	562
30-1016	525	30-1291	534	30-1828	541	30-2668	562
30-1025	525	30-1292	534	30-1829	541	30-2682	562
30-1026	525	30-1600	547	30-1831	551	30-2684	562
30-1027	525	30-1602	547	30-1832	551	30-2690	558
30-1030	525	30-1605	547	30-1870	538	30-2691	558
30-1100	526	30-1607	547	30-1871	538	30-2695	561
30-1101	526	30-1610	547	30-1872	538		
30-1110	526	30-1630	545	30-1873	538	31	
30-1111	526	30-1631	545	30-1874	538	31-0600	512
30-1115	526	30-1632	545	30-1875	538	31-0601	512
30-1116	526	30-1635	545	30-1876	538	31-0602	512
30-1120	526	30-1640	545	30-1877	538	31-0603	512
30-1121	526	30-1642	548	30-1886	550	31-0605	513
30-1124	527	30-1643	548	30-1887	550	31-0607	513
30-1125	527	30-1646	539	30-1910	531	31-0608	513
30-1127	527	30-1648	539	30-1911	531	31-0609	513
30-1128	527	30-1650	539	30-1915	533	31-0612	512
30-1130	528	30-1655	549	30-1916	533	31-0615	512
30-1132	528	30-1656	549	30-1917	533	31-0616	512
30-1134	528	30-1657	549	30-1918	533	31-0617	512
30-1136	528	30-1658	549	30-1930	544	31-0618	514
30-1138	528	30-1660	541	30-1932	544	31-0619	514
30-1146	537	30-1662	541	30-1940	544	31-0620	514
30-1148	537	30-1664	541	30-1942	544	31-0622	514
30-1150	534	30-1666	541	30-1945	544	31-0623	514
30-1152	534	30-1668	541	30-1947	544	31-0624	514
30-1154	534	30-1680	553	30-1950	563	31-0626	514
30-1156	537	30-1682	553	30-1952	563	31-0628	514
30-1160	529	30-1684	553	30-1954	563	31-0630	514
30-1161	529	30-1686	553	30-1960	563	31-0632	513
30-1162	529	30-1690	553	30-1962	563	31-0634	513
30-1163	529	30-1692	553	30-1964	563	31-0635	514
30-1164	529	30-1694	553	30-2000	56	31-0660	514
30-1165	529	30-1696	553	30-2001	56	31-0661	514
30-1166	529	30-1700	540	30-2002	56	31-0662	514
30-1167	529	30-1702	540	30-2005	57	31-0665	514
30-1200	533	30-1704	540	30-2006	57	31-0666	514
30-1203	533	30-1706	540	30-2007	57	31-0667	514
30-1210	531	30-1711	546	30-2010	57	31-0668	514
30-1213	531	30-1713	546	30-2011	57	31-0669	514
30-1235	534	30-1715	546	30-2012	57	31-0670	514
30-1240	535	30-1719	546	30-2070	56	31-0671	514
30-1245	535	30-1720	554	30-2071	56	31-0672	514
30-1250	535	30-1722	554	30-2072	56	31-0673	514
30-1258	530	30-1724	554	30-2073	56	31-0674	514
30-1262	530	30-1726	554	30-2074	56	31-0675	514

Nummernverzeichnis

Index of Numbers

Índice de números de referencias

Index des numéros de références

Indice dei codici

LAWTON
Medizintechnik

Kat. -Nr.	Seite	Kat. -Nr.	Seite	Kat. -Nr.	Seite	Kat. -Nr.	Seite
Cat. No.	Page	Cat. No.	Page	Cat. No.	Page	Cat. No.	Page
Núm. Ref.	Página	Núm. Ref.	Página	Núm. Ref.	Page	Núm. Ref.	Página
No. Réf.	Page	No. Réf.	Page	No. Réf.	Page	No. Réf.	Page
No. Cat.	Página	No. Cat.	Página	No. Cat.	Página	No. Cat.	Página
31-0677	515	35-0466	518	37-0148	499	38-0150	492
31-0680	322	35-0467	518	37-0150	498	38-0198	493
31-0681	322	35-0720	387	37-0152	498	38-0200	492
31-0682	322	35-0820	387	37-0155	499	38-0210	494
31-0683	322	35-0825	387	37-0156	499	38-0220	494
31-0690	515	35-0830	387	37-0157	500	38-0230	493
31-0700	510	35-0835	387	37-0158	500	38-0231	493
31-0701	510	35-0860	386	37-0159	500	38-0255	492
31-0702	510	35-0865	386	37-0160	503	38-0330	493
31-0703	510			37-0161	503	38-0345	639
31-0704	510	36		37-0162	503	38-0350	639
31-0705	510	36-0170	171	37-0170	502	38-0355	639
31-0706	510	36-0200	566	37-0171	502	38-0400	634
31-0707	510	36-0201	566	37-0172	502	38-0405	636
31-0722	510	36-0202	566	37-0183	503	38-0410	634
31-0723	510	36-0250	564	37-0184	502	38-0415	636
31-0724	510	36-0255	564	37-0185	501	38-0425	635
31-0725	510	36-0260	564	37-0186	501	38-0435	633
31-0726	510	36-0321	186	37-0200	504	38-0440	633
31-0727	510	36-0322	186	37-0202	504	38-0441	633
31-0728	510	36-0323	186	37-0204	504	38-0442	634
31-0729	510	36-0324	186	37-0206	504	38-0443	634
31-0730	510	36-0410	566	37-0208	504	38-0450	633
31-0731	510	36-0415	566	37-0210	505	38-0451	633
31-0732	510	36-1310	551	37-0212	505	38-0455	636
31-0733	510	36-1312	551	37-0214	505	38-0460	636
31-0758	511	36-1326	186	37-0215	505	38-0470	638
31-0760	511	36-1327	186	37-0216	505	38-0471	638
31-0870	516	36-1328	186	37-0217	505	38-0500	635
31-0871	516	36-1329	186	37-0218	505	38-0501	635
31-0872	516	36-1360	551	37-0221	506	38-0502	635
31-0873	516	36-1361	551	37-0222	506	38-0503	635
31-0874	516	36-1362	551	37-0230	507	38-0701	494
31-0875	516	36-1363	551	37-0232	507	38-0703	636
31-0876	516	36-1364	551	37-0234	507		
31-0877	516	36-1365	551	37-0236	507	39	
31-0878	516	36-1370	552	37-0248	508	39-0130	497
31-0879	516	36-1372	552	37-0250	508	39-0165	495
31-0880	516	36-1374	552	37-0255	508	39-0166	495
31-0881	516			37-0258	508	39-0170	495
31-0882	516	37		37-0275	231	39-0171	495
31-0883	516	37-0100	503	37-0276	231	39-0175	495
31-0885	517	37-0110	503	37-0277	231	39-0176	495
31-0886	517	37-0111	503	37-0320	260	39-0192	586
31-0887	517	37-0120	503	37-0321	260	39-0195	586
31-0889	517	37-0121	503	37-0370	260	39-0250	496
31-0895	517	37-0122	503	37-0445	261	39-0252	496
31-0896	517	37-0124	501	37-0446	261	39-0254	496
31-0897	517	37-0125	501	37-0447	261	39-0258	496
31-0898	517	37-0126	501	37-0450	260	39-0262	496
		37-0130	506	37-0455	260	39-0302	497
35		37-0137	507			39-0305	497
35-0460	518	37-0142	500	38		39-0500	329
35-0462	518	37-0143	498	38-0099	492	39-0500	518
35-0463	518	37-0144	498	38-0100	492	39-0523	318
35-0465	518	37-0145	499	38-0110	492	39-0524	318

Kat. -Nr. Seite
Cat. No. Page
Núm. Ref. Página
No. Réf. Page
No. Cat. Pagina

42

42-0110 675
42-0115 675
42-0118 677
42-0120 677
42-0145 678
42-0147 678
42-0150 678
42-0210 679
42-0232 679
42-0234 679
42-0240 679
42-0245 679
42-0300 682
42-0302 682
42-0315 682
42-0320 682
42-0350 680
42-0351 680
42-0355 681
42-0356 681
42-0357 681
42-0358 681
42-0359 681

45

45-0099 624
45-0100 624
45-0110 624
45-0112 627
45-0114 627
45-0116 627
45-0118 627
45-0123 622
45-0127 622
45-0130 622
45-0131 622
45-0133 622
45-0135 622
45-0136 623
45-0138 623
45-0140 623
45-0150 625
45-0159 625
45-0161 625
45-0175 626
45-0185 626
45-0186 626
45-0187 626
45-0188 627
45-0190 628
45-0191 628
45-0192 628
45-0193 628
45-0201 630
45-0202 630

Kat. -Nr. Seite
Cat. No. Page
Núm. Ref. Página
No. Réf. Page
No. Cat. Pagina

45-0205 630
45-0208 630
45-0212 630
45-0214 630
45-0216 630
45-0225 630
45-0230 629
45-0231 629
45-0232 629
45-0233 629
45-0234 629
45-0280 630
45-0302 576
45-0304 576
45-0306 576
45-0308 576
45-0310 581
45-0312 577
45-0314 577
45-0316 577
45-0317 578
45-0318 580
45-0319 578
45-0320 578
45-0322 578
45-0323 579
45-0324 579
45-0325 579
45-0326 580
45-0328 580
45-0329 580
45-0330 581
45-0331 581
45-0348 623
45-0349 623
45-0350 623
45-0360 641
45-0362 641
45-0364 641
45-0366 641
45-0368 641
45-0370 641
45-0371 641
45-0375 641
45-0400 637
45-0402 637
45-0404 637
45-0406 637
45-0410 637
45-0412 637
45-0414 637
45-0416 637
45-0428 638
45-0429 638
45-0430 637
45-0431 637

Kat. -Nr. Seite
Cat. No. Page
Núm. Ref. Página
No. Réf. Page
No. Cat. Pagina

45-0433 637
45-0460 633
45-0462 633
45-0485 638
45-0490 638
45-0491 638
45-0498 494
45-0500 633
45-0502 633
45-0505 633
45-0507 634
45-0509 633
45-0597 634
45-0598 634
45-0599 634
45-0600 632
45-0601 632
45-0605 631
45-0607 631
45-0613 632
45-0628 631
45-0743 710
45-0745 710
45-0753 711
45-0755 711
45-0763 711
45-0765 711
45-0790 707
45-0791 707
45-0792 707
45-0793 707
45-0806 712
45-0807 712
45-0812 712
45-0814 712
45-0815 712
45-0817 712
45-0852 713
45-0853 713
45-0854 713
45-0862 713
45-0863 713
45-0864 713
45-0872 713
45-0873 713
45-0874 713
45-0950 720
45-0951 721
45-0953 721
45-0955 721
45-0956 721
45-0957 721
45-0958 721
45-0959 721
45-1100 709
45-1101 709

Kat. -Nr. Seite
Cat. No. Page
Núm. Ref. Página
No. Réf. Page
No. Cat. Pagina

45-1102 709
45-1103 709
45-1105 709
45-1106 709
45-1107 709
45-1108 709
45-1110 710
45-1111 710
45-1112 710
45-1113 710
45-1130 709
45-1131 709
45-1132 709
45-1133 709
45-1135 709
45-1136 709
45-1137 709
45-1138 709
45-1140 710
45-1141 710
45-1142 710
45-1143 710
45-1170 710
45-1171 710
45-1172 710
45-1173 710
45-1743 710
45-1745 710
45-1753 711
45-1755 711
45-1763 711
45-1765 711

46

46-0002 607
46-0003 607
46-0004 607
46-0005 607
46-0006 607
46-0007 607
46-0008 607
46-0012 607
46-0013 607
46-0014 607
46-0015 607
46-0016 607
46-0017 607
46-0018 607
46-0020 609
46-0022 609
46-0024 609
46-0026 609
46-0028 609
46-0030 609
46-0032 609
46-0034 609

Nummernverzeichnis

Index of Numbers

Índice de números de referencias

Index des numéros de références

Indice dei codici

Kat. -Nr.	Seite	Kat. -Nr.	Seite	Kat. -Nr.	Seite	Kat. -Nr.	Seite
Cat. No.	Page	Cat. No.	Page	Cat. No.	Page	Cat. No.	Page
Núm. Ref.	Página	Núm. Ref.	Página	Núm. Ref.	Página	Núm. Ref.	Página
No. Réf.	Page	No. Réf.	Page	No. Réf.	Page	No. Réf.	Page
No. Cat.	Pagina	No. Cat.	Pagina	No. Cat.	Pagina	No. Cat.	Pagina
46-0036	609	46-0227	610	46-0822	615	47-0118	619
46-0038	609	46-0230	610	46-0823	615	47-0119	619
46-0040	609	46-0235	610	46-0900	611	47-0120	619
46-0042	609	46-0240	610	46-0901	611	47-0121	620
46-0044	609	46-0248	610	46-0902	611	47-0126	621
46-0046	609	46-0250	610	46-0903	611	47-0127	621
46-0048	609	46-0252	610	46-0904	611	47-0129	621
46-0050	612	46-0255	610	46-0905	611	47-0132	617
46-0051	612	46-0260	610	46-0906	611	47-0133	618
46-0052	612	46-0265	610	46-0907	611	47-0134	618
46-0053	612	46-0270	610	46-0908	611	47-0135	618
46-0054	612	46-0350	608	46-0909	611	47-0136	617
46-0060	612	46-0351	608	46-0910	611	47-0140	619
46-0061	612	46-0352	608	46-0911	611	47-0141	619
46-0062	612	46-0353	608	46-0912	611	47-0142	619
46-0063	612	46-0354	608	46-0920	613	47-0143	619
46-0064	612	46-0355	608	46-0921	613	47-0146	620
46-0078	606	46-0356	608	46-0925	613	47-0147	620
46-0079	606	46-0357	608	46-0926	613	47-0148	620
46-0080	606	46-0360	608	46-0930	613	47-0149	620
46-0081	606	46-0361	608	46-0931	613	47-0150	621
46-0082	606	46-0362	608	46-0940	613	47-0191	619
46-0083	606	46-0363	608	46-0941	613	47-0195	618
46-0084	606	46-0364	608	46-0942	613	47-0197	618
46-0094	606	46-0365	608	46-0945	613	47-0200	594
46-0095	606	46-0366	608	46-0946	613	47-0210	594
46-0096	606	46-0370	608	46-0947	613	47-0211	594
46-0097	606	46-0371	608	46-0950	614	47-0217	594
46-0098	606	46-0372	608	46-0952	614	47-0218	595
46-0099	606	46-0373	608	46-0954	614	47-0230	592
46-0149	608	46-0374	608	46-0956	614	47-0231	592
46-0150	608	46-0375	608	46-0958	614	47-0232	592
46-0151	608	46-0376	608	46-0960	615	47-0240	570
46-0152	608	46-0380	610	46-0961	615	47-0241	570
46-0153	608	46-0381	610	46-0962	615	47-0243	570
46-0154	608	46-0382	610	46-0965	615	47-0244	570
46-0155	608	46-0383	610	46-0966	615	47-0245	570
46-0157	608	46-0384	610	46-0967	615	47-0248	570
46-0170	608	46-0710	589	46-0970	616	47-0250	38
46-0172	608	46-0711	589	46-0971	616	47-0251	38
46-0174	608	46-0712	589	46-0972	616	47-0252	38
46-0176	608	46-0713	589	46-0973	616	47-0254	38
46-0177	608	46-0801	612			47-0255	38
46-0178	608	46-0802	612	47		47-0256	38
46-0180	608	46-0803	612	47-0100	618	47-0260	39
46-0182	608	46-0805	612	47-0101	617	47-0262	38
46-0184	608	46-0806	612	47-0102	617	47-0263	38
46-0186	608	46-0807	612	47-0103	617	47-0264	39
46-0187	608	46-0808	612	47-0105	618	47-0265	39
46-0188	608	46-0811	612	47-0108	617	47-0266	39
46-0200	610	46-0812	612	47-0109	617	47-0290	571
46-0202	610	46-0813	612	47-0110	617	47-0291	571
46-0205	610	46-0815	612	47-0111	619	47-0300	572
46-0210	610	46-0816	612	47-0115	618	47-0305	572
46-0215	610	46-0817	612	47-0116	620	47-0310	572
46-0225	610	46-0818	612	47-0117	618	47-0311	572

Kat. -Nr.	Seite	Kat. -Nr.	Seite	Kat. -Nr.	Seite	Kat. -Nr.	Seite
Cat. No.	Page	Cat. No.	Page	Cat. No.	Page	Cat. No.	Page
No. Réf.	Página	No. Réf.	Página	No. Réf.	Página	No. Réf.	Página
No. Cat.	Pagina	No. Cat.	Pagina	No. Cat.	Pagina	No. Cat.	Pagina
47-0315	573	47-0482	601	47-0545	602	47-1611	606
47-0316	573	47-0483	601	47-0546	602	47-1612	606
47-0317	573	47-0484	601	47-0547	602	47-1613	606
47-0320	573	47-0485	601	47-0548	602	47-1614	606
47-0321	573	47-0486	601	47-1520	603	47-1615	606
47-0322	573	47-0490	602	47-1521	603	47-1616	606
47-0323	573	47-0491	602	47-1522	603	47-1617	606
47-0330	573	47-0492	602	47-1523	603	47-1618	606
47-0331	573	47-0493	602	47-1524	603	47-1619	606
47-0332	573	47-0494	602	47-1525	603		
47-0334	573	47-0495	602	47-1526	603	48	
47-0335	573	47-0496	602	47-1527	603	48-0070	576
47-0350	687	47-0499	602	47-1528	603	48-0072	576
47-0360	687	47-0500	602	47-1540	604	48-0075	576
47-0365	687	47-0501	602	47-1541	604	48-0087	574
47-0367	687	47-0502	602	47-1542	604	48-0090	574
47-0370	687	47-0503	602	47-1543	604	48-0091	574
47-0371	687	47-0504	602	47-1550	604	48-0105	582
47-0375	687	47-0505	602	47-1551	604	48-0107	582
47-0400	600	47-0506	602	47-1552	604	48-0108	582
47-0405	600	47-0507	602	47-1553	604	48-0110	582
47-0410	600	47-0508	602	47-1560	604	48-0117	587
47-0414	600	47-0510	602	47-1561	604	48-0118	575
47-0415	600	47-0511	602	47-1562	604	48-0119	587
47-0416	600	47-0512	602	47-1563	604	48-0120	575
47-0420	600	47-0513	602	47-1570	605	48-0121	575
47-0421	600	47-0514	602	47-1571	605	48-0122	575
47-0422	600	47-0515	602	47-1572	605	48-0123	587
47-0423	600	47-0516	602	47-1573	605	48-0125	587
47-0425	599	47-0517	602	47-1574	605	48-0126	587
47-0426	600	47-0518	602	47-1575	605	48-0128	587
47-0427	600	47-0519	602	47-1576	605	48-0129	587
47-0428	600	47-0520	603	47-1577	605	48-0131	575
47-0429	600	47-0521	603	47-1578	605	48-0132	588
47-0430	601	47-0522	603	47-1579	605	48-0134	588
47-0431	601	47-0523	603	47-1580	605	48-0138	590
47-0440	599	47-0524	603	47-1581	605	48-0141	590
47-0441	599	47-0525	603	47-1582	605	48-0142	588
47-0442	599	47-0526	603	47-1583	605	48-0143	588
47-0453	599	47-0527	603	47-1584	605	48-0146	590
47-0455	599	47-0528	603	47-1585	605	48-0147	590
47-0456	599	47-0530	603	47-1586	605	48-0148	588
47-0457	599	47-0531	603	47-1587	605	48-0149	588
47-0461	601	47-0532	603	47-1588	605	48-0151	590
47-0462	601	47-0533	603	47-1589	605	48-0152	590
47-0463	601	47-0534	603	47-1600	606	48-0153	590
47-0464	601	47-0535	603	47-1601	606	48-0154	590
47-0465	601	47-0536	603	47-1602	606	48-0156	591
47-0466	601	47-0537	603	47-1603	606	48-0157	591
47-0471	601	47-0538	603	47-1604	606	48-0158	591
47-0472	601	47-0539	602	47-1605	606	48-0159	591
47-0473	601	47-0540	602	47-1606	606	48-0162	497
47-0474	601	47-0541	602	47-1607	606	48-0163	497
47-0475	601	47-0542	602	47-1608	606	48-0164	497
47-0476	601	47-0543	602	47-1609	606	48-0165	497
47-0481	601	47-0544	602	47-1610	606	48-0166	497

Nummernverzeichnis

Index of Numbers

Índice de números de referencias

Index des numéros de références

Indice dei codici

LAWTON
Medizintechnik

Kat. -Nr.	Seite	Kat. -Nr.	Seite	Kat. -Nr.	Seite	Kat. -Nr.	Seite
Cat. No.	Page	Cat. No.	Page	Cat. No.	Page	Cat. No.	Page
Núm. Ref.	Página	Núm. Ref.	Página	Núm. Ref.	Página	Núm. Ref.	Página
No. Réf.	Page	No. Réf.	Page	No. Réf.	Page	No. Réf.	Page
No. Cat.	Pagina	No. Cat.	Pagina	No. Cat.	Pagina	No. Cat.	Pagina
48-0170	574	48-0406	640	48-0635	658	48-1497	667
48-0172	583	48-0412	640	48-0636	658	48-1498	667
48-0174	591	48-0415	640	48-0640	659	48-1499	668
48-0175	591	48-0416	640	48-0641	659	48-1508	655
48-0176	591	48-0424	648	48-0644	659	48-1510	655
48-0177	574	48-0425	648	48-0645	658	48-1512	655
48-0200	589	48-0426	648	48-0652	654	48-1514	655
48-0201	589	48-0427	648	48-0654	654	48-1515	655
48-0202	589	48-0428	648	48-0656	654	48-1516	655
48-0203	589	48-0429	648	48-0660	658	48-1518	655
48-0204	589	48-0435	624	48-0661	658	48-1520	655
48-0205	589	48-0436	624	48-0665	659	48-1522	655
48-0206	589	48-0460	649	48-0666	659	48-1525	655
48-0210	584	48-0461	649	48-0667	659	48-1527	655
48-0212	584	48-0463	649	48-0674	659	48-1708	655
48-0214	584	48-0464	649	48-0675	659	48-1710	655
48-0216	584	48-0465	649	48-0676	659	48-1712	655
48-0218	585	48-0470	666	48-0902	660	48-1714	655
48-0220	585	48-0471	666	48-0903	660	48-1715	655
48-0222	585	48-0484	663	48-0904	660	48-1716	655
48-0224	585	48-0485	663	48-0905	660	48-1718	655
48-0226	585	48-0486	663	48-0906	660	48-1720	655
48-0228	585	48-0487	663	48-0907	660	48-1722	655
48-0307	642	48-0491	664	48-0908	660	48-1725	655
48-0308	642	48-0492	664	48-0909	660	48-1727	655
48-0309	642	48-0493	664	48-0910	660	48-1828	655
48-0310	643	48-0494	664	48-0912	660	48-1830	655
48-0311	643	48-0495	664	48-0915	660	48-1832	655
48-0312	643	48-0496	664	48-0920	660	48-1834	655
48-0317	642	48-0498	668	48-0922	662	48-1835	655
48-0318	642	48-0499	668	48-0926	660	48-1836	655
48-0330	643	48-0517	689	48-0927	660	48-1838	655
48-0331	643	48-0518	689	48-0928	660	48-1840	655
48-0332	643	48-0580	653	48-0931	661	48-1842	655
48-0333	643	48-0581	653	48-0932	661	48-1845	655
48-0339	644	48-0585	653	48-0933	661	48-1847	655
48-0340	644	48-0586	653	48-0950	669	48-1878	655
48-0341	644	48-0612	653	48-0951	669	48-1880	655
48-0351	646	48-0613	653	48-0952	669	48-1882	655
48-0352	646	48-0615	653	48-0953	669	48-1884	655
48-0353	646	48-0616	653	48-0955	669	48-1885	655
48-0354	646	48-0620	654	48-0956	669	48-1886	655
48-0355	646	48-0621	654	48-0957	669	48-1888	655
48-0360	646	48-0622	654	48-0958	669	48-1890	655
48-0363	646	48-0623	654	48-1019	650	48-1892	655
48-0364	646	48-0624	654	48-1020	650	48-1895	655
48-0376	646	48-0625	654	48-1023	650	48-1897	655
48-0377	646	48-0626	654	48-1030	650	48-2038	655
48-0378	646	48-0627	654	48-1031	650	48-2040	655
48-0379	646	48-0628	654	48-1035	650	48-2042	655
48-0380	647	48-0629	654	48-1484	663	48-2044	655
48-0382	647	48-0630	658	48-1486	663	48-2045	655
48-0384	647	48-0631	658	48-1488	663	48-2046	655
48-0388	648	48-0632	658	48-1491	667	48-2048	655
48-0400	640	48-0633	658	48-1495	667	48-2050	655
48-0405	640	48-0634	658	48-1496	667	48-2052	655

Kat. -Nr.	Seite	Kat. -Nr.	Seite	Kat. -Nr.	Seite	Kat. -Nr.	Seite
Cat. No.	Page	Cat. No.	Page	Cat. No.	Page	Cat. No.	Page
Núm. Ref.	Página	Núm. Ref.	Página	Núm. Ref.	Página	Núm. Ref.	Página
No. Réf.	Page	No. Réf.	Page	No. Réf.	Page	No. Réf.	Page
No. Cat.	Pagina	No. Cat.	Pagina	No. Cat.	Pagina	No. Cat.	Pagina
48-2055	655	50		51-0571	693	51-0830	323
48-2057	655	50-0107	652	51-0572	693	51-0832	323
48-2058	655	50-0120	651	51-0573	693	51-0833	323
48-2060	655	50-0121	651	51-0574	693	51-0834	323
48-2062	655	50-0140	652	51-0575	693	51-0835	323
48-2064	655	50-0141	652	51-0576	693	51-0866	323
48-2065	655	50-0142	652	51-0577	692	51-0867	323
48-2066	655	50-0143	652	51-0578	692	51-0868	323
48-2068	655	50-0144	652	51-0600	218	51-0870	323
48-2070	655	50-0145	652	51-0610	217	51-0871	323
48-2072	655	50-0146	652	51-0612	217		
48-2075	655	50-0147	652	51-0613	217	52	
48-2077	655	50-0150	652	51-0615	216	52-0090	586
48-2078	655	50-0151	652	51-0617	215	52-0091	586
48-2080	655	50-0160	652	51-0618	215	52-0092	586
48-2082	655	50-0190	650	51-0634	700	52-0100	586
48-2084	655	50-0255	688	51-0636	700	52-0105	586
48-2085	655	50-0335	687	51-0640	700	52-0110	586
48-2086	655	50-0400	100	51-0641	700	52-0115	586
48-2088	655	50-0419	100	51-0643	700	52-0200	701
48-2090	655	50-0420	100	51-0644	700	52-0202	701
48-2092	655	50-0465	100	51-0650	221	52-0205	701
48-2095	655	50-0600	690	51-0657	214	52-0210	701
48-2097	655	50-0602	690	51-0658	214	52-0212	701
48-2100	657	50-0620	155	51-0660	214	52-0214	701
48-2102	657	50-0621	155	51-0661	214	52-0216	701
48-2104	657	50-0622	155	51-0662	214	52-0220	702
48-2106	657	50-0623	155	51-0664	214	52-0222	702
48-2108	657	50-0631	690	51-0665	214	52-0224	703
48-2158	656	50-0633	690	51-0666	214	52-0226	703
48-2160	656	50-0635	690	51-0667	214	52-0228	703
48-2162	656	50-0649	691	51-0668	215	52-0230	703
48-2164	656	50-0650	691	51-0669	215	52-0232	703
48-2165	656	50-0652	691	51-0729	698	52-0234	703
48-2166	656	50-0658	691	51-0730	698	52-0236	704
48-2168	656	50-0679	690	51-0731	698	52-0238	704
48-2170	656	50-1001	651	51-0735	698	52-0240	705
48-2172	656	50-1002	651	51-0745	698	52-0242	705
48-2175	656	50-1003	651	51-0790	699	52-0244	705
48-2177	656	50-1004	651	51-0792	699	52-0246	705
48-2178	656	50-1005	651	51-0794	699	52-0250	701
48-2180	656	50-1006	651	51-0796	699	52-0252	691
48-2182	656	50-1007	651	51-0798	699	52-0254	691
48-2184	656	50-1010	651	51-0800	323	52-0261	706
48-2185	656	50-1015	651	51-0801	323	52-0262	706
48-2186	656	50-1016	651	51-0802	323	52-0263	706
48-2188	656	50-1017	651	51-0803	323	52-0264	706
48-2190	656	50-1018	651	51-0806	323	52-0265	706
48-2192	656			51-0807	323	52-0266	706
48-2195	656	51		51-0808	323	52-0267	706
48-2197	656	51-0524	692	51-0810	323	52-0290	706
		51-0528	692	51-0811	323	52-0291	706
49		51-0534	692	51-0812	323	52-0298	706
49-4260	329	51-0540	692	51-0818	323	52-0300	706
49-4262	329	51-0541	692	51-0828	323	52-0301	706
49-4264	329	51-0570	693	51-0829	323	52-0302	706

Nummernverzeichnis

Index of Numbers

Índice de números de referencias

Index des numéros de références

Indice dei codici

Kat. -Nr.	Seite	Kat. -Nr.	Seite	Kat. -Nr.	Seite	Kat. -Nr.	Seite
Cat. No.	Page	Cat. No.	Page	Cat. No.	Page	Cat. No.	Page
Núm. Ref.	Página	Núm. Ref.	Página	Núm. Ref.	Page	Núm. Ref.	Página
No. Réf.	Page	No. Réf.	Page	No. Réf.	Page	No. Réf.	Page
No. Cat.	Página	No. Cat.	Página	No. Cat.	Página	No. Cat.	Página
52-0303	706	52-0721	289	52-0784	293	53-0402	716
52-0304	706	52-0722	289	52-0785	293	53-0403	716
52-0305	706	52-0723	289	52-0786	293	53-0404	716
52-0306	706	52-0724	289	52-0790	293	53-0405	716
52-0307	706	52-0725	289	52-0791	293	53-0406	716
52-0350	272	52-0726	289	52-0792	293	53-0407	716
52-0394	276	52-0727	289	52-0793	293	53-0408	716
52-0395	276	52-0730	289	52-0794	293	53-0430	717
52-0490	279	52-0731	289	52-0795	293	53-0431	717
52-0491	279	52-0732	289	52-0796	293	53-0432	717
52-0494	279	52-0733	289	52-0797	293	53-0435	717
52-0497	279	52-0734	289	52-0798	293	53-0436	717
52-0499	280	52-0735	289	52-0799	293	53-0437	717
52-0512	231	52-0736	289	52-0800	294	53-0450	717
52-0514	231	52-0737	289	52-0801	294	53-0451	717
52-0516	296	52-0739	289	52-0802	294	53-0452	717
52-0517	296	52-0740	290	52-0803	294	53-0510	718
52-0520	689	52-0742	290	52-0804	294	53-0512	718
52-0525	689	52-0745	291	52-0805	294	53-0514	718
52-0540	689	52-0746	291	52-0806	294	53-0516	718
52-0542	689	52-0750	292	52-0807	294	53-0518	718
52-0555	286	52-0751	292	52-0810	295	53-0520	718
52-0583	286	52-0770	292	52-0812	295	53-0522	718
52-0585	286	52-0770	293	52-0814	295	53-0524	718
52-0588	286	52-0771	292	52-0816	295	53-0526	718
52-0590	286	52-0771	293	52-0818	295	53-0528	718
52-0600	287	52-0772	292	52-1301	296	53-0530	718
52-0601	287	52-0772	293	52-1305	296	53-0532	718
52-0610	287	52-0773	292	52-1345	285	53-0534	718
52-0611	287	52-0773	293	52-1346	285	53-0536	718
52-0613	287	52-0774	292	52-1355	285	53-0538	718
52-0620	287	52-0774	293	52-1356	285	53-0542	718
52-0621	287	52-0775	292	52-1360	285	53-0544	718
52-0685	287	52-0775	293	52-1361	285	53-0546	718
52-0686	287	52-0776	292	52-1362	285	53-0552	718
52-0687	287	52-0776	293	52-1363	285	53-0554	718
52-0700	288	52-0777	292	52-1364	285	53-0556	718
52-0701	288	52-0777	293	52-1370	285	53-0562	718
52-0702	288	52-0778	292	52-1371	285	53-0564	718
52-0705	288	52-0778	293	52-1372	285	53-0566	718
52-0705	289	52-0779	292	52-1373	285	53-0572	719
52-0706	289	52-0779	293	52-1374	285	53-0574	719
52-0710	289	52-0780	290			53-0582	719
52-0711	288	52-0780	291	53		53-0584	719
52-0711	289	52-0780	293	53-0300	719	53-0592	719
52-0712	288	52-0781	290	53-0370	715	53-0594	719
52-0712	289	52-0781	291	53-0371	715	53-0970	688
52-0713	288	52-0781	293	53-0372	715	53-0971	688
52-0713	289	52-0782	290	53-0373	715	53-0975	688
52-0714	288	52-0782	291	53-0374	715	53-0976	688
52-0714	289	52-0782	293	53-0375	715	53-0977	688
52-0715	288	52-0783	290	53-0376	715		
52-0715	289	52-0783	291	53-0377	715	57	
52-0716	289	52-0783	293	53-0378	715	57-0050	695
52-0717	289	52-0784	290	53-0400	716	57-0080	694
52-0720	289	52-0784	291	53-0401	716	57-0085	694

Kat. -Nr.	Seite	Kat. -Nr.	Seite	Kat. -Nr.	Seite	Kat. -Nr.	Seite
Cat. No.	Page	Cat. No.	Page	Cat. No.	Page	Cat. No.	Page
Núm. Ref.	Página	Núm. Ref.	Página	Núm. Ref.	Página	Núm. Ref.	Página
No. Réf.	Page	No. Réf.	Page	No. Réf.	Page	No. Réf.	Page
No. Cat.	Pagina	No. Cat.	Pagina	No. Cat.	Pagina	No. Cat.	Pagina
57-0090	694	57-1081	67	60-1220	218	62-3763	360
57-0091	695	57-1082	67	60-1221	218	62-3764	360
57-0092	695	57-1083	67	60-1260	217	62-3765	360
57-0093	695	57-1086	67	60-1780	36	62-3768	360
57-0094	695	57-1087	67	60-1791	36	62-3769	360
57-0095	694	57-1088	67	60-1793	36	62-3778	360
57-0096	695	57-1089	67	60-1797	36	62-3779	360
57-0098	695	57-1095	362	62		63	
57-0099	695	57-1096	362	62-0250	139	63-0010	70
57-0100	694	57-1097	362	62-0251	128	63-0011	70
57-0105	694	57-1098	362	62-0252	139	63-0050	70
57-0110	694	57-1099	362	62-0253	128	63-0051	70
57-0115	694	57-1110	125	62-0254	138	63-0099	92
57-0120	695	57-1112	125	62-0255	138	63-0100	92
57-0125	695	57-1114	125	62-0256	138	63-0150	92
57-0130	695	57-1116	125	62-0261	128	63-0151	92
57-0132	696	57-1120	125	62-0263	128	63-0200	88
57-0134	696	57-1122	125	62-0271	128	63-0201	88
57-0136	696	57-1124	125	62-0273	128	63-0202	88
57-0138	696	57-1126	125	62-0280	139	63-0330	68
57-0142	696	57-1130	125	62-0281	139	63-0331	68
57-0144	696	57-1140	126	62-0283	139	63-0332	68
57-0146	696	57-1142	126	62-0284	139	63-0333	68
57-0148	696	57-1144	126	62-0561	138	63-0402	88
57-0150	697	57-1146	126	62-0749	138	63-0403	88
57-0152	697	57-1148	126	62-0750	138	63-0420	92
57-0154	697	57-1160	126	62-0751	138	63-0421	92
57-0175	694	57-1162	126	62-0770	138	63-0906	68
57-0325	118	57-1164	127	62-0771	138	63-0907	68
57-0365	118	57-1166	127	62-0772	138	63-0910	68
57-0670	215	57-1171	127	62-0848	122	63-0911	68
57-0671	215	57-1173	127	62-0849	122	63-1360	94
57-0672	215	57-1175	127	62-0853	122	63-1400	62
57-0673	215	57-1181	127	62-0862	139	63-1401	62
57-0800	697	57-1183	127	62-0864	139	63-1402	62
57-0805	697	57-1185	127	62-1220	152	63-1403	62
57-0810	697	57-1250	719	62-1400	152	63-1406	62
57-0815	697	57-1272	737	62-1402	152	63-1407	62
57-0850	215	57-1276	737	62-1405	152	63-1408	62
57-0851	215	57-1286	720	62-1420	152	63-1800	7
57-0855	215	57-1294	729	62-1460	152	63-1801	7
57-0856	215	57-1296	730	62-3736	358	63-2200	312
57-0860	212	57-1298	730	62-3739	358	63-2201	312
57-0861	212			62-3740	358	63-2202	312
57-0866	212	60		62-3741	358	63-2203	312
57-1054	66	60-1110	213	62-3742	358	63-2204	312
57-1055	66	60-1111	213	62-3743	358	63-2205	312
57-1064	66	60-1112	213	62-3744	358	63-2220	312
57-1065	66	60-1199	222	62-3745	358	63-2221	312
57-1066	66	60-1200	222	62-3750	363	63-2222	312
57-1067	66	60-1201	222	62-3755	360	63-2223	312
57-1069	66	60-1202	222	62-3756	360	63-2224	312
57-1072	66	60-1203	222	62-3760	360	63-2225	312
57-1073	66	60-1208	222	62-3761	360	63-2230	312
57-1074	66	60-1215	216	62-3762	360	63-2231	312
57-1079	66	60-1216	216				

Nummernverzeichnis

Index of Numbers

Indice de números de referencias

Index des numéros de références

Indice dei codici

LAWTON
Medizintechnik

Kat. -Nr.	Seite
Cat. No.	Page
Núm. Ref.	Página
No. Réf.	Page
No. Cat.	Pagina

63-2233	312
63-2235	312
63-2237	312
63-2239	312
63-2240	312
63-2241	312
63-2243	312
63-2245	312
63-2247	312
63-2249	312
63-2710	707
63-2711	707
63-2720	707
63-2900	607
63-2901	607
63-2905	607
63-2906	607
63-2920	583
63-2925	583
63-2965	225

65

65-0230	4
65-0234	4
65-0273	4
65-0274	4
65-0281	4
65-0282	4
65-0285	4
65-0301	322
65-0302	322
65-0303	322
65-0361	332
65-0362	332
65-0363	332
65-0366	332
65-0366	333
65-0368	332
65-0368	333
65-0369	332
65-0370	332
65-0371	332
65-0372	332
65-0379	332
65-0380	332
65-0382	332
65-0384	332
65-0386	332
65-0387	332
65-0388	332
65-0389	332
65-0431	317
65-0432	317

66

66-0158	598
---------	-----

Kat. -Nr.	Seite
Cat. No.	Page
Núm. Ref.	Página
No. Réf.	Page
No. Cat.	Pagina

66-0159	598
66-0160	598
66-0161	598
66-0162	599
66-0163	598
66-0165	598
66-0166	598
66-0167	599
66-0168	598
66-0170	598
66-0171	598
66-0172	598
66-0255	213
66-0256	213
66-0257	213
66-0260	213
66-0261	213
66-0262	213
66-0263	213
66-0264	213
66-0270	213
66-0271	213
66-0307	316
66-0308	316
66-0309	316
66-0310	316
66-0311	316
66-0312	316
66-0313	316
66-0318	316
66-0319	316
66-0320	316
66-0321	316
66-0322	316
66-0325	316
66-0326	316
66-0327	316
66-0330	316
66-0331	316
66-0332	316
66-0700	272
66-0701	272

67

67-0371	609
67-0372	609
67-0373	609
67-0374	609
67-0375	609
67-0381	609
67-0382	609
67-0383	609
67-0384	609
67-0385	609
67-0391	609
67-0392	609

Kat. -Nr.	Seite
Cat. No.	Page
Núm. Ref.	Página
No. Réf.	Page
No. Cat.	Pagina

67-0393	609
67-0394	609
67-0395	609
67-0654	631
67-0656	631
67-0702	632
67-0704	632
67-0710	632
67-0711	632
67-0712	632
67-0715	631
67-0716	631
67-0717	632
67-0718	632

68

68-0310	604
68-0311	604
68-0312	604
68-0313	604
68-0314	604
68-0315	604
68-1015	212
68-1017	212
68-1020	212
68-1021	212
68-1022	212
68-1023	212
68-1024	212
68-1025	212
68-1026	212
68-1027	212
68-1028	212
68-1210	584
68-1212	584
68-1214	584
68-1215	584
68-1410	322
68-1440	321
68-1441	321
68-1470	321
68-1471	321
68-1472	321
68-1473	321
68-1474	321
68-1480	320
68-1481	320
68-1482	320
68-1484	320
68-1485	320
68-1486	320
68-1488	320
68-1489	320

70

70-0670	322
---------	-----

Kat. -Nr.	Seite
Cat. No.	Page
Núm. Ref.	Página
No. Réf.	Page
No. Cat.	Pagina

70-0671	322
70-0673	322
70-0725	321
70-0787	319
70-0788	319
70-0789	319
70-0794	319
70-0795	319
70-0796	319
70-0804	319
70-0805	319
70-0806	319
70-0810	320
70-0840	320
70-0850	319
70-0860	319
70-0865	319
70-0870	320
70-0871	320
70-0960	593
70-0963	593
70-0965	593
70-0967	593

71

71-0100	101
71-0102	101
71-0120	101
71-0122	101
71-0415	583
71-0416	583
71-0440	583
71-0441	583
71-0450	582
71-0490	582
71-0493	582
71-0516	583
71-0560	604
71-0561	604
71-0562	604
71-0580	604
71-0655	607
71-0656	607

72

72-0202	714
72-0204	714
72-0212	714
72-0214	714
72-0222	714
72-0224	714
72-0242	714
72-0244	714
72-0700	708
72-0701	708
72-0702	708

Kat. -Nr. Seite
Cat. No. Page
Núm. Ref. Página
No. Réf. Page
No. Cat. Pagina

72-0703 708
72-0710 708

75

75-0100 37
75-0215 216
75-0218 216
75-0220 216
75-0221 216
75-0222 216
75-0325 218
75-0330 217
75-0340 219
75-0342 219
75-0344 219
75-0345 219
75-0400 218
75-0412 221
75-0430 221
75-0435 221
75-0620 226

76

76-0415 68
76-0416 68
76-0426 93
76-0427 93
76-0472 82
76-0473 82
76-0475 82
76-0478 82
76-0479 82
76-0540 83
76-0541 83
76-0542 83
76-0543 83
76-0561 94
76-0570 93
76-0571 93
76-0610 82
76-0611 82
76-0620 81
76-0623 81
76-0630 102
76-0631 102
76-0640 102
76-0650 102
76-0760 81

77

77-0350 595
77-0355 595
77-0400 592
77-0410 593
77-0420 593
77-0421 593

Kat. -Nr. Seite
Cat. No. Page
Núm. Ref. Página
No. Réf. Page
No. Cat. Pagina

77-0430 592
77-0431 592
77-0440 593
77-0450 592
77-0607 330
77-0608 330
77-0610 330
77-0620 608
77-0630 608
77-0631 608
77-0632 608
77-0633 608
77-0634 608
77-0650 330
77-0651 330
77-0652 330
77-0653 330
77-0654 330
77-0655 330
77-0670 330
77-0671 330
77-0672 330
77-0673 330
77-0674 330
77-0675 330
77-0680 331
77-0682 331
77-0684 331
77-0685 328
77-0686 328
77-0687 328
77-0688 328
77-0690 331
77-0691 331
77-0692 331
77-0693 331
77-0698 331
77-0699 331
77-0760 582
77-0765 584
77-0766 584
77-0877 333
77-0878 333
77-0883 333
77-0884 333
77-1330 596
77-1332 596
77-1340 596
77-1341 596
77-1342 596
77-1343 596
77-1344 596
77-1345 596
77-1346 596
77-1347 596
77-1348 596

Kat. -Nr. Seite
Cat. No. Page
Núm. Ref. Página
No. Réf. Page
No. Cat. Pagina

77-1349 596
77-1350 597
77-1351 597
77-1352 597
77-1353 597
77-1354 597
77-1607 330
77-1608 330
77-1610 330
77-1650 330
77-1651 330
77-1652 330
77-1653 330
77-1654 330
77-1655 330
77-1670 330
77-1671 330
77-1672 330
77-1673 330
77-1674 330
77-1675 330
77-1680 331
77-1682 331
77-1684 331
77-1690 331
77-1691 331
77-1692 331
77-1693 331

78

78-0120 637
78-0320 366

80

80-0100 22
80-0105 22
80-0112 22
80-0275 22
80-0370 12
80-0372 12
80-0373 12
80-0376 12
80-0377 12
80-0378 12
80-0379 12
80-0735 193
80-0750 179
80-0752 179

81

81-0125 574
81-0308 374
81-0309 374
81-0650 103
81-0655 103
81-0677 103

Kat. -Nr. Seite
Cat. No. Page
Núm. Ref. Página
No. Réf. Page
No. Cat. Pagina

85

85-0001 27
85-0002 27
85-0003 27
85-0004 27
85-0005 27
85-0006 26
85-0007 26
85-0008 27
85-0008 31
85-0009 31
85-0040 29
85-0041 29
85-0042 29
85-0043 29
85-0044 29
85-0045 28
85-0046 28
85-0047 28
85-0047 30
85-0048 28
85-0048 30
85-0058 25
85-0058 29
85-0059 25
85-0059 29
85-0072 24
85-0072 26
85-0073 25
85-0074 25
85-0075 25
85-0076 25
85-0081 31
85-0082 31
85-0083 31
85-0084 31
85-0085 31
85-0087 30
85-0088 30
85-0090 24
85-0091 24
85-0092 25
85-0094 25
85-0094 29
85-0098 25
85-0098 29
85-0099 24
85-0099 26
85-0100 14
85-0101 14
85-0102 14
85-0103 14
85-0104 14
85-0105 14
85-0106 14
85-0107 14

Nummernverzeichnis

Index of Numbers

Indice de números de referencias

Index des numéros de références

Indice dei codici

LAWTON
Medizintechnik

Kat. -Nr.	Seite	Kat. -Nr.	Seite	Kat. -Nr.	Seite	Kat. -Nr.	Seite
Cat. No.	Page	Cat. No.	Page	Cat. No.	Page	Cat. No.	Page
Núm. Ref.	Página	Núm. Ref.	Página	Núm. Ref.	Page	Núm. Ref.	Página
No. Réf.	Page	No. Réf.	Page	No. Réf.	Page	No. Réf.	Page
No. Cat.	Página	No. Cat.	Página	No. Cat.	Página	No. Cat.	Página
85-0108	14	87-0415	725	87-0555	726	90-0622	412
85-0109	14	87-0416	725	87-0556	726	90-0623	412
85-0110	14	87-0417	725	87-0557	726	90-0632	412
85-0111	14	87-0418	725	87-0558	726	90-0633	412
85-0120	14	87-0419	725	87-0559	726	90-0652	412
85-0121	14	87-0420	726	87-0564	727	90-0654	412
85-0122	14	87-0421	726	87-0565	727	90-0656	412
85-0123	14	87-0422	726	87-0566	727	90-0706	412
85-0124	14	87-0423	726	87-0567	727	90-0712	412
85-0125	14	87-0424	726	87-0568	727	90-0713	412
85-0126	14	87-0425	726	87-0569	727	90-0955	409
85-0127	14	87-0426	726	87-0574	727	90-0962	410
85-0128	14	87-0427	726	87-0575	727	90-0969	410
85-0129	14	87-0428	726	87-0576	727	90-0970	410
85-0130	14	87-0429	726	87-0577	727	90-0971	410
85-0131	14	87-0430	726	87-0578	727	90-0972	410
85-0149	14	87-0431	726	87-0579	727	90-0974	411
85-0150	14	87-0432	726	87-0584	727	90-0975	411
85-0151	14	87-0433	726	87-0585	727	90-0976	411
85-0152	14	87-0434	726	87-0586	727	90-0977	411
85-1100	13	87-0435	726	87-0587	727	90-0978	411
85-1101	13	87-0436	726	87-0588	727	90-0979	411
85-1102	13	87-0437	726	87-0589	727		
85-1103	13	87-0438	726	87-0650	727	92	
85-1104	13	87-0439	726	87-1035	729	92-0101	310
85-1105	13	87-0440	725	87-1040	730	92-0102	310
85-1106	13	87-0441	725			92-0103	310
85-1107	13	87-0442	725	90		92-0104	310
85-1108	13	87-0443	725	90-0099	407	92-0105	310
85-1109	13	87-0444	725	90-0100	408	92-0106	310
85-1110	13	87-0445	725	90-0110	408	92-0108	310
85-1111	13	87-0446	725	90-0115	408	92-0114	310
85-1130	13	87-0447	725	90-0116	408	92-0130	310
85-1132	13	87-0448	725	90-0117	408	92-0136	310
		87-0449	725	90-0118	408	92-0137	310
87		87-0450	725	90-0119	408	92-0138	310
87-0135	217	87-0451	725	90-0130	405	92-0139	310
87-0140	217	87-0452	725	90-0138	405	92-0145	268
87-0145	728	87-0453	725	90-0140	405	92-0150	268
87-0146	728	87-0454	725	90-0145	405	92-0200	422
87-0150	728	87-0455	725	90-0147	406	92-0205	422
87-0151	728	87-0456	725	90-0148	406	92-0210	422
87-0200	226	87-0457	725	90-0149	406	92-0215	422
87-0270	728	87-0458	725	90-0150	407	92-0251	423
87-0275	728	87-0459	725	90-0151	407	92-0252	423
87-0400	726	87-0460	725	90-0155	406	92-0255	423
87-0401	726	87-0461	725	90-0180	407	92-0256	423
87-0402	726	87-0462	725	90-0205	406	92-0338	372
87-0403	726	87-0463	725	90-0210	406	92-0340	372
87-0404	726	87-0464	725	90-0225	407	92-0341	372
87-0405	726	87-0465	725	90-0230	407	92-0342	372
87-0406	726	87-0466	725	90-0276	405	92-0343	372
87-0407	726	87-0467	725	90-0309	409	92-0370	426
87-0408	726	87-0468	725	90-0311	409	92-0372	426
87-0409	726	87-0469	725	90-0312	409	92-0480	425
87-0414	725	87-0554	726	90-0351	409	92-0481	425

Kat. -Nr.	Seite	Kat. -Nr.	Seite	Kat. -Nr.	Seite	Kat. -Nr.	Seite
Cat. No.	Page	Cat. No.	Page	Cat. No.	Page	Cat. No.	Page
Núm. Ref.	Página	Núm. Ref.	Página	Núm. Ref.	Página	Núm. Ref.	Página
No. Réf.	Page	No. Réf.	Page	No. Réf.	Page	No. Réf.	Page
No. Cat.	Pagina	No. Cat.	Pagina	No. Cat.	Pagina	No. Cat.	Pagina
92-0486	425	95		95-0202	441	95-0337	444
92-0501	420	95-0010	430	95-0215	439	95-0338	444
92-0502	420	95-0015	431	95-0216	439	95-0339	444
92-0503	420	95-0016	431	95-0217	439	95-0340	444
92-0504	420	95-0017	431	95-0222	440	95-0341	444
92-0505	421	95-0020	431	95-0223	254	95-0342	444
92-0506	421	95-0021	431	95-0224	254	95-0343	444
92-0544	425	95-0022	431	95-0225	440	95-0344	444
92-0546	425	95-0030	430	95-0226	440	95-0345	444
92-0547	426	95-0037	430	95-0227	440	95-0346	444
92-0548	426	95-0038	430	95-0228	440	95-0360	445
92-0549	426	95-0039	430	95-0229	440	95-0362	445
92-0550	190	95-0040	433	95-0231	254	95-0364	445
92-0560	191	95-0041	433	95-0232	254	95-0365	445
92-0561	190	95-0042	433	95-0244	440	95-0366	445
92-0562	190	95-0045	433	95-0245	440	95-0367	445
92-0580	191	95-0046	433	95-0257	438	95-0368	445
92-0590	195	95-0047	433	95-0258	438	95-0369	445
92-0612	192	95-0050	433	95-0259	438	95-0379	444
92-0613	192	95-0051	433	95-0271	438	95-0380	445
92-0615	192	95-0052	433	95-0272	438	95-0381	444
92-0620	193	95-0055	433	95-0273	438	95-0382	444
92-0624	193	95-0056	433	95-0275	438	95-0383	444
92-0625	192	95-0057	433	95-0276	438	95-0384	444
92-0676	193	95-0080	431	95-0277	438	95-0385	444
92-0677	193	95-0081	431	95-0278	438	95-0386	444
92-1408	424	95-0082	431	95-0285	440	95-0387	444
92-1410	424	95-0085	431	95-0286	440	95-0388	444
92-1412	424	95-0086	431	95-0290	434	95-0389	445
92-1414	424	95-0087	431	95-0291	434	95-0390	446
92-1416	424	95-0100	432	95-0292	434	95-0391	444
92-1418	424	95-0105	432	95-0293	434	95-0392	446
92-1420	424	95-0110	432	95-0294	434	95-0396	444
92-1422	424	95-0119	432	95-0295	434	95-0397	444
92-1424	424	95-0120	432	95-0296	434	95-0399	444
92-1426	424	95-0121	432	95-0297	434	95-0401	446
92-1428	424	95-0125	432	95-0298	434	95-0405	446
92-1430	424	95-0130	432	95-0299	442	95-0406	446
92-1432	424	95-0135	432	95-0300	447	95-0408	447
92-1434	424	95-0145	432	95-0301	447	95-0410	447
92-1436	424	95-0146	433	95-0321	444	95-0414	447
92-1730	424	95-0147	433	95-0322	444	95-0480	443
92-1732	424	95-0149	433	95-0323	444	95-0482	443
92-1734	424	95-0156	432	95-0324	444	95-0483	443
92-1736	424	95-0175	440	95-0325	444	95-0484	443
92-1738	424	95-0176	440	95-0326	444	95-0485	443
92-1740	424	95-0177	440	95-0327	444	95-0486	448
92-1742	424	95-0178	440	95-0328	444	95-0487	448
92-1752	424	95-0179	440	95-0329	444	95-0488	448
92-1754	424	95-0180	440	95-0330	444	95-0550	460
92-1756	424	95-0182	441	95-0331	444	95-0600	462
92-1758	424	95-0197	430	95-0332	444	95-0601	462
92-1760	424	95-0198	430	95-0333	444	95-0604	463
92-1762	424	95-0199	430	95-0334	444	95-0606	463
92-1764	424	95-0200	441	95-0335	444	95-0608	463
		95-0201	441	95-0336	444	95-0610	464

Nummernverzeichnis

Index of Numbers

Indice de números de referencias

Index des numéros de références

Indice dei codici

LAWTON
Medizintechnik

Kat. -Nr.	Seite	Kat. -Nr.	Seite	Kat. -Nr.	Seite	Kat. -Nr.	Seite
Cat. No.	Page	Cat. No.	Page	Cat. No.	Page	Cat. No.	Page
Núm. Ref.	Página	Núm. Ref.	Página	Núm. Ref.	Page	Núm. Ref.	Página
No. Réf.	Page	No. Réf.	Page	No. Réf.	Page	No. Réf.	Page
No. Cat.	Pagina	No. Cat.	Pagina	No. Cat.	Pagina	No. Cat.	Pagina
95-0612	464	95-0849	605	95-0996	468	95-1063	467
95-0614	464	95-0850	466	95-0996	469	95-1064	467
95-0616	464	95-0851	466	95-0997	468	95-1065	467
95-0650	461	95-0852	466	95-0997	469	95-1066	467
95-0652	461	95-0853	466	95-0998	468	95-1071	467
95-0659	462	95-0854	466	95-0998	469	95-1072	467
95-0660	462	95-0855	466	95-0999	468	95-1073	467
95-0661	462	95-0860	466	95-0999	469	95-1074	467
95-0662	462	95-0861	466	95-1000	468	95-1075	467
95-0670	461	95-0862	466	95-1000	469	95-1076	467
95-0680	465	95-0863	466	95-1001	468	95-1081	467
95-0681	465	95-0864	466	95-1001	469	95-1082	467
95-0682	465	95-0865	466	95-1002	468	95-1083	467
95-0683	465	95-0927	466	95-1002	469	95-1084	467
95-0684	465	95-0928	468	95-1003	468	95-1085	467
95-0685	465	95-0928	469	95-1003	469	95-1086	467
95-0686	465	95-0929	468	95-1004	468	95-1091	467
95-0687	465	95-0929	469	95-1004	469	95-1092	467
95-0688	465	95-0930	468	95-1005	468	95-1093	467
95-0689	465	95-0930	469	95-1005	469	95-1094	467
95-0690	465	95-0931	468	95-1006	468	95-1095	467
95-0691	465	95-0931	469	95-1006	469	95-1096	467
95-0692	465	95-0932	468	95-1007	468	95-1101	460
95-0693	465	95-0932	469	95-1007	469	95-1102	460
95-0699	465	95-0933	468	95-1008	468	95-1103	460
95-0740	448	95-0933	469	95-1008	469	95-1105	460
95-0741	448	95-0934	468	95-1009	468	95-1106	460
95-0745	449	95-0934	469	95-1009	469	95-1107	460
95-0746	449	95-0935	468	95-1010	468	95-1120	470
95-0747	449	95-0935	469	95-1010	469	95-1121	470
95-0748	449	95-0936	468	95-1018	468	95-1122	470
95-0749	449	95-0936	469	95-1018	469	95-1123	470
95-0750	450	95-0937	468	95-1020	468	95-1124	470
95-0751	450	95-0937	469	95-1020	469	95-1125	470
95-0752	450	95-0938	468	95-1021	468	95-1126	470
95-0753	450	95-0938	469	95-1021	469	95-1130	470
95-0755	451	95-0939	468	95-1022	468	95-1131	470
95-0756	451	95-0939	469	95-1022	469	95-1132	470
95-0757	451	95-0978	468	95-1023	468	95-1133	470
95-0758	451	95-0978	469	95-1023	469	95-1134	470
95-0762	463	95-0988	468	95-1024	468	95-1135	470
95-0764	459	95-0988	469	95-1024	469	95-1136	470
95-0765	459	95-0989	468	95-1025	468	95-1150	471
95-0809	459	95-0989	469	95-1025	469	95-1151	471
95-0810	459	95-0990	468	95-1026	468	95-1152	471
95-0812	459	95-0990	469	95-1026	469	95-1153	471
95-0820	466	95-0991	468	95-1027	468	95-1154	471
95-0821	466	95-0991	469	95-1027	469	95-1155	471
95-0822	466	95-0992	468	95-1028	468	95-1156	471
95-0823	466	95-0992	469	95-1028	469	95-1159	471
95-0824	466	95-0993	468	95-1029	468	95-1200	437
95-0844	605	95-0993	469	95-1029	469	95-1201	437
95-0845	605	95-0994	468	95-1030	468	95-1202	437
95-0846	605	95-0994	469	95-1030	469	95-1210	437
95-0847	605	95-0995	468	95-1061	467	95-1211	437
95-0848	605	95-0995	469	95-1062	467	95-1212	437

Kat. -Nr. **Seite**
Cat. No. Page
Núm. Ref. Página
No. Réf. Page
No. Cat. Pagina

95-1215 437
95-1216 437
95-1217 437
95-1240 434
95-1241 434
95-1242 434
95-1244 434
95-1245 434
95-1246 434
95-1250 435
95-1251 435
95-1252 435
95-1253 435
95-1254 435
95-1255 435
95-1260 436
95-1261 436
95-1262 436
95-1263 436
95-1264 436
95-1265 436
95-1266 436
95-1267 436
95-1268 436
95-1290 441
95-1310 439
95-1311 439
95-1312 439
95-1313 439
95-1321 444
95-1322 444
95-1323 444
95-1324 444
95-1325 444
95-1326 444
95-1327 444
95-1328 444
95-1329 444
95-1330 444
95-1331 444
95-1332 444
95-1333 444
95-1334 444
95-1335 444
95-1336 444
95-1337 444
95-1350 440
95-1351 440
95-1352 440
95-1353 440
95-1354 440
95-1355 440
95-2000 442
95-2001 442
95-2002 442
95-2003 442

Kat. -Nr. **Seite**
Cat. No. Page
Núm. Ref. Página
No. Réf. Page
No. Cat. Pagina

95-2005 442
95-2006 442
95-2007 442
95-2008 442
95-2009 442

96
96-0100 208
96-0105 208
96-0110 208
96-0125 210
96-0251 221
96-0300 452
96-0303 453
96-0305 453
96-0306 453
96-0309 452
96-0310 452
96-0313 452
96-0315 453
96-0320 452
96-0349 454
96-0350 454
96-0351 454
96-0352 454
96-0355 455
96-0357 455
96-0370 456
96-0371 456
96-0380 456
96-0580 197
96-0581 197
96-0582 197
96-0583 197
96-0584 197
96-0590 197
96-0591 197
96-0592 197
96-0593 197
96-0594 197
96-0600 196
96-0602 196
96-0605 195
96-0620 194
96-0625 196
96-0628 196
96-0630 196
96-0670 196
96-0674 195
96-0680 194
96-0681 194
96-0682 194
96-0683 194
96-0684 194
96-0685 194
96-0732 456

Kat. -Nr. **Seite**
Cat. No. Page
Núm. Ref. Página
No. Réf. Page
No. Cat. Pagina

96-0733 456
96-0734 456
96-0735 456
96-0740 455
96-0749 458
96-0750 458
96-0800 458
96-0815 421
96-0817 458
96-0980 107
96-0985 107
96-0987 107
96-0988 107
96-0989 107
96-0990 108
96-0993 108

97
97-0100 477
97-0192 480
97-0200 478
97-0201 478
97-0202 478
97-0203 478
97-0220 479
97-0225 479
97-0290 479
97-0300 480
97-0306 480
97-0370 482
97-0371 482
97-0372 482
97-0373 482
97-0374 482
97-0375 482
97-0380 481
97-0382 481
97-0390 481
97-0410 485
97-0415 485
97-0430 485
97-0435 109
97-0436 109
97-0440 486
97-0443 486
97-0450 457
97-0452 457
97-0456 457
97-0470 483
97-0471 483
97-0472 483
97-0481 484
97-0482 484
97-0483 484
97-0490 481
97-0493 477

Kat. -Nr. **Seite**
Cat. No. Page
Núm. Ref. Página
No. Réf. Page
No. Cat. Pagina

97-0495 477
97-0501 484
97-0502 484
97-0503 484
97-0513 486
97-0515 486
97-0521 484
97-0522 484
97-0531 484
97-0532 484
97-0533 484
97-0550 426
97-0552 426
97-0553 426
97-0554 426
97-0555 426
97-0556 426
97-0557 426
97-0558 426
97-0600 472
97-0601 472
97-0602 472
97-0620 472
97-0621 472
97-0622 472
97-0641 472
97-0645 472
97-0646 472
97-0648 472
97-0660 474
97-0661 474
97-0662 474
97-0663 474
97-0664 474
97-0665 474
97-0666 474
97-0667 474
97-0668 474
97-0669 474
97-0670 473
97-0672 473
97-0674 473
97-0676 473
97-0678 473
97-0680 473

98
98-0200 109
98-0210 109

99
99-0099 631
99-0100 631
99-0101 631

Ihr Fachhändler:

Your distributor:

Su distribuidor:

Votre distributeur:

Il Vs. distributore è:

LAWTON

MEDIZINTECHNIK

LAWTON GmbH & Co. KG

Württembergischer Str. 23

Telefon: +49 (0) 7463 99 65-0

e-mail: info@lawton.de

D-78567 Fridingen/Germany

Telefax: +49 (0) 7463 99 65-20

<http://www.lawton.de>