

2016 SURGICAL INSTRUMENTS CATALOG
German Engineering. American Design. World-Class Quality.



Pilling® | KMedic®

Teleflex, KMedic and Pilling are trademarks or registered trademarks of Teleflex Incorporated or its affiliates.

Teleflex is a global provider of medical products designed to enable healthcare providers to protect against infections and improve patient and provider safety. The company specializes in products and services for vascular access, respiratory, general and regional anesthesia, cardiac care, urology and surgery. Teleflex also provides specialty products for device manufacturers.

© 2015 Teleflex Incorporated. All rights reserved. MC-001338

2016 SURGICAL INSTRUMENTS CATALOG
German Engineering. American Design. World-Class Quality.



GENERAL INFORMATION

Pilling® and Kmedic® Surgical Instruments	7
Guarantee/Warranty	9
Customer Service and Ordering Information	10
Care and Cleaning	12
Policies and Procedures	13
Trademarks	14
Instrumentation Services	15
N-Compass™ Instrument Management System	16
Scales and Gauges	18
Measuring Guidelines and Common Jaw Patterns of Surgical Instruments	20

GENERAL INSTRUMENTS AND PRODUCTS

Overview	22
Knife Handles	24
Forceps and Clamps	27
Scissors	103
Needle Holders	152
Retractors, Hand-Held	187
Retractors, Self-Retaining	218
Retractors, Table-Mounted	240
Suction Tubes	245
Extended Length/Open Bariatric	251
OB/GYN	264
Urology	294
Rectal	300
Miscellaneous General	309
Micro Clips and Applicators	317
Instrument Accessories	324
Pilling® Case and Tray Solutions	330
Instrument Accessories	331
Floor Grade Instruments	351
Specialty Sponges	359
Weck® Specialty Products	369
Container Systems	370
Weck® Ligation Solutions	375

EAR, NOSE AND THROAT INSTRUMENTS

Overview	388
Laryngoscopes	390
Subglottoscopes	408
Instrumentation for Laryngoscopes	418
Bronchoscopes	439
Telescopes and Accessories	444
Rigid Endoscope/Telescope Compatibility Chart	446
Esophagoscopes	448

Instrumentation for Bronchoscopes and Esophagoscopes	453
Lightsources	466
Fiber Optic Cables	467
Bougies/Dilators	469
Tracheostomy and Laryngectomy Tubes	473
Ear Instruments	495
Nasal Instruments	505
Mouth and Throat Instruments	523
Scope and Light Carriers	536

CARDIAC, VASCULAR AND THORACIC INSTRUMENTS

Overview	544
CVT Forceps and Clamps	546
Bulldog® and Micro Vessel Clamps	562
Vascular Clamps	575
Aortic Vascular Clamps	630
Scissors	658
CVT Needle Holders	676
Titanium Instruments: Forceps and Clamps	688
Titanium Instruments: Scissors	706
Titanium Instruments: Needle Holders	709
Rib Instruments	716
CVT Retractors	722
Valve Instruments	753
Aortic Punches	764
Heparin Cannulae	766
Suction Tubes	767
Vascular Dilators	770
Valvulotomes	774
Mediastinoscopy	776
Video-Assisted Thoracoscopy	782
Miscellaneous CVT	795
Specialty Sets	800

ORTHOPEDIC INSTRUMENTS

Overview	806
KMedic® Wire and Pin Implants	808
Kirschner Wires, Steinmann Pin, Vickers K-Wire Dispensers	811
Vickers Easidriver	813
KMedic® Gratloch™ Wire Bender	815
Wire Twisters and Wire/Pin/Rod Cutters	817
KMedic® Corwin Wire Twister	819
KMedic® P.I. Wire Twister and Tightener	820
KMedic® Jet Wire Twister	821
About KMedic® Wire and Pin Cutters	822
KMedic® Large Pin Cutter	830
KMedic® Cable Cutter	832

Table Top Rod Cutter	834
Pliers	835
Wire Guides and Traction Bows	848
Ligature Carriers and Wire Passers	849
Drills, Drill Bits and Guides	850
KMedic® Drill Bit Case	855
Trephines	865
Screw Drivers	866
Bending Irons and Rod Holders	874
Orthopedic Retractors	878
Vickers Finger Retractor	895
Bone Holding Instruments	914
Bone Hooks and Awls	938
Cartilage and Tendon Instruments	942
Dissectors and Elevators	949
Bone Files and Rasps	966
Curettes	975
Osteotomes	988
Smartracks for Osteotomes	997
Chisels and Gouges	998
Bone Tamps And Impactors	1005
Mallets	1007
Bone Cutting Forceps	1015
Rongeurs	1019
KMedic® Spinal Rongeurs and Punches	1041
KMedic® Cleanpunch® Rongeurs	1043
TI Spinal Implant Removal System	1062
Nail Instruments	1064
Bone Saws and Knives	1071
Plaster Cast Instruments	1074
Measuring Devices	1077
Smartracks	1080
Miscellaneous Orthopedic	1085

OPHTHALMIC INSTRUMENTS

Overview	1094
Forceps	1096
Scissors	1106
Needle Holders	1115
Hooks	1116
Curettes	1118
Knives	1119
Specula	1119
Lacrimal Probes/Dilators	1120
Eye Spuds/Needles	1121
Irrigation Cannula	1122
Calipers	1124
Cutting Block	1124
Eye Shields	1125

LAPAROSCOPIC INSTRUMENTS

Overview	1126
Handle Types	1128
5 mm Dissectors, Grasping Forceps	1129
10 mm Dissectors	1132
5-10 mm Biopsy Forceps	1133
5 mm Bipolar Forceps	1135
5 mm Ratcheted Graspers	1136
5 mm Needle Holders	1141
5 mm Scissors	1142
Trays	1143
Electrodes and Coagulators	1144
Verres Needles	1145
Cannulas	1145
Probes	1145
Knot Pushers	1145
Telescopes	1146
Retractors	1146

ELECTROSURGICAL INSTRUMENTS

Overview	1148
Biceps Non-stick Bipolar Forceps and Cords	1150
Biceps Forceps and Cords	1151
Disposable Electrodes	1153
Monopolar Handswitching Forceps	1154
Coagulation Suction Tubes	1155

ADDITIONAL SURGICAL PRODUCTS

Overview	1156
Deklene® Maxx™ Polypropylene Suture	1158
Tevdek®/Polydek® Braided Polyester Suture	1158
NextStitch® Valve Suture	1158
Gabbay Frater Suture Organizer	1158
Taut® Cholangiography Catheters	1159
Taut® System One™ Common Bile Duct Exploration Kit	1160
Weck Vista® Bladeless Laparoscopic Access Ports	1161
Weck EFX™ Endo Fascial Closure System	1162
Weck® Visistat® Skin Staplers	1163
INDEX	1164

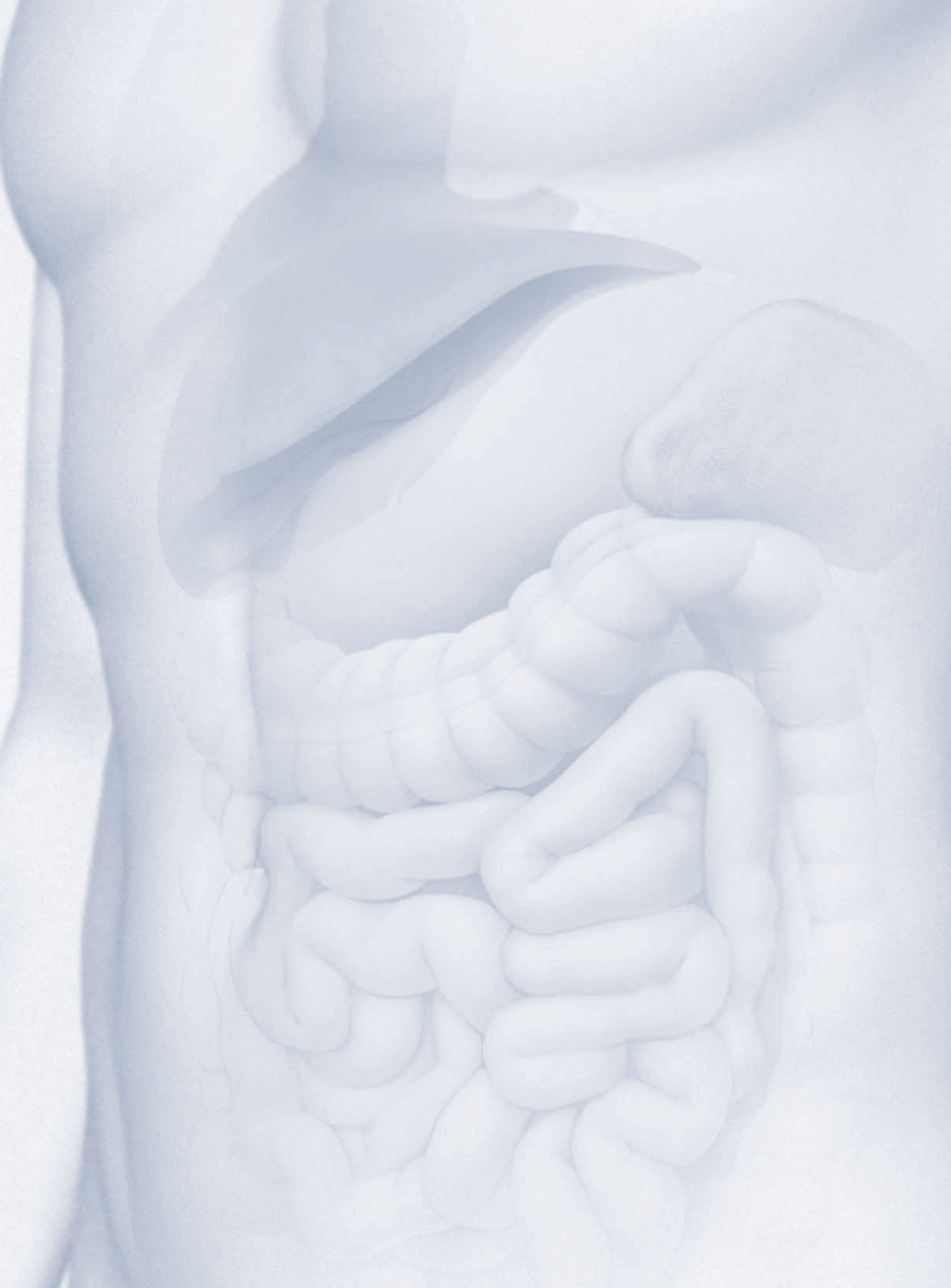

PILLING® AND KMEDIC® SURGICAL INSTRUMENTS

Quality That Builds Confidence

For nearly 200 years, quality Pilling® Instruments have been provided to surgeons across the world to help improve the standard of patient care. The Pilling® Brand is especially known globally in the CVT and ENT specialties with numerous proprietary instruments co-developed with leading surgeons in these fields.

George P. Pilling joined a company started in 1814 that fashioned jewelry and fraternal emblems and guided the business into a new role. As hospitals in the Philadelphia, Pennsylvania area needed new tools to provide improved care for their patients, the Pilling Company met that important need and established itself as the oldest surgical instrument manufacturer in the United States.

Today, the Pilling® Brand is an important part of the Teleflex® Brand portfolio, and continues its legacy in providing high quality, hand-crafted instrumentation that meets the surgeon's requirements.

Over the years, the Pilling® Brand has maintained high standards of quality and continues to emphasize customer service and satisfaction. As surgical procedural needs change, specialty surgeons can count on Pilling® Branded instruments to meet their new requirements.

KMedic® Instruments, another member of the Teleflex® Family of brands, offers the most extensive line of orthopedic instruments with more than 2,000 patterns. Just like our Pilling® Brand, our KMedic® Line of orthopedic instruments conforms to the highest standards of precision and reliability, consistency of pattern and lasting value.



PILLING® AND KMEDIC®

American Designed. German Engineered. World-class Quality.

Pilling® and KMedic® Branded surgical instruments are made from 100% German and U.S. forgings to ensure the highest quality and impeccable functionality. These instruments are fully guaranteed for the quality of material and workmanship and have been subjected to an established quality control process that consists of a comprehensive product inspection that verifies the form, fit and function of all the instruments.

Pilling® Forceps and Scissors are made of the finest stainless steel, processed to obtain optimum corrosion resistance, resilience and strength.

Ratchets on Pilling® Vascular Clamps provide indispensable finite control for arterial clamping. Ratchets are designed with the steps (1 x 7, 1 x 9, 1 x 11) to furnish the specific amounts of required compression.

Pilling® DeBakey® Jaws are designed to clamp and hold without slipping. Cardiovascular clamps featuring these jaws will grip tissue delicately but firmly, or will completely occlude a vessel, reducing the danger of crushing or causing undue damage to the intima.

The LIFE-LOK® Box-Lock construction of all Pilling® Vascular Clamps and a growing assortment of general instruments has virtually eliminated cracked and

broken box-locks. This major improvement materially prolongs the useful life of these expensive instruments and reduces the necessity for repair or replacement.

We are able to provide **laser surface or ebonized finishes** for most stainless steel instruments to provide the appropriate reflection-lowering finish for their use in laser surgery.

We continually strive to improve our products; therefore, changes may result. All specifications and measurements in this Catalog may vary within accepted industry standards or change without notice. Teleflex® will not be responsible for any printing errors contained herein.

Measurements given in our Catalog refer to overall length, unless specified otherwise.

Reproduction of illustrations or descriptions is prohibited without the express written consent of Teleflex®.

For more information on Pilling® and KMedic® Products, or to place an order, contact Customer Service at 866-246-6990.

PILLING® AND KMEDIC® SURGICAL INSTRUMENTS

Guarantee/Warranty

This warranty information may be modified from time to time by Teleflex®. Please check the Pilling® Instruments online catalog website for the most current warranty information: Pillinginstruments.com

Except as provided below, all surgical instruments stamped or etched with the Pilling® or KMedic® Brand shall be free from manufacturing defects in material or workmanship for the life of the instrument. Teleflex®'s sole responsibility under all warranty shall be, at Teleflex®'s option, to either repair, replace or refurbish any instrument proving defective, free of charge. Teleflex® makes no warranty with respect to In-Ex branded instruments, lenses, malleable items, micro instruments, bougies and disposable products. This guarantee is void if instruments are not maintained or repaired properly, or if they are not used for their intended surgical purpose.

LIFE-LOK® BOX-LOCK

Pilling® Instruments that feature the LIFE-LOK® box-lock are warranted not to break or crack in the box-lock area due to stress buildup for the life of the instrument.

NEEDLE HOLDERS

Pilling® Needle Holders containing Tungsten Carbide (TC) inserts are warranted against cracking or fragmenting in the jaw for three (3) years.

TUNGSTEN CARBIDE INSERTS

KMedic® Scissors, Needle Holders and Wire Cutters that obtain Tungsten Carbide (TC) inserts are guaranteed for three (3) years. Replacement parts, such as springs, are guaranteed for one (1) year.

NON-DISPOSABLE LAPAROSCOPIC INSTRUMENTS

Pilling® Non-Disposable Laparoscopic Instruments are warranted against failure in normal use for one (1) year. This warranty does not cover routine sharpening or refurbishment, or repair of damage caused by misuse.

The above warranties are contingent upon the proper maintenance and use of the instruments and do not cover instruments that have been modified without Teleflex®'s approval or which have been subjected to unusual stress, or on which the original identification marks have been removed or altered.

TELESCOPES AND LIGHT CARRIERS

All light carriers and Rod Lens Telescopes etched with the Pilling® Name shall be free from manufacturing defects in material or workmanship. Any parts proving defective in the first 12 months of ownership will be serviced, repaired or replaced at Teleflex®'s option, free of charge.

This limited warranty is the only warranty provided by Teleflex®. Teleflex® disclaims all other warranties, either express or implied, including but not limited to implied warranties of merchantability and fitness for particular purpose. In no event shall Teleflex® have any liability for indirect, consequential, special, incidental or punitive damages, however caused, on any theory of liability and whether or not it has been advised of the possibility of such damages.

CUSTOMER SERVICE & ORDERING INFORMATION

Our highly trained customer service team is available to assist you with all your customer service needs including:

- New account establishment or account changes
- Order placement
- Order inquiries
- Delivery information
- Pricing inquiries
- Product information
- Product returns

UNITED STATES HEADQUARTERS

Physical Address

Teleflex
3015 Carrington Mill Boulevard
Morrisville, NC 27560

Mailing Address

Teleflex
PO Box 12600
Research Triangle Park, NC 27709

Phone/Fax

Toll Free: 866.246.6990
Fax: 866.804.9881

To make an inquiry or to place an order in the **United States**, please contact Customer Service at **866.246.6990** or cs@teleflex.com from **8 a.m. to 8 p.m. (EST)**.

CANADA HEADQUARTERS

Physical Address

165 Gibson Drive
Markham, Ontario L3R 3K7

Phone/Fax

Toll Free: +1 (0) 905.943.9000
Fax: +1 (0) 905.943.9001

To make an inquiry or to place an order in **Canada**, please contact Customer Service at **800.387.9699** or customerservicecanada@teleflex.com from **8 a.m. to 4:30 p.m. (EST)**.

LATIN AMERICA HEADQUARTERS

Physical Address

Teleflex
3015 Carrington Mill Boulevard
Morrisville, NC 27560 USA

Phone/Fax

Toll Free: +1 919.433.4999
Fax: +1 919.361.4111

For availability in your region, please contact Customer Service at **+1 919.433.4999** or la.cs@teleflex.com.

Not all products may be available for sale or use in your particular region. Please contact your local sales office for additional details.



CARE AND CLEANING

High quality surgical instruments are typically made from surgical grade stainless steel (i.e., 410, 420, etc.). The grade varies by manufacturer and by type of instrument. For example, a scissor may be fabricated of 420 stainless steel to enable the blades to be hardened adequately for long life. A forceps on the other hand usually does not require the same hardness, and may be fabricated from a 410 grade.

Malleable retractors are made of yet another grade. The grade of stainless steel selected for specific instruments is critical for long serviceability. The grade of steel reflects its hardness and its resistance to corrosion. Unfortunately, there is an inverse relationship; that is, the more the steel can be hardened, the greater its susceptibility to corrosion.

In an effort to reduce corrosion problems, Teleflex® specially treats (passivates) its instruments to make the surface less chemically active with its environment. All Weck® Instruments feature this special high gloss finish. This finish reduces the number of pits in the instrument, which in turn reduces the number of sites where corrosion can occur. These steps are necessary due to the environment, which is very harsh as a consequence of the composition of blood and other fluids, the chemicals used to clean and disinfect the instruments, and finally the methods used to sterilize them.

USE

Use instruments for their intended purpose only.

CLEANING

Instruments should be thoroughly cleaned with cleaners such as: Wec-Kleen®, Weck® Liquid Detergent, Weck Instrument Cleaner or Wec-Wash® as soon as possible after use. Once blood or other foreign matter has dried, removal is very difficult.

If left in place these contaminants can provide sites for corrosion to begin. Distilled water (pH near 7) is recommended for soaking and cleaning instruments. If cleaning manually, avoid use of wire brushes or abrasive powders as these can create sites for corrosion. An ultrasonic cleaner is recommended.

CARE

After a thorough cleaning, instruments with moving parts should be lubricated using a product such as Weck-Lube® or Wec-Kreem® to keep surfaces lubricated. It is important to use water soluble lubricating agents only.

STERILIZATION

The use of repeated flash cycles is damaging to instruments; therefore, a standard steam cycle is preferred. Instruments should be arranged in an open position and instruments fabricated from different metals should be separated to avoid electrochemical reactions. Refer to the sterilizer manufacturer's instructions and AORN guidelines for proper sterilization techniques.

MAINTENANCE

Routine inspection for damaged tips, jaw alignment, loose box-locks and worn or damaged ratchets can identify problems. If caught early these problems can often be repaired at a much lower cost than the replacement price of an instrument which has become damaged beyond repair. Contact your Teleflex® Sales Representative to see the Weck® Care and Cleaning Products, set up an instrument inspection program, and review our extensive repair capabilities.

To locate Instructions For Use (IFU) and Cleaning and Sterilization Instructions for Pilling® Instruments, go to: www.teleflex.com/ifu.

POLICIES AND PROCEDURES

REFURBISHING/REPAIR SERVICE

Even the finest surgical instruments may need to be repaired or refurbished. Teleflex recognizes the need to provide rapid responses and quick turnaround times in these situations.

We accept all brands and types of surgical instruments in need of refurbishment or repair. To expedite your repair, include hospital name and address, department to return, and a contact name and phone number. Any surgical instrument which needs refurbishing or repair, regardless of manufacturer, should be forwarded to:

Teleflex
Surgical Instrument Repair
4177 Varsity Drive Unit B
Ann Arbor, MI 48108
(877) TFX- RPR1
(877) 839-7771

TERMS AND CONDITIONS

Standard terms are: net 30 days; F.O.B. shipping point, unless otherwise approved in writing by Teleflex.

All orders are subject to approval and acceptance by Teleflex.

Teleflex reserves the right to alter or suspend credit, refuse shipment or cancel unfilled orders, when credit conditions or delivery delays from the customer warrant such action.

PARTIAL SHIPMENTS AND SPECIAL ORDERS

Due to demand for certain products, Teleflex cannot guarantee that every product will be available for immediate shipment. If a back order situation occurs, partial shipment will be made where possible. Your invoice will indicate any product on back order.

If partial shipments are not acceptable or practical, we will make every effort to ship the complete order at the earliest possible time.

Certain products are built to order and are subject to availability of raw materials. These products may require longer lead times.

RETURN GOODS POLICY

All returns must be accompanied by a "Return Goods Authorization Number" which is available by calling our Customer Service Department at 866-246-6990. Teleflex's invoice number, order number and date of receipt of goods must be supplied to customer service in order to obtain a return goods number.

All returns must be made within sixty (60) days of invoice date. The products must be unused and in the original packaging.

Returned goods must be shipped prepaid to:

Teleflex
11425 N. Distribution Cove
Olive Branch, MS 38654

The goods should also be accompanied by a copy of the invoice or packing list and a return goods authorization number. All returns are subject to the Teleflex instrument's inspection and acceptance and there will be a \$5.00 per instrument charge for removal of etching applied at the customer's request. The following items are non-returnable, other than for a manufacturing defect:

- Sterilized products
- Discontinued products
- Engraved instruments or instruments etched by hospital
- Instruments returned after sixty (60) days of invoice date
- Custom or modified items
- Silicone goods
- Disposable products

TELEFLEX® TRADEMARKS

Pilling®

BICEPS®
BULLDOG®
CLEAR ADVANTAGE®
DIGITATE®
HEMOCLIP®
CLEANPUNCH®
HEM-O-LOK®
IDENTI-LOOPS®
LIFE-LOK®
PILLING®
KMEDIC®
PLASTI STATS®
TECHNIQUE®
VISISTAT®

WEC-JAW®
WEC-KLEEN®
WECK-LUBE®
WEC-PEN FTC®
WEC-WASH®
WECK®
KAISER-PILLING®
K-P®
KLINTMALM™
MAKI™
MCDUGAL™
N-COMPASS™
WECK-RACK™

All other trademarks or name brands cited herein are the property of their respective owners.

INSTRUMENTATION SERVICES

In addition to providing our customers with a comprehensive product line of surgical instruments, Teleflex® also offers the following programs and services:

- N-COMPASS™ Instrument Management System
- Repair Service
- Custom Instruments Service
- Complimentary Instrument Etching
- Special Instrument Finishes

For more information on these services, please contact your Teleflex® Surgical Sales Specialist or customer service at 866.246.6990.

N-COMPASS™ INSTRUMENT MANAGEMENT SYSTEM

Your Path to Total Instrument Management

THE N-COMPASS SYSTEM SAVES TIME AND MONEY BY:

- Minimizing risk of errors in instrument set assembly, which can help reduce OR schedule delays
- Enabling Central Processing staff to locate instruments by providing the functionality to search hospital inventory
- Identifying frequently used instrument sets and helping you manage inventory relative to case volume
- Minimizing risk of purchasing errors and increased requisition processing time by clear identification of instrument requirements and vendors

THE N-COMPASS SYSTEM PUTS YOU IN CONTROL: CUSTOMIZE COUNT SHEETS

- Use and update easily
- Include images of each instrument and the assembled instrument set
- Customize to your specific needs
- Make and save global instrument changes

INSTRUMENT LOCATOR

- Search by catalog number, description or vendor
- Search set inventory to locate a specific instrument, eliminating the need to open sets

INSTRUMENT REPAIR RECORDS

- Generate instrument/equipment repair reports
- Review repair status
- Create repair/replacement requisitions automatically

INSTRUMENT INVENTORY

- Produce a complete instrument inventory
- Sort instrument inventory by instrument type, catalog number, description, vendor, set name and surgical specialty

DIGITAL IMAGE DATABASE

- More than 20,000 individual instrument images at your fingertips
- Import assembled set images
- Save time and reduce errors in new and replacement instrument ordering
- Train new employees more easily with identified instruments and sets

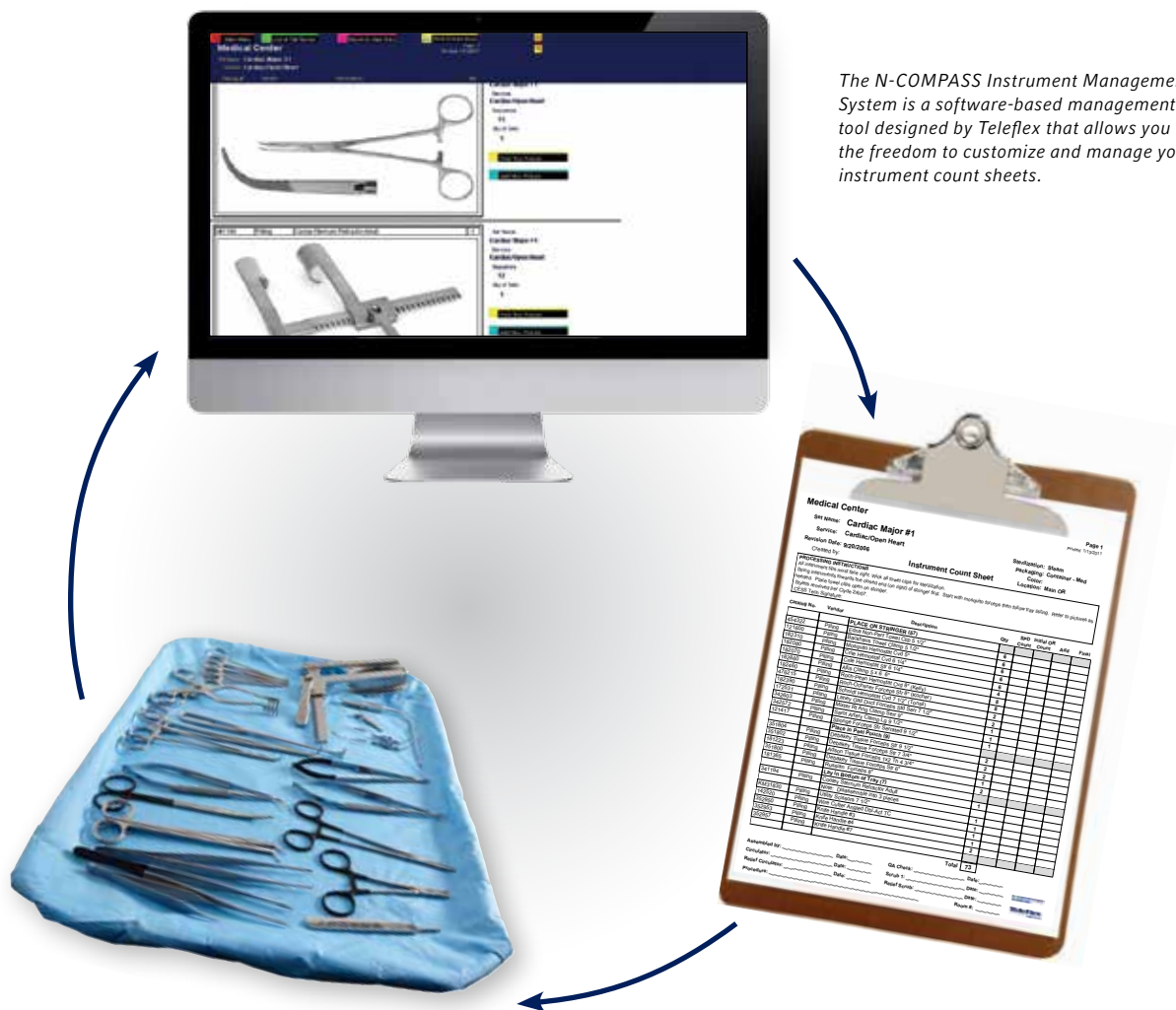

CROSS REFERENCE LIST

- Simplify instrument ordering by cross referencing instruments with leading suppliers

PRICING/BUDGETING

- Dollar values for each instrument, set and specialty
- Easy access to pricing to assist in budgeting and financial planning

REPORTS

- Generate staff productivity and set use reports
- Track data on set usage to help identify both high and low set usage

N-COMPASS SERVICES PROVIDED BY TELEFLEX:

- Software installation
- On-site physical set inventory
- Data entry and verification
- Digital images of Pilling®, Weck® and KMedic® Instruments
- Standardization of instrument patterns
- Customized count sheets
- On-site training



SCALES AND GAUGES

CONVERSION SCALE

TO CONVERT FROM	TO	MULTIPLY BY
Ounces (AVDP.)	Grams	28.349523
Ounces (APOTH.)	Grams	31.103486
Grains	Grams	0.06479891
Pounds (AVDP.)	Kilograms	0.45359237
Inches	Centimeters	2.54
Feet	Meters	0.3048
Yards	Meters	0.9144
Ounces (U.S. Fluid)	Cubic Centimeters	29.573730
Ounces (British Fluid)	Cubic Centimeters	28.41305
Quarts (U.S. Fluid)	Liters	0.9463264
Cubic Inches	Cubic Centimeters	16.387064
Grams	Grains	15.432358
Grams	Ounces (AVDP.)	0.35273962
Grams	Ounces (APOTH.)	0.32150737
Kilograms	Pounds (AVDP.)	2.2046226
Millimeters	Inches	0.039370079
Centimeters	Inches	0.39370079
Meters	Feet	3.2808399
Cubic Centimeters	Cubic Inches	0.61023744
Cubic Centimeters (Fluid)	Ounces (U.S. Fluid)	0.33814023
Liters	Quarts (U.S. Fluid)	1.056718

FAHRENHEIT AND CENTIGRADE SCALES

F°	C°
500	260
401	205
392	200
383	195
374	190
356	180
347	175
338	170
329	165
320	160
311	155
302	150
284	140
275	135
266	130
248	120
239	115
230	110
212	100
203	95
194	90
176	80
167	75
140	60
122	50
113	45
105	40.56
104	40
100	37.8
98.5	36.9
95	35
86	30
77	25
68	20
50	10
41	5
32	0
23	-5
14	-10
+5	-15
-4	-20
-13	-25
-22	-30
-40	-40
-76	-60

SCALES AND GAUGES

COMPARATIVE SCALES OR GAUGES

DIAMETERS IN MILLIMETERS	AMERICAN	FRENCH	ENGLISH
1/3		1	
1/2	1		
2/3		2	
1	2	3	
1-1/3		4	
1-1/2	3		
1-2/3		5	
2	4	6	
2-1/3		7	1
2-1/2	5		
2-2/3		8	2
3	6	9	3
3-1/3		10	
3-1/2	7		
3-2/3		11	4
4	8	12	5
4-1/3		13	
4-1/2	9		
4-2/3		14	
5	10	15	6
5-1/3		16	7
5-1/2	11		
5-2/3		17	8
6	12	18	9
6-1/3		19	10
6-1/2	13		
6-2/3		20	11

DIAMETERS IN MILLIMETERS	AMERICAN	FRENCH	ENGLISH
7	14	21	
7-1/3		22	12
7-1/2	15		
7-2/3		23	13
8	16	24	
8-1/3		25	14
8-1/2	17		
8-2/3		26	15
9	18	27	16
9-1/3		28	17
9-1/2	19		
9-2/3		29	
10	20	30	18
10-1/3		31	19
10-1/2	21		
10-2/3		32	20
11	22	33	21
11-1/3		34	22
11-1/2	23		
11-2/3		35	23
12	24	36	24
12-1/3		37	25
12-1/2	25		
12-2/3		38	26
13	26	39	27
13-1/3		40	28

MEASURING GUIDELINES AND COMMON JAW PATTERNS OF SURGICAL INSTRUMENTS

High quality, handcrafted instrument measurements will vary slightly. Instruments in this catalog are stainless steel unless otherwise noted.

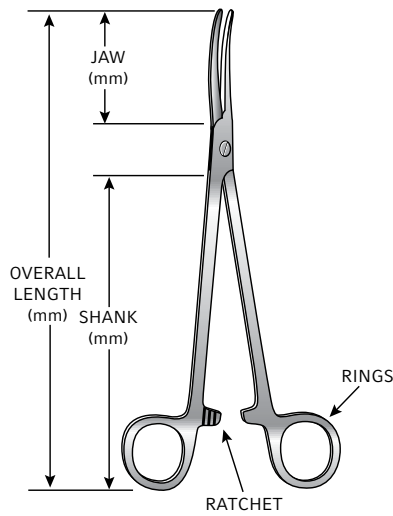

COMMON JAW SURFACES FOUND ON HEMOSTATS AND CLAMPS

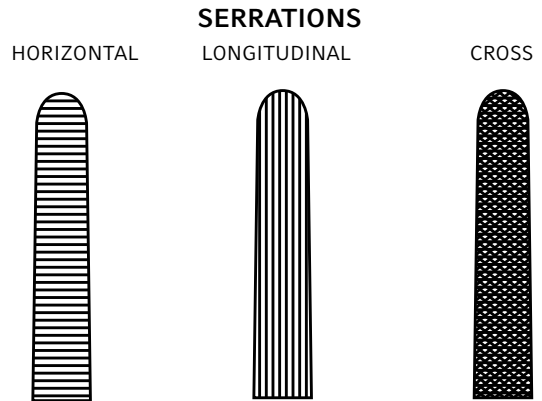

JAW CURVATURE

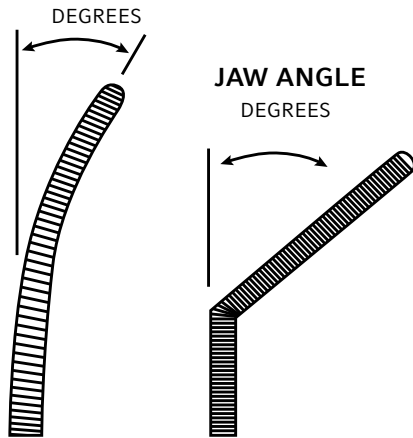

JAW CROSS SECTIONS

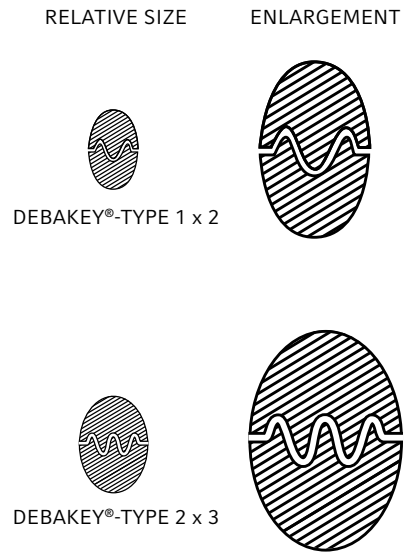

COMMON SURFACES FOUND ON NEEDLE HOLDERS WITH TUNGSTEN CARBIDE INSERTS

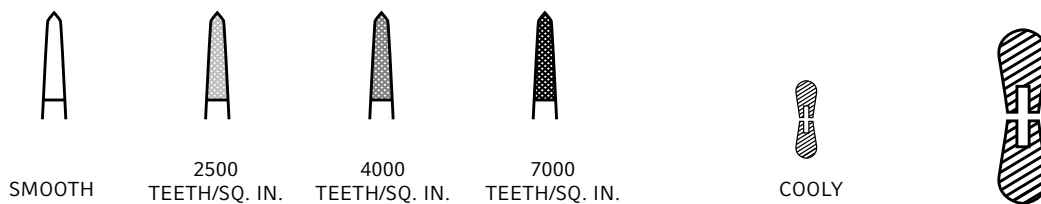

FROM INNER SURFACE OF SIDE BLADES

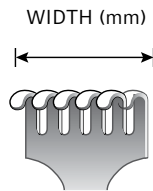
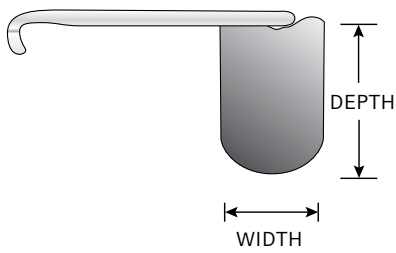
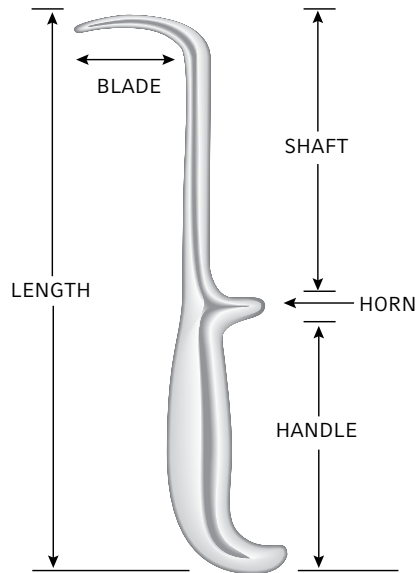
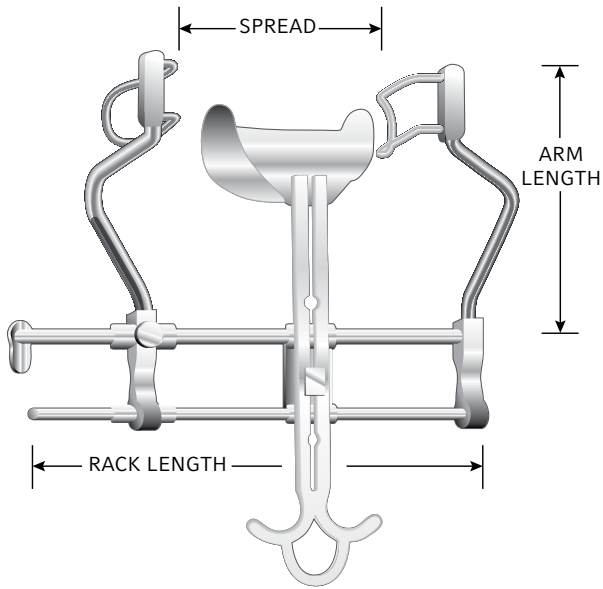

RING HANDLE

BLADE LENGTH

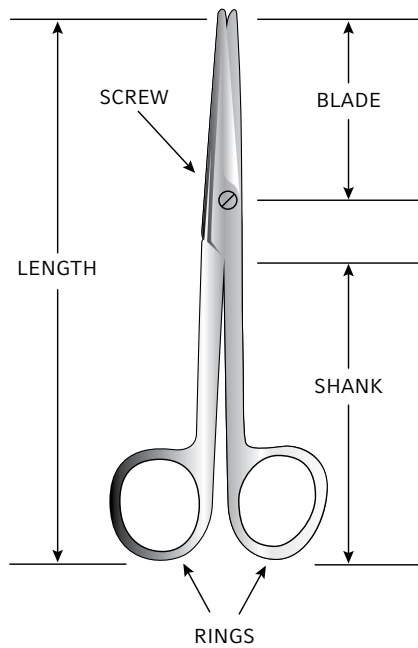
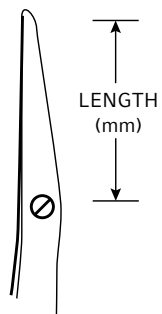

BLADE CURVATURE

DEGREES

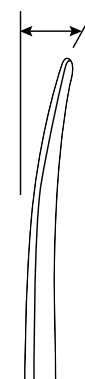





GENERAL INSTRUMENTS

Pilling® Surgical Innovation and Quality

CHAPTER OVERVIEW

It has been the innovations developed through the Pilling® Brand and responsiveness to the needs of healthcare professionals which have established Teleflex® as a leader in surgical instrumentation.

Today, in addition to the worldwide recognition for excellence achieved in the area of Cardiovascular, Thoracic and Ear/Nose/Throat surgical instrumentation, Teleflex® also provides a full range of Pilling® General Instrumentation manufactured to our traditionally high standards of quality and value.

PRODUCTS

Our extensive line of Pilling® General Instruments are made from German stainless steel and include the following:

- Scissors
- Needle Holders
- Hemostats
- Dressing, Sponge and Tissue Forceps
- Knife Handles
- Hand-Held, Self-Retaining Retractors
- Suction Tubes
- Extended-Length Instruments
- Trays
- And many more

FEATURED PRODUCT

Pilling® CircuTract Retracting System

- Maximum exposure for optimal visibility
- Compatible with all Bookwalter® Retractor Components
- Full complement of bariatric components
- Easy assembly

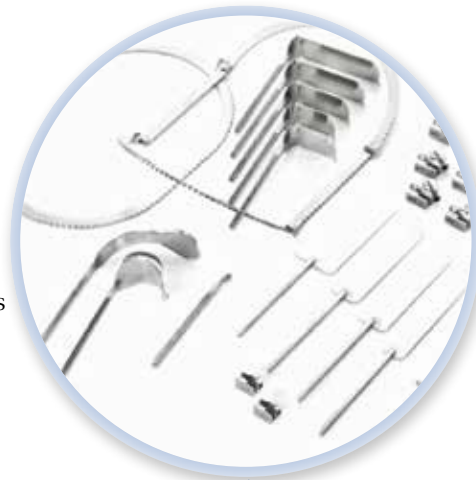

Bookwalter is a registered trademark of Specialty Surgical Instrumentation Inc.

KNIFE HANDLES

General

KNIFE HANDLES



352950



352951



352952



352953



352954



352957



352959

Correctly fit knife handle to standard surgical blades. The distal ends are tapered and beveled for use in blunt dissection. Each handle is contoured for firm grip, strength, manipulation and comfort. They are sold one handle each per package.

CATALOG #	DESCRIPTION
352950	Size 3, fits blade sizes 10, 11, 12 and 15
352951	Size 3L, fits blade sizes 10, 11, 12 and 15. Measures 8-3/8" (21.5 cm) not including blade.
352952	Size 3LA, fits blade sizes 10, 11, 12 and 15
352953	Size 4, fits blade sizes 20, 21, 22, 23, 24 and 25
352954	Size 4L, fits blade sizes 20, 21, 22, 23, 24 and 25. Measures 8-3/8" (21.5 cm) not including blade.
352957	Size 7, fits blade sizes 10, 11, 12 and 15
352959	Size 9, fits blade sizes 10, 11, 12 and 15



KNIFE HANDLES

General

ROUND SHAFT BEAVER BLADE HANDLES

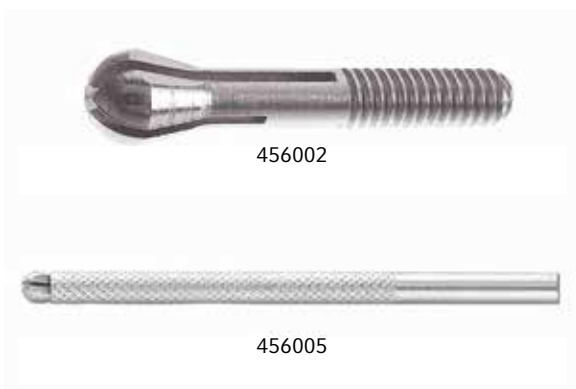

CATALOG #	DESCRIPTION
456002	Replacement collet
456005	#3KM, 2-31/32" (7.5 cm)
456006	#3K, 4-1/8" (10.5 cm)
456007	#3KL, 6" (15 cm)

Specialty

WEBSTER SKIN GRAFT KNIFE HANDLE



Use with blade no. 450205, 7-1/4" (18.5 cm).

CATALOG #	DESCRIPTION
050230	Handle only

GOULIAN SKIN GRAFT KNIFE SET



Includes: 1 Webster knife handle (050230), 5 Wecprep blades (450205), 3 depth gauges and guards (050203, 050204, 050205).

CATALOG #	DESCRIPTION
050200	Complete

KNIFE HANDLES

Specialty

GOULIAN DEPTH GAUGE AND GUARDS



050203

2-3/8" (6 cm). Use with Webster knife handle (050230), Wecprep blades (450205).

CATALOG #	DESCRIPTION
050201	0.004"
050202	0.006"
050203	0.008"
050204	0.010"
050205	0.012"
050206	0.014"
050207	0.016"
050208	0.018"
050209	0.020"
050211	0.024"
050212	0.026"
050213	0.028"

WECPREP BLADES



450205

Single edge carbon steel blade. Use with 050200 and 050230.

CATALOG #	DESCRIPTION
450205	2-1/4" (5.5 cm), carton of 50

HOLINGER LARYNGEAL KNIFE HANDLE



506705

For use with surgical blades no. 10, 11, 12 and 15.

CATALOG #	DESCRIPTION
506705	11" (28 cm)

FORCEPS AND CLAMPS

Sponge Forceps

BALLENGER SPONGE FORCEPS



121412

CATALOG #	DESCRIPTION
121410	Straight, smooth jaws, 7-1/4" (18.5 cm)
121412	Straight, serrated jaws, 7-1/4" (18.5 cm)
121422	Curved, serrated jaws, 7" (18 cm)

FOERSTER SPONGE FORCEPS



121417

Pilling® Pattern, satin finish.

CATALOG #	DESCRIPTION
121415	Straight, smooth jaws, 9-3/4" (25 cm)
121417	Straight, serrated jaws, 9-3/4" (25 cm)
121427	Curved, serrated jaws, 9-1/2" (24 cm)

FOERSTER SPONGE FORCEPS

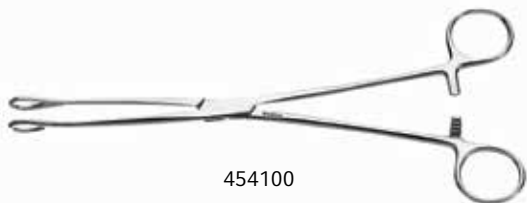

454100

Weck® Pattern, bright finish.

CATALOG #	DESCRIPTION
454100	Straight, cross serrated jaws, 9-1/2" (24 cm)

0 in

1

2

3

4

5

6

7

8

9

FORCEPS AND CLAMPS

Tubing Clamps

GUNNAR ROLLER CLAMPS

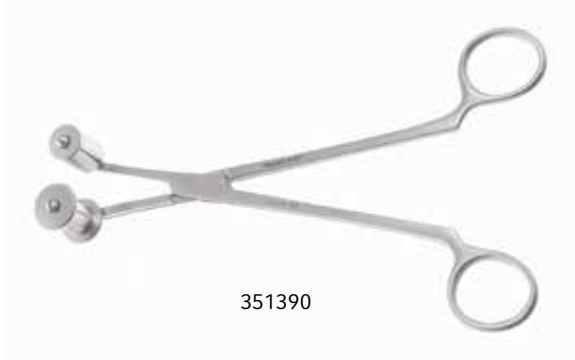

CATALOG #	DESCRIPTION
351390	For "milking" pump tubing 1/2" (12.5 mm) diameter, 7-1/8" (18 cm)

LORE TUBE HOLDING FORCEPS



Full serrations, serrated jaws grasp drape without puncturing. Fitting on shanks holds tubing securely and without drag when not in use. Suction tube may be stored in protective metal sleeve.

CATALOG #	DESCRIPTION
536275	Angled, 2.6 mm tip, 6-1/4" (16 cm)

MORSE TOWEL CLIP TUBING HOLDERS



For holding extracorporeal tubing to drapes giving positive fixation. The serrated inner surface of the tube holding ring closes down on the tubing but does not collapse or reduce the lumen. Sizes listed are for outside diameter of extracorporeal tubing.

CATALOG #	DESCRIPTION
351351	For 3/16" and 1/4" tubing
351352	For 5/16" and 3/8" tubing
351353	For 7/16" and 1/2" tubing
351354	For 9/16" and 5/8" tubing
351355	For 11/16" and 3/4" tubing

FORCEPS AND CLAMPS

Tubing Clamps

NICHOLS TUBING HOLDER

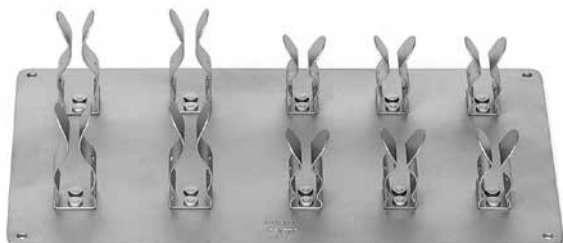

351370

Specially designed to hold and support the weight of the various diameters of tubing used by the pump-oxygenator, keeping them "in-line."

CATALOG #	DESCRIPTION
351370	4-1/2" x 7-1/4" (11.4 x 18.5 cm) metal plate is perforated so it may be held in place with towel clamps.

PRESBYTERIAN HOSPITAL TUBING CLAMP

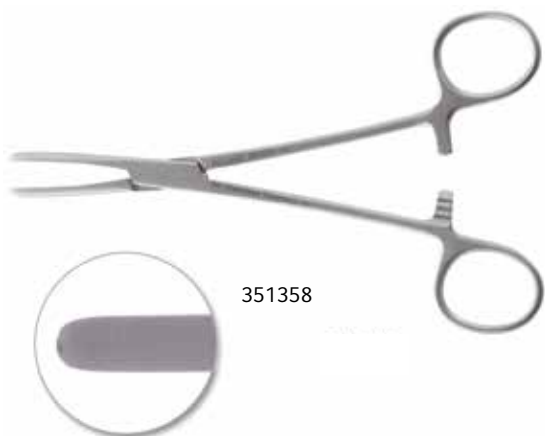

351358

Durable construction with smooth jaws for clamping off tubing without damage.

CATALOG #	DESCRIPTION
351358	6-1/2" (16.5 cm)

0 in

1

2

3

4

5

6

7

8

9

FORCEPS AND CLAMPS

Tubing Clamps

VORSE TUBING OCCLUDING CLAMPS



Heavy construction with jaws designed for positive occlusion of Silastic®, Tygon® and similar thick-walled tubings.

CATALOG #	DESCRIPTION
351373	For tubing 1/4" I.D. (3/8" O.D.), 6-1/8" (15.5 cm)
351374	For tubing 3/8" I.D. (5/8" O.D.), 7-3/8" (18.5 cm)
351375	For tubing 1/2" I.D. (7/8" O.D.), 8-1/8" (20.5 cm)

VORSE TUBING OCCLUDING CLAMPS WITH SAFETY GUARD



The familiar Vorse-type tube-occluding clamp supplied with a safety guard to prevent the box-lock from puncturing the tubing. Heavy construction with jaw designed for positive non-slip occlusion of Silastic®, Tygon® and similar thick-walled tubing.

CATALOG #	DESCRIPTION
351376	For tubing 1/4" I.D. (3/8" O.D.), 6-1/8" (15.5 cm)
351377	For tubing 3/8" I.D. (5/8" O.D.), 7-3/8" (18.5 cm)
351378	For tubing 1/2" I.D. (7/8" O.D.), 8-1/8" (20.5 cm)



FORCEPS AND CLAMPS

Towel Clamps

EDNA TOWEL FORCEPS



Pilling® Pattern, satin finish.

CATALOG #	DESCRIPTION
121655	Single row of non-penetrating teeth, 5-1/2" (14 cm)
121656	4" (10 cm)

EDNA NON-PERFORATING TOWEL CLAMPS



Weck® Pattern, bright finish.

CATALOG #	DESCRIPTION
454320	3-3/4" (9.5 cm)
454322	5-3/8" (13.5 cm)

FORCEPS AND CLAMPS

Towel Clamps

BACKHAUS TOWEL CLAMPS



Weck® Pattern, bright finish.

CATALOG #	DESCRIPTION
454300	3-1/2" (9 cm)
454305	5-1/4" (13.5 cm)

BACKHAUS TOWEL FORCEPS



Pilling® Pattern, satin finish.

CATALOG #	DESCRIPTION
121605	3-1/2" (9 cm)
121600	5-1/4" (13.5 cm)

BACKHAUS TOWEL FORCEPS



CATALOG #	DESCRIPTION
447050	3-1/2" (9 cm)

FORCEPS AND CLAMPS

Towel Forceps

JONES CROSS-ACTION TOWEL FORCEPS



121640

CATALOG #	DESCRIPTION
121640	3-1/2" (9 cm)

PEERS TOWEL FORCEPS



121650

Double opposing row of non-penetrating teeth.

CATALOG #	DESCRIPTION
121650	5-3/4" (14.5 cm)

ROEDER TOWEL FORCEPS



121610

CATALOG #	DESCRIPTION
121610	With ball stops, 5-1/4" (13.5 cm)

0 in

1

2

3

4

5

6

7

8

9

FORCEPS AND CLAMPS

Splinter Forceps

CARMALT SPLINTER FORCEPS



KM39412

CATALOG #	DESCRIPTION
KM39410	Straight, serrated, 4-3/8" (11 cm)
KM39412	Curved, serrated, 4-3/8" (11 cm)

FEILCHENFELD SPLINTER FORCEPS



KM39386

CATALOG #	DESCRIPTION
KM39386	Straight, serrated, 3-1/4" (8.5 cm)
KM39390	Straight, serrated, 4-1/2" (11.5 cm)

PLAIN SPLINTER FORCEPS



KM39364

CATALOG #	DESCRIPTION
KM39364	Straight, serrated, 3-1/2" (9 cm)
KM39366	Straight, serrated, 0.6 mm tip, 4-1/2" (11.5 cm)

SPLINTER FORCEPS



181559

CATALOG #	DESCRIPTION
181556	Straight, serrated, 3-1/8" (8 cm)
181557	Straight, serrated, 4" (10 cm)
181559	Straight, serrated, 5" (12.5 cm)



FORCEPS AND CLAMPS

Splinter Forceps

VANGUARD SPLINTER LIBERATOR



KM39534

CATALOG #	DESCRIPTION
KM39534	Trocar in reversible handle, 5" (12.5 cm)
KM39536	Trocar point only

VIRTUS SPLINTER FORCEPS



KM39478

CATALOG #	DESCRIPTION
KM39478	Straight, serrated, 6" (15 cm)

WILLIAMS SPLINTER FORCEPS



KM39509



KM39511



KM39513

CATALOG #	DESCRIPTION
KM39509	Straight, serrated, 5-1/2" (14 cm)
KM39511	45 degree angled, serrated, 5-1/4" (13.5 cm)
KM39513	90 degree angled, serrated, 5-1/2" (14 cm)

FORCEPS AND CLAMPS

Dressing Forceps

THUMB DRESSING FORCEPS



181106

Pilling® Pattern, satin finish. Standard, serrated tips.

CATALOG #	DESCRIPTION
181102	2.7 mm tip, 5" (12.5 cm)
181104	3.4 mm tip, 5-1/2" (14 cm)
181106	3.5 mm tip, 6" (15 cm)
181108	4 mm tip, 7-1/4" (18.5 cm)

THUMB DRESSING FORCEPS



465115

Weck® Pattern, bright finish. Standard, serrated tips.

CATALOG #	DESCRIPTION
465100	2.6 mm tip, 4-5/8" (11.5 cm)
465105	2.7 mm tip, 5" (12.5 cm)
465110	3 mm tip, 5-5/8" (14.5 cm)
465115	3.5 mm tip, 6-1/4" (16 cm)
465120	3.6 mm tip, 7-7/8" (20 cm)
465125	4 mm tip, 9-7/8" (25 cm)
465130	4.7 mm tip, 12" (30.5 cm)

THUMB FORCEPS



465160

Weck® Pattern, bright finish. Narrow, serrated tips.

CATALOG #	DESCRIPTION
465150	2 mm tip, 4-5/8" (11.5 cm)
465155	2 mm tip, 5" (12.5 cm)
465160	2 mm tip, 5-5/8" (14.5 cm)
465165	2 mm tip, 6" (15 cm)
465170	2.1 mm tip, 7-7/8" (20 cm)

ADSON DRESSING FORCEPS



181220

Pilling® Pattern, satin finish.

CATALOG #	DESCRIPTION
181220	4-3/4" (12 cm)

FORCEPS AND CLAMPS

Dressing Forceps

ADSON DRESSING FORCEPS



057200

Weck® Pattern, serrated tip.

CATALOG #	DESCRIPTION
057200	Standard, 1.3 mm tip, 4-3/4" (12 cm)
057202	Delicate, 1.2 mm tip, 5" (12.5 cm)

ADSON DRESSING FORCEPS TC



057205

Weck® Pattern, tungsten carbide.

CATALOG #	DESCRIPTION
057205	Standard, 4-3/4" (12 cm), TC

ADSON DRESSING FORCEPS



KM39060

KMedic® Pattern.

CATALOG #	DESCRIPTION
KM39058	Micro tip, serrated, 1 mm tip, 4-3/4" (12 cm)
KM39060	Delicate, serrated, 1.2 mm tip, 4-3/4" (12 cm)
KM39062	Standard tip, serrated, 4-3/4" (12 cm)
KM39059	Micro serrated, 1 mm tip, 6" (15 cm)
KM39052	Serrated, 1.2 mm tip, 6" (15 cm)

EWALD DRESSING FORCEPS



181237

Pilling® Pattern, satin finish. Delicate tips designed for careful handling of tissue. Handles are broad for comfortable, secure grasp.

CATALOG #	DESCRIPTION
181237	Serrated, 4-3/4" (12 cm)

FORCEPS AND CLAMPS

Dressing Forceps

ADSON LASER TISSUE FORCEPS

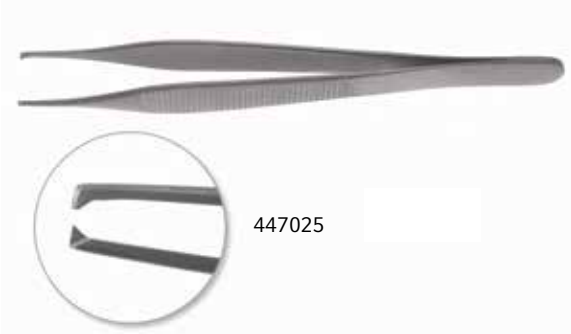

Ebonized.

CATALOG #	DESCRIPTION
447025	1 x 2 teeth, 4-3/4" (12 cm)

CUSHING DRESSING FORCEPS



181410

Serrated handles, scraper end.

CATALOG #	DESCRIPTION
181410	Straight, serrated tips, 7" (18 cm)

CUSHING DRESSING FORCEPS TC



351860

CATALOG #	DESCRIPTION
351860	Straight, 6-7/8" (17.5 cm), TC

CUSHING DRESSING FORCEPS



466200

Weck® Pattern, bright finish.

CATALOG #	DESCRIPTION
466200	Straight, serrated, 1.5 mm tip, 7" (18 cm)

CUSHING GUTSCH DRESSING FORCEPS



466211

Tungsten carbide.

CATALOG #	DESCRIPTION
466211	Serrated, 1.8 mm tip, 6-7/8" (17.5 cm), TC
466210	Serrated, 1.6 mm tip, 7" (18 cm), TC



FORCEPS AND CLAMPS

Dressing Forceps

CUSHING BAYONET DRESSING FORCEPS



CATALOG #	DESCRIPTION
351861	7-1/2" (19 cm), TC

CUSHING GUTSCH BAYONET DRESSING FORCEPS



Serrated handles, scraper end.

CATALOG #	DESCRIPTION
466220	Serrated, 1.5 mm tip, 7-1/4" (18.5 cm)

GERALD DRESSING FORCEPS



These are full-size dressing forceps with only the distal portion narrowed to provide light, delicate tips that maintain alignment.

CATALOG #	DESCRIPTION
351900	Serrated, 7" (18 cm)
351902	Serrated, 9-3/4" (25 cm)

GERALD DRESSING FORCEPS TC



CATALOG #	DESCRIPTION
466225	Straight, serrated, 1.1 mm tip, 6-7/8" (17.5 cm), TC

FORCEPS AND CLAMPS

Dressing Forceps

IRIS DRESSING FORCEPS



CATALOG #	DESCRIPTION
181600	Straight, 4" (10 cm)
181602	Slightly curved, 4" (10 cm)

DRESSING FORCEPS



CATALOG #	DESCRIPTION
KM38082	Curved, fine point serrated, 5" (12.5 cm)

GRUENWALD BAYONET FORCEPS



CATALOG #	DESCRIPTION
466151	Serrated, 2.3 mm tip, 8-3/8" (21.5 cm)

FORCEPS AND CLAMPS

Dressing Forceps

JANSEN BAYONET DRESSING FORCEPS



466150

CATALOG #	DESCRIPTION
KM55100	Serrated, 2.1 mm tip, 6-1/4" (16 cm)
466150	Serrated, 2.4 mm tip, 7-5/8" (19.5 cm)

LUCAE BAYONET DRESSING FORCEPS



027100

CATALOG #	DESCRIPTION
027100	Delicate, 1.5 mm tip, 5-1/2" (14 cm)

LUCAE BAYONET DRESSING FORCEPS



031100

CATALOG #	DESCRIPTION
031100	Serrated, 2 mm tip, 6-1/2" (16.5 cm)

THUMB BAYONET DRESSING FORCEPS



395118

CATALOG #	DESCRIPTION
395118	Angled, smooth, 7-1/4" (18.5 cm)

0 in

1

2

3

4

5

6

7

8

9

FORCEPS AND CLAMPS

Dressing Forceps

NEVINS FORCEPS



CATALOG #	DESCRIPTION
466160	Straight, 1.5 mm serrated tip, 6-3/4" (17 cm)

POTTS-SMITH DRESSING FORCEPS



Fine, serrated tips.

CATALOG #	DESCRIPTION
351850	7-1/4" (18.5 cm)
351852	8-1/4" (21 cm)
351854	9-5/8" (24.5 cm)
351856	10-1/4" (26 cm)
351858	11-7/8" (30 cm)

POTTS-SMITH TECHNIQUE® DRESSING FORCEPS

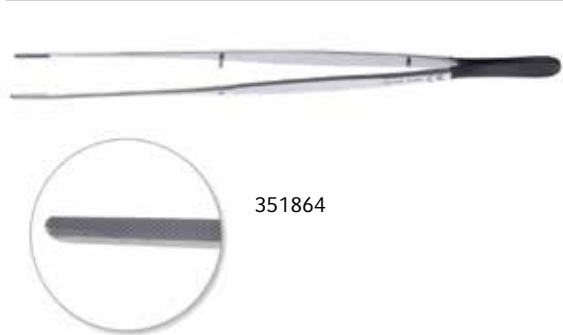

Narrow, serrated, TC tips.

CATALOG #	DESCRIPTION
351862	7" (18 cm), TC
351863	8" (20.5 cm), TC
351864	9-3/4" (25 cm), TC
351865	10-1/4" (26 cm), TC

FORCEPS AND CLAMPS

Dressing Forceps

BRIGHAM DRESSING FORCEPS



466170

CATALOG #	DESCRIPTION
466170	Serrated, 1.7 mm dissecting tip, 6-1/8" (15.5 cm)

SEMKEN DRESSING FORCEPS



KM39086

CATALOG #	DESCRIPTION
181270	Serrated, 5" (12.5 cm)
KM39086	Serrated, 1.8 mm tip, 6" (15 cm)

Tissue Forceps

THUMB TISSUE FORCEPS



181131

Pilling® Pattern, satin finish. 1 x 2 teeth.

CATALOG #	DESCRIPTION
181127	2 mm tip, 5" (12.5 cm)
181129	2.6 mm tip, 5-1/2" (14 cm)
181131	2.4 mm tip, 6" (15 cm)
181133	3.3 mm tip, 7-1/4" (18.5 cm)
181139	3.4 mm tip, 11-3/4" (30 cm)

THUMB TISSUE FORCEPS



181166

Pilling® Pattern, satin finish.

CATALOG #	DESCRIPTION
181155	1 x 2 teeth, extra-fine 2.6 mm tip, 5-1/2" (14 cm)
181166	2 x 3 teeth, 6-1/4" (16 cm)

0 in

1

2

3

4

5

6

7

8

9

FORCEPS AND CLAMPS

Tissue Forceps

TISSUE FORCEPS



KMedic® Pattern, satin finish.

CATALOG #	DESCRIPTION
KM38304	3 x 4 teeth, 5-1/2" (14 cm)



KM38304

THUMB TISSUE FORCEPS



Weck® Pattern, bright finish. 1 x 2 teeth.

CATALOG #	DESCRIPTION
467100	2.0 mm tip, 4-1/2" (11.5 cm)
467105	2.2 mm tip, 5" (12.5 cm)
467110	2.2 mm tip, 5-5/8" (14.5 cm)
467115	2.3 mm tip, 6-1/4" (16 cm)
467120	2.7 mm tip, 8" (20.5 cm)
467125	3.4 mm tip, 9-5/8" (24.5 cm)

467115

TISSUE FORCEPS



Pilling® Pattern, satin finish.

CATALOG #	DESCRIPTION
181310	1.5 mm tip, 1 x 2 teeth, serrated, 6" (15 cm)

181310

FORCEPS AND CLAMPS

Tissue Forceps

ADSON TISSUE FORCEPS



181228

Pilling® Pattern, satin finish.

CATALOG #	DESCRIPTION
181223	1 x 2 teeth, 4-3/4" (12 cm)
181225	2 x 3 teeth, 5" (12.5 cm)
181228	1 x 2 teeth, serrated, 4-3/4" (12 cm)

ADSON TISSUE FORCEPS



057207

Weck® Pattern, bright finish.

CATALOG #	DESCRIPTION
057207	1 x 2 teeth, 1.3 mm tip, 4-3/4" (12 cm)
057210	Standard, 1 x 2 teeth, 1.4 mm tip, 4-3/4" (12 cm)
057212	Delicate, 1 x 2 teeth, 1.2 mm tip, 5" (12.5 cm)
057214	Delicate, serrated, 1 x 2 teeth, 1.3 mm tip, 4-7/8" (12.5 cm)
057230	2 x 3 teeth, 2 mm tip, 5" (12.5 cm)



057210



FORCEPS AND CLAMPS

Tissue Forceps

CALLISON-ADSON TISSUE FORCEPS



057220

Weck® Pattern, bright finish.

CATALOG #	DESCRIPTION
057220	1 x 2 teeth with tying platform, 1.3 mm tip, 4-3/4" (12 cm)

ADSON TISSUE FORCEPS



KM39057

KMedic® Pattern, satin finish.

CATALOG #	DESCRIPTION
KM39056	Micro 1 x 2 teeth, 0.8 mm tip, 4-3/4" (12 cm)
KM39057	Micro 1 x 2 teeth, 0.9 mm tip, 6" (15 cm)
KM39064	Delicate 1 x 2 teeth, 4-3/4" (12 cm)
KM39050	1 x 2 teeth, 1.2 mm tip, 6" (15 cm)

ADSON-DEBAKEY® TISSUE FORCEPS



KM39054

KMedic® Pattern, satin finish. DeBakey® Teeth.

CATALOG #	DESCRIPTION
KM39054	1.5 mm tip, 4-3/4" (12 cm)

BROWN-ADSON TISSUE FORCEPS



181235

Pilling® Pattern, satin finish. Delicate tips designed for careful handling of tissue. Handles are broad for comfortable, secure grasp.

CATALOG #	DESCRIPTION
181235	9 x 9 teeth, 4-3/4" (12 cm)

BROWN-ADSON TISSUE FORCEPS



057250

Weck® Pattern, satin finish.

CATALOG #	DESCRIPTION
057250	7 x 7 teeth, 2 mm tip, 4-3/4" (12 cm)

FORCEPS AND CLAMPS

Tissue Forceps

ADSON BROWN LASER TISSUE FORCEPS



Ebonized.

CATALOG #	DESCRIPTION
447030	Straight, 9 x 9 teeth, 4-3/4" (12 cm)

EWALD TISSUE FORCEPS



Pilling® Pattern, satin finish. Delicate tips designed for careful handling of tissue. Handles are broad for comfortable, secure grasp.

CATALOG #	DESCRIPTION
181240	1 x 2 teeth, 4-3/4" (12 cm)

HUDSON TISSUE FORCEPS



CATALOG #	DESCRIPTION
057215	1 x 2 teeth, heavy, 1.5 mm tip, 5" (12.5 cm)

FORCEPS AND CLAMPS

Tissue Forceps

BEASLEY-BABCOCK TISSUE FORCEPS



CATALOG #	DESCRIPTION
057302	6 x 6 teeth, 5-1/4" (13.5 cm)

BONNEY TISSUE FORCEPS



Strong, rugged construction. Serrated tying platform. Non-slip handles.

CATALOG #	DESCRIPTION
640524	1 x 2 teeth, 3.3 mm tip, 6-3/4" (17 cm)
181327	2 x 3 teeth, 6-3/4" (17 cm)

BROWN TISSUE FORCEPS



Small 9 x 9 sets of teeth run longitudinally along narrow jaws.

CATALOG #	DESCRIPTION
181255	6" (15 cm)
342965	8" (20.5 cm)
342967	9-1/2" (24 cm)

FORCEPS AND CLAMPS

Tissue Forceps

CUSHING BAYONET TISSUE FORCEPS



468240

Serrated handles, scraper end.

CATALOG #	DESCRIPTION
468240	1 x 2 teeth, 7-1/4" (18.5 cm)

CUSHING GUTSCH TISSUE FORCEPS



468230

CATALOG #	DESCRIPTION
468230	1 x 2 teeth, serrated, 7" (18 cm)

CUSHING TISSUE FORCEPS



468220

CATALOG #	DESCRIPTION
468220	1 x 2 teeth, serrated, 7" (18 cm)

DEBAKEY® THORACIC TISSUE FORCEPS



342980

The row of 1 x 2 DeBakey®-type serrations on the tips are designed to be large and strong enough to handle relatively large masses of tissue. Because of the groove construction and light spring tension, they may be used to hold and handle suture material as well. These forceps are of heavier design than the DeBakey® Vascular Tissue Forceps (351800 through 351814 on pg. 50). The distal portion is tapered to a 3 mm DeBakey®-type tip.

CATALOG #	DESCRIPTION
342980	Straight, 3 mm tip, 6-1/8" (15.5 cm)
342981	Straight, 3 mm tip, 7-3/4" (19.5 cm)
342982	Straight, 3 mm tip, 9-1/2" (24 cm)
342984	Straight, 3 mm tip, 12" (30.5 cm)
342986	Angled, 3 mm tip, 12" (30.5 cm)

342986

FORCEPS AND CLAMPS

Tissue Forceps

DEBAKEY® VASCULAR TISSUE FORCEPS



351800



351810

Standard. The distal 2 cm of these forceps is a narrow DeBakey®-type serration with a width of 2 mm. The body of the instrument is constructed especially to prevent feathering, and all pins and projections have been omitted to help eliminate suture catchers. Jaws are very well-fitted for handling tiny vessels as well as the smallest suture material.

CATALOG #	DESCRIPTION
351800	Straight, 2 mm tip, 6" (15 cm)
351802	Straight, 2 mm tip, 7-3/4" (19.5 cm)
351804	Straight, 2 mm tip, 9-1/2" (24 cm)
351808	Straight, 2 mm tip, 12" (30.5 cm)
351810	Angled, 2 mm tip, 6" (15 cm)
351812	Angled, 2 mm tip, 7-3/4" (19.5 cm)
351814	Angled, 2 mm tip, 9-1/2" (24 cm)

DEBAKEY®-DIETRICH DELICATE VASCULAR TISSUE FORCEPS



351803

Designed for micro-vascular and coronary artery surgery. The distal portion is tapered to a 1 mm extra-fine DeBakey®-type serration.

CATALOG #	DESCRIPTION
351801	Straight, delicate, 1 mm tip, 6" (15 cm)
351803	Straight, delicate, 1 mm tip, 7-3/4" (19.5 cm)
351806	Straight, delicate, 1 mm tip, 9-1/2" (24 cm)

DEBAKEY® ULTRALIGHT FORCEPS



351821

Approximately one-half the weight of standard DeBakey® Forceps, similar to that of titanium but at a much lower price. Ebonized stainless steel to reduce glare. Reduced tension minimizes fatigue and allows better control of delicate tissues.

CATALOG #	DESCRIPTION
351820	1.5 mm tip, 6" (15 cm)
351821	1.5 mm tip, 7-3/4" (19.5 cm)

FORCEPS AND CLAMPS

Tissue Forceps

DEBAKEY® CARBIDE FORCEPS



351817

DeBakey®-type serrations at distal tip. Tungsten carbide insert behind the jaw for secure needle pulling actions.

CATALOG #	DESCRIPTION
351815	Regular forceps, 6" (15 cm), TC
351817	Regular forceps, 7-3/4" (19.5 cm), TC
351818	Delicate forceps, 7-3/4" (19.5 cm), TC
351819	Regular forceps, 9-1/2" (24 cm), TC
351824	Delicate forceps, 9-1/2" (24 cm), TC



351818

VASCULAR DEBAKEY® BAYONET TISSUE FORCEPS



351845

DeBakey®-type serrations with a bayonet shape. Angled handles for difficult access and increased visibility.

CATALOG #	DESCRIPTION
351845	Fine, 1.3 mm tip, 7-3/4" (19.5 cm)
351843	Standard, 2.0 mm tip, 7-3/4" (19.5 cm)



351843

0 in

1

2

3

4

5

6

7

8

9



FORCEPS AND CLAMPS

Tissue Forceps

DEBAKEY® TITANIUM TISSUE FORCEPS

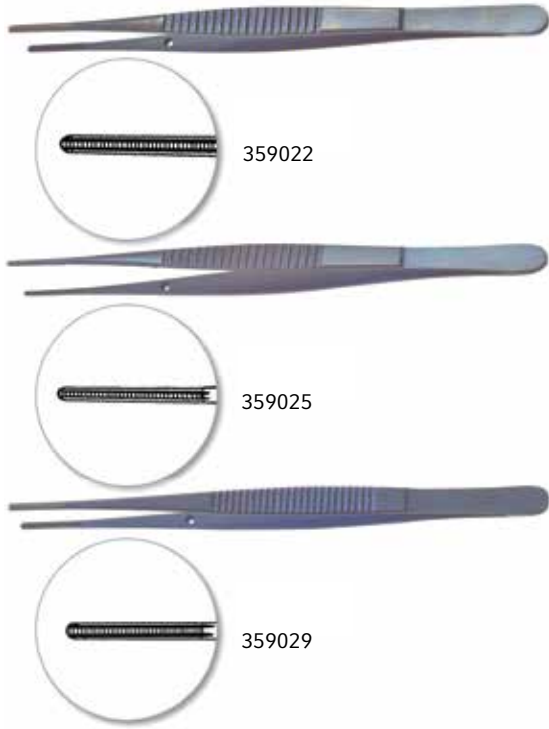

CATALOG #	DESCRIPTION
359024	Straight, flat handle, 1.5 mm jaw width, 6" (15 cm)
359025	Straight, flat handle, 1.5 mm jaw width, 7-5/8" (19.5 cm)
359021	Straight, flat handle, 2.5 mm jaw width, 6" (15 cm)
359022	Straight, flat handle, 2.5 mm jaw width, 7-5/8" (19.5 cm)
359027	Straight, flat handle, 3 mm jaw width, 6" (15 cm)
359028	Straight, flat handle, 3 mm jaw width, 7-5/8" (19.5 cm)
359029	Straight, flat handle, 3 mm jaw width, 9-1/2" (24 cm)
359030	Angular, flat handle, 2.5 mm jaw width, 5-7/8" (15 cm)
359031	Angular, flat handle, 2.5 mm jaw width, 7-1/2" (19 cm)
359032	Angular, flat handle, 2.5 mm jaw width, 9-1/4" (23.5 cm)

FERRIS SMITH TISSUE FORCEPS



CATALOG #	DESCRIPTION
468190	2 x 3 teeth with 4 mm serrated tying platform. 6-7/8" (17.5 cm)

GERALD TISSUE FORCEPS



These are full-size tissue forceps with only the distal portion narrowed to provide light, delicate tips that maintain alignment.

CATALOG #	DESCRIPTION
351905	1 x 2 teeth, 7" (18 cm)
351907	1 x 2 teeth, 9-3/4" (25 cm)



FORCEPS AND CLAMPS

Tissue Forceps

GERALD DEBAKEY® TISSUE FORCEPS

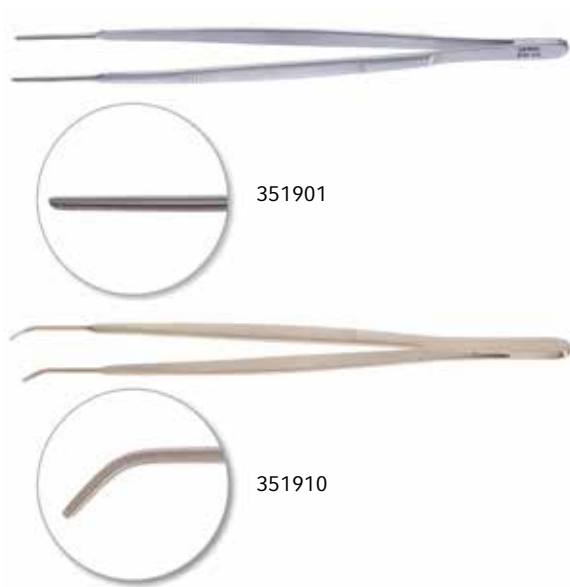

Delicate, tapered DeBakey®-type serrations.

CATALOG #	DESCRIPTION
351901	7" (18 cm)
351908	8" (20.5 cm)
351909	9-1/2" (24 cm)
351910	Angled, 6-7/8" (17.5 cm)

GRAEFE TISSUE FORCEPS



CATALOG #	DESCRIPTION
181250	5 x 6 teeth, 4-3/8" (11 cm)

FORCEPS AND CLAMPS

Tissue Forceps

IRIS TISSUE FORCEPS

Delicate.

CATALOG #	DESCRIPTION
181610	Straight, 1 x 2 teeth, 4" (10 cm)
181614	Full curve, 1 x 2 teeth, 3-3/4" (9.5 cm)
181604	Full curve, 3-3/4" (9.5 cm)



181610



181614

SEMKEN TISSUE FORCEPS

These delicate forceps are midway in size between Iris forceps and delicate standard tissue forceps.

CATALOG #	DESCRIPTION
181272	1 x 2 teeth, 5" (12.5 cm)
KM39088	1 x 2 teeth, 6-1/4" (16 cm)



181272

FORCEPS AND CLAMPS

Tissue Forceps

NELSON TISSUE FORCEPS



CATALOG #	DESCRIPTION
342950	6 x 7 sharp, fine teeth, 9" (23 cm)

SINGLEY TISSUE FORCEPS



Serrated ring end 8.5 mm wide. Medium-heavy construction.

CATALOG #	DESCRIPTION
342933	9" (23 cm)

ADAMS TISSUE FORCEPS



CATALOG #	DESCRIPTION
351835	Delicate, 1 mm tip, 8" (20.5 cm), TC

TUTTLE THORACIC TISSUE FORCEPS



Light construction. Ring tips 6.8 mm wide.

CATALOG #	DESCRIPTION
342935	9" (23 cm)

0 in

1

2

3

4

5

6

7

8

9

FORCEPS AND CLAMPS

Tissue Forceps

CORONARY ULTRA-FINE TISSUE FORCEPS



351838

Tungsten carbide.

CATALOG #	DESCRIPTION
351837	7" (18 cm), TC
351838	8" (20.5 cm), TC
351839	9" (23 cm), TC

WHEELER TECHNIQUE® PLAQUE AND VESSEL FORCEPS



351827

Very powerful grip at tip.

CATALOG #	DESCRIPTION
351825	DeBakey®-type jaw, 1.6 mm, 5-1/2" (14 cm)
351827	DeBakey®-type jaw, 1.6 mm, 7-1/8" (18 cm)
351829	DeBakey®-type jaw, 1.6 mm, 8-3/4" (22 cm)

CRAFOORD TISSUE FORCEPS



351898

Serrated tips are built up to provide an unusually secure grip.

CATALOG #	DESCRIPTION
351898	Serrated, 8" (20.5 cm)

POTTS-SMITH TISSUE FORCEPS



351872

Fine, serrated, 1 x 2 distal teeth.

CATALOG #	DESCRIPTION
351870	7-1/4" (18.5 cm)
351872	8-1/4" (21 cm)
351874	9-1/2" (24 cm)
351876	10-1/4" (26 cm)

FORCEPS AND CLAMPS

Tissue Forceps

RUSSIAN TISSUE FORCEPS



CATALOG #	DESCRIPTION
181360	6" (15 cm)
181365	8" (20.5 cm)
181370	10" (25.5 cm)

C.W. MAYO TISSUE FORCEPS



Russian-type fenestrated tips are 6.7 mm wide and deeply serrated.

CATALOG #	DESCRIPTION
342910	9" (23 cm)

DAVIS TISSUE FORCEPS



Russian-type jaws, 7.5 mm wide.

CATALOG #	DESCRIPTION
342915	Straight, serrated, 10" (25.5 cm)

SELMAN TISSUE FORCEPS



Small diameter circular tips have meshing teeth for secure, non-damaging grip.

CATALOG #	DESCRIPTION
351840	6" (15 cm)
351841	8" (20.5 cm)
351842	10" (25.5 cm)

FORCEPS AND CLAMPS

Hemostatic Forceps and Clamps

ADSON HEMOSTATIC FORCEPS



30 mm jaw, 2 mm tip, two-thirds serrations.

CATALOG #	DESCRIPTION
477190	Straight, 7-1/2" (19 cm)
477191	Curved, 7-1/8" (18 cm)

PILLING® THORACIC ARTERY FORCEPS

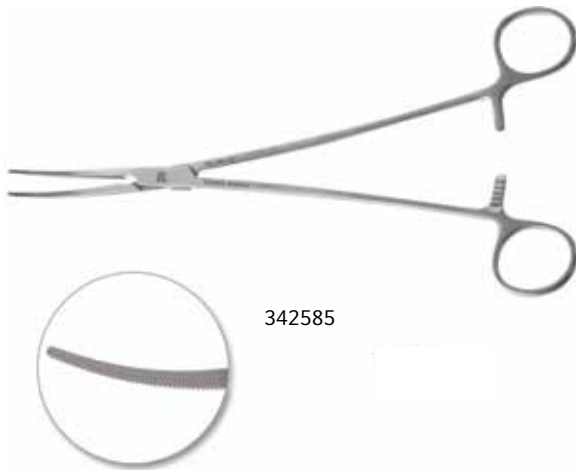

Slim, slightly curved jaws have very light criss-cross serrations making this an excellent instrument for handling suture material as well as delicate tissue.

CATALOG #	DESCRIPTION
342585	Serrated, 2" (5 cm) tip length, 2 mm tip width, 9-1/4" (23.5 cm)

FORCEPS AND CLAMPS

Hemostatic Forceps and Clamps

LEJEUNE THORACIC FORCEPS

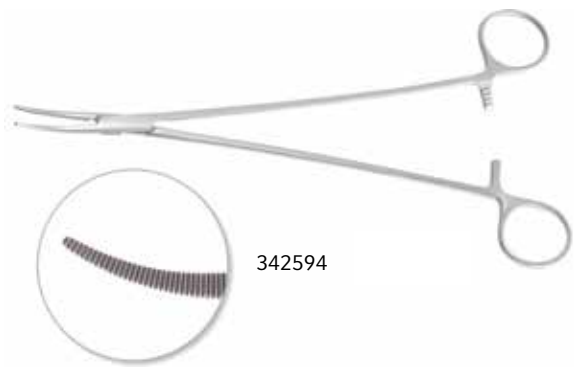

CATALOG #	DESCRIPTION
342594	Slightly curved, serrated, 1-3/8" (3.5 cm) tip length, 1.8 mm tip width, 9-3/8" (24 cm)

BENGOLEA FORCEPS



Lightweight, with narrow, criss-cross serrated jaws.

CATALOG #	DESCRIPTION
342587	Slightly curved, serrated, 2 mm wide tip, 8-1/2" (21.5 cm)

BRIDGE HEMOSTATIC FORCEPS

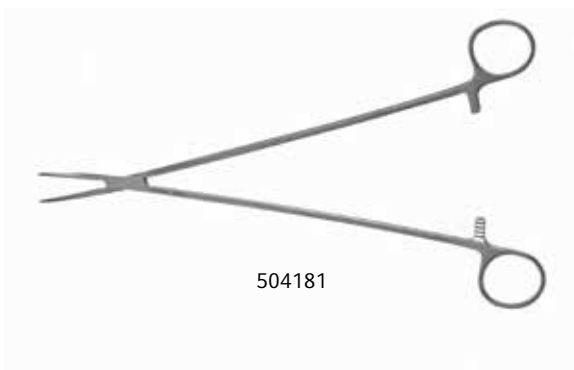

32 mm serrated jaw.

CATALOG #	DESCRIPTION
504180	Straight, 2 mm tip, 11-1/8" (28.5 cm)
504181	Curved, 2 mm tip, 11" (28 cm)
540111	Curved, 1.6 mm tip, 6-7/8" (17.5 cm)

0 in

1

2

3

4

5

6

7

8

9

FORCEPS AND CLAMPS

Hemostatic Forceps and Clamps

CARMALT FORCEPS

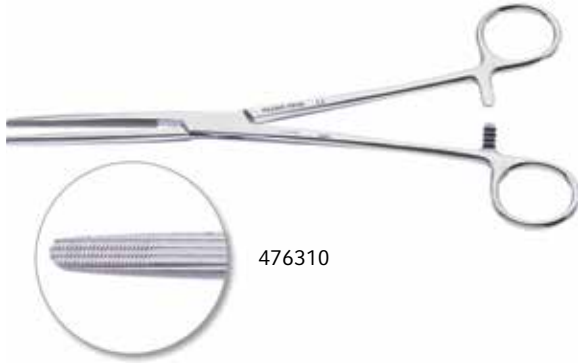

Cross-serrated tip with longitudinally serrated jaw.

CATALOG #	DESCRIPTION
476300	Straight, 43 mm jaw, 3 mm tip, 6-1/2" (16.5 cm)
476310	Straight, 58 mm jaw, 4 mm tip, 8-1/4" (21 cm)
476330	Curved, 43 mm jaw, 3 mm tip, 6-1/2" (16.5 cm)
476340	Curved, 58 mm jaw, 4 mm tip, 8-1/4" (21 cm)



FORCEPS AND CLAMPS

Hemostatic Forceps and Clamps

COLLER FORCEPS



475307



477110

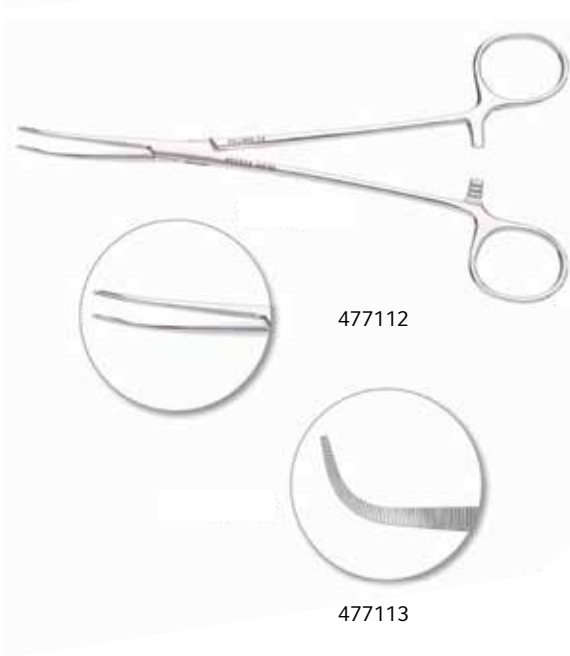

477112

477113

CATALOG #	DESCRIPTION
475305	Skillman serrations, straight, 31 x 1.7 mm tip, 5-1/2" (14 cm)
475306	Skillman serrations, curved, 29 x 1.7 mm tip, 5-3/8" (13.5 cm)
475307	Skillman serrations, strongly curved, 26 x 1.7 mm tip, 5-3/8" (13.5 cm)
477109	Straight, 38 x 1.8 mm tip, 1 x 3 catch, 6-5/8" (17 cm)
477110	Curved, 38 x 1.8 mm tip, 1 x 3 catch, 6-5/8" (17 cm)
477112	Curved, 42 x 1.7 mm tip, 1 x 3 catch, 7-1/4" (18.5 cm)
477113	Strongly curved, 37 x 1.6 mm tip, 1 x 3 catch, 7" (18 cm)
477116	Curved, 44 x 2 mm tip, 4 x 4 catch, 9-3/8" (24 cm)
477117	Strongly curved, 40 x 2 mm tip, 4 x 4 catch, 9-1/4" (23.5 cm)
477118	Angled, 32 x 2 mm tip, 4 x 4 catch, 8-7/8" (22.5 cm)



477118

FORCEPS AND CLAMPS

Hemostatic Forceps and Clamps

COLLIER HEMOSTATIC FORCEPS



182086

A Crile-type forceps with a lighter distal end for more delicate procedures.

CATALOG #	DESCRIPTION
182085	Straight, 5-1/2" (14 cm)
182086	Curved, 5-1/2" (14 cm)
182090	Straight, 6-1/4" (16 cm)
182095	Curved, 6-1/4" (16 cm)
182097	Straight, 7-3/4" (19.5 cm)
182098	Curved, 7-1/4" (18.5 cm)

CRILE HEMOSTATS



182060

Pilling® Pattern, satin finish, standard tip, full serrations.

CATALOG #	DESCRIPTION
182050	Straight, 5-3/4" (14.5 cm)
182060	Curved, 5-1/2" (14 cm)
182070	Straight, 6-1/4" (16 cm)
182080	Curved, 6-1/4" (16 cm)

CRILE FORCEPS



475309

Weck® Pattern, bright finish, full serrations.

CATALOG #	DESCRIPTION
475308	Straight, 5-5/8" (14.5 cm)
475309	Curved, 5-3/4" (14.5 cm)

FORCEPS AND CLAMPS

Hemostatic Forceps and Clamps

CRILE FORCEPS



475311

Weck® Pattern, bright finish, delicate, full serrations.

CATALOG #	DESCRIPTION
475310	Straight, 1.8 mm tip, 5-1/2" (14 cm)
475311	Curved, 1.8 mm tip, 5-3/8" (13.5 cm)
475312	Straight, 1.7 mm tip, 6-3/8" (16 cm)
475313	Curved, 2 mm tip, 6-1/4" (16 cm)

DANDY HEMOSTATIC FORCEPS

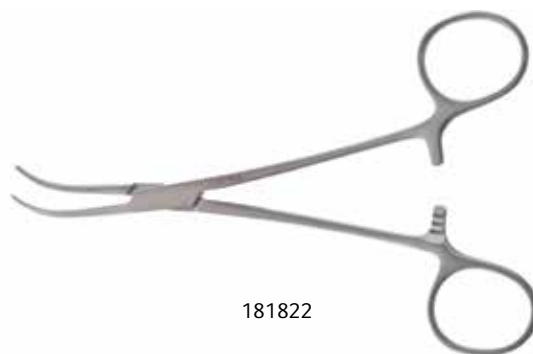

181822

Pilling® Pattern, satin finish.

CATALOG #	DESCRIPTION
181822	Curved sideways, 5-1/2" (14 cm)

DANDY KOLODNY FORCEPS



477170

Weck® Pattern, bright finish.

CATALOG #	DESCRIPTION
477170	Curved sideways, one-half horizontal serrations, 5-3/8" (13.5 cm)

0 in

1

2

3

4

5

6

7

8

9

FORCEPS AND CLAMPS

Hemostatic Forceps and Clamps

HALSTED MOSQUITO FORCEPS



Pilling® Pattern, satin finish, full serrations.

CATALOG #	DESCRIPTION
182300	Straight, 5-1/4" (13.5 cm)
182310	Curved, 5-1/8" (13 cm)
182350	Straight, 4" (10 cm)
182355	Curved, 4" (10 cm)

HALSTED MOSQUITO FORCEPS



Weck® Pattern, bright finish, serrated jaw.

CATALOG #	DESCRIPTION
475084	Straight, 1.2 mm tip, 4-3/4" (12 cm)
475086	Curved, 1.2 mm tip, 4-5/8" (11.5 cm)
475100	Straight, 1.6 mm tip, 5-1/4" (13.5 cm)
475101	Curved, 1.6 mm tip, 5-1/8" (13 cm)

HALSTED MOSQUITO FORCEPS WITH TEETH



Weck® Pattern, bright finish.

CATALOG #	DESCRIPTION
475102	Straight, 1 x 2 teeth, 1.5 mm tip, 5" (12.5 cm)



FORCEPS AND CLAMPS

Hemostatic Forceps and Clamps

HARTMANN MOSQUITO FORCEPS



Weck® Pattern, bright finish. Delicate, serrated jaw.

CATALOG #	DESCRIPTION
475080	Straight, 20 mm jaw, 1.3 mm tip, 4" (10 cm)
475082	Curved, 20 mm jaw, 1.3 mm tip, 4" (10 cm)

MOSQUITO FORCEPS



CATALOG #	DESCRIPTION
075118	Curved, fully serrated, 1.7 x 2 mm tip, 7-1/4" (18.5 cm)

FORCEPS AND CLAMPS

Hemostatic Forceps and Clamps

MOSQUITO FORCEPS SERRATED



KM36078

CATALOG #	DESCRIPTION
KM36078	Curved, serrated, 1 x 2 teeth, 5" (12.5 cm)

SKILLMAN MOSQUITO FORCEPS



475131

Weck® Pattern, bright finish. Full serrations.

CATALOG #	DESCRIPTION
475130	Straight, 1.6 mm tip, 5-1/4" (13.5 cm)
475131	Curved, 1.6 mm tip, 5-1/8" (13 cm)

FORCEPS AND CLAMPS

Hemostatic Forceps and Clamps

JONES HEMOSTAT



Sturdy construction, fully serrated.

CATALOG #	DESCRIPTION
182160	Straight, 5" (12.5 cm)

KELLY FORCEPS



Pilling® Pattern, satin finish. Half serrations.

CATALOG #	DESCRIPTION
182100	Straight, 5-3/4" (14.5 cm)
182110	Curved, 5-1/2" (14 cm)

KELLY FORCEPS



Weck® Pattern, bright finish. Half serrations.

CATALOG #	DESCRIPTION
475210	Straight, 5-1/2" (14 cm)
475211	Curved, 5-1/2" (14 cm)

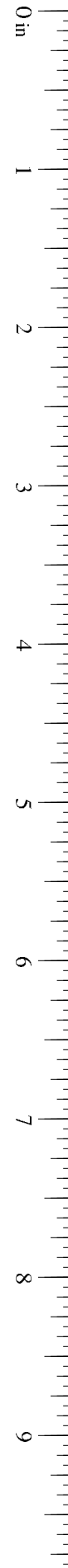

FORCEPS AND CLAMPS

Hemostatic Forceps and Clamps

LAHEY TRACTION FORCEPS



171155

CATALOG #	DESCRIPTION
171155	Straight, 3 x 3 teeth, 6" (15 cm)

LAWRENCE HEMOSTATIC FORCEPS

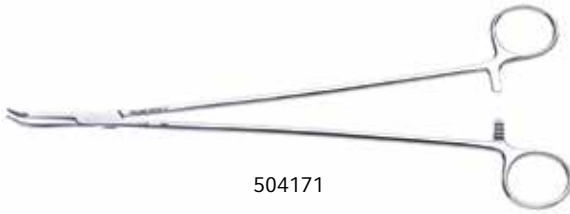

504171

Curved, serrated jaw.

CATALOG #	DESCRIPTION
504171	31 mm jaw, 2 mm tip, 10-3/4" (27.5 cm)
540140	30 mm jaw, 1.7 mm tip, 6-3/4" (17 cm)

MASTIN MUSCLE FORCEPS

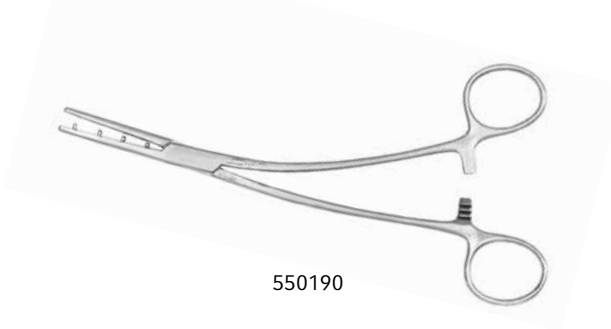

550190

42 mm jaw with cross serrations on pin side only.

CATALOG #	DESCRIPTION
550190	Curved on side, 3.1 mm tip, 6-5/8" (17 cm)

FORCEPS AND CLAMPS

Hemostatic Forceps and Clamps

MAYO-PEAN FORCEPS

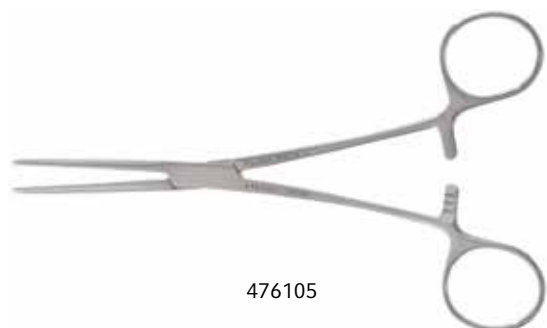

Weck® Pattern, bright finish. Straight hemostatic forceps with full serrations.

CATALOG #	DESCRIPTION
476105	2.9 mm tip, 6-5/8" (17 cm)
476106	2.4 mm tip, 6-5/8" (17 cm)
476110	3.3 mm tip, 7-1/4" (18.5 cm)
476115	3.7 mm tip, 8-1/4" (21 cm)
476120	3.7 mm tip, 8-3/4" (22 cm)
476125	3.8 mm tip, 10-3/8" (26.5 cm)

MAYO-PEAN FORCEPS



Weck® Pattern, bright finish. Curved hemostatic forceps with full serrations.

CATALOG #	DESCRIPTION
476150	2.5 mm tip, 5-5/8" (14.5 cm)
476155	2.9 mm tip, 6-1/2" (16.5 cm)
476156	2.4 mm tip, 6-1/2" (16.5 cm)
476160	3.3 mm tip, 7-1/8" (18 cm)
476165	3.7 mm tip, 8-1/4" (21 cm)
476170	3.5 mm tip, 9-1/4" (23.5 cm)
476175	3.8 mm tip, 10-1/4" (26 cm)

PEAN CLAMPS



Pilling® Pattern, satin finish. Horizontal serrations.

CATALOG #	DESCRIPTION
185060	Straight, 8-1/8" (20.5 cm)
185065	Curved, 8-1/8" (20.5 cm)
185066	Curved, 9-1/4" (23.5 cm)
185067	Straight, 10-1/8" (25.5 cm)

FORCEPS AND CLAMPS

Hemostatic Forceps and Clamps

ROCHESTER-PEAN FORCEPS

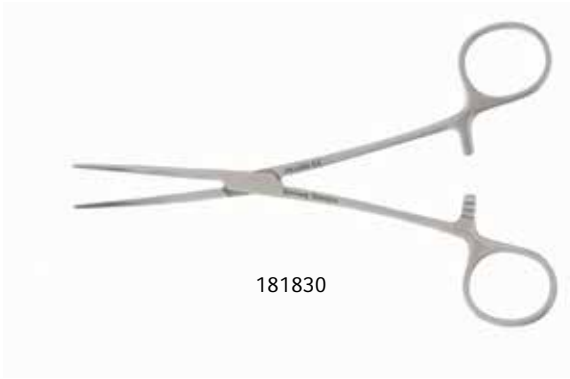

Pilling® Pattern, satin finish. Straight, full serrations.

CATALOG #	DESCRIPTION
181830	Curved, 2 mm tip, 6-1/2" (16.5 cm)

ROCHESTER-PEAN FORCEPS



Pilling® Pattern, satin finish. Straight, full serrations.

CATALOG #	DESCRIPTION
182400	2.7 mm tip, 5-1/2" (14 cm)
182405	2.8 mm tip, 6-1/2" (16.5 cm)
182415	3.0 mm tip, 7-1/4" (18.5 cm)
182420	3.2 mm tip, 8" (20.5 cm)

ROCHESTER-PEAN FORCEPS



Pilling® Pattern, satin finish. Curved, full serrations.

CATALOG #	DESCRIPTION
182440	3.2 mm tip, 5-1/2" (14 cm)
182445	2.8 mm tip, 6-1/4" (16 cm)
182455	3.0 mm tip, 7-1/4" (18.5 cm)
182460	3.2 mm tip, 8" (20.5 cm)

FORCEPS AND CLAMPS

Hemostatic Forceps and Clamps

ROCHESTER-PEAN FORCEPS, 12"



KM36362

KMedic® Pattern, satin finish.

CATALOG #	DESCRIPTION
KM36360	Hemostatic, straight, 4.6 mm tip, 12" (30.5 cm)
KM36362	Curved, serrated, 12" (30.5 cm)

OCHSNER FORCEPS (KOCHER)



476205

Weck® Pattern, bright finish. Straight hemostatic forceps with full serrations, 1 x 2 teeth.

CATALOG #	DESCRIPTION
476200	3 mm tip, 5-5/8" (14.5 cm)
476205	4.2 mm tip, 6-3/8" (16 cm)
476206	Light model, 2.5 mm tip, 6-3/8" (16 cm)
476210	3.3 mm tip, 7-1/4" (18.5 cm)
476215	4.5 mm tip, 8" (20.5 cm)
476220	5.5 mm tip, 8-7/8" (22.5 cm)
476225	5 mm tip, 10-3/8" (26.5 cm)

OCHSNER FORCEPS (KOCHER)



476255

Weck® Pattern, bright finish. Curved hemostatic forceps with full serrations, 1 x 2 teeth.

CATALOG #	DESCRIPTION
476250	2.7 mm tip, 5-1/2" (14 cm)
476255	2.6 mm tip, 6-1/4" (16 cm)
476260	3.6 mm tip, 7-1/4" (18.5 cm)
476265	3.4 mm tip, 7-7/8" (20 cm)
476270	4 mm tip, 8-3/4" (22 cm)
476275	4 mm tip, 10-1/4" (26 cm)

FORCEPS AND CLAMPS

Hemostatic Forceps and Clamps

ROCHESTER-OCHSNER FORCEPS (KOCHER)

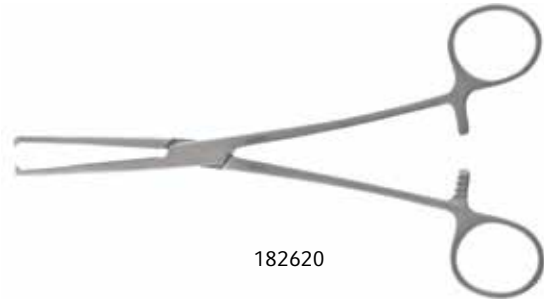

Pilling® Pattern, straight. Full serrations, 1 x 2 teeth.

CATALOG #	DESCRIPTION
182600	5-1/2" (14 cm)
182605	6-1/4" (16 cm)
182615	7-1/4" (18.5 cm)
182620	8" (20.5 cm)

ROCHESTER-OCHSNER FORCEPS (KOCHER)



Pilling® Pattern, curved. Full serrations, 1 x 2 teeth.

CATALOG #	DESCRIPTION
182655	6-1/4" (16 cm)
182665	7-1/4" (18.5 cm)
182670	Curved, 1 x 2 teeth, 8" (20.5 cm)

PROVIDENCE HOSPITAL FORCEPS



Weck® Pattern, bright finish. Two-thirds serrations.

CATALOG #	DESCRIPTION
475200	Straight, 2 mm tip, 5-3/8" (13.5 cm)
475201	Curved, 2 mm tip, 5-3/8" (13.5 cm)

FORCEPS AND CLAMPS

Hemostatic Forceps and Clamps

PROVIDENCE HOSPITAL HEMOSTATS



Pilling® Pattern, satin finish. Half serrations.

CATALOG #	DESCRIPTION
182140	Straight, 5-3/4" (14.5 cm)
182150	Curved, 5-5/8" (14.5 cm)

RANKIN FORCEPS



Pilling® Pattern, satin finish. Half serrations.

CATALOG #	DESCRIPTION
182120	Straight, 6-1/4" (16 cm)
182130	Curved, 6-1/4" (16 cm)

RANKIN-KELLY HEMOSTAT FORCEPS



KMedic® Pattern, satin finish. Three-quarter serrations.

CATALOG #	DESCRIPTION
KM36196	Straight, 6-1/4" (16 cm)
KM36198	Curved, serrated, 6-1/4" (16 cm)

FORCEPS AND CLAMPS

Hemostatic Forceps and Clamps

SAROT INTRA-THORACIC ARTERY FORCEPS

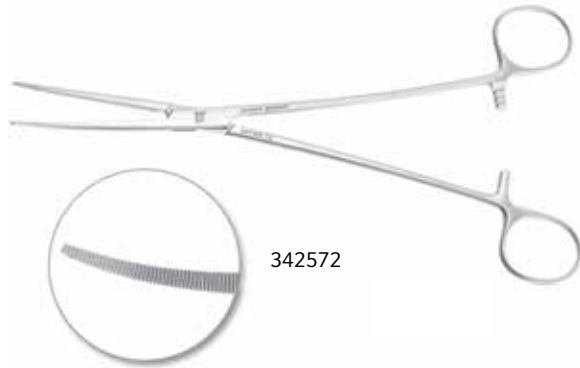

Slender, slightly curved forceps with serrated jaws. Specially designed for pulmonary resections, cardiovascular and esophageal surgery.

CATALOG #	DESCRIPTION
342571	Medium, serrated, 1/2" (1.5 cm) tip length, 1.6 mm tip width, 7-5/8" (19.5 cm)
342572	Large, serrated, 2-1/4" (5.5 cm) tip length, 2 mm tip width, 9" (23 cm)

SCHNIDT FORCEPS (TONSIL)



Pilling® Pattern, satin finish. Half serrations.

CATALOG #	DESCRIPTION
182390	Half curved, 7-1/2" (19 cm)

SCHNIDT FORCEPS (TONSIL)

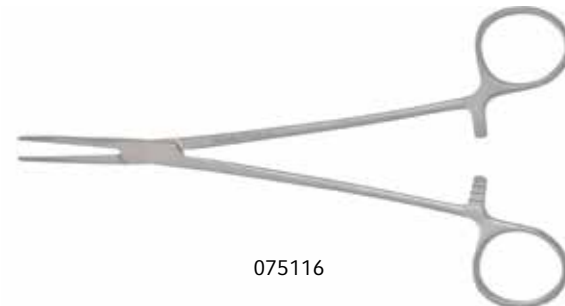

Weck® Pattern, bright finish.

CATALOG #	DESCRIPTION
075116	Slightly curved, 7-1/4" (18.5 cm)
075120	Lightly curved, serrated, 2 mm tip, 7-1/2" (19 cm)
075122	Strongly curved, serrated, 2 mm tip, 7-1/2" (19 cm)

FORCEPS AND CLAMPS

Hemostatic Forceps and Clamps

VANDERBILT VESSEL FORCEPS



342590

This hemostatic-type forceps is particularly useful in cardiovascular and thoracic surgery but has been used extensively in general surgery as well. The elongated handles afford access to a number of surgical sites. Jaws are of a standard cross-serration design.

CATALOG #	DESCRIPTION
342590	Slightly curved, 2" (5 cm) tip length, 2 mm tip width, 8-5/8" (22 cm)

SERREFINES CROSS-ACTION CLAMPS



182205

Cross-action, full serrations.

CATALOG #	DESCRIPTION
182200	Straight, 1-1/2" (4 cm)
182205	Straight, 2-1/4" (5.5 cm)
182210	Curved, 1-3/8" (3.5 cm)

Extra-Delicate Hemostatic Forceps

JACOBSON HEMOSTATIC FORCEPS



443507

Pilling® Pattern, satin finish. These delicate forceps feature tips as fine as 0.8 mm and can be used in a number of microsurgical procedures.

CATALOG #	DESCRIPTION
443500	Straight, 0.8 mm tip, 3-7/8" (10 cm)
443502	Curved, 0.8 mm tip, 3-7/8" (10 cm)
443505	Straight, 0.8 mm tip, 5-1/8" (13 cm)
443507	Curved, 0.8 mm tip, 5-1/8" (13 cm)
443508	Full curved, 0.8 mm tip, 4-7/8" (12.5 cm)
443510	Curved, 1.2 mm tip, 7-1/8" (18 cm)
443512	Full curved, 1 mm tip, 7-1/8" (18 cm)

FORCEPS AND CLAMPS

Extra Delicate Hemostatic Forceps

MICRO MOSQUITO FORCEPS



KM36165

KMedic® Pattern, satin finish.

CATALOG #	DESCRIPTION
KM36164	Straight, 1 mm tip, 5" (12.5 cm)
KM36165	Curved, serrated, extremely fine tips, 5" (12.5 cm)

PLASTI STATS® ADSON FORCEPS

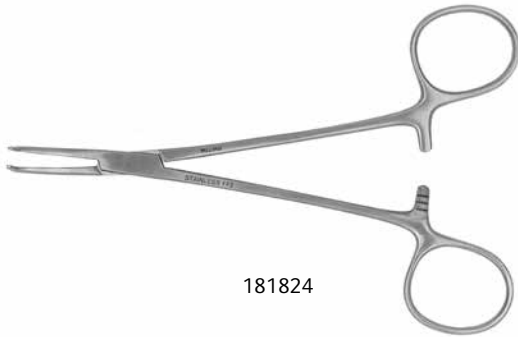

181824

CATALOG #	DESCRIPTION
181824	Curved, 1/2" (12.5 mm) jaw serration, 5-1/2"(14 cm)

PLASTI STATS® COLLIER FORCEPS



181804

CATALOG #	DESCRIPTION
181804	Curved, 7-1/2" (19 cm)

FORCEPS AND CLAMPS

Extra Delicate Hemostatic Forceps

PLASTI STATS® CRILE HEMOSTATS



181802

Full serrations.

CATALOG #	DESCRIPTION
181800	Straight, 1-1/4" (32 mm) jaw, 5-3/4" (14.5 cm)
181802	Curved, 1-1/4" (32 mm) jaw, 5-1/2" (14 cm)

PLASTI STATS® KOCHER FORCEPS



181832

CATALOG #	DESCRIPTION
181832	Straight, 1 x 2 teeth, full serrations, 5-1/2" (14 cm)

PLASTI STATS® MOSQUITO FORCEPS



181806

Full serrations.

CATALOG #	DESCRIPTION
181810	Straight, 3/4" (2 cm) jaw, 4" (10 cm)
181812	Curved, 5/8" (1.5 cm) jaw, 4" (10 cm)
181818	Straight, 1/2" (12.5 mm) jaw, 4-3/4" (12 cm)
181820	Curved, 1/2" (12.5 mm) jaw, 4-5/8" (11.5 cm)
181814	Straight, 3/4" (2 cm) jaw, 5" (12.5 cm)
181816	Curved, 3/4" (2 cm) jaw, 5" (12.5 cm)
181806	Straight, 1" (2.5 cm) jaw, 5-1/2" (14 cm)
181808	Curved, 1" (2.5 cm) jaw, 5-1/2" (14 cm)

FORCEPS AND CLAMPS

Right Angle Clamps

CROUCH CLAMP

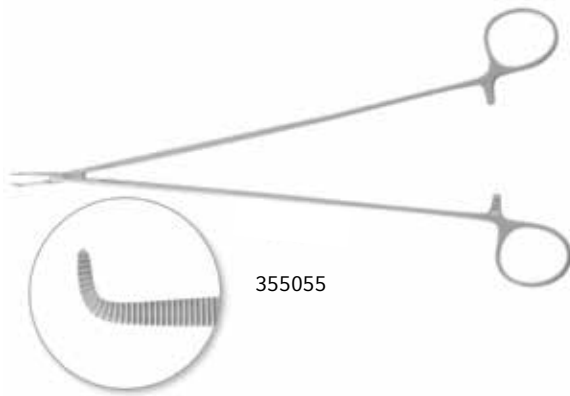

CATALOG #	DESCRIPTION
355055	10-1/4" (26 cm)

DEBAKEY® RIGHT ANGLE FORCEPS

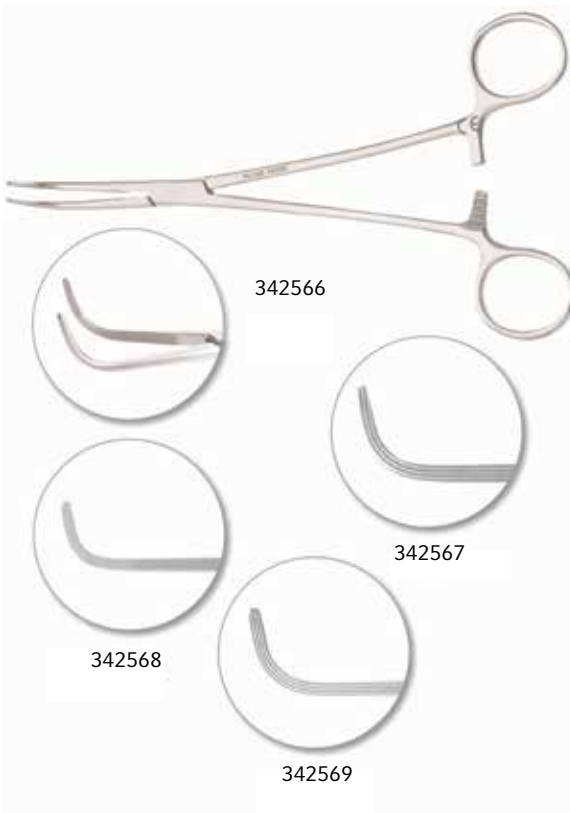

With full length longitudinal serrations and cross serrations at tip.

CATALOG #	DESCRIPTION
342566	7-5/8" (19.5 cm)
342567	9" (23 cm)
342568	10-1/4" (26 cm)
342569	11-3/8" (29 cm)

FORCEPS AND CLAMPS

Right Angle Clamps

DIETRICH RIGHT ANGLE CLAMPS

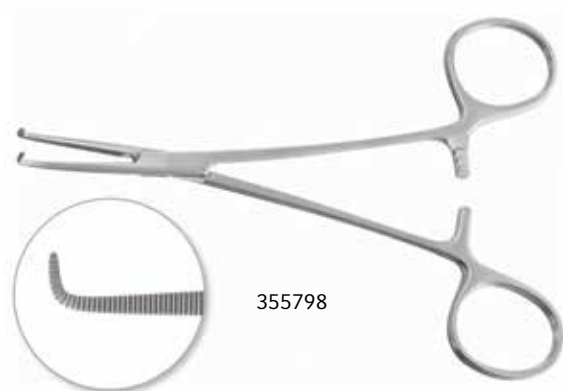

355798

CATALOG #	DESCRIPTION
355798	Serrated jaw, 5-3/8" (13.5 cm)
355799	Serrated jaw, 4-7/8" (12.5 cm)
355800	Serrated jaw 8 mm past angle, 7-1/4" (18.5 cm)
355801	Longitudinally serrated jaw 8 mm past angle, 7-1/4" (18.5 cm)



355800

355801

FINOCHIETTO THORACIC FORCEPS



342615

A utility clamp for use as ligature carrier, hemostat or dissector. Particularly good in ligation during esophageal surgery. Blades have longitudinal serrations and holes for threading ligature.

CATALOG #	DESCRIPTION
342615	Angled, longitudinal serrations, 1-1/8" (3 cm) tip length, 9-1/2" (24 cm)

0 in

1

2

3

4

5

6

7

8

9

FORCEPS AND CLAMPS

Right Angle Clamps

GEMINI FORCEPS

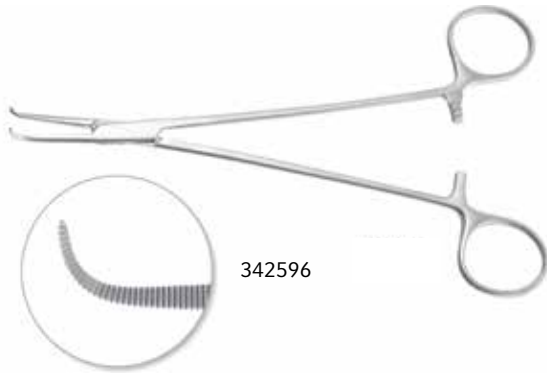

A more delicate modification of the Mixer Forceps. Slender, acutely curved jaws with full serrations.

CATALOG #	DESCRIPTION
342596	7-1/4" (18.5 cm)
342597	9" (23 cm)
342598	11-1/8" (28.5 cm)

GRAY CYSTIC DUCT FORCEPS



CATALOG #	DESCRIPTION
172550	Curved jaws and shafts. Set of two: 8-1/4" (21 cm) and 9-1/4" (23.5 cm)

HARRINGTON CLAMPS



Right angle jaw. Dull, non-glare finish stainless steel.

CATALOG #	DESCRIPTION
342632	Heavy construction, longitudinal serrations, 1-1/2" (4 cm) tip length, 12-3/8" (31.5 cm)
342633	Light construction, longitudinal serrations, 1-1/2" (4 cm) tip length, 12-3/8" (31.5 cm)

FORCEPS AND CLAMPS

Right Angle Clamps

JACKSON TRACHEAL HEMOSTAT



514480

CATALOG #	DESCRIPTION
514480	Acutely curved, 5-3/8" (13.5 cm)

KANTROWITZ FORCEPS

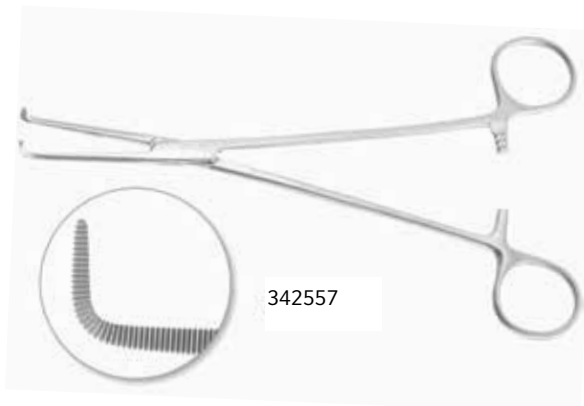

342557

True right angle forceps with cross serrated jaws. Useful for grasping and dissecting in thoracic, vascular and general surgery.

CATALOG #	DESCRIPTION
342557	Serrated, 3/4" (2 cm) tip length, 2 mm tip width, 7-7/8" (20 cm)
342558	Serrated, 9-1/2" (24 cm)
342559	Serrated, 3/4" (2 cm) tip length, 2 mm tip width, 10-5/8" (27 cm)

0 in

1

2

3

4

5

6

7

8

9

FORCEPS AND CLAMPS

Right Angle Clamps

LAHEY DISSECTING FORCEPS



496111

CATALOG #	DESCRIPTION
496105	Longitudinal serrations, 2.4 mm tip, 7-7/8" (20 cm)
496110	Horizontal serrations, 44 mm jaw, 2.4 mm tip, 7-3/4" (19.5 cm)
496111	Longitudinal serrations, 46 mm jaw, 2.5 mm tip, 7-3/4" (19.5 cm)

LAHEY GALL DUCT FORCEPS, SLENDER BLADES



172530

CATALOG #	DESCRIPTION
172530	Longitudinal serrations, 7-1/2" (19 cm)
172531	Standard serrations, 7-1/2" (19 cm)
172532	Longitudinal serrations, 8-7/8" (22.5 cm)

FORCEPS AND CLAMPS

Right Angle Clamps

LOWER GALL DUCT FORCEPS



CATALOG #	DESCRIPTION
172525	Short jaws, fully curved, longitudinal serrations, 7-1/2" (19 cm)

MEEKER HEMOSTATIC DISSECTING FORCEPS

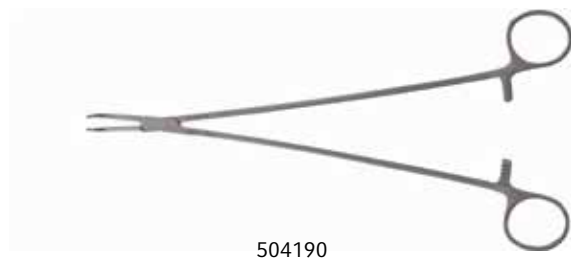

CATALOG #	DESCRIPTION
540150	90 degree-angled, serrated, 23 mm jaw, 1.8 mm tip, 6-3/8" (16 cm)
504190	90 degree-angled, serrated, 28 mm jaw, 1.8 mm tip, 10-5/8" (27 cm)

MACQUIGG-MIXTER FORCEPS



An excellent general purpose forceps and bronchus clamp. Longitudinally serrated jaws, right angle tip.

CATALOG #	DESCRIPTION
342611	Curved, longitudinal serrations, 1-5/8" (4 cm) tip length, 8-5/8" (22 cm)

FORCEPS AND CLAMPS

Right Angle Clamps

MIXTER THORACIC FORCEPS

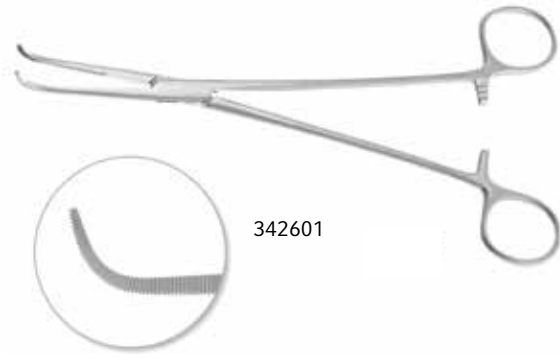

Regular model. Available with DeBakey®-type jaw or standard serrated jaw, 3/4" (2 cm) long.

CATALOG #	DESCRIPTION
342603	Half curved, serrated, 5/8" (1.5 cm) tip length, 2.3 mm tip width, 9-1/8" (23 cm)
342600	Curved, DeBakey®-type jaw, 1" (2.5 cm) tip length, 2.8 mm tip width, 9-1/4" (23.5 cm)
342601	Strongly curved, serrated, 3/4" (2 cm) tip length, 8-3/4" (22 cm)

MIXTER CLAMPS

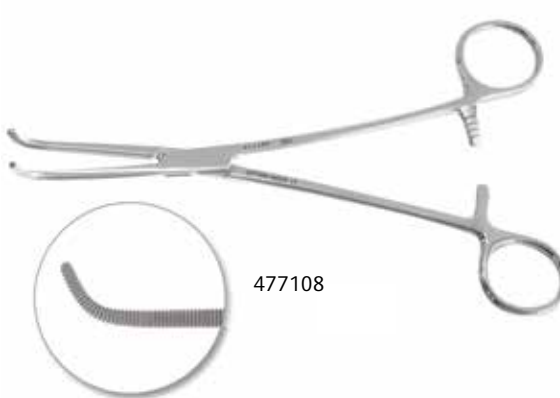

CATALOG #	DESCRIPTION
477108	40 degree-angled, fully serrated, 50 mm jaw, 3 mm tip, 7-3/4" (19.5 cm)

MIXTER DISSECTING FORCEPS

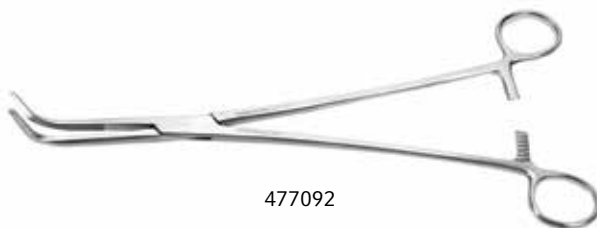

Two-thirds serrations.

CATALOG #	DESCRIPTION
477091	26 mm jaw, 2 mm tip, 7-1/4" (18.5 cm)
477092	40 mm jaw, 2.2 mm tip, 9" (23 cm)
477093	55 mm jaw, 2.4 mm tip, 11" (28 cm)

FORCEPS AND CLAMPS

Right Angle Clamps

MIXTER FORCEPS



CATALOG #	DESCRIPTION
KM36566	Fully curved, serrated, 9" (23 cm)

MIXTER GALL DUCT FORCEPS



Acutely curved jaws. Full serrations run entire length of jaw.

CATALOG #	DESCRIPTION
172500	6-1/4" (16 cm)
172503	7-1/8" (18 cm)
172506	8-3/4" (22 cm)

PEDIATRIC MIXTER DISSECTING FORCEPS



Weck® Pattern, bright finish, fully curved.

CATALOG #	DESCRIPTION
477090	24 mm jaw, 2 mm tip, 5-1/4" (13.5 cm)

0 in

1

2

3

4

5

6

7

8

9

FORCEPS AND CLAMPS

Right Angle Clamps

MIXTER "PEDI" GALL DUCT FORCEPS



172495

Pilling® Pattern, satin finish.

CATALOG #	DESCRIPTION
172495	Delicate, 5-1/8" (13 cm)

RIENHOFF SWAN-NECK CLAMP

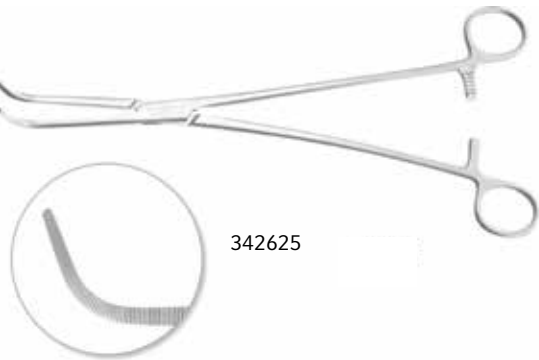

342625

A double-curved forceps with delicately rounded tips.

CATALOG #	DESCRIPTION
342625	Serrated, 10-5/8" (27 cm)

ROOS SCALENECTOMY FORCEPS

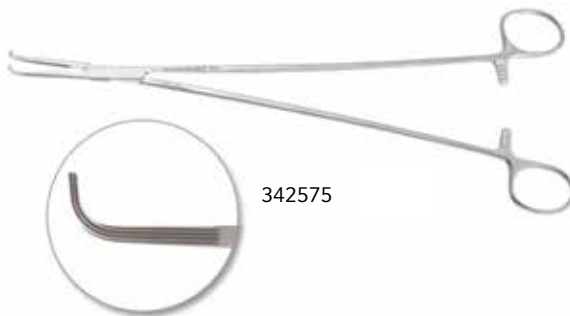

342575

Designed to give a secure hold on the scalene muscle during scaleneotomy.

CATALOG #	DESCRIPTION
342575	Right angle, longitudinal serrations, 1/2" (1.5 cm) tip length, 1.5 mm tip width, 11" (28 cm)



FORCEPS AND CLAMPS

Right Angle Clamps

RUMEL THORACIC FORCEPS



Furnished with DeBakey®-type jaw or standard serrated jaws. In addition to being one of the more popular thoracic artery forceps, they are especially suited for passing tapes around the cava or pulmonary artery in open heart surgery.

CATALOG #	DESCRIPTION
342501	A curved, DeBakey® jaw, 2-3/4" (7 cm) tip length, 9-5/8" (24.5 cm)
342504	D curved, DeBakey® jaw, 1-1/8" (3 cm) tip length, 2.8 mm tip width, 9-3/4" (25 cm)
342511	A curved, serrated, 1/2" (1.5 cm) tip length, 2.4 mm tip width, 9-3/8" (24 cm)
342513	C curved, serrated, 3/4" (2 cm) tip length, 2 mm tip width, 9-5/8" (24.5 cm)
342514	D curved, serrated, 1" (2.5 cm) tip length, 2.4 mm tip width, 9" (23 cm)
342533	Child size, fully curved, standard serrated, 2 mm tip width, 7-7/8" (20 cm)

SAWTELL HEMOSTATIC FORCEPS

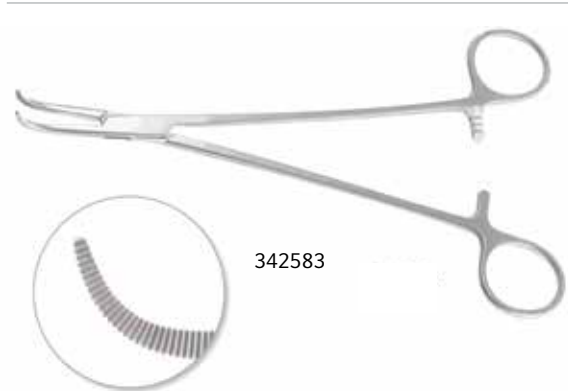

CATALOG #	DESCRIPTION
342583	Full curved, heavy tips, 7-1/4" (18.5 cm)

FORCEPS AND CLAMPS

Right Angle Clamps

STOREY HEMOSTATIC FORCEPS

33 mm jaw with cross serrations.

CATALOG #	DESCRIPTION
496215	Slightly curved, 8-3/4" (22 cm)
496216	Strongly curved, 8-5/8" (22 cm)
496217	Right angle, 8-3/8" (21.5 cm)



WESTPHAL DISSECTING FORCEPS

Longitudinal serrations, narrow tip.

CATALOG #	DESCRIPTION
496112	Angled, 7-7/8" (20 cm)



FORCEPS AND CLAMPS

Right Angle Clamps

WILLAUER FORCEPS



Lightweight full curved, longitudinally serrated jaws.

CATALOG #	DESCRIPTION
342580	2" (5 cm) tip length, 9-1/2" (24 cm)

Gastrointestinal Forceps and Clamps

ADAIR-ALLIS INTESTINAL TISSUE FORCEPS

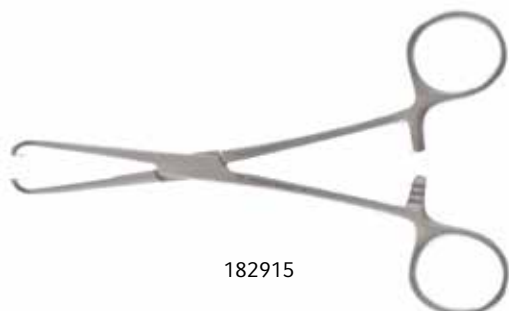

CATALOG #	DESCRIPTION
182915	9 x 10 teeth, 6-1/4" (16 cm)

ALLEN INTESTINAL CLAMPS

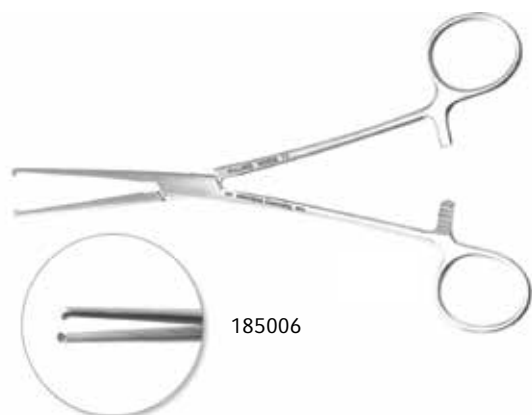

Longitudinal serrations, 1 x 2 teeth.

CATALOG #	DESCRIPTION
185005	Jaws 3-3/4" (9.5 cm), 9-1/2" (24 cm)
185006	Jaws 2-3/8" (6 cm), 8" (20.5 cm)
185010	Pediatric size, delicate, jaws 2-1/8" (5.5 cm), 6-1/4" (16 cm)

FORCEPS AND CLAMPS

Gastrointestinal Forceps and Clamps

ALLIS DELICATE TISSUE FORCEPS



Weck® Pattern, bright finish, 6-1/8" (15.5 cm).

CATALOG #	DESCRIPTION
541100	2 x 3 teeth, 3.8 mm tip
541120	Straight, delicate, 3 x 4 teeth, 4 mm tip

ALLIS TISSUE FORCEPS



Pilling® Pattern, satin finish.

CATALOG #	DESCRIPTION
182795	3 x 4 teeth, 6" (15 cm)
182850	4 x 5 teeth, 6" (15 cm)
182860	5 x 6 teeth, 6" (15 cm)
182870	5 x 6 teeth, 7-1/2" (19 cm)
182875	5 x 6 teeth, 9" (23 cm)
182880	4 x 5 teeth, 5-3/4" (14.5 cm)

ALLIS TISSUE FORCEPS



Weck® Pattern, bright finish.

CATALOG #	DESCRIPTION
541094	3 x 4 teeth, 5" (12.5 cm)
500310	3 x 4 teeth, 6-1/8" (15.5 cm)
500311	4 x 5 teeth, 6-1/8" (15.5 cm)
500312	5 x 6 teeth, 6-1/8" (15.5 cm)
500316	5 x 6 teeth, 7-1/2" (19 cm)

FORCEPS AND CLAMPS

Gastrointestinal Forceps and Clamps

JUDD-ALLIS INTESTINAL FORCEPS

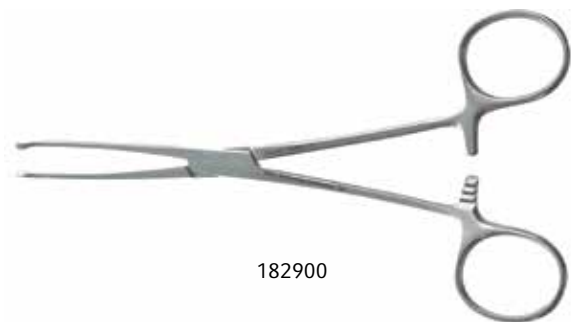

CATALOG #	DESCRIPTION
182900	3 x 4 teeth, 6" (15 cm)
182905	3 x 4 teeth, 7-1/4" (18.5 cm)

LOCKWOOD-ALLIS INTESTINAL TISSUE FORCEPS

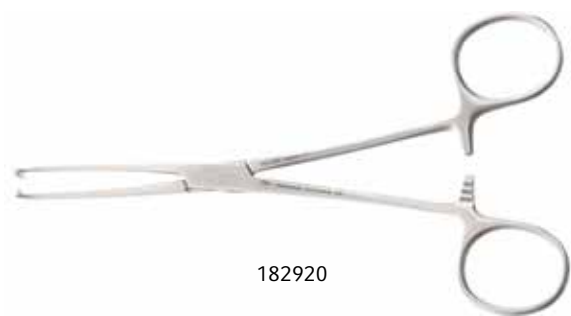

CATALOG #	DESCRIPTION
182920	Light model, flattened jaws, 5 x 6 teeth, 6-1/4" (16 cm)

THOMS-ALLIS TISSUE AND TRACTION FORCEPS



CATALOG #	DESCRIPTION
182910	6 x 7 teeth, 8" (20.5 cm)

0 in

1

2

3

4

5

6

7

8

9

FORCEPS AND CLAMPS

Gastrointestinal Forceps and Clamps

WILLAUER-ALLIS TISSUE FORCEPS



Extra-long, springy, Allis-type forceps with 5 x 6 teeth. Dull, non-glare finish stainless steel.

CATALOG #	DESCRIPTION
342720	10" (25.5 cm)
342721	11-1/4" (28.5 cm)

BABCOCK TISSUE FORCEPS



Pilling® Pattern, satin finish.

CATALOG #	DESCRIPTION
183010	6-1/4" (16 cm)
183020	7-7/8" (20 cm)
342725	Serrated, 9-1/2" (24 cm)
342726	Serrated, 9-1/2" (24 cm)

BABCOCK TISSUE FORCEPS

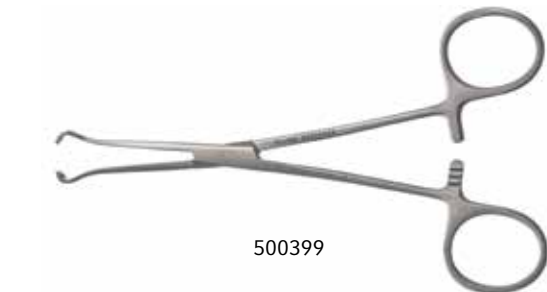

Weck® Pattern, bright finish.

CATALOG #	DESCRIPTION
500399	5.8 mm tip, 5-3/4" (14.5 cm)
500400	8.3 mm tip, 6-3/8" (16 cm)
500402	10 mm tip, 7-7/8" (20 cm)

FORCEPS AND CLAMPS

Gastrointestinal Forceps and Clamps

BABCOCK TISSUE FORCEPS

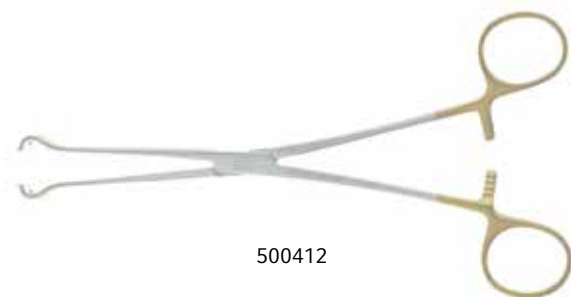

Tungsten carbide jaw tips.

CATALOG #	DESCRIPTION
500410	3/8" (9.5 mm) tip, 6-1/2" (16.5 cm), TC
500412	7/16" (11 mm) tip, 7-7/8" (20 cm), TC

BAINBRIDGE FORCEPS

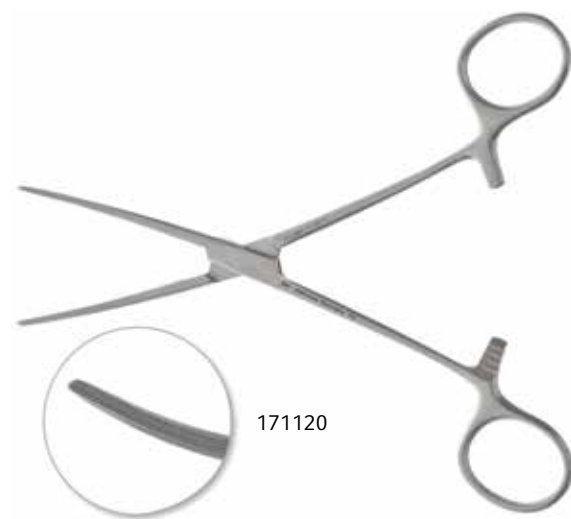

Pilling® Pattern, satin finish. Slender blades longitudinally serrated.

CATALOG #	DESCRIPTION
171117	Straight, 7-1/4" (18.5 cm)
171120	Curved, 6-3/4" (17 cm)
171122	Curved, 7-1/4" (18.5 cm)

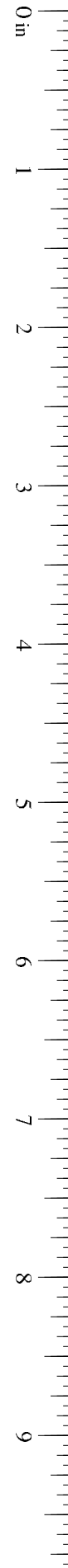

FORCEPS AND CLAMPS

Gastrointestinal Forceps and Clamps

DEBAKEY® BAINBRIDGE CLAMPS

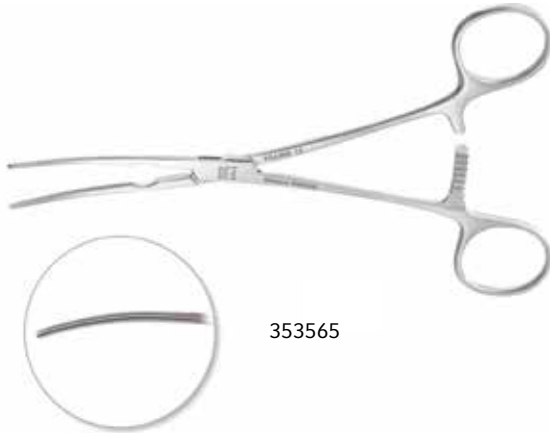

With narrow DeBakey®-type jaws.

CATALOG #	DESCRIPTION
353560	Straight, 40 x 2.4 mm jaws, 7" (18 cm)
353562	Straight, 80 x 2.8 mm jaws, 7-7/8" (20 cm)
353565	Curved, 60 x 2.4 mm jaws, 7" (18 cm)

BEST COLON CLAMP

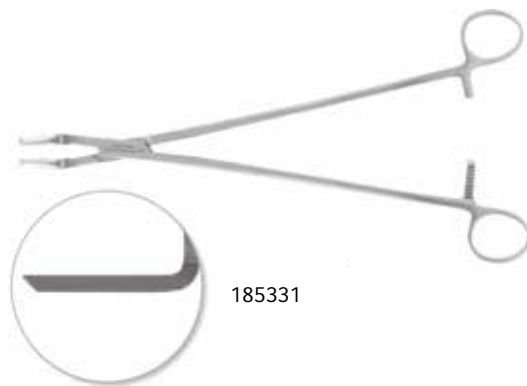

Right angle design for open anastomosis. Strong crushing jaws.

CATALOG #	DESCRIPTION
185331	2-5/8" (6.5 cm) jaw size, 10-5/8" (27 cm)

FORCEPS AND CLAMPS

Gastrointestinal Forceps and Clamps

BLAKE GALLSTONE GRASPING FORCEPS



Pilling® Pattern, satin finish.

CATALOG #	DESCRIPTION
172616	Curved, serrated, 8" (20.5 cm)

CYSTIC DUCT CATHETER CLAMPS



For open cholangiography.

CATALOG #	DESCRIPTION
172570	Accepts 4 Fr. catheter, 7-1/2" (19 cm)
172571	Accepts 6 Fr. catheter, 7-1/2" (19 cm)

0 in

1

2

3

4

5

6

7

8

9

FORCEPS AND CLAMPS

Gastrointestinal Forceps and Clamps

DEBAKEY® THORACIC DISSECTING FORCEPS



342560

DeBakey®-type jaws. The jaws are narrowed and thinned to a minimum size and double-curved. This provides a lightweight, sure-holding forceps for dissecting and passing tapes and ligatures around vessels.

CATALOG #	DESCRIPTION
342560	C curved, 3/8" (1 cm) tip length, 8-1/8" (20.5 cm)
342561	D curved, 1/2" (1.5 cm) tip length, 2.8 mm tip width, 8-1/4" (21 cm)
342562	C curved, 5/8" (1.5 cm) tip length, 2.8 mm tip width, 9-5/8" (24.5 cm)
342563	D curved, 7/8" (2 cm) tip length, 9-1/2" (24 cm)
342565	D curved, 3/4" (2 cm) tip length, 10-1/4" (26 cm)



342560



342561



342562



342563



342565

FORCEPS AND CLAMPS

Gastrointestinal Forceps and Clamps

DENNIS ANASTOMOSIS CLAMP

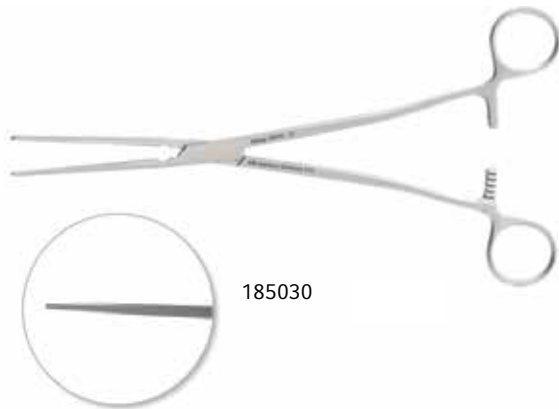

CATALOG #	DESCRIPTION
185030	54 mm jaws, 9-1/4" (23.5 cm)

DESJARDIN GALLSTONE GRASPING FORCEPS

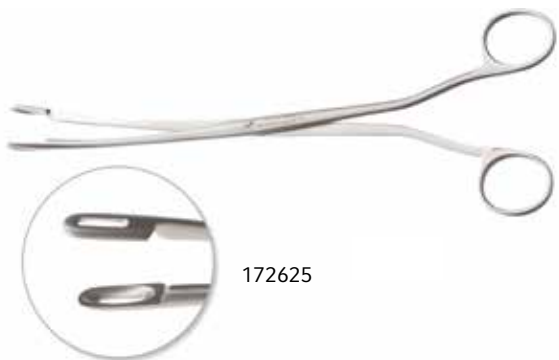

CATALOG #	DESCRIPTION
172625	9-1/4" (23.5 cm)

DOYEN INTESTINAL CLAMPS



Soft blades, diagonal serrations.

CATALOG #	DESCRIPTION
185202	Straight, 9-1/8" (23 cm)
185204	Curved, 9" (23 cm)

0 in

1

2

3

4

5

6

7

8

9

FORCEPS AND CLAMPS

Gastrointestinal Forceps and Clamps

HAYES ANTERIOR RESECTION CLAMPS

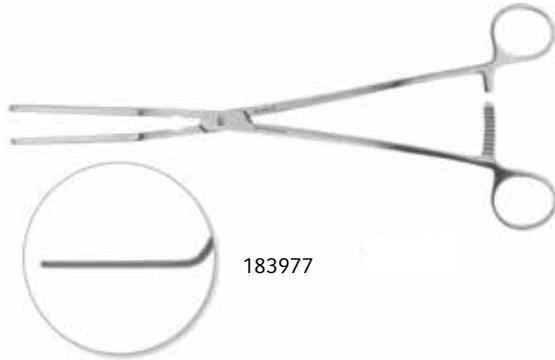

70 degree-angled, 1 x 2 DeBakey® Jaws, angular shafts.

CATALOG #	DESCRIPTION
183975	2-3/8" (6 cm) jaws, 9-7/8" (25 cm)
183977	3-1/8" (8 cm) jaws, 10-1/2" (26.5 cm)

KLINTMALM™ LIVER TRANSPLANT CLAMPS

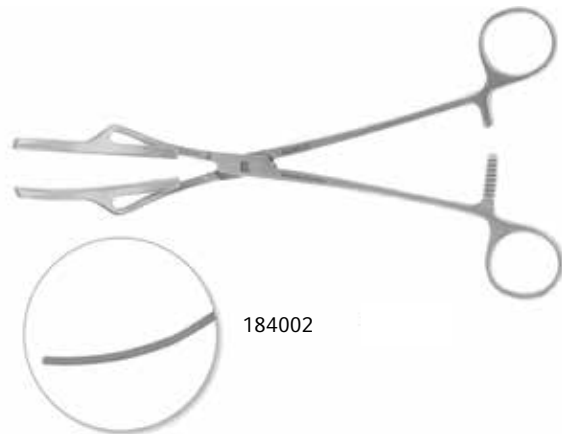

The KLINTMALM™ Liver Transplant Clamp is designed to securely occlude the suprahepatic inferior vena cava of the recipient during anastomosis of the donor liver.

- Unique "teething" design of a single row against a double row of teeth helps prevent slippage and scissoring of the jaw.
- An even-parallel closure of the jaw helps prevent blood seepage and helps minimize the risk of the vena cava slipping from the clamp.
- Jaw curvature is designed to meet the anatomical requirements of the upper abdomen and to reduce trauma to the liver.

A standard vascular clamp on the cuff of the vena cava and diaphragm may not always properly close due to the amount of tissue in the clamp. The use of a standard vascular clamp may result in clamp insecurity and slippage leading to the possible retraction of the vena cava into the diaphragm, and visual obstruction caused by pooling blood.

CATALOG #	DESCRIPTION
184001	Small 2-1/2" (6.5 cm) jaw, 7-1/8" (18 cm)
184002	Medium 3-1/8" (8 cm) jaw, 8-3/8" (21.5 cm)
184003	Large 3-3/8" (8.5 cm) jaw, 9-7/8" (25 cm)

FORCEPS AND CLAMPS

Gastrointestinal Forceps and Clamps

KOCHER INTESTINAL CLAMPS

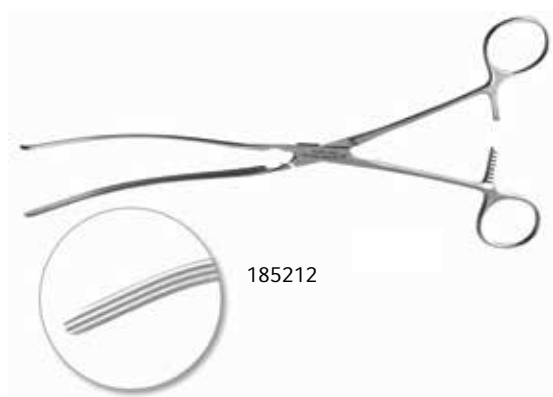

Soft blades, longitudinal serrations.

CATALOG #	DESCRIPTION
185210	Straight, 10" (25.5 cm)
185212	Curved, 9-7/8" (25 cm)
185214	Straight, 10-3/4" (27.5 cm)

LELAND JONES CLAMPS

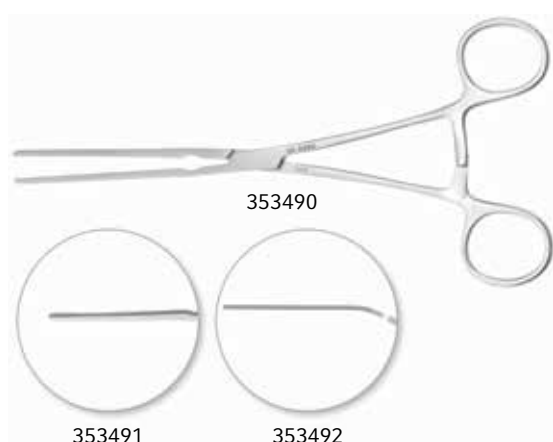

Delicate DeBakey® Jaws, 2.4 mm wide. LIFE-LOK® Box-Lock. Versatile clamps which have been found useful in small bowel procedures.

CATALOG #	DESCRIPTION
353490	Straight, 8-1/8" (20.5 cm)
353491	Angled 15 degrees, 8-1/8" (20.5 cm)
353492	Angled 30 degrees, 8" (20.5 cm)

MIXTER FORCEPS

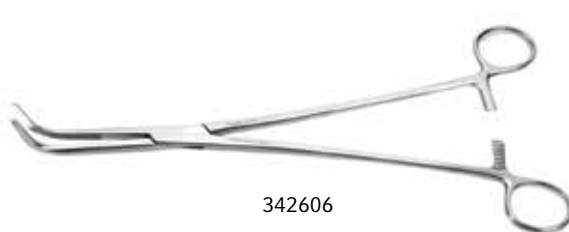

Long model. Very useful for deep dissection and as a bronchus clamp.

CATALOG #	DESCRIPTION
342606	Strongly curved, serrated (3 cm) tip length, 10-3/4" (27.5 cm)
342605	Strongly curved, DeBakey® Jaw, 1-3/8" (3.5 cm) tip length, 11" (28 cm)



FORCEPS AND CLAMPS

Gastrointestinal Forceps and Clamps

MAYO (GUYON) VESSEL CLAMP

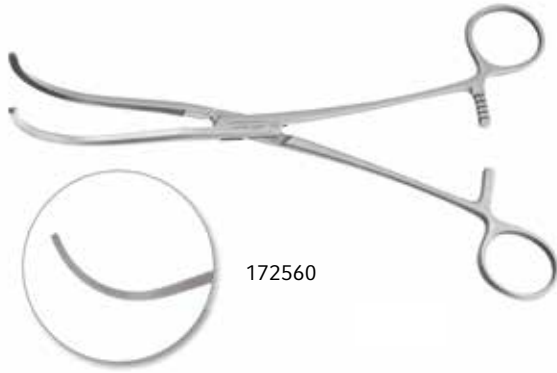

172560

CATALOG #	DESCRIPTION
172560	9-1/4" (23.5 cm)

MAYO-ROBSON INTESTINAL CLAMPS

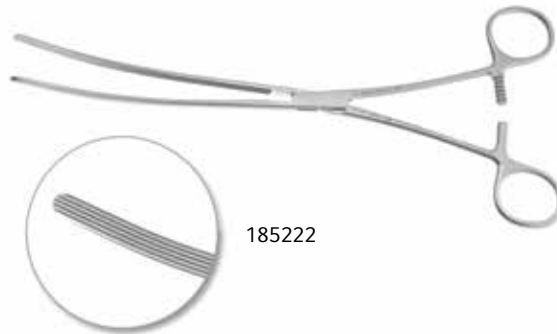

185222

Longitudinal serrations.

CATALOG #	DESCRIPTION
185220	Straight, 10-1/4" (26 cm)
185222	Curved, 10" (25.5 cm)

FORCEPS AND CLAMPS

Gastrointestinal Forceps and Clamps

PENNINGTON FORCEPS



CATALOG #	DESCRIPTION
475250	Serrated, triangular, 14 x 11 mm jaw, 6-1/8" (15.5 cm)
616370	Serrated, triangular, 16 x 12.5 mm jaw, 8-1/4" (21 cm)

PILLING® GUT AND COLON CLAMPS

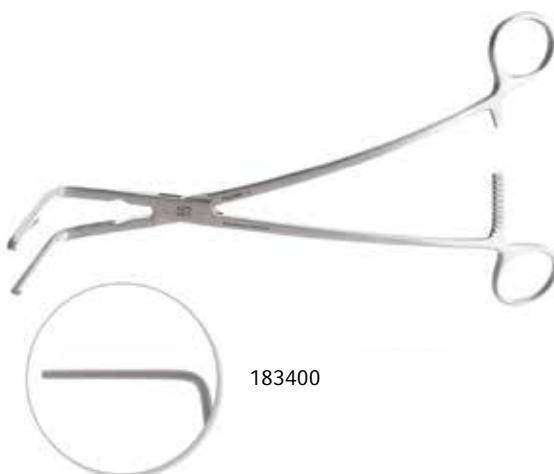

90 degree angled, 1 x 2 DeBakey®-type jaws, curved shafts.

CATALOG #	DESCRIPTION
183400	2-3/4" (7 cm) jaws, 9-3/8" (24 cm)
183410	3-5/8" (9 cm) jaws, 9-5/8" (24.5 cm)



FORCEPS AND CLAMPS

Gastrointestinal Forceps and Clamps

STONE INTESTINAL CLAMPS



Handle may be used at any angle. Narrow longitudinally serrated blades. Set consists of 2 clamps with tip locks and 2 applying forceps.

CATALOG #	DESCRIPTION
185402	Set. With 4-3/8" (11 cm) length clamps
185404	Clamp with tip lock, 3-3/8" (8.5 cm)

STRELINGER RIGHT ANGLE CLAMP

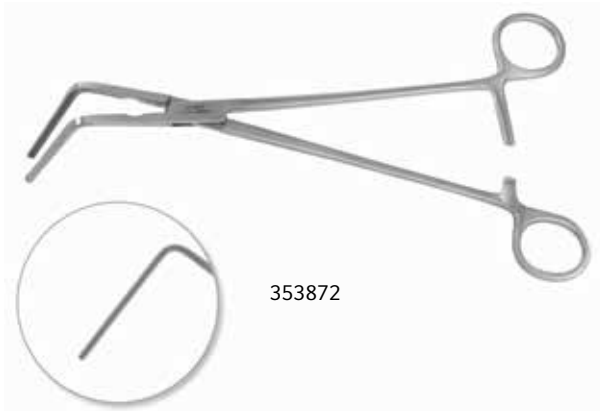

CATALOG #	DESCRIPTION
353872	Large size, 3-1/4" (8.5 cm) DeBakey®-type jaws angled 90 degrees, 9-5/8" (24.5 cm)

SCISSORS

Bandage Scissors and Shears

ESMARCH BANDAGE SCISSORS



142425

One large finger ring.

CATALOG #	DESCRIPTION
142425	7-3/4" (19.5 cm)

ESMARCH PLASTER SHEARS



463885

CATALOG #	DESCRIPTION
463885	7-7/8" (20 cm)

HERCULES PLASTER SCISSORS



KM31834

For lightweight plaster or aluminum casts.

CATALOG #	DESCRIPTION
KM31834	Angled, one blade serrated, 7-1/2" (19 cm)

0 in

1

2

3

4

5

6

7

8

9

SCISSORS

Bandage Scissors and Shears

HI-LEVEL BANDAGE SCISSORS



KM31792

The delicate offset shanks provide better leverage. The fine knob slides easily under finger and toe bandages.

CATALOG #	DESCRIPTION
KM31792	Shanks angled on side, one serrated blade, 5-1/2" (14 cm)

KMEDIC® UTILITY SHEARS



KM31836

Effective for cloth or cotton wadding. One smooth and one serrated blade.

CATALOG #	DESCRIPTION
KM31836	8-1/4" (21 cm)

KNOWLES BANDAGE SCISSORS



KM31804

For finger and toe bandages.

CATALOG #	DESCRIPTION
KM31804	Straight, one serrated blade, 5-1/2" (14 cm)

SCISSORS

Bandage Scissors and Shears

LISTER BANDAGE SCISSORS



KM31680

CATALOG #	DESCRIPTION
KM31680	4-1/2" (11.5 cm)

LISTER BANDAGE SCISSORS



142415

Pilling® Pattern, satin finish.

CATALOG #	DESCRIPTION
142415	5-3/4" (14.5 cm)
142420	7-1/4" (18.5 cm)
142422	8" (20.5 cm)

LISTER BANDAGE SCISSORS



463810

Weck® Pattern, bright finish.

CATALOG #	DESCRIPTION
463810	5-3/4" (14.5 cm)
463830	7-1/4" (18.5 cm)

0 in

1

2

3

4

5

6

7

8

9

SCISSORS

Bandage Scissors and Shears

LISTER BANDAGE SCISSORS



One large finger ring.

CATALOG #	DESCRIPTION
463840	8" (20.5 cm)

MOLESKIN SCISSORS



One blade serrated.

CATALOG #	DESCRIPTION
KM69820	Straight, 7" (18 cm)
KM69824	Curved, 7-1/2" (19 cm)

SCISSORS

Bandage Scissors and Shears

MAKI™ SCISSORS



463820

Uniquely designed teeth to grip bottle caps, needles, tubing.

CATALOG #	DESCRIPTION
463820	5-3/4" (14.5 cm)

UNIVERSAL SHEARS



142452

Stainless steel, comfortable polymer handles, serrated.

CATALOG #	DESCRIPTION
142452	7-1/2" (19 cm)
KM11202	Red handles, 7-1/2" (19 cm)

0 in

1

2

3

4

5

6

7

8

9

SCISSORS

Stitch and Suture Removal Scissors

HILL STITCH SCISSORS

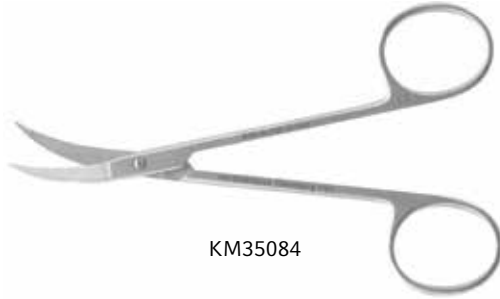

KM35084

CATALOG #	DESCRIPTION
KM35084	Curved, 4-3/8" (11 cm)

LITTAUER STANDARD SUTURE SCISSORS



142325

CATALOG #	DESCRIPTION
142325	5-1/2" (14 cm)

LITTAUER STITCH SCISSORS



KM35120

CATALOG #	DESCRIPTION
KM35120	Straight, 5-1/2" (14 cm)

SCISSORS

Stitch and Suture Removal Scissors

LITTLER STITCH SCISSORS



CATALOG #	DESCRIPTION
KM35078	Curved, 4-5/8" (11.5 cm)

NORTHBENT STITCH SCISSORS



CATALOG #	DESCRIPTION
KM35104	Curved on side, 5-1/8" (13 cm)

0 in

1

2

3

4

5

6

7

8

9



SCISSORS

Stitch and Suture Removal Scissors

SHORTBENT STITCH SCISSORS



CATALOG #	DESCRIPTION
KM35080	Curved on side, delicate, 3-1/2" (9 cm)

SPENCER SCISSORS



Pilling® Pattern, satin finish. Very delicate for fine sutures.

CATALOG #	DESCRIPTION
142312	5" (12.5 cm)

SCISSORS

Stitch and Suture Removal Scissors

SPENCER STITCH SCISSORS



KM35092

KMedic® Pattern, satin finish. Delicate, straight.

CATALOG #	DESCRIPTION
KM35068	3-1/2" (9 cm)
KM35092	4-3/4" (12 cm)

SPENCER STITCH SCISSORS



520135

520140

Weck® Pattern, bright finish.

CATALOG #	DESCRIPTION
520135	Slightly curved, 20 mm blades, 3-1/2" (9 cm)
520140	Straight, serrated, 30 mm blades, 5" (12.5 cm)

0 in

1

2

3

4

5

6

7

8

9

SCISSORS

Stitch and Suture Removal Scissors

SUTURE REMOVAL SCISSORS



Weck® Pattern, bright finish.

CATALOG #	DESCRIPTION
056120	Curved, pointed, 22 mm blades, 4-3/4" (12 cm)

Wire Cutting Scissors

BANTAM WIRE CUTTING SCISSORS



Serrated 18 mm blades.

CATALOG #	DESCRIPTION
520150	Straight, 4-3/8" (11 cm)
520152	Curved, 4" (10 cm)

SCISSORS

Wire Cutting Scissors

HEATH SUTURE AND WIRE CUTTING SCISSORS



520120

CATALOG #	DESCRIPTION
520120	Curved sideways, serrated, 23 mm blades, 6" (15 cm)

ROGER WIRE CUTTING SCISSORS



520130

Weck® Pattern, bright finish.

CATALOG #	DESCRIPTION
520130	One serrated blade, 15 mm blades angled sideways, 5" (12.5 cm)

WIRE SCISSORS



142518

Pilling® Pattern, satin finish. Angular with notch for wire.

CATALOG #	DESCRIPTION
142515	Stainless steel blades, one serrated, 5" (12.5 cm)
142518	TC blades, 5" (12.5 cm)

SCISSORS

Wire Cutting Scissors

WIRE CUTTING SCISSORS



KMedic® Pattern, satin finish.

CATALOG #	DESCRIPTION
KM35200	Angular carbide, one serrated blade, 4-3/4" (12 cm), TC

VERNON WIRE SCISSORS



Straight, serrated blades.

CATALOG #	DESCRIPTION
790310	32 mm blades, 5-3/4" (14.5 cm)
790315	42 mm blades, 7-1/2" (19 cm)

Operating Scissors

DELICATE OPERATING SCISSORS



Sharp/Blunt.

CATALOG #	DESCRIPTION
460180	Straight, 5" (12.5 cm)

SCISSORS

Operating Scissors

OPERATING SCISSORS, B/B



460170

Blunt/Blunt, stainless steel.

CATALOG #	DESCRIPTION
460165	Straight, 5" (12.5 cm)
460219	Curved, 5-1/2" (14 cm)
460170	Straight, 5-3/4" (14.5 cm)
460179	Straight, 6" (15 cm)
460177	Straight, 7" (18 cm)

OPERATING SCISSORS, S/B



460220

Sharp/Blunt, stainless steel.

CATALOG #	DESCRIPTION
460100	Straight, 4-3/4" (12 cm)
460105	Straight, 5" (12.5 cm)
460110	Straight, 5-1/2" (14 cm)
460220	Curved, 5-1/2" (14 cm)
460175	Straight, 6" (15 cm)
460115	Straight, 6-3/4" (17 cm)

OPERATING SCISSORS, S/S



460245

Sharp/Sharp, stainless steel.

CATALOG #	DESCRIPTION
460245	Curved, 5-1/2" (14 cm)
460135	Straight, 5" (12.5 cm)
460140	Straight, 5-1/2" (14 cm)

0 in

1

2

3

4

5

6

7

8

9

SCISSORS

Operating Scissors

OPERATING SCISSORS, TC



464502

5-1/2" (14 cm), TC.

CATALOG #	DESCRIPTION
464500	Sharp/Blunt
464502	Sharp/Sharp

OPERATING SCISSORS



141146

141106

Pilling® Pattern, satin finish.

CATALOG #	DESCRIPTION
141146	Sharp/Blunt, straight, 5-1/2" (14 cm)
141106	Sharp/Sharp, straight, 5-3/4" (14.5 cm)

Mayo-Type Scissors

MAYO BEVELED BLADE SCISSORS



141317

CATALOG #	DESCRIPTION
141310	Straight, 5-3/4" (14.5 cm)
141315	Curved, 5-3/4" (14.5 cm)
141312	Straight, 6-3/4" (17 cm)
141317	Curved, 6-3/4" (17 cm)

SCISSORS

Mayo-Type Scissors

MAYO ROUND SURFACE BLADE SCISSORS



141332

CATALOG #	DESCRIPTION
141332	Straight, 6-3/4" (17 cm)

MAYO DISSECTING SCISSORS



460400

Weck® Pattern, bright finish.

CATALOG #	DESCRIPTION
460410	Curved, 43 mm blades, 5-1/2" (14 cm)
460400	Straight, 43.5 mm blades, 5-5/8" (14.5 cm)
460420	Straight, 51.5 mm blades, 6-3/4" (17 cm)
460430	Curved, 49.5 mm blades, 6-3/4" (17 cm)
460620	Straight, 64 mm blades, 8-3/4" (22 cm)
460630	Curved, 64 mm blades, 8-3/4" (22 cm)

MAYO DISSECTING SCISSORS



460461

Weck® Pattern, bright finish, lightweight, 6-1/2" (16.5 cm).

CATALOG #	DESCRIPTION
460460	Straight
460461	Curved

SCISSORS

Mayo-Type Scissors

MAYO DISSECTING SCISSORS, TC



Pilling® Pattern, satin finish. Beveled blade.

CATALOG #	DESCRIPTION
142220	Curved, 5-1/2" (14 cm), TC
142235	Curved, 9" (23 cm), TC
142237	Straight, 9" (23 cm), TC

MAYO DISSECTING SCISSORS, TC



Weck® Pattern, bright finish. Round blade.

CATALOG #	DESCRIPTION
464605	Curved, 5-3/4" (14.5 cm), TC
464615	Curved, 6-1/2" (16.5 cm), TC
464600	Straight, 5-3/4" (14.5 cm), TC
464610	Straight, 6-1/2" (16.5 cm), TC

SCISSORS

Mayo-Type Scissors

MAYO NOBLE SCISSORS



6-1/2" (16.5 cm).

CATALOG #	DESCRIPTION
460600	Straight
460601	Curved

MAYO-HARRINGTON SCISSORS



11" (28 cm).

CATALOG #	DESCRIPTION
462120	Straight
462121	Curved

MAYO-STILLE SCISSORS



CATALOG #	DESCRIPTION
KM34306	Straight, 5-1/2" (14 cm)
KM34308	Curved, 5-1/2" (14 cm)
KM34310	Straight, 6-3/4" (17 cm)
KM34312	Curved, 6-3/4" (17 cm)

0 in

1

2

3

4

5

6

7

8

9

SCISSORS

Mayo-Type Scissors

CHURCH SCISSORS



352250

Lightly constructed, long scissors with a beveled surface. Mayo style blades. Blunt, dissecting tips.

CATALOG #	DESCRIPTION
352250	Curved, 6-3/4" (17 cm)
352240	Straight, 7" (18 cm)

COOLEY-MAYO CURVED SCISSORS

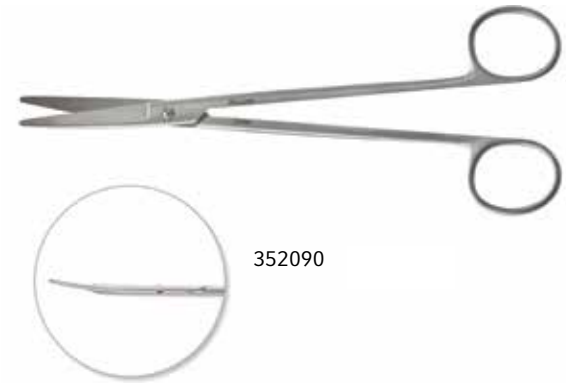

352090

CATALOG #	DESCRIPTION
352090	7-1/2" (19 cm)

DOYEN ABDOMINAL SCISSORS



KM34336

KMedic® Pattern, satin finish.

CATALOG #	DESCRIPTION
KM34334	Straight, 7" (18 cm)
KM34336	Curved, 7" (18 cm)



SCISSORS

Mayo-Type Scissors

DOYEN SCISSORS



141395

Pilling® Pattern, satin finish.

CATALOG #	DESCRIPTION
141395	Straight, 7-1/4" (18.5 cm)

DOYEN FERGUSON SCISSORS



460720

CATALOG #	DESCRIPTION
460720	Angled on flat, 59 mm blades, 7-1/8" (18 cm)

SIMS SCISSORS



KM67174

8" (20.5 cm).

CATALOG #	DESCRIPTION
KM67164	Straight, Sharp/Sharp blades
KM67166	Straight, Sharp/Blunt blades
KM67168	Straight, Blunt/Blunt blades
KM67170	Curved, Sharp/Sharp blades
KM67172	Curved, Sharp/Blunt blades
KM67174	Curved, Blunt/Blunt blades

SCISSORS

Mayo-Type Scissors

SISTRUNK FINE SCISSORS



Delicate, 5-1/2" (14 cm).

CATALOG #	DESCRIPTION
KM34348	Straight
KM34354	Curved

SISTRUNK HEAVY SCISSORS



CATALOG #	DESCRIPTION
KM34356	Straight, 5-1/2" (14 cm)

JORGENSON SCISSORS



Heavy, rigid body with acutely curved blades that taper to a rounded narrow tip.

CATALOG #	DESCRIPTION
342273	8-3/4" (22 cm)

SCISSORS

Mayo-Type Scissors

THOREK SCISSORS



Medium weight construction, round surface, acutely curved blades.

CATALOG #	DESCRIPTION
342270	7-1/4" (18.5 cm)
342272	10" (25.5 cm)

MARTIN CARTILAGE SCISSORS



CATALOG #	DESCRIPTION
790320	Curved, serrated blades, 8" (20.5 cm)

DEAN SCISSORS

CATALOG #	DESCRIPTION
KM34642	Angled, serrated, 7" (18 cm)

GORNEY RHYTIDECTOMY SCISSORS



CATALOG #	DESCRIPTION
442560	Straight, serrated, 6-3/4" (17 cm)

0 in

1

2

3

4

5

6

7

8

9

SCISSORS

Metzenbaum-Type Scissors

BABY METZENBAUM SCISSORS



Weck® Pattern, bright finish.

CATALOG #	DESCRIPTION
056310	Curved, 5-3/4" (14.5 cm)

LAHEY (BABY METZ) SCISSORS



Pilling® Pattern, satin finish.

CATALOG #	DESCRIPTION
141450	Straight, 5-3/4" (14.5 cm)
141452	Curved, 5-3/4" (14.5 cm)

METZENBAUM SCISSORS, DELICATE

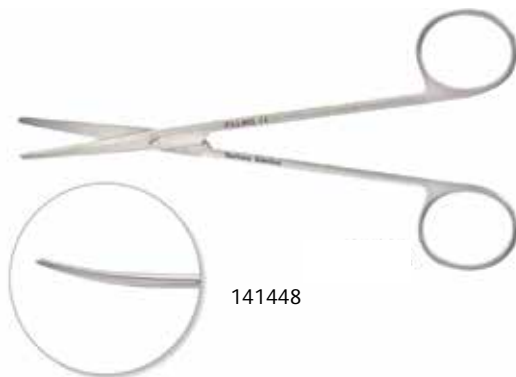

Pilling® Pattern, satin finish. Delicate curved.

CATALOG #	DESCRIPTION
141448	5-1/2" (14 cm)
352235	7" (18 cm)
352237	8" (20.5 cm)

SCISSORS

Metzenbaum-Type Scissors

METZENBAUM SCISSORS, DELICATE

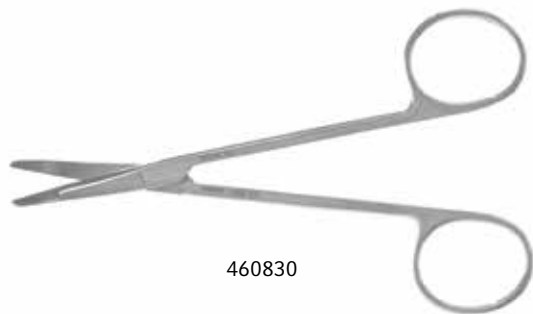

CATALOG #	DESCRIPTION
460830	Curved, 29 mm delicate blades with cut-out, 5" (12.5 cm)

METZENBAUM SCISSORS



Pilling® Pattern, satin finish.

CATALOG #	DESCRIPTION
141460	Straight, 7" (18 cm)
141462	Curved, 7" (18 cm)
141467	Curved, 8-1/4" (21 cm)
141469	Curved, 9" (23 cm)

0 in

1

2

3

4

5

6

7

8

9



SCISSORS

Metzenbaum-Type Scissors

METZENBAUM SCISSORS

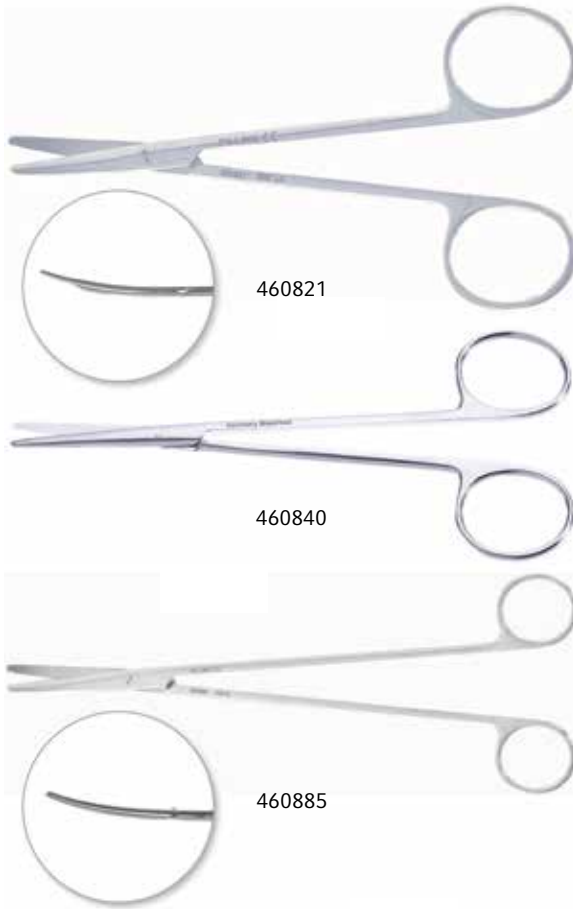

Weck® Pattern, bright finish.

CATALOG #	DESCRIPTION
460820	Straight, 5" (12.5 cm)
460821	Curved, 5" (12.5 cm)
460840	Straight, 5-3/8" (13.5 cm)
460841	Curved, 5-3/8" (13.5 cm)
460880	Straight, 5-3/8" (13.5 cm)
460881	Curved, 5-3/8" (13.5 cm)
460870	Straight, 7" (18 cm)
460871	Curved, 7" (18 cm)
460884	Straight, 9" (23 cm)
460885	Curved, 9" (23 cm)
462105	Straight, 10-3/8" (26.5 cm)
462110	Curved, 10-1/4" (26 cm)
460889	Curved, 11" (28 cm)

SCISSORS

Metzenbaum-Type Scissors

METZENBAUM SCISSORS



KMedic® Pattern, satin finish, 6" and 8".

CATALOG #	DESCRIPTION
KM34458	Straight, 6" (15 cm)
KM34462	Curved, 6" (15 cm)
KM34472	Straight, 8" (20.5 cm)
KM34474	Curved, 8" (20.5 cm)

METZENBAUM SCISSORS, TC



Sharp/Sharp.

CATALOG #	DESCRIPTION
464707	Curved, 5-3/4" (14.5 cm), TC
464712	Straight, 7" (18 cm), TC
464718	Curved, 7" (18 cm), TC
464722	Straight, 9" (23 cm), TC
464727	Curved, 9" (23 cm), TC

0 in

1

2

3

4

5

6

7

8

9

SCISSORS

Metzenbaum-Type Scissors

METZENBAUM SCISSORS, TC



Weck® Pattern, bright finish.

CATALOG #	DESCRIPTION
464700	Straight, 5-3/4" (14.5 cm), TC
464705	Curved, 5-3/4" (14.5 cm), TC
464710	Straight, 7" (18 cm), TC
464715	Curved, 7" (18 cm), TC
464720	Straight, 9" (23 cm), TC
464725	Curved, 9" (23 cm), TC

METZENBAUM SCISSORS, DELICATE, TC



Delicate. Blunt/Blunt.

CATALOG #	DESCRIPTION
464701	Straight, 5-3/4" (14.5 cm), TC
464706	Curved, 5-3/4" (14.5 cm), TC
464711	Straight, 7" (18 cm), TC
464716	Curved, 7" (18 cm), TC
464721	Straight, 9" (23 cm), TC
464726	Curved, 9" (23 cm), TC

SCISSORS

Metzenbaum-Type Scissors

DEBAKEY® SCISSORS

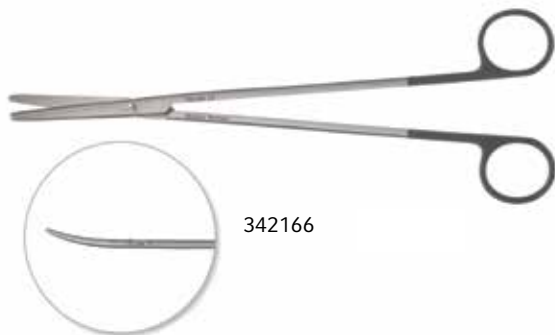

Sturdy Metzenbaum-type scissors. Black rings for quick identification.

CATALOG #	DESCRIPTION
342160	Curved, 5-3/4" (14.5 cm), TC
342162	Curved, 7" (18 cm), TC
342166	Curved, 9-1/8" (23 cm), TC
342167	Curved, 10-1/4" (26 cm), TC
342168	Curved, 11-1/4" (28.5 cm), TC
342169	Curved, 12" (30.5 cm), TC

DEBAKEY®-METZENBAUM DISSECTING SCISSORS



Curved blades. These scissors are proportionately matched in weight.

CATALOG #	DESCRIPTION
342200	Curved, 5-7/8" (15 cm)
342201	Curved, 7" (18 cm)
342202	Curved, 8-1/8" (20.5 cm)
342203	Curved, 9-1/8" (23 cm)
342204	Curved, 10-1/4" (26 cm)
342206	12-1/4" (31 cm)

DEMARTEL ACUTELY ANGLED SCISSORS



Lightweight construction.

CATALOG #	DESCRIPTION
352210	Angled on flat 50 degrees, short, 16 mm blades, sharp tips, 7" (18 cm)

SCISSORS

Metzenbaum-Type Scissors

DEMARTEL SCISSORS

Very slim, light construction.

CATALOG #	DESCRIPTION
352120	Straight, sharp blades, 6-3/4" (17 cm)
352106	Angled on flat, blunt blades, 6-3/4" (17 cm)
352109	Curved, blunt blades, 6-3/4" (17 cm)
352129	Curved, sharp blades, 6-3/4" (17 cm)
352100	Straight, blunt blades, 7" (18 cm)
352103P	Angled on flat, blunt tips, 7" (18 cm)
352123	Angled on flat, sharp blades, 7" (18 cm)
352126	Angled to side, sharp blades, 6-7/8" (17.5 cm)

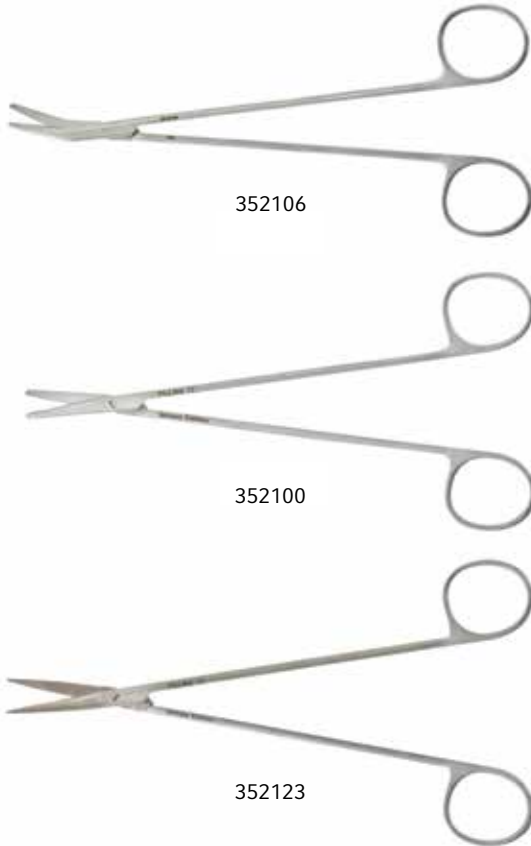

FERGUSON LONG DISSECTING SCISSORS

With Metzenbaum-type, curved blades.

CATALOG #	DESCRIPTION
342275	10-1/4" (26 cm)



SCISSORS

Metzenbaum-Type Scissors

NELSON LOBECTOMY SCISSORS

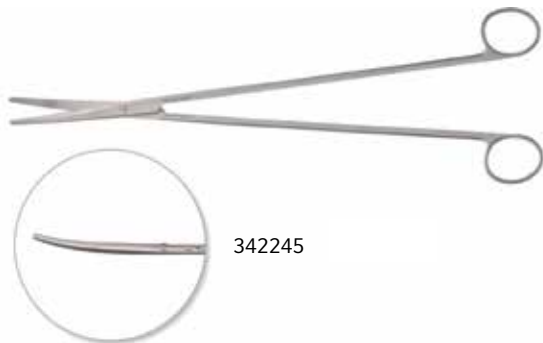

342245

Pilling® Pattern, satin finish, medium weight with rounded Metzenbaum-type curved blades.

CATALOG #	DESCRIPTION
342242	10-1/4" (26 cm)
342243	11-1/4" (28.5 cm)
342245	14-1/4" (36 cm)

NELSON SCISSORS



462149

Weck® Pattern, bright finish.

CATALOG #	DESCRIPTION
462148	Straight, 8" (20.5 cm)
462149	Curved, 8" (20.5 cm)
462150	Straight, 9" (23 cm)
462151	Curved, 9" (23 cm)

NELSON SCISSORS, TC



464801

CATALOG #	DESCRIPTION
464800	Curved, 11-1/8" (28.5 cm), TC
464801	Curved, 11-1/4" (28.5 cm), TC

0 in

1

2

3

4

5

6

7

8

9

SCISSORS

Metzenbaum-Type Scissors

JAMISON-METZENBAUM TENOTOMY SCISSORS

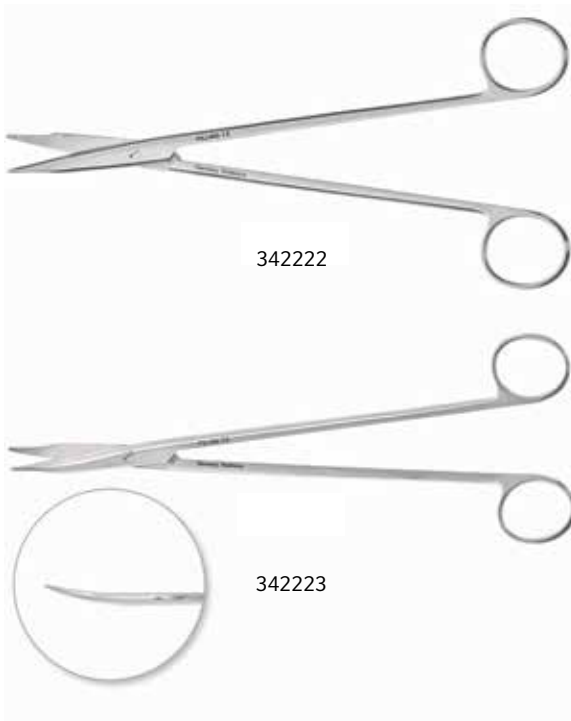

The standard Metzenbaum-style curved blades have specially narrowed tenotomy-type distal tips.

CATALOG #	DESCRIPTION
342220	6" (15 cm)
342221	7" (18 cm)
342222	8" (20.5 cm)
342223	9" (23 cm)

POTTS TENOTOMY SCISSORS



CATALOG #	DESCRIPTION
640280	Curved, 6" (15 cm)

SCISSORS

Metzenbaum-Type Scissors

LINCOLN-METZENBAUM SCISSORS



Rounded, narrow dissecting tips.

CATALOG #	DESCRIPTION
460883	Curved, 5-3/8" (13.5 cm)
460873	Curved, 7" (18 cm)

LINCOLN SCISSORS

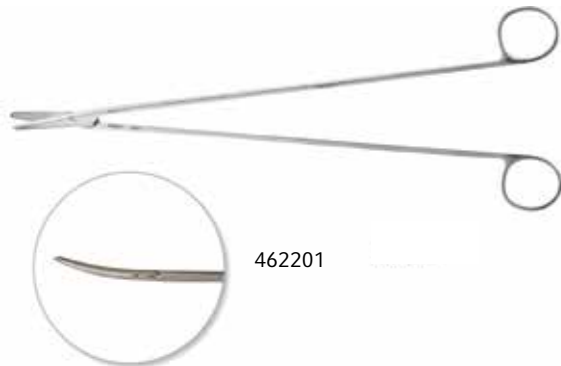

Small, rounded dissecting blades.

CATALOG #	DESCRIPTION
461310	Straight, 6-1/2" (16.5 cm)
461311	Curved, 6-1/2" (16.5 cm)
462201	Curved, 11" (28 cm)

STRULLY PROBED TIP SCISSORS

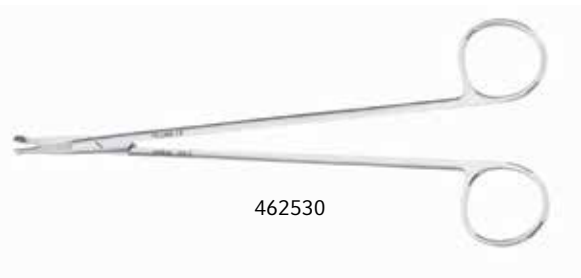

CATALOG #	DESCRIPTION
462530	Curved, 8" (20.5 cm)

0 in

1

2

3

4

5

6

7

8

9

SCISSORS

Delicate and Iris-Type Scissors

DIGITATE®-HEIFETZ SCISSORS



066102

CATALOG #	DESCRIPTION
066102	Curved, 5-3/4" (14.5 cm)
066100	Straight, 5-3/4" (14.5 cm)
066104	Straight, 4-3/4" (12 cm)

MCCLURE IRIS SCISSORS



144295

CATALOG #	DESCRIPTION
144295	Angled, 4-3/4" (12 cm)



SCISSORS

Delicate and Iris-Type Scissors

IRIS SCISSORS WITH BARRAQUER HANDLE

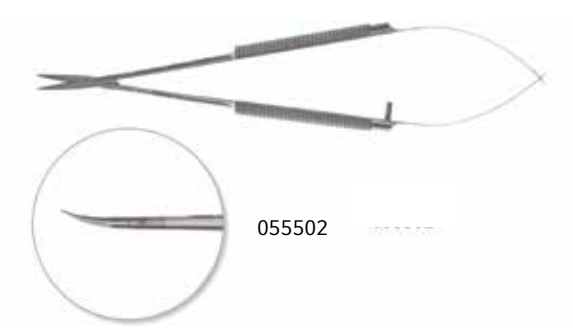

CATALOG #	DESCRIPTION
055502	Curved, 18 mm blades, 5-3/4" (14.5 cm)

055502

BLEPHAROPLASTY SCISSORS

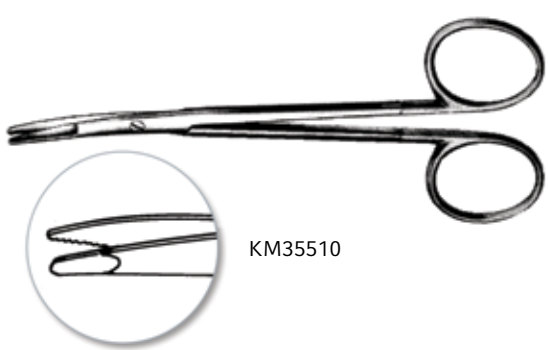

CATALOG #	DESCRIPTION
KM35510	Curved flat tips, one serrated and one carbide blade, 4-1/2" (11.5 cm), TC

KM35510

SCISSORS

Delicate and Iris-Type Scissors

GRADLE SCISSORS



Slightly curved, Sharp/Sharp.

CATALOG #	DESCRIPTION
KM53316	3-3/4" (9.5 cm)
KM53318	4" (10 cm)

IRIS MINIATURE SCISSORS



CATALOG #	DESCRIPTION
055100	Straight, 15 mm blades, 3-1/2" (9 cm)

SCISSORS

Delicate and Iris-Type Scissors

IRIS RIBBON SCISSORS



KM53267

Slightly curved, Sharp/Sharp.

CATALOG #	DESCRIPTION
KM53265	3-3/4" (9.5 cm)
KM53267	4" (10 cm)

IRIS SCISSORS



144300

Pilling® Pattern, satin finish.

CATALOG #	DESCRIPTION
144300	Straight, 4-1/2" (11.5 cm), stainless steel
144310	Curved, 4-1/2" (11.5 cm), stainless steel
144315	Straight, 4-1/2" (11.5 cm), TC
144317	Curved, 4-1/2" (11.5 cm), TC

IRIS SCISSORS



462600

Weck® Pattern, bright finish.

CATALOG #	DESCRIPTION
462600	Curved, 25 mm blades, 4-1/2" (11.5 cm)
462605	Straight, 25 mm blades, 4-1/2" (11.5 cm)
462640	Straight, 30 mm blades, 5" (12.5 cm)
462641	Curved, 28 mm blades, 5" (12.5 cm)

0 in

1

2

3

4

5

6

7

8

9

SCISSORS

Delicate and Iris-Type Scissors

IRIS SCISSORS, TC



Weck® Pattern, bright finish.

CATALOG #	DESCRIPTION
462632	Straight, 4-1/2" (11.5 cm), TC
462633	Curved, 4-1/2" (11.5 cm), TC

JOSEPH SCISSORS



CATALOG #	DESCRIPTION
442510	Straight, 5-3/4" (14.5 cm)
442512	Curved, 5-3/4" (14.5 cm)

KAYE SCISSORS



CATALOG #	DESCRIPTION
464220	Curved, 32 mm serrated blades, 4-1/2" (11.5 cm), TC

SCISSORS

Delicate and Iris-Type Scissors

KELLY FISTULA SCISSORS



KM34607

Smooth, Sharp/Sharp.

CATALOG #	DESCRIPTION
KM34602	Straight, 6-1/4" (16 cm)
KM34607	Curved, 6-1/4" (16 cm)
KM34612	Angled, 6-1/4" (16 cm)

DUFFIELD SCISSORS



461431

Sharp/Sharp.

CATALOG #	DESCRIPTION
461430	Straight, 28 mm blades, 6-1/2" (16.5 cm)
461431	Curved, 28 mm blades, 6-1/2" (16.5 cm)

KNAPP IRIS SCISSORS

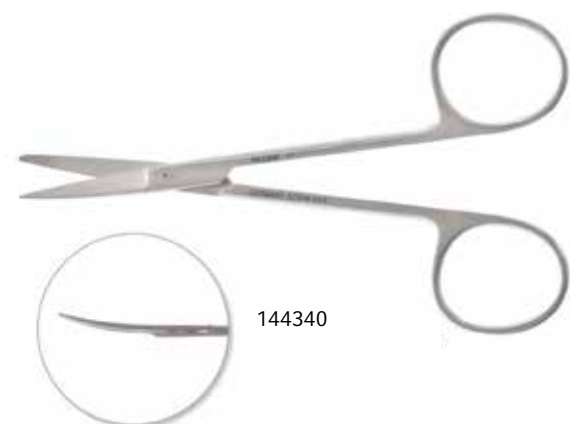

144340

One sharp and one blunt point, 4-1/2" (11.5 cm).

CATALOG #	DESCRIPTION
144338	Straight
144340	Curved



SCISSORS

Delicate and Iris-Type Scissors

LA GRANGE SCISSORS



KM34621

CATALOG #	DESCRIPTION
KM34621	Curved, 4-1/2" (11.5 cm)

PAR SCISSORS



464810

CATALOG #	DESCRIPTION
464810	Curved, 4-1/2" (11.5 cm), TC



SCISSORS

Delicate and Iris-Type Scissors

PLASTIC SCISSORS



CATALOG #	DESCRIPTION
442502	Curved, 4-3/4" (12 cm)

PLASTIC SCISSORS



Pointed, sharp, 34 mm blades, 4-3/4" (12 cm).

CATALOG #	DESCRIPTION
056200	Straight
056201	Curved

SCISSORS

Delicate and Iris-Type Scissors

RAGNELL SCISSORS, DELICATE



442576

CATALOG #	DESCRIPTION
442576	Half-curved, 4-3/4" (12 cm)

RAGNELL SCISSORS



KM34560

Curved, flat blunt tips.

CATALOG #	DESCRIPTION
KM34560	5" (12.5 cm)
KM34562	7" (18 cm)

SHEA VEIN GRAFT SCISSORS



442525

CATALOG #	DESCRIPTION
442525	Flat tips, 4-3/4" (12 cm)

SCISSORS

Delicate and Iris-Type Scissors

STEVENS TENOTOMY



KM53174

KMedic® Pattern, satin finish, Sharp/Sharp points.

CATALOG #	DESCRIPTION
KM53174	Straight, 4-3/8" (11 cm)
KM53176	Curved, 4-3/8" (11 cm)

STEVENS TENOTOMY



144352

Pilling® Pattern, satin finish, slender style.

CATALOG #	DESCRIPTION
144350	Straight, 4-1/2" (11.5 cm)
144352	Slightly curved blades, 4-1/2" (11.5 cm)

STEVENS TENOTOMY, DELICATE



442515

Pilling® Pattern, satin finish.

CATALOG #	DESCRIPTION
442515	Curved, 5" (12.5 cm)

0 in

1

2

3

4

5

6

7

8

9

SCISSORS

Delicate and Iris-Type Scissors

STEVENS TENOTOMY

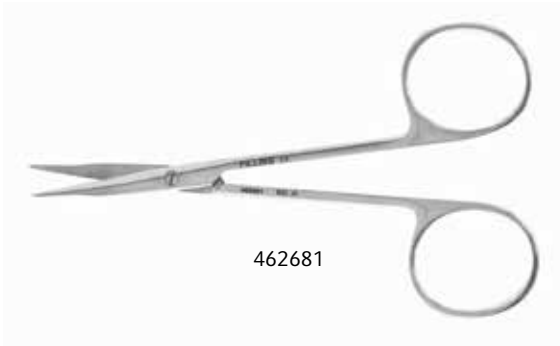

Weck® Pattern, bright finish.

CATALOG #	DESCRIPTION
462680	Straight, 4-1/2" (11.5 cm)
462681	Curved, 4-1/2" (11.5 cm)
056110	Curved, 5-1/8" (13 cm)

STRABISMUS SCISSORS



Pilling® Pattern, satin finish. Rounded blades and tips.

CATALOG #	DESCRIPTION
144319	Straight, 4-1/2" (11.5 cm), TC
144321	Curved, 4-1/2" (11.5 cm), TC
144330	Straight, round shank, 4-3/4" (12 cm), stainless steel
144332	Curved, round shank, 4-3/4" (12 cm), stainless steel

STRABISMUS SCISSORS



Weck® Pattern, bright finish. Rounded 30 mm dissecting blades.

CATALOG #	DESCRIPTION
462690	Straight, 4-1/2" (11.5 cm)
462691	Curved, 4-1/2" (11.5 cm)

SCISSORS

Delicate and Iris-Type Scissors

WUTZLER SCISSORS



28 mm dissecting blades.

CATALOG #	DESCRIPTION
462540	Straight, Blunt/Blunt blades, 5" (12.5 cm)
462541	Curved, Blunt/Blunt blades, 5" (12.5 cm)
462550	Straight, Sharp/Sharp blades, 4-3/4" (12 cm)

GOLDMAN-FOX SCISSORS

CATALOG #	DESCRIPTION
KM34648	Curved, serrated, 5" (12.5 cm)

0 in

1

2

3

4

5

6

7

8

9

SCISSORS

Super-Cut and Ultimate-Cut Scissors

Our KMedic® Super-Cut Scissors and Pilling® Ultimate-Cut Scissors are manufactured with the finest surgical stainless steel, the latest heat treating methods and master craftsmanship.

Both style scissors are designed with one razor-sharp blade edge. The Super-Cut scissors' opposite blade has a standard smooth edge, while the Ultimate-Cut scissors' opposite blade incorporates a micro-serrated edge.

SUPER-CUT LISTER BANDAGE SCISSORS



KM35210

CATALOG #	DESCRIPTION
KM35210	5-3/4" (14.5 cm)
KM35212	7-1/4" (18.5 cm)

SUPER-CUT HI-LEVEL BANDAGE SCISSORS

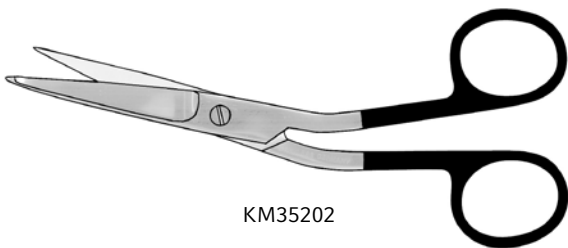

KM35202

The delicate offset shanks and the sharp Super-Cut edge provide better leverage. The fine knob slides easily under finger bandages.

CATALOG #	DESCRIPTION
KM35202	Straight, angled on side, 5-1/2" (14 cm)

SUPER-CUT LISTER BANDAGE SCISSORS WITH LARGE FINGER RING

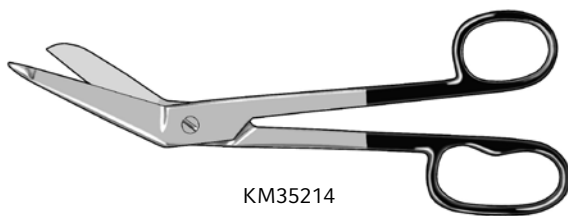

KM35214

Razor-sharp scissors ideal for cutting heavy material including: moleskin, drapes and stockinette. Not recommended for fiberglass or plaster splints. Oversized finger ring helps relieve pressure on the third metacarpal.

CATALOG #	DESCRIPTION
KM35214	Straight, 8" (20.5 cm)

SCISSORS

Super-Cut and Ultimate-Cut Scissors

SUPER-CUT OPERATING SCISSORS



KM35250

Sharp/Blunt.

CATALOG #	DESCRIPTION
KM35220	Straight, 5-1/2" (14 cm)
KM35250	Curved, 5-3/4" (14.5 cm)

SUPER-CUT MAYO SCISSORS



KM35298

Beveled blades, blunt points.

CATALOG #	DESCRIPTION
KM35280	Straight, 5-3/4" (14.5 cm)
KM35286	Curved, 5-3/4" (14.5 cm)
KM35292	Straight, 6-3/4" (17 cm)
KM35298	Curved, 6-3/4" (17 cm)
KM35316	Straight, 9-1/4" (23.5 cm)
KM35322	Curved, 9" (23 cm)
KM35340	Curved, 11" (28 cm)

ULTIMATE-CUT COOLEY SCISSORS



463950

CATALOG #	DESCRIPTION
463950	Curved, with one serrated blade, 7-3/4" (19.5 cm)

0 in

1

2

3

4

5

6

7

8

9

SCISSORS

Super-Cut and Ultimate-Cut Scissors

SUPER-CUT (BABY) METZENBAUM SCISSORS



Blunt points.

CATALOG #	DESCRIPTION
KM35364	Straight, 4-1/2" (11.5 cm)
KM35370	Curved, 4-1/2" (11.5 cm)

SUPER-CUT METZENBAUM SCISSORS



Blunt points.

CATALOG #	DESCRIPTION
KM35380	Straight, 6" (15 cm)
KM35382	Curved, 5-5/8" (14.5 cm)
KM35392	Straight, 7" (18 cm)
KM35394	Curved, 7" (18 cm)
KM35396	Curved, delicate, 7" (18 cm)
KM35406	Curved, 8" (20.5 cm)
KM35418	Curved, 9" (23 cm)
KM35430	Curved, 11-1/4" (28.5 cm)

SUPER-CUT JAMISON SCISSORS



CATALOG #	DESCRIPTION
KM35496	Curved blunt points, very delicate, 6-1/4" (16 cm)

SCISSORS

Super-Cut and Ultimate-Cut Scissors

SUPER-CUT STEVENS SCISSORS



KM35494

Blunt points. Delicate short narrow tips for dissecting fine tissue.

CATALOG #	DESCRIPTION
KM35484	Straight, 4-1/2" (11.5 cm)
KM35490	Curved, 4-1/2" (11.5 cm)
KM35494	Curved, 5-1/4" (13.5 cm)

SUPER-CUT IRIS SCISSORS



KM35452

Sharp points.

CATALOG #	DESCRIPTION
KM35450	Straight, 3-1/2" (9 cm)
KM35452	Curved, 3-1/2" (9 cm)
KM35454	Straight, 4-1/2" (11.5 cm)
KM35460	Curved, 4-1/2" (11.5 cm)

0 in

1

2

3

4

5

6

7

8

9

SCISSORS

Super-Cut and Ultimate-Cut Scissors

ULTIMATE-CUT MAYO SCISSORS



CATALOG #	DESCRIPTION
463900	Straight, 6-3/4" (17 cm)
463901	Curved, 6-3/4" (17 cm)
463903	Curved, 9-1/8" (23 cm)

ULTIMATE-CUT METZENBAUM SCISSORS



CATALOG #	DESCRIPTION
463910	Straight, 5-3/4" (14.5 cm)
463911	Curved, 5-3/4" (14.5 cm)
463912	Straight, 6-7/8" (17.5 cm)
463913	Curved, 7" (18 cm)
463915	Curved, 9" (23 cm)

ULTIMATE-CUT POTTS SCISSORS



CATALOG #	DESCRIPTION
463941	Angled 45 degrees, with one serrated blade, 7-1/4" (18.5 cm)

SCISSORS

Super-Cut and Ultimate-Cut Scissors

ULTIMATE-CUT STEVENS TENOTOMY SCISSORS



463920

CATALOG #	DESCRIPTION
463920	Straight, 4-1/2" (11.5 cm)
463921	Curved, 4-1/2" (11.5 cm)

IRIS SCISSORS



463932

Sharp/Sharp.

CATALOG #	DESCRIPTION
463930	Straight with one serrated blade, 4-1/2" (11.5 cm)
463932	Curved with one serrated blade, 4-1/2" (11.5 cm)

0 in

1

2

3

4

5

6

7

8

9

NEEDLE HOLDERS

General Needle Holders

BAUMGARTNER NEEDLE HOLDER



CATALOG #	DESCRIPTION
152710	11.7 x 2.2 mm jaw, 5-1/4" (13.5 cm), TC

BAUMGARTNER BULLDOG® NEEDLE HOLDER



CATALOG #	DESCRIPTION
510181	1.6 mm jaw, 5" (12.5 cm), TC

NEEDLE HOLDERS

General Needle Holders

BROWN NEEDLE HOLDER



055200

CATALOG #	DESCRIPTION
055200	Regular, convex jaw with fine oblique serrations, 15 x 2.7 mm, 5" (12.5 cm), stainless steel jaw

CONVERSE NEEDLE HOLDER



443100

CATALOG #	DESCRIPTION
443100	Large rings, 14 x 2.3 mm jaw, 5" (12.5 cm), stainless steel jaw

DERF NEEDLE HOLDERS



055135

Weck® Pattern, bright finish.

CATALOG #	DESCRIPTION
055135	10.2 x 2.4 mm jaw, 4-3/4" (12 cm), TC

0 in

1

2

3

4

5

6

7

8

9



NEEDLE HOLDERS

General Needle Holders

DERF NEEDLE HOLDERS



Pilling® Pattern, satin finish.

CATALOG #	DESCRIPTION
152798	7.5 x 1.7 mm jaw, 4-1/2" (11.5 cm), TC

DERF NEEDLE HOLDER STANDARD – STAINLESS STEEL JAW



CATALOG #	DESCRIPTION
443120	9.5 x 2 mm jaw, 5" (12.5 cm)

NEEDLE HOLDERS

General Needle Holders

GILLIES NEEDLE HOLDER SCISSORS



Large offset thumb ring.

CATALOG #	DESCRIPTION
152496	2.2 mm jaw, 6-1/4" (16 cm), TC

HALSEY NEEDLE HOLDERS



KMedic® Pattern, satin finish. Stainless steel jaw.

CATALOG #	DESCRIPTION
KM41064	Smooth, 2.5 mm jaw, 5" (12.5 cm)
KM41066	Serrated, 2.2 mm jaw, 5-1/4" (13.5 cm)

0 in

1

2

3

4

5

6

7

8

9

NEEDLE HOLDERS

General Needle Holders

HALSEY NEEDLE HOLDERS



Pilling® Pattern, satin finish.

CATALOG #	DESCRIPTION
152802	Smooth, 11.5 x 1.8 mm jaw, 5-1/4" (13.5 cm), TC
152800	Serrated, 11 x 2.2 mm jaw, 5-1/4" (13.5 cm), TC

JOHNSON BULLDOG® NEEDLE HOLDER



CATALOG #	DESCRIPTION
510311	9.7 x 2.5 mm, Bulldog® Jaw, 4-3/4" (12 cm), TC

JOHNSON NEEDLE HOLDER



CATALOG #	DESCRIPTION
510312	12 x 2 mm jaw, 4-3/4" (12 cm), TC

NEEDLE HOLDERS

General Needle Holders

NEIVERT NEEDLE HOLDER



Off-set ring handle.

CATALOG #	DESCRIPTION
152805	16 x 2 mm jaw, 5-1/4" (13.5 cm), TC

PAR NEEDLE HOLDERS



CATALOG #	DESCRIPTION
510335	13 x 2 mm jaw, 5" (12.5 cm), TC
510395	11 x 1.8 mm jaw, 5-1/2" (14 cm), TC



NEEDLE HOLDERS

General Needle Holders

WEBSTER NEEDLE HOLDERS



Pilling® Pattern, satin finish.

CATALOG #	DESCRIPTION
152808	10.2 x 1.8 mm smooth jaw, 4-1/2" (11.5 cm), TC

WEBSTER NEEDLE HOLDERS



Weck® Pattern, bright finish.

CATALOG #	DESCRIPTION
510325	Delicate, smooth, 13 x 2.2 mm jaw, 4-3/4" (12 cm), TC

NEEDLE HOLDERS

General Needle Holders

WEBSTER BULLDOG® NEEDLE HOLDER



510321

Weck® Pattern, bright finish.

CATALOG #	DESCRIPTION
510321	Delicate, smooth, 13.5 x 2 mm Bulldog® jaw, 4-3/4" (12 cm), TC

WEBSTER NEEDLE HOLDERS



152448

CATALOG #	DESCRIPTION
152448	16 x 2.2 mm smooth stainless steel jaw, 5" (12.5 cm)

0 in

1

2

3

4

5

6

7

8

9

NEEDLE HOLDERS

General Needle Holders

WEBSTER NEEDLE HOLDERS



KM41068

CATALOG #	DESCRIPTION
KM41068	Smooth, stainless steel jaw, 5" (12.5 cm)

OLSEN-HEGAR NEEDLE HOLDER AND SCISSORS



510440

510441

Weck® Pattern, bright finish.

CATALOG #	DESCRIPTION
510440	11 x 3.2 mm jaw, 5-3/4" (14.5 cm), TC
510441	15 x 3.1 mm jaw, 6" (15 cm), stainless steel jaw
510445	11.5 x 3.2 mm jaw, 7" (18 cm), TC

NEEDLE HOLDERS

General Needle Holders

OLSEN-HEGAR NEEDLE HOLDERS



Combination needle holder and suture scissors.
KMedic® Pattern, satin finish.

CATALOG #	DESCRIPTION
KM41424	Delicate, 4-3/4" (12 cm)
KM41428	5" (12.5 cm)
KM41440	Delicate, 4-1/2" (11.5 cm), TC
KM41452	6-1/2" (16.5 cm), TC

RYDER FRENCH EYE NEEDLE HOLDERS



Pilling® Pattern, satin finish.

CATALOG #	DESCRIPTION
152760	20 x 2 mm jaw, 6" (15 cm), TC
152762	20.5 x 2 mm jaw, 7-1/4" (18.5 cm), TC
152764	20 x 2 mm jaw, 8" (20.5 cm), TC



NEEDLE HOLDERS

General Needle Holders

RYDER BULLDOG® NEEDLE HOLDERS

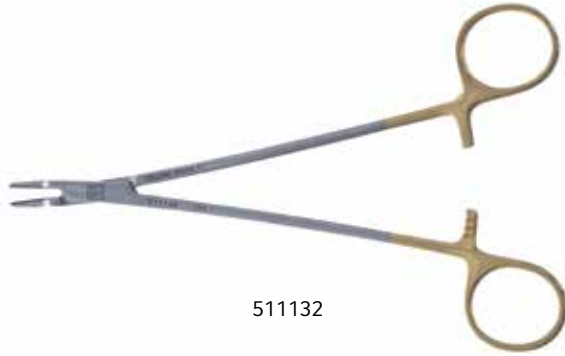

511132

Weck® Pattern, bright finish. French eye with fine serrations and delicate, tapered, Bulldog® Jaw.

CATALOG #	DESCRIPTION
511115	9.5 x 2 mm jaw, 5" (12.5 cm), TC
511130	12 x 2 mm jaw, 6" (15 cm), TC
511132	13 x 1.7 mm jaw, 7" (18 cm), TC
511134	13 x 2 mm jaw, 7-3/4" (19.5 cm), TC
511138	12.5 x 1.8 mm jaw, 10" (25.5 cm), TC

RYDER NEEDLE HOLDERS

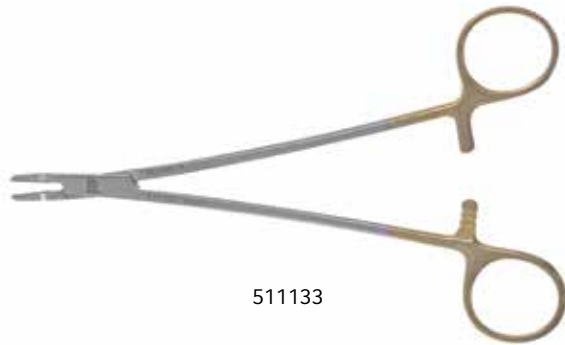

511133

Weck® Pattern, bright finish. French eye with fine serrations and delicate, tapered jaw.

CATALOG #	DESCRIPTION
511131	12.5 x 2 mm jaw, 6-1/4" (16 cm), TC
511133	13 x 2.2 mm jaw, 7" (18 cm), TC
511135	12.5 x 1.7 mm jaw, 8" (20.5 cm), TC
511139	12 x 2 mm jaw, 10" (25.5 cm), TC

RYDER EXTRA-FINE TECHNIQUE® NEEDLE HOLDERS



354994

Pilling® Pattern, satin finish. Sculptured 1 mm wide jaws designed for the finest vascular, plastic and nerve suture needles. Lightweight throughout (average weight 1 oz).

CATALOG #	DESCRIPTION
354990	11.5 x 1.3 mm jaw, 5-1/4" (13.5 cm), TC
354992	12.5 x 1.2 mm jaw, 6" (15 cm), TC
354994	14.3 x 1.2 mm jaw, 7" (18 cm), TC
354996	14.5 x 1.2 mm jaw, 8" (20.5 cm), TC
354998	15 x 1.3 mm jaw, 9" (23 cm), TC



NEEDLE HOLDERS

General Needle Holders

CRILE WOOD NEEDLE HOLDERS



Pilling® Pattern, satin finish.

CATALOG #	DESCRIPTION
152771	Left-handed, 7" (18 cm), TC
152780	6" (15 cm), TC
152781	Smooth, 6" (15 cm), TC
152782	7" (18 cm), TC
152784	8" (20.5 cm), TC
152786	9" (23 cm), TC
152790	Curved, 7" (18 cm), TC
152792	Curved, 9-1/4" (23.5 cm), TC

CRILE WOOD NEEDLE HOLDERS



Weck® Pattern, bright finish. Delicate, tapered tip.

CATALOG #	DESCRIPTION
510400	6" (15 cm), TC
510405	7" (18 cm), TC
510410	8" (20.5 cm), TC
510415	9" (23 cm), TC
510420	10-1/4" (26 cm), TC
510430	12-1/4" (31 cm), TC

NEEDLE HOLDERS

General Needle Holders

CRILE MURRAY BULLDOG® NEEDLE HOLDERS



510241

Weck® Pattern, bright finish. Long, slender Bulldog® Jaw.

CATALOG #	DESCRIPTION
510241	15.4 x 1.8 mm jaw, 6-1/4" (16 cm), TC
510251	15.5 x 2.4 mm jaw, 7" (18 cm), TC

CRILE WOOD BULLDOG® NEEDLE HOLDERS



510211

Weck® Pattern, bright finish. Bulldog® Jaw.

CATALOG #	DESCRIPTION
510201	Light, 6-1/4" (16 cm), TC
510211	Heavy, 6-1/4" (16 cm), TC

NEEDLE HOLDERS

General Needle Holders

HEGAR BAUMGARTNER NEEDLE HOLDERS



Serrated stainless steel jaw.

CATALOG #	DESCRIPTION
KM41162	Serrated, 5" (12.5 cm)
KM41164	Serrated, 5-3/4" (14.5 cm)

MAYO HEGAR NEEDLE HOLDERS



Pilling® Pattern, satin finish.

CATALOG #	DESCRIPTION
152720	14.5 x 3 mm jaw, 6-1/2" (16.5 cm), TC
152402	23 x 2.8 mm jaw, 7-1/4" (18.5 cm), TC
152722	16.5 x 3.3 mm jaw, 7-1/2" (19 cm), TC
152724	17 x 2.8 mm jaw, 8" (20.5 cm), TC
152406	17 x 2.8 mm jaw, 9-1/4" (23.5 cm), TC
152772	Left-handed, 13 x 2.4 mm jaw, 6-1/4" (16 cm), TC

0 in

1

2

3

4

5

6

7

8

9

NEEDLE HOLDERS

General Needle Holders

MAYO HEGAR NEEDLE HOLDERS



Weck® Pattern, bright finish, narrow.

CATALOG #	DESCRIPTION
510100	14.6 x 2.6 mm jaw, 6" (15 cm), TC
510110	16.2 x 2.8 mm jaw, 7" (18 cm), TC
510120	15.7 x 3 mm jaw, 8" (20.5 cm), TC
510130	16.4 x 3.2 mm jaw, 9" (23 cm), TC
510140	16.3 x 3.5 mm jaw, 11-3/4" (30 cm), TC

MAYO HEGAR NEEDLE HOLDERS

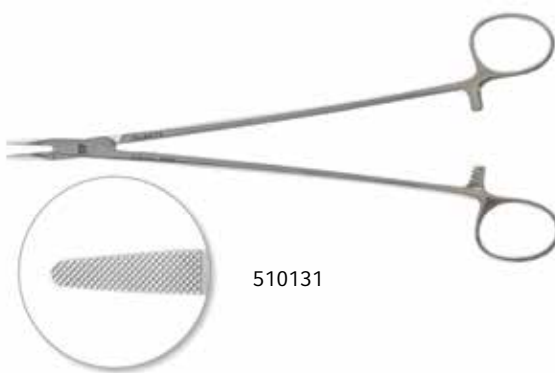

Weck® Pattern, bright finish, Bulldog® Jaw, narrow.

CATALOG #	DESCRIPTION
510101	15.5 x 3 mm jaw, 6" (15 cm), TC
510111	16 x 2.8 mm jaw, 7" (18 cm), TC
510121	19 x 2.7 mm jaw, 8" (20.5 cm), TC
510131	20 x 3 mm jaw, 9" (23 cm), TC

NEEDLE HOLDERS

General Needle Holders

MAYO HEGAR NEEDLE HOLDERS



Serrated, stainless steel jaw.

CATALOG #	DESCRIPTION
KM41270	5-1/2" (14 cm)
KM41272	6" (15 cm)
KM41278	7" (18 cm)
KM41284	8" (20.5 cm)
KM41286	10-1/2" (26.5 cm)
KM41300	5" (12.5 cm), TC

MAYO HEGAR BROAD BULLDOG® NEEDLE HOLDERS

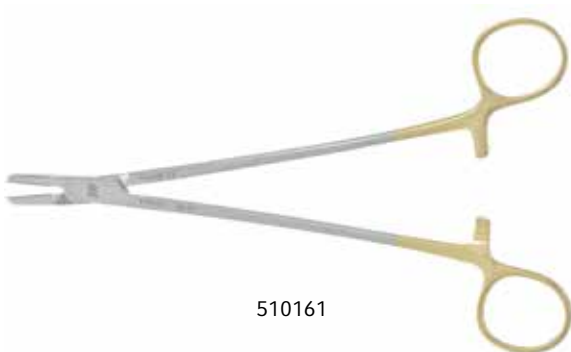

Weck® Pattern, bright finish, Bulldog® Jaw, broad.

CATALOG #	DESCRIPTION
510151	12 x 4 mm jaw, 7" (18 cm), TC
510161	17 x 3.5 mm jaw, 8" (20.5 cm), TC

MASSON BULLDOG® NEEDLE HOLDERS



CATALOG #	DESCRIPTION
511101	Heavy, 18.5 x 3 mm jaw, 10-1/4" (26 cm), TC
511102	Light, 18.5 x 3.2 mm jaw, 10-1/4" (26 cm), TC

NEEDLE HOLDERS

General Needle Holders

MASSON NEEDLE HOLDERS

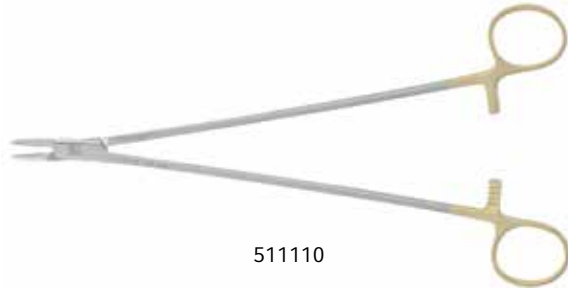

511110

CATALOG #	DESCRIPTION
511110	15.5 x 2.4 mm jaw, 7" (18 cm), TC
511112	16 x 3.2 mm jaw, 11-3/4" (30 cm), TC

HEANEY BULLDOG® NEEDLE HOLDER

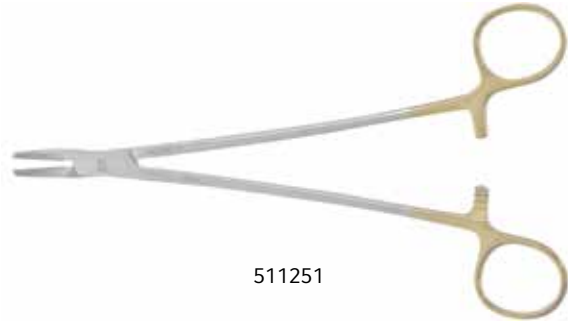

511251

CATALOG #	DESCRIPTION
511251	19.3 x 3.2 mm curved Bulldog® Jaw, 8" (20.5 cm), TC

HEANEY NEEDLE HOLDERS



511250

CATALOG #	DESCRIPTION
511250	20.5 x 2.6 mm curved jaw with cross serrations, 8" (20.5 cm), TC

NEEDLE HOLDERS

General Needle Holders

HEANEY NEEDLE HOLDERS



CATALOG #	DESCRIPTION
511252	3.2 mm curved jaw, 8" (20.5 cm), serrated stainless steel jaw

HEANEY NEEDLE HOLDERS



CATALOG #	DESCRIPTION
152837	25.6 x 2.5 mm curved jaw, 10-1/2" (26.5 cm), TC

MCALLISTER BULLDOG® NEEDLE HOLDER

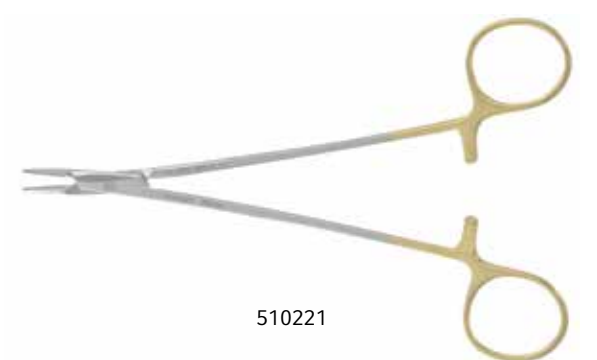

CATALOG #	DESCRIPTION
510221	Long, delicate, 14.5 x 1.8 mm, Bulldog® Jaw, 7" (18 cm), TC

0 in

1

2

3

4

5

6

7

8

9



NEEDLE HOLDERS

General Needle Holders

SAROT NEEDLE HOLDERS



510467

Weck® Pattern, bright finish. Parallel shanks with offset finger rings.

CATALOG #	DESCRIPTION
510467	16.5 x 1.8 mm jaw, 7" (18 cm), TC
510469	17 x 1.8 mm jaw, 9" (23 cm), TC

SAROT NEEDLE HOLDER



152796

CATALOG #	DESCRIPTION
152796	19.5 x 1.8 mm jaw, 10-1/4" (26 cm), TC

NEEDLE HOLDERS

General Needle Holders

STRATTE NEEDLE HOLDERS



CATALOG #	DESCRIPTION
152855	22 x 2.7 mm jaw, 8" (20.5 cm), TC
343027	Reverse curved, 9" (23 cm), TC

CVT-Type Needle Holders

BAILEY CARDIAC TECHNIQUE® NEEDLE HOLDER



Very light construction throughout with fine tapered tips. Jaws are lightly scored for use with smallest size needles and sutures. Tungsten Carbide.

CATALOG #	DESCRIPTION
354931	17 x 2 mm jaw, 7" (18 cm), TC

0 in

1

2

3

4

5

6

7

8

9

NEEDLE HOLDERS

CVT-Type Needle Holders

DEBAKEY® TECHNIQUE® NEEDLE HOLDERS



Carefully designed with light, short Tungsten Carbide jaws. Constructed in weight proportional to total length. May be purchased individually or as matched set of four.

CATALOG #	DESCRIPTION
354900	No. 1. Length, 18.2 x 2 mm jaw, 7" (18 cm), TC
354902	No. 2. Length, 21.5 x 1.8 mm jaw, 9-1/4" (23.5 cm), TC
354904	No. 3. Length, 21.5 x 2.3 mm jaw, 10-1/2" (26.5 cm), TC
354906	No. 4. Length, 19 x 2.6 mm jaw, 11-3/4" (30 cm), TC
354908	Matched set of four, TC

FINOCHIETTO NEEDLE HOLDER



CATALOG #	DESCRIPTION
152842	25.5 x 2.5 mm jaw, 10-1/2" (26.5 cm), TC

NEEDLE HOLDERS

CVT-Type Needle Holders

GERBODE TECHNIQUE® NEEDLE HOLDER



Medium-light construction. A strong full-sized needle holder with jaws tapered to 2 mm width for holding fine needles.

CATALOG #	DESCRIPTION
343000	16.5 x 2 mm jaw, 10-1/2" (26.5 cm), TC

HOWELL CORONARY TECHNIQUE® NEEDLE HOLDER



CATALOG #	DESCRIPTION
354920	14 x 1.6 mm jaw, 7-1/4" (18.5 cm), TC

HOWELL VALVE TECHNIQUE® NEEDLE HOLDER



CATALOG #	DESCRIPTION
354928	19 x 2 mm jaw, 8" (20.5 cm), TC

0 in

1

2

3

4

5

6

7

8

9

NEEDLE HOLDERS

CVT-Type Needle Holders

JAMISON TECHNIQUE® NEEDLE HOLDER



Long, slender needle holder. Jaws are lightly serrated.

CATALOG #	DESCRIPTION
354941	19.8 x 1.8 mm jaw, 9" (23 cm), TC

JULIAN NEEDLE HOLDER



CATALOG #	DESCRIPTION
510250	Straight, 21 x 2 mm jaw, 8" (20.5 cm), TC

PILLING® EXTRA-LIGHT TECHNIQUE® NEEDLE HOLDERS



Thinner shanks and box-locks than Pilling® Thin Needle Holders for reduced weight and more "feel."

CATALOG #	DESCRIPTION
354981	17 x 1.8 mm jaw, 6" (15 cm), TC
354982	17.5 x 1.6 mm jaw, 7" (18 cm), TC

NEEDLE HOLDERS

CVT-Type Needle Holders

PILLING® INTRACARDIAC TECHNIQUE® NEEDLE HOLDERS



CATALOG #	DESCRIPTION
354985	17 x 1.8 mm jaw, 7" (18 cm), TC
354986	11.5 x 1.6 mm jaw, 8" (20.5 cm), TC
354987	20.5 x 2 mm jaw, 9-1/4" (23.5 cm), TC
354988	20.5 x 2 mm jaw, 10-1/4" (26 cm), TC

PILLING® THIN VASCULAR AND CORONARY TECHNIQUE® NEEDLE HOLDERS

Delicately proportioned, slender needle holders.



CATALOG #	DESCRIPTION
354961	16 x 1.7 mm jaw, 7" (18 cm), TC
354960	16 x 1.8 mm jaw, 6" (15 cm), TC
354962	20 x 1.8 mm jaw, 8-1/4" (21 cm), TC
354958	20.5 x 1.8 mm jaw, 9" (23 cm), TC
354959	20.5 x 2.2 mm jaw, 10-1/4" (26 cm), TC



NEEDLE HOLDERS

CVT-Type Needle Holders

W.M. LEMMON TECHNIQUE® NEEDLE HOLDERS

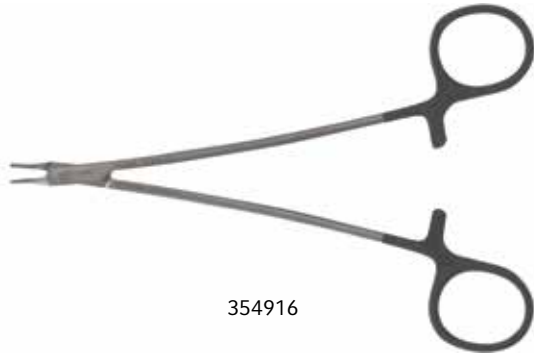

354916

CATALOG #	DESCRIPTION
354915	Delicate, 15.5 x 2.3 mm jaw, 5-3/4" (14.5 cm), TC
354916	14.5 x 1.5 mm jaw, 6-3/4" (17 cm), TC
354917	15.5 x 2.3 mm jaw, 7-1/2" (19 cm), TC

WANGENSTEEN NEEDLE HOLDER

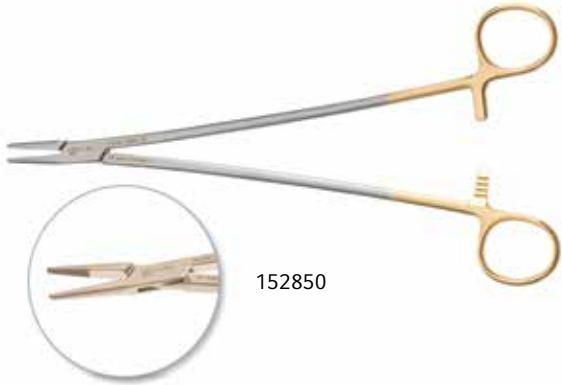

152850

CATALOG #	DESCRIPTION
152850	29.4 x 2.3 mm jaw, 10-3/4" (27.5 cm), TC

NEEDLE HOLDERS

Castro-Type Micro Needle Holders

MICRO VASCULAR ROUND HANDLE NEEDLE HOLDERS



CATALOG #	DESCRIPTION
357654	Straight, without lock, 1.1 mm smooth jaw, 7-3/8" (18.5 cm)
357655	Curved, without lock, smooth, 7-3/8" (18.5 cm)
357656	Straight, with lock, 1.2 mm smooth jaw, 7-1/2" (19 cm)
357657	Curved, with lock, 0.6 mm smooth jaw, 7-3/8" (18.5 cm)
357667	Straight, with lock, 7-3/8" (18.5 cm), TC
357672	Straight, with lock, 0.6 mm smooth jaw, 8-1/8" (20.5 cm)
357674	Straight, with lock, 0.6 mm smooth jaw, 9" (23 cm)
357675	Curved, with lock, 0.6 mm smooth jaw, 9" (23 cm)
357676	Straight, with lock, 8" (20.5 cm), TC
357677	Curved, with lock, 1 mm jaw, 8" (20.5 cm), TC

BARRAQUER MICRO NEEDLE HOLDERS



With lock, round handle.

CATALOG #	DESCRIPTION
KM44167	Straight, smooth, 5-1/2" (14 cm)
KM44163	Curved, smooth, 5-1/2" (14 cm)
KM44169	Straight, smooth, 7" (18 cm)
KM44165	Curved, smooth, 7" (18 cm)
KM44168	Straight, smooth, 5-1/2" (14 cm), TC
KM44164	Curved, smooth, 5-1/2" (14 cm), TC
KM44157	Straight, serrated, 5-1/2" (14 cm), TC
KM44155	Curved, serrated, 5-1/2" (14 cm), TC
KM44170	Straight, smooth, 7" (18 cm), TC
KM44166	Curved, smooth, 7" (18 cm), TC
KM44158	Straight, serrated, 7" (18 cm), TC
KM44156	Curved, serrated, 7" (18 cm), TC

NEEDLE HOLDERS

Castro-Type Micro Needle Holders

CASTROVIEJO NEEDLE HOLDERS

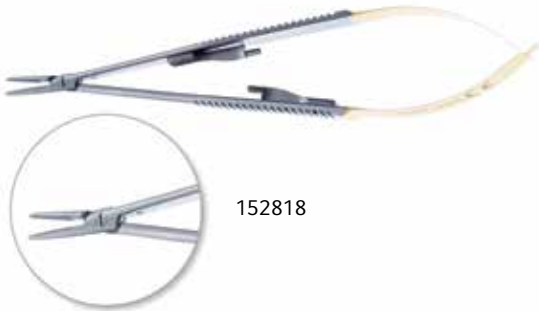

152818

CATALOG #	DESCRIPTION
152818	Straight, 11 x 1.4 mm jaw, 6" (15 cm), TC
152819	Curved, 12 x 1.4 mm jaw, 5-3/4" (14.5 cm), TC

MICRO SURGERY NEEDLE HOLDERS



152825

Flat handle, smooth jaws.

CATALOG #	DESCRIPTION
152825	Straight, 12.5 x 1.4 mm jaw, 6" (15 cm), TC
152827	Curved, 13 x 1.4 mm jaw, 6" (15 cm), TC

CASTROVIEJO MICRO NEEDLE HOLDERS



KM44204

With lock.

CATALOG #	DESCRIPTION
KM44201	Straight, serrated, 5-1/2" (14 cm)
KM44200	Curved, serrated, 5-1/2" (14 cm)
KM44204	Straight, smooth, 7" (18 cm)
KM44202	Curved, smooth, 7" (18 cm)
KM44205	Straight, serrated, 7" (18 cm)
KM44203	Curved, serrated, 7" (18 cm)
KM44208	Straight, serrated, 5-1/2" (14 cm), TC
KM44215	Straight, smooth, 7" (18 cm), TC
KM44214	Curved, smooth, 7" (18 cm), TC
KM44207	Curved, serrated, 7" (18 cm), TC

NEEDLE HOLDERS

Castro-Type Micro Needle Holders

CASTROVIEJO MICRO NEEDLE HOLDERS



KM44219

Without lock.

CATALOG #	DESCRIPTION
KM44218	Curved, serrated, 5-1/2" (14 cm)
KM44219	Straight, serrated, 5-1/2" (14 cm)
KM44220	Curved, smooth, 7" (18 cm)
KM44221	Curved, serrated, 7" (18 cm)
KM44222	Straight, smooth, 7" (18 cm)
KM44223	Straight, serrated, 7" (18 cm)

CASTROVIEJO MICRO NEEDLE HOLDERS TC



KM44210

Without lock.

CATALOG #	DESCRIPTION
KM44210	Curved, serrated, 5-1/2" (14 cm), TC
KM44211	Curved, serrated, 7" (18 cm), TC
KM44212	Straight, serrated, 5-1/2" (14 cm), TC
KM44213	Straight, serrated, 7" (18 cm), TC
KM44216	Curved, smooth, 7" (18 cm), TC
KM44217	Straight, smooth, 7" (18 cm), TC

CASTROVIEJO MICRO NEEDLE HOLDERS



35559DG

Fine, straight, with round handle and lock. 1 mm Diama-Grip jaws.

CATALOG #	DESCRIPTION
35558DG	9" (23 cm)
35559DG	10" (25.5 cm)
35560DG	12" (30.5 cm)

NEEDLE HOLDERS

Castro-Type Micro Needle Holders

CASTROVIEJO MICRO NEEDLE HOLDERS



357676DG

Round handle with Diama-Grip jaws.

CATALOG #	DESCRIPTION
357656DG	Straight, with lock, 1.2 mm, 7" (18 cm)
357676DG	Straight, with lock, 1.2 mm, 8" (20.5 cm)
357677DG	Curved without lock, 1 mm, 8" (20.5 cm)

CASTROVIEJO NEEDLE HOLDERS



354964DG

Straight, with flat handle and lock. Diama-Grip jaws.

CATALOG #	DESCRIPTION
354964DG	1.8 mm, 7-1/4" (18.5 cm)
354965DG	8" (20.5 cm)

CASTROVIEJO TECHNIQUE® NEEDLE HOLDERS



354964

CATALOG #	DESCRIPTION
354964	Straight, 13 x 1.4 mm jaw, 7-1/4" (18.5 cm), TC
354965	Straight, 13 x 1.4 mm jaw, 8" (20.5 cm), TC

NEEDLE HOLDERS

Castro-Type Micro Needle Holders

MICRO SURGERY TECHNIQUE® NEEDLE HOLDERS



354967

Flat handle, smooth jaws.

CATALOG #	DESCRIPTION
354966	Straight, 13 x 1.4 mm jaw, 7" (18 cm), TC
354967	Straight, 13 x 1.4 mm jaw, 8" (20.5 cm), TC

SPENCER CORONARY TECHNIQUE® NEEDLE HOLDER



354969

CATALOG #	DESCRIPTION
354969	Straight, smooth, 12 x 1.2 mm jaw, 0.9 mm tip, 7" (18 cm), TC

GIANNINI TECHNIQUE® NEEDLE HOLDER



354971

CATALOG #	DESCRIPTION
354971	Straight, 17.5 x 1.8 mm jaw, 10-1/4" (26 cm), TC

JACOBSON MICRO NEEDLE HOLDER



357603DG

CATALOG #	DESCRIPTION
357603DG	Straight with flat handle, lock, 18 x 1.3 mm Diama-Grip jaw, 8-1/2" (21.5 cm)

0 in

1

2

3

4

5

6

7

8

9

NEEDLE HOLDERS

Castro-Type Micro Needle Holders

JACOBSON MICRO NEEDLE HOLDERS



358002

CATALOG #	DESCRIPTION
358001	Straight, round handle, with lock, 11 x 0.8 mm Diamo-grip jaw, 9" (23 cm)
358002	Straight, round handle, with lock, 1.8 mm Diamo-grip jaw, 9" (23 cm)
358003	Straight, round handle, with lock, 16 x 0.9 mm Diamo-grip jaw, 8-1/4" (21 cm)

JACOBSON MICRO-SURGICAL NEEDLE HOLDERS



357603

Castroviejo-type lock can be removed if not required.
Stainless steel jaws.

CATALOG #	DESCRIPTION
357601	Straight, flat handle, with lock, 13 x 1.3 mm smooth jaw, 7" (18 cm)
357603	Straight, flat handle, with lock, 13.5 x 1.2 mm smooth jaw, 8-1/2" (21.5 cm)

BARRAQUER MICRO NEEDLE HOLDERS



KM44173

Without lock, round handle.

CATALOG #	DESCRIPTION
KM44175	Straight, smooth, 5-1/2" (14 cm)
KM44171	Curved, smooth, 5-1/2" (14 cm)
KM44177	Straight, smooth, 7" (18 cm)
KM44173	Curved, smooth, 7" (18 cm)
KM44176	Straight, smooth, 5-1/2" (14 cm), TC
KM44172	Curved, smooth, 5-1/2" (14 cm), TC
KM44161	Straight, serrated, 5-1/2" (14 cm), TC
KM44159	Curved, serrated, 5-1/2" (14 cm), TC
KM44178	Straight, smooth, 7" (18 cm), TC
KM44174	Curved, smooth, 7" (18 cm), TC
KM44162	Straight, serrated, 7" (18 cm), TC
KM44160	Curved, serrated, 7" (18 cm), TC

NEEDLE HOLDERS

Castro-Type Micro Needle Holders

BARRAQUER DELICATE NEEDLE HOLDERS



With lock, round handle.

CATALOG #	DESCRIPTION
KM44133	Straight, smooth, 5-1/2" (14 cm)
KM44129	Curved, smooth, 5-1/2" (14 cm)
KM44135	Straight, smooth, 7" (18 cm)
KM44131	Curved, smooth, 7" (18 cm)
KM44134	Straight, smooth, 5-1/2" (14 cm), TC
KM44130	Curved, smooth, 5-1/2" (14 cm), TC
KM44123	Straight, serrated, 5-1/2" (14 cm), TC
KM44121	Curved, serrated, 5-1/2" (14 cm), TC
KM44136	Straight, smooth, 7" (18 cm), TC
KM44132	Curved, smooth, 7" (18 cm), TC
KM44124	Straight, serrated, 7" (18 cm), TC
KM44122	Curved, serrated, 7" (18 cm), TC

BARRAQUER DELICATE NEEDLE HOLDERS



Without lock, round handle.

CATALOG #	DESCRIPTION
KM44151	Straight, smooth, 5-1/2" (14 cm)
KM44137	Curved, smooth, 5-1/2" (14 cm)
KM44153	Straight, smooth, 7" (18 cm)
KM44139	Curved, smooth, 7" (18 cm)
KM44152	Straight, smooth, 5-1/2" (14 cm), TC
KM44138	Curved, smooth, 5-1/2" (14 cm), TC
KM44127	Straight, serrated, 5-1/2" (14 cm), TC
KM44125	Curved, serrated, 5-1/2" (14 cm), TC
KM44154	Straight, smooth, 7" (18 cm), TC
KM44150	Curved, smooth, 7" (18 cm), TC
KM44128	Straight, serrated, 7" (18 cm), TC
KM44126	Curved, serrated, 7" (18 cm), TC

0 in

1

2

3

4

5

6

7

8

9



NEEDLE HOLDERS

Wire Twisters

BAUMGARTEN WIRE TWISTER



CATALOG #	DESCRIPTION
142521	Heavy square, 17.5 x 5 mm jaw, 8-1/8" (20.5 cm), TC

RUBIO TECHNIQUE® WIRE TWISTER



CATALOG #	DESCRIPTION
351349	12 x 4.5 mm jaw, 5" (12.5 cm), TC

NEEDLE HOLDERS

Wire Twisters

BERRY STERNAL TECHNIQUE® NEEDLE HOLDER



A large, heavy-duty needle holder with 6 mm wide jaws designed to securely hold the large needles used to close sternotomies. LIFE-LOK® Box-Lock.

CATALOG #	DESCRIPTION
343030	28 x 6 mm jaw, 7-3/4" (19.5 cm), TC

WIRE FORCEPS



CATALOG #	DESCRIPTION
351348	5-3/8" (13.5 cm)

0 in

1

2

3

4

5

6

7

8

9

NEEDLE HOLDERS

Suture Tags

GREGORY TECHNIQUE® SUTURE "STAY" CLAMPS



Smooth jaw hemostats for tagging sutures. May be used with or without rubber shodding.

CATALOG #	DESCRIPTION
351830	Straight, 3-7/8" (10 cm), TC
351831	Curved, 3-7/8" (10 cm), TC



RETRACTORS, HAND-HELD

Skin Hooks

CONVERSE SKIN HOOKS

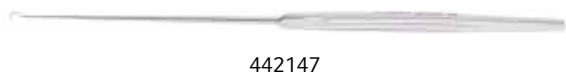

442147

CATALOG #	DESCRIPTION
442147	Small, 7-1/4" (18.5 cm)
442145	Large, 7" (18 cm)

COTTLE SKIN HOOKS



054135



054120

CATALOG #	DESCRIPTION
054120	Sharp, 2 prongs, 12 mm between prongs, 5-7/8" (15 cm)
054135	Sharp, 3.5 mm hook, 4-7/8" (12.5 cm)

FLEXIBLE RAKE RETRACTOR SKIN HOOKS



KM52182

CATALOG #	DESCRIPTION
KM52174	Sharp, 1 prong, 6-1/4" (16 cm)
KM52176	Sharp, 2 prongs, 6-1/4" (16 cm)
KM52182	Sharp, 3 prongs, 6-1/4" (16 cm)
KM52184	Blunt, 1 prong, 6-1/4" (16 cm)
KM52188	Blunt, 2 prongs, 6-1/4" (16 cm)
KM52192	Blunt, 3 prongs, 6-1/4" (16 cm)

FOMON RETRACTOR



054500

CATALOG #	DESCRIPTION
054500	Ball tip, 2 prongs, 10 mm between prongs, 6-3/8" (16 cm)

RETRACTORS, HAND-HELD

Skin Hooks

FREER RETRACTOR

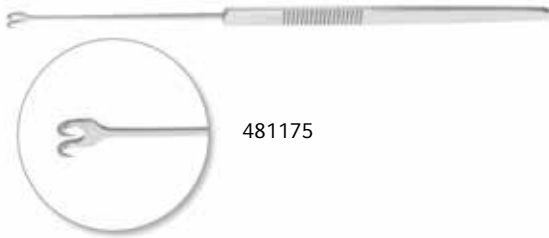

481175

CATALOG #	DESCRIPTION
481175	Sharp, 2 prongs, 5-7/8" (15 cm)

FREER SKIN HOOK



KM52040

CATALOG #	DESCRIPTION
KM52040	Sharp, 2 prongs, 2.5 mm wide, 6" (15 cm)

GILLIES CONVERSE SKIN HOOKS



054130

CATALOG #	DESCRIPTION
054128	Small, sharp, 3 mm hook, 7-3/8" (18.5 cm)
054130	Large, sharp, 4 mm hook, 7-1/8" (18 cm)

GUTHRIE SKIN HOOK



054126

CATALOG #	DESCRIPTION
054126	Sharp, 2 prongs, 2 mm between prongs, 5-1/8" (13 cm)



RETRACTORS, HAND-HELD

Skin Hooks

JOHNSON SKIN HOOK



054125

CATALOG #	DESCRIPTION
054125	Sharp, 5 mm hook, 6-1/2" (16.5 cm)

JOSEPH SKIN HOOKS



054105

Sharp, 4 mm hook. Weck® Pattern, bright finish.

CATALOG #	DESCRIPTION
054100	1 prong, 6-1/8" (15.5 cm)
054102	2 prongs, 2 mm between prongs, 6-1/4" (16 cm)
054105	2 prongs, 5 mm between prongs, 6-1/4" (16 cm)
054107	2 prongs, 6 mm between prongs, 6-1/4" (16 cm)
054110	2 prongs, 9 mm between prongs, 6-1/8" (15.5 cm)

JOSEPH SKIN HOOKS

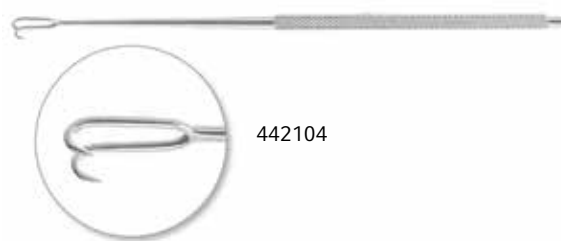

442104

Pilling® Pattern, bright finish. 6-1/4" (16 cm).

CATALOG #	DESCRIPTION
442100	1 prong
442102	2 prongs, 3 mm
442104	2 prongs, 5.5 mm
442106	2 prongs, 7 mm
442108	2 prongs, 10 mm

KLEINERT-KUTZ SKIN HOOKS



054142

Weck® Pattern, bright finish.

CATALOG #	DESCRIPTION
054140	Small, 3 mm hook, 6-1/4" (16 cm)
054142	Medium, 5 mm hook, 6-1/4" (16 cm)
054144	Large, 7 mm hook, 6-1/8" (15.5 cm)

RETRACTORS, HAND-HELD

Skin Hooks

KLEINERT-KUTZ HOOK



KM52060

KMedic® Pattern, satin finish.

CATALOG #	DESCRIPTION
KM52060	3 mm hook, 6-1/4" (16 cm)
KM52064	5 mm hook, 6-1/4" (16 cm)
KM52068	6 mm hook, 6-1/4" (16 cm)

KMEDIC® SKIN HOOK



KM52055

CATALOG #	DESCRIPTION
KM52055	1 sharp prong, 2 mm hook, 4-3/4" (12 cm)

O'CONNER SKIN HOOK



164786

CATALOG #	DESCRIPTION
164786	Sharp, 5-3/8" (13.5 cm)

PECK-JOSEPH SKIN HOOK



442110

CATALOG #	DESCRIPTION
442110	2 prongs, 10 mm between prongs, 5-5/8" (14.5 cm)

RIGID RAKE RETRACTOR SKIN HOOKS



KM52172

6-1/2" (16.5 cm).

CATALOG #	DESCRIPTION
KM52156	Sharp, 1 prong
KM52158	Sharp, 2 prongs, 6-1/2" (16.5 cm)
KM52162	Sharp, 3 prongs, 6-1/2" (16.5 cm)
KM52164	Blunt, 1 prong, 6-1/2" (16.5 cm)
KM52166	Blunt, 2 prongs, 6-1/2" (16.5 cm)
KM52172	Blunt, 3 prongs, 6-1/2" (16.5 cm)

RETRACTORS, HAND-HELD

Skin Hooks

ROLLET RETRACTOR

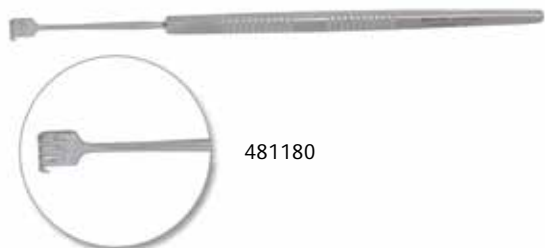

481180

CATALOG #	DESCRIPTION
481180	Sharp, 4 prongs, 2.8 x 5.5 mm, 5-1/4" (13.5 cm)

SCHNITMAN SHARP SKIN HOOK WITH EYE



524230

CATALOG #	DESCRIPTION
524230	6-1/2" (16.5 cm)

TYRELL HOOKS



KM54342

CATALOG #	DESCRIPTION
KM54338	1 sharp prong, 5" (12.5 cm)
KM54342	1 blunt prong, 5" (12.5 cm)

TYRELL HOOKS



054015

Delicate, 1.3 mm hook, 4-3/4" (12 cm).

CATALOG #	DESCRIPTION
054015	Sharp
054016	Blunt

WIENER SKIN HOOKS



KM54346

Single hook, 5" (12.5 cm).

CATALOG #	DESCRIPTION
KM54346	Sharp
KM54348	Blunt

RETRACTORS, HAND-HELD

Hook and Rake Retractors

DANDY NERVE HOOK



CATALOG #	DESCRIPTION
185714	Straight, 5.1 mm hook, 9" (23 cm)

SISSON NERVE HOOK

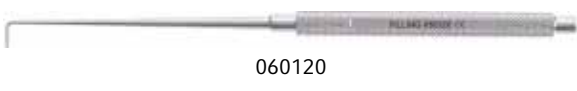

CATALOG #	DESCRIPTION
060120	Blunt, 90 degree angled, 7 mm hook, 6-1/8" (15.5 cm)

JACKSON TRACHEAL TENACULUM



CATALOG #	DESCRIPTION
514413	Hook depth 1/4" (0.5 cm), 5-1/4" (13.5 cm)

NEWS TRACHEA RETRACTOR



CATALOG #	DESCRIPTION
070114	Sharp, 10 mm hook, 5-7/8" (15 cm)

RETRACTORS, HAND-HELD

Hook and Rake Retractors

TRACHEA HOOK



054165

CATALOG #	DESCRIPTION
054165	Sharp, 8.7 x 1.4 mm hook, 7-1/2" (19 cm)
KM52098	Hupp Trachea Hook, sharp, 6-1/2" (16.5 cm)

SOLVAY SPAY HOOK



801886

CATALOG #	DESCRIPTION
801886	8" (20.5 cm)

JACKSON TRACHEAL RETRACTOR, DOUBLE-ENDED



514414

Pilling® Pattern, satin finish.

CATALOG #	DESCRIPTION
514414	Double-pronged, 1" wide x 1/4" deep (2.5 cm x 0.5 cm) blade, 6-7/8" (17.5 cm)

0 in

1

2

3

4

5

6

7

8

9

RETRACTORS, HAND-HELD

Hook and Rake Retractors

JACKSON TRACHEA RETRACTOR



Weck® Pattern, bright finish.

CATALOG #	DESCRIPTION
070116	2 prongs, 7" (18 cm)

DINGMAN ZYGOMA HOOK



CATALOG #	DESCRIPTION
026275	Sharp, 13 mm hook, 7" (18 cm)

BERNAY FINGER RAKE TRACHEAL RETRACTORS

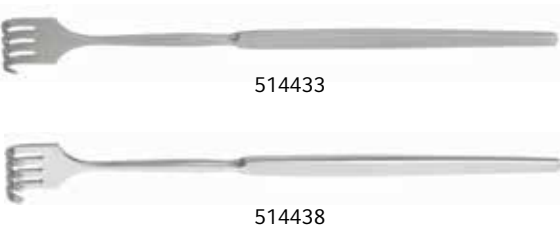

CATALOG #	DESCRIPTION
514430	1 prong, sharp, 6-5/8" (17 cm)
514431	2 prongs, sharp, 6-5/8" (17 cm)
514433	3 prongs, sharp, 6-5/8" (17 cm)
514435	1 prong, blunt, 6-5/8" (17 cm)
514436	2 prongs, blunt, 6-5/8" (17 cm)
514437	3 prongs, blunt, 6-5/8" (17 cm)
514438	4 prongs, blunt, 6-5/8" (17 cm)

LAHEY FINGER RETRACTORS



CATALOG #	DESCRIPTION
KM52082	1 prong, 4-3/4" (12 cm)
KM52086	2 sharp prongs, 5" (12.5 cm)
KM52087	3 sharp prongs, 5" (12.5 cm)

RETRACTORS, HAND-HELD

Hook and Rake Retractors

BLAIR (ROLLET) RETRACTOR



KM54368

CATALOG #	DESCRIPTION
KM54366	Rigid, 4 sharp prongs, 6 mm wide blade, 5" (12.5 cm)
KM54368	Rigid, 4 blunt prongs, 5 mm wide blade, 5" (12.5 cm)
KM54372	Flexible, 4 sharp prongs, 5-1/2" (14 cm)

MURPHY RAKE RETRACTORS



164444



164454

CATALOG #	DESCRIPTION
164443	Sharp, 3 prongs, 7-3/4" (19.5 cm)
164444	Sharp, 4 prongs, 8" (20.5 cm)
164446	Sharp, 6 prongs, 7-7/8" (20 cm)
164453	Blunt, 3 prongs, 8" (20.5 cm)
164454	Blunt, 4 prongs, 8" (20.5 cm)
164456	Blunt, 6 prongs, 7-3/4" (19.5 cm)

VOLKMANN POCKET RETRACTORS



164374

CATALOG #	DESCRIPTION
164374	Sharp, 4 prongs, 4-1/2" (11.5 cm)
164376	Sharp, 6 prongs, 4-1/2" (11.5 cm)
164384	Blunt, 4 prongs, 4-1/2" (11.5 cm)

0 in

1

2

3

4

5

6

7

8

9

RETRACTORS, HAND-HELD

Hook and Rake Retractors

VOLKMANN RAKE RETRACTORS



164403



164414

Pilling® Pattern, satin finish.

CATALOG #	DESCRIPTION
164402	Sharp, 2 prongs, 8-1/2" (21.5 cm)
164403	Sharp, 3 prongs, 8-1/2" (21.5 cm)
164404	Sharp, 4 prongs, 8-1/2" (21.5 cm)
164406	Sharp, 6 prongs, 8-1/2" (21.5 cm)
164412	Blunt, 2 prongs, 8-1/2" (21.5 cm)
164413	Blunt, 3 prongs, 8-1/2" (21.5 cm)
164414	Blunt, 4 prongs, 8-1/2" (21.5 cm)
164416	Blunt, 6 prongs, 8-1/2" (21.5 cm)

VOLKMANN RETRACTORS



KM52264

KMedic® Pattern, satin finish. Sharp.

CATALOG #	DESCRIPTION
KM52266	6 prongs, 1-1/8" wide x 1/2" deep blade (3 x 1.5 cm), 8-1/2" (21.5 cm)
KM52254	1 prong, 1/2" deep blade (15 mm), 8-1/2" (21.5 cm)
KM52264	4 prongs, 3/4" wide x 1/2" deep blade (18 x 13 mm), 8-1/2" (21.5 cm)

MUELLER RAKE RETRACTOR



KM52338

CATALOG #	DESCRIPTION
KM52338	8 prongs, 1-1/2" (38 mm) wide

DEEP RAKE RETRACTORS



KM52294

CATALOG #	DESCRIPTION
KM52292	4 blunt prongs, 2-1/4" wide x 1-1/2" deep (5.5 x 4 cm)
KM52294	4 blunt prongs, 2-1/4" wide x 2" deep (5.5 x 5 cm)
KM52296	4 blunt prongs, 2-1/4" wide x 2-1/2" deep (5.5 x 6.5 cm)
KM52298	4 blunt prongs, 2-1/4" wide x 3" deep (5.5 x 7.5 cm)

RETRACTORS, HAND-HELD

Hook and Rake Retractors

ISRAEL RETRACTOR



CATALOG #	DESCRIPTION
481390	Blunt, 4 prongs, 41 x 43 mm, 7-3/8" (18.5 cm)

OLLIER RAKE RETRACTOR



CATALOG #	DESCRIPTION
KM52282	4 blunt prongs, 5.5 cm wide x 4 cm deep blade, 9" (23 cm)

FREEMAN FACE LIFT RETRACTOR



CATALOG #	DESCRIPTION
442295	1-5/8" (4 cm) wide blade, 7-1/8" (18 cm)

0 in

1

2

3

4

5

6

7

8

9

RETRACTORS, HAND-HELD

Single-Ended Retractors

BREWSTER RETRACTORS



Curved, convex blades.

CATALOG #	DESCRIPTION
164650	3/4" x 1-3/4" (2 x 4.5 cm) blade, 8-1/2" (21.5 cm)
164652	1" x 2" (2.5 x 5 cm) blade, 9" (23 cm)
164656	1-3/4" x 2-1/2" (4.5 x 6.5 cm) blade, 9-1/4" (23.5 cm)
164658	1-7/8" x 2-7/8" (5 x 7.5 cm) blade, 9-1/2" (24 cm)

COTTLE ALAR RETRACTOR



CATALOG #	DESCRIPTION
442210	1/2" (1.5 cm) wide blade, 5-1/2" (14 cm)

CUSHING DECOMPRESSION RETRACTOR



CATALOG #	DESCRIPTION
481220	21 x 10 mm blade, 8-1/8" (20.5 cm)

RETRACTORS, HAND-HELD

Single-Ended Retractors

CUSHING NERVE AND VEIN RETRACTOR

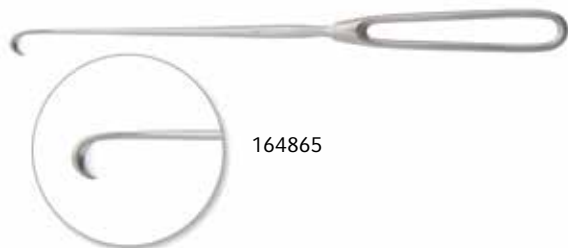

164865

Pilling® Pattern, satin finish.

CATALOG #	DESCRIPTION
164865	12 mm wide blade, 8-1/2" (21.5 cm)

CUSHING NERVE AND VEIN RETRACTORS



481230

Weck® Pattern, bright finish.

CATALOG #	DESCRIPTION
481230	16 x 15 mm blade, 8-5/8" (22 cm)
481231	14.5 x 15 mm blade, 12-3/4" (32.5 cm)

DESMARRES LID RETRACTORS



421630

CATALOG #	DESCRIPTION
421610	Size 1, 12 mm wide blade, 5-3/8" (13.5 cm)
421620	Size 2, 13 mm wide blade, 5-3/8" (13.5 cm)
421630	Size 3, 15 mm wide blade, 5-3/8" (13.5 cm)
421640	Size 4, 17 mm wide blade, 5-3/8" (13.5 cm)

GREEN RETRACTOR



481520

CATALOG #	DESCRIPTION
481520	Fenestrated, 21 x 24 mm blade, 8-7/8" (22.5 cm)

RETRACTORS, HAND-HELD

Single-Ended Retractors

LAHEY RETRACTOR



CATALOG #	DESCRIPTION
481610	30 x 5 mm blade, 7-3/4" (19.5 cm)

LANGENBECK RETRACTORS



Distal blade tip, slightly curved. Flat handle.
Length 8-1/2" (21.5 cm).

CATALOG #	DESCRIPTION
164630	3/8" x 1-5/8" (1 x 4 cm) blade
164631	1/2" x 1-5/8" (1.3 x 4 cm) blade
164632	5/8" x 1-5/8" (1.5 x 4 cm) blade

LITTLER RETRACTOR



CATALOG #	DESCRIPTION
481500	Curved, 20 x 12 mm blade, 7-1/2" (19 cm)

RETRACTORS, HAND-HELD

Single-Ended Retractors

LOVE NERVE RETRACTORS



KM51532

CATALOG #	DESCRIPTION
KM51530	Straight, 7 mm wide blade, 8-1/2" (21.5 cm)
KM51532	Angled 45 degrees, 7 mm wide blade, 7" (18 cm)
KM51534	Angled 90 degrees

LOVE NERVE RETRACTORS

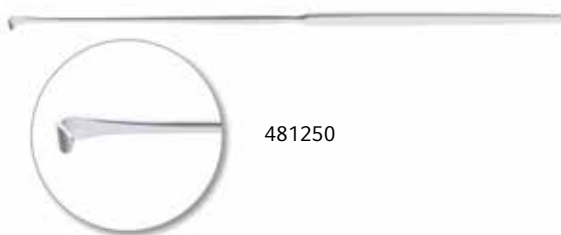

481250

CATALOG #	DESCRIPTION
481250	4 x 6 mm blade, straight, 8" (20.5 cm)

MCBURNEY RETRACTOR



481530

CATALOG #	DESCRIPTION
481530	Fenestrated, 20 x 16 mm blade, 7-5/8" (19.5 cm)

0 in

1

2

3

4

5

6

7

8

9

RETRACTORS, HAND-HELD

Single-Ended Retractors

MEYERDING FINGER RETRACTORS



Pilling® Pattern, satin finish.

CATALOG #	DESCRIPTION
164790	7.5 x 17 mm blade, 6-7/8" (17.5 cm)

MEYERDING FINGER RETRACTORS



KMedic® Pattern, satin finish, 7" (18 cm).

CATALOG #	DESCRIPTION
KM52116	#1, 7 mm wide x 18 mm deep blade
KM52118	#2, 6 mm wide x 17 mm deep blade, with teeth
KM52122	#3, 4 mm wide x 8 mm deep blade, with teeth
KM52124	#4, 4 mm wide x 10 mm deep blade
KM52128	#5, 4 mm wide x 7 mm deep blade
KM52130	#6, 8 mm wide x 7 mm deep blade, 3 sharp prongs



RETRACTORS, HAND-HELD

Single-Ended Retractors

SAUERBRUCH RETRACTORS



Long, slender blades with slightly curved tips. Hollow handle.

CATALOG #	DESCRIPTION
164635	5/8" x 1-3/4" (1.5 x 4.5 cm) blade, 9" (23 cm)
164636	7/8" x 2-1/2" (2 x 6.5 cm) blade, 9" (23 cm)
164637	3/4" x 2-7/8" (2 x 7.5 cm) blade, 8-7/8" (22.5 cm)

SEMB RETRACTOR



For retracting the muscles during resection of the posterior medial ends of the ribs and during freeing of the transverse processes and separation of the vertebrocostal joints. Stainless steel blade.

CATALOG #	DESCRIPTION
341640	Small, blade 3/4" wide x 1-3/4" deep (2 x 4.5 cm)

Double-Ended Retractors

"S" RETRACTOR



CATALOG #	DESCRIPTION
054620	Blade A 1/4" wide x 3/8" deep (6 x 10 mm), Blade B 1/2" wide x 5/8" deep (13.5 x 15 mm) Overall length 5-1/4" (13.5 cm)

RETRACTORS, HAND-HELD

Double-Ended Retractors

KLEINERT-RAGNELL RETRACTOR



442260

CATALOG #	DESCRIPTION
442260	Blade A 1/4" wide x 3/4" deep (5.6 x 20 mm), Blade B 1/8" wide x 3/8" deep (3.7 x 10 mm), Overall length 6-1/8" (15.5 cm)

BREWSTER PHRENIC RETRACTORS

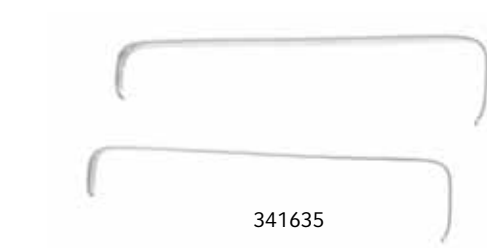

341635

Nested set of 2.

CATALOG #	DESCRIPTION
341635	Large blade 1-3/8" x 1-1/2" wide (20 x 40 mm) x 1-3/8" deep (35 mm), Small blade 1" wide x 3/8" deep (25 x 10 mm), Overall length 5-7/8" (15 cm)

CHILDREN'S HOSPITAL RETRACTOR



164754

CATALOG #	DESCRIPTION
164754	Blade A 3/8" wide x 3/4" deep (10 x 19 mm), Blade B 1/4" wide x 3/4" deep (6 x 19 mm), Overall length 6-1/8" (15.5 cm)

RETRACTORS, HAND-HELD

Double-Ended Retractors

CRILE RETRACTOR

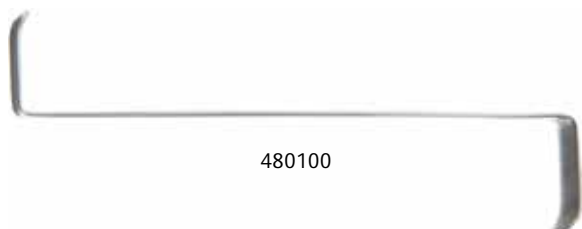

480100

CATALOG #	DESCRIPTION
480100	Large blade 1/4" wide x 3/4" deep (7.5 x 20 mm), Small blade 1/4" wide x 5/8" deep (5 x 17 mm), Overall length 4-1/8" (10.5 cm)

DAVIS RETRACTORS



442245

CATALOG #	DESCRIPTION
442245	Blade A 3/8" wide (10 mm), Blade B 1/4" wide (6 mm), Overall length 6-1/8" (15.5 cm)

DAVIS RETRACTORS



KM52076

CATALOG #	DESCRIPTION
KM52076	Blade A 1/4" wide x 5/8" deep blade (6 x 17 mm), Blade B 3/8" wide x 3/4" deep blade (9 x 20 mm), Overall length 6" (15 cm)

FARABEUF RETRACTORS



164702

Nested set of 2.

CATALOG #	DESCRIPTION
164700	Blade A 5/8" wide x 1-1/8" deep (15 x 28 mm), Blade B 5/8" wide x 1-1/4" deep (15 x 30 mm), Overall length 6" (15 cm)
164702	Blade A 3/8" wide x 1" deep (10 x 25 mm), Blade B 1/2" wide x 1-1/4" deep (12 x 30 mm), Overall length 4-1/2" (11.5 cm)

0 in

1

2

3

4

5

6

7

8

9

RETRACTORS, HAND-HELD

Double-Ended Retractors

GOELET RETRACTOR



480150

CATALOG #	DESCRIPTION
480150	Blade A 1" wide x 1-1/8" deep (26 x 30 mm), Blade B 1-1/4" wide x 1-7/8" deep (31 x 47 mm), Overall length 7-1/2" (19 cm)

INFANT RETRACTOR



480105

CATALOG #	DESCRIPTION
480105	Blades 3/8" x 1/2" (10 x 13 mm), 5-5/8" (14.5 cm)

LUKENS THYMUS RETRACTOR



514412

CATALOG #	DESCRIPTION
514412	Blade 3/8" wide x 1/4" deep (9 x 6 mm), Overall length 6-7/8" (17.5 cm)

MAYO-COLLINS RETRACTORS



164710

Nested set of 2.

CATALOG #	DESCRIPTION
164710	Blade A 3/4" wide x 1-1/8" deep (20 x 30 mm), Blade B 3/4" wide x 1-1/4" deep (20 x 35 mm), Overall length 6" (15 cm)



RETRACTORS, HAND-HELD

Double-Ended Retractors

PARKER RETRACTORS



480170

CATALOG #	DESCRIPTION
480170	Small set of 2 retractors. Short retractor: Blade A 7/8" wide x 5/8" deep (21 x 16 mm), Blade B 1" wide x 5/8" deep (25 x 16 mm), Overall length 5-1/2" (14 cm)
480172	Large set of 2 retractors. Short retractor: Blade A 1" wide x 1" deep (25 x 24 mm), Blade B 1" wide x 1" deep (26 x 24 mm), Overall length 6-3/4" (17 cm)

PARKER-MOTT RETRACTORS



164698

Set of 2.

CATALOG #	DESCRIPTION
164698	1" x 2-1/2" (25 x 65 mm) blades, Overall length 5-3/4" (14.5 cm)

RAGNELL RETRACTOR



054600

CATALOG #	DESCRIPTION
054600	Blade A 3 mm wide x 8 mm deep, Blade B 5 mm wide x 17 mm deep, Overall length 5-3/4" (14.5 cm)

RETRACTORS, HAND-HELD

Double-Ended Retractors

RAGNELL RETRACTOR



KM52094

KMedic® Pattern, satin finish.

CATALOG #	DESCRIPTION
KM52094	Blade A 4 wide x 8 mm deep, Blade B 6 wide x 15 mm deep, Overall length 5-3/4" (14.5 cm)

ROUX RETRACTORS



480140

7-1/4" (18.5 cm).

CATALOG #	DESCRIPTION
480140	Small: Blade A 1-1/8" wide x 1" deep (27 x 25 mm), Blade B 1-3/8" wide x 1-1/2" deep (34 x 38 mm)
480145	Large: Blade A 1-1/4" wide x 1-3/8" deep (31 x 36 mm), Blade B 1-1/4" wide x 1-7/8" deep (31 x 47 mm)

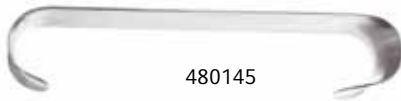

480145

SENN RETRACTORS



164750

Pilling® Pattern, satin finish. 1/4" x 3/4" (6 x 19 mm) flat blade, 6-1/4" (16 cm).

CATALOG #	DESCRIPTION
164750	3 sharp prongs
164752	3 blunt prongs

SENN-KANAHEL DELICATE RETRACTOR



054590

CATALOG #	DESCRIPTION
054590	3 sharp 7 x 7 mm prongs, 21 x 6 mm blade, 6-1/2" (16.5 cm)

RETRACTORS, HAND-HELD

Double-Ended Retractors

MILLER-SENN RETRACTORS



9.8 mm prongs, 21 x 6.5 mm blade, 6-1/2" (16.5 cm).

CATALOG #	DESCRIPTION
480125	3 sharp prongs
480126	3 blunt prongs

U.S. ARMY (ARMY-NAVY) RETRACTORS



Nested set of 2.

CATALOG #	DESCRIPTION
164715	5/8" (1.5 cm) wide blade, 8-1/2" (21.5 cm)

Abdominal-Type Retractors

DEAVER RETRACTORS



Hollow grip handle.

CATALOG #	DESCRIPTION
KM51230	1" wide x 10" long blade (2.5 x 25.5 cm)
KM51232	1" wide x 12" long blade (2.5 x 30.5 cm)
KM51234	1" wide x 13" long blade (2.5 x 33 cm)
KM51240	2" wide x 12" long blade (5 x 30.5 mm)
KM51236	2-1/2" wide x 14-1/2" long blade (6.5 x 37 cm)
KM51242	3" wide x 12" long blade (7.5 x 30.5 cm)
KM51238	3-1/2" wide x 12" long blade (9 x 30.5 cm)

RETRACTORS, HAND-HELD

Abdominal-Type Retractors

DEAVER RETRACTORS

Standard design. Rigid stainless steel.

CATALOG #	DESCRIPTION
164110	3/4" (2 cm) wide, 6-7/8" (17.5 cm)
164112	7/8" (2 cm) wide, 7-7/8" (20 cm)
164115	1" (2.5 cm) wide, 8-7/8" (22.5 cm)
164118	#1, 1" (2.5 cm) wide, 8-1/8" (20.5 cm)
164120	#2, 1" (2.5 cm) wide, 9-7/8" (25 cm)
164122	#3, 1" (2.5 cm) wide, 12" (30.5 cm)
164125	#4, 1" (2.5 cm) wide, 14-3/8" (36.5 cm)
164130	#5, 1-1/2" (4 cm) wide, 11-7/8" (30 cm)
164132	#6, 2" (5 cm) wide, 12" (30.5 cm)
164134	#7, 3" (7.5 cm) wide, 12" (30.5 cm)



164110



164112



164115



164118



164120



164122



164125



164130



164134

RETRACTORS, HAND-HELD

Abdominal-Type Retractors

W.M. LEMMON EXTRA-DEEP DEAVER RETRACTORS



341732

Distal blade section extended to provide working depth of 9-1/2" (24 cm). Blade length 15" (38 cm). Large fluted handles.

CATALOG #	DESCRIPTION
341730	1" (2.5 cm) wide blade
341732	2" (5 cm) wide blade

WILLAUER-DEAVER RETRACTORS



341722

Deaver blades mounted on comfortable handle.

CATALOG #	DESCRIPTION
341720	Narrow, 1" wide x 6-1/4" deep (2.5 x 16 cm) blade, 14-1/2" (37 cm)
341722	Wide, 2" wide x 6-1/4" deep (5 x 16 cm) blade, 14-1/2" (37 cm)

DEEP DEAVER RETRACTORS



481826

Stainless steel, hollow handle.

CATALOG #	DESCRIPTION
481825	6" deep x 1-1/2" (15 x 4 cm) blade, 13-3/4" (35 cm)
481826	6" deep x 2" (15 x 5 cm) blade, 13-3/4" (35 cm)
481827	6" deep x 2-1/2" (15 x 6.5 cm) blade, 13-3/4" (35 cm)

0 in

1

2

3

4

5

6

7

8

9

RETRACTORS, HAND-HELD

Abdominal-Type Retractors

DOYEN RETRACTORS



Concave blade.

CATALOG #	DESCRIPTION
164520	1-3/4" x 2-3/4" blade (4.5 x 7 cm), 8-3/4" (22 cm)
164521	2-3/8" x 3-3/8" blade (6 x 8.5 cm), 9" (23 cm)
164522	2-1/4" x 3-7/8" blade (5.5 x 10 cm), 9" (23 cm)

DEBAKEY®-COOLEY RETRACTOR



Extra-deep retractor of greater than usual width. Blade is carefully proportioned to provide maximum working depth and to prevent tendency toward slipping upward and out. Satin finish to prevent glare from overhead lights.

CATALOG #	DESCRIPTION
341740	7-1/4" (18.5 cm) deep blade with 2-1/4" (5.5 cm) Harrington end, 12-1/4" (31 cm)

HARRINGTON EXTRA DEEP RETRACTORS



Extra-deep with fluted handle, satin finish.

CATALOG #	DESCRIPTION
341790	2-1/4" wide x 8" deep blade (5.5 x 20.5 cm), 11-3/4" (30 cm)
341791	4-1/2" wide x 7" deep blade (11.5 x 18 cm), 13-1/8" (33.5 cm)

HARRINGTON RETRACTORS



Stainless steel, hollow handle.

CATALOG #	DESCRIPTION
482370	135 x 44 mm blade, 12-3/4" (32.5 cm)
482371	135 x 65 mm blade, 13" (33 cm)

RETRACTORS, HAND-HELD

Abdominal-Type Retractors

HARRINGTON SPLANCHNIC RETRACTORS



341773

Cross serrated retracting surface.

CATALOG #	DESCRIPTION
341770	1-1/2" wide x 4-3/4" deep blade (4 x 12 cm), 12-1/2" (32 cm)
341773	2-1/2" wide x 5" deep blade (6.5 x 12.5 cm), 12" (30.5 cm)

KELLY RETRACTORS



164526

Flat blade with slight upward turn on sides and downward turn on slightly reduced width distal edge.

CATALOG #	DESCRIPTION
KM51222	3" x 2-1/2" blade (76 x 64 mm), 9-3/4" (25 cm)
164525	1-1/2" x 2" blade (38 x 50 mm), 9" (23 cm)
164526	2" x 2-3/8" blade (50 x 61 mm), 9-1/2" (24 cm)
164527	2-1/2" x 3" blade (64 x 76 mm), 10" (25.5 cm)
164528	3" x 3-1/2" blade (76 x 90 mm), 10-1/2" (26.5 cm)

MAYO ABDOMINAL RETRACTOR



482350

CATALOG #	DESCRIPTION
482350	40 x 70 mm blade, 11" (28 cm)

RICHARDSON APPENDECTOMY RETRACTOR



164540

CATALOG #	DESCRIPTION
164540	3/4" wide x 2" deep blade (2 x 5 cm), 9-1/2" (24 cm)

RETRACTORS, HAND-HELD

Abdominal-Type Retractors

RICHARDSON RETRACTORS



Blade face is relatively flat with lateral edges curved upwards. Distal edge is straight across and turned downward.

CATALOG #	DESCRIPTION
164542	3/4" x 1-1/4" blade (20 x 32 mm), length 9-3/4" (25 cm)
164543	1" x 1-1/4" blade (25 x 32 mm), length 9-3/4" (25 cm)
164544	1-1/2" x 1-1/2" blade (38 x 38 mm), length 9-3/4" (25 cm)

RICHARDSON RETRACTORS



Stainless steel, hollow handle.

CATALOG #	DESCRIPTION
481616	1" x 3/4" blade (25 x 20 mm), 9-1/2" (24 .5 cm)
481617	1-1/4" x 1-1/4" blade (32 x 32 mm), 9-1/2" (24 .5 cm)
481618	1-1/2" x 1-1/2" blade (38 x 38 mm), 9-1/2" (24 .5 cm)
481629	2" x 3/4" blade (48 x 20 mm), 9-1/2" (24 .5 cm)

RICHARDSON-EASTMAN RETRACTORS



Pilling® Pattern, satin finish.

CATALOG #	DESCRIPTION
164550	Set of 2: Small 10" (25.5 cm), blade A 33 x 30 mm, blade B 26 x 23 mm Large 10-3/4" (27.5 cm), blade A 65 x 43 mm, blade B 42 x 38 mm

RETRACTORS, HAND-HELD

Abdominal-Type Retractors

RICHARDSON-EASTMAN RETRACTORS



480195

CATALOG #	DESCRIPTION
480195	Set of 2: Small 9-7/8" (25 cm) blade A 30 x 29 mm, blade B 24 x 22 mm Large 10-5/8" (27 cm) blade A 63 x 42 mm, blade B 39 x 37 mm, Weck® Pattern, bright finish
480196	Small only: 9-7/8" (25 cm) blade A 30 x 29 mm, blade B 24 x 22 mm, Weck® Pattern, bright finish
KM51214	Large only: 10-5/8" (27 cm) blade A 65 x 43 mm, blade B 39 x 38 mm, Satin finish

WYLIE RENAL VEIN RETRACTORS



341797

Designed for the retraction of the left renal vein during procedures on the abdominal aorta or renal arteries. Gently curved distal tip for atraumatic control. Stainless Steel.

CATALOG #	DESCRIPTION
341795	Short, 1" wide x 3-3/4" deep (2.5 x 9.5 cm) blade, 11-3/4" (30 cm)
341797	Long, 1" wide x 6-7/8" deep (2.5 x 17.5 cm) blade, 12-3/4" (32.5 cm)

WYLIE SPLANCHNIC RETRACTOR



341780

CATALOG #	DESCRIPTION
341780	Rigid, acutely curved blade is 6-3/4" deep (17 cm) Distal 1/2" is angled inward and deeply cross serrated, which provides positive, non-slip traction Blade is 2-1/2" wide (6.3 cm) Large, fluted handle, overall length 13"

RETRACTORS, HAND-HELD

Ribbon-Type Malleable Retractors

DAVIS BRAIN SPATULAS



380206

CATALOG #	DESCRIPTION
380200	1/4" (6.5 mm) wide blade
380202	3/8" (9.5 mm) wide blade
380204	1/2" (12.5 mm) wide blade
380206	5/8" (16 mm) wide blade
380208	3/4" (19 mm) wide blade
380210	1" (25.5 mm) wide blade

HAIGHT RETRACTORS



341694

Malleable "T"-shaped blades. For abdominal and intra-thoracic surgery.

CATALOG #	DESCRIPTION
341690	3" wide x 11-1/2" long (7.5 x 29 cm)
341692	3-1/2" wide x 11-3/4" long (9 x 30 cm)
341694	4" wide x 12" long (10 x 30.5 cm)
341696	4-3/4" wide x 12-3/4" long (12 x 32.5 cm)
341698	5-1/2" wide x 13-1/2" long (14 x 34.5 cm)

OCHSNER RIBBON RETRACTORS



164170

Malleable.

CATALOG #	DESCRIPTION
164164	1" x 13" (2.5 x 33 cm)
164166	1-1/4" x 13" (3 x 33 cm)
164168	1-1/2" x 13" (4 x 33 cm)
164170	2" x 13" (5 x 33 cm)
164172	2-1/2" x 13" (6.5 x 33 cm)
164174	3" x 13" (7.5 x 33 cm)
442288	7/8" x 7" (2 x 18 cm)

RIBBON RETRACTORS



KM51766

Malleable.

CATALOG #	DESCRIPTION
KM51752	1/2" (12.5 mm) wide blade, 6" (15 cm)
KM51755	1" (25.5 mm) wide blade, 7-1/2" (19 cm)
KM51766	3/4" (19 mm) wide blade, 13" (33 cm)

RETRACTORS, HAND-HELD

Specialty Retractors

ALLISON LUNG RETRACTORS



341679

Wire, spatula-shaped blade.

CATALOG #	DESCRIPTION
341678	Child size, 10-1/4" (26 cm)
341679	Adult Size, 12-3/8" (31.5 cm)

DAVIDSON SCAPULA RETRACTORS



341650

CATALOG #	DESCRIPTION
341650	Small size, blade 2" (5 cm) wide, 7-3/4" (19.5 cm)
341651	Large size, blade 3-1/2" (9 cm) wide, 7-3/4" (19.5 cm)

DEVINE-MILLARD-AUFRECHT NASAL RETRACTOR FIBEROPTIC LIGHTING



525150

CATALOG #	DESCRIPTION
525150	7-3/4" (19.5 cm)

FACE LIFT RETRACTOR FIBEROPTIC LIGHTING ON #2 DEEVER RETRACTOR



525215

CATALOG #	DESCRIPTION
525215	10-5/8" (27 cm)

RETRACTORS, SELF-RETAINING

Wire and Alm-Type Retractors

BARRAQUER WIRE SPECULUMS

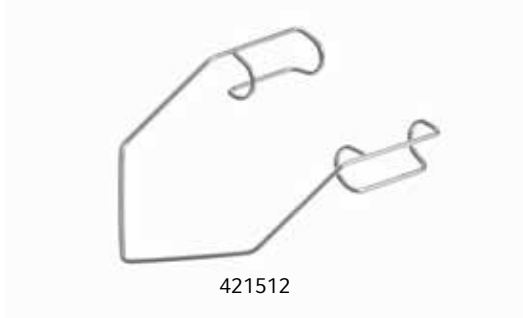

All blades 3/16" (5 mm) deep.

CATALOG #	DESCRIPTION
421510	Small fenestrated blade, 3/8" wide (4 mm), overall length 1-1/8" (3 cm)
421512	Large fenestrated blade, 5/8" wide (16 mm), overall length 1-5/8" (4 cm)

FARR RETRACTORS

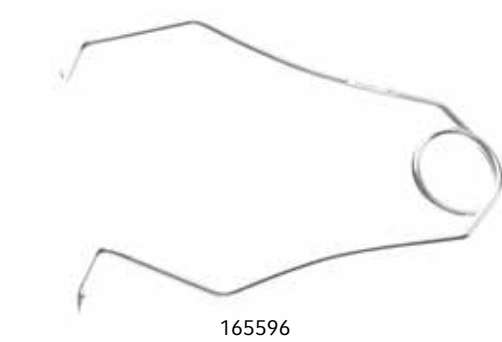

CATALOG #	DESCRIPTION
165595	No. 1, blade 3/4" (2 cm), 5-1/2" (14 cm)
165596	No. 2, blade 1-1/8" (3 cm), 5-1/2" (14 cm)
165597	No. 3, blade 1-1/8" (3 cm), 9" (23 cm)

GRIESHABER WIRE RETRACTORS



Useful for very small incisions in minor surgery and in laboratory uses.

CATALOG #	DESCRIPTION
165590	#1, delicate, thin wire, 1 prong, 3-1/4" (8.5 cm)
165591	#2, delicate, thin wire, 3-tooth blade, 3-1/4" (8.5 cm)
165592	#3, medium weight wire, single short prong, 4-3/4" (12 cm)
351685	Deep arteriotomy spring retractor, 3-1/4" (8.5 cm)

RETRACTORS, SELF-RETAINING

Wire and Alm-Type Retractors

HEISS RETRACTORS



CATALOG #	DESCRIPTION
165085	4 x 4 sharp prongs, 1/8" (3 mm) deep, 4-1/8" (10.5 cm)
165086	4 x 4 blunt prongs, 1/8" (3 mm) deep, 4-1/8" (10.5 cm)

SKIN SELF-RETAINING RETRACTORS

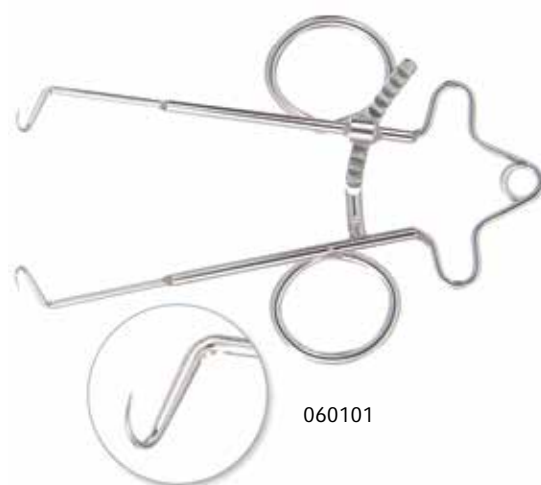

CATALOG #	DESCRIPTION
060100	Sharp prongs, lightly angled 55 degrees, 2-1/2" (6.5 cm) spread, 3-3/4" (9.5 cm)
060101	Sharp prongs, strongly angled 80 degrees, 2-1/2" (6.5 cm) spread, 3-1/2" (9 cm)
060105	Sharp prongs, strongly angled 80 degrees, 3-1/2" (9 cm) spread, 4-3/4" (12 cm)

ALM RETRACTORS



For delicate minor surgery.

CATALOG #	DESCRIPTION
165510	Small, 4 mm, semi-sharp teeth, 2-3/4" (7 cm)
488210	4 x 4 blunt prongs, 3" (7.5 cm)

RETRACTORS, SELF-RETAINING

Wire and Alm-Type Retractors

JANSEN RETRACTORS



165550

CATALOG #	DESCRIPTION
165550	3 x 3 blunt prongs, 5/16" (8 mm) deep, 3" (7.5 cm) spread, 4-3/8" (11 cm)
165552	3 x 3 sharp prongs, 5/16" (8 mm) deep, 2" (5 cm) spread, 4-3/8" (11 cm)

Weitlaner, Gelpi and Henly-Type Retractors

WEITLANER RETRACTORS



165352



165362

Pilling® Pattern, satin finish.

CATALOG #	DESCRIPTION
165348	2 x 3 sharp prongs, 4-1/2" (11.5 cm)
165350	3 x 4 sharp prongs, 5-1/2" (14 cm)
165352	3 x 4 sharp prongs, 6-1/2" (16.5 cm)
165354	3 x 4 sharp prongs, 7-5/8" (19.5 cm)
165356	3 x 4 sharp prongs, 9-1/2" (24 cm)
165358	2 x 3 blunt prongs, 4-1/2" (11.5 cm)
165360	3 x 4 blunt prongs, 5-1/2" (14 cm)
165362	3 x 4 blunt prongs, 6-1/2" (16.5 cm)
165364	3 x 4 blunt prongs, 7-5/8" (19.5 cm)
165366	3 x 4 blunt prongs, 9-1/2" (24 cm)

RETRACTORS, SELF-RETAINING

Weitlaner, Gelpi and Henly-Type Retractors

WEITLANER RETRACTORS



Weck® Pattern, bright finish.

CATALOG #	DESCRIPTION
488305	2 x 3 sharp prongs, 4-1/2" (11.5 cm)
488306	2 x 3 blunt prongs, 4-1/2" (11.5 cm)

WEITLANER RETRACTORS



KMedic® Pattern, satin finish.

CATALOG #	DESCRIPTION
KM52492	2 x 3 sharp prongs 12 x 16 mm, 4" (10 cm)
KM52494	2 x 3 blunt prongs 13 mm, 4" (10 cm)
KM52498	3 x 4 sharp prongs, 5-1/4" (13.5 cm)

WULLSTEIN-WEITLANER RETRACTORS



CATALOG #	DESCRIPTION
029550	Small, 3 x 3 sharp prongs, 11 mm deep x 12 mm wide, 4-3/8" (11 cm)
029555	Large, 3 x 3 sharp prongs, 11 mm deep x 12 mm wide, 5" (12.5 cm)

RETRACTORS, SELF-RETAINING

Weitlaner, Gelpi and Henly-Type Retractors

SCALP CONTOUR RETRACTORS



KM52546

Useful in hand procedures because handle is not obstructive.

CATALOG #	DESCRIPTION
KM52546	3 x 4 blunt prongs, 5-1/2" (14 cm)
KM52548	3 x 4 sharp prongs, 5-1/2" (14 cm)

ADSON RETRACTORS



488361

Straight shanks.

CATALOG #	DESCRIPTION
488360	4 x 4 sharp prongs, 7-1/2" (19 cm)
488361	4 x 4 blunt prongs, 7-1/2" (19 cm)

ADSON RETRACTORS



382722

Contoured shanks.

CATALOG #	DESCRIPTION
382722	4 x 4, sharp, 17 x 7 mm prongs, 7-1/4" (18.5 cm)

RETRACTORS, SELF-RETAINING

Weitlaner, Gelpi and Henly-Type Retractors

ANDERSON ADSON RETRACTOR

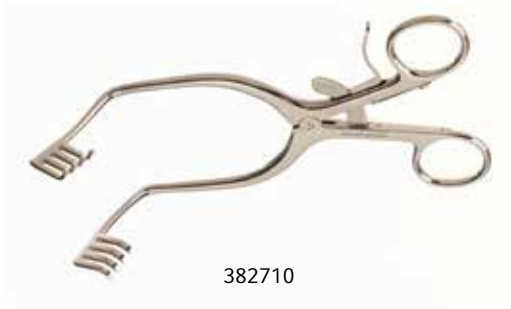

Angled shanks.

CATALOG #	DESCRIPTION
382710	4 x 4 blunt, 6-3/4" (17 cm)

ADSON RETRACTOR



Hinged arm design.

CATALOG #	DESCRIPTION
KM52474	4 x 5 blunt prongs, 13" (33 cm)

BECKMAN-WEITLANER RETRACTORS



This modification involves the addition of the Beckman Hinge to Weitlaner Retractors. Pilling® Pattern, satin finish.

CATALOG #	DESCRIPTION
165370	3 x 4 sharp prongs, 5-1/2" (14 cm)
165372	3 x 4 sharp prongs, 6-1/2" (16.5 cm)
165374	3 x 4 sharp prongs, 8-1/4" (21 cm)
165380	3 x 4 blunt prongs, 5-1/2" (14 cm)
165382	3 x 4 blunt prongs, 6-1/2" (16.5 cm)
165384	3 x 4 blunt prongs, 8-1/4" (21 cm)

RETRACTORS, SELF-RETAINING

Weitlaner, Gelpi and Henly-Type Retractors

BECKMAN RETRACTOR



488370

Weck® Pattern, bright finish.

CATALOG #	DESCRIPTION
488370	4 x 4 sharp prongs, 12-1/2" (32 cm)

BECKMAN RETRACTORS



KM52470

CATALOG #	DESCRIPTION
KM52470	4 x 4 sharp prongs, 27 mm, side blade 5/8" (1.5 cm) deep, 12-1/4" (31 cm)
KM52472	4 x 4 blunt prongs, 27 mm, side blade 5/8" (1.5 cm) deep, 12-1/4" (31 cm)

BECKMAN-ADSON LAMINECTOMY RETRACTORS



KM52484

With hinged blades.

CATALOG #	DESCRIPTION
KM52484	4 x 4 blunt prongs, 28 x 29 mm, 12-1/4" (31 cm)
KM52486	4 x 4 sharp prongs, 28 x 47 mm, 12-1/4" (31 cm)
KM52488	4 x 4 blunt prongs, 25 x 44 mm, 12-1/4" (31 cm)
KM52490	4 x 4 sharp prongs, 28 x 29 mm, 12-1/4" (31 cm)

RETRACTORS, SELF-RETAINING

Weitlaner, Gelpi and Henly-Type Retractors

BECKMAN-ADSON RETRACTORS



Modification of Beckman having Adson blades.
4 x 4 blunt prongs. Pilling® Pattern, satin finish.

CATALOG #	DESCRIPTION
165400	4 x 4 blunt prongs, 1" (2.5 cm) deep blades, 12-1/4" (31 cm)
165402	4 x 4 blunt prongs, 1-1/4" (3 cm) deep blades, 13" (33 cm)

BECKMAN-EATON RETRACTOR



CATALOG #	DESCRIPTION
KM52476	7 x 7 sharp prongs, 40 x 48 mm, 12-1/4" (31 cm)

BECKMAN-WEITLANER RETRACTORS



With hinged blades. KMedic® Pattern, satin finish.

CATALOG #	DESCRIPTION
KM52542	3 x 4 sharp prongs, 22 mm, 9-1/2" (24 cm)
KM52544	3 x 4 blunt prongs, 22 mm, 9-1/2" (24 cm)

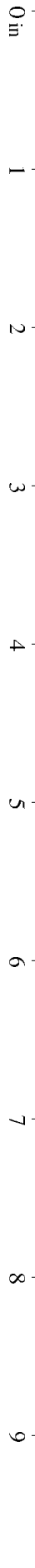

RETRACTORS, SELF-RETAINING

Weitlaner, Gelpi and Henly-Type Retractors

DEBAKEY® GELPI RETRACTOR, SHORT MODEL



CATALOG #	DESCRIPTION
165439	Sharp prongs, 5-3/8" (13.5 cm)

GELPI RETRACTORS



Weck® Pattern, bright finish. Sharp prongs.

CATALOG #	DESCRIPTION
488390	7-1/4" (18.5 cm)
488395	5-3/8" (13.5 cm)

GELPI STANDARD RETRACTOR

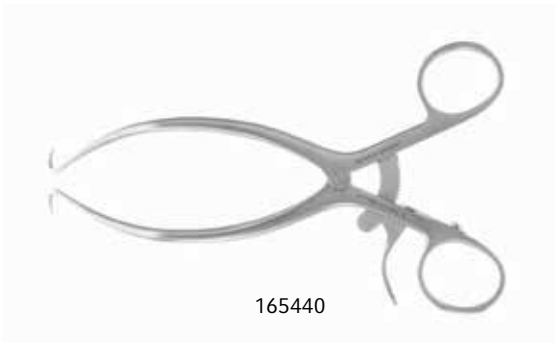

Pilling® Pattern, satin finish.

CATALOG #	DESCRIPTION
165440	Standard type (no stops), single sharp prongs, 7" (18 cm)

RETRACTORS, SELF-RETAINING

Weitlaner, Gelpi and Henly-Type Retractors

GELPI RETRACTORS



KMedic® Pattern, satin finish.

CATALOG #	DESCRIPTION
KM52776	3-1/2" (9 cm)
KM52778	4-3/8" (11 cm)
KM52768	7-1/4" (18.5 cm)
KM52769	With ball stops, 7" (18 cm)

GELPI-SELETZ RETRACTOR



CATALOG #	DESCRIPTION
KM52765	Sharp points, deep blades, 6-1/4" (16 cm)



RETRACTORS, SELF-RETAINING

Weitlaner, Gelpi and Henly-Type Retractors

JOHNSON NEUROMA RETRACTOR



Designed to aid in the removal of interdigital neuroma. Tips overlap in closed position making insertion and removal of retractor easier. Provides excellent visibility of neuroma when retractor is in open position.

CATALOG #	DESCRIPTION
KM52782	Sharp, 5" (12.5 cm)

WILTSE-GELPI RETRACTOR



Deep, angled blades, sharp points.

CATALOG #	DESCRIPTION
KM52771	Angled shaft, 10-7/8" (27.5 cm)

ORIGINAL HENLY POPLITEAL RETRACTOR



A modification of the Weitlaner retractor with provisions for attachment of a third retractor blade for improved exposure in either the popliteal or carotid positions. Supplied with 3 center blades. The retraction surfaces of the center blades are grooved for soft tissue retraction.

CATALOG #	DESCRIPTION
351779	4 x 3 prongs, center blades: 5/8" wide x 3/4" deep (1.5 x 2 cm), 5/8" wide x 1" deep (1.5 x 2.5 cm), 5/8" wide x 1-1/4" deep (1.5 x 3 cm), overall length 6-3/8" (16 cm)



RETRACTORS, SELF-RETAINING

Weitlaner, Gelpi and Henly-Type Retractors

HENLY POPLITEAL RETRACTOR

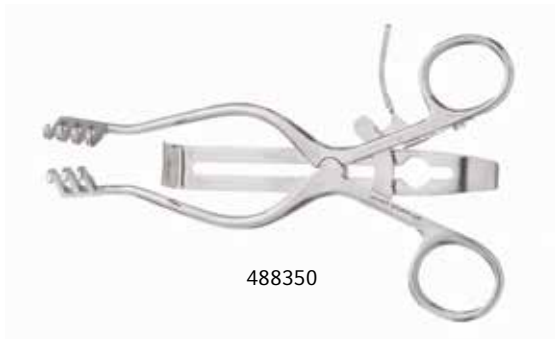

488350

Weck® Pattern, bright finish.

CATALOG #	DESCRIPTION
488350	With 3 detachable center blades: 16 mm wide x 20 mm / 26 mm / 32 mm, 6-3/8" (16 cm)

IMPROVED HENLY RETRACTORS



351679

With interchangeable center blades and side blades.

CATALOG #	DESCRIPTION
351679	Henly Retractor with straight arms, side blades slide onto arms
351680	Henly Retractor with arms spread outward. Both are complete with: <ul style="list-style-type: none"> • 1 frame • 3 center blades, 7/8", 1-1/8" and 1-1/4" deep x 5/8" wide, (2, 3 and 3 cm deep x 1.5 cm wide) • 3 pair of side blades with blunt prongs, 1", 2" and 3" deep x 7/8" wide, (2.5, 5 and 7.5 cm deep x 2 cm wide)



351680

RETRACTORS, SELF-RETAINING

Weitlaner, Gelpi and Henly-Type Retractors

IMPROVED HENLY RETRACTOR SIDE BLADES



351676

Shallow, medium and deep interchangeable sliding side blades.

CATALOG #	DESCRIPTION
351676	1 pair, 1" x 7/8" (2.5 x 2 cm)
351677	1 pair, 2" x 7/8" (5 x 2 cm)
351678	1 pair, 3" x 7/8" (7.5 x 2 cm)

MAINI SIDE BLADE FOR HENLY RETRACTOR



351661

CATALOG #	DESCRIPTION
351661	2-3/4 x 2" (7 X 5 cm), slide on

MAINI RICHARDSON DOUBLE-ENDED CENTER BLADE FOR HENLY RETRACTOR



351664

CATALOG #	DESCRIPTION
351664	Blade ends are 31 and 40 mm wide



RETRACTORS, SELF-RETAINING

Weitlaner, Gelpi and Henly-Type Retractors

PILLING® MULTIPURPOSE RETRACTORS



A versatile self-retaining Henly type retractor designed for use in the following surgical specialties: peripheral vascular surgery in the carotid, subclavian, femoral, popliteal and tibial regions. Spinal surgery in the cervical and lumbar regions. Orthopedic surgery in shoulder and hip procedures. General surgery for inguinal hernia, appendectomy and many minor procedures.

CATALOG #	DESCRIPTION
351675	Pilling® Multipurpose Retractor, complete with: 1 Frame with a 3-1/8" (7.8 cm) spread; 3 Center Blades in sizes 7/8" (2.2 cm), 1-1/8" (2.8 cm) and 1-1/4" (3.2 cm) deep x 5/8" (1.6 cm) wide; 3 pairs of Side Blades in sizes 1-1/8" (2.9 cm), 2-1/8" (5.5 cm) and 3-1/8" (8.0 cm) deep x 7/8" (2.2 cm) wide; Self-retaining, with interchangeable center and side blades. Ball-snap attachment of side blades. Swivel side blades rotate 360 degrees.
351666	1 pair side blades, 1-1/8" x 7/8" (3 x 2 cm) for 351675
351667	1 pair side blades, 2-1/8" x 7/8" (5.5 x 2 cm) for 351675
351668	1 pair side blades, 3-1/8" x 7/8" (8 x 2 cm) for 351675
351669	Center blade, 7/8" x 5/8" (2 x 1.5 cm) for 351675
351670	Center blade, 1-1/8" x 5/8" (3 x 1.5 cm) for 351675
351671	Center blade, 1-1/4" x 5/8" (3 x 1.5 cm) for 351675
351672	Center blade, 2" x 5/8" (5 x 1.5 cm) for 351675
351673	Center blade, 2-1/2" x 5/8" (6.5 x 1.5 cm) for 351675

EXTRA LONG CENTER BLADES



Fits all Henly and Pilling® Multipurpose Retractors.

CATALOG #	DESCRIPTION
351784	Two extra-long center blades in sizes 1-1/2" (4 cm) and 1-3/4" (4.5 cm) deep x 5/8" (1.5 cm) wide

RETRACTORS, SELF-RETAINING

Abdominal/Balfour-Type Retractors

BALFOUR RETRACTORS



165200

Trigger controlled, positive automatic ratchet retaining design. Free, smooth easy movement of all parts. Large selection of blade designs and sizes. Stainless steel construction.

CATALOG #	DESCRIPTION
165200	Wire lateral blades 2" deep (5 cm), center blade 3-5/8" wide x 1-3/4" deep (9 x 4.5 cm), 7" (18 cm) spread
165203	Wire lateral blades 4-3/8" deep (11 cm), center blade 4-3/16" deep x 2-1/2" wide (10.5 x 6.5 cm), 7" (18 cm) spread
165240	Pediatric. Miniature model, arms 3-1/2" long (9 cm), lateral blades 3/4" (2 cm) deep, 4" (10 cm) spread

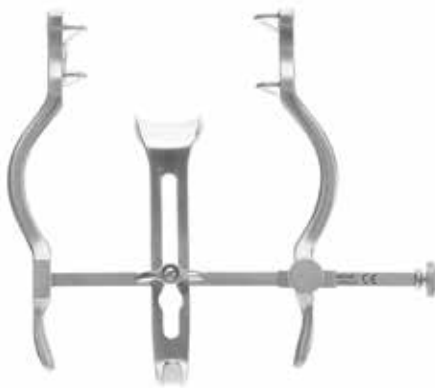

165240

RETRACTORS, SELF-RETAINING

Abdominal/Balfour-Type Retractors

BALFOUR RETRACTORS PERMANENT SIDE BLADE MODEL



165105

CATALOG #	DESCRIPTION
165100	Side blades 2-1/2" (6.5 cm) deep. Center blade 2-3/4" (7 cm) wide x 1-3/4" (4.5 cm) deep, standard size 8" (20.5 cm) opening
165105	Side blades 3-1/2" (9 cm) deep. Center blade 3-1/2" (9 cm) wide x 1-3/4" (4.5 cm) deep, standard size 8" (20.5 cm) opening

IMPROVED BALFOUR RETRACTORS INTERCHANGEABLE SIDE BLADE MODEL



165130

Lateral blades may be easily snapped on and off. Set includes 2 pairs of detachable wire lateral blades 2-1/2" (6.5 cm) and 3-1/2" (9 cm) deep.

CATALOG #	DESCRIPTION
165130	Center blade 2-1/2" (6.5 cm) wide, standard size, 8" (20.5 cm) opening
165133	Center blade 3-1/2" (8.8 cm) wide, extra wide 10-1/2" (26.5 cm) opening
165135	Extra solid lateral blades 2-1/2" (6.5 cm) deep, per pair
165137	Extra wire lateral blades, 2-1/2" (6.5 cm) deep, per pair
165138	Extra wire lateral blades, 3-1/2" (9 cm) deep, per pair



165133

RETRACTORS, SELF-RETAINING

Abdominal/Balfour-Type Retractors

TRANSPLANT RECOVERY BALFOUR RETRACTORS

Transplant retractors for the recovery of the abdominal organs. Spiked lateral blades for maximum hold.

CATALOG #	DESCRIPTION
165107	Adult, 2 x 2 sharp prongs, blades 2-3/4" (7 cm), overall length of arms 7-7/8" (20 cm), 17" (43 cm) spread

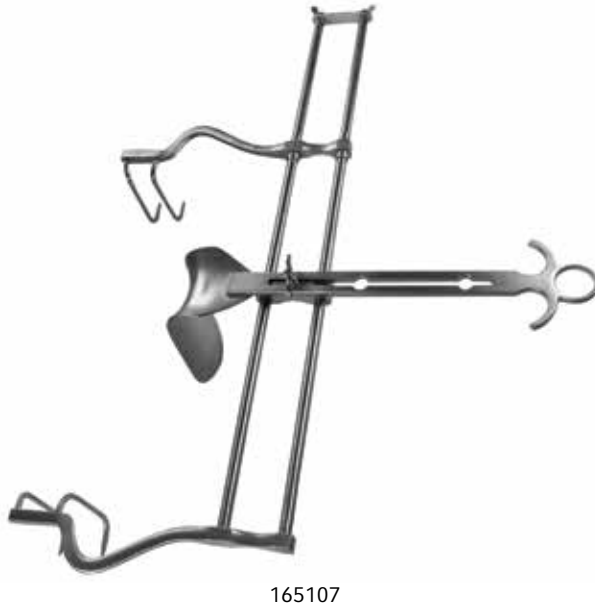

RETRACTORS, SELF-RETAINING

Abdominal/Balfour-Type Retractors

BALFOUR CENTER BLADES



165141



165142



165146



165149

These blades are made for use with the Balfour Retractors 165100 through 165133.

CATALOG #	DESCRIPTION
165141	Standard, 3-1/2" wide x 1-1/4" deep (8.8 cm x 3.2 cm)
165142	Standard, 2-3/4" wide x 1-3/4" deep (7 cm x 4.4 cm)
165143	Supra-Pubic, 3-1/2" wide x 2-5/8" deep (8.8 cm x 6.8 cm)
165145	Narrow, 1-5/8" wide x 3-1/2" deep (4.2 cm x 8.8 cm)
165146	Wide, 2-1/2" wide x 2-5/8" deep (6.3 cm x 6.8 cm)
165147	Wide, 2-1/2" wide x 3-1/2" deep (6.3 cm x 8.8 cm)
165149	Horgan malleable 2" wide x 7-3/4" long (5 x 19.5 cm)
165150	Horgan malleable 2-1/2" wide x 8" long (6.5 x 20.5 cm)

YU HOLTGREVE MALLEABLE BLADE



165160

CATALOG #	DESCRIPTION
165160	2-1/2" wide x 5-7/8" deep x 9-3/8" long (6.5 x 15 x 24 cm)

RETRACTORS, SELF-RETAINING

Abdominal/Balfour-Type Retractors

BALFOUR FOURTH BLADE ATTACHMENTS



165170

Locks securely to arm of Balfour retractors, holding fourth blade. (Blade not included.)

CATALOG #	DESCRIPTION
165170	For right arm
165171	For left arm

O'SULLIVAN-O'CONNOR ABDOMINAL RETRACTORS

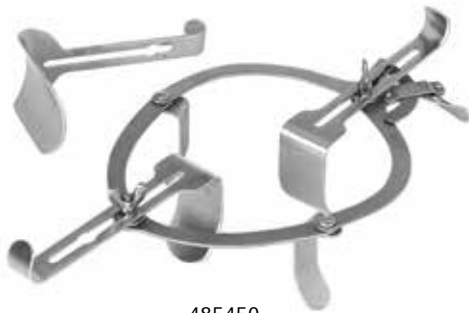

485450

CATALOG #	DESCRIPTION
165300	Adjustable shape ring Spread 7-1/2" (20 cm) Two lateral blades, 1" wide x 3" deep (2.5 x 7.5 cm) Set complete with three detachable blades: 2 small, 1-3/4" wide x 3" deep (4.5 x 7.5 cm), and 1 large, 2-3/4" wide x 4-1/8" deep (7.0 x 10.5 cm) Positive action ratchet regulates diameter
485450	Blades on frame are 73 x 27 mm Three detachable blades: 2 small, 1-3/4" wide x 3-1/8" deep (4.5 x 8 cm), and 1 large, 2-7/8" wide x 4" deep (7 x 10 cm) Spread 12-1/2" (32 cm)

WEXLER BANTAM RETRACTOR



486100

For pediatric and minor surgery use. Set comes complete with frame, 1 center blade and 2 side blades.

CATALOG #	DESCRIPTION
486100	Center blade is 1-1/4" deep x 3/4" wide (3 x 2 cm), side blade is 1-1/8" deep x 7/8" wide (3 x 2.5 cm), 3-7/8" (10 cm) spread

RETRACTORS, SELF-RETAINING

Abdominal/Balfour-Type Retractors

WEXLER STANDARD OCTAGON FRAME

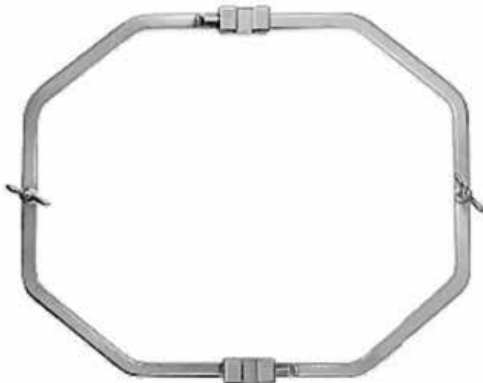

485205

Lateral catches for two blades.

CATALOG #	DESCRIPTION
485205	11-5/16" x 9-3/16" (28.5 x 23.5 cm)

UNIVERSAL JOINT FOR WEXLER RETRACTORS



485210

CATALOG #	DESCRIPTION
485210	Allows rotation on ball with locking arm for Wexler Retractors

WEXLER DEAVER BLADE



485220

For Wexler Retractors.

CATALOG #	DESCRIPTION
485220	2" wide x 4-5/16" deep (5 x 11 cm), 9" (23 cm)

RETRACTORS, SELF-RETAINING

Abdominal/Balfour-Type Retractors

WEXLER DEEP SPREADER



485262

For Wexler Retractors.

CATALOG #	DESCRIPTION
485262	4" x 1-7/8" blades (10 x 5 cm), 5-1/4" (13.5 cm), pair of 2

WEXLER EXPANDABLE BLADE



485225

CATALOG #	DESCRIPTION
485225	2-3/4" (7 cm) wide blade, expands to 5" (12.5 cm)

RETRACTORS, SELF-RETAINING

Thyroid Retractors

HAMBURGER-BRENNAN-MAHORNER RETRACTOR



485270

Set comes complete with frame and 2 side blades.

CATALOG #	DESCRIPTION
485270	7 pointed prongs, 18 x 32 mm, detachable side blades are 5-3/4" (14.5 cm), 33 x 29 mm blade, 4" (10 cm) spread, overall length 9-1/16" (23 cm)

MAHORNER THYROID RETRACTOR

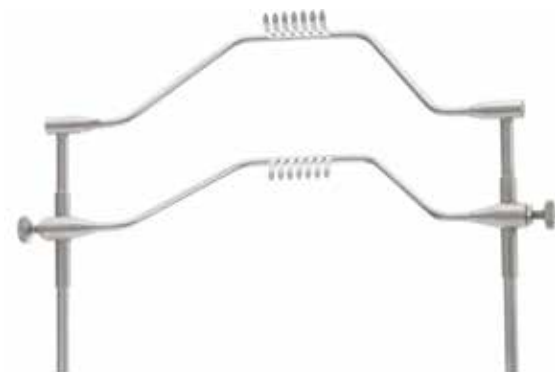

485265

CATALOG #	DESCRIPTION
485265	7 pointed prongs, 15 x 32 mm, 4-3/8" (11 cm) spread, overall 9" (23 cm)

0 in

1

2

3

4

5

6

7

8

9

RETRACTORS, TABLE-MOUNTED

Circuitract Retractor System



MAXIMUM EXPOSURE SAVES OR TIME.

The familiar, easy-to-use Pilling® Circuitract System provides maximum exposure for optimal visibility. With a comprehensive offering, our retractor blades are available in sizes ranging from pediatric to bariatric. All Circuitract components are more affordable and completely compatible with the Bookwalter® System. Bookwalter is a registered trademark of Specialty Surgical Instrumentation Inc.

Circuitract Set includes:

- Horizontal Bar, 14-1/2"
- Post Coupling Clamp
- Vertical Post Table Clamp, 12"
- Horizontal Flex Bar
- Non-Tilting Ratchet (2 per set)
- Advanced Tilting Ratchet (6 per set)
- Ribbon Blade, 2 x 6-1/2" (2 per set)
- Ribbon Blade, 1-1/2 x 6"
- Ribbon Blade, 3 x 6-1/2"
- Kelly Blade, 2 x 3" (2 per set)
- Kelly Blade, 2 x 4"
- Kelly Blade, 2 x 5"
- Kelly Blade, 2 x 6"
- Balfour Blade, 3 x 3-1/2"
- Gelpi Blade
- Harrington Blade, 2-1/2 x 5"
- Oval Ring - Medium
- Segmented Oval Ring - Medium

RETRACTORS, TABLE-MOUNTED

Circuitract Retractor System

CIRCUTRACT SET - COMPONENTS

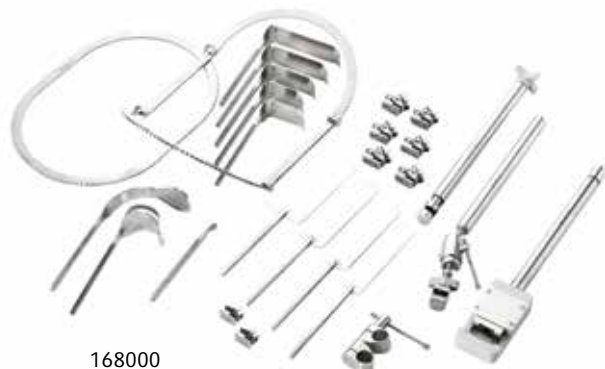

168000

CIRCUTRACT RETRACTOR SYSTEM

CATALOG #	QTY/ SET	DESCRIPTION
168000		Circuitract Set - Components included:
168101	1	Horizontal Bar, 14-1/2"
168103	1	Post Coupling Clamp
168104	1	Vertical Post Table Clamp, 12"
168105	1	Horizontal Flex Bar
168110	2	Non-Tilting Ratchet
168111	6	Advanced Tilting Ratchet
168201	2	Ribbon Blade, 2 x 6-1/2"
168202	1	Ribbon Blade, 1-1/2 x 6"
168203	1	Ribbon Blade, 3 x 6-1/2"
168210	2	Kelly Blade, 2 x 3"
168211	1	Kelly Blade, 2 x 4"
168212	1	Kelly Blade, 2 x 5"
168213	1	Kelly Blade, 2 x 6"
168220	1	Balfour Blade, 3 x 3-1/2"
168221	1	Gelpi Blade
168222	1	Harrington Blade, 2-1/2 x 5"
168254	1	Oval Ring - Medium
168257	1	Segmented Oval Ring - Medium

BARIATRIC COMPONENTS

CATALOG #	DESCRIPTION
168000	Circuitract Set (* included in set)
167050	Storage Case - Blade and Clamp
167051	Storage Case - Ring and Table Post
168101	*Horizontal Bar, 14-1/2"
168102	Extension Bar
168103	*Post Coupling Clamp
168104	*Vertical Post Table Clamp, 12"
168105	*Horizontal Flex Bar
168263	Bariatric Vertical Post, 18-3/8"
168262	Bariatric Segmented Ring - Extra-Large
168205	Bariatric Blade Malleable, 2 x 10"
168206	Bariatric Blade Malleable, 3 x 10"

CATALOG #	DESCRIPTION
168207	Bariatric Blade Malleable, 4 x 10"
168208	Bariatric Blade Malleable, 3 x 12"
168209	Bariatric Blade Malleable, 4 x 12"
168223	Bariatric Harrington Blade, 3-1/2 x 10"
168218	Bariatric Kelly Blade, 2 x 8"

ADDITIONAL COMPONENTS

CATALOG #	DESCRIPTION
168102	Extension Bar
168214	Kelly Blade, 1 x 1-1/4"
168215	Kelly Blade, 1 x 2-1/2"
168216	Kelly Blade, 2 x 1-1/2"
168217	Kelly Blade, 2 x 2-1/2"
168253	Oval Ring - Small
168255	Oval Ring - Large
168256	Segmented Oval Ring - Small
168258	Segmented Oval Ring - Large
168250	Round Ring - Small, 8-1/2"
168251	Round Ring - Medium, 10-1/2"
168252	Round Ring - Large, 12-1/2"
168259	Ring Straight Segments 4" - Sold in Pairs
168260	Ring Straight Segments 6" - Sold in Pairs
168261	Ring Straight Segments 8" - Sold in Pairs
168156	Segmented Ring Replacement Screw
168232	Rectal Blade, 22 x 2-3/4"
168233	Rectal Blade, 23 x 4"
168204	Ribbon Blade, 2 x 8"
168245	Vaginal Deaver Blade - Extra Small 1 x 3-1/2"
168246	Vaginal Deaver Blade - Small 1 x 4-1/2"
168247	Vaginal Deaver Blade - Medium 1-1/2 x 4-1/2"
168248	Vaginal Deaver Blade - Large 2 x 4-1/2"
168228	Rake Blade 3 Prong
168229	Rake Blade 4 Prong
168230	Rake Blade 6 Prong
168243	Lateral Vaginal Blade, 1 x 3"
168244	Posterior Vaginal Blade, 1 x 4-1/2"
168249	Vaginal Retractor Ring, 8 x 10-1/2"
168196	Malleable Pedi Blade, 3/4 x 3"
168197	Malleable Pedi Blade, 1 x 4"
168198	Malleable Pedi Blade, 1 x 5"
168199	Malleable Pedi Blade, 1-1/2 x 3"
168200	Malleable Pedi Blade, 1-1/2 x 4"
168235	Scoville Hook Blade, 2"
168236	Scoville Hook Blade, 3-1/4"
168225	Meyerding Blade, 2-1/3 x 2/3"
168226	Meyerding Blade, 3-1/3 x 1"
168227	Meyerding Blade, 3-3/4 x 2"

RETRACTORS, TABLE-MOUNTED

Wishbone Retractor System



163100



163104



163102



163103



163108

WISHBONE RETRACTOR SYSTEM

Basic system is supplied with a wide assortment of retractor blades for various purposes. Special blade requirements may be ordered economically from your Pilling® Weck® surgical representative. All components are constructed of heat-treated 400 Series stainless steel. There are no plastic washers or small parts.

- A single post table-mounted self-retaining retractor designed for any major abdominal vascular procedures of the aorta, iliacs and their branches.
- Allows use of multiple blades of various configurations, eliminating the need for second or third assistants.
- Non-wavering, non-tiring, self-retaining retraction provides better exposure, speeding the procedure with less postoperative pain.
- Far more versatile than the traditional types of self-retaining retractors. Less restrictive than enclosed ring and frame type retractors.
- Can be easily set up and positioned by the surgeon and one assistant. The rail clamp may be attached to the table rail over the patient drapes.
- Disc clamps on the table upright and crossbar are easily tightened and provide greater force and stability than other systems.
- Closed and open universal clamps that attach the retractor blades to the "wishbone" frame both feature a unique captive design. Clamps are easily cleaned ultrasonically without disassembling them.
- Open distal end of the "split wishbone" allows easier tunneling if grafting is required below the ilio-femoral junction. "Split (two piece) wishbone" frame allows simplified handling and assembly and will fit standard sterilizing trays.



RETRACTORS, TABLE-MOUNTED

Wishbone Retractor System

ABDOMINAL VASCULAR RETRACTOR SET WITH SPLIT WISHBONE - COMPONENTS



CATALOG #	DESCRIPTION	QTY.
163000	Complete set	1
CATALOG #	SET COMPONENTS	SET QTY.
163100	Pilling® Table Clamp	
163102	Upright with Disc Clamp, 20-5/8"	
163103	Crossbar with attached Disc Clamp	
163104	Wishbone-Split Bar, left and right	
163108	Closed Universal Clamp	6
163109	Open Universal Clamp	2
163200	Splanchnic Retractor, 2 x 4-1/4"	
163201	Splanchnic Retractor, 2 x 6-1/4"	
163203	Renal Vein Retractor, 1 x 6"	2
163211	Mayo Retractor, standard, 2-5/8 x 2-1/4"	2
163213	Richardson Retractor, Swivel, 1 x 1-3/4"	
163400	Blade Holder, swivel with handle, 6-1/4"	2
163401	Blade Holder, swivel with knob, 9-1/4"	
163406	Fence Blade, swivel, 4 x 6"	
163420	Mayo Blade, swivel, 2-5/8 x 2-1/4"	
163422	Mayo Blade, wide swivel, 3-1/2 x 2-3/4"	
163424	Deaver Blade, swivel, 2-3/4 x 4-1/2"	
163212	Mayo Retractor, wide, 3-1/2 x 2-3/4"	
163111	Bariatric Crossbar	
163117	Bariatric Side Arm	



RETRACTORS, TABLE-MOUNTED

Wishbone Retractor System

WISHBONE LECHNER-HARRINGTON LIVER BLADE



163436

CATALOG #	DESCRIPTION
163436	1-5/8" x 5" x 10" (4 x 12.5 x 25.5 cm)

Miscellaneous Retractors

GOMEZ/POLY-TRACT RAIL CLAMPS



341114

The Pilling® Rail Clamp is a highly versatile operating table rail clamp for use with the Gomez, Poly-Tract Fowler and other retractor systems, as well as with other equipment to be attached to the operating room table. The Rail Clamp has been designed to fit the side rail of any currently manufactured U.S. or European operating room table.

CATALOG #	DESCRIPTION
341114	Single
166002	Set of four

RETRACTOR FIBER OPTIC "LIGHT BEAM"



163701

This malleable fiber optic light bundle can illuminate the many difficult-to-access surgical sites in the abdomen and pelvis. The captive clamp will attach to many standard table-mounted and self-retaining retractors. It can be operated from fiber optic light sources that accept Pilling® Fiber Optic Cables.

CATALOG #	DESCRIPTION
163701	

SUCTION TUBES

General

ADSON SUCTION TUBES



536103

See "Scales and Gauges" chart in the beginning of the catalog for French size/mm conversion.

CATALOG #	DESCRIPTION
536103	Straight suction with finger valve, 4 mm tip, 8-1/4" (21 cm)

ADSON SUCTION TUBES, CURVED



536100

Curved suction with finger valve. See "Scales and Gauges" chart in the beginning of the catalog for French size/mm conversion.

CATALOG #	DESCRIPTION
536100	7 mm, 7-1/4" (18.5 cm)
536104	6 mm, 8-1/4" (21 cm)
536105	5 mm, 6-1/2" (16.5 cm)

FERGUSON-FRAZIER SUCTION TUBES



162413

Stainless steel tubes, block-type finger valve, complete with cleaning stylette. Angled. 4-7/8" (12.5 cm). Pilling® Pattern, satin finish.

CATALOG #	DESCRIPTION
162410	# 0, 6 Fr. tip
162411	# 1, 7 Fr. tip
162412	# 2, 8 Fr. tip
162413	# 3, 9 Fr. tip
162414	# 4, 10 Fr. tip
162415	# 5, 12 Fr. tip
162416	# 6, 14 Fr. tip
162421	Ferguson Stylet # 0

FRAZIER SUCTION TUBES



KM42826

7" (18 cm). 1 Fr. = .33 mm. KMedic® Pattern, satin finish.

CATALOG #	DESCRIPTION
KM42823	6 Fr. tip
KM42824	7 Fr. tip
KM42825	8 Fr. tip
KM42826	10 Fr. tip
KM42830	12 Fr. tip
KM42825P	Frazier Stylet 8 Fr.



KM42825P

SUCTION TUBES

General

FRAZIER SUCTION TUBES



KM42876

KMedic® Pattern, satin finish.

CATALOG #	DESCRIPTION
KM42863	7 Fr. tip, 4-1/2" (11.5 cm)
KM42864	9 Fr. tip, 4-1/2" (11.5 cm)
KM42866	11 Fr. tip, 4-1/2" (11.5 cm)
KM42873	7 Fr. tip, 7-1/2" (19 cm)
KM42874	9 Fr. tip, 7-1/2" (19 cm)
KM42876	11 Fr. tip, 7-1/2" (19 cm)

PEDIATRIC POOLE SUCTION TUBE



536107

CATALOG #	DESCRIPTION
536107	16 Fr., 6 mm tip, 7-1/2" (19 cm)

POOLE ABDOMINAL SUCTION TUBES



162210

Removable inner tube in multi-perforated outer tube.

CATALOG #	DESCRIPTION
162210	Large, 30 Fr., straight connector, 9-1/4" (23.5 cm)
162212	Small, 23 Fr., curved connector, 10-1/4" (26 cm)

YANKAUER SUCTION TUBES



162300

CATALOG #	DESCRIPTION
162300	Standard adult size, 10 mm diameter. Tip has 2 mm central opening and four 2 mm, side openings. Length 11-1/2" (29 cm)
162301	Tip only for 162300 Yankauer, 1/2" (12.5 mm)



162301

SUCTION TUBES

General

YANKAUER SUCTION TUBE WITH SWITCH VALVE



162345

For use with wall suction. Stopcock-type valve allows reliable "on-off" action. Tube is detachable for cleaning.

CATALOG #	DESCRIPTION
162345	11-3/4" (30 cm)

Specialty

BARON SUCTION TUBES



411702

With finger cut-off.

CATALOG #	DESCRIPTION
411700	3 Fr. tip
411702	5 Fr. tip
411704	7 Fr. tip

ROSEN SUCTION TUBES



411727

CATALOG #	DESCRIPTION
411724	18 Ga. tip, 3-3/4" (9.5 cm)
411726	20 Ga. tip, 3-3/4" (9.5 cm)
411727	22 Ga. tip, 3-3/4" (9.5 cm)
411728	24 Ga. tip, 3-3/4" (9.5 cm)

0 in

1

2

3

4

5

6

7

8

9

SUCTION TUBES

Specialty

FUKUSHIMA SUCTION TUBES

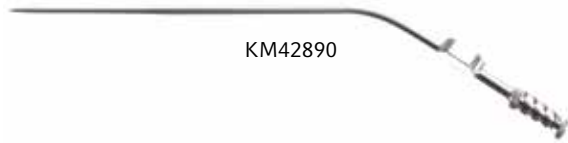

Teardrop opening allows surgeon to regulate force of suction.

CATALOG #	DESCRIPTION
KM42880	4 Fr. tip, 6-1/4" (16 cm)
KM42881	5 Fr. tip, 6-1/4" (16 cm)
KM42882	6 Fr. tip, 6-1/4" (16 cm)
KM42883	7 Fr. tip, 6-1/4" (16 cm)
KM42884	8 Fr. tip, 6-1/4" (16 cm)
KM42885	9 Fr. tip, 6-1/4" (16 cm)
KM42890	4 Fr. tip, 7" (18 cm)
KM42891	5 Fr. tip, 7" (18 cm)
KM42892	6 Fr. tip, 7" (18 cm)
KM42893	7 Fr. tip, 7" (18 cm)
KM42894	8 Fr. tip, 7" (18 cm)
KM42895	9 Fr. tip, 7" (18 cm)
KM42901	4 Fr. tip, 8" (20.5 cm)
KM42902	5 Fr. tip, 8" (20.5 cm)
KM42903	6 Fr. tip, 8" (20.5 cm)
KM42904	7 Fr. tip, 8" (20.5 cm)
KM42905	8 Fr. tip, 8" (20.5 cm)
KM42906	9 Fr. tip, 8" (20.5 cm)

ANDREWS INFANT SUCTION TUBE

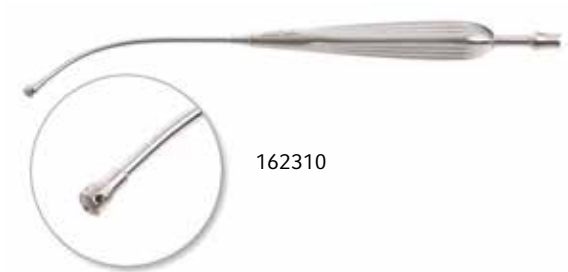

6 mm diameter tip, permanently attached.

CATALOG #	DESCRIPTION
162310	9-1/4" (23.5 cm)

ANDREWS PYNCHON SUCTION TUBE



CATALOG #	DESCRIPTION
536220	Curved, 6 mm tip, 3 mm diameter removable shaft, 9-5/8" (24.5 cm)



SUCTION TUBES

Specialty

COOLEY SUMP SUCTION TUBE



351547

Long, removable perforated outer tube with internal extension provides for fluid removal by sump-drain principle. Entire tube removable from handle for cleaning and rotatable for convenience.

CATALOG #	DESCRIPTION
351547	Curved, 9 mm tip, 12-7/8" (32.5 cm)

DEBAKEY® FIBEROPTIC ILLUMINATED SUCTION TUBE



351508

A modification of the DeBakey®-Yankauer Tube but with a special tip to provide for greater volume of aspirated fluids. Large distal central opening is surrounded by circular perforations and slots in the sides.

CATALOG #	DESCRIPTION
351508	9.5 mm tip, 11-3/8" (29 cm)

DEBAKEY® SUCTION TUBES



351500

CATALOG #	DESCRIPTION
351500	9.5 mm tip, 11-3/8" (29 cm)
351501	DeBakey® Suction Tube Tip for 351500, 3/8" (9.5 mm)



351501

SUCTION TUBES

Specialty

DEBAKEY® SUCTION TUBE



Distal opening with four side openings 3 mm long, 4 mm diameter.

CATALOG #	DESCRIPTION
351502	3 mm diameter tip, 12-1/4" (31 cm)

DEBAKEY®-ADSON CORONARY SUCTION TUBES

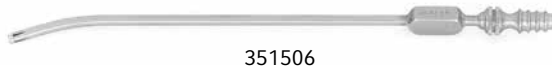

Distal opening with four side openings 3 mm long, 4 mm diameter.

CATALOG #	DESCRIPTION
351504	6-1/8" (15.5 cm)
351506	8-1/8" (20.5 cm)

MORSE-ANDREWS SUCTION TUBE



Short length, small 3 mm outside diameter tube, terminating in 6 mm diameter tip which has one distal and four side openings. Handle is ebonized.

CATALOG #	DESCRIPTION
351505	10-1/4" (26 cm)

EXTENDED LENGTH/OPEN BARIATRIC

Knife Handles/Suction Tubes

KNIFE HANDLES



175055

CATALOG #	DESCRIPTION
175055	#3, 16" (40.5 cm)
175056	#3, 18" (45.5 cm)

YANKAUER SUCTION TUBES

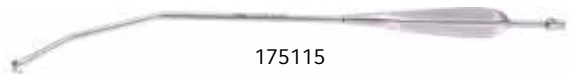

175115

CATALOG #	DESCRIPTION
175114	12" (30.5 cm)
175115	14" (35.5 cm)
175116	16" (40.5 cm)
175117	18" (45.5 cm)

POOLE SUCTION TUBES



175086

CATALOG #	DESCRIPTION
175083	30 Fr. tip, 12" (30.5 cm)
175084	30 Fr. tip, 16" (40.5 cm)
175085	30 Fr. tip, 18" (45.5 cm)
175086	14" (35.5 cm)

Forceps and Clamps

THUMB TISSUE FORCEPS



175109

CATALOG #	DESCRIPTION
175109	1 x 2 teeth, 16" (40.5 cm)
175110	1 x 2 teeth, 18" (45.5 cm)

POTTS SMITH FORCEPS



175087

CATALOG #	DESCRIPTION
175087	14" (35.5 cm)
175088	1 x 2 teeth, 14" (35.5 cm)

0 in

1

2

3

4

5

6

7

8

9

EXTENDED LENGTH/OPEN BARIATRIC

Forceps and Clamps

RUSSIAN TISSUE FORCEPS



175105

CATALOG #	DESCRIPTION
175104	12" (30.5 cm)
175105	14" (35.5 cm)
175106	16" (40.5 cm)

DEBAKEY® TISSUE FORCEPS



175030P

CATALOG #	DESCRIPTION
175026	12" (30.5 cm), TC
175027	14" (35.5 cm), 2 mm
175028	16" (40.5 cm), 2 mm
175029	18" (45.5 cm), 2 mm
175030P	14" (35.5 cm), 3 mm
175031	16" (40.5 cm), 3 mm
175032	18" (45.5 cm), 2.5 mm

GERALD DRESSING FORCEPS



175037

CATALOG #	DESCRIPTION
175037	12" (30.5 cm)

SINGLEY DRESSING FORCEPS



175107

CATALOG #	DESCRIPTION
175107	Serrated, 16" (40.5 cm)
175108	Serrated, 18" (45.5 cm)

FOERSTER SPONGE FORCEPS



175036

CATALOG #	DESCRIPTION
175033	Straight, 12" (30.5 cm)
175034	Straight, 14" (35.5 cm)
175035	Straight, 16" (40.5 cm)
175036	Straight, 18" (45.5 cm)

EXTENDED LENGTH/OPEN BARIATRIC

Forceps and Clamps

ALLIS TISSUE FORCEPS

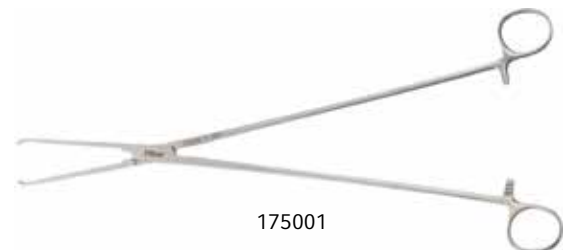

175001

CATALOG #	DESCRIPTION
175000	12" (30.5 cm)
175001	14" (35.5 cm)
175002	16" (40.5 cm)
175003	18" (45.5 cm)
175004	X-action, 18" (45.5 cm)

BABCOCK TISSUE FORCEPS

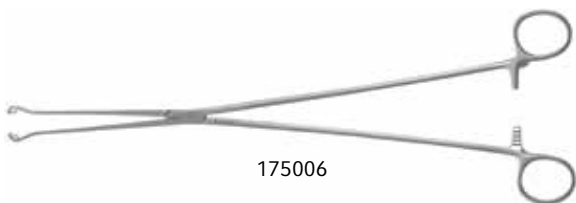

175006

CATALOG #	DESCRIPTION
175005	12" (30.5 cm)
175006	14" (35.5 cm)
175007	16" (40.5 cm)
175008	18" (45.5 cm)
175009	X-action, 18" (45.5 cm)

BRIDGE X-ACTION FORCEPS

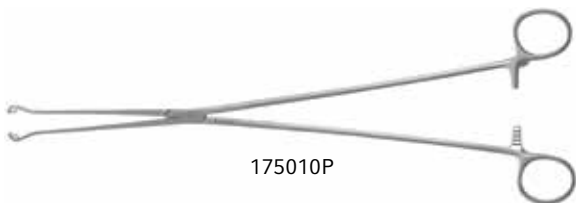

175010P

CATALOG #	DESCRIPTION
175010P	Curved, 18" (45.5 cm)

CARMALT FORCEPS

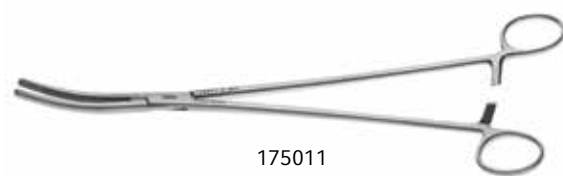

175011

CATALOG #	DESCRIPTION
175011	Curved, 12" (30.5 cm)

CLARK ARTERY FORCEPS

CATALOG #	DESCRIPTION
175012	Curved, 16" (40.5 cm)
175013	Curved, 18" (45.5 cm)

0 in

1

2

3

4

5

6

7

8

9

EXTENDED LENGTH/OPEN BARIATRIC

Forceps and Clamps

COLLIER ANDERSON CLAMPS



175017

CATALOG #	DESCRIPTION
175016	10" (25.5 cm)
175017	11" (28 cm)
175018	14" (35.5 cm)
175019	16" (40.5 cm)

KANTROWITZ RIGHT ANGLE FORCEPS

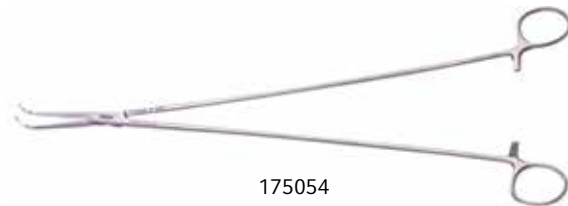

175054

CATALOG #	DESCRIPTION
175053	12" (30.5 cm)
175054	14" (35.5 cm)

MIXTER RIGHT ANGLE FORCEPS



175073

CATALOG #	DESCRIPTION
175073	16" (40.5 cm)
175074	18" (45.5 cm)

MIXTER RIGHT ANGLE FORCEPS

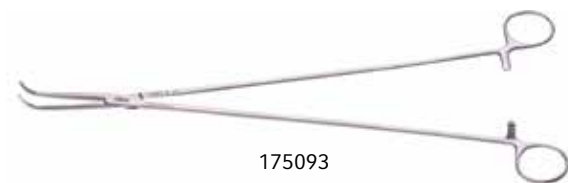

175093

CATALOG #	DESCRIPTION
175093	14" (35.5 cm)
175094	18" (45.5 cm)

EXTENDED LENGTH/OPEN BARIATRIC

Forceps and Clamps

RIGHT ANGLE CLAMP

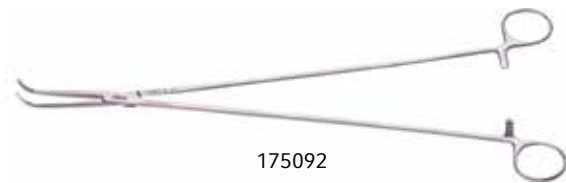

CATALOG #	DESCRIPTION
175092	16" (40.5 cm)

RIGHT ANGLE X-ACTION FORCEPS



CATALOG #	DESCRIPTION
175095	18" (45.5 cm)

KOCKER X-ACTION FORCEPS

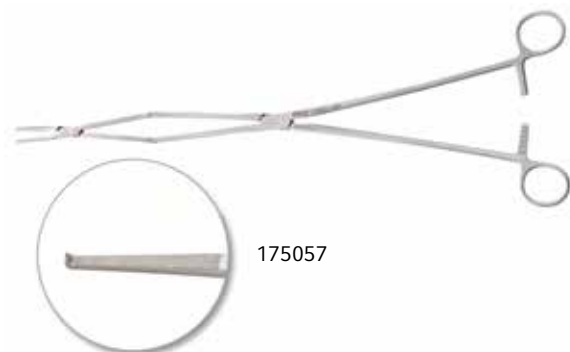

CATALOG #	DESCRIPTION
175057	Straight, serrated, 1 x 2 teeth, 18" (45.5 cm)

TONSIL CLAMP

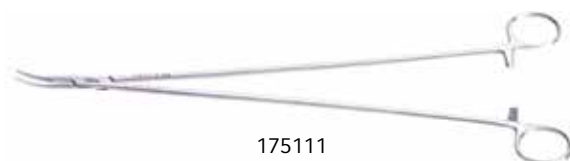

CATALOG #	DESCRIPTION
175111	14" (35.5 cm)

TONSIL FORCEPS

CATALOG #	DESCRIPTION
175112	Straight, serrated, 16" (40.5 cm)

0 in

1

2

3

4

5

6

7

8

9

EXTENDED LENGTH/OPEN BARIATRIC

Forceps and Clamps

ZENKER FORCEPS

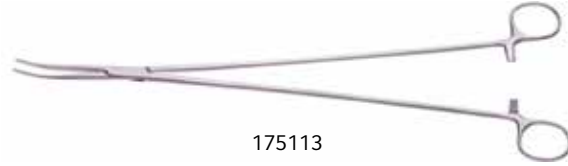

175113

CATALOG #	DESCRIPTION
175113	Straight, 14" (35.5 cm)

ROCHESTER OCHSNER FORCEPS

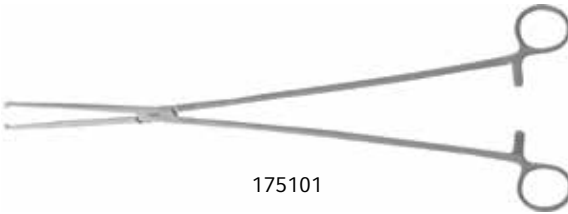

175101

CATALOG #	DESCRIPTION
175096	Straight, serrated, 1 x 2 teeth, 18" (45.5 cm)
175100	Straight, 14" (35.5 cm)
175101	Straight, serrated, 1 x 2 teeth, 16" (40.5 cm)

ROCHESTER PEAN FORCEPS



175097

CATALOG #	DESCRIPTION
175097	Curved, 14" (35.5 cm)
175098	Curved, 18" (45.5 cm)

ROCHESTER PEAN HEMOSTATIC FORCEPS



175099

CATALOG #	DESCRIPTION
175099	16" (40.5 cm)

CLARK HYSTERECTOMY CLAMPS



175015P

CATALOG #	DESCRIPTION
175014	12" (30.5 cm)
175015P	14" (35.5 cm)

EXTENDED LENGTH/OPEN BARIATRIC

Forceps and Clamps

HEANEY BALLENTINE CLAMPS



CATALOG #	DESCRIPTION
175038	Curved, 12" (30.5 cm)
175039	Straight, 12" (30.5 cm)

MASTERSON HYSTERECTOMY FORCEPS



CATALOG #	DESCRIPTION
175059	Curved, 10" (25.5 cm)
175060	Straight, 10" (25.5 cm)

ROGERS HYSTERECTOMY FORCEPS



CATALOG #	DESCRIPTION
175102	Curved, 10" (25.5 cm)
175103	Straight, 10" (25.5 cm)

0 in

1

2

3

4

5

6

7

8

9

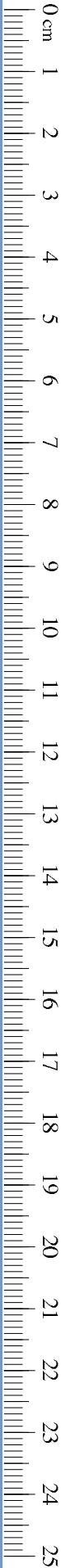

EXTENDED LENGTH/OPEN BARIATRIC

Forceps and Clamps

Z-HYSTERECTOMY FORCEPS

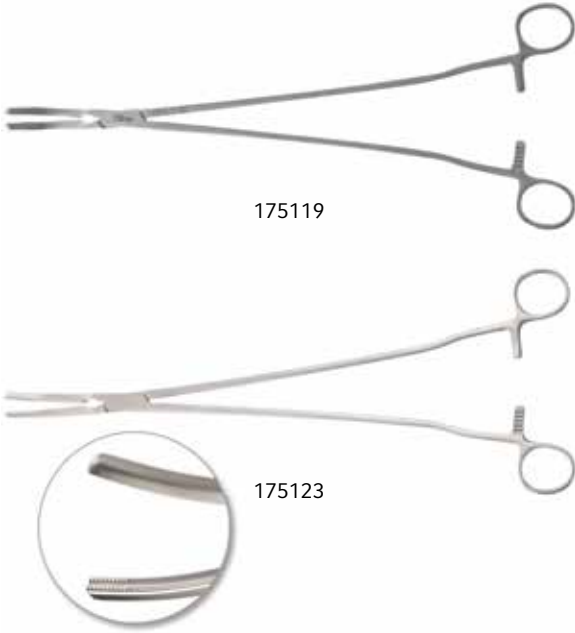

CATALOG #	DESCRIPTION
175118	Angled, 12" (30.5 cm)
175119	Angled, 14" (35.5 cm)
175120	Straight, 12" (30.5 cm)
175121	Straight, 14" (35.5 cm)
175122	Slight curved, 12" (30.5 cm)
175123	Slight curved, 14" (35.5 cm)
175124	Full curved, 12" (30.5 cm)
175125	Full curved, 14" (35.5 cm)

Scissors

COOLEY SCISSORS



CATALOG #	DESCRIPTION
175020P	Curved, 12" (30.5 cm)

EXTENDED LENGTH/OPEN BARIATRIC

Scissors

HYSTERECTOMY SCISSORS



CATALOG #	DESCRIPTION
175042	Curved, 10-1/2" (26.5 cm), TC
175043	Curved, 12" (30.5 cm), TC
175045	Medium curved, 10-1/2" (26.5 cm), TC
175046	Medium curved, 12" (30.5 cm), TC
175048	Acutely curved, 10-1/2" (26.5 cm), TC
175049	Acutely curved, 12" (30.5 cm), TC

JORGENSON SCISSORS



CATALOG #	DESCRIPTION
175052	Acutely curved, 14" (35.5 cm)

MAYO HARRINGTON SUPER-CUT SCISSORS



CATALOG #	DESCRIPTION
175061	Medium curved, 12" (30.5 cm)

MAYO SCISSORS



CATALOG #	DESCRIPTION
175067	Medium curved, 14" (35.5 cm), TC
175068	Medium straight, 14" (35.5 cm), TC

EXTENDED LENGTH/OPEN BARIATRIC

Scissors

METZENBAUM SCISSORS



175071

CATALOG #	DESCRIPTION
175069	Curved, 12" (30.5 cm), TC
175070	Curved, 14" (35.5 cm), TC
175072	Curved, 16" (40.5 cm), TC
175071	Curved, 18" (45.5 cm), TC

NELSON METZENBAUM SCISSORS



175075

CATALOG #	DESCRIPTION
175075	Curved, 16" (40.5 cm)
175076	Curved, 18" (45.5 cm)

NELSON METZENBAUM SUPER-CUT SCISSORS

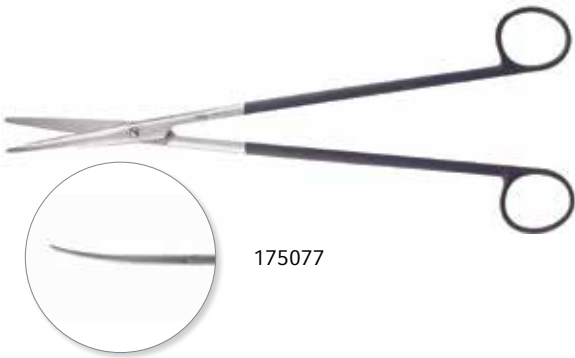

175077

CATALOG #	DESCRIPTION
175077	Supercut, curved, 11-3/4" (30 cm)

POTTS TENOTOMY SCISSORS



175090

CATALOG #	DESCRIPTION
175089	Curved, 10" (25.5 cm)
175090	Curved, 12" (30.5 cm)
175091	Curved, 14" (35.5 cm)



EXTENDED LENGTH/OPEN BARIATRIC

Needle Holders

CRILE WOOD NEEDLE HOLDERS

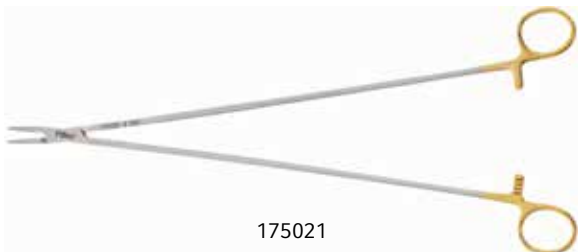

CATALOG #	DESCRIPTION
175021	14" (35.5 cm), TC
175022	16" (40.5 cm), TC

175021

HEANEY NEEDLE HOLDERS

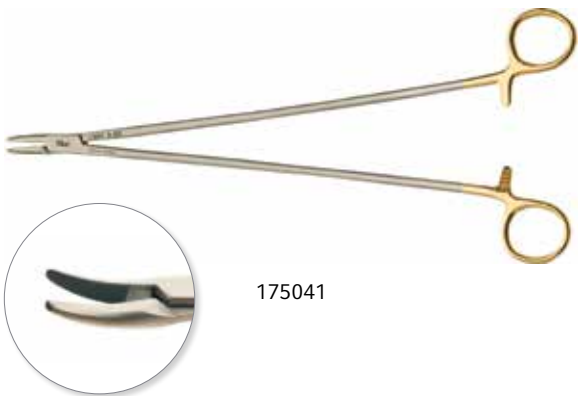

CATALOG #	DESCRIPTION
175040P	12" (30.5 cm), TC
175041	14" (35.5 cm), TC

175041

MASSON NEEDLE HOLDER

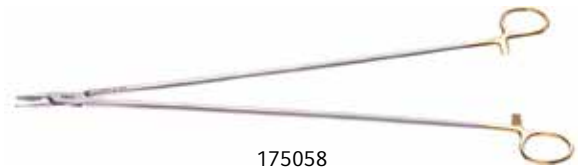

CATALOG #	DESCRIPTION
175058	16" (40.5 cm), TC

175058



EXTENDED LENGTH/OPEN BARIATRIC

Needle Holders

MAYO HEGAR NEEDLE HOLDERS



CATALOG #	DESCRIPTION
175062	12" (30.5 cm), TC
175066	14" (35.5 cm), TC
175063	18" (45.5 cm), TC

MAYO MASSON NEEDLE HOLDER

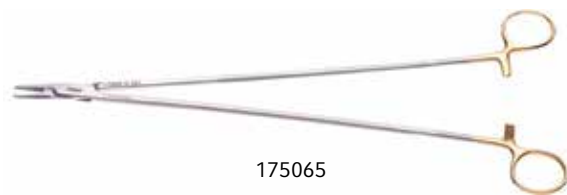

CATALOG #	DESCRIPTION
175065	18" (45.5 cm), TC



EXTENDED LENGTH/OPEN BARIATRIC

Needle Holders

NOLAN NEEDLE HOLDERS

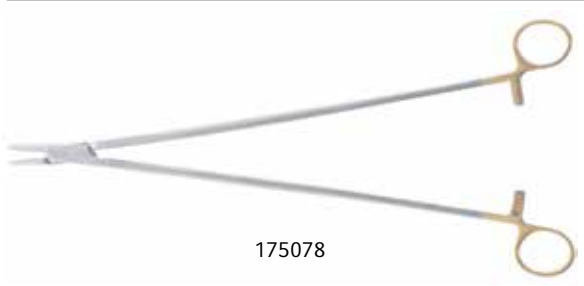

175078

CATALOG #	DESCRIPTION
175078	14" (35.5 cm), TC
175079	16" (40.5 cm)
175080	Curved, 16" (40.5 cm), TC
175081	16" (40.5 cm), TC
175082	18" (45.5 cm)

Retractors

CUSHING VEIN RETRACTORS

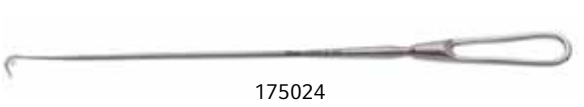

175024

CATALOG #	DESCRIPTION
175023	12-1/2" (32 cm)
175024	14" (35.5 cm)
175025P	16" (40.5 cm)

OB/GYN

Forceps and Clamps

BOZEMAN UTERINE DRESSING FORCEPS

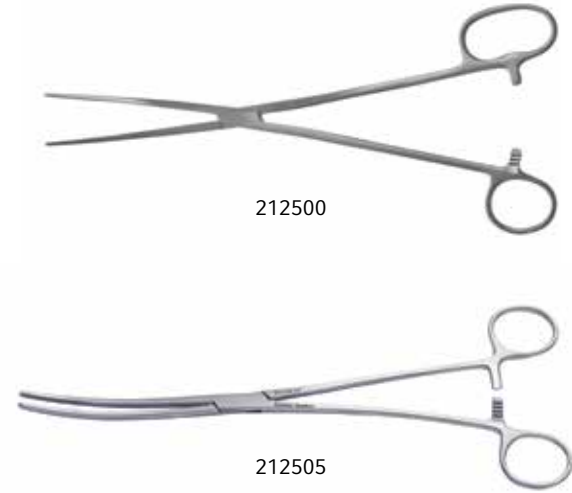

CATALOG #	DESCRIPTION
212500	Double-curved, one large ring, 10-1/4" (26 cm)
212505	Standard model, curved, 10-1/4" (26 cm)

DE LEE CERVICAL GRASPING FORCEPS



CATALOG #	DESCRIPTION
213050	10" (25.5 cm)

KELLY PLACENTA CLAMP

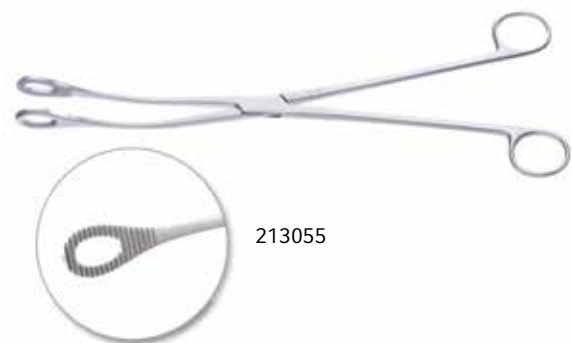

CATALOG #	DESCRIPTION
213055	12-5/8" (32 cm)

OB/GYN

Forceps and Clamps

POLK PLACENTA FORCEPS



Fenestrated jaw with cross serrations.

CATALOG #	DESCRIPTION
770730	Straight, 9-5/8" (24.5 cm)

SOMER UTERINE ELEVATING FORCEPS



CATALOG #	DESCRIPTION
213230	9" (23 cm)

WALLACE CAESAREAN FORCEPS



CATALOG #	DESCRIPTION
770405	Serrated, 25 mm jaw, 8" (20.5 cm)

0 in

1

2

3

4

5

6

7

8

9

OB/GYN

Forceps and Clamps

PHANEUF UTERINE ARTERY FORCEPS

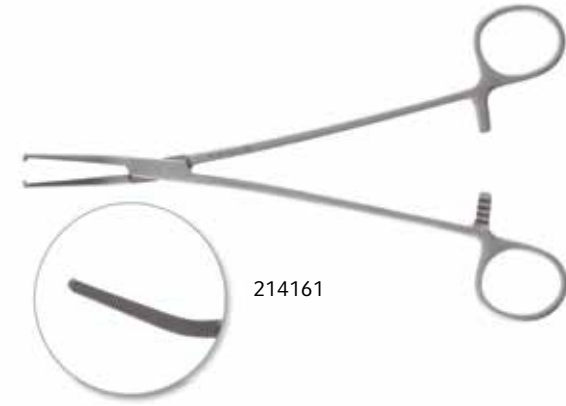

Pilling® Pattern, satin finish.

CATALOG #	DESCRIPTION
214161	Short, heavy jaws, 1 x 2 distal teeth, angled, 8-1/4" (21 cm)

PHANEUF UTERINE ARTERY FORCEPS

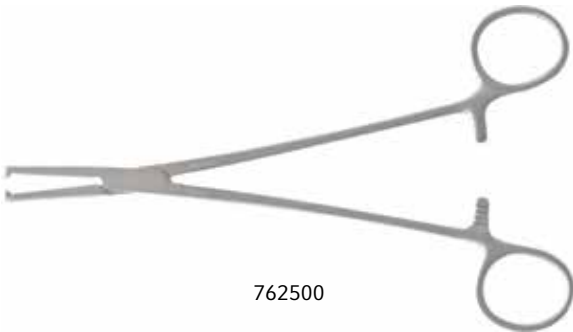

Weck® Pattern, bright finish.

CATALOG #	DESCRIPTION
762500	Straight, serrated, 1 x 2 teeth, 4 mm tip, 8-1/4" (21 cm)

BLAND CERVICAL TRACTION FORCEPS



CATALOG #	DESCRIPTION
213140	Straight, 10 mm tip, 9-1/4" (23.5 cm)



OB/GYN

Forceps and Clamps

DEBAKEY® HYSTERECTOMY CLAMP

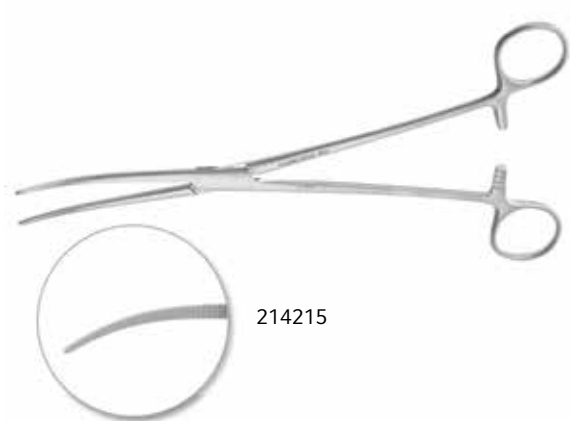

CATALOG #	DESCRIPTION
214215	Curved, 9-3/8" (24 cm)

HEANEY HYSTERECTOMY FORCEPS

Double serrated jaws with cross-groove.



CATALOG #	DESCRIPTION
214170	Curved, light jaws, single groove, 8-1/4" (21 cm)
214172	Curved, heavy jaws, single groove, 8-1/4" (21 cm)
214175	Curved, heavy jaws, double groove, 8-1/4" (21 cm)



OB/GYN

Forceps and Clamps

HEANEY-BALLANTINE HYSTERECTOMY CLAMPS

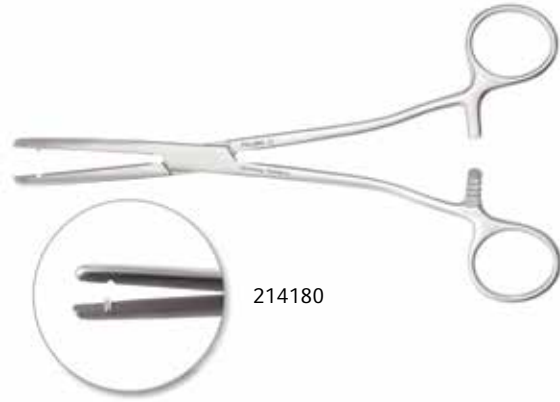

Longitudinally serrated jaws. Single groove.

CATALOG #	DESCRIPTION
214180	Straight, 8-1/4" (21 cm)
214182	Curved, 8-1/8" (20.5 cm)

WERTHEIM-CULLEN PEDICLE CLAMP



CATALOG #	DESCRIPTION
214230	Angled, longitudinally serrated jaws, 8-5/8" (22 cm)

Biopsy Punches

EPPENDORFER BIOPSY PUNCH



CATALOG #	DESCRIPTION
KM65162	Straight, 4 x 8 mm bite, 9" (23 cm)



OB/GYN

Biopsy Punches

KEVORKIAN-YOUNGE CERVICAL BIOPSY FORCEPS



CATALOG #	DESCRIPTION
213036	10-1/8" (25.5 cm)

SCHUBERT BIOPSY PUNCHES



CATALOG #	DESCRIPTION
766520	Angled to side, 5 x 8 mm punch, 9-5/8" (24.5 cm)
766522	Straight, 5 x 8 mm punch, 11" (28 cm)

SCHUBERT BIOPSY PUNCHES



CATALOG #	DESCRIPTION
KM65115	Straight, 8-1/2" (21.5 cm)
KM65118	Angled, 10-1/2" (26.5 cm)

OB/GYN

Biopsy Punches

THOMAS-GAYLOR CERVICAL BIOPSY FORCEPS

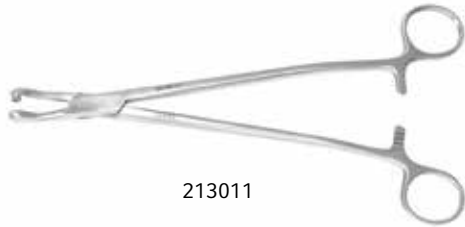

213011

CATALOG #	DESCRIPTION
213011	Curved shanks, 9-1/4" (23.5 cm)

THOMAS-GAYLOR BIOPSY PUNCH



KM65084

CATALOG #	DESCRIPTION
KM65084	Interfitted jaw, 9-1/2" (24 cm)

TISCHLER BIOPSY PUNCHES



KM65186

CATALOG #	DESCRIPTION
KM65188	Straight, 3 x 5 mm, 8" (20.5 cm)
KM65186	Straight, 3 x 7 mm, 9" (23 cm)
KM65204	Shaft only, 3 x 7 mm bite
KM65205	Pistol grip handle only for Tischler punch



OB/GYN

Biopsy Punches

WITTNER BIOPSY FORCEPS



752526

8 x 6 mm toothed basket jaw, 8-7/8" (22.5 cm) stem.

CATALOG #	DESCRIPTION
752526	Straight, 11-1/2" (29 cm)

Circumcision Clamps

GOMCO® CIRCUMCISION CLAMPS



742110

CATALOG #	DESCRIPTION
742100	Extra small, 11 mm
742102	Newborn, 13 mm
742104	Infant, 15 mm
742106	Child, 16 mm
742108	Youth, 21 mm
742110	Adult, 26 mm

OB/GYN

Delivery Forceps

DE LEE OBSTETRICAL FORCEPS



214595

CATALOG #	DESCRIPTION
214595	12" (30.5 cm)

MCLEAN-TUCKER-LUIKART OBSTETRICAL FORCEPS



214605

CATALOG #	DESCRIPTION
214605	15-1/2" (39.5 cm)

SIMPSON OBSTETRICAL FORCEPS



214555

CATALOG #	DESCRIPTION
214550	14" (35.5 cm)
214555	12" (30.5 cm)

SIMPSON-LUIKART OBSTETRICAL FORCEPS



214570

CATALOG #	DESCRIPTION
214570	Fenestrated, smooth, 14" (35.5 cm)

OB/GYN

Scissors

BUSCH UMBILICAL SCISSORS



CATALOG #	DESCRIPTION
KM67294	Curved sideways, 6-1/2" (16.5 cm)

UMBILICAL SCISSORS

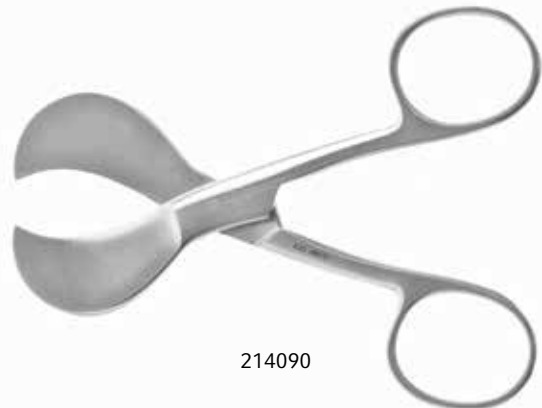

CATALOG #	DESCRIPTION
214090	4-1/8" (10.5 cm)
KM67292	Straight, 4-3/8" (11 cm)

BRAUN EPISIOTOMY SCISSORS



CATALOG #	DESCRIPTION
214081	Wide lower blade, angled to side, 8-3/4" (22 cm)

0 in

1

2

3

4

5

6

7

8

9

OB/GYN

Probes, Sounds and Dilators

EMMETT UTERINE PROBE

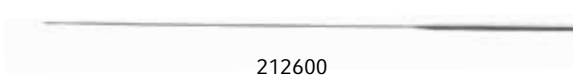

212600

CATALOG #	DESCRIPTION
212600	Sterling Silver, 11" (28 cm)

SIMPSON UTERINE SOUND



212605

CATALOG #	DESCRIPTION
212605	4 mm, graduated in inches, silver plated, malleable, 12-3/4" (32.5 cm)

SIMS UTERINE SOUNDS



212612

CATALOG #	DESCRIPTION
212610	4 mm, non-graduated, silver plated, malleable, 12-3/4" (32.5 cm)
212612	4 mm, graduated in cm, malleable, 12-3/4" (32.5 cm)

OB/GYN

Probes, Sounds and Dilators

HANK UTERINE DILATORS



212666

Pilling® Pattern, satin finish. Double-ended. Length 10-3/4" (27.5 cm). All sizes available individually.

CATALOG #	DESCRIPTION
212659	Hank Uterine Dilators, set of 6, sizes 11-12 Fr. to 21-22 Fr. (3.66 to 7.33 mm)
212661	9-10 Fr. (3 x 3.3 mm)
212662	11-12 Fr. (3.6 x 4 mm)
212663	13-14 Fr. (4.3 x 4.7 mm)
212664	15-16 Fr. (5 x 5.3 mm)
212665	17-18 Fr. (5.7 x 6 mm)
212666	19-20 Fr. (6.3 x 6.7 mm)
212667	21-22 Fr. (7 x 7.3 mm)
212668	23-24 Fr. (7.7 x 8 mm)
212669	25-26 Fr. (8.3 x 8.7 mm)
212670	27-28 Fr. (9 x 9.3 mm)
212671	29-30 Fr. (9.3 x 10 mm)

HANK UTERINE DILATORS



752382

Weck® Pattern, bright finish. Double-ended. End lengths 2-1/2" (6.5 cm). Length 10-3/8" (26.5 cm).

CATALOG #	DESCRIPTION
752380	9/10 American (4.5 x 5 mm)
752381	11/12 American (5.5 x 6 mm)
752382	13/14 American (6.5 x 7 mm)
752383	15/16 American (7.5 x 8 mm)
752384	17/18 American (8.5 x 9 mm)
752385	19/20 American (9.5 x 10 mm)

0 in

1

2

3

4

5

6

7

8

9

OB/GYN

Probes, Sounds and Dilators

HEGAR UTERINE DILATORS



212673

Pilling® Pattern, satin finish. Double-ended, 7-7/8" (20 cm).

CATALOG #	DESCRIPTION
212673	Set of 8, sizes 3 mm to 18 mm
212675	Size 3-4 mm
212676	Size 5-6 mm
212677	Size 7-8 mm
212678	Size 9-10 mm
212679	Size 11-12 mm
212680	Size 13-14 mm
212681	Size 15-16 mm
212682	Size 17-18 mm



212678

HEGAR UTERINE DILATORS



752354

Weck® Pattern, bright finish. Double-ended, hollow, 7-7/8" (20 cm).

CATALOG #	DESCRIPTION
752338	Size 1/2 mm
752347	Size 19/20 mm
752348	Size 21/22 mm
752349	Size 23/24 mm
752351	Size 25/26 mm
752354	Complete set in case



OB/GYN

Probes, Sounds and Dilators

PRATT UTERINE DILATORS



212647

Pilling® Pattern, satin finish. Double-ended, 11-5/8" (29.5 cm). Stainless steel.

CATALOG #	DESCRIPTION
212647	Set of 8 in canvas case, sizes 13-15 Fr. to 41-43 Fr.

PRATT UTERINE DILATORS



752394

Weck® Pattern, bright finish. Double-ended, 11-5/8" (29.5 cm).

CATALOG #	DESCRIPTION
752390	Size 13-15 Fr.
752391	Size 17-19 Fr.
752392	Size 21-23 Fr.
752393	Size 25-27 Fr.
752394	Size 29-31 Fr.
752395	Size 33-35 Fr.
752396	Size 37-39 Fr.
752397	Size 41-43 Fr.

Curettes

HEANEY BIOPSY CURETTE

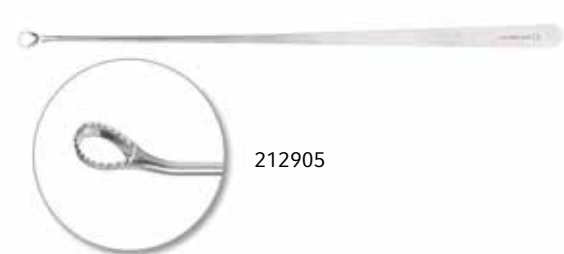

212905

CATALOG #	DESCRIPTION
212905	9-3/4" (25 cm)



OB/GYN

Curettes

KEVORKIAN-YOUNGE BIOPSY CURETTE

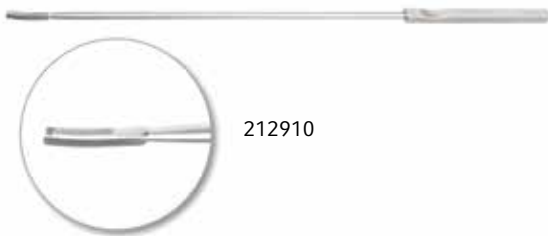

212910

Pilling® Pattern.

CATALOG #	DESCRIPTION
212910	12-1/8" (31 cm)

KEVORKIAN-YOUNGE CURETTES



KM64796

Sharp tip.

CATALOG #	DESCRIPTION
KM64796	Without basket, 12" (30.5 cm)
KM64802	With basket, 12" (30.5 cm)



OB/GYN

Curettes

RANDALL SUCTION BIOPSY CURETTE



CATALOG #	DESCRIPTION
KM64808	Sharp, curved, 4 mm diameter, 9-3/4" (25 cm)



KM64808

SIMS UTERINE CURETTES



Sharp blades. Malleable shafts.

CATALOG #	DESCRIPTION
212749	Size 0, 10-7/8" (27.5 cm)
212750	Size 1, 11-1/4" (28.5 cm)
212751	Size 2, 11-1/4" (28.5 cm)
212752	Size 3, 11-3/8" (29 cm)
212753	Size 4, 11-1/2" (29 cm)
212754	Size 5, 11-1/2" (29 cm)
212755	Size 6, 11-5/8" (29.5 cm)



212752

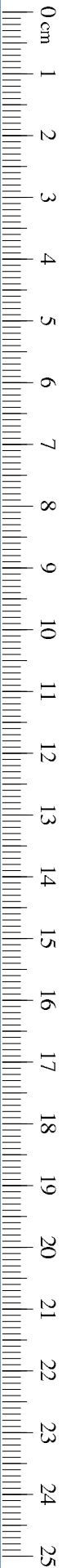

OB/GYN

Tenaculums and Vulsellums

ADAIR TENACULUM



CATALOG #	DESCRIPTION
213120	6-7/8" (17.5 cm)

BARRETT TENACULUM



CATALOG #	DESCRIPTION
213110	7-1/4" (18.5 cm)

BRAUN TENACULUM



CATALOG #	DESCRIPTION
213100	9-5/8" (24.5 cm)

OB/GYN

Tenaculums and Vulsellums

DUPLAY TENACULUM



213085

CATALOG #	DESCRIPTION
213085	9-7/8" (25 cm)

HULKA TENACULUM AND PROBE



754125

CATALOG #	DESCRIPTION
754125	Single tooth, probe 4-3/4" (12 cm) w/ 3.6 mm tip, 11-1/8" (28.5 cm)

JARCHO TENACULUM



213065

CATALOG #	DESCRIPTION
213065	8" (20.5 cm)

SCHROEDER TENACULUM



213080

CATALOG #	DESCRIPTION
213080	9-7/8" (25 cm)

0 in

1

2

3

4

5

6

7

8

9

OB/GYN

Tenaculums and Vulsellums

STAUDE TENACULUM



213090

CATALOG #	DESCRIPTION
213090	5-3/8" (13.5 cm)

STAUDE-MOORE TENACULUM

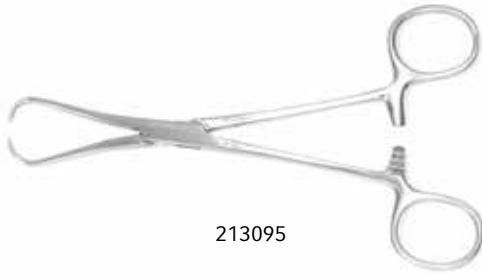

213095

CATALOG #	DESCRIPTION
213095	6-3/8" (16 cm)

WYLIE UTERINE TENACULUM



754160

CATALOG #	DESCRIPTION
754160	1 x 2 teeth, 9-1/2" (24 cm)



OB/GYN

Tenaculums and Vulsellums

HENROTIN VULSELLUM



213150

CATALOG #	DESCRIPTION
213150	8-1/4" (21 cm)

JACOB'S VULSELLUM FORCEPS



213155

CATALOG #	DESCRIPTION
213155	Straight, 2 x 2 teeth, 8-1/4" (21 cm)
213157	Curved sideways, serrated, 2 x 2 teeth, 8-1/4" (21 cm)



213157

KELLY VULSELLUM



213160

CATALOG #	DESCRIPTION
213160	Curved sideways, 9-1/2" (24 cm)

OB/GYN

Tenaculums and Vulsellums

M.G.H. VULSELLUM



CATALOG #	DESCRIPTION
213175	3 x 3 teeth, 6-1/8" (15.5 cm)

SCHROEDER VULSELLUM



CATALOG #	DESCRIPTION
213180	Straight, 9-7/8" (25 cm)

TEALE UTERINE VULSELLUM



CATALOG #	DESCRIPTION
754370	Curved sideways, 3 x 4 teeth, 9-1/4" (23.5 cm)

OB/GYN

Specula

GRAVES VAGINAL SPECULA



212001

CATALOG #	DESCRIPTION
212000	Small blade 3-1/4" (8.5 cm) long x 7/8" (2.2 cm) wide
212001	Medium blade 4-3/8" (11 cm) long x 1-3/8" (3.5 cm) wide
212002	Large blade 5" (13 cm) long x 1-1/2" (3.7 cm) wide
212005	Medium, right open-sided blade 4-3/8" (11 cm) long x 1-3/8" (3.5 cm) wide



212005

0 in

1

2

3

4

5

6

7

8

9

OB/GYN

Specula

PEDERSON VAGINAL SPECULA



212011

Narrow, straight side blades.

CATALOG #	DESCRIPTION
212010	Small, 3-1/4" x 1/2" (8.5 x 1.5 cm)
212011	Medium, 3-1/4" x 1" (8.5 x 2.5 cm)
212012	Large, 4-3/4" x 1" (12 x 2.5 cm) blades

SLENDER PEDERSON SPECULUM



KM64288

CATALOG #	DESCRIPTION
KM64288	Narrow blades, 4-11/32" (110 mm) long x 11/16" (17.5 mm) wide with a 2-7/8" (73 mm) maximum opening

KOGAN ENDOCERVICAL SPECULUM



KM64830

CATALOG #	DESCRIPTION
KM64830	With gauge and set screw, 9-1/2" (24 cm)

OB/GYN

Specula

AUVARD WEIGHTED VAGINAL SPECULA



212196

CATALOG #	DESCRIPTION
212195	3 lbs., 3" (7.5 cm)
212196	2-1/2 lbs., 3-3/8" (8.5 cm)
212197	3 lbs., 4" (10 cm)

GARRIGUE WEIGHTED VAGINAL SPECULUM



212185

CATALOG #	DESCRIPTION
212185	Cut-out handle allows drainage. Blade 1-5/8" x 3-1/8" (4 x 8 cm), weight 2 lbs., chrome plated

HENROTIN WEIGHTED VAGINAL SPECULUM



212187

CATALOG #	DESCRIPTION
212187	Blade 1-1/2" x 3-1/2" (3.8 x 9 cm), weight 3 lbs, chrome plated

0 in

1

2

3

4

5

6

7

8

9

OB/GYN

Retractors

DE LEE UNIVERSAL RETRACTOR



CATALOG #	DESCRIPTION
212350	3" x 2-1/8" (7.5 x 5.5 cm) blade, 9-1/2" (24 cm)

EASTMAN VAGINAL RETRACTORS



CATALOG #	DESCRIPTION
212271	1-3/8" x 3-1/4" (3.5 x 8.5 cm)
212275	1-3/8" x 3-7/8" (3.5 x 10 cm)

HEANEY-SIMON VAGINAL RETRACTOR



CATALOG #	DESCRIPTION
212305	1-1/8" x 4-3/4" (2.5 x 12 cm), blade length 11" (28 cm)

OB/GYN

Retractors

JACKSON VAGINAL RETRACTORS



212264

CATALOG #	DESCRIPTION
212263	1-9/16" x 3-1/4" (4 x 8.5 cm)
212264	1-9/16" x 3-19/32" (4 x 9 cm)
212265	1-19/32" x 4" (4 x 10 cm)

PRYOR-PEAN RETRACTOR



212295

CATALOG #	DESCRIPTION
212295	1" x 4-1/2" (2.5 x 11.5 cm), blade length 10-3/8" (26.5 cm)

SIMS VAGINAL RETRACTORS



212228

Double-ended.

CATALOG #	DESCRIPTION
212225	7/8" x 2-5/8" (2 x 6.5 cm) and 1" x 3-1/8" (2.5 x 8 cm)
212226	1" x 2-1/2" (2.5 x 6.5 cm) and 1-1/4" x 3" (3 x 7.5 cm)
212227	1" x 3-1/4" (2.5 x 8.5 cm) and 1-3/16" x 3-1/2" (3 x 9 cm)
212228	1-1/4" x 3" (3 x 7.5 cm) and 1-3/8" x 3-1/4" (3.5 x 8.5 cm)
212229	1-3/16" x 3-1/4" (3 x 8.5 cm) and 1-7/16" x 4" (3.5 x 10 cm)

0 in

1

2

3

4

5

6

7

8

9

OB/GYN

Retractors

SIMS VAGINAL RETRACTORS



212241

Single-ended.

CATALOG #	DESCRIPTION
212241	1-1/8" x 3-5/8" (3 x 9 cm)
212242	1-1/2" x 3-1/2" (4 x 9 cm)

Laser Instruments

BELLINA LASER RULERS

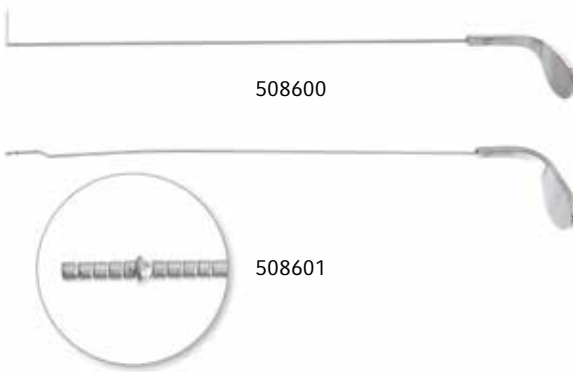

508600

508601

For determining depth and length of tissue for ablation purposes.

CATALOG #	DESCRIPTION
508600	Lateral ruler, graduated in millimeters up to 15 mm
508601	Straight ruler, graduated in millimeters with a ridge indicating the 5 mm mark

CERVICAL LASER HOOKS

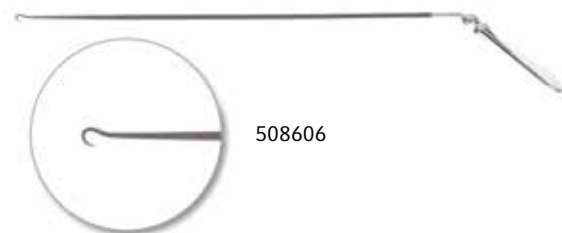

508606

Ebonized for use with laser surgery.

CATALOG #	DESCRIPTION
508605	Small, 2 mm hook, 6-1/2" (16.5 cm) working length, overall 9-1/2" (24 cm)
508606	Large, 4 mm hook, 7" (18 cm) working length, overall 9-7/8" (25 cm)

OB/GYN

Laser Instruments

LASER MIRROR

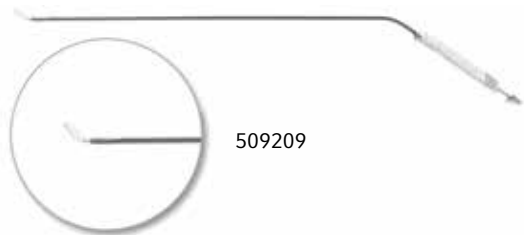

Highly polished stainless steel front surface mirror. Suction to draw smoke and steam.

CATALOG #	DESCRIPTION
509209	6 mm diameter, working length 8-1/4" (21 cm)

MILAN-LONDON VACUUM TUBE



Ebonized for use with laser surgery. Clips onto a standard metal Graves speculum for evacuation of smoke and plume.

CATALOG #	DESCRIPTION
508602	4-7/8" (12.5 cm)

OSSOFF MICRO SUCTION TUBE EBONIZED



Ebonized for use with laser surgery.

CATALOG #	DESCRIPTION
509204	7 Fr., working length 7-7/8" (20 cm)

0 in

1

2

3

4

5

6

7

8

9

OB/GYN

Laser Instruments

PILLING® LASER SPECULA



Inner blades are matte finished to help reduce reflection of the laser beam. External blades are polished stainless steel for ease of insertion. One smoke evacuation tube is on the upper blade for rapid removal of steam and smoke from the ablated tissue. Available in three sizes.

CATALOG #	DESCRIPTION
508610	Small, blades 3-1/4" (8.5 cm) long x 7/8" (2.2 cm) wide, suction tube 4-5/8" (12 cm) long (unbent)
508612	Medium, blades 4-3/8" (11 cm) long x 1-3/8" (3.5 cm) wide, suction tube 4-5/8" (12 cm) long (unbent)
508614	Large, blades 5" (13 cm) long x 1-1/2" (3.7 cm) wide, suction tube 5-1/2" (14 cm) long (unbent)

SCHROEDER TENACULUM



Ebonized for use with laser surgery.

CATALOG #	DESCRIPTION
508694	10" (25.5 cm)

THOMS-ALLIS VULSELLUM FORCEPS



Ebonized for use with laser surgery.

CATALOG #	DESCRIPTION
508696	Straight, 6 x 7 Teeth, 8" (20.5 cm)

OB/GYN

Miscellaneous

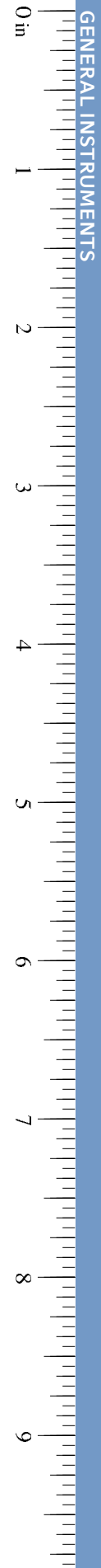

BETHEA SHEET HOLDERS



214770

CATALOG #	DESCRIPTION
214770	1" (2.5 cm) wide, 5" (12.5 cm) diameter

IOWA TRUMPET NEEDLE GUIDE



884227

For paracervical anesthesia.

CATALOG #	DESCRIPTION
884227	Ball tip 7 mm, 5-1/2" (14 cm)

UROLOGY

Forceps and Clamps

HERRICK KIDNEY CLAMP

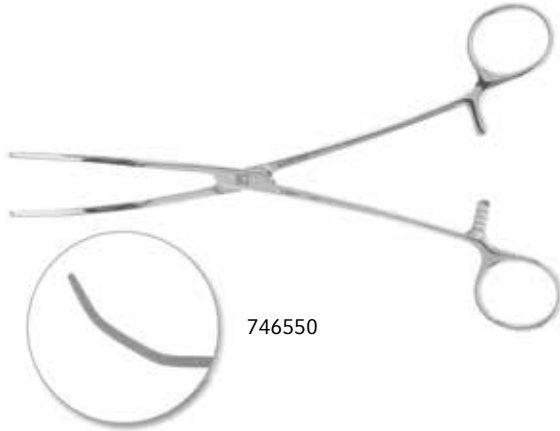

CATALOG #	DESCRIPTION
746550	Angled, 41 mm jaw with longitudinal serrations, 9" (23 cm)

RANDALL KIDNEY STONE GRASPING FORCEPS



CATALOG #	DESCRIPTION
172650	#1, 1/4" curved, 9-1/4" (23.5 cm)
172655	#2, 1/2" curved, 8-1/4" (21 cm)
172660	#3, 3/4" curved, 7-3/4" (19.5 cm)
172665	#4, Full Curved, 7-3/8" (18.5 cm)

UROLOGY

Forceps and Clamps

MAYO VESSEL CLAMP

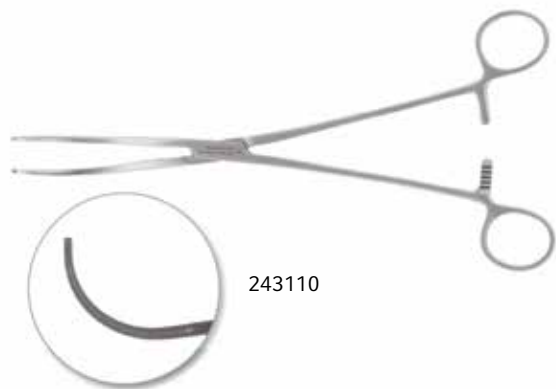

243110

CATALOG #	DESCRIPTION
243110	Curved, 1-1/2" (4 cm) tip length, 10" (25.5 cm)

MCDUGAL™ PROSTATECTOMY CLAMPS

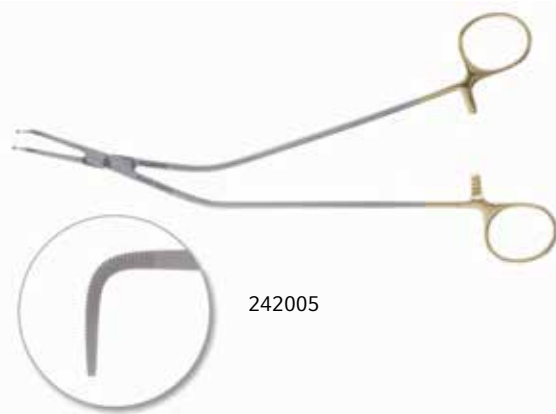

242005

Secures the dorsal vein complex during radical retropubic prostatectomy. Useful for other deep retropubic or deep pelvic work when approached from the abdomen. Allows easy access in operative site obstructed by the pubis or other structures.

CATALOG #	DESCRIPTION
242005	Angled left, 1" (2.5 cm) tip length, 9-7/8" (25 cm)
242006	Angled right, 1" (2.5 cm) tip length, 9-7/8" (25 cm)

0 in

1

2

3

4

5

6

7

8

9

UROLOGY

Forceps and Clamps

VASECTOMY CLAMP



CATALOG #	DESCRIPTION
244001	No scalpel ring clamp, 3.6 mm ring I.D., 5-1/2" (14 cm)

VASECTOMY FORCEPS



CATALOG #	DESCRIPTION
244000	No scalpel hemostat, 19 Ga. tip, sharp, 5-1/8" (13 cm)



UROLOGY

Forceps and Clamps

ZIPSER PENIS CLAMP

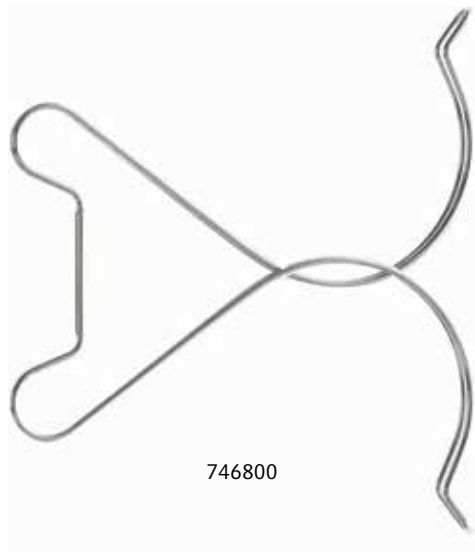

CATALOG #	DESCRIPTION
746800	3-3/8" (8.5 cm)

Dilators, Sounds and Needles

DITTEL URETHRAL SOUNDS



KM64014

11-1/2" (29 cm). 1 Fr. = 0.33 mm.

CATALOG #	DESCRIPTION
KM64008	8 Fr., 11-1/2" (29 cm)
KM64010	10 Fr., 11-1/2" (29 cm)
KM64012	12 Fr., 11-1/2" (29 cm)
KM64014	14 Fr., 11-1/2" (29 cm)
KM64016	16 Fr., 11-1/2" (29 cm)
KM64018	18 Fr., 11-1/2" (29 cm)
KM64020	20 Fr., 11-1/2" (29 cm)
KM64022	22 Fr., 11-1/2" (29 cm)
KM64024	24 Fr., 11-1/2" (29 cm)
KM64026	26 Fr., 11-1/2" (29 cm)
KM64028	28 Fr., 11-1/2" (29 cm)
KM64030	30 Fr., 11-1/2" (29 cm)
KM64032	32 Fr., 11-1/2" (29 cm)
KM64034	34 Fr., 11-1/2" (29 cm)

UROLOGY

Dilators, Sounds and Needles

VAN BUREN URETHRAL DILATORS



10-7/8" (27.5 cm), even sizes, 8 Fr. to 32 Fr.

CATALOG #	DESCRIPTION
241108	8 Fr.
241110	10 Fr.
241112	12 Fr.
241114	14 Fr.
241116	16 Fr.
241118	18 Fr.
241120	20 Fr.
241122	22 Fr.
241124	24 Fr.
241126	26 Fr.
241128	28 Fr.
241130	30 Fr.
241132	32 Fr.

LITVAK PEREYRA LIGATURE NEEDLE



CATALOG #	DESCRIPTION
214687	9-7/8" (25 cm)

STAMEY NEEDLES

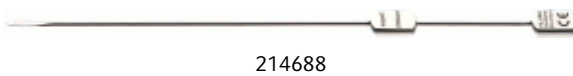

Used in conjunction with the treatment of urinary incontinence in the female.

CATALOG #	DESCRIPTION
214688	Straight, 9-3/4" (25 cm)
214689	Angled 15 degrees, 9-3/4" (25 cm)
214691	Angled 30 degrees, 9-3/4" (25 cm)



UROLOGY

Catheter Guides

FEMALE CATHETER SILVERS



740166

CATALOG #	DESCRIPTION
740165	14 Fr., 5-7/8" (15 cm)
740166	16 Fr., 5-7/8" (15 cm)

GUYON CATHETER GUIDE



746797

CATALOG #	DESCRIPTION
746797	9 Fr., 13-1/4" (33.5 cm)

VAN BUREN CATHETER GUIDE



746798

CATALOG #	DESCRIPTION
746798	9 Fr., 13-3/4" (35 cm)

Retractors

LOWSLEY PROSTATIC RETRACTORS



243200

CATALOG #	DESCRIPTION
243200	Curved, 9-1/2" (24 cm)
243201	Straight, 12-7/8" (32.5 cm)

RECTAL

Forceps and Clamps

BARRON HEMORRHOIDAL ALLIGATOR SEIZING FORCEPS



CATALOG #	DESCRIPTION
202970	5 x 6 teeth, 11-3/4" (30 cm)

BUIE PILE CLAMP

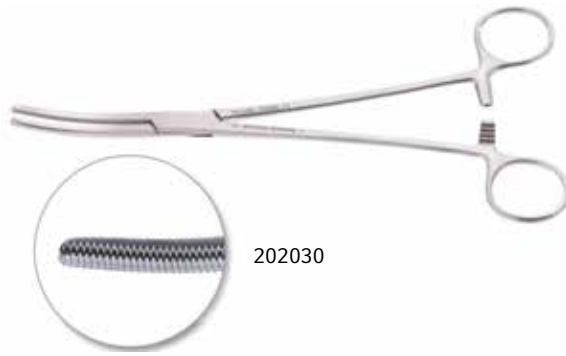

Angiotribe jaws.

CATALOG #	DESCRIPTION
202030	Curved, serrated, 5/8" (16 mm) tip length, 8-7/8" (22.5 cm)

RECTAL

Forceps and Clamps

MCGIVNEY FORCEPS



KM63503

CATALOG #	DESCRIPTION
KM63503	Angled shanks, 7-1/2" (19 cm)

PRATT "T" FORCEPS



477115

Concave, T-shaped jaws, with serrations.

CATALOG #	DESCRIPTION
477115	6" (15 cm)

RECTAL BIOPSY FORCEPS



203142

CATALOG #	DESCRIPTION
203142	Oval, basket punch type, 13.5 x 4 mm jaw, 14-1/2" (37 cm)

0 in

1

2

3

4

5

6

7

8

9



RECTAL

Forceps and Clamps

ROTATING RECTAL BIOPSY FORCEPS



204004

Positive, universal handle. Curved upper jaw and serrated lower jaw give firm grasp and clean cut of tissue. Stems are rotatable full 360 degrees. Stainless steel.

CATALOG #	DESCRIPTION
204004	10" (25.5 cm) stem only, straight jaw
204016	13-7/8" (35 cm) stem only, angular jaw
204018	Handle only



204016



204018

RECTAL

Retractors and Specula

HILL FERGUSON RECTAL RETRACTORS



730296

CATALOG #	DESCRIPTION
730295	Blade 2-3/8" x 1" (6 x 2.5 cm), 8-1/2" (21.5 cm)
730296	Blade 2-3/4" x 1-1/8" (7 x 3 cm), 9-1/2" (24 cm)

SAWYER RECTAL RETRACTORS



202151

CATALOG #	DESCRIPTION
202150	Small, blades 2-1/2" x 7/8" (6.5 x 2 cm), 10-5/8" (27 cm)
202151	Medium, blades 3" x 1-1/8" (7.5 x 3 cm), 11" (28 cm)

SMITH RECTAL RETRACTOR



202140

CATALOG #	DESCRIPTION
202140	Blade 2-13/16" (7 cm), 8-7/8" (22.5 cm) spread

0 in

1

2

3

4

5

6

7

8

9



RECTAL

Retractors and Specula

BODENHAMMER RECTAL SPECULUM



KM63300

CATALOG #	DESCRIPTION
KM63300	Set screw, solid blades, 6" (15 cm)

BRINKERHOFF RECTAL SPECULA



KM63354

CATALOG #	DESCRIPTION
KM63350	Small
KM63352	Medium
KM63354	Large



RECTAL

Retractors and Specula

FANSLER OPERATING SPECULUM



202105

CATALOG #	DESCRIPTION
202105	Slotted tube 2-3/8" (6 cm) long, 1-1/4" (3 cm)

FANSLER-IVES RECTAL SPECULA



KM63319

CATALOG #	DESCRIPTION
KM63318	Chrome speculum with obturator
KM63319	Rubber obturator only



RECTAL

Retractors and Specula

PRATT RECTAL SPECULA



202060

CATALOG #	DESCRIPTION
202060	Large, blades 3-3/8" (8.5 cm) long, 1" (2.5 cm) diameter
202062	Small, blades 3-1/2" (9 cm) long, 3/4" (2 cm) diameter

SIMS RECTAL SPECULUM



202067

CATALOG #	DESCRIPTION
202067	Fenestrated blades 3-1/2" (9 cm) long, 3/4" (2 cm) diameter



RECTAL

Retractors and Specula

HIRSCHMAN ANOSCOPES



202095

CATALOG #	DESCRIPTION
202095	Small, 5/8" (16 mm) tip diameter, 2-1/2" (6.5 cm)
202096	Medium, 3/4" (19 mm) tip diameter, 2-3/4" (7 cm)
202097	Large, 7/8" (22 mm) tip diameter, 2-3/4" (7 cm)

Miscellaneous

BARR CRYPT HOOK



202623

CATALOG #	DESCRIPTION
202623	Double-ended, 10-1/8" (25.5 cm)

MARTIN RECTAL HOOK

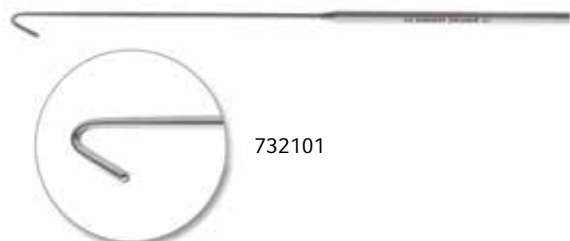

732101

CATALOG #	DESCRIPTION
732101	Hook 9 x 2 mm, 7" (18 cm)



RECTAL

Miscellaneous

PRATT CRYPT HOOK

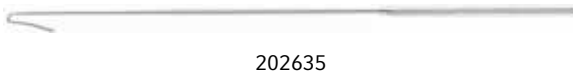

CATALOG #	DESCRIPTION
202635	Small hook, 8-7/8" (22.5 cm)

STEWART RECTAL HOOK

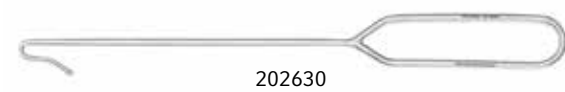

CATALOG #	DESCRIPTION
202630	7/8" (22 mm) hook, 8-7/8" (22.5 cm)

BUIE SUCTION TUBES

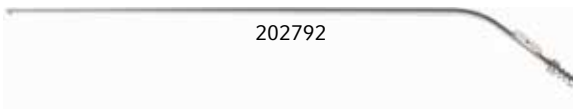

Distal and side openings.

CATALOG #	DESCRIPTION
202792	Thumb valve control model, 15 Fr. diameter, 17" (43 cm)

LARRY PROBE AND GROOVE DIRECTOR

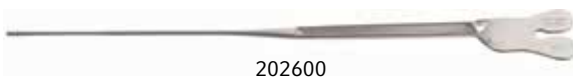

CATALOG #	DESCRIPTION
202600	5-7/8" (15 cm)

MISCELLANEOUS GENERAL

Probes, Cannulae and Dilators

WILLIAMS LACRIMAL PROBES



166490

5-1/8" (13 cm).

CATALOG #	DESCRIPTION
166480	Size 1-2
166485	Size 3-4
166490	Size 5-6
166495	Size 7-8

BOWMAN LACRIMAL PROBES



426096

Sterling silver, 4-7/8" (12.5 cm).

CATALOG #	DESCRIPTION
426090	Size 0000-000
426092	Size 00-0
426094	Size 1-2
426096	Size 3-4
426098	Size 5-6
427002	Size 7-8

DOUBLE-ENDED PROBES



166573

Stainless steel.

CATALOG #	DESCRIPTION
166571	5-1/8" (13 cm)
166573	6-1/8" (15.5 cm)

GROOVED DIRECTOR AND TONGUE TIES



166611

Plain end, stainless steel.

CATALOG #	DESCRIPTION
166610	4-1/2" (11.5 cm)
166611	5-1/8" (13 cm)
166612	5-3/4" (14.5 cm)
166613	6-1/4" (16 cm)

GROOVED DIRECTORS



166632

Probe point, stainless steel.

CATALOG #	DESCRIPTION
166632	5-1/2" (14 cm)
166633	6-1/4" (16 cm)

MISCELLANEOUS GENERAL

Probes, Cannulae and Dilators

PROBES WITH PROXIMAL EYE

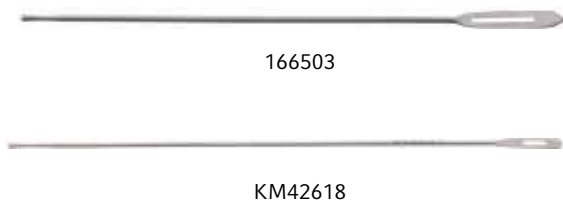

Malleable, stainless steel.

CATALOG #	DESCRIPTION
166500	4-1/2" (11.5 cm)
166501	5-1/8" (13 cm)
166502	5-3/4" (14.5 cm)
166503	5-7/8" (15 cm)
166504	7-1/8" (18 cm)
166505	7-7/8" (20 cm)
166507	9-7/8" (25 cm)
KM42618	10" (25.5 cm)

PROBES WITH PROXIMAL EYE



Sterling silver.

CATALOG #	DESCRIPTION
166520	4-1/2" (11.5 cm)
166521	5-1/8" (13 cm)
166522	5-3/4" (14.5 cm)
166523	5-7/8" (15 cm)
166527	9-7/8" (25 cm)

PATTERSON TROCAR AND CANNULA



Stainless steel trocar tip with chrome plated handle allows for easy catheter insertion.

CATALOG #	DESCRIPTION
534201	Size 1, for 14 Fr. catheter, 7-3/4" (19.5 cm)
534202	Size 2, for 20 Fr. catheter, 8" (20.5 cm)
534203	Size 3, for 26 Fr. catheter, 8" (20.5 cm)

MISCELLANEOUS GENERAL

Probes, Cannulae and Dilators

BAKES COMMON DUCT DILATORS SET

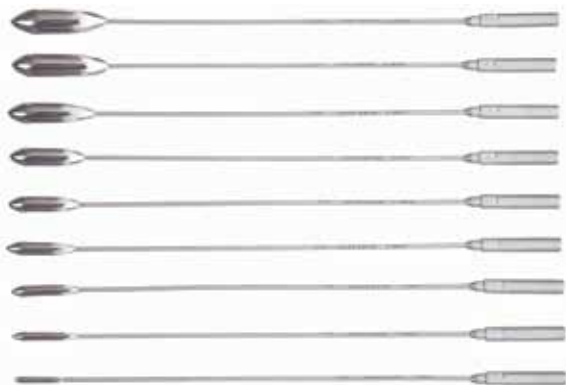

172700

CATALOG #	DESCRIPTION
172700	Malleable stainless steel shafts. 9 tip sizes, 3 to 11 mm. Overall length 8-1/2" (21.5 cm). Set of 9 in plastic case.

Measuring Devices

RULERS



KM39694

Flexible, graduated in inches and millimeters.

CATALOG #	DESCRIPTION
KM39692	6" (15 cm)
KM39694	8" (20.5 cm)
KM39698	12" (30.5 cm)
KM39700	20" (51 cm)

CENTIMETER SUBTRACTION RULER



504075

For accurate calculation, by subtraction, of the depth to which a scope has been inserted.

CATALOG #	DESCRIPTION
504075	30 cm

KUNTSCHER X-RAY SCALE



KM48299

Ruler for X-rays.

CATALOG #	DESCRIPTION
KM48299	Graduated in millimeters, 50 cm length (19-5/8")

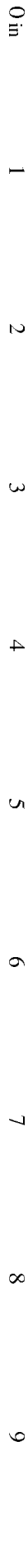

MISCELLANEOUS GENERAL

Measuring Devices

POLK FINGER GONIOMETER



KM48310

Graduated in centimeters and inches.

CATALOG #	DESCRIPTION
KM48310	6" (15 cm)

CASTROVIEJO CALIPERS



KM53042



428630

CATALOG #	DESCRIPTION
KM53042	Graduated to 40 mm, 6-1/2" (16.5 cm)
428630	Straight, 0-20 mm scale, 3-3/8" (8.5 cm)

BONE COMPASS

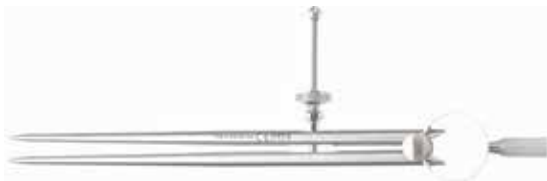

KM48302

CATALOG #	DESCRIPTION
KM48302	8" (20.5 cm)



MISCELLANEOUS GENERAL

Measuring Devices

TOWNLEY FEMUR CALIPER



KM48314

CATALOG #	DESCRIPTION
KM48314	Takes inside and outside measurements up to 4" (10 cm)

FOX CURETTES



KM29498

Round, 5-1/2" (14 cm).

CATALOG #	DESCRIPTION
KM29495	1 mm
KM29496	2 mm
KM29497	3 mm
KM29498	4 mm
KM29499	5 mm
KM29500	6 mm

MISCELLANEOUS GENERAL

Dermal Instruments

GREG COMDONE EXTRACTOR



KM29606

CATALOG #	DESCRIPTION
KM29606	One fenestrated cup and lancet blade with cap, 5" (12.5 cm)

KEYES DERMAL SKIN PUNCHES



KM29513

Straight, sharp ring. 4" (10 cm).

CATALOG #	DESCRIPTION
KM29511	2 mm
KM29512	3 mm
KM29513	4 mm
KM29514	5 mm
KM29515	6 mm
KM29517	7 mm

KMEDIC® COMDONE EXTRACTOR (WALTON)



KM29604

CATALOG #	DESCRIPTION
KM29604	One fenestrated cup and curved lancet with cap

MISCELLANEOUS GENERAL

Dermal Instruments

PIFFARD CURETTES



KM29505

Oval, 5-1/2" (14 cm).

CATALOG #	DESCRIPTION
KM29503	#1 small
KM29505	#2 medium
KM29507	#3 large

SAALFELD COMDONE EXTRACTOR



KM29566

CATALOG #	DESCRIPTION
KM29566	Extra-fine, with lancet and one fenestrated cup, 4-1/2" (11.5 cm)

SCHAMBERG COMDONE EXTRACTORS



KM29582

3-3/4" (9.5 cm).

CATALOG #	DESCRIPTION
KM29580	Standard, crimped loops
KM29582	Extra-fine, crimped loops
KM29584	Square loops

UNNA COMDONE EXTRACTOR



KM29592

CATALOG #	DESCRIPTION
KM29592	Fenestrated spoon ends, 5-3/4" (14.5 cm)

0 in

1

2

3

4

5

6

7

8

9

MISCELLANEOUS GENERAL

Ligature Carriers and Wire Passers

DESCHAMPS LIGATURE CARRIERS



152255

CATALOG #	DESCRIPTION
152255	Blunt point, left curved, 8-1/8" (20.5 cm)
152256	Blunt point, right curved, 8-1/8" (20.5 cm)

BERCI SUTURE PASSER



P47482

CATALOG #	DESCRIPTION
P47482	2.8 mm, 6-3/4" (17 cm)

MICRO CLIPS AND APPLIERS

Temporary Vessel Clips

KLEINERT-KUTZ MICRO VESSEL CLIPS



065105

CATALOG #	DESCRIPTION
065100	Straight blade, 1 x 3 mm, 0.34" (8.5 mm)
065105	Straight blade, 1 x 5 mm, 0.40" (10 mm)

KLEINERT-KUTZ MICRO VESSEL CLIPS



065145

CATALOG #	DESCRIPTION
065125	Angled blade, 1 x 5 mm
065145	Curved blade, 1 x 6 mm

TEMPORARY OCCLUSION CLIPS



065108

CATALOG #	DESCRIPTION
065108	7 x 2 mm blade
065109	12 x 2 mm blade

0 in

1

2

3

4

5

6

7

8

9

MICRO CLIPS AND APPLIERS

Temporary Vessel Clips

MINI WECK® MICRO VESSEL APPROXIMATOR



065166

CATALOG #	DESCRIPTION
065166	5 x 1 mm blades, 7/16" (11 mm) bar

LOUISVILLE MICRO VESSEL APPROXIMATOR WITH CLIPS



065172

With suture staying frame.

CATALOG #	DESCRIPTION
065172	1.5 x 8 mm blades, 1/2" (12.5 mm) bar
065173	1 x 5 mm blades, 7/16" (11 mm) bar

MICRO CLIPS AND APPLIERS

Temporary Vessel Clips

WECK® MICRO VESSEL APPROXIMATORS



065170

CATALOG #	DESCRIPTION
065165	1.5 x 7.5 mm blades, 1/2" (12.5 mm) bar
065170	1.5 x 7.5 mm blades, 3/4" (19 mm) bar

ULNAR RADIAL APPROXIMATOR



065190

CATALOG #	DESCRIPTION
065190	12 x 12 mm blades, 1" (25.5 mm) bar

0 in

1

2

3

4

5

6

7

8

9

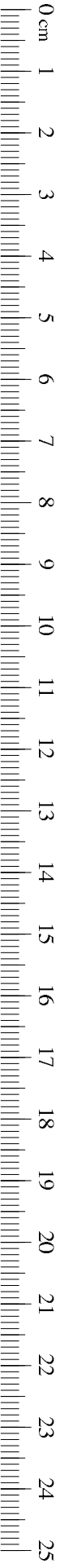

MICRO CLIPS AND APPLIERS

Temporary Vessel Clips

BRACHIAL LARGE VESSEL APPROXIMATORS



065195

CATALOG #	DESCRIPTION
065195	14 mm uniform blades, 1" (25.5 mm) bar
065196	14 mm tapered blades, 1" (25.5 mm) bar

BRACHIAL LARGE VESSEL CLIPS



065110

CATALOG #	DESCRIPTION
065110	24 mm straight blade
065111	24 mm tapered blade

VAN BEEK NERVE APPROXIMATORS



065151

CATALOG #	DESCRIPTION
065151	For median ulna nerves, 15 mm blade, 1" (25.5 mm) bar, 28 Ga. needles
065152	10 mm blade, 5/8" (16 mm) bar

VASOVASOSTOMY APPROXIMATOR



065181

CATALOG #	DESCRIPTION
065181	12 mm blades with serrated 2 mm cups, 3/4" (19 mm) bar

MICRO CLIPS AND APPLIERS

Temporary Vessel Clips

APPROXIMATION CLAMP



KM44030

CATALOG #	DESCRIPTION
KM44030	Without suture holding frame, 1/2" (12.5 mm)

MICRO CLAMP APPLICATOR



KM44028

For Approximation Clamp KM44030.

CATALOG #	DESCRIPTION
KM44028	5-1/2" (14 cm)

KLEINERT-KUTZ MICRO CLIP APPLYING FORCEPS



065155

CATALOG #	DESCRIPTION
065155	2-1/2" (6.5 cm)

RIZZUTI ANGLED MICRO CLIP APPLYING FORCEPS



065175

Applier opens approximator simultaneously or individually.

CATALOG #	DESCRIPTION
065175	5-1/2" (14 cm)

0 in

1

2

3

4

5

6

7

8

9

MICRO CLIPS AND APPLIERS

Temporary Vessel Clips

MICHEL SKIN CLIPS



151228

CATALOG #	DESCRIPTION
151228	18 mm, nickel silver, package of 100

MICHEL CLIP APPLYING FORCEPS



KM42254

CATALOG #	DESCRIPTION
KM42254	5" (12.5 cm)

RICHTER HEATH CLIP FORCEPS

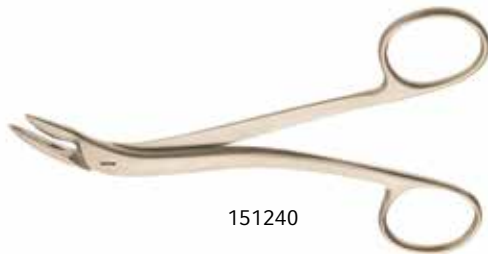

151240

Removing forceps.

CATALOG #	DESCRIPTION
151240	5-1/2" (14 cm)

MICHEL CLIP FORCEPS



151210

Applying and removing forceps.

CATALOG #	DESCRIPTION
151210	4-3/4" (12 cm)



MICRO CLIPS AND APPLIERS

Temporary Vessel Clips

WACHENFELDT CLIP APPLYING AND REMOVING FORCEPS



KM42256

CATALOG #	DESCRIPTION
KM42256	5" (12.5 cm)
KM42258	Cross-action, 5" (12.5 cm)



KM42258

MICRO CLIP TRAY



065199

CATALOG #	DESCRIPTION
065199	1-3/4" x 2-3/4" x 1/2" (4.5 x 7 x 1.5 cm)

INSTRUMENT ACCESSORIES

Containers and Trays

1 MM FINE PERFORATED CASES



087702

CATALOG #	DESCRIPTION
087702	Micro perforated utility case with sliding micro perforated lid, 3-1/2" x 3-1/2" x 3/4"

ALUMINUM UTILITY CASES



087750

Case includes lid and ultrasoft, silicon mat. Five-year warranty against defects in materials and workmanship.

CATALOG #	DESCRIPTION
087747	4" x 8" x 3/4"
087748	8-1/4" x 12-1/4" x 1"
087749	8" x 14" x 1"
087750	10" x 6" x 1"

INSTRUMENT ACCESSORIES

Containers and Trays

MICRO INSTRUMENT TRAYS



429601

Nylon coated and autoclavable. Stainless steel, with silicone racks. Perforated on top and bottom.

CATALOG #	DESCRIPTION
429594	Color coded blue, 8" x 12-1/2" (20.5 x 31.5 cm)
429601	Color coded beige, 10-1/2" x 15" (26.5 x 38 cm)

DILATOR INSTRUMENT TRAYS



355286



355291

CATALOG #	DESCRIPTION
355286	DeBakey® Dilator Tray for 355285 (pg. 769), tray only, small, 5-3/4" x 9-1/4" x 3/4", holds 12 dilators
355291	DeBakey® Dilator Tray for 355290 (pg. 769), tray only, large, 5-3/4" x 16-3/4" x 3/4", holds 12 dilators

0 in

1

2

3

4

5

6

7

8

9

INSTRUMENT ACCESSORIES

Containers and Trays

POLYSULFONE TRAYS



508002



508004

Polysulfone with lid. With silicone finger mat.

CATALOG #	DESCRIPTION
508002	9-1/2 x 5-1/2 x 2-1/2" (24 x 14 x 6.5 cm)
508004	9 x 13 x 3-1/4" (23 x 33 x 8 cm)
521185	11 x 7 x 2" (28 x 18 x 5 cm)
521186	10 x 8-1/2 x 2-3/4" (25.5 x 22 x 7 cm)
521187	17 x 7-1/2 x 2-1/4" (43.5 x 19 x 6 cm)



521185

FLASH TRAYS



806024

CATALOG #	DESCRIPTION
806024	10" x 6-1/2" x 2-1/2" (25.5 x 16.5 x 6.5 cm)
806098	9" x 5" x 2" (23 x 12.5 x 5 cm)

SAFETY HANDLE



806026

Use with Flash Trays, 806024 and 806098.

CATALOG #	DESCRIPTION
806026	10-1/8" (25.5 cm)

INSTRUMENT ACCESSORIES

Containers and Trays

TRAYS



850360

Trays with handles and perforated bottoms.

CATALOG #	DESCRIPTION
850350	10-3/8" x 10" x 3" (26.3 x 25.4 x 7.6 cm)
850355	10-3/8" x 15" x 3" (26.3 x 38.1 x 7.6 cm)
850360	10-3/8" x 20" x 3" (26.3 x 50.8 x 7.6 cm)
101050	10" x 6-1/2" x 2-1/2" (25.5 x 16.5 x 6.5 cm), mesh bottom
101054	13" x 20-1/4" x 3-1/2" (33 x 51.5 x 9 cm), mesh bottom
101061	9-1/4" x 6-1/2" x 3/4" (23.5 x 16.5 x 2 cm), perforated bottom

REPLACEMENT TRAY HANDLE



850345

CATALOG #	DESCRIPTION
850345	Replacement handle for use with Weck® Special Trays (850325, 850330, 850340)

MULTIPURPOSE STAINLESS STEEL TRAYS



806040

Removable locking lid stores easily under tray during use.

CATALOG #	DESCRIPTION
806034	Stainless steel tray with lid, 3-1/4" x 7" x 1-3/4" (8.5 x 18 x 4.5 cm)
806040	Stainless steel tray with lid, 6" x 30" x 3-1/2"
806048	Stainless steel tray with lid, 15" x 10-1/2" x 3-1/2"
806050	Stainless steel tray with lid, 20" x 10-1/2" x 3-1/2"
806052	Stainless steel tray with lid, 20-1/4" x 13" x 3-1/2"

INSTRUMENT ACCESSORIES

Containers and Trays

INSTRUMENT TRAY



101075

This stainless steel tray is designed to accommodate all of the component parts of our Wishbone, Bariatric, Poly-Tract Full Abdominal or Upper Abdominal Retractor Systems, or a set or two of our bougies.

CATALOG #	DESCRIPTION
101075	Includes lid, 32" x 7" x 7" (81 x 18 x 18 cm)

HIGH MAYO PERFORATED TRAYS



806070

CATALOG #	DESCRIPTION
806068	9" x 5" x 1-3/4" (23 x 12.5 x 4.5 cm)
806070	10" x 6-1/2" x 2" (25.5 x 16.5 x 5 cm)
806072	12-3/4" x 10-1/2" x 2-3/4" (31.5 x 26.5 x 7 cm)
806074	12-1/4" x 7-3/4" x 2" (31 x 19.5 x 5 cm)
806076	16-1/2" x 10" x 2-1/2" (42 x 25.5 x 6.5 cm)
806078	20-3/4" x 12-3/4" x 2-1/2" (52.5 x 32.5 x 6.5 cm)

INSTRUMENT TRAYS



960364

CATALOG #	DESCRIPTION
960364	12-1/4" x 7-3/4" x 2" (31 x 19.5 x 5 cm)

MAYO TRAYS



471210

Solid bottom.

CATALOG #	DESCRIPTION
471185	Tray 9" x 5" x 2" (23 x 12.5 x 5 cm)
471210	Tray 15-1/8" x 10-1/2" x 5/8" (38.5 x 26.5 x 1.5 cm)
471175	Tray 16-1/2" x 10" x 2-1/2" (42 x 25.5 x 6.5 cm)
471215	Tray 17-1/8" x 11-5/8" x 5/8" (43.5 x 29.5 x 1.5 cm)

INSTRUMENT ACCESSORIES

Containers and Trays

PERFORATED MAYO TRAYS



806064

Perforated bottom.

CATALOG #	DESCRIPTION
806058	13-3/4" x 9-3/4" x 1/2" (35 x 24.5 x 1 cm)
806060	15" x 10-1/2" x 3/4" (38 x 26.5 x 2 cm)
806062	17" x 11-5/8" x 1/2" (43 x 29.5 x 1 cm)
806064	19" x 12-3/4" x 3/4" (48 x 32.5 x 19 cm)
806066	21-1/4" x 16-1/4" x 3/4" (54 x 41 x 19 cm)

SILICONE MATS



087396

CATALOG #	DESCRIPTION
087403	Ultrasoft spike mat, 11" x 11"
087419	Ultrasoft spike mat, 11" x 16"
087420	Ultrasoft spike mat, 11" x 20-1/4"
087396	Ultrasoft spike mat, 11" x 22"
087405	Ultrasoft spike mat, 13" x 20-1/4"
720000M	For Pilling® Laparoscopic Instrument Tray 720000 (pg. 1149)
720001M	For Pilling® Laparoscopic Instrument Tray 720001 (pg. 1143)

PATE TRAY POSTS

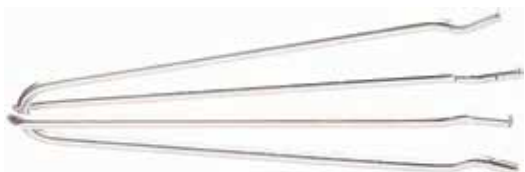

850310

CATALOG #	DESCRIPTION
850310	Special posts to hold instruments in Weck® Special Trays (850325, 850330, 850340), package of a dozen

PILLING® CASE & TRAY SOLUTIONS

Organize, Protect, Store and Deliver Your Surgical Instruments.

QUALITY & DURABILITY

- Embossed feet will not break, fall off, tear, warp or hang up on wire racks
- Tough and resilient silicone brackets with stainless steel channel
- Strong stainless steel latches remain functional for years
- PVC-coated aluminum provides a smoother "satin-like" finish on all anodized metal parts – instead of a heavy grain finish

CUSTOMIZABLE WITH SILICONE BRACKETS AND ACCESSORIES

- Customize trays with available accessories to accommodate various instrument geometries

PROCESSING FUNCTIONALITY

- Maximum holes results in a lighter instrument case
- Maximum sterilant penetration
- Improved drainage

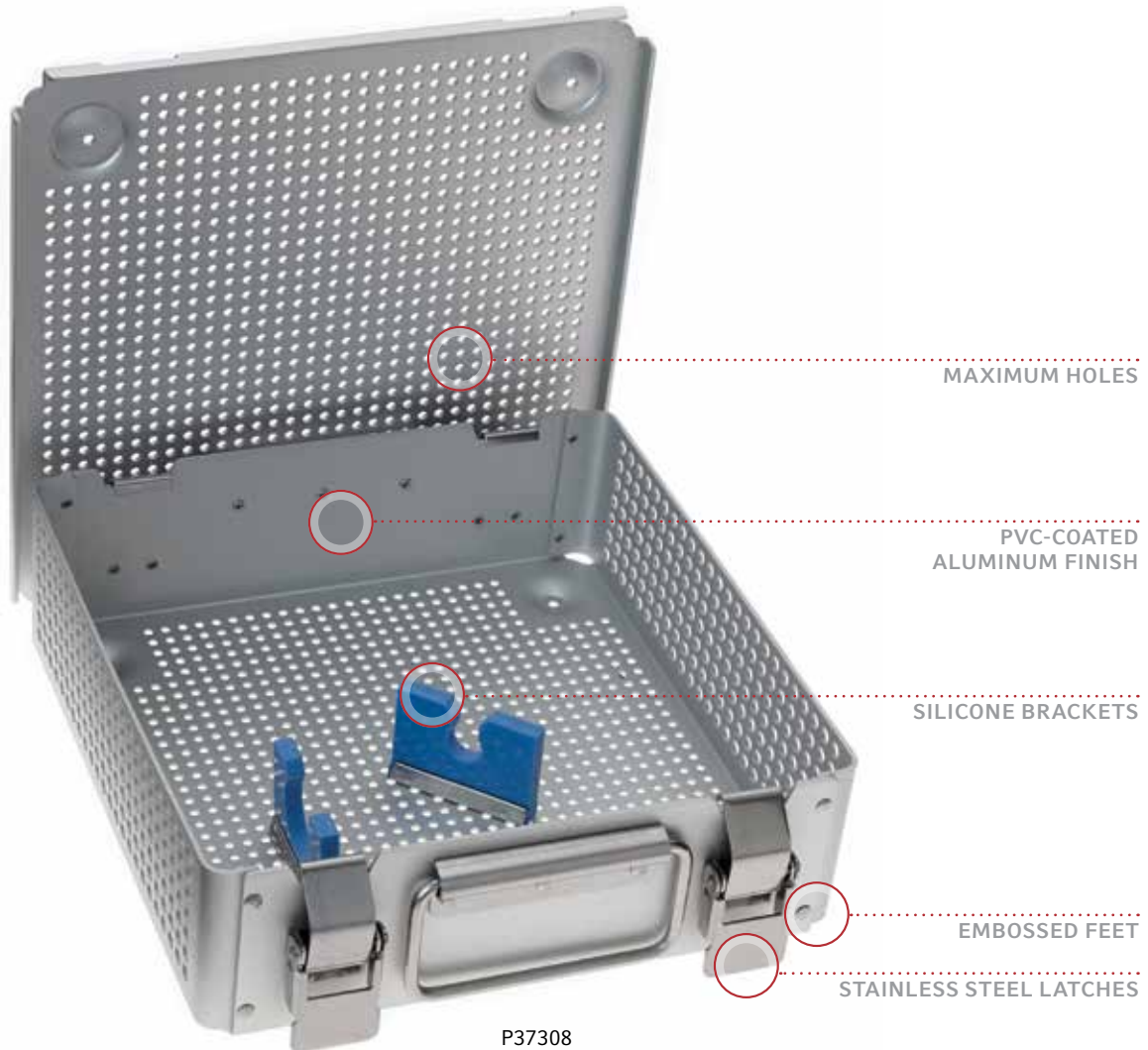

INSTRUMENT ACCESSORIES

Case and Tray Solutions

SCOPE CASE

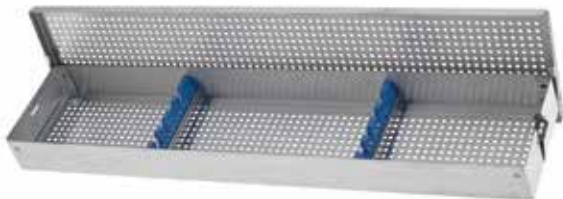

P37314

CATALOG #	DESCRIPTION
P37314	For 2 - 4 scopes, with brackets, ext. size: 4" x 17-1/2" x 1-1/2" (10 x 44.5 x 4 cm) int. size: 3.57" x 17.19" x 1.35" (9 x 43.5 x 3.5 cm)

SCOPE CASE



P37319

CATALOG #	DESCRIPTION
P37319	For up to 5 scopes/instruments, with brackets, ext. size: 6-1/2" x 31" x 3" (16.5 x 78.5 x 7.5 cm) int. size: 6" x 30" x 2.5" (15 x 76 x 6.5 cm)



SCOPE CASES



P37318

CATALOG #	DESCRIPTION
P37310	Without brackets, ext. size: 3" x 11" x 2-1/2" (7.5 x 28 x 6.5 cm) int. size: 2.93" x 10.93" x 2.5" (7.5 x 28 x 6.5 cm)
P37311	Without brackets, ext. size: 3" x 18" x 2-1/2" int. size: 2.93" x 17.93" x 2.46" (7.5 x 45.5 x 6 cm)
P37318	For single bariatric scope, with brackets, ext. size: 3-1/2" x 26" x 3-1/2" (9 x 66 x 9 cm)
P37312	Two levels, with brackets, and camera and light cord compartments, ext. size: 9" x 20" x 4" (23 x 51 x 10 cm) int. size: 8.47" x 18.68" x 3.55" (21.5 x 47.5 x 9 cm)
P37313	Two levels, without brackets or dividers, ext. size: 9" x 20" x 4" (23 x 51 x 10 cm) int. size: 8.47" x 18.68" x 3.55" (21.5 x 47.5 x 9 cm)

INSTRUMENT ACCESSORIES

Case and Tray Solutions

CAMERA AND LIGHT CORD CASES



P37308

CATALOG #	DESCRIPTION
P37308	Camera Case, with brackets, ext. size: 9" x 10" x 3" (23 x 25.5 x 7.5 cm) int. size: 8.47" x 8.68" x 2.55" (21.5 x 22 x 6.5 cm)
P37309	Light Cord Case, ext. size: 9" x 9" x 1-1/2" (23 x 23 x 4 cm) int. size: 8.57" x 8.72" x 1.18" (22 x 22 x 3 cm)

FORCEPS CASES

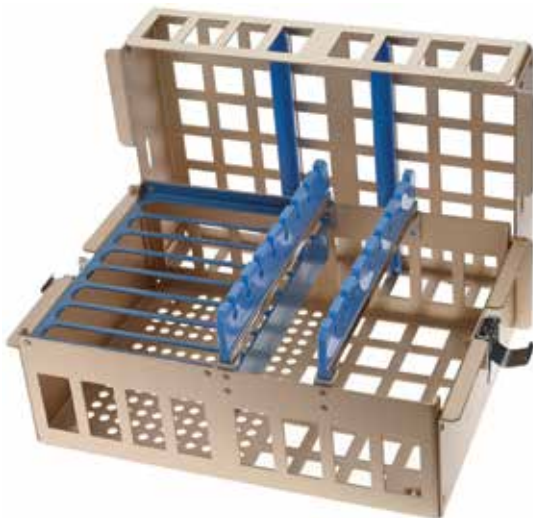

P37327

CATALOG #	DESCRIPTION
P37327	Holds up to 8 rongeurs, designed for size 4 & 5 handles with handle guide, ext. size: 9" x 13" x 6" (23 x 33 x 15 cm) int. size: 8.59" x 12.09" x 5.84" (22 x 30.5 x 15 cm)
P37328	For up to 16 arthroscopic and/or sinus forceps interlacing 8 forceps in each direction, ext. size: 9" x 15" x 5" (23 x 38 x 12.5 cm) int. size: 8.59" x 13.84" x 4.84" (22 x 35 x 12.5 cm)

INSTRUMENT ACCESSORIES

Case and Tray Solutions

TWO-LEVEL LAP CHOLE CASES

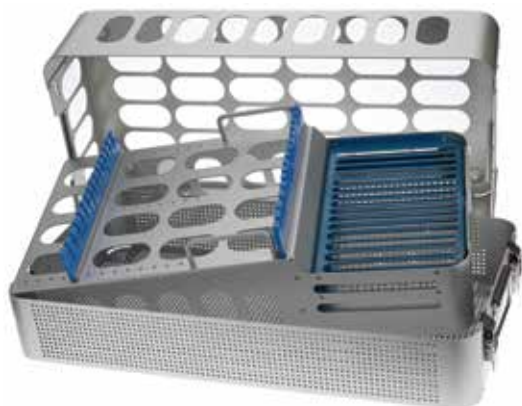

P37316

CATALOG #	DESCRIPTION
P37316	With insert and brackets for up to 13-1/2" (35 cm) instruments, ext. size: 11" x 23" x 8" (28 x 58.5 x 20.5 cm) int. size: 10.7" x 21.62" x 7.66" (27 x 55 x 19.5 cm)
P37317	With insert and brackets for up to 26" (65 cm) instruments, ext. size: 11" x 27" x 8" (28 x 68.5 x 20.5 cm) int. size: 10.7" x 25.62" x 7.66" (27 x 65 x 19.5 cm)

LAP CHOLE INSTRUMENT INSERTS

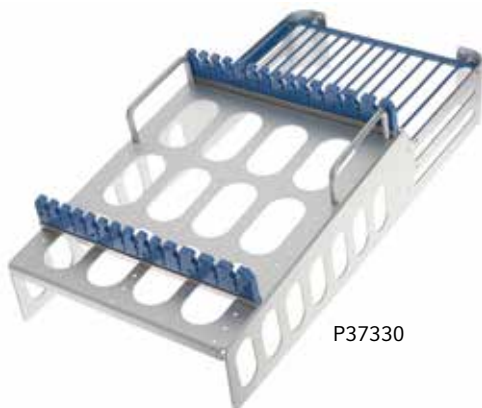

P37330

CATALOG #	DESCRIPTION
P37329	Holds 14 instruments, 8" A-type container ext. size: 9-1/2" x 20" x 5-1/2", fits P37316 and P37317
P37330	Holds 14 instruments ext. size: 9-1/2" x 20" x 5-1/2", fits P37316 and P37317
P37872	Holds 14 instruments ext. size: 9.9" x 19-1/2" x 4.9", fits P37316 and P37317

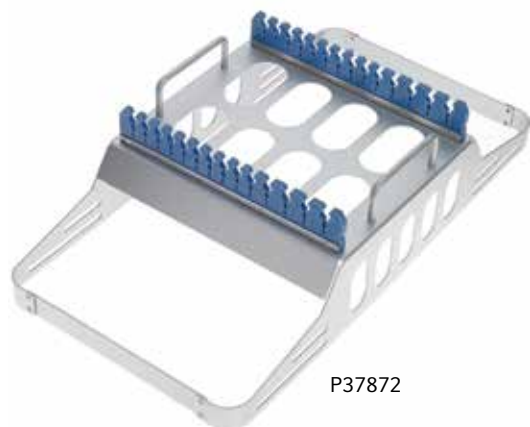

P37872

INSTRUMENT ACCESSORIES

Case and Tray Solutions

MICROSURGICAL CASES



P37320



P37324

CATALOG #	DESCRIPTION
P37321	Single-level, with pin mat, retainers, ext. size: 10-1/2" x 10-1/2" x 1-1/2" (26.5 x 26.5 x 4 cm) int. size: 9.84" x 10.2" x 1.23" (25 x 26 x 3 cm)
P37322	Single-level, with pin mat, retainers, ext. size: 10-1/2" x 15" x 1-1/2" (26.5 x 38 x 4 cm) int. size: 9.84" x 14.68" x 1.23" (25 x 37.5 x 3 cm)
P37320	Two levels, with pin mat, retainers, ext. size: 10-1/2" x 10-1/2" x 2-1/2" (26.5 x 26.5 x 6.5 cm) int. size: 9.84" x 10.2" x 2.32" (25 x 26 x 6 cm)
P37323	Two levels, with pin mat, retainers and long tray/half height accessory area, ext. size: 10-1/2" x 15" x 2-1/2" (26.5 x 38 x 6.5 cm) int. size: 9.84" x 14.6" x 2.32" (25 x 37 x 6 cm)
P37325	Two levels, with pin mat, retainers and long tray/half height accessory area, ext. size: 10-1/2" x 19-1/2" x 2-1/2" (26.5 x 49.5 x 6.5 cm) int. size: 9.84" x 19" x 2.32" (25 x 48.5 x 6 cm)
P37324	Two levels, with pin mat, retainers and short tray/full height accessory area, ext. size: 10-1/2" x 15" x 2-1/2" (26.5 x 38 x 6.5 cm) int. size: 9.84" x 14.6" x 2.32" (25 x 37 x 6 cm)
P37326	Two levels, with pin mat, retainers and short tray/full height accessory area, ext. size: 10" x 19-1/2" x 2-1/2" (25.5 x 49.5 x 6.5 cm) int. size: 9.84" x 19" x 2.32" (25 x 48.5 x 6 cm)

OSTEOTOME CASE



P37335

CATALOG #	DESCRIPTION
P37335	For curved and straight Lambottes, ext. size: 9" x 11-1/2" x 3" (23 x 29 x 7.5 cm) int. size: 8.57" x 11.12" x 2.38" (22 x 28 x 6 cm)

INSTRUMENT ACCESSORIES

Case and Tray Solutions

SURGICAL CASES AND TRAYS

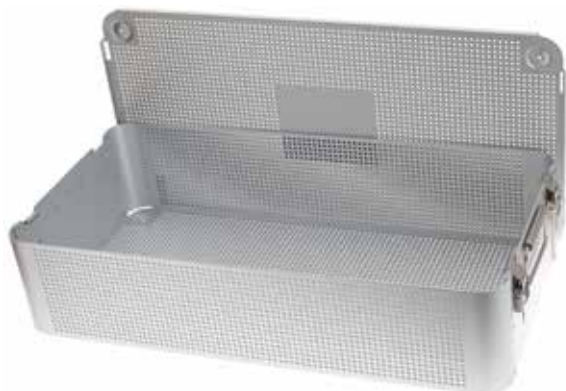

P37332

CATALOG #	DESCRIPTION
P37315	Case without brackets or pin mat, ext. size: 10" x 21-1/2" x 2-1/2" (25.5 x 54.5 x 6.5 cm) int. size: 9.72" x 20.65" x 2.42" (24.5 x 52.5 x 6 cm)
P37331	Case without brackets or pin mat, ext. size: 11" x 23" x 3-1/2" (28 x 58.5 x 9 cm) int. size: 10.7" x 21.62" x 3.41" (27 x 55 x 8.5 cm)
P37304	Case without brackets or pin mat, ext. size: 11" x 27" x 3-1/2" (28 x 68.5 x 9 cm) int. size: 10.88" x 25.62" x 3.41" (27.5 x 65 x 8.5 cm)
P37332	Case without optional trays, support brackets, or pin mat, ext. size: 11" x 23" x 5" (28 x 58.5 x 12.5 cm) int. size: 10.7" x 21.62" x 4.91" (27 x 55 x 12.5 cm)
P37333	Case with optional trays and support brackets, without pin mat, ext. size: 11" x 23" x 5" (28 x 58.5 x 12.5 cm) int. size: 10.7" x 21.62" x 4.91" (27 x 55 x 12.5 cm)
P37334	Case with 2 optional trays and support brackets, without pin mat, ext. size: 11" x 23" x 5" (28 x 58.5 x 12.5 cm) int. size: 10.7" x 21.62" x 4.91" (27 x 55 x 12.5 cm)
P37338	Tray, 10-1/2" x 21-1/2" x 2-1/4" (26.5 x 54.5 x 5.5 cm)
P37419	Tray, 10-1/2" x 21-1/2" x 2" (26.5 x 54.5 x 5 cm)

SURGICAL UTILITY CASES

CATALOG #	DESCRIPTION
P37336	Ext. size: 5" x 10-1/2" x 2" (12.5 x 26.5 x 5 cm) int. size: 4.5" x 10.29" x 1.63" (11.5 x 26 x 4 cm)
P37337	With full pin mat, center lid retainer, ext. size: 5" x 10-1/2" x 2" (12.5 x 26.5 x 5 cm) int. size: 4.5" x 10.29" x 1.53" (11.5 x 26 x 4 cm)



INSTRUMENT ACCESSORIES

Case and Tray Solutions

ACCESSORY BOXES



P37305

CATALOG #	DESCRIPTION
P37305	With hardware, ext. size: 1-1/2" x 3-1/2" x 1" (4 x 9 x 2.5 cm) int. size: 1.44" x 3.16" x 1" (3.5 x 8 x 2.5 cm)
P37593	Without hardware, ext. size: 1-1/2" x 3-1/2" x 1" (4 x 9 x 2.5 cm) int. size: 1.44" x 3.16" x 1" (3.5 x 8 x 2.5 cm)

"L" BRACKETS



P37545

CATALOG #	DESCRIPTION
P37545	"L" brackets to support trays



INSTRUMENT ACCESSORIES

Case and Tray Solutions

SS RISER BRACKET



P37564

CATALOG #	DESCRIPTION
P37564	Used to elevate single wide brackets from the case floor, 0.5" x 1.5"

UNIVERSAL BRACKETS



P37339

CATALOG #	DESCRIPTION
P37358	5" long, 6 position
P37544	7.5" long, 6 position
P37339	7.5" long, 10 position
P37341	9.25" long, 14 position
P37306	10" long, 15 position

SLOTTED "U" BRACKETS



P37344

CATALOG #	DESCRIPTION
P37424	(2 mm) 1.0"
P37346	(3 mm) 1.0"
P37425	(4 mm) 1.0"
P37347	(5 mm) 1.0"
P37426	(6 mm) 1.0"
P37348	(7 mm) 1.0"
P37349	(10 mm) 1.0"
P37350	(12 mm) 1.0"
P37420	(2 mm) 1.5"
P37421	(3 mm) 1.5"
P37342	(4 mm) 1.5"
P37422	(5 mm) 1.5"
P37423	(6 mm) 1.5"
P37343	(7 mm) 1.5"
P37344	(10 mm) 1.5"
P37345	(12 mm) 1.5"

INSTRUMENT ACCESSORIES

Case and Tray Solutions

PASS THRU BRACKETS



P37356

CATALOG #	DESCRIPTION
P37355	(6 mm) 1.0"
P37429	(7 mm) 1.0"
P37430	(9 mm) 1.0"
P37356	(10 mm) 1.0"
P37357	(12 mm) 1.0"
P37487	(13 mm) 1.0"
P37351	(6 mm) 1.5"
P37352	(7 mm) 1.5"
P37427	(9 mm) 1.5"
P37353	(10 mm) 1.5"
P37354	(12 mm) 1.5"
P37428	(13 mm) 1.5"

KEYHOLE BRACKETS



P37377

CATALOG #	DESCRIPTION
P37432	(2 mm) 1.0"
P37433	(3 mm) 1.0"
P37383	(4 mm) 1.0"
P37384	(5 mm) 1.0"
P37486	(6 mm) 1.0"
P37385	(7 mm) 1.0"
P37387	(10 mm) 1.0"
P37388	(12 mm) 1.0"
P37389	(13 mm) 1.0"
P37431	(2 mm) 1.5"
P37372	(3 mm) 1.5"
P37373	(4 mm) 1.5"
P37485	(5 mm) 1.5"
P37374	(6 mm) 1.5"
P37375	(7 mm) 1.5"
P37376	(10 mm) 1.5"
P37377	(12 mm) 1.5"
P37378	(13 mm) 1.5"
P37379	(15 mm) 1.5"
P37380	(19 mm) 1.5"
P37381	(22 mm) 1.5"
P37382	(25 mm) 1.5"
P37390	(3 tier 10/5/3 mm) 1.5"

INSTRUMENT ACCESSORIES

Case and Tray Solutions

V-SILICONE RETAINERS



P37361

CATALOG #	DESCRIPTION
P37361	9.5"
P37435	14.25"
P37436	18.25"

PIN MATS



P37437

CATALOG #	DESCRIPTION
P37437	1" x 4.5"
P37447	1" x 9.63"
P37448	1" x 14.25"
P37449	1" x 18"
P37450	1.5" x 4.5"
P37451	1.5" x 7.13"
P37452	1.5" x 9.12"
P37453	1.5" x 9.63"
P37455	1.5" x 14.25"
P37456	1.5" x 18"
P37457	3.4" x 10.12"
P37391	3.45" x 16.88"
P37454	4.25" x 9.75"
P37392	4.25" x 10.12"
P37401	5" x 10.12"
P37402	5.75" x 10.12"
P37400	6.5" x 10.12"
P37399	6.75" x 10.12"
P37403	6.75" x 17.5"
P37393	8.12" x 8.56"
P37394	8.25" x 18"
P37397	9.5" x 9.5"
P37395	9.63" x 14.13"
P37396	9.63" x 18"
P37398	10.12" x 18"
P37404	13.13" x 18.25"
P37458	Snaps for Pin Mats, 0.187", set of 4

0 in

1

2

3

4

5

6

7

8

9

INSTRUMENT ACCESSORIES

Bowls

EMESIS BASINS



471100

CATALOG #	DESCRIPTION
471100	8-1/8" x 4-3/8" (20.5 cm x 11 cm)
471105	10" x 5-5/8" (25 cm x 14.5 cm)

MEDICINE CUP



471115

CATALOG #	DESCRIPTION
471115	2 oz. (60 mL), 2" diameter x 2" deep (5.1 x 5.1 cm)

IODINE CUP



471120

CATALOG #	DESCRIPTION
471120	Holds 6 oz. (177 mL)

SPONGE BOWLS



471135

CATALOG #	DESCRIPTION
471125	4-3/4" top diameter x 2" deep (12 x 5 cm), total capacity 12 oz. (360 mL)
471130	5" top diameter x 2-1/4" deep (12.5 x 5.7 cm), total capacity 18 oz. (540 mL)
471135	5-3/4" top diameter x 2-1/2" deep (14.5 x 6.5 cm), total capacity 30 oz. (900 mL)
471140	6-3/8" top diameter x 2-3/4" deep (16 x 7 cm), total capacity 46 oz. (1380 mL)



INSTRUMENT ACCESSORIES

Instrument Holders and Stringers

THOMPSON THORACIC INSTRUMENT HOLDER



343395

This instrument table is easily attached to standard operating table and provides convenient space for instruments in use. This could eliminate the separate and less steady floor-mounted Mayo stand. Complete with Rail Clamps (343393).

CATALOG #	DESCRIPTION
343395	

RAIL CLAMPS



343393

CATALOG #	DESCRIPTION
343393	1 pair

INSTRUMENT ACCESSORIES

Instrument Holders and Stringers

INSTRUMENT STRINGERS



087531



087550



087561

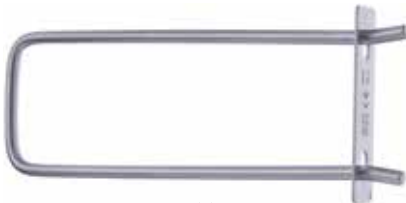

166870

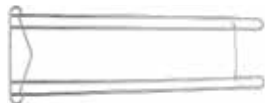

840200



840210



840221

CATALOG #	DESCRIPTION
087531	Posilok single link instrument holder, 8" x 2-3/4"
087532	Posilok single link instrument holder, 10" x 2-3/4"
087533	Posilok single link instrument holder, 12" x 2-3/4"
087550	Instrument stringer, 6"
087552	Instrument stringer, 10"
087559	E-Z lock double lock hinge bar, connects in middle, 8" x 2-3/4"
087561	E-Z lock double lock hinge bar, connects in middle, 12" x 2-3/4"
166868	Lahey instrument holder, 6" (15 cm)
166870	Lahey instrument holder, 8" (20.5 cm)
166872	Lahey instrument holder, 10" (25.5 cm)
166874	Lahey instrument holder, 12" (30.5 cm)
166876	Lahey instrument holder, 14" (35.5 cm)
840200	Worcester instrument holder, 12-5/8" x 4-1/2"
840210	Weinstein instrument holder, 8" x 2-1/2"
840215	Weinstein instrument holder, 10" x 2-1/2"
840221	Instrument holder, 6"
840222	Instrument holder, 12"



INSTRUMENT ACCESSORIES

Instrument Holders and Stringers

INSTRUMENT STRINGER



806122

CATALOG #	DESCRIPTION
806122	2-3/4" x 8" (7 x 20.5 cm)

INSTRUMENT HOLDERS



166851

CATALOG #	DESCRIPTION
166851	Instrument holder with clasp lock, 8" (20.5 cm)
166853	Instrument holder with clasp lock, 10" (25.5 cm)
166855	Instrument holder with clasp lock, 12" (30.5 cm)
166857	Instrument holder with clasp lock, 14" (35.5 cm)
166859	Instrument holder with clasp lock, 16" (40.5 cm)
166861	Instrument holder with clasp lock, 18" (45.5 cm)

BUNT FORCEPS HOLDER



KM39670

CATALOG #	DESCRIPTION
KM39670	

INSTRUMENT ACCESSORIES

Instrument Holders and Stringers

INSTRUMENT RACK



840220

CATALOG #	DESCRIPTION
840220	3" (7.5 cm) posts

WECK®-RACKS



840100

Includes 6, 9 or 12 separator clips, 1 security rod, 1 retainer clip.

CATALOG #	DESCRIPTION
840100	12-1/8" (31 cm)
840105	15-1/8" (38.5 cm)
840110	18-1/8" (46 cm)

WECK®-RACK RETAINER CLIPS

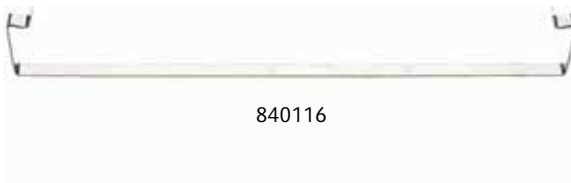

840116

Replacement retainer clip.

CATALOG #	DESCRIPTION
840116	11" (28 cm)
840117	14-3/8" (36.5 cm)
840118	17" (43 cm)

INSTRUMENT ACCESSORIES

Instrument Holders and Stringers

WECK®-RACK SECURITY RODS



840111

Replacement security rod.

CATALOG #	DESCRIPTION
840111	11-3/4" (30 cm)
840112	14-3/4" (37.5 cm)
840113	17-3/4" (45 cm)

WECK®-RACK SEPARATOR CLIPS



840114

Replacement separator clips.

CATALOG #	DESCRIPTION
840114	Package of 6

Cleaners and Lubricants

CANNULA CLEANERS



850500

Clean bronchoscopes, laryngoscopes, laparoscopes and suction tubes.

CATALOG #	DESCRIPTION
850500	1/8", 50 ft. coil
850502	3/16", 50 ft. coil

0 in

1

2

3

4

5

6

7

8

9

INSTRUMENT ACCESSORIES

Cleaners and Lubricants

INSTRUMENT CLEANING BRUSHES



KM39682

CATALOG #	DESCRIPTION
KM39682	Wire, set of 3
KM39684	Nylon, set of 3

SCRUB FILES



910110

For use with scrub brush 910100.

CATALOG #	DESCRIPTION
910110	For use with scrub brush 910100, 1 dozen

WECK® INSTRUMENT CLEANER



850103

Designed to remove protein on surgical instruments and glassware.

CATALOG #	DESCRIPTION
850103	5 lbs.

INSTRUMENT ACCESSORIES

Cleaners and Lubricants

WECK® LIQUID DETERGENT



850110

Concentrate, ideal for ultrasonic cleaners.

CATALOG #	DESCRIPTION
850110	1 gallon

WECK-LUBE™



850150

Concentrate. Inhibits rusting of instruments while lubricating.

CATALOG #	DESCRIPTION
850150	1 gallon

0 in

1

2

3

4

5

6

7

8

9

INSTRUMENT ACCESSORIES

Cleaners and Lubricants

WEC-WASH™



850115

CATALOG #	DESCRIPTION
850115	1/2 gallon

WECK® WIPE

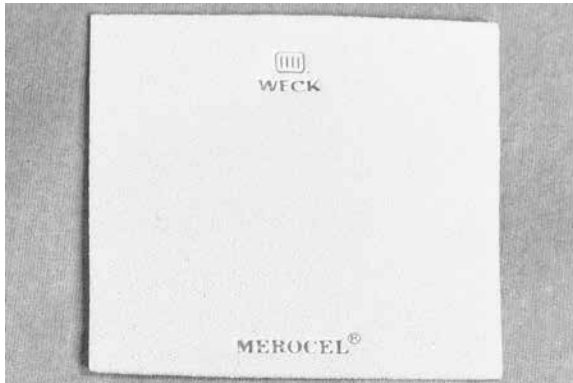

200550

Used to clean instruments in the sterile field.

CATALOG #	DESCRIPTION
200550	3-1/4" x 3-1/4" (8.5 cm x 8.5 cm), X-ray detectable, sterile, 20 per box, 1 per pouch

INSTRUMENT ACCESSORIES

Cleaners and Lubricants

WEC-KLEEN™



850102

Super concentrate instrument cleaner.

CATALOG #	DESCRIPTION
850102	Plastic tub of 2-1/2 lbs.

WEC-KREEM™



850155

Super concentrate instrument lubricant.

CATALOG #	DESCRIPTION
850155	1/2 gallon

0 in

1

2

3

4

5

6

7

8

9

INSTRUMENT ACCESSORIES

Miscellaneous

MAGNETIC INSTRUMENT MATS



151350

Magna-Tronce is a flexible sheet of silicone with permanent magnets embedded in the sheet. The Magna-Tronce Mat is designed to keep delicate surgical instruments firmly and safely in place, even during the most critical operations. Embedded magnets hold surgical instruments in convenient positions, and eliminate most of the dropped instrument problems. The flexible Magna-Tronce Mat may be clamped to drapes on any slanted or uneven surface. Grommets are provided at the corners so that the magnetic sheet may be tied or clamped in any position. Magna-Tronce Mat is capable of being autoclaved. A film of silicone protects embedded magnets.

11-7/8" x 11-7/8" (30 cm x 30 cm)

CATALOG #	DESCRIPTION
151350	Magna-Tronce Mat, single
151351	Magna-Tronce Mat, set of 3

SURG-I-BAND® TAPE



121384

Available in spools 244" x 1/4" (620 x 0.6 cm).

Surg-i-Band® Tape is a registered trademark of Scanlan International, Inc.

CATALOG #	DESCRIPTION
121380	Surg-i-Band® Tape, Black
121381	Surg-i-Band® Tape, Red
121382	Surg-i-Band® Tape, Green
121383	Surg-i-Band® Tape, Yellow
121384	Surg-i-Band® Tape, Blue
121385	Surg-i-Band® Tape, White
121386	Surg-i-Band® Tape, Orange
121387	Surg-i-Band® Tape, Brown
121388	Surg-i-Band® Tape, Purple
121389	Surg-i-Band® Tape, Neon Orange
121390	Surg-i-Band® Tape, Gray
121391	Surg-i-Band® Tape, Lime Green

FLOOR GRADE INSTRUMENTS

Forceps

IN-EX ADSON DRESSING FORCEPS



101149

CATALOG #	DESCRIPTION
101149	Serrated, 4-3/4" (12 cm), 12 per box

IN-EX ADSON TISSUE FORCEPS



101150

CATALOG #	DESCRIPTION
101150	1 x 2 teeth, 4-3/4" (12 cm), 12 per box

IN-EX THUMB FORCEPS



101148

CATALOG #	DESCRIPTION
101147	Serrated, 5-1/2" (14 cm), 12 per box
101148	1 x 2, 5-1/2" (14 cm), 12 per box

0 in

1

2

3

4

5

6

7

8

9



FLOOR GRADE INSTRUMENTS

Forceps

IN-EX BACKHAUS TOWEL CLAMPS

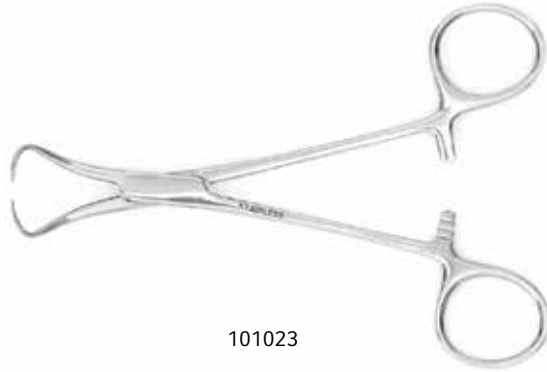

101023

CATALOG #	DESCRIPTION
101022	3-1/2" (9 cm), 12 per box
101023	5-1/4" (13.5 cm), 12 per box

IN-EX EDNA TOWEL CLAMP



101028

CATALOG #	DESCRIPTION
101028	5-3/8" (13.5 cm), 12 per box

IN-EX HOFF TOWEL CLAMP



101024

CATALOG #	DESCRIPTION
101024	Non-perforating, 5-3/4" (14.5 cm), 12 per box

FLOOR GRADE INSTRUMENTS

Forceps

IN-EX SPONGE FORCEPS



CATALOG #	DESCRIPTION
101152	Ballenger, serrated, 7-1/4" (18.5 cm), 12 per box
101151	Foerster, serrated, 9-3/4" (25 cm), 12 per box

IN-EX HALSTED MOSQUITO FORCEPS



CATALOG #	DESCRIPTION
101010	Straight, 5" (12.5 cm), 12 per box
101011	Curved, 5" (12.5 cm), 12 per box

IN-EX CRILE FORCEPS



CATALOG #	DESCRIPTION
101016	Straight, 5-1/2" (14 cm), 12 per box
101017	Curved, 5-1/2" (14 cm), 12 per box

0 in

1

2

3

4

5

6

7

8

9

FLOOR GRADE INSTRUMENTS

Forceps

IN-EX KELLY FORCEPS



CATALOG #	DESCRIPTION
101012	Straight, 5-1/2" (14 cm), 12 per box
101013	Curved, 5-1/2" (14 cm), 12 per box

IN-EX ROCHESTER-PEAN FORCEPS



CATALOG #	DESCRIPTION
101014	Straight, 6-1/2" (16.5 cm), 12 per box
101015	Curved, 6-1/2" (16.5 cm), 12 per box

IN-EX ALLIS TISSUE FORCEPS

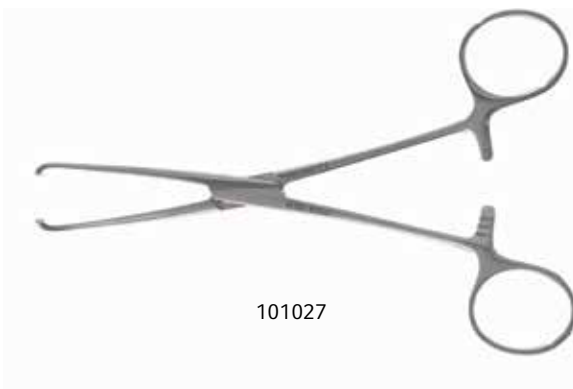

CATALOG #	DESCRIPTION
101027	4 x 5 teeth, 6-1/4" (16 cm), 12 per box

FLOOR GRADE INSTRUMENTS

Forceps

IN-EX BOZEMAN UTERINE DRESSING FORCEPS



101033

CATALOG #	DESCRIPTION
101033	Straight, 10" (25.5 cm)
101034	Curved, 10-3/8" (26.5 cm)

Needle Holders

IN-EX BAUMGARTNER NEEDLE HOLDER

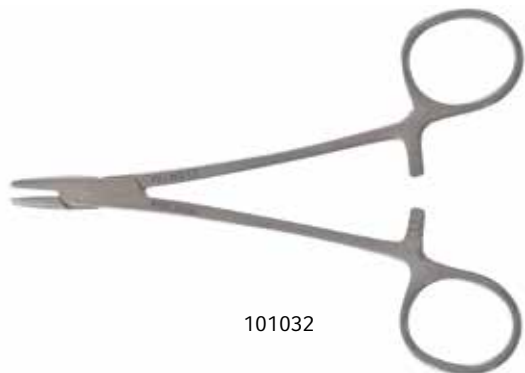

101032

CATALOG #	DESCRIPTION
101032	12.5 x 2.7 mm jaw, 5-1/2" (14 cm), 12 per box

IN-EX WEBSTER NEEDLE HOLDER



101031

CATALOG #	DESCRIPTION
101031	15.5 x 1.7 mm smooth jaw, 5" (12.5 cm), 12 per box

0 in

1

2

3

4

5

6

7

8

9

FLOOR GRADE INSTRUMENTS

Needle Holders

IN-EX MAYO HEGAR NEEDLE HOLDERS

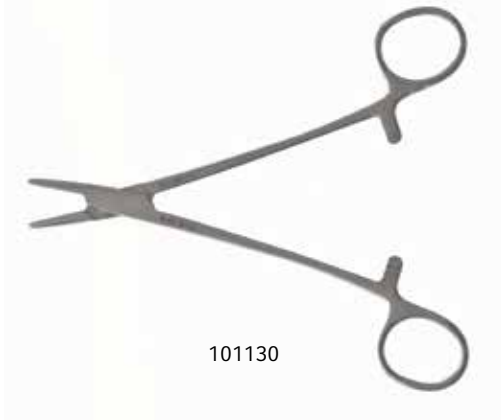

CATALOG #	DESCRIPTION
101130	20 x 2.8 mm jaw, 6-1/2" (16.5 cm), 12 per box
101131	24 x 3 mm jaw, 8" (20.5 cm), 12 per box

Scissors

IN-EX LISTER BANDAGE SCISSORS



CATALOG #	DESCRIPTION
101142	5-3/4" (14.5 cm), 12 per box
101143	7-1/4" (18.5 cm), 12 per box

IN-EX LITTAUER SUTURE SCISSORS



CATALOG #	DESCRIPTION
101146	5-1/2" (14 cm), 12 per box

FLOOR GRADE INSTRUMENTS

Scissors

IN-EX WIRE SCISSORS



101039

CATALOG #	DESCRIPTION
101039	4-3/4" (12 cm), 12 per box

IN-EX IRIS SCISSORS



101145

Sharp/Sharp.

CATALOG #	DESCRIPTION
101144	Straight, 4-1/2" (11.5 cm), 12 per box
101145	Curved, 4-1/2" (11.5 cm), 12 per box

IN-EX OPERATING SCISSORS

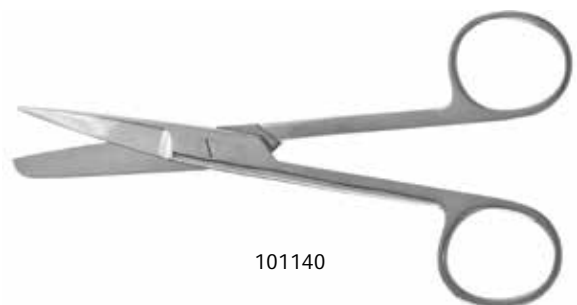

101140

CATALOG #	DESCRIPTION
101140	Straight, Sharp/Blunt, 5-1/2" (14 cm), 12 per box
101141	Straight, Sharp/Sharp, 5-1/2" (14 cm), 12 per box

0 in

1

2

3

4

5

6

7

8

9

FLOOR GRADE INSTRUMENTS

Scissors

IN-EX MAYO SCISSORS

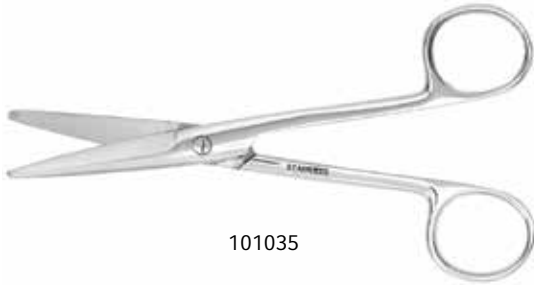

101035



101036



101038

CATALOG #	DESCRIPTION
101035	Straight, 5-1/2" (14 cm), 12 per box
101036	Curved, 5-1/2" (14 cm), 12 per box
101037	Straight, 6-3/4" (17 cm), 12 per box
101038	Curved, 6-3/4" (17 cm), 12 per box

SPECIALTY SPONGES

Specialty Sponges

CYLINDRICAL SPONGES

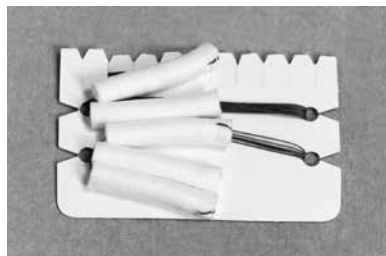

200400



200401

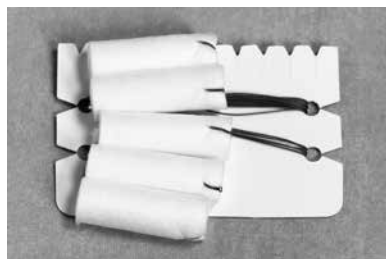

200402

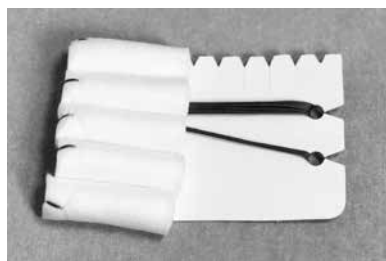

200403

Cylindrical sponges are used during tonsil, adenoid and nasal surgical procedures for packing and applying medication following surgery and for control of hemorrhaging or drainage.

CATALOG #	DESCRIPTION
200400	3/8" x 1-1/2" (9.53 x 38.1 mm) Non-X-ray detectable Sterile, end strung, cotton roll 100 per box, 5 per accountability card
200401	3/8" x 1-1/2" (9.53 x 38.1 mm) Non-X-ray detectable Sterile, center strung, cotton roll 100 per box, 5 per accountability card
200402	1/2" x 1-1/2" (12.7 mm x 38.1 mm) Non-X-ray detectable Sterile, end strung, cotton roll 100 per box, 5 per accountability card
200403	1/2" x 1-1/2" (12.7 x 38.1 mm) Non-X-ray detectable Sterile, center strung, cotton roll 100 per box, 5 per accountability card

0 in

1

2

3

4

5

6

7

8

9

SPECIALTY SPONGES

Specialty Sponges

GAUZE FLAT SPONGES

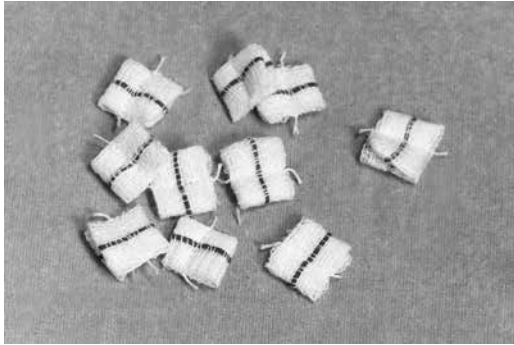

200220

Some flat gauze sponges are used for dissection and absorption, some for absorption only. Those larger sponges used for absorption can be used with sponge forceps.

CATALOG #	DESCRIPTION
200220	"Dissectors" 1/2" x 1/2" (12.7 x 12.7 mm) X-ray detectable Sterile, non-strung, cotton gauze 200 per box, 10 per package
200240	Bronchoscopic 1/4" x 3/4" (6.35 x 19 mm) X-ray detectable Sterile, non-strung, cotton 200 per box, 10 per safety pin
200250	2" x 2" (50.8 x 50.8 mm) X-ray detectable Sterile, strung, gauze 200 per box, 10 per accountability card



200240

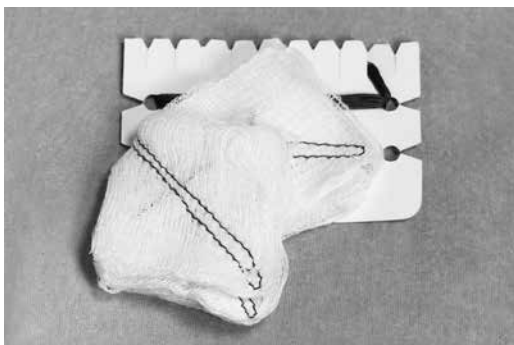

200250

SPECIALTY SPONGES

Specialty Sponges

"K" DISSECTOR SPONGES



200200



200202



200203



200211

"K" Dissector sponges, named for Dr. Kittner, are held in the jaws of a clamp at the ends or sides of the "can" construction, to provide a stable, soft tip for dissection and absorption during delicate surgical procedures. They have a slightly tighter structure than a peanut sponge. Pilling® Dissector Sponges have a tightly woven chevron mesh for finer dissection, and feature an X-ray thread wound concentrically in layers for X-ray visibility in any direction.

CATALOG #	DESCRIPTION
200200	1/4" x 9/16" (6.35 x 14.29 mm) X-ray detectable Sterile, non-strung, cotton gauze 200 per box, 5 per tray
200201	1/4" x 9/16" (6.35 x 14.29 mm) X-ray detectable Sterile, non-strung, cotton gauze 200 per box, 10 per tray
200202	1/4" x 9/16" (6.35 x 14.29 mm) X-ray detectable Sterile, non-strung, cotton gauze 200 per box, 5 per plastic holder
200203	1/4" x 9/16" (6.35 x 14.29 mm) X-ray detectable Sterile, non-strung, cotton gauze 200 per box, 5 per foam holder
200211	1/8" x 9/16" (3.18 x 14.29 mm) X-ray detectable Non-sterile, non-strung, cotton gauze 500 per box, 100 per bag
200212	1/8" x 9/16" (3.18 x 14.29 mm) X-ray detectable Sterile, cotton gauze Box of 40 packages, 5 per package

0 in

1

2

3

4

5

6

7

8

9

SPECIALTY SPONGES

Specialty Sponges

LAMINECTOMY WEDGE SPONGES

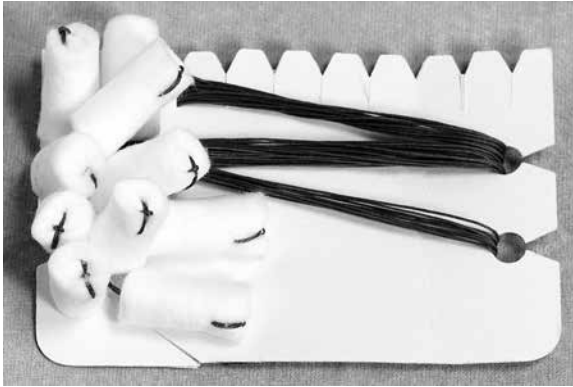

200161

Laminectomy sponges are a type of neuro sponge used on soft tissue in laminectomies.

CATALOG #	DESCRIPTION
200161	3/4" x 3/8" (19 x 9.53 mm) Non-X-ray detectable Sterile, double-strung, cotton 200 per box, 10 per accountability card

NEURO SPONGES

Neuro sponges are used during cranial and spine surgery to moisten the dura or to cushion against bone edges. They are also used to protect brain tissue under the dura or elsewhere during incision. Gardlok neuro sponges are made from the highest quality non-woven cotton, which is soft, conformable, as free of lint as possible and highly retentive in comparison to other rayon "cottonoid" brands. For security, the X-ray detectable element is heat sealed and stitched into the sponge, and the sponges are double strung.



200100



200101



200102

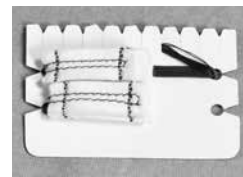

200103

CATALOG #	DESCRIPTION
200100	Patties 1/2" x 1/2" (12.7 mm x 12.7 mm) X-ray detectable Sterile, double-strung, cotton 200 per box, 10 per accountability card
200101	Patties 1" x 1" (25.4 mm x 25.4 mm) X-ray detectable Sterile, double-strung, cotton 200 per box, 10 per accountability card
200102	Patties 1" x 3" (25.4 mm x 76.2 mm) X-ray detectable Sterile, double-strung, cotton 200 per box, 10 per accountability card
200103	Patties 1/2" x 1-1/2" (12.7 mm x 38.1 mm) X-ray detectable Sterile, double-strung, cotton 200 per box, 10 per accountability card

SPECIALTY SPONGES

Specialty Sponges

NEURO SPONGES (CONTINUED)

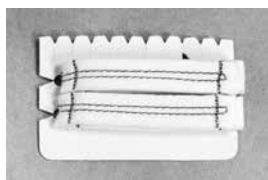

200104



200105

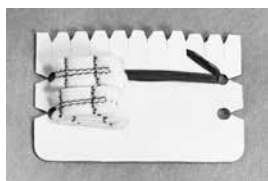

200106



200108



200110



200112

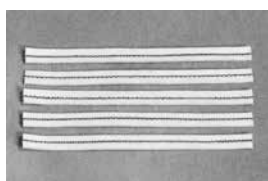

200120

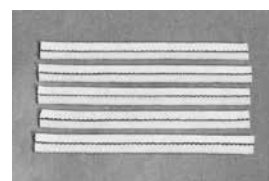

200121

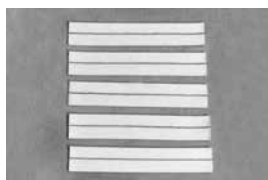

200123

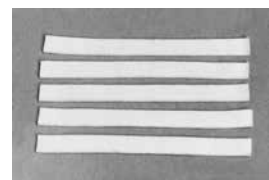

200131

CATALOG #	DESCRIPTION
200104	Patties 1/2" x 3" (12.7 mm x 76.2 mm) X-ray detectable Sterile, double-strung, cotton 200 per box, 10 per accountability card
200105	Patties 3/4" x 3/4" (19.5 mm x 19.5 mm) X-ray detectable Sterile, double-strung, cotton 200 per box, 10 per accountability card
200106	Patties 1/2" x 1" (12.7 mm x 25.4 mm) X-ray detectable Sterile, double-strung, cotton 200 per box, 10 per accountability card
200108	Patties 3" x 3" (76.2 mm x 76.2 mm) X-ray detectable Sterile, double-strung, cotton 200 per box, 10 per accountability card
200110	Patties 1/2" x 1/2" (12.7 mm x 12.7 mm) Non-X-ray detectable Sterile, double-strung, cotton 200 per box, 10 per accountability card
200112	Patties 1/2" x 3" (12.7 mm x 76.2 mm) Non-X-ray detectable Sterile, double-strung, cotton 200 per box, 10 per accountability card
200120	Strips 3/8" x 6" (9.53 mm x 152.4 mm) X-ray detectable Sterile, non-strung, cotton 100 per box, 10 per pouch
200121	Strips 1/2" x 6" (12.7 mm x 152.4 mm) X-ray detectable Sterile, non-strung, cotton 100 per box, 10 per pouch
200123	Strips 1" x 6" (25.4 mm x 152.4 mm) Non-X-ray detectable Sterile, non-strung, cotton 100 per box, 10 per pouch
200131	Strips 1/2" x 6" (12.7 mm x 152.4 mm) Non-X-ray detectable Sterile, non-strung, cotton 100 per box, 10 per pouch

0 in

1

2

3

4

5

6

7

8

9

SPECIALTY SPONGES

Specialty Sponges

PEANUT SPONGES



200214



200215



200217

Peanut sponges, held at the end of a hemostat during delicate surgical procedures, facilitate tissue separation around vessels, or identify bleeders, with less chance of damage to those structures. Pilling® Surgical's Gardlok Peanut Sponges are made of USA cotton and feature a large gauze strand for better abrading in blunt dissection.

CATALOG #	DESCRIPTION
200214	3/8" (9.53 mm) X-ray detectable Sterile, non-strung, cotton gauze 200 per box, 5 per safety pin
200215	3/8" (9.53 mm) X-ray detectable Sterile, non-strung, cotton gauze 200 per box, 5 per plastic holder
200217	3/8" (9.53 mm) X-ray detectable Sterile, non-strung, cotton gauze 200 per box, 5 per foam holder



SPECIALTY SPONGES

Specialty Sponges

ROSEBUD/CHERRY SPONGES

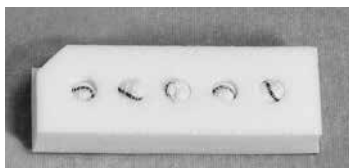

200218



200230



200231



200232

Smaller versions of peanut sponges, rosebud sponges are used for dissection and absorption where precise dissection is necessary during delicate surgical procedures such as thyroidectomies, colostomy closures, hepatic resections, laryngectomies and abdominal aortic and other vascular procedures. Cherries are very tightly spun spherical sponges used for very gentle dissection and absorption during delicate surgical procedures. A center hole is incorporated to facilitate grip in a toothed forceps. Gardlok cherry sponges feature an X-ray detectable chip, rather than a tiny monofilament section, in the center of the sponge for enhanced visibility. Cherry sponge construction does not allow for the long monofilament incorporated in other Gardlok dissectors.

CATALOG #	DESCRIPTION
200218	Rosebud 1/4" (6.35 mm) X-ray detectable Sterile, non-strung, cotton gauze 200 per box, 5 per foam holder
200230	Rosebud 1/4" (6.35 mm) X-ray detectable Sterile, non-strung, cotton gauze 200 per box, 10 per tray
200231	Rosebud 1/2" (12.7 mm) X-ray detectable Sterile, non-strung, cotton-gauze 200 per box, 10 per tray
200232	Rosebud 1/4" (6.35 mm) X-ray detectable Sterile, non-strung, cotton gauze 200 per box, 5 per plastic holder

SPECIALTY SPONGES

Specialty Sponges

ROSEBUD/CHERRY SPONGES (CONTINUED)

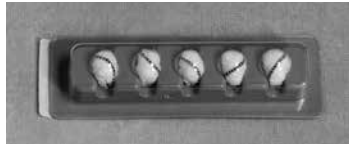

200233

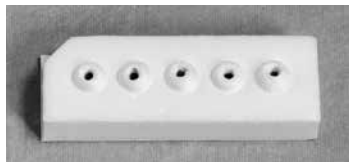

200234



200235



200236

CATALOG #	DESCRIPTION
200233	Rosebud 1/2" (12.7 mm) X-ray detectable Sterile, non-strung, cotton gauze 200 per box, 5 per plastic holder
200234	Cherry 3/8" (9.53 mm) X-ray detectable Sterile, non-strung, spun cotton 200 per box, 5 per foam holder
200235	Rosebud 1/4" (6.35 mm) X-ray detectable Sterile, strung, cotton gauze 200 per box, 10 per accountability card
200236	Rosebud 1/2" (12.7 mm) X-ray detectable Sterile, strung, cotton gauze 200 per box, 10 per accountability card

SPECIALTY SPONGES

Specialty Sponges

TONSIL SPONGES

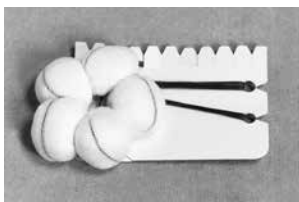

200322

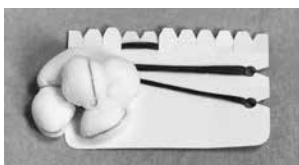

200326

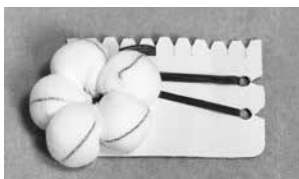

200327

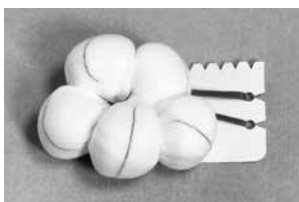

200328

Tonsil sponges are used at the end of a forceps for absorption and pressure hemostatic control during tonsil and adenoid surgery. They can also be drawn into position and tied to a catheter for use after nasal surgical procedures for postnasal or sphenoid packing, applying medication following surgery, and for control of hemorrhaging or drainage. Pilling® Surgical Tonsil Sponges feature double stringing for secure retrieval after use, and are available in a wide variety of choices including gauze, cotton or gauze cotton-filled in three sizes. Other choices include strung or non-strung, X-ray and non-X-ray detectable, sterile and non-sterile.

CATALOG #	DESCRIPTION
200322	Large X-ray detectable Non-sterile, double-strung, cotton-filled, gauze-covered 1000 per box, 5 per accountability card
200326	Medium X-ray detectable Sterile, double-strung, cotton-filled, gauze-covered 500 per box, 5 per accountability card
200327	Large X-ray detectable Sterile, double-strung, cotton-filled, gauze-covered 500 per box, 5 per accountability card
200328	X-Large X-ray detectable Sterile, double-strung, cotton-filled, gauze-covered 500 per box, 5 per accountability card

0 in

1

2

3

4

5

6

7

8

9

SPECIALTY SPONGES

Specialty Sponges

TONSIL SPONGES (CONTINUED)

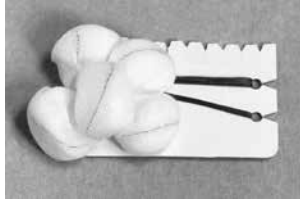

200333

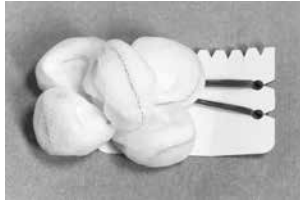

200334

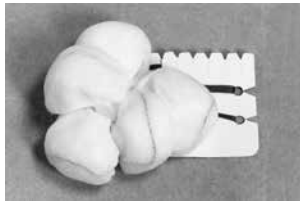

200335

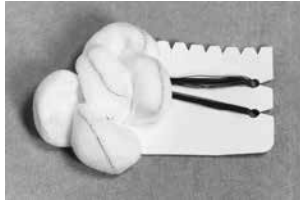

200340

CATALOG #	DESCRIPTION
200333	Medium X-ray detectable Sterile, double-strung, gauze-filled, gauze covered 500 per box, 5 per accountability card
200334	Large X-ray detectable Sterile, double-strung, gauze-filled, gauze-covered 500 per box, 5 per accountability card
200335	X-Large X-ray detectable Sterile, double-strung, gauze-filled, gauze-covered 500 per box, 5 per accountability card
200340	Medium X-ray detectable Sterile, double-strung, gauze-filled, gauze-covered 100 per box, 5 per accountability card

WECK® SPECIALTY PRODUCTS

Accessories

"FISH HOOK" NEURO ELASTIC RETRACTORS

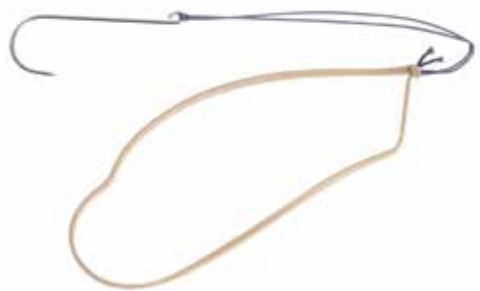

382805

CATALOG #	DESCRIPTION
382800	Durahook, 1/4" (6 mm) hook, sterile, single use. 6/pouch, 10 pouches/box
382805	Dermahook, 1/2" (12.5 mm) hook, sterile, single use. 6/pouch, 10 pouches/box

RANEY CLIP APPLYING FORCEPS



658500

CATALOG #	DESCRIPTION
658500	Reusable, 6" (15 cm)

RANEY NYLON CLIPS



658505

CATALOG #	DESCRIPTION
658505	Sterile, single use, 10/pouch, 20 pouches/box

CONTAINER SYSTEMS

Pilling® Container Systems

NON-PERFORATED CONTAINER BOTTOM



920100



930100



940100

CATALOG #	DESCRIPTION
920100	Small 1/2, 285 x 280 x 135 mm
930100	Medium 3/4, 465 x 280 x 135 mm
940100	Large 1/1, 580 x 280 x 135 mm

PERFORATED CONTAINER LID



920200

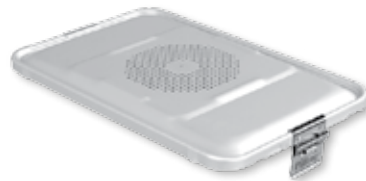

930200



940200

Silver.

CATALOG #	DESCRIPTION
920200	Small 1/2, 285 x 280 mm
930200	Medium 3/4, 465 x 280 mm
940200	Large 1/1, 580 x 280 mm



CONTAINER SYSTEMS

Pilling® Container Systems

PERFORATED TRAY WITH FEET



920300



930300



940300

CATALOG #	DESCRIPTION
920300	Small 1/2, 242 x 252 x 110 mm
930300	Medium 3/4, 405 x 252 x 110 mm
930301	Medium 3/4, 405 x 252 x 40 mm
940300	Large 1/1, 539 x 252 x 110 mm
940301	Large 1/1, 539 x 252 x 40 mm

PERFORATED SILICONE MAT

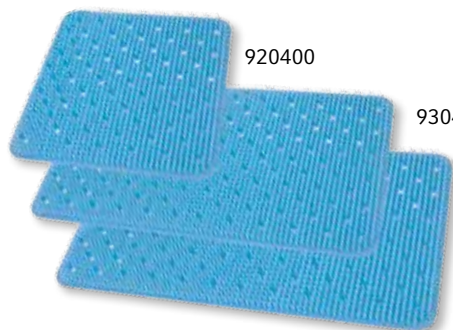

920400

930400

940400

CATALOG #	DESCRIPTION
920400	Small 1/2, 225 x 235 mm
930400	Medium 3/4, 370 x 235 mm
940400	Large 1/1, 500 x 235 mm

CONTAINER SYSTEMS

Accessories

CRADLES AND HOLDERS



970002



970003

CATALOG #	DESCRIPTION
970002	Cradle for Individual Silicone Holder (bag of 4)
970003	Cradle for 4 Silicone Holders (long)
970010	Silicone Holder 8 x 26 x 40 mm, Open
970020	Silicone Holder 8 x 26 x 40 mm, Closed
970030	Silicone Holder 8 x 26 x 40 mm, Closed Barbed



970010



970020



970030

METAL LABELS



CATALOG #	DESCRIPTION
970600	Metal ID Label, Silver
970601	Metal ID Label, Yellow
970602	Metal ID Label, Red
970603	Metal ID Label, Blue
970604	Metal ID Label, Green
970605	Metal ID Label, Black
971000	Metal ID Label, Custom Engrave, Silver*
971001	Metal ID Label, Custom Engrave, Yellow*
971002	Metal ID Label, Custom Engrave, Red*
971003	Metal ID Label, Custom Engrave, Blue*
971004	Metal ID Label, Custom Engrave, Green*
971005	Metal ID Label, Custom Engrave, Black*

*14 characters per line, 2 line maximum



CONTAINER SYSTEMS

Accessories

FILTERS



970700



970701

CATALOG #	DESCRIPTION
970700	Filter Holder for S,M,L Paper Filter
970701	Paper Filters 100/pk for S,M,L Container
970702	Paper Filters 500/pk for S,M,L Container

ADDITIONAL ACCESSORIES



970705



979000



970040



970008



971010

CATALOG #	DESCRIPTION
970705	Paper Label w/Indicator 250/pk for S,M,L
979000	Plastic Security Seal 100/pk
970040	Extra Cradle Fixation Clips, 4 each
970008	Extra Tray Feet, 4 each
971010	Tray Tag Clips, Metal



WECK® LIGATION SOLUTIONS

Metal and polymer products to help you ligate with security and confidence

Since humble beginnings in Edward Weck's Manhattan storefront in 1884, Weck® Branded products have been there for surgeons — step-by-step — since the earliest days of modern surgery.

In 1963, Weck® redefined the closure market with the introduction of the Hemoclip® Traditional Metal Ligating Clip. Over the last fifty years, the Weck® Brand has continued to refine the science of closure to produce a line of metal and polymer ligation solutions demanded by surgeons around the world.

Whether you prefer the classic feel of metal clips, or the modern flexibility of polymer, Teleflex® offers ligation products designed to suit your distinct preferences and procedural needs:

- **Hem-o-lok® Polymer Locking Ligation System** – provides cool ligation, lasting security, and the ability to place and remove clips as needed. Hem-o-lok® Clips are ideal for both open and laparoscopic cases.
- **Horizon™ and Hemoclip® Metal Ligation Systems** – satisfy your need for traditional metal ligating clips for use in cardiovascular and general surgical applications. Available in a range of sizes. Surgeons have relied on Weck® Metal Clips for generations.



WECK® LIGATION SOLUTIONS

Weck® Hem-o-lok® Polymer Locking Ligation System

CONFIDENCE YOU CAN FEEL

Confidence. That's what the Weck® Hem-o-lok® Polymer Locking Ligation System provides. Confidence created by a ligation system designed for clip security — secure in the applier, locked onto the patient vessel.

SECURITY BY DESIGN

The Hem-o-lok® Closure System's unique design and flexible hinge keep the clip firmly seated in applier jaws. The clip's distinct tactile feedback confirms jaw seating and secure vessel placement.

COOL LIGATION

Since Hem-o-lok® is a Cool Ligation System, there's no chance of thermal spread to vital structures, a common concern of many surgeons when using energy-based ligation solutions.

SIZE RANGES TO MEET YOUR NEEDS

The Hem-o-lok® System is available in a range of clip sizes: Medium, Medium-Large, Large and Extra-Large. The Hem-o-lok® System allows for ligation of 10 mm vessels through a 5 mm port or 16 mm vessels through a 10 mm port. Our broad range of applier lengths (including 45 cm endoscopic appliers for extended reach) allows surgeons to deliver clips with control and confidence.

HEM-O-LOK® BEHIND THE CLIP

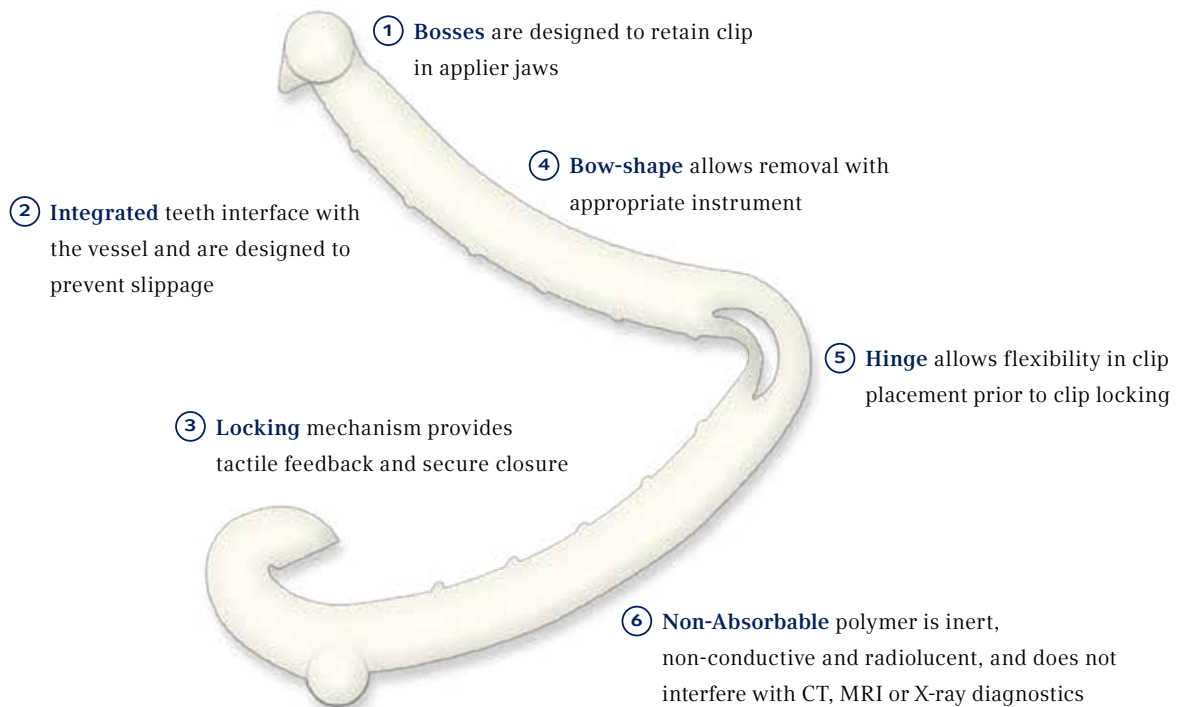

WECK® LIGATION SOLUTIONS

Weck® Hem-o-lok® Polymer Locking Ligation System

MANUAL LOAD APPLIERS

HEM-O-LOK® OPEN APPLIERS

- Open appliers available in Medium, Medium-Large, Large, Extra-Large
- Available in 8" and 11" lengths and curved or right angle jaws
- Opens at box-lock for easy, thorough cleaning



544180



544179



544240

HEM-O-LOK® ENDOSCOPIC APPLIERS

- Endo appliers available in Medium-Large, Large, Extra-Large
- Medium-Large appliers available on a 5 mm platform
- Available with 32 cm or extended-length 45 cm shafts
- One-piece and take-apart designs



544995T



544965

AUTOMATIC APPLIER

AUTO ENDO5® APPLIER

- 5 mm automatic closure system with 15 Medium-Large clips
- Medium-Large clips designed for 3-10 mm size vessels
- Clip designed for security – locks on to patient vessel



543965

*Hem-o-lok® Ligating Clips are not intended for use as a fallopian contraceptive tubal occlusion device.
Hem-o-lok® Ligating Clips are contraindicated for use in ligating the renal artery during laparoscopic donor nephrectomies.*



WECK® LIGATION SOLUTIONS

Weck® Hem-o-lok® Polymer Locking Ligation System

VESSEL/TISSUE BUNDLE SIZE RANGE

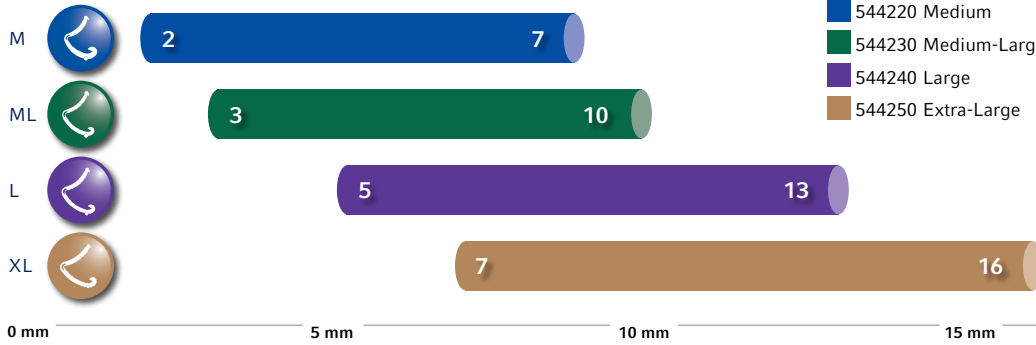

HEM-O-LOK® POLYMER LIGATING CLIPS

- 544220 Medium
- 544230 Medium-Large
- 544240 Large
- 544250 Extra-Large





WECK® LIGATION SOLUTIONS

Weck® Hem-o-lok® Polymer Locking Ligation System

ORDERING INFORMATION

WECK® HEM-O-LOK® POLYMER LOCKING LIGATION SYSTEM

CLIPS	OPEN MANUAL LOAD APPLIERS/REMOVERS	ENDOSCOPIC MANUAL LOAD APPLIERS/REMOVERS	AUTOMATIC APPLIERS
 M 544220 Hem-o-lok® Medium Polymer Clips 6 clips/cartridge 14 cartridges per box, sterile	544113 8" Curved 544114 11" Right Angle (70°) 544115 11" Curved 544123 11" Remover (for M, ML, L)		
 ML 544230 Hem-o-lok® Medium-Large Polymer Clips 6 clips/cartridge 14 cartridges per box, sterile	544170 8" Curved 544171 11" Curved 544172 11" Right Angle (70°) 544123 11" Remover (for M, ML, L)	Endo5® Applier ML, 5 mm diameter 544965 32.5 cm applier 544965L 45 cm applier 544965T 34 cm applier, take-apart 544121 32 cm remover (for ML and L) 544121L 45 cm remover (for ML and L) 544121T 32 cm remover, take-apart (for ML and L)	543965 Auto Endo5® Applier 15 clips per applier, 3 appliers per box, sterile, disposable for endo surgery
 L 544240 Hem-o-lok® Large Polymer Clips 6 clips/cartridge 14 cartridges per box, sterile	544179 11" Right Angle (70°) 544180 8" Curved 544181 11" Curved 544182 10" Right Angle (70°), narrow shaft 544123 11" Remover (for M, ML, L) 544124 11" Remover (for L, XL)	Endo10™ Applier L 544995 32 cm applier, 10 mm 544995L 45 cm applier, 10 mm 544995T 34 cm applier, 10 mm, take-apart 544121 32 cm remover, 5 mm (for ML and L) 544121L 45 cm remover, 5 mm (for ML and L) 544121T 32 cm remover, 5 mm, take-apart (for ML and L) 544130 32 cm remover, 10 mm (for L and XL) 544130L 45 cm remover, 10 mm (for L and XL) 544130T 33 cm remover, 10 mm take-apart (for L and XL)	
 XL 544250 Hem-o-lok® Extra-Large Polymer Clips 6 clips/cartridge 14 cartridges per box, sterile	544191 11" Curved 544192 11" Right Angle (70°) 544124 11" Remover (for L, XL)	Endo10™ Applier XL, 10 mm diameter 544990 32 cm applier 544990L 45 cm applier 544990T 34 cm applier, take-apart 544130 32 cm remover (for L and XL) 544130L 45 cm remover (for L and XL) 544130T 33 cm remover, take-apart (for L and XL)	
STORAGE TRAY		544500 capacity: 3 endoscopic 32 cm appliers P37319 capacity: 2-3 endoscopic 45 cm appliers	

Hem-o-lok® Ligating Clips are not intended for use as a fallopian contraceptive tubal occlusion device.
 Hem-o-lok® Ligating Clips are contraindicated for use in ligating the renal artery during laparoscopic donor nephrectomies.

WECK® LIGATION SOLUTIONS

Weck® Horizon™ Metal Ligation System

The Horizon™ System is the Weck® Premium Titanium Ligation Platform providing surgeons a strong, secure clip coupled with an efficient, convenient easy-load cartridge system.

THE HORIZON™ CLIP

The preformed chevron shape of the Horizon™ Clip engulfs tissue with precise tip-to-tip closure. Heart-shaped wire is designed to give each clip a firm grip on vessels, while the triangulated cross-section of the clip leg maximizes surface-to-surface contact between clip and jaw, practically eliminating clip fallout.

THE HORIZON™ CARTRIDGE

The design of the Horizon™ Cartridge creates a frictionless one-hand load. Horizon™ Cartridges are color-coded to match applicators and adhesive backing allows convenient placement of the cartridge to any sterile area.

Clip images represent approximate, not exact, sizes.



MICROCLIP™



SMALL



MEDIUM



MEDIUM-LARGE



LARGE



WECK® LIGATION SOLUTIONS

Weck® Horizon™ Metal Ligation System

OPEN APPLIERS

- Available with curved (20°), angled (55°) or right angled (70°) jaws
- Opens at box-lock for easy, thorough cleaning
- Available in a wide range of applier lengths, including 14"



ENDOSCOPIC APPLIERS

- Medium, Medium-Large and Large
- Extended length available (45 cm shaft)
- Large, lightweight rotation knob allows one-finger, 360° rotation of applier shaft
- Flush ports for thorough cleaning



CLIP OPTIONS

- The Horizon™ Clip Cartridge provides incredibly easy and precise loading that can enhance surgical procedure efficiency
- Both 6- and 24-clip cartridges are available



SPECIALTY APPLIER

- The Horizon™ 11" Multi-Angle Access Open Surgical Applier for small (wide slot) clip cartridges incorporates a 45° angled jaw (or curved jaw) for an optimal angle of access to the surgical target
- The Horizon™ Endosaphenous Vein Applier incorporates a 5 mm shaft diameter with a 7 mm angled jaw for ligation of vein branches



Weck® Ligating Clips are not intended for use as a contraceptive tubal occlusion device.

Weck® Ligating Clips are contraindicated for use in ligating the renal artery during laparoscopic donor nephrectomies.

WECK® LIGATION SOLUTIONS

Weck® Horizon™ Metal Ligation System

ORDERING INFORMATION

WECK® HORIZON™ METAL LIGATION SYSTEM

□ Micro ■ Small ■ Small-Wide ■ Medium ■ Medium-Large ■ Large

TITANIUM LIGATING CLIPS

CATALOG #	CLIP SIZE	CLIPS/CARTRIDGE	CARTRIDGES/BOX	CLIPS/BOX
005200	MicroClip™	6	30	180
001200	Small	6	30	180
001204	Small	24	25	600
001201	Small-Wide	6	30	180
001205	Small-Wide	24	25	600
002200	Medium	6	30	180
002204	Medium	24	25	600
003200	Medium-Large	6	20	120
003204	Medium-Large	24	15	360
004200	Large	6	20	120
004204	Large	24	15	360



WECK® LIGATION SOLUTIONS

Weck® Horizon™ Metal Ligation System

WECK® HORIZON™ METAL LIGATION SYSTEM

□ Micro ■ Small ■ Small-Wide ■ Medium ■ Medium-Large ■ Large

OPEN SURGICAL APPLIERS

CATALOG #	APPLIER LENGTH	CLIP SIZE	JAW TYPE*
537061	6" (15 cm)	MicroClip™	Curved
537081	8" (20 cm)	MicroClip™	Curved
137061	6" (15 cm)	Small	Curved
137081	8" (20 cm)	Small	Curved
137085	8" (20 cm)	Small	Angled
137111	11" (28 cm)	Small	Curved
137062	6" (15 cm)	Small-Wide	Curved
137082	8" (20 cm)	Small-Wide	Curved
137086	8" (20 cm)	Small-Wide	Angled
137112	11" (28 cm)	Small-Wide	Curved
237061	6" (15 cm)	Medium	Curved
237081	8" (20 cm)	Medium	Curved
237085	8" (20 cm)	Medium	Angled
237111	11" (28 cm)	Medium	Curved
237115	11" (28 cm)	Medium	Angled
237117	11" (28 cm)	Medium	Right Angled
237141	14" (35.5 cm)	Medium	Curved
237145	14" (35.5 cm)	Medium	Angled
337081	8" (20 cm)	Medium-Large	Curved
337085	8" (20 cm)	Medium-Large	Angled
337111	11" (28 cm)	Medium-Large	Curved
337115	11" (28 cm)	Medium-Large	Angled
337117	11" (28 cm)	Medium-Large	Right Angled
337141	14" (35.5 cm)	Medium-Large	Curved
337145	14" (35.5 cm)	Medium-Large	Angled
437081	8" (20 cm)	Large	Curved
437085	8" (20 cm)	Large	Angled
437111	11" (28 cm)	Large	Curved
437115	11" (28 cm)	Large	Angled
437117	11" (28 cm)	Large	Right Angled
437141	14" (35.5 cm)	Large	Curved
437145	14" (35.5 cm)	Large	Angled

ENDOSCOPIC LIGATING APPLIERS

CATALOG #	APPLIER LENGTH	DIAMETER	CLIP SIZE	JAW TYPE
238110	12" (31 cm)	10 mm	Medium	Endoscopic
238170	18" (45 cm)	10 mm	Medium	Endoscopic
238200	13" (32 cm)	5 mm Shaft, 7 mm Jaw	Medium	Endosaphenous
338110	12" (21 cm)	10 mm	Medium-Large	Endoscopic
338170	18" (45 cm)	10 mm	Medium-Large	Endoscopic
438110	14" (36 cm)	12 mm	Large	Endoscopic
438170	18" (45 cm)	12 mm	Large	Endoscopic

ENDOSCOPIC LIGATING APPLIERS – TAKE-APART

CATALOG #	APPLIER LENGTH	DIAMETER	CLIP SIZE	JAW TYPE
238110T	13" (32 cm)	10 mm	Medium	Endoscopic
338110T	13" (32 cm)	10 mm	Medium-Large	Endoscopic

SPECIALTY OPEN SURGICAL LIGATING APPLIERS

CATALOG #	APPLIER LENGTH	CLIP SIZE	JAW TYPE
137117	11" (28 cm)	Small-Wide	45° Angled
137118	11" (28 cm)	Small-Wide	Curved

METAL CLIP REMOVERS (REMOVES ALL WECK METAL CLIPS)

CATALOG #	APPLIER LENGTH	STYLE
523120	6.5" (16.5 cm)	Straight
523121	10.5" (26.7 cm)	Bent Shaft, 30° Angle

Weck® Ligating Clips are not intended for use as a contraceptive tubal occlusion device. Weck® Ligating Clips are contraindicated for use in ligating the renal artery during laparoscopic donor nephrectomies.

**Curved 20°, Angled 55°, Right Angle 70°*

WECK® LIGATION SOLUTIONS

Weck® Hemoclip® Traditional and Plus Metal

HEMOCLIP® TRADITIONAL

The Hemoclip® Traditional Metal Ligating Clips:

- Friction fit loading system
- Available in titanium, tantalum and stainless steel – the widest metal selection in the industry
- Cartridge base to assist loading

HEMOCLIP® PLUS

The Hemoclip® Plus System is an evolution of the classic metal Hemoclip® Hemoclip® Plus Metal Ligating Clips:

- Features an easy-load cartridge system
- Clip loads from the cartridge with minimal pressure
- Available with adhesive or non-adhesive clip cartridges

CLIP OPTIONS

- Chevron shaped clip for precise tip to tip closure
- Heart-shaped wire for tenacious grip on vessels
- Lateral transverse grooves for increased vessel contact



523130

OPEN APPLIERS

- Available in a variety of lengths and tip angles
- Opens at box-lock for easy cleaning



- Curved tip



- Right angle tip

WECK® LIGATION SOLUTIONS

Weck® Hemoclip® Traditional and Plus Metal



Weck® Ligating Clips are not intended for use as a contraceptive tubal occlusion device.

Weck® Ligating Clips are contraindicated for use in ligating the renal artery during laparoscopic donor nephrectomies.

WECK® LIGATION SOLUTIONS

Weck® Hemoclip® Traditional and Plus Metal

ORDERING INFORMATION

WECK® HEMOCLIP® TRADITIONAL CLIPS AND APPLIERS

■ Small ■ Medium ■ Medium-Large ■ Large

HEMOCLIP® TRADITIONAL-TITANIUM LIGATING CLIPS

CATALOG #	CLIP SIZE	CLIPS/ CARTRIDGE	CARTRIDGES/ BOX	CLIPS/BOX
523735	Small	25	12	300
523835	Small	10	24	240
523700	Medium	25	10	250
523800	Medium	10	20	200
523760	Medium-Large	10	20	200
523860	Medium-Large	10	16	160
523770	Large	15	10	150
523870	Large	10	12	120

HEMOCLIP® TRADITIONAL-TANTALUM LIGATING CLIPS

CATALOG #	CLIP SIZE	CLIPS/ CARTRIDGE	CARTRIDGES/ BOX	CLIPS/BOX
523135	Small	25	12	300
523335	Small	10	24	240
523100	Medium	25	10	250
523300	Medium	10	20	200
523160	Medium-Large	10	20	200
523360	Medium-Large	10	16	160
523170	Large	15	10	150
523370	Large	10	12	120

HEMOCLIP® TRADITIONAL-STAINLESS STEEL LIGATING CLIPS

CATALOG #	CLIP SIZE	CLIPS/ CARTRIDGE	CARTRIDGES/ BOX	CLIPS/BOX
523435	Small	25	12	300
523635	Small	10	24	240
523400	Medium	25	10	250
523600	Medium	10	20	200
523460	Medium-Large	10	20	200
523660	Medium-Large	10	16	160
523470	Large	15	10	150
523670	Large	10	12	120

HEMOCLIP® TRADITIONAL LIGATING CLIP APPLIERS

CATALOG #	CLIP SIZE	APPLIER LENGTH	JAW TYPE
523140	Small	6" (15 cm)	Curved
523150	Small	8" (20 cm)	Curved
523151	Small	11" (28 cm)	Curved
523105	Medium	8" (20 cm)	Right Angled
523106	Medium	11" (28 cm)	Right Angled
523109	Medium	6" (15 cm)	Curved
523110	Medium	8" (20 cm)	Curved
523111	Medium	11" (28 cm)	Curved
523165	Medium-Large	8" (20 cm)	Curved
523166	Medium-Large	11" (28 cm)	Curved
523167	Medium-Large	8" (20 cm)	Right Angled
523168	Medium-Large	11" (28 cm)	Right Angled
523175	Large	8" (20 cm)	Curved
523177	Large	8" (20 cm)	Right Angled
523178	Large	11" (28 cm)	Right Angled
523180	Large	11" (28 cm)	Curved

HEMOCLIP® TRADITIONAL LIGATING CLIP PRECISION APPLIERS

CATALOG #	CLIP SIZE	APPLIER LENGTH	JAW TYPE
523540	Small	6" (15 cm)	Curved
523550	Small	8" (20 cm)	Curved
523551	Small	11" (28 cm)	Curved

HEMOCLIP® LIGATING CLIP ACCESSORIES

CATALOG #	CLIP SIZE	APPLIER LENGTH	JAW TYPE
523120	Removing Forceps	6" (15 cm)	Straight
523121	Removing Forceps	10" (25.4 cm)	Angled Shanks
523130	Cartridge Base	7" (17.78 cm)	

WECK® LIGATION SOLUTIONS

Weck® Hemoclip® Traditional and Plus Metal

WECK® HEMOCLIP® PLUS CLIPS AND APPLIERS

■ Small ■ Small-Strongpoint ■ Medium ■ Medium-Large ■ Large

HEMOCLIP® PLUS TITANIUM LIGATING CLIPS

CATALOG #	CLIP SIZE	CLIPS/ CARTRIDGE	CARTRIDGES/ BOX	CLIPS/BOX
533735	Small w/tape	25	12	300
533737	Small	25	12	300
533835	Small w/tape	10	18	180
533837	Small	10	18	180
534735	Small-Strongpoint w/tape	25	12	300
534737	Small-Strongpoint	25	12	300
534835	Small-Strongpoint w/tape	10	18	180
534837	Small-Strongpoint	10	18	180
533700	Medium w/tape	25	10	250
533702	Medium	25	10	250
533800	Medium w/tape	10	18	180
533802	Medium	10	18	180
533860	Medium-Large w/tape	10	12	120
533862	Medium-Large	10	12	120
533870	Large w/tape	10	12	120
533872	Large	10	12	120

HEMOCLIP® PLUS LIGATING CLIP APPLIERS

CATALOG #	CLIP SIZE	APPLIER LENGTH	JAW TYPE
533140	Small	6" (15 cm)	Curved
533150	Small	8" (20 cm)	Curved
533151	Small	11" (28 cm)	Curved
533152	Small	8" (20 cm)	Right Angled
534140	Small-Strongpoint	6" (15 cm)	Curved
534150	Small-Strongpoint	8" (20 cm)	Curved
533105	Medium	8" (20 cm)	Right Angled
533106	Medium	11" (28 cm)	Right Angled
533108	Medium	11" (28 cm)	Angled
533109	Medium	6" (15 cm)	Curved
533110	Medium	8" (20 cm)	Curved
533111	Medium	11" (28 cm)	Curved
533164	Medium-Large	11" (28 cm)	Angled
533165	Medium-Large	8" (20 cm)	Curved
533166	Medium-Large	11" (28 cm)	Curved
533167	Medium-Large	8" (20 cm)	Right Angled
533168	Medium-Large	11" (28 cm)	Right Angled
114527	Medium-Large	13" (32 cm)	Endoscopic
533175	Large	8" (20 cm)	Curved
533177	Large	8" (20 cm)	Right Angled
533178	Large	11" (28 cm)	Right Angled
533180	Large	11" (28 cm)	Curved
533181	Large	11" (28 cm)	Angled

HEMOCLIP® LIGATING CLIP ACCESSORIES

CATALOG #	CLIP SIZE	APPLIER LENGTH	JAW TYPE
523120	Removing Forceps	6" (15 cm)	Straight
523121	Removing Forceps	10" (25.4 cm)	Angled Shanks
523130	Cartridge Base	7" (17.78 cm)	

Weck® Ligating Clips are not intended for use as a contraceptive tubal occlusion device.

Weck® Ligating Clips are contraindicated for use in ligating the renal artery during laparoscopic donor nephrectomies.





EAR, NOSE AND THROAT (ENT) INSTRUMENTS

CHAPTER OVERVIEW

Today, the Pilling® Brand is recognized worldwide for excellence achieved in the area of Ear, Nose and Throat surgical instrumentation, which has established Teleflex® as a market leader in the Otolaryngology specialty with our rigid endoscopes.

A wide selection of unique designs, patterns and proprietary Pilling® ENT Instruments co-developed with leading surgeons are provided to customers across the world to help improve the standard of patient care.

Our ENT Pilling® Instruments meet your hospital's needs in the ENT specialty by offering high quality OR grade instruments made of 100% German and U.S. stainless steel. A full line of rigid endoscopes – laryngoscopes, bronchoscopes and esophagoscopes – is offered, along with many laryngeal, bronchial and esophageal instruments used during endoscopic surgical procedures. Biopsy forceps, grasping forceps, retrieval forceps, aspirating tubes and other related instruments have been designed specifically in length and diameter to work with Pilling® Scopes.

PRODUCTS

Our full line of Pilling® ENT Scopes, Tracheostomy Tubes, Bougies and Dilators is made in the U.S.A. and includes the following:

- Laryngoscopes
- Bronchoscopes
- Esophagoscopes
- Tracheostomy Tubes
- Dilators
- Maloney and Hurst Bougies
- Related Instrumentation



FEATURED PRODUCT

Pilling® Video Laryngoscope Systems Versatility. *Surgeon-inspired design. High quality resolution.*

When you want versatility, look to Pilling® Ossoff and Dedo® Laryngoscopes. Our dual channel designs allow the telescope, suction tube or light carrier to be positioned as the surgeon chooses.

Each video laryngoscope system includes a laryngoscope, telescope, suction tube and light carrier. Trays are optional.





LARYNGOSCOPES



PILLING® LARYNGOSCOPES

Offering one of the largest selections of laryngoscopes in the world today, Pilling® Scopes include designs by leading surgeons. All laryngoscopes have fiberoptic light carriers.

NEW!
Ossoff-Pilling® Video
Laryngoscope
522194
See pg. 411 for details.

LARYNGOSCOPE AND LASER LARYNGOSCOPE PATIENT SIZE LISTING

NEONATE/INFANT LARYNGOSCOPES

521500	Holinger
521550	Jackson
522002	Holinger

CHILD/PEDIATRIC LARYNGOSCOPES

521450	Tucker
521820	Jackson Direct
522004	Tucker-Anterior
522216	Jako III
522222	Pilling®-Dedo

CHILD/PEDIATRIC LASER LARYNGOSCOPES

522237	Ossoff-Karlan-Dedo
--------	--------------------

CHILD/PEDIATRIC SUBGLOTTISCOPES

522242	Healy Pediatric Subglottiscope
--------	--------------------------------

ADOLESCENT LARYNGOSCOPES

521455	Tucker Slide
521554	Jackson
522209	Jako-Cherry Type III
522224	Dedo

LASER LARYNGOSCOPES

522238	Ossoff-Karlan
522292	Pilling® Double-Action

ADULT LARYNGOSCOPES

521460	Tucker
521465	Tucker
521556	Jackson
521558	Jackson
521824	Jackson Direct
522010	Holinger
522012	Holinger
522040	Holinger
522030	Holinger
522032	Holinger
522045	Holinger
522206	Jako-Micro Type III
522225P	Pilling®-Dedo
522229	Abramson-Dedo

LASER LARYNGOSCOPES

522290	Pilling®-Dedo
522291	Pilling®-Ossoff
522193	Pilling®-Ossoff Video
522228	Dedo Micro
522243	Dedo Extra Long
522231	Ossoff-Karlan-Dedo
522232	Ossoff-Karlan-Jako
522233	Ossoff-Karlan
522229	Abramson-Dedo

SUBGLOTTISCOPES

522244	Ossoff
522245	Ossoff

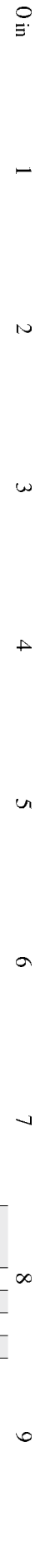

LARYNGOSCOPES

Teeth Guards

TEETH GUARDS



502275

These nylon teeth guards were designed as protection for the patient's teeth against pressure that may be exerted during insertion and positioning of a laryngoscope.

CATALOG #	DESCRIPTION
502275	Adult size teeth guards, box of 24 pair
502276	Adult size teeth guards, box of 3 pair

Laryngoscopes/Monocular View

TUCKER MID-LIGHTED SIDE SLIDE LARYNGOSCOPES



521465

A standard Jackson Slide Laryngoscope with a mid-line fiber optic light carrier and Tucker modification of a side slide. The side slide removal allows for easy introduction of the bronchoscope. The shortened light carrier facilitates the use of the instrument in the vallecula to minimize the shadow cast by the epiglottis when introducing a bronchoscope. Supplied with one light carrier. Cable sold separately (pg. 467).

CATALOG #	SCOPE SIZE	OVERALL LENGTH	MIN I.D.	NOMINAL PROXIMAL I.D.	MAX O.D.	REPLACE CARRIER
521450	Child	91 mm	6.9 mm	9.0 mm	14.0 mm	526510
521455	Adolescent	106 mm	9.0 mm	10.0 mm	17.0 mm	526512
521460	Adult	121 mm	10.7 mm	12.0 mm	19.0 mm	526515
521465	Long Adult	160 mm	11.8 mm	12.0 mm	19.0 mm	526516

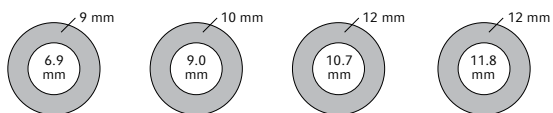

521450

521455

521460

521465

Drawings illustrate Nominal Proximal Internal Dimensions and Minimum Internal Diameter (I.D.), NOT TO SCALE.



LARYNGOSCOPES

Laryngoscopes/Monocular View

HOLINGER INFANT (NEWBORN) SLIDE LARYNGOSCOPE



521500

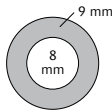

521500

Drawings illustrate Nominal Proximal Internal Dimensions and Minimum Internal Diameter (I.D.), NOT TO SCALE

Supplied with a very small light carrier to permit maximum lumen. Cable sold separately (pg. 467).

CATALOG #	SCOPE SIZE	OVERALL LENGTH	MIN I.D.	NOMINAL PROXIMAL I.D.	MAX O.D.	REPLACE CARRIER
521500	Infant	82 mm	8.0 mm	9.0 mm	14.0 mm	526204

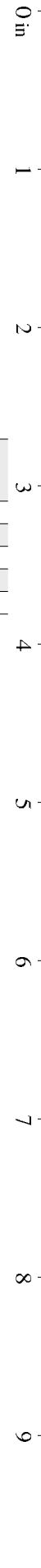

LARYNGOSCOPES

Laryngoscopes/Monocular View

JACKSON STANDARD FIBER OPTIC SLIDE LARYNGOSCOPES

The Jackson Standard Slide Laryngoscope is considered the standard scope and is used not only for introduction of a bronchoscope but also for operating in the larynx. Removable slide at bottom of scope. Supplied with one light carrier. Cable sold separately (pg. 467).



521552



521554

CATALOG #	SCOPE SIZE	OVERALL LENGTH	MIN I.D.	NOMINAL PROXIMAL I.D.	MAX O.D.	REPLACE CARRIER
521550	Infant	95 mm	8.0 mm	10.0 mm	16.0 mm	526000
521552	Child	125 mm	10.5 mm	12.0 mm	17.0 mm	526006
521554	Adolescent	160 mm	10.6 mm	12.0 mm	17.0 mm	526018
521556	Adol/Adult	160 mm	11.4 mm	13.0 mm	18.0 mm	526018
521558	Adult	160 mm	13.0 mm	14.0 mm	21.0 mm	526018

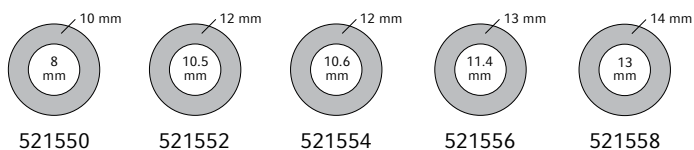

Drawings illustrate Nominal Proximal Internal Dimensions and Minimum Internal Diameter (I.D.), NOT TO SCALE



LARYNGOSCOPES

Laryngoscopes/Monocular View

JACKSON DIRECT OR ANTERIOR COMMISSURE LARYNGOSCOPES



521820

The distal tip and arrangement of the light carrier in the Jackson Anterior Commissure Laryngoscope are constructed for best vision and avoidance of trauma, especially going through the glottis into the trachea without injury to the cords. The scope is long enough to also be used as a tracheoscope in many cases. Supplied with one light carrier. Hook handle. Cable sold separately (pg. 467).

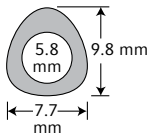

521820

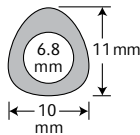

521824

Drawings illustrate Nominal Proximal Internal Dimensions and Minimum Internal Diameter (I.D.). NOT TO SCALE.

CATALOG #	SCOPE SIZE	OVERALL LENGTH	MIN I.D.	NOMINAL PROXIMAL DIMENSIONS	MAX O.D.	REPLACE CARRIER
521820	Child	133 mm	5.8 mm	7.7 x 9.8 mm	13.6 mm	526008
521824	Adult	173 mm	6.8 mm	10 x 11 mm	16.0 mm	526026

LARYNGOSCOPES

Laryngoscopes/Monocular View

HOLINGER ANTERIOR COMMISSURE LARYNGOSCOPES



522012



522040

The Holinger Anterior Commissure Laryngoscope incorporates the principle of the Yankauer post-nasal speculum. The distal end of the superior surface of the tube rises obliquely and flares laterally and the proximal portion drops obliquely. This increases the lumen and gives a larger field for work by elevating the tuberculum of the epiglottis. Supplied with one light carrier. Cable sold separately (pg. 467).

CATALOG #	SCOPE SIZE	OVERALL LENGTH	MIN I.D.	NOMINAL PROXIMAL DIMENSIONS	MAX O.D.	REPLACE CARRIER
522002	Infant	97 mm	3.7 mm	6 x 9 mm	9.8 mm	526206
522004	Child	120 mm	7.0 mm	8 x 12 mm	13.0 mm	526210
522010	Adult	170 mm	8.3 mm	10 x 14 mm	19.0 mm	526028
522012	Adult Extra-Long	180 mm	8.3 mm	10 x 14 mm	19.0 mm	526038
522040	Adult "Slotted"	170 mm	8.5 mm	10 x 14 mm	19.0 mm	526028
522045	Adult "Slotted"	170 mm	8.2 mm	10 x 19 mm	20.0 mm	526212

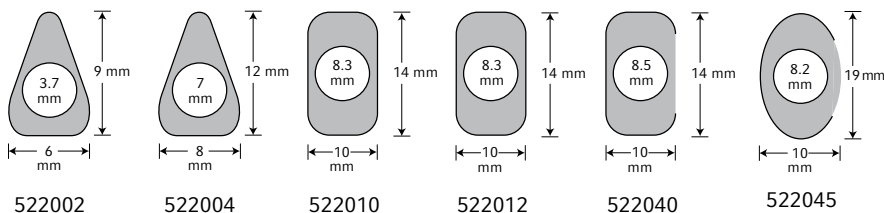

Drawings illustrate Nominal Proximal Internal Dimensions and Minimum Internal Diameter (I.D.), NOT TO SCALE.

LARYNGOSCOPES

Laryngoscopes/Monocular View

HOLINGER "HOUR GLASS" ANTERIOR COMMISSURE LARYNGOSCOPES



522032

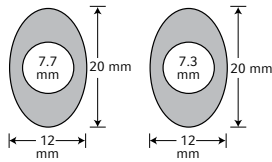

522030

522032

Drawings illustrate Nominal Proximal Internal Dimensions and Minimum Internal Diameter (I.D.), NOT TO SCALE.

The Holinger "Hour Glass" Anterior Commissure Laryngoscope accentuates the flare tip and enlarged proximal opening of the original Holinger Laryngoscope. The center portion, which is markedly constricted, and the very small light carriers give a minimal external diameter for ease in introduction while providing maximum exposure of the vocal cords for endolaryngeal surgery. Supplied with one light carrier. Cable sold separately (pg. 467).

CATALOG #	SCOPE SIZE	OVERALL LENGTH	MIN I.D.	NOMINAL PROXIMAL DIMENSIONS	MAX O.D.	REPLACE CARRIER
522030	Adult	171 mm	7.7 mm	12 x 20 mm	20.2 mm	526212
522032	Adult Extra-Long	181 mm	7.3 mm	12 x 20 mm	20.4 mm	526214

HOLINGER "SLOTTED" ANTERIOR COMMISSURE LARYNGOSCOPE



522045

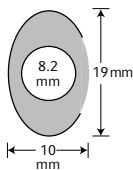

522045

Drawings illustrate Nominal Proximal Internal Dimensions and Minimum Internal Diameter (I.D.), NOT TO SCALE.

The Holinger "Slotted" Anterior Commissure Laryngoscope is a Holinger "Hour Glass" Laryngoscope that has been modified with an open slot on the working right side of the instrument. This modification allows greater latitude of forceps manipulation and may be useful in vocal cord injection procedures. Supplied with one light carrier.

CATALOG #	SCOPE SIZE	OVERALL LENGTH	MIN I.D.	NOMINAL PROXIMAL DIMENSIONS	MAX O.D.	REPLACE CARRIER
522045	Adult "Slotted"	170 mm	8.2 mm	10 x 19 mm	20.0 mm	526212

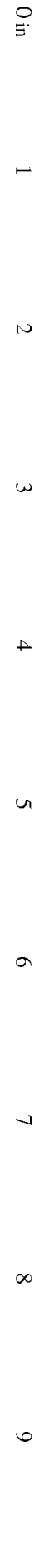

LARYNGOSCOPES

Micro-Laryngoscopes/Binocular View

PILLING® MICRO-LARYNGOSCOPES

Pilling® Micro-Laryngoscopes fulfill the need for maximum illumination and light intensity in microsurgery. The lighting systems on the micro-laryngoscopes provide more than adequate illumination for microsurgery and diagnosis when used under high microscopic magnification. These laryngoscopes were designed with direction from leading surgeons to meet their demanding requirements.



JAKO MICRO-LARYNGOSCOPE TYPE III



522206



522209

The Jako Micro-Laryngoscope Type I has been considered the standard scope for micro-laryngoscopy. However, Pilling® offers the Jako Micro-Laryngoscope Type III because of its superior design. It is identical in size and configuration to the Type I and Type II, but the Type III scope features an improved lighting system which diverts the fiber optic cable out of the way of the surgeon's hands. Additionally, a bifurcated light carrier running down each side of the laryngoscope barrel provides bilateral illumination, which minimizes shadows from the instruments as they approach vocal cord lesions. Because of these additional benefits, Pilling® is pleased to offer the Jako Micro-Laryngoscope Type III. Supplied with one bifurcated light carrier. Cable sold separately (pg. 467).

CATALOG #	SCOPE SIZE	OVERALL LENGTH	MIN I.D.	NOMINAL PROXIMAL DIMENSIONS	MAX O.D.	REPLACE CARRIER
522206	Adult	178 mm	13.4 mm	29.0 x 20.0 mm	34.0 mm	526526
522209	Adol.	149 mm	11.7 mm	25.0 x 13.0 mm	30.0 mm	526527
522216	Child	120 mm	9.1 mm	20.0 x 13.0 mm	25.0 mm	526528

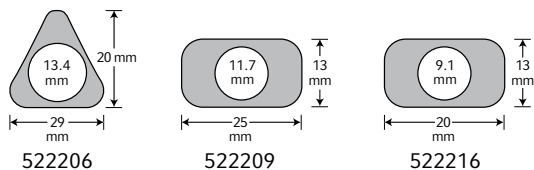

Drawings illustrate Nominal Proximal Internal Dimensions and Minimum Internal Diameter (I.D.), NOT TO SCALE.

LARYNGOSCOPES

Micro-Laryngoscopes/Binocular View

JAKO-CHERRY MICRO-LARYNGOSCOPE TYPE II (NEWBORN)



522220

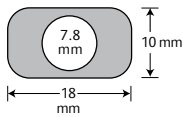

522220

Drawings illustrate Nominal Proximal Internal Dimensions and Minimum Internal Diameter (I.D.), NOT TO SCALE.

The Jako-Cherry Micro-Laryngoscope Type II is identical in size and configuration to the Type I. However, the Type II scopes are supplied with two extra-large diameter light carriers permanently connected to 72" light transmission cables (picture pg. 403).

Micro-Laryngoscopes fulfill the need for maximum illumination and light intensity in microsurgery.

CATALOG #	SIZE	OVERALL LENGTH	MIN I.D.	NOMINAL PROXIMAL DIMENSIONS	MAX O.D.	REPLACE CARRIER
522220	Newborn	114 mm	7.8 mm	18 x 10 mm	25.0 mm	527825 (R) 527820 (L)

* (R) indicates right light carrier, (L) indicates left light carrier
Not to be included in the Catalog Number

DEDO-PILLING® MICRO-LARYNGOSCOPE (OUR MOST POPULAR)



522225P

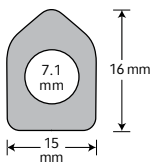

522222

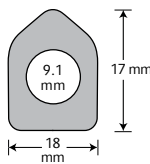

522224

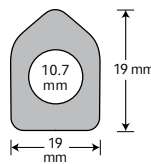

522225P

Drawings illustrate Nominal Proximal Internal Dimensions and Minimum Internal Diameter (I.D.), NOT TO SCALE.

The Dedo-Pilling® Micro-Laryngoscopes have been designed to provide the ability to examine the vocal cords at the anterior commissure in the majority of patients: for example, patients with bull necks, short jaws or prominent upper teeth. The dimensions of the Dedo-Pilling® Micro-Laryngoscopes are narrow enough between the light carriers to permit moving the instrument off the incisors and down between the molars to permit visualization of the anterior commissure. The fiber optic light carriers are adjacent to the handle with a metal protected fiber optic bundle which runs in a groove in the handle. When used with the operating microscope equipped with a 400 mm lens, the Dedo-Pilling® Micro-Laryngoscope affords binocular vision for microendoscopy. Supplied with one bifurcated light carrier. Cable sold separately (pg. 467).

CATALOG #	SIZE	OVERALL LENGTH	MIN I.D.	NOMINAL PROXIMAL DIMENSIONS	MAX O.D.	REPLACE CARRIER
522222	Child	119 mm	7.1 mm	15.0 x 16.0 mm	22.0 mm	526524
522224	Adol.	145 mm	9.1 mm	18.0 x 17.0 mm	25.0 mm	526529
522225P	Adult	178 mm	10.7 mm	19.0 x 19.0 mm	27.0 mm	526525



LARYNGOSCOPES

Micro-Laryngoscopes/Binocular View

ABRAMSON-DEDO MICRO-LARYNGOSCOPE

For Difficult Intubations

The Abramson modification of the Dedo-Pilling® Micro-Laryngoscope was designed to increase the efficiency of Venturi®-type ventilation. It provides the physician with a choice of six positions for placement of the Venturi® Needle (up to 14 Ga.). The inside is finished to be nonreflective, and 14 Ga. blunt needles may be used for smoke evacuation. It comes supplied with a set of right and left light carriers, two 12" 14 Ga. blunt needles and two Luer-Lok® Adapters for use with Sanders system tubing.

CATALOG #	SIZE	OVERALL LENGTH	MIN I.D.	NOMINAL PROXIMAL DIMENSIONS	MAX O.D.	REPLACE CARRIER
522229	Adult	177 mm	12 mm	18.4 x 19 mm	28.0 mm	527586 (R) 527587 (L)

* (R) indicates right light carrier, (L) indicates left light carrier
Not to be included in the Catalog Number

Venturi Ventilating Needles

CATALOG #	DESCRIPTION
502594	Replacement ventilating needle, 14 Ga., 5-3/8" (13.5 cm)
502600	Replacement ventilating needle, 14 Ga. bent 90 degrees, 4" (10 cm)
522241	Replacement ventilating needle, 14 Ga., blunt, 12" (30.5 cm)

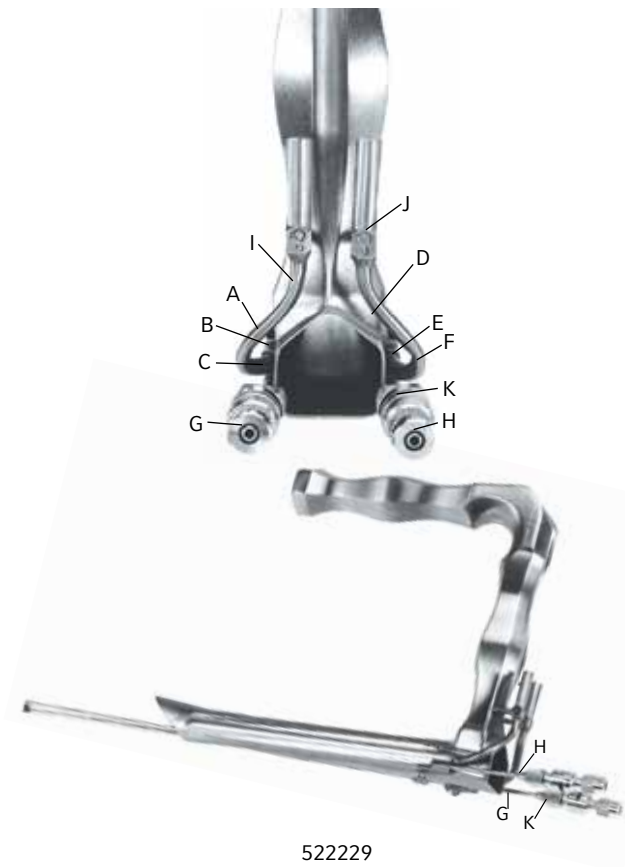

522229

LEGEND

- A, C, D, F Channels for ventilating needle up to 14 gauge
- B, E Channels for light carriers or ventilating needles
- G, H Ventilating needles and adapters
- I, J Light carriers
- K Luer-Lok® Hubs to fit tubing adapter

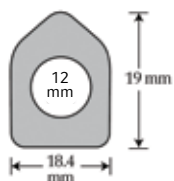

Drawings illustrate Nominal Proximal Internal Dimensions and Minimum Internal Diameter (I.D.), NOT TO SCALE.

522229

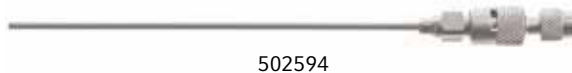

502594

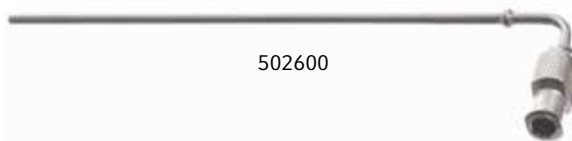

502600



522241



LARYNGOSCOPES

Micro-Laryngoscopes/Binocular View

NEW OSSOFF-PILLING® MICRO-LARYNGOSCOPE



522190

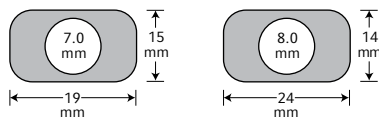

522190

522191

Drawings illustrate Nominal Proximal Internal Dimensions and Minimum Internal Diameter (I.D.), NOT TO SCALE.

Available in two proximal widths. The 25.5 mm width can be introduced in most patients and is easily aligned with the microscope (400 mm objective). The 19 mm scope has the narrowest width capable of absorbing both microscope sight lines and can be used in most patients who previously could accept only the original Holinger scope.

- Holinger distal end, ease of introduction, excellent visualization.
- 19 or 25.5 mm proximal widths, increases patient selection for micro procedures.
- Standard adult handle, can be used with most suspension systems, B.U. suspension handle available as option.
- Single light carrier, external tube dimensions are kept to a minimum.
- Laser finish, laser safety.
- Supplied with one light carrier. Cable sold separately (pictured pg. 467).

CATALOG #	SIZE	OVERALL LENGTH	MIN I.D.	NOMINAL PROXIMAL DIMENSIONS	MAX O.D.	REPLACE CARRIER
522190	Adult	168 mm	7.0 mm	19.0 x 15.0 mm	22.0 mm	527864
522191	Adult	168 mm	8.0 mm	24.0 x 14.0 mm	27.0 mm	527865

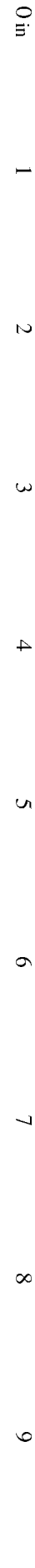

PILLING® LASER LARYNGOSCOPES

The use of lasers for ablative surgery for tissue removal has become increasingly popular. To meet the demand, a complete line of Pilling® Laryngoscopes and Accessories is available for use in laser surgery procedures. All of our laser instruments have a non-reflective, dull finish to reduce the chance of the laser beam reflecting off the instrument.

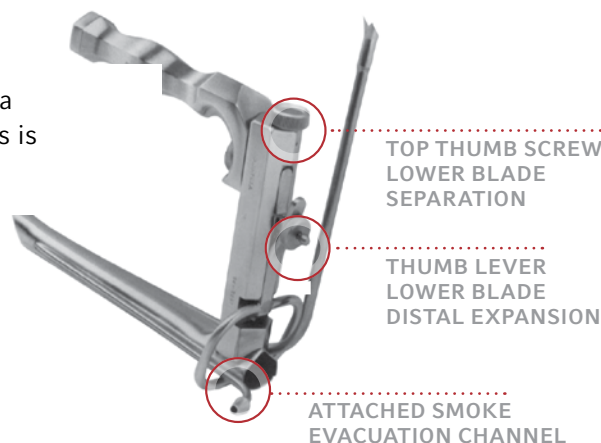

PILLING® BIVALVE LASER LARYNGOSCOPES

These special scopes are modified designs of the Pilling®-Dedo Anterior Commissure and Ossoff Posterior Commissure Micro and Laser Laryngoscopes.

- The Dedo Anterior Commissure Scopes provide minimal chance of teeth breakage, yet offer optimum microscopic visibility.
- The Ossoff Posterior Commissure Scopes provide the ability to lift the endotracheal tube and permit entrance and microscopic visibility beyond the vocal cords.
- These scopes provide increased visibility at the surgical site through expansion and distension of the split tubes.

- Distal expansion of the lower blade allows maximum visibility of the cords and beyond.
- Non-reflective internal surface minimizes laser beam deflection.
- Removable handle reduces weight during insertion. This handle can be attached to the standard laryngoscope holder (502245), or Tobey Laryngoscope Holder (502248), or adapted for use with the Boston University System (502260).
- Smoke evacuation channel is permanently attached and extends distally for maximum removal of laser plume.
- One large fiberoptic light carrier is supplied with attached cable for optimum distal lighting.

PILLING®-DEDO DOUBLE-ACTION LASER LARYNGOSCOPES

- Lower blade separation provides an increased operative area for ease of instrumentation.

Both styles of bivalve Laser Laryngoscopes have O.D. measurements which can exceed the anatomical limits for their intended patient size.

A thumb operated lever enables the physician to tactilely gauge the degree of pressure exerted.

DOUBLE-ACTION TYPE WITH LOWER BLADE SEPARATED



DOUBLE-ACTION TYPE WITH LOWER BLADE SEPARATED AND EXPANDED





LARYNGOSCOPES

Laser Micro-Laryngoscopes

DEDO LASER MICRO-LARYNGOSCOPE



522228

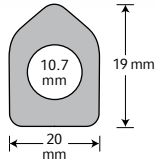

522228

Drawings illustrate Nominal Proximal Internal Dimensions and Minimum Internal Diameter (I.D.), NOT TO SCALE.

The Dedo Laser Micro-Laryngoscope was designed specifically for use with the CO₂ laser. It is supplied with two light carriers permanently attached to fiber optic cables (picture pg. 403) and features a non-reflective, dull interior finish. Its large oval light carriers provide maximum illumination, and it contains an integral aspirating channel for automatic smoke and steam evacuation. The same narrow dimensions as the standard Dedo-Pilling® Micro-Laryngoscope allow its use in many cases in which larger micro-laryngoscopes are contraindicated.

CATALOG #	SCOPE SIZE	OVERALL LENGTH	MIN I.D.	NOMINAL PROXIMAL DIMENSIONS	MAX O.D.	REPLACE CARRIER
522228	Adult	177 mm	10.7 mm	20.0 x 19.0 mm	32.0 mm	527860



LARYNGOSCOPES

Laser Micro-Laryngoscopes

DEDO-PILLING® LASER LARYNGOSCOPE EXTRA-LONG



522243

Designed for the patient with a great distance between the teeth and vocal cords. Supplied with two light carriers permanently attached to fiber optic cables.

CATALOG #	SCOPE SIZE	OVERALL LENGTH	MIN I.D.	NOMINAL PROXIMAL DIMENSIONS	REPLACE CARRIER
522243	Adult X-Long	197 mm	12.6 mm	20.0 x 20.0 mm	527860

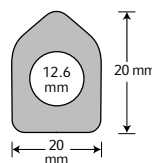

Drawings illustrate Nominal Proximal Internal Dimensions and Minimum Internal Diameter (I.D.). NOT TO SCALE.

522243

SINGLE ONE-PIECE FIBER OPTIC LIGHT CARRIERS/CABLES

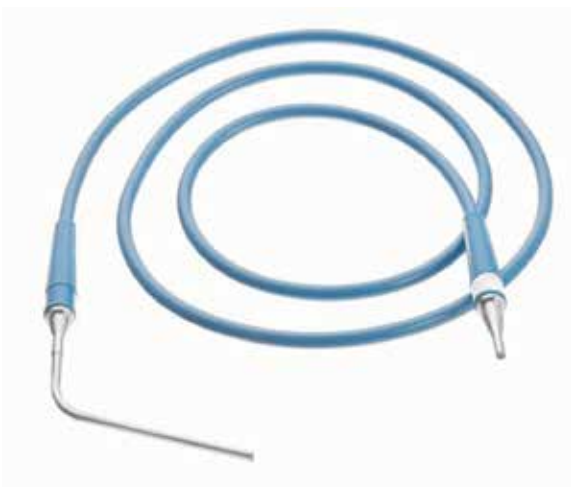

527860

Light carriers are permanently attached to fiber optic cables which provide maximum illumination.

LIGHT CARRIER/ CABLE #	SCOPE
527800 (L)	522232 Ossoff-Karlan-Jako Laser Laryngoscope, adult
527805 (R)	522232 Ossoff-Karlan-Jako Laser Laryngoscope, adult
527820 (L)	522220 Jako-Cherry Laryngoscope Type II, newborn
527825 (R)	522220 Jako-Cherry Laryngoscope Type II, newborn
527830 (R)	522242 Healy-Jako Pediatric Subglottiscope
527835 (L)	522242 Healy-Jako Pediatric Subglottiscope
527850	522311 Improved Tucker Mediastinoscope, long
527853	522306 Improved Tucker Mediastinoscope, short
527860	522228 Dedo Laser Laryngoscope
	522231 Ossoff-Karlan-Dedo Laser Laryngoscope
	522233 Ossoff-Karlan Posterior Commissure
	522243 Dedo Laser Laryngoscope, extra-long
	522244 Ossoff Adult Subglottiscope, female
	522245 Ossoff Adult Subglottiscope, male
	522290 Pilling® Dedo DA Laryngoscope, adult
522291 Pilling®-Ossoff Double-Action Laryngoscope	
527862	522238 Ossoff-Karlan Adolescent Laser Laryngoscope
527863	522237 Ossoff-Karlan Child Laser Laryngoscope
	522292 Pilling® Dedo DA Adolescent Laryngoscope

** (R) indicates right light carrier, (L) indicates left light carrier
Not to be included in the Catalog Number*



LARYNGOSCOPES

Laser Micro-Laryngoscopes

OSSOFF-KARLAN-DEDO LASER MICRO-LARYNGOSCOPES



522231



522237



522238

The Ossoff-Karlan-Dedo Laser Micro-Laryngoscopes are modifications of the Dedo and Jako Micro-Laryngoscopes with additions of special features for laser surgery. Supplied with two light carriers permanently attached to cables (picture pg. 403). Features:

- Bifurcated smoke evacuation channels.
- Non-reflective, dull interior finish.
- Large oval light carriers for maximum illumination.

CATALOG #	SIZE	OVERALL LENGTH	MIN I.D.	NOMINAL PROXIMAL DIMENSIONS	MAX O.D.	REPLACE CARRIER
522231	Adult	178 mm	11.9 mm	22.0 x 20.0 mm	35.0 mm	527860
522237	Child	130 mm	9.8 mm	18.0 x 18.0 mm	30.0 mm	527863
522238	Adol.	152 mm	9.7 mm	21.0 x 20.0 mm	33.0 mm	527862

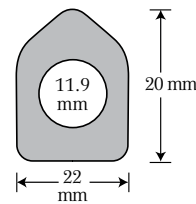

522231

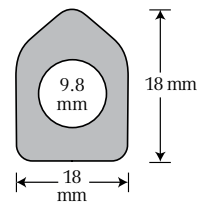

522237

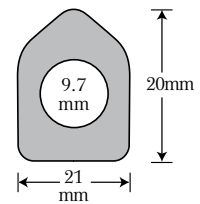

522238

Drawings illustrate Nominal Proximal Internal Dimensions and Minimum Internal Diameter (I.D.), NOT TO SCALE.



LARYNGOSCOPES

Laser Micro-Laryngoscopes

OSSOFF-KARLAN-JAKO LASER MICRO-LARYNGOSCOPE



522232

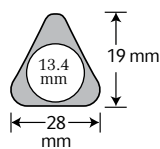

522232

Drawings illustrate Nominal Proximal Internal Dimensions and Minimum Internal Diameter (I.D.), NOT TO SCALE.

The Ossoff-Karlan-Jako Laser Micro-Laryngoscope is a modification of the Jako Micro-Laryngoscope with additions of special features for laser surgery. This interior commissure scope is a special design of Drs. Ossoff and Karlan. Supplied with two light carriers permanently attached to cables. Features:

- Bifurcated smoke evacuation channels.
- Non-reflective, dull interior finish.
- Large oval light carriers for photography.

CATALOG #	SCOPE SIZE	OVERALL LENGTH	MIN I.D.	NOMINAL PROXIMAL DIMENSIONS	MAX O.D.	REPLACE CARRIER
522232	Adult	178 mm	13.4 mm	28.0 x 19.0 mm	38.0 mm	527805 (R) 527800 (L)

* (R) indicates right light carrier, (L) indicates left light carrier
Not to be included in the Catalog Number

NEW OSSOFF-PILLING® MICRO-LARYNGOSCOPE (LASER FINISH)



522190

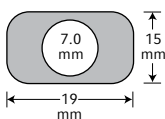

522190

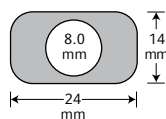

522191

Drawings illustrate Nominal Proximal Internal Dimensions and Minimum Internal Diameter (I.D.), NOT TO SCALE.

Available in two proximal widths. The 25.5 mm width can be introduced in most patients and is easily aligned with the microscope (400 mm objective). The 19 mm scope has the narrowest width capable of absorbing both microscope sight lines and can be used in most patients who previously could accept only the original Holinger scope.

- Holinger distal end, ease of introduction, excellent visualization.
- 19 or 25.5 mm proximal widths, increases patient selection for micro procedures.
- Standard adult handle, can be used with most suspension systems, B.U. suspension handle available as option.
- Single light carrier, external tube dimensions are kept to a minimum.
- Laser finish, laser safe.
- Supplied with one light carrier. Cable sold separately (pg. 467).

CATALOG #	SCOPE SIZE	OVERALL LENGTH	MIN I.D.	NOMINAL PROXIMAL DIMENSIONS	MAX O.D.	REPLACE CARRIER
522190	Adult	168 mm	7.0 mm	19.0 x 15.0 mm	22.0 mm	527864
522191	Adult	168 mm	8.0 mm	24.0 x 14.0 mm	27.0 mm	527865

LARYNGOSCOPES

Laser Micro-Laryngoscopes

OSSOFF-KARLAN POSTERIOR COMMISSURE MICRO-LARYNGOSCOPE



522233

This posterior commissure scope is a special design of Drs. Ossoff and Karlan. Supplied with two light carriers permanently attached to cables. Features:

- Bifurcated smoke evacuation channels.
- Non-reflective, dull interior finish.
- Large oval light carriers for maximum illumination.

CATALOG #	SCOPE SIZE	OVERALL LENGTH	MIN I.D.	NOMINAL PROXIMAL DIMENSIONS	MAX O.D.	REPLACE CARRIER
522233	Adult	177 mm	12.6 mm	22.0 x 19.0 mm	35.0 mm	527860

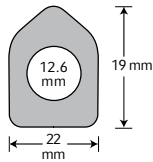

Drawings illustrate Nominal Proximal Internal Dimensions and Minimum Internal Diameter (I.D.), NOT TO SCALE.

522233

PILLING® DEDO DOUBLE-ACTION ANTERIOR COMMISSURE LARYNGOSCOPES



522290

Pilling® Bivalve Laser Laryngoscopes are modified designs of the Pilling®-Dedo Anterior Commissure and Ossoff Posterior Commissure Micro and Laser Laryngoscopes. Supplied with one light carrier permanently attached to fiber optic cable.

CATALOG #	SCOPE SIZE	OVERALL LENGTH	CLOSED MIN I.D.	NOMINAL PROXIMAL DIMENSIONS	CLOSED MAX O.D.	REPLACE CARRIER
522290	Adult	179 mm	12.7 mm	22.0 x 20.0 mm	33.0 mm	527860
522292	Adol.	136 mm	9.8 mm	21.0 x 26.0 mm	32.0 mm	527863



522292

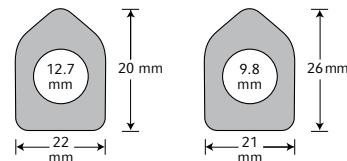

522290

522290

Drawings illustrate Nominal Proximal Internal Dimensions and Minimum Internal Diameter (I.D.), NOT TO SCALE.



LARYNGOSCOPES

Laser Micro-Laryngoscopes

PILLING® OSSOFF DOUBLE-ACTION POSTERIOR COMMISSURE LARYNGOSCOPE



522291

The Ossoff Posterior Commissure Scope provides the ability to lift the endotracheal tube and permit entrance and microscopic visibility beyond the vocal cords. This scope provides increased visibility at the surgical site through expansion and distension of the split tubes. Supplied with one light carrier permanently attached to fiber optic cable for maximum illumination.

CATALOG #	SCOPE SIZE	OVERALL LENGTH	MIN I.D.	NOMINAL PROXIMAL DIMENSIONS	REPLACE CARRIER	CLOSED MAX O.D.
522291	Adult	178 mm	12.7 mm	22.0 x 26.0 mm	527860	33.0 mm

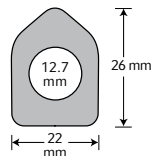

522291

Drawings illustrate Nominal Proximal Internal Dimensions and Minimum Internal Diameter (I.D.), NOT TO SCALE.



SUBGLOTTISCOPIES

Laser Subglottoscopes

HEALY-JAKO PEDIATRIC SUBGLOTTISCOPE



522242

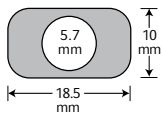

522242

Drawings illustrate Nominal Proximal Internal Dimensions and Minimum Internal Diameter (I.D.), NOT TO SCALE.



502600



502599

The Healy-Jako Subglottoscope was designed specifically for the pediatric patient. The small tapered 6 mm distal tip allows the subglottoscope to pass farther down the airway and give access to lesions below the level of the vocal cords, while still being able to utilize the operating microscope. Supplied with light carriers permanently attached to fiber optic cables. Features:

- Non-reflective, matte interior finish. This finish decreases the chance of the laser beam reflecting off the inside of the scope and burning unintended tissue. The subglottoscope is most useful when the carbon dioxide laser is used.
- Disconnect handle. Subglottoscope can be held by standard laryngoscope holder 502245 or Tobey 502248. When the handle is unscrewed, the subglottoscope can be easily inserted and manipulated.
- Large fiber optic light carriers. The large cables allow for maximum illumination and light intensity.
- Removable 14 Ga., 3-7/8" (10 cm) ventilating needle.
- Needle locking mechanism and tubing clip on the handle.
- Assures proper placement and hold of ventilating needle while keeping tubing out of the way.
- Includes 502599 Luer-Lok® Hub Adapter to Sanders tubing.

CATALOG #	OVERALL LENGTH	MIN I.D.	NOMINAL PROXIMAL DIMENSIONS	MAX O.D.	REPLACE CARRIER
522242	155 mm	5.7 mm	18.5 x 10.0 mm	29.0 mm	527830 (R) 527835 (L)
502600	Replacement Ventilating Needle				
502599	Replacement Luer-Lok® Adapter				

** (R) indicates right light carrier, (L) indicates left light carrier
Not to be included in the Catalog Number*



SUBGLOTTISCOPE

Laser Subglottiscope

OSSOFF ADULT SUBGLOTTISCOPE



522244



522245



527860

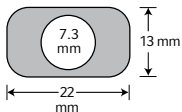

522244

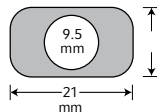

522245

Drawings illustrate Nominal Proximal Internal Dimensions and Minimum Internal Diameter (I.D.), NOT TO SCALE.

Designed to view and access beyond the vocal cords for standard and laser procedures for subglottic stenosis and subglottic lesions.

- Extended length with tapered tube (longer than standard laryngoscope).
- Wide proximal end.
- Matte finish inside lumen to reduce possible reflection of laser beam.
- Integral, distally-opened smoke evacuation channel.
- Removable 14 Ga., 3-7/8" (10 cm) ventilating needle.
- Needle locking mechanism and tubing clip on the handle.
- Single, one-piece design fiber optic light carrier/cable.
- Adult size laryngoscope handle.
- Includes 502599 Needle Luer-Lok® Adapter to Sanders Tubing.
- Passes easily through the vocal cords to reach the subglottic area.
- Provides binocular vision with use of a microscope with 350-400 lens.
- Less chance of burning unintended tissue.
- Allows for removal of laser plume rapidly.
- Allows for Venturi ventilation (order separately).
- Assures proper placement and hold of ventilating needle while keeping tubing out of the way.
- Provides optimum distally delivered light.
- Allows use of laryngoscope holder (502245) or Tobey Laryngoscope Holder (502248) for two-handed surgery.
- Adult subglottiscope requires instrumentation 28 cm or longer.

CATALOG #	SCOPE SIZE	OVERALL LENGTH	MIN I.D.	NOMINAL PROXIMAL DIMENSIONS	MAX O.D. AT DISTAL TIP	MAX O.D.
522244	Adult Female	230 mm	7.3 mm	22.0 x 13.0 mm	11.0 mm	32.0 mm
522245	Adult Male	230 mm	9.5 mm	21.0 x 13.0 mm	12.0 mm	33.0 mm
527860	Replacement Light Carrier					
502600	Replacement Ventilating Needle					
502599	Replacement Luer-Lok® Adapter					



SUBGLOTTISCPES

Laser Subglottiscope Instrumentation

MICROSUBGLOTTIC INSTRUMENTS

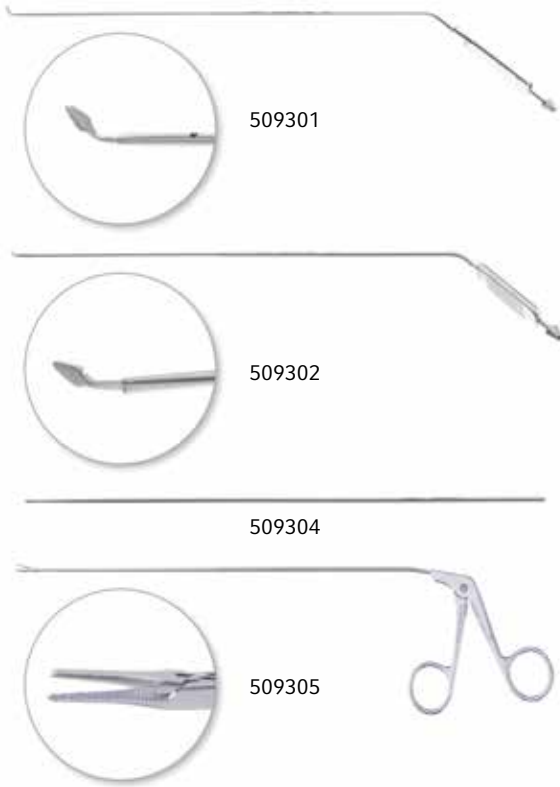

Designed for laser microsurgery of the entire subglottic space and upper cervical trachea, this instrumentation includes forceps, probe, mirror and platform (all 28 cm in length and laser finished).

CATALOG #	DESCRIPTION
509301	Operating platform, 3 mm
509302	Front surface mirror, 3 mm
509304	Straight probe
509305	Grasping forceps, straight

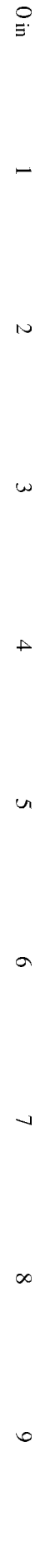

LARYNGOSCOPES

Video Laryngoscopes

NEW VIDEO LARYNGOSCOPE SYSTEMS

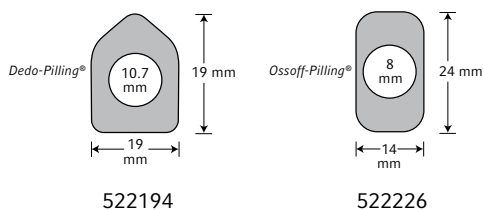

Drawings illustrate Nominal Proximal Internal Dimensions and Minimum Internal Diameter (I.D.), NOT TO SCALE.

Teleflex provides Pilling® brand Ossoff and Dedo-design Video Laryngoscopes that now include dual channels for increased versatility. The dual channel design allows the surgeon to position the telescope, suction tube or light carrier wherever it is most comfortable and is thus helpful for the left-handed surgeon. The Video Laryngoscope System is an ideal resource for training and education since the telescope can be connected to most video systems for visualization of the surgical site. The 0 degree telescope (4 mm x 177 mm) features a forward view with a right angle eyepiece to ensure that it is not in the surgeon's way. This Pilling® Telescope can be autoclaved. The telescope eyepiece will accept any standard C-mount video coupler. The fiber optic terminal of the light carrier accepts ACMI style cable connections. Each complete Video Laryngoscope System includes a laryngoscope, telescope, suction tube and light carrier. Trays are optional; see pg. 412.

CATALOG #	DESCRIPTION
522194	Ossoff-Pilling® Dual Channel Video Laryngoscope System Adult, 16.8 cm length Minimal internal diameter: 8 mm Nominal proximal dimensions: 24 x 14 mm
522226	Dedo-Pilling® Dual Channel Video Laryngoscope System Adult, 17.3 cm length Minimal internal diameter: 10.7 mm Nominal proximal diameter: 19 x 19 mm
527867	Replacement Light Carrier for 522194 or 522226
522195	Replacement Suction Tube for 522194 or 522226
524060	Replacement Telescope for 522193, 522194 and 522226 4 mm x 177 mm, 0 degrees forward, with a 90 degree eyepiece. This telescope can be autoclaved

LARYNGOSCOPES

Video Laryngoscopes

STORAGE TRAYS



508002



508004

Pilling® Trays are designed for microsurgical and other delicate instruments. These lightweight, durable trays are engineered for maximum protection and flexibility. The transparent lid will help you easily identify instruments. These trays can withstand repeated exposure to steam, ethylene oxide and cold methods.

CATALOG #	DESCRIPTION
508002	Telescope Tray Includes silicone stabilizer bars to secure telescope during storage 9-1/2" x 5-1/2" x 2-1/2" (24 x 14 x 6.5 cm)
508004	Video Laryngoscope Tray Includes silicone finger mat. Tray size will accommodate laryngoscope and fiber-optic cable 9" x 13" x 3-1/4" (23 x 33 x 8 cm)

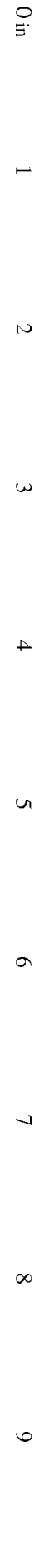

LARYNGOSCOPES

Laryngoscope Holders

Pilling® Laryngoscope Holders enable the surgeon to have both hands free during Laryngoscopy, Micro-Laryngoscopy and Laser Laryngoscopy procedures. These holders allow the surgeon to perform intricate procedures requiring both hands available for necessary instrumentation insertion through the laryngoscopes.

BOSTON UNIVERSITY SUSPENSION SYSTEM



502260

This system is used to suspend the laryngoscope during micro and laser surgery of the larynx. *Laryngoscope and Strong Laryngoscope Handle Extension (502261) are not included.*

- Supports the laryngoscope for two-handed surgery.
- Is not affected by chest movement.
- Allows use of the Boyce-Jackson position.
- Allows repositioning of the table as necessary without readjustment of the suspension system.

CATALOG #	DESCRIPTION
502260	Includes Pilling® Table Clamp (163100) and Pivoting Extension Arm Assembly (502262)
163100	Pilling® Table Clamp
502261	BU System Laryngoscope Handle
502262	BU Pivoting Extension Arm Assembly

Boston University Suspension System Scope Service to adapt handle for use with BU System. All laryngoscopes must be tapped for use with the BU System.

502261 BU System Laryngoscope Handle – must be ordered along with scope for use with BU Suspension System.

Contact Teleflex® Customer Service to have your laryngoscope tapped.



163100



502261



502262

LARYNGOSCOPES

Laryngoscope Holders

BOSTON UNIVERSITY SYSTEM PIVOTING EXTENSION ARM ASSEMBLY



502262

CATALOG #	DESCRIPTION
502262	BU Pivoting Extension Arm Assembly, overall length 10" (25.5 cm)

BOSTON UNIVERSITY SYSTEM LARYNGOSCOPE HANDLE



502261

Adapts micro-laryngoscope for use with the Boston University Suspension System. Laryngoscopes already in use may be returned to Teleflex® Instrument Repair for the modification or a new instrument may be ordered with this extension. Contact your local surgical representative for more information.

CATALOG #	DESCRIPTION
502261	BU System Laryngoscope Handle, 2-1/2" (6.5 cm)

DEDO TABLE-MOUNTED MAYO TRAY



502265

The Dedo Table-Mounted Mayo Tray System is used to support the standard Pilling® Laryngoscope Holder (502248/502245). The tray can be positioned at any height, will swivel and can be extended. All parts are stainless steel and can be disassembled for cleaning and sterilizing. This system can be easily covered by a sterile Mayo cover.

CATALOG #	DESCRIPTION
502265	Complete system: Tray Detachable Sliding Bars and Clamps Upright Rod Pilling® Table Clamp (163100)

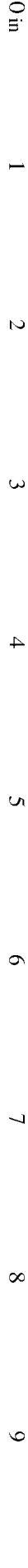

LARYNGOSCOPES

Laryngoscope Holders

NEW TOBEY LARYNGOSCOPE HOLDER (MOST POPULAR)



502248

The Tobey Laryngoscope Holder is the newest version of Pilling® Laryngoscope holders. It has a quick attach/release mechanism that provides a secure hold of your laryngoscope. The Tobey eliminates the twisting and turning necessary to lock the laryngoscope into the holder. It allows for fine adjustments using the size adjustment knob for different laryngoscope handles.

CATALOG #	DESCRIPTION
502248	Tobey Laryngoscope Holder

LARYNGOSCOPE HOLDER



502245

The external chest bar and rod easily attach to or detach from the handle of most laryngoscopes. Manually operated gear supplies leverage to the laryngoscope for exposure of the anterior commissure and allows the operator to have both hands free for instrumentation.

CATALOG #	DESCRIPTION
502245	Laryngoscope Holder, Improved Model (Laryngoscope is not included)

PILLING® TABLE CLAMP



163100

CATALOG #	DESCRIPTION
163100	Clamp for Dedo Mayo Tray (502265) and Boston University Suspension System (502260)

LARYNGOSCOPES

Venturi Anesthesia Devices

VENTURI ADAPTERS FOR BRONCHOSCOPES AND LARYNGOSCOPES



502562



502566

Flow and pressure characteristics vary greatly according to the design of the bronchoscope or laryngoscope and any new combination should be studied carefully before clinical use. *Note: The Sanders Venturi System can be used only with tapered scopes.*

CATALOG #	DESCRIPTION
502562	Albert-Sanders Venturi Adapter for laryngoscopes
502566	Sanders Venturi Adapter for Pilling® Bronchoscope 15 mm sidearm

TYGON TUBING WITH LUER-LOK® CONNECTOR



502574

Used in conjunction with Luer-Lok® connector 502599 to fit into toggle valve. The bare end of the tubing connects to the Venturi Adapters for Bronchoscopes and Laryngoscopes, 502562 and 502566.

CATALOG #	DESCRIPTION
502574	Adapter is 4 mm O.D. x 2.5 mm I.D.



LARYNGOSCOPES

Venturi Anesthesia Devices

VENTURI VENTILATING NEEDLES



CATALOG #	DESCRIPTION
502594	Replacement needles for 522229 Abramson-Dedo Micro-Laryngoscopes, 14 Ga., 5-3/8" (13.5 cm)
502600	Replacement needles for 522244 and 522245 Ossoff Adult Subglottiscopes, 522242 Healy-Jako Pediatric Subglottiscope and 522229 Abramson-Dedo Micro-Laryngoscope, 14 Ga. bent 90 degrees, 4" (10 cm)
522241	Replacement needles for 522229 Abramson-Dedo Micro-Laryngoscope, blunt, 14 Ga., 12" (30.5 cm)

REPLACEMENT LUER-LOK® HUB ADAPTER



502599

CATALOG #	DESCRIPTION
502599	Needle Luer-Lok® to Sanders Tubing, 1-1/8" (3 cm)

REPLACEMENT CLIPS



522240

CATALOG #	DESCRIPTION
522240	For securing Venturi Ventilating Needles, 5/8" (1.5 cm)



INSTRUMENTATION FOR LARYNGOSCOPES

Forceps

PILLING® LARYNGEAL INSTRUMENTATION FOR LARYNGOSCOPES AND MICRO-LARYNGOSCOPES

Pilling® Laryngeal Instruments are designed in conjunction with leading otolaryngology surgeons. These instruments can be utilized for both Laryngoscopy and Micro-Laryngoscopy. Surgeons continue to provide feedback for new designs and modifications as procedural changes occur.

JACKSON CROSS ACTION FORCEPS



For anesthetizing the larynx by blocking the superior laryngeal nerves. Stainless steel.

CATALOG #	DESCRIPTION
507375	24 cm length from proximal end of handle to curve

JACKSON LARYNGEAL CUP FORCEPS - STANDARD LIGHTWEIGHT 4 AND 6 MM CUPS

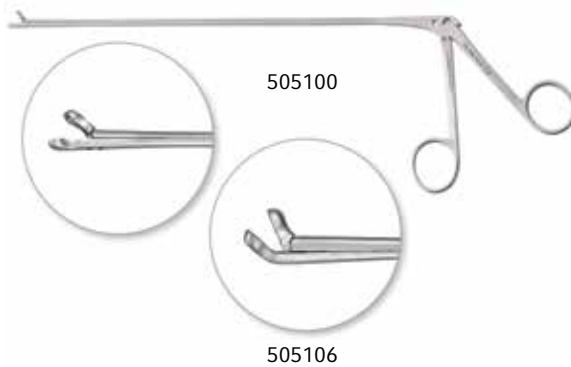

Jackson Forceps come in standard and extra lightweight construction that provides durability and strength. The jaw size, shape and angle are specially calculated for use through Jackson scopes.

CATALOG #	DESCRIPTION
505100	Straight, 4 mm diameter jaw, working length 28 cm
505102	Straight, 6 mm diameter jaw, working length 28 cm
505104	Angled, 4 mm diameter jaw, working length 28 cm
505106	Angled, 6 mm diameter jaw, working length 28 cm



INSTRUMENTATION FOR LARYNGOSCOPES

Forceps

JACKSON LARYNGEAL CUP FORCEPS - EXTRA LIGHTWEIGHT 2 MM CUPS

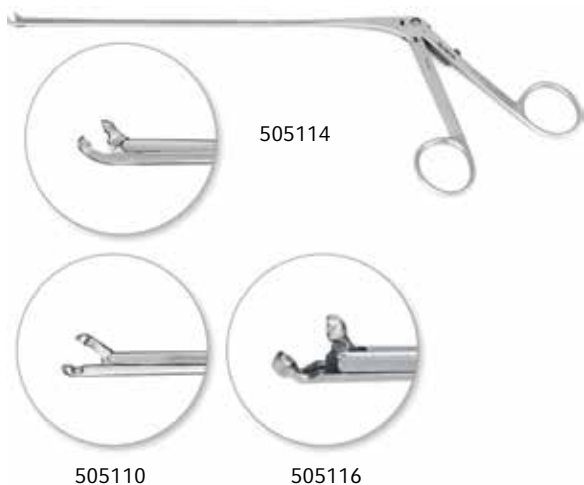

Jackson Forceps come in standard and extra lightweight construction that provides durability and strength. The jaw size, shape and angle are specially calculated for use through Jackson scopes.

CATALOG #	DESCRIPTION
505110	Straight, 2 mm diameter jaw, working length 20 cm
505112	Straight, 2 mm diameter jaw, working length 28 cm
505114	Angled, 2 mm diameter jaw, working length 20 cm
505116	Angled, 2 mm diameter jaw, working length 28 cm

JACKSON TRIANGULAR PUNCH SPECIMEN AND TISSUE FORCEPS



Shear-type forceps remove a piece of tissue approximately 3.5 x 7 mm. Will pass through laryngoscope 10 mm or larger.

CATALOG #	DESCRIPTION
505342	Angled jaws, working length 11-1/8" (28.5 cm)



INSTRUMENTATION FOR LARYNGOSCOPES

Forceps

LORE SUBGLOTTIC SPECIMEN AND TISSUE FORCEPS



Jaws angled 90 degrees upward and open to the right or left. Working length 11-1/8" (28.5 cm).

CATALOG #	DESCRIPTION
505195	Opens to right, 6 mm jaw
505196	Opens to left, 6 mm jaw

PATTERSON ELONGATED CUP BITING FORCEPS



CATALOG #	DESCRIPTION
505230	Regular, 4 mm width jaw, working length 11-1/8" (28.5 cm)

NORRIS SPONGE HOLDING FORCEPS



Bayonet-shaped, cross action forceps designed for use in mediastinoscopy. Straight distal portion of jaw is 16 cm long.

CATALOG #	DESCRIPTION
506747	13-1/8" (33 cm)

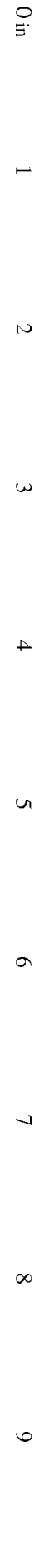

INSTRUMENTATION FOR LARYNGOSCOPES

Suction Tubes

INSULATED CAUTERY SUCTION TUBE



507045

With thumb-valve for controlled suction, 4 mm diameter, 12 Fr.

CATALOG #	DESCRIPTION
507045	Working length 8-5/8" (22 cm), supplied with a 10 ft. Bovie cord and plug (507046)
507046	10 ft. Bovie cord and plug with connection to fit insulated suction cautery tube. Cord only.

JACKSON OPEN END ASPIRATING TUBE

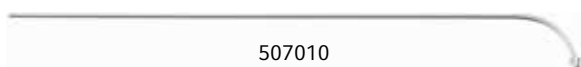

507010

Pilling® Aspirating Tubes, except in special designs, are constructed of stainless steel. They are measured in working length from distal tip to beginning of proximal curve or angle. Aspirating tubes should be 5 cm or 10 cm longer than the scope through which they are used.

CATALOG #	WORKING LENGTH	FOR USE THRU SCOPES	TUBE DIAMETER
507010	20 cm	5.0 mm or larger	4 mm (12 Fr.)

JACKSON "VELVET-EYE" ASPIRATING TUBES

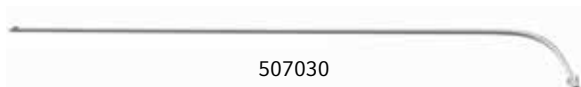

507030

These tubes have a smooth, oval-shaped opening on each side of the distal tip and a closed, blunt end.

CATALOG #	WORKING LENGTH	FOR USE THRU SCOPES	TUBE DIAMETER
507030	20 cm	5.0 mm or larger	4 mm (12 Fr.)

STRONG SUCTION IRRIGATOR

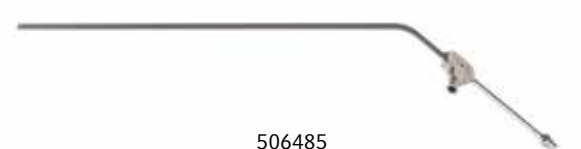

506485

For washing dyed vocal cords with saline.

CATALOG #	DESCRIPTION
506485	9" (23 cm)



INSTRUMENTATION FOR LARYNGOSCOPES

Micro-Laryngeal/Feder-Ossoff

FEDER-OSSOFF MICRO-LARYNGEAL GRASPING FORCEPS

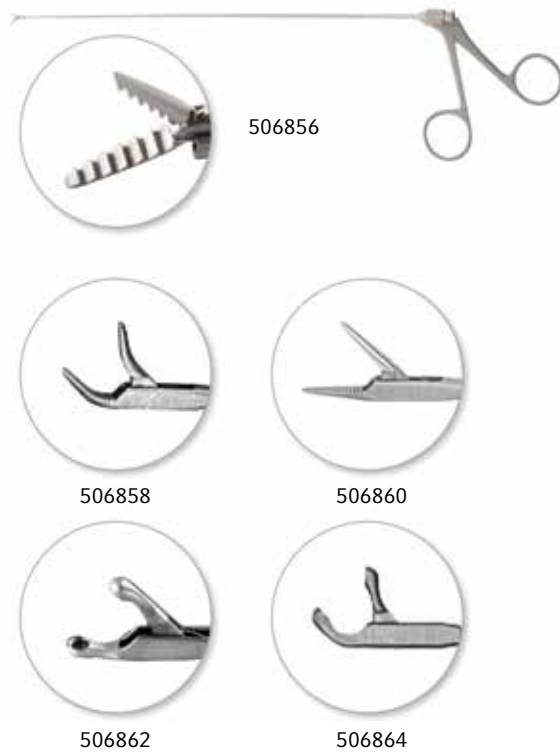

Feder-Ossoff forceps include alligator grasping and cup biopsy jaws. All forceps have a matte laser finish and shafts that taper from 2 mm to 0.5 mm.

Double-action grasping forceps have aggressive serrated jaws for better holding and a suction channel with a Luer-Lok® proximal fitting for smoke evacuation and improved visibility during laser procedures.

Grasping forceps have finely serrated jaws, 1.1 mm wide tapering to 0.6 mm, 4 mm long and a working length of 23 cm.

Delicate biopsy cup forceps have a 1 mm jaw with a working length of 23 cm.

CATALOG #	DESCRIPTION
506856	Grasping forceps, double action, straight, with suction
506858	Grasping forceps, angled up
506860	Grasping forceps, straight
506862	Cup biopsy, 1 mm, straight
506864	Cup biopsy, 1 mm, angled up

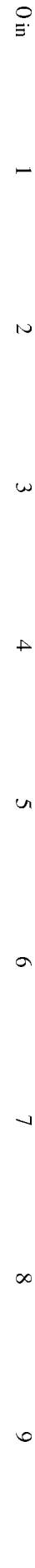

INSTRUMENTATION FOR LARYNGOSCOPES

Micro-Laryngeal/Feder-Ossoff

PILLING® FEDER-OSSOFF PHONOSURGERY SET

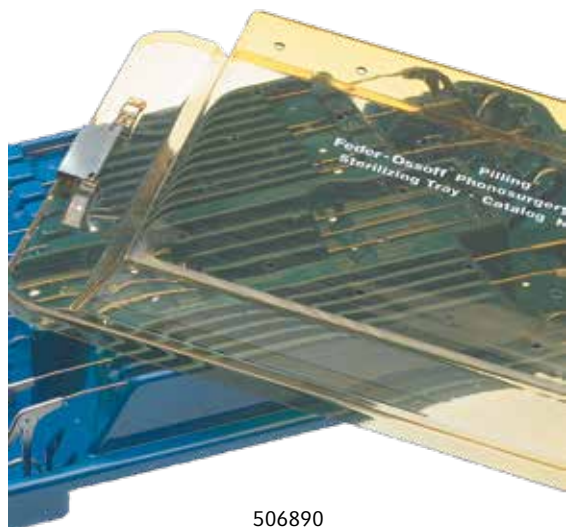

506890

Pilling® Feder-Ossoff Micro-Laryngeal Precision Instruments from Teleflex® are designed for microlaryngeal procedures to retain, restore or improve voice quality. Feder-Ossoff instruments are specially designed for phonosurgery/microflap surgery with Mayo blades on the scissors and angled handles with slender diameter shafts. Set includes 27 instruments for use in delicate mucosal microflap dissection techniques.

- Mayo blades on scissors
- Matte laser finish
- Angled handles and slender diameter shafts
- Universal ring handle for knives and probes
- 23-27 cm working length
- Durable storage and tray

CATALOG #	DESCRIPTION
506800	Feder-Ossoff Phonosurgery Set Contains 27 Instruments, 506802-506890 (pgs. 422-424)
506890	Instrument Tray 11-3/4" x 15-1/4" x 3" (38.5 x 30 x 7.5 cm) at handles



INSTRUMENTATION FOR LARYNGOSCOPES

Micro-Laryngeal/Feder-Ossoff

FEDER-OSSOFF MICRO-LARYNGEAL SCISSORS



Scissors are designed with blunt or sharp tips and come in a variety of patterns to enable easier access and better exposure. All scissors have a 23 cm working length, a 2 mm diameter shaft and a 5 degree bend at the handle for better exposure.



506802



506804



506806



506808



506810



506822



506812



506814



506816



506818



506820



506824

CATALOG #	DESCRIPTION
506802	Blunt, straight blades, vertical action
506804	Blunt, curved blades, horizontal action, open left
506806	Blunt, curved blades, horizontal action, open right
506808	Blunt, angled up, vertical action
506810	Blunt, angled down, vertical action
506822	Blunt, angled up, double action
506812	Sharp, straight blades, vertical action
506814	Sharp, curved blades, horizontal action, open left
506816	Sharp, curved blades, horizontal action, open right
506818	Sharp, angled up, vertical action
506820	Sharp, angled down, vertical action
506824	Sharp, double action

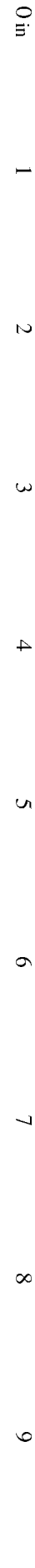

INSTRUMENTATION FOR LARYNGOSCOPES

Micro-Laryngeal/Feder-Ossoff

KNIVES AND KNIFE HANDLE

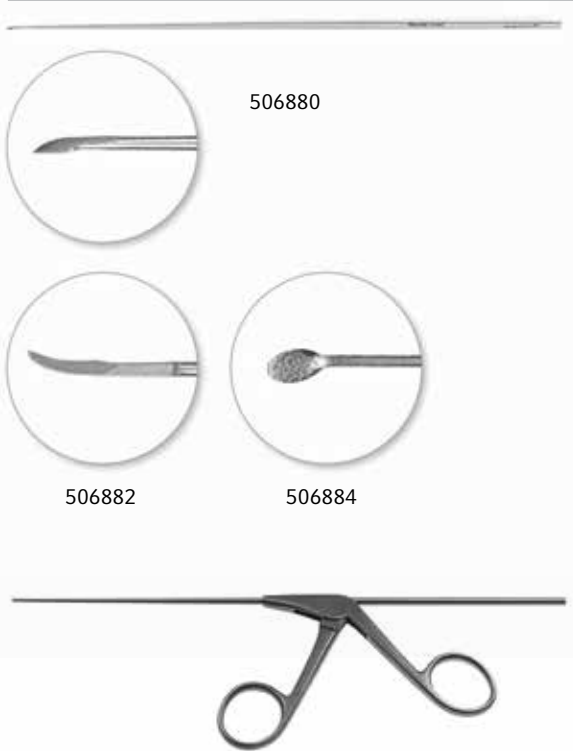

All knives have 27 cm maximum working length and a 3.2 – 1 mm tapered shaft. Working length is measured from front portion of handle to tip of instrument.

CATALOG #	DESCRIPTION
506880	Straight sickle, 3 mm blade
506882	Curved sickle, 3 mm blade
506884	Phono circle knife, 3 mm blade
506888	Universal ring handled knife handle with camlock



506888

Shown with probe inserted into handle. Knives and probes can be set to any angle or depth relative to the handle.

PROBE/ELEVATORS

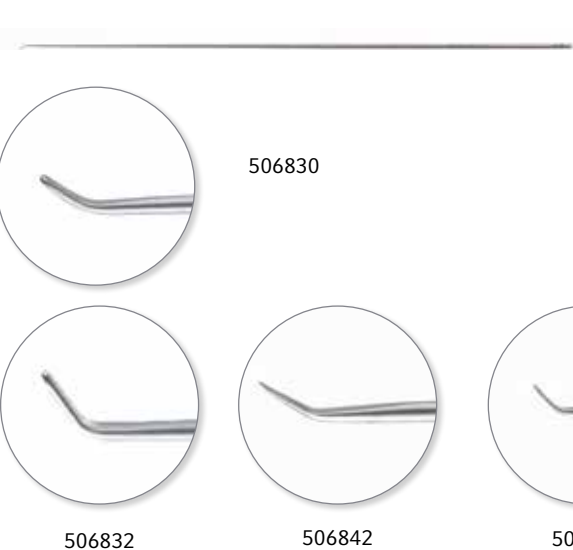

These probe/elevators allow for sharp and blunt dissection and elevating of tissue. All probes fit into the Camlock Handle (506888). 27 cm working length.

CATALOG #	DESCRIPTION
506830	30 degree angle, blunt
506832	60 degree angle, blunt
506842	30 degree angle, sharp
506844	60 degree angle, sharp

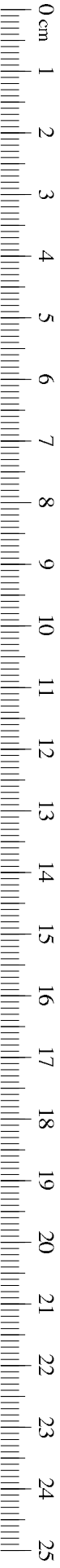

INSTRUMENTATION FOR LARYNGOSCOPES

Micro-Laryngeal/Feder-Ossoff

SUCTIONS

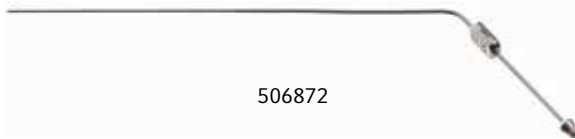

23 cm working length with thumb control, laser finish.

CATALOG #	DESCRIPTION
506870	3 Fr. diameter
506872	5 Fr. diameter
506874	7 Fr. diameter

FEDER-OSSOFF PHONOSURGERY INSTRUMENT TRAY



Has individual instrument housing. The tray is a durable construction, protecting the delicate instruments. This tray may be stacked for storage.

CATALOG #	DESCRIPTION
506890	Inside dimensions: 11-3/4" x 15-1/4" x 3" (30 x 38.5 x 7.5 cm) at handles

506890

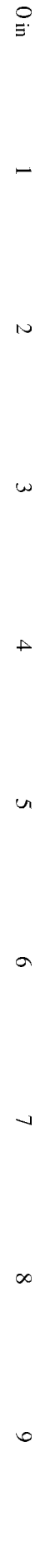

INSTRUMENTATION FOR LARYNGOSCOPES

Micro-Laryngeal/Feder-Ossoff

MICRO-LARYNGEAL FORCEPS



The serrated triangular jaw allows for a larger surface area of tissue to be grasped within the 3 mm wide tips. These forceps have a 23 cm working length and a non-reflective finish for use with lasers. Jaws are uniquely angled and fenestrated to better grasp along the longitudinal surface of the respective cord, 2.75 mm wide triangular jaw, serrated jaw, 2 mm shaft. Fits adult laryngoscopes without interfering with microscope, 5 degree bend at the handle. Non-reflective finish; can be used in laser surgery.

CATALOG #	DESCRIPTION
506950	Triangular fenestrated, serrated jaw forceps, right, working length 9-1/4" (23.5 cm)
506952	Triangular fenestrated, serrated jaw forceps, left, working length 9-1/4" (23.5 cm)

Micro-Laryngeal/Jako-Kleinsasser

JAKO-KLEINSASSER MICRO-LARYNGEAL CUP FORCEPS (MOST COMMON & ESSENTIAL)



These Pilling® Micro-Laryngeal Cup Forceps were designed specifically for everyday-use micro-surgery. They feature slender 2 mm diameter stems with miniature distal jaws in the shape of cup forceps and are made of dull finished stainless steel to reduce glare. Stems are angulated (5 degree bend at handle) for unobstructed vision and all have a 22 cm working length.

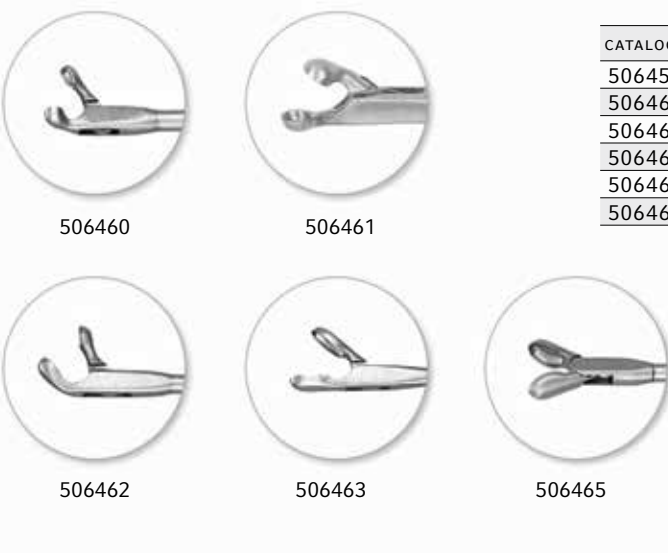

CATALOG #	DESCRIPTION
506455	Straight
506460	Angled left
506461	Angled right
506462	Angled up
506463	Oval, single action
506465	Straight oval



INSTRUMENTATION FOR LARYNGOSCOPES

Micro-Laryngeal/Jako-Kleinsasser

JAKO-KLEINSASSER MICRO-LARYNGEAL GRASPING FORCEPS

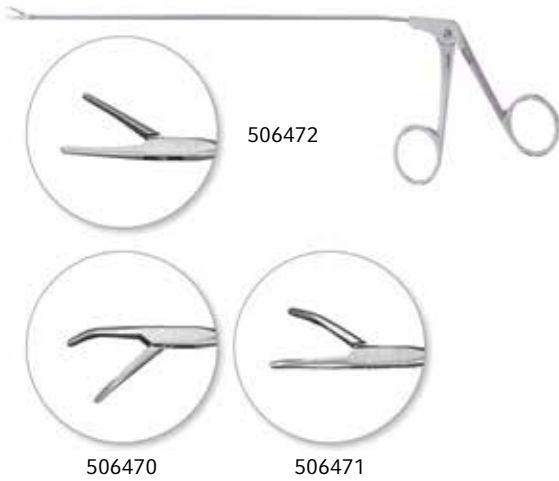

These Pilling® Micro-Laryngeal Grasping Forceps were designed specifically for everyday-use micro-surgery. They feature slender 2 mm diameter stems with miniature distal jaws in the shape of grasping forceps and are made of dull finished stainless steel to reduce glare. Stems are angulated (5 degree bend at handle) for unobstructed vision and all have a 22 cm working length.

CATALOG #	DESCRIPTION
506470	Curved left
506471	Curved right
506472	Straight, very fine serrated

JAKO-KLEINSASSER MICRO-LARYNGEAL SCISSORS

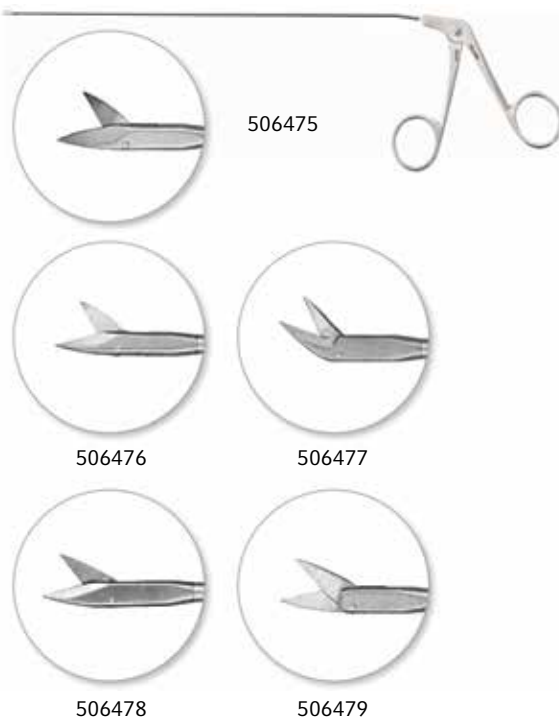

These Pilling® Micro-Laryngeal Scissors were designed specifically for everyday-use micro-surgery. They feature slender 2 mm diameter stems with miniature distal jaws in the shape of scissors and are made of dull finished stainless steel to reduce glare. Stems are angulated (5 degree bend at handle) for unobstructed vision and all have a 22 cm working length.

CATALOG #	DESCRIPTION
506475	Curved left
506476	Curved right
506477	Angled up
506478	Straight, vertical
506479	Straight, horizontal

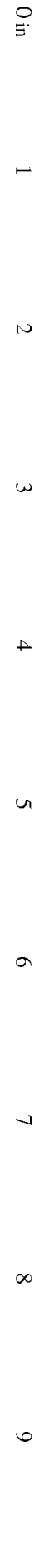

INSTRUMENTATION FOR LARYNGOSCOPES

Micro-Laryngeal/Jako

JACKSON LARYNGEAL SCISSORS

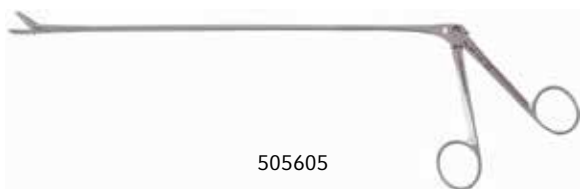

CATALOG #	DESCRIPTION
505605	Straight, 7-7/8" (20 cm) long blades, working length 11-1/8" (28.5 cm)

JAKO COAGULATION PROBE



Will fit standard Bovie Pencil Handle.

CATALOG #	DESCRIPTION
506672	Working length 8-1/4" (21 cm)

JAKO FINE BALL TIP HOOK

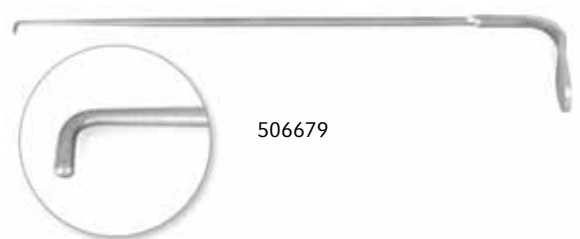

CATALOG #	DESCRIPTION
506679	Right angle, 9" (23 cm)



INSTRUMENTATION FOR LARYNGOSCOPES

Micro-Laryngeal/Jako

JAKO MIRROR

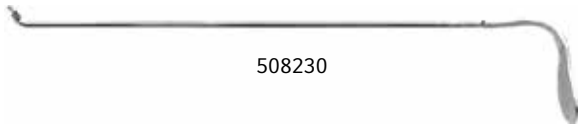

For minor examination of the undersurface of the vocal cords.

CATALOG #	DESCRIPTION
508230	Working length 8-1/4" (21 cm)

JAKO SICKLE KNIFE

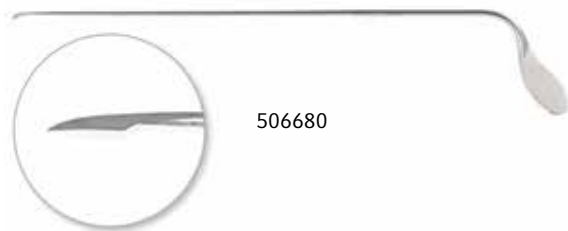

CATALOG #	DESCRIPTION
506680	10-1/4" (26 cm)

JAKO FINE SUCTION TUBES

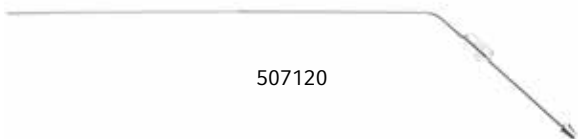

Specially designed with thumb control.

CATALOG #	DESCRIPTION
507120	No. 00, 5 Fr., 23 cm working length
507121	No. 0, 6 Fr., 23 cm working length
507122	No. 1, 7 Fr., 23 cm working length

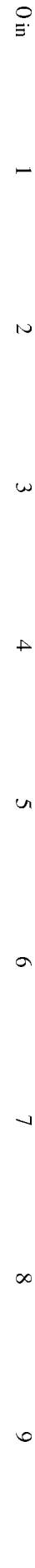

INSTRUMENTATION FOR LARYNGOSCOPES

Micro-Laryngeal/Jako

JAKO RIGID STEM INSTRUMENTS

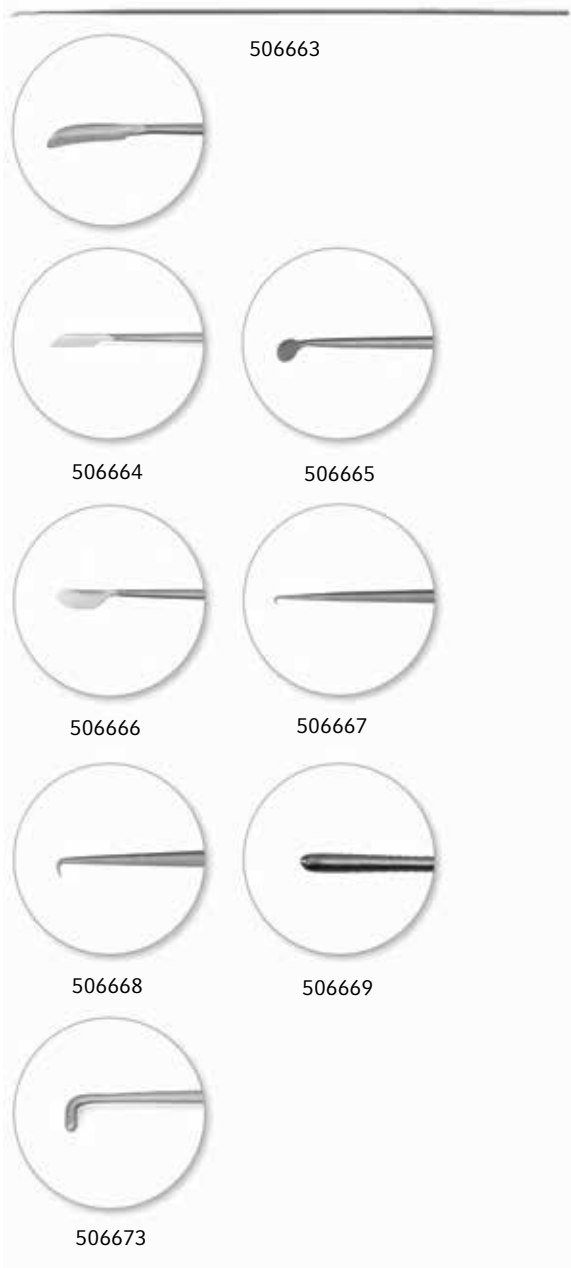

Dull finish to reduce glare. May be used with 506888 Feder-Ossoff Universal Ring Handled Knife Handle (pg. 425). Working length 26 cm.

CATALOG #	DESCRIPTION
506663	Jako Sickle Knife, curved
506664	Jako Sickle Knife, straight
506665	Jako Circle Knife
506666	Jako Round Edge Knife
506667	Jako Sharp Hook, slight
506668	Jako Sharp Hook, acute
506669	Jako Probe, straight
506673	Jako Blunt Angled Probe



Shown with probe inserted into handle. Knives and probes can be set to any angle or depth relative to the handle.

INSTRUMENTATION FOR LARYNGOSCOPES

Laser Instrumentation

ANGLED LASER RETRACTORS

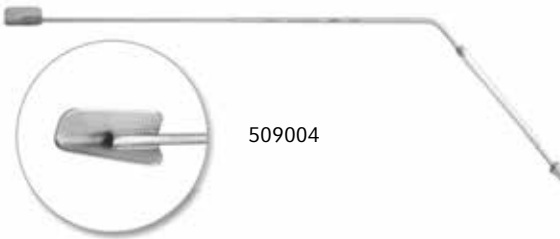

For protection of the anterior commissure and the evacuation of smoke and plume during laser surgery. Non-reflective finish on shaft. 23 cm working length.

CATALOG #	DESCRIPTION
509004	Adult, right, 8 mm diameter
509005	Adult, left, 8 mm diameter
509006	Pediatric, right, 4 mm diameter
509007	Pediatric, left, 4 mm diameter

LASER SPATULA RETRACTORS

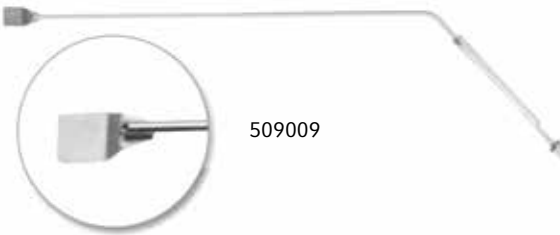

For protection/retraction of the vocal cords and for the evacuation of smoke and plume during laser surgery. 23 cm working length. Non-reflective finish on shaft.

CATALOG #	DESCRIPTION
509008	Adult, right, 10 mm diameter
509009	Adult, left, 10 mm diameter
509010	Pediatric, right, 5mm diameter

LASER OPERATING PLATFORM - EBONIZED

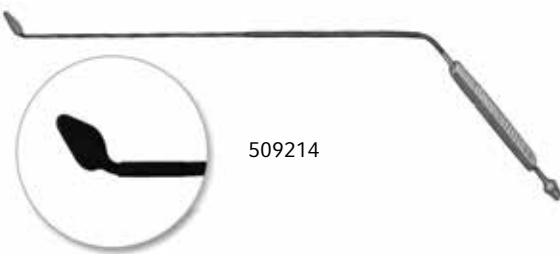

The platform is inserted into the subglottic larynx above the level of the packed cottonoids. The platform helps to protect the cottonoids, endotracheal tube and cuff, and tissues of the subglottic larynx from any direct or reflected laser beam radiation. Shaft and tip are ebonized. 21 cm working length.

CATALOG #	DESCRIPTION
509214	4 mm diameter platform
509215	6 mm diameter platform
509216	8 mm diameter platform



INSTRUMENTATION FOR LARYNGOSCOPES

Laser Instrumentation

ASPIRATING TUBES



For removal of smoke and steam created during laser surgery. 3 mm diameter (9 Fr.).

CATALOG #	DESCRIPTION
509012	"Velvet-eye"-type, working length 7-7/8" (20 cm)
509013	Open end, working length 6" (15 cm)
509014	Clip for attaching aspirating tubes to laryngoscope up to 9 Fr. (3 mm)



INSTRUMENTATION FOR LARYNGOSCOPES

Laser Instrumentation

MICROSUBGLOTTIC INSTRUMENTS

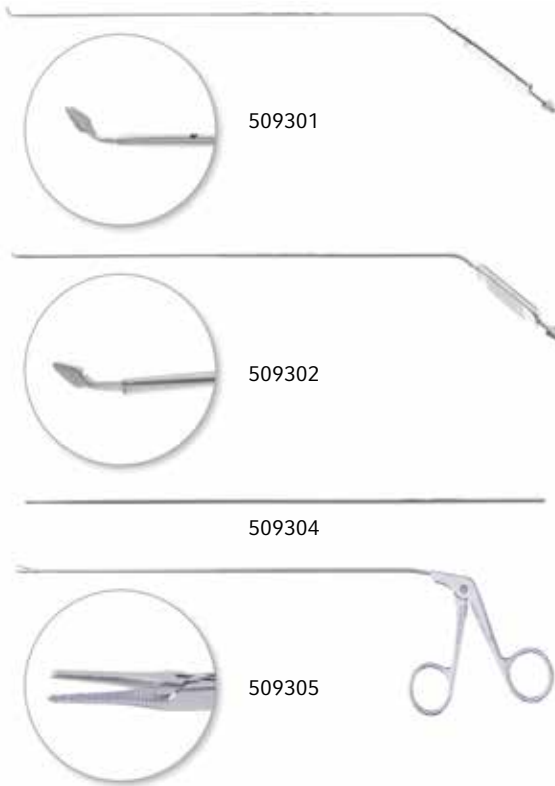

Designed for laser microsurgery of the entire subglottic space and upper cervical trachea, this instrumentation includes forceps, probe, mirror and platform (all 28 cm in length and laser finished).

CATALOG #	DESCRIPTION
509301	Operating platform, 3 mm
509302	Front surface mirror, 3 mm
509304	Straight probe
509305	Grasping forceps, straight

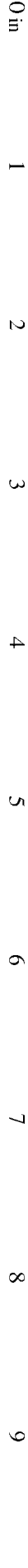

INSTRUMENTATION FOR LARYNGOSCOPES

Laser Instrumentation

MICRO-LARYNGEAL PROBES - EBONIZED

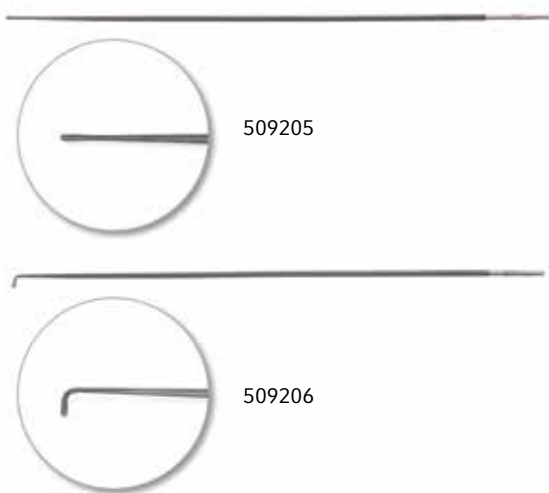

CATALOG #	DESCRIPTION
509205	Straight, ebonized, 10-1/4" (26 cm)
509206	Angled, ebonized, 10" (25.5 cm)

OSSOFF-KARLAN GRASPING FORCEPS - EBONIZED

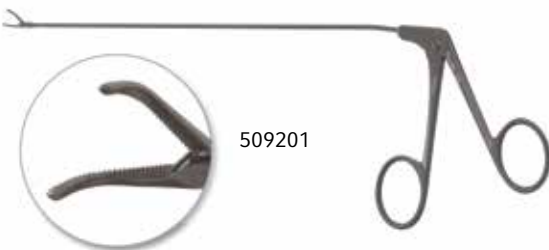

CATALOG #	DESCRIPTION
509201	Curved left, ebonized, working length 8-1/4" (21 cm)
509202	Curved right, ebonized, working length 8-1/4" (21 cm)
509203	Straight, ebonized, working length 8-1/4" (21 cm)

OSSOFF-KARLAN MICRO SUCTION TUBE - EBONIZED

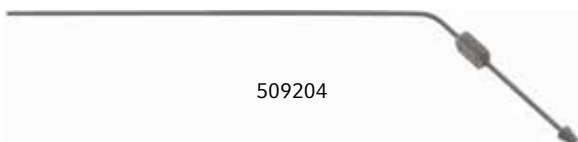

CATALOG #	DESCRIPTION
509204	7 Fr., ebonized, working length 7-1/2" (19 cm)

INSTRUMENTATION FOR LARYNGOSCOPES

Laser Instrumentation

OSSOFF-KARLAN VOCAL CORD ROLLER - EBONIZED



509207

This instrument was designed to facilitate greater direct exposure of the infraglottic surface of the true vocal cords.

CATALOG #	DESCRIPTION
509207	Ebonized, 8-1/4" (21 cm)

Miscellaneous

HOLINGER LARYNGEAL DISSECTOR



506707

CATALOG #	DESCRIPTION
506707	12" (30.5 cm)

HOLINGER KNIFE HANDLE



506705

For use with surgical blades no. 10, 11, 12 and 15.

CATALOG #	DESCRIPTION
506705	11" (28 cm)

JACKSON STANDARD SPONGE CARRIER



506750

For use through laryngoscopes and bronchoscopes. Heavy construction weight. Stainless steel.

CATALOG #	DESCRIPTION
506750	Working length 11-3/4" (30 cm)
506752	Working length 15-3/4" (40 cm)

JAKO FINE SPONGE CARRIER

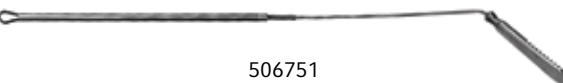

506751

To hold small piece of sponge rubber used to dye vocal cords for diagnostic purposes.

CATALOG #	DESCRIPTION
506751	Working length 10-1/4" (26 cm)



INSTRUMENTATION FOR LARYNGOSCOPES

Miscellaneous

ABRAHAM LARYNGEAL SYRINGE CANNULA



507434

For use on Luer-Lok® syringes.

CATALOG #	DESCRIPTION
507434	Malleable, 5-7/8" (15 cm)

BONNIER CATHETER ADAPTER



507335

For attachment of catheters to Luer tip syringes.

CATALOG #	DESCRIPTION
507335	1-3/8" (3.5 cm)

LUER-LOK® CATHETER ADAPTER



507336

For attachment of catheters to Luer-Lok® syringes.

CATALOG #	DESCRIPTION
507336	1-1/2" (4 cm)

CENTIMETER SUBTRACTION RULER



504075

For accurate calculation by subtraction of the depth to which a scope has been inserted.

CATALOG #	DESCRIPTION
504075	30 cm



INSTRUMENTATION FOR LARYNGOSCOPES

Miscellaneous

LARYNGEAL MICRO ATOMIZER



Permits use of very small quantities of solution. Very fine particle size. Double valve in bulb permits sustained, very effective spray.

CATALOG #	DESCRIPTION
507485S	Complete Micro Atomizer (nos. 151 and 1-RD)
507267S	Atomizer glass collection tube, small no. 151
507498S	Atomizer replacement rubber bulb, small no. 1-RD

Laryngeal Mirrors

LARYNGEAL MIRRORS



Extra thin, permanently mounted on handle. Shaft length is 6-3/4" (17 cm).

CATALOG #	DESCRIPTION
508200	#000, 8 mm diameter
508201	#00, 10 mm diameter
508202	#0, 12 mm diameter
508203	#1, 16 mm diameter
508204	#2, 18 mm diameter
508205	#3, 20 mm diameter
508206	#4, 22 mm diameter
508207	#5, 24 mm diameter
508208	#6, 28 mm diameter
508209	#7, 30 mm diameter



PILLING® BRONCHOSCOPES



Pilling® Bronchoscopes are designed in conjunction with Dr. Paul Holinger and Dr. C.L. Jackson for ease in examination and performance of surgical procedures in the lung and bronchi. These instruments use fiberoptics

to provide cool, constant illumination and nearly full lumen view. Each type of scope is designed with channels to ventilate the patient during the procedure.

PILLING® BRONCHOSCOPE AND LASER BRONCHOSCOPE PATIENT SIZE LISTING

CATALOG #	PRODUCT NAME	CATALOG #	PRODUCT NAME
NEONATE/INFANT BRONCHOSCOPES		ADOLESCENT BRONCHOSCOPES	
522575	Holinger	522579	Holinger
522576	Holinger	522580	Holinger
522550	Pilling® Improved Holinger	522581	Holinger
522552	Pilling® Improved Holinger	522582	Holinger
CHILD/PEDIATRIC BRONCHOSCOPES		522583	Holinger
522554	Pilling® Improved Holinger	ADOLESCENT LASER BRONCHOSCOPES	
522556	Pilling® Improved Holinger	523120P	Pilling® CO ₂
522576	Holinger	523130P	Pilling® CO ₂
522577	Holinger	523176	Pilling® YAG
523578	Holinger	ADULT BRONCHOSCOPES	
		522584	Holinger
		522585	Holinger
		522586	Holinger
		522587	Holinger
		ADULT LASER BRONCHOSCOPES	
		523140P	Pilling® CO ₂
		523150P	Pilling® CO ₂
		523160P	Pilling® CO ₂



BRONCHOSCOPES

Holinger Design

HOLINGER VENTILATING FIBEROPTIC BRONCHOSCOPE

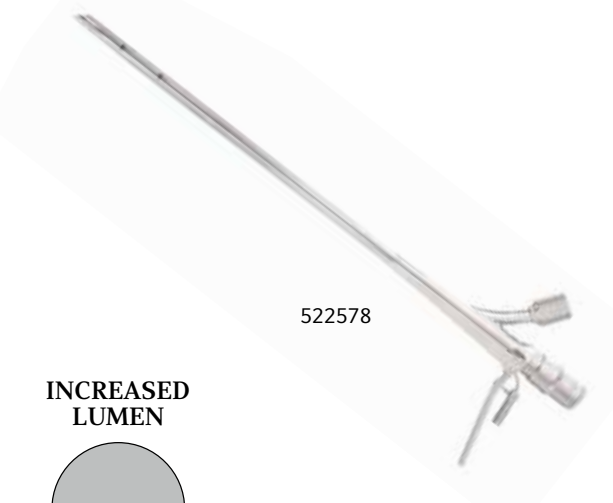

Designed by Dr. Paul Holinger, these fiberoptic bronchoscopes provide a nearly full view of the lumen with constant, cool illumination. Special features include:

- 15 mm sidearm for direct attachment of ventilation and anesthesia apparatus.
- Large fiber bundle for increased distal illumination.
- Oval fiber optic light carrier, which allows more viewing and instrumentation room in main tube.
- 15 mm diameter proximal end for attachment of accessories (window plug, Sanders Venturi, etc.).
- Smooth distal tip.
- Shortened proximal flare.
- Each Holinger Bronchoscope is supplied with one light carrier and one window plug (522595).
- Blue fiber optic cable sold separately (see pg. 467).

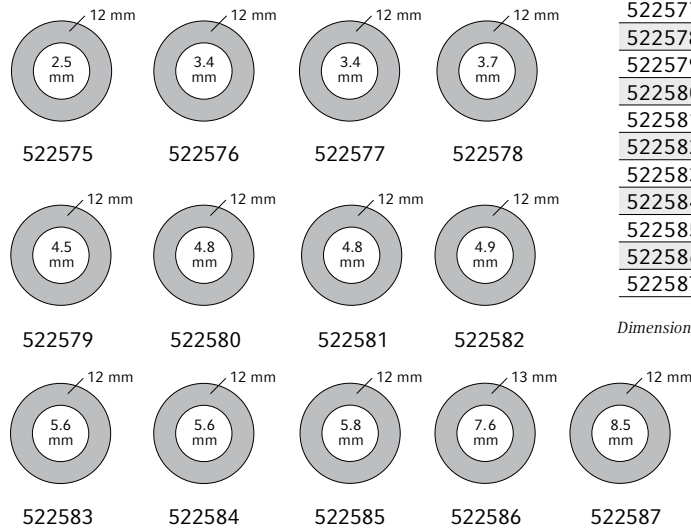
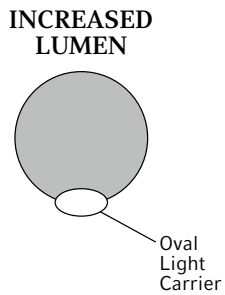

CATALOG #	SCOPE SIZE	OVERALL LENGTH	MIN I.D.	NOMINAL PROXIMAL I.D.	MAX O.D.	REPLACE CARRIER
522575	3 x 20	203 mm	2.5 mm	12.0 mm	9.4 mm	527500
522576	3.5 x 25	254 mm	3.4 mm	12.0 mm	12.0 mm	527505
522577	3.5 x 30	305 mm	3.4 mm	12.0 mm	12.0 mm	527510
522578	4 x 30	305 mm	3.7 mm	12.0 mm	12.0 mm	527510
522579	5 x 30	305 mm	4.5 mm	12.0 mm	12.5 mm	527510
522580	5 x 35	350 mm	4.8 mm	12.0 mm	12.5 mm	527515
522581	5 x 40	400 mm	4.8 mm	12.0 mm	12.5 mm	527520
522582	5 x 45	451 mm	4.9 mm	12.0 mm	12.0 mm	527525
522583	6 x 35	350 mm	5.6 mm	12.0 mm	12.0 mm	527555
522584	6 x 40	400 mm	5.6 mm	12.0 mm	13.0 mm	527560
522585	7 x 40	400 mm	5.8 mm	12.0 mm	15.3 mm	527560
522586	8 x 40	400 mm	7.6 mm	13.0 mm	15.4 mm	527580
522587	9 x 40	400 mm	8.5 mm	12.0 mm	16.4 mm	527580

Dimensions without window plug.

Drawings illustrate Nominal Proximal Internal Dimensions and Minimum Internal Diameter (I.D.), NOT TO SCALE.



BRONCHOSCOPES

Holinger Pediatric Design

PILLING® IMPROVED HOLINGER VENTILATING FIBEROPTIC BRONCHOSCOPES

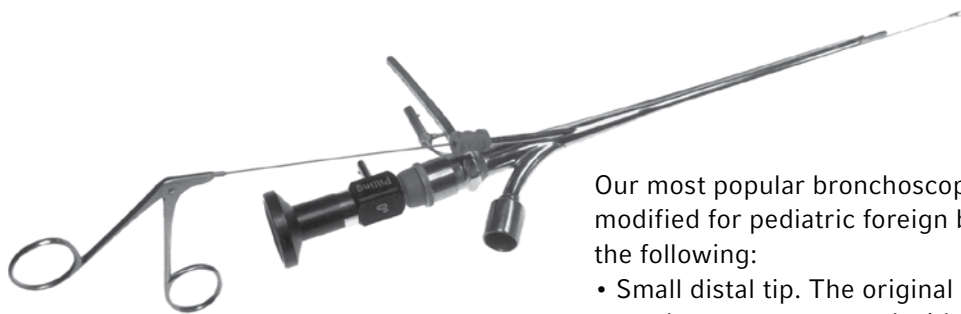

Our most popular bronchoscope, the Holinger, has been modified for pediatric foreign body removal and features the following:

- Small distal tip. The original Holinger tip has been cut down to correspond with tube size, while still retaining smoothness.
- Built-in instrument channel for introduction of flexible forceps or disposable suction.
- Full lumen view. The oval fiberoptic light carrier has been raised slightly to provide a full lumen and give more room for instrumentation and a larger viewing area.
- 15 mm sidearm attachment allows direct attachment of ventilation and anesthesia apparatus.

Each Pilling® Improved Holinger Bronchoscope is supplied with one light carrier, one window plug (522595) and instrument guide rubber cap. Blue fiber optic cable sold separately (see pg. 467).

- 524022 Telescope 2.7 mm, 0°
- 524036 Telescope Guide 2.7 mm
- 522552 Improved Holinger Bronchoscope 3.5 x 20
- 505670 Flexible 1 mm Alligator Forceps

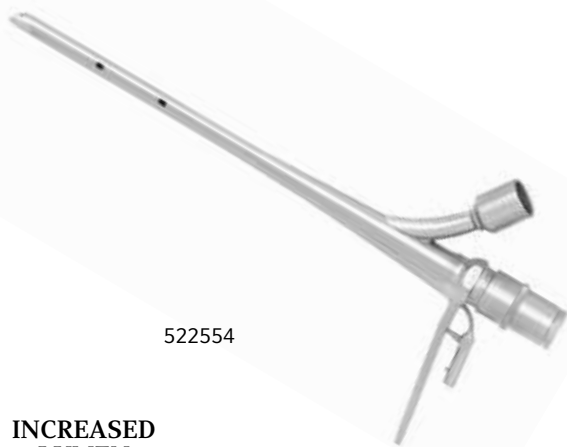

522554

INCREASED LUMEN

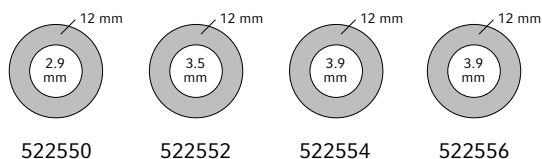
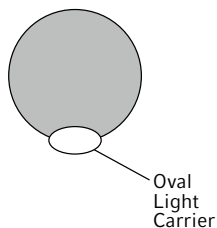

CATALOG #	SCOPE SIZE	OVERALL LENGTH	MIN I.D.	NOMINAL PROXIMAL I.D.	MAX O.D.	REPLACE CARRIER
522550	3 x 20	203 mm	2.9 mm	12.0 mm	9.0 mm	527500
522552	3.5 x 20	203 mm	3.5 mm	12.0 mm	12.0 mm	527500
522554	4 x 20	203 mm	3.9 mm	12.0 mm	12.0 mm	527500
522556	4 x 25	254 mm	3.9 mm	12.0 mm	11.0 mm	527505

Dimensions without window plug.

NOTE: The light carrier can be removed from the Improved Holinger Bronchoscope and forceps introduced through the light carrier channel with the 2.7 mm telescope in place (telescope may have to be partially withdrawn in 522550 and 522552 scopes).

Drawings illustrate Nominal Proximal Internal Dimensions and Minimum Internal Diameter (I.D.), NOT TO SCALE.



BRONCHOSCOPES

Laser Bronchoscopes

PILLING® BRONCHOSCOPE SYSTEM

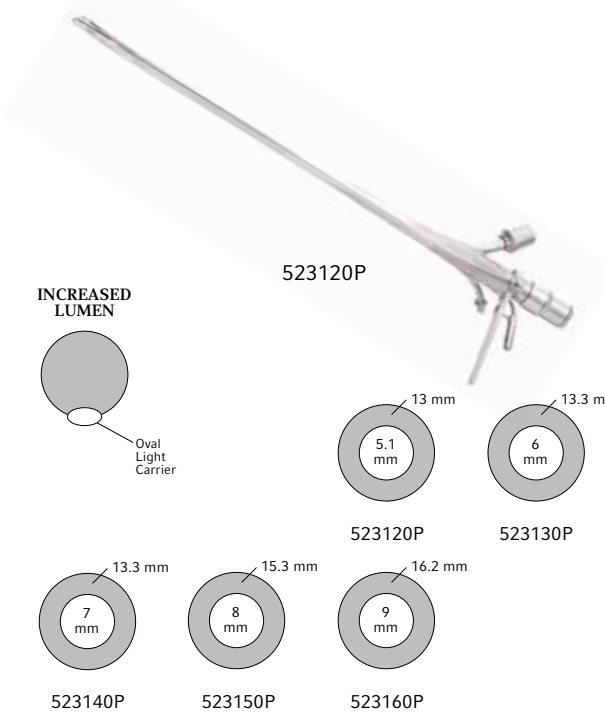

Drawings illustrate Nominal Proximal Internal Dimensions and Minimum Internal Diameter (I.D.), NOT TO SCALE.

- Pilling®, Holinger-type Bronchoscope with window plug.
- Standard 15 mm anesthesia ventilating arm.
- Dedicated, distally-delivered YAG or suction channel.
- Dedicated, distally-opened smoke evacuation channel.
- Enlarged, oval fiberoptic, distal light carrier. One supplied with each scope.
- Five sizes of CO₂ bronchoscopes available.
- Can be used with CO₂ laser.
- Side ports can be used for flexible instrumentation.
- Blue fiber optic cable sold separately (see pg. 467).

CATALOG #	SCOPE SIZE	OVERALL LENGTH	MIN I.D.	NOMINAL PROXIMAL I.D.	MAX O.D.	REPLACE CARRIER
523120P	5.0 x 30	300 mm	5.1 mm	13.0 mm	13.0 mm	527550
523130P	6.0 x 35	350 mm	6.0 mm	13.3 mm	13.3 mm	523131
523140P	7.0 x 40	400 mm	7.0 mm	13.3 mm	13.3 mm	527580
523150P	8.0 x 40	400 mm	8.0 mm	15.3 mm	15.3 mm	527580
523160P	9.0 x 40	400 mm	9.0 mm	16.2 mm	16.2 mm	527580
524042	Replaceable rubber cap for Forceps/Suction Channel					

MOISTURE BARRIER FOR CO₂ COUPLER-MANIPULATOR



CATALOG #	DESCRIPTION
523210P	To be used with the Pilling® CO ₂ Coupler-Manipulator 523200P

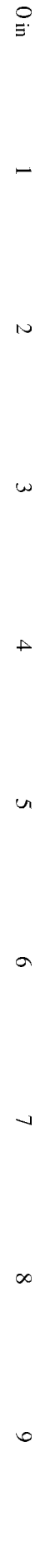

BRONCHOSCOPES

Bronchoscope Accessories

BRONCHOSCOPE ADAPTER



522590

Converts older Jackson and Holinger Bronchoscopes with 11 mm oxygen connector to standard 15 mm anesthesia and positive pressure connector.

CATALOG #	DESCRIPTION
522590	Bronchoscope Ventilating Adapter, 3/4" (2 cm)

FLUVOG SLIDE ATTACHMENT FOR PILLING® BRONCHOSCOPES



502540

For use on bronchoscopes with the 15 mm proximal extension. Provides "closed system" bronchoscopes with the use of instrumentation.

CATALOG #	DESCRIPTION
502540	Tapered fit for easy attachment or removal

BRONCHOSCOPE WINDOW PLUG REPLACEMENT LENS

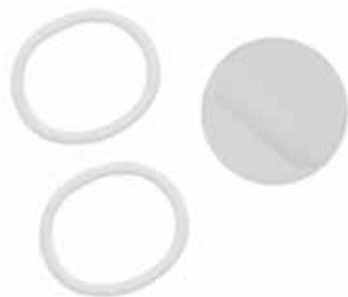

522596

CATALOG #	DESCRIPTION
522596	Replacement kit for Bronchoscope window plug, consists of lens and two Teflon seals

WINDOW PLUG



522595

Fits 15 mm proximal extension of Holinger and Jackson Bronchoscopes and Esophagoscopes. Provides a "closed system" for anesthesia in bronchoscopy or inflation during esophagoscopy.

CATALOG #	DESCRIPTION
522595	Window plug, 1-1/8" (3 cm)



TELESCOPES AND ACCESSORIES

TELESCOPE GUIDES



524037

Fits the proximal end of bronchoscopes and esophagoscopes to hold telescope in place. Not supplied with bronchoscopes or esophagoscopes.

CATALOG #	DESCRIPTION
524036	For 2.7 mm telescopes, fits 15 mm proximal end of bronchoscopes or esophagoscopes
524037	For 4.0 mm telescopes, fits 15 mm proximal end of bronchoscopes or Jackson Esophagoscope
524038	For 5.5 mm telescopes, fits 15 mm proximal end of bronchoscopes or esophagoscopes

REPLACEMENT TELESCOPE GUIDE SILICONE CAPS



524040

CATALOG #	DESCRIPTION
524039	For 2.7 mm telescope, 524036, 5 per pack
524040	For 4.0 mm telescope, 524037, 5 per pack
524041	For 5.5 mm telescope, 524038, 5 per pack

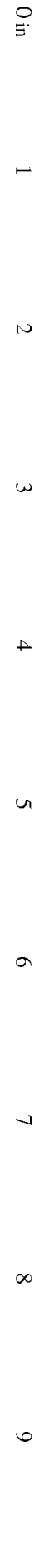

TELESCOPES AND ACCESSORIES

TELESCOPE LOCKING DEVICE



524044

Designed to hold telescopes at a maximum desired depth against our telescope guide, or to lock telescope into a competitive telescope bridge system. The serrated knob is tightened to hold the telescope.

CATALOG #	DESCRIPTION
524044	Telescope locking device, 4.0 mm
524045	Telescope locking device, 5.5 mm

REPLACEMENT GUIDE SILICONE CAPS



524042

For Improved Holinger Bronchoscopes. Use with flexible instruments.

CATALOG #	DESCRIPTION
524042	Guide silicone caps, 5 per pack, 1/2" (1.5 cm)

PILLING® TELESCOPES WITH FIBEROPTIC ILLUMINATION

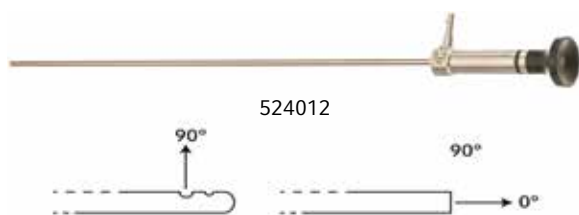

524012

The rod lens design of Pilling® Telescopes provides excellent color retention, light transmission, resolution and reduced distortion. The modular construction permits quick repair. Pilling® Fiber Optic Telescopes use the same cables as Pilling® Bronchoscopes and Esophagoscopes.

CATALOG #	DESCRIPTION
524022	2.7 mm telescope, 0 degrees straight forward, 34 cm overall length
524012	4.0 mm telescope, 0 degrees straight forward, 39 cm overall length
524050	4.0 mm telescope, 0 degrees straight forward, 45 cm
524010	5.5 mm telescope, 90 degrees lateral, 49 cm overall length

PILLING® RIGID ENDOSCOPE/ TELESCOPE COMPATIBILITY CHART

Lengths of All Endoscopes

BOXES WITH ENTRIES = ENDOSCOPE SIZES AVAILABLE

SMALLEST DIAMETER OF ENDOSCOPE	20 CM	22 CM	25 CM	29 CM	30 CM	32 CM	35 CM	40 CM	42 CM	45 CM	50 CM
3.0 mm					B						
3.5 mm			B		B						
4.0 mm			B		B						
5.0 mm					B C		C D (B)	D (C)		(D)	
6.0 mm					B C	B C	C D (B)	D F (C)		F (D)	
6.5 mm							C D (B)				
7.0 mm		B	B		B C			D F (C)	DF	F (D)	
8.0 mm								D F (C)		F (D)	
9.0 mm		B	B		B C			D F (C)		F (D)	
10.0 mm				B C	B C			D F (C)			
12.0 mm							C D (B)			F (D)	

KEY TO CHART

- Letters:** Represents compatible telescope sizes for that size endoscope. Similar diameter telescope letters have been grouped together, in increasing length order.
- (Letters):** While the telescope does not extend past the endoscope, a 0° telescope will provide an adequate view.

B	524022	0°	Straight Forward	2.7 mm Telescope	34 cm
C	524012	0°	Straight Forward	4.0 mm Telescope	39 cm
D	524050	0°	Straight Forward	4.0 mm Telescope	45 cm
F	524010	90°	Lateral Rt. Angle	5.5 mm Telescope	49 cm

OPTIONAL ACCESSORIES AVAILABLE

The Telescope Locking Device is an optional accessory that slides onto the shaft of the Telescope and can be twist tightened at any place along the length of the shaft of the Telescope as a stop against the Telescope Guide. This will keep the Telescope inside the bronchoscope, permitting insertion under direct telescopic vision and lessening the chance of breakage, perforation or getting mucous or blood on the lens. The lock also fits into the twist locking system of the Storz Bronchoscope Bridge System, permitting the use of Pilling® Telescopes in these competitive bronchoscopes.

For 2.7 mm Telescope:	524036 Telescope Guide
For 4.0 mm Telescope:	524037 Telescope Guide 524044 Locking Device
For 5.5 mm Telescope:	524038 Telescope Guide 524045 Locking Device

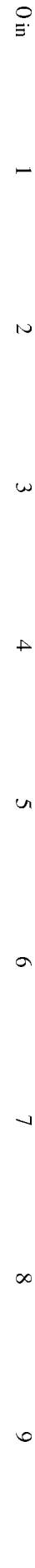

BRONCHOSCOPES

Cleaning Brushes

HOLMAN SCOPE BRUSHES

For loosening hardened secretions not freed by washing.

CATALOG #	DESCRIPTION
508540	Set of three: small, medium, large
508541	Brush for large scopes, 15 mm x 62 cm
508542	Brush for medium scopes, 11 mm x 56 cm
508543	Brush for small scopes, 9 mm x 49 cm
508544	Special extra-small brush for infant scopes, 6 mm x 46 cm



508540



PILLING® ESOPHAGOSCOPES



The Pilling® Esophagoscopes have been designed in conjunction with the innovators in esophageal surgery for examination, diagnostic procedures and removal of foreign bodies in the

esophagus. These fiberoptic scopes have been designed for ease of insertion. A variety of sizes and configurations are offered to meet the patient’s specific needs.

PILLING® ESOPHAGOSCOPE PATIENT SIZE LISTING

CATALOG #	PRODUCT NAME	CATALOG #	PRODUCT NAME
NEONATE/INFANT ESOPHAGOSCOPES		ADULT ESOPHAGOSCOPES	
523570	Holinger	523602	Jackson
523505	Holinger Speculum	523604	Jackson
CHILD/PEDIATRIC ESOPHAGOSCOPES		523608	Jackson
523600P	Jackson	523610P	Jackson
523602	Jackson	523612	Jackson
523650P	Jesberg	523614	Jackson
523652	Jesberg	523656	Jesberg
523640	Pillsbury-Jesberg	523658	Jesberg
523642	Pillsbury-Jesberg	523660P	Jesberg
523571	Holinger	523646	Pillsbury-Jesberg
523572	Holinger	523648	Pillsbury-Jesberg
523675	Forbes	523649	Pillsbury-Jesberg
ADOLESCENT ESOPHAGOSCOPES		523577	Holinger
523654	Jesberg	523579	Holinger
523644	Pillsbury-Jesberg	523581	Holinger
523573	Holinger	523582	Holinger
523574	Holinger	523677	Forbes
523575	Holinger		



ESOPHAGOSCOPES

Pillsbury-Jesberg Design

NEW PILLSBURY-JESBERG ESOPHAGOSCOPES



The Pillsbury-Jesberg Esophagoscopes were designed with the light carrier fully incorporated into the textured handle. With this improved design, there is built-in protection for the light carrier during normal handling. The barrel and tip of the scope follow the familiar Jesberg design, facilitating gentle insertion while maintaining usual technique. Supplied with one light carrier. Blue fiber optic cable sold separately (see pg. 467).

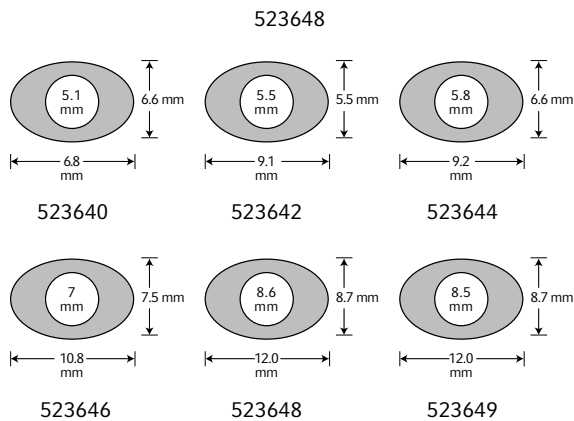

Drawings illustrate Nominal Proximal Internal Dimensions and Minimum Internal Diameter (I.D.), NOT TO SCALE.

CATALOG #	SCOPE SIZE	OVERALL LENGTH	MIN I.D.	NOMINAL PROXIMAL DIMENSIONS	MAX O.D.	REPLACE CARRIER
523640	6 x 8 x 32	317 mm	5.1 mm	6.6 x 6.8 mm	12.0 mm	526640
523642	6.5 x 10 x 35	349 mm	5.5 mm	5.5 x 9.1 mm	15.2 mm	526642
523644	7 x 10 x 42	421 mm	5.8 mm	6.6 x 9.2 mm	15.3 mm	526644
523646	8 x 12 x 45	452 mm	7.0 mm	7.5 x 10.8 mm	15.9 mm	526646
523648	10 x 14 x 29	292 mm	8.6 mm	8.7 x 12.0 mm	19.5 mm	526648
523649	10 x 14 x 50	500 mm	8.5 mm	8.7 x 12.0 mm	19.2 mm	526649

Jesberg Design

JESBERG OVAL ESOPHAGOSCOPES



The oval tube used in the construction of this scope is thickened at its distal end to form a protective edge and finished to a smooth shape. Supplied with one light carrier. Blue fiber optic cable sold separately (see pg. 467).

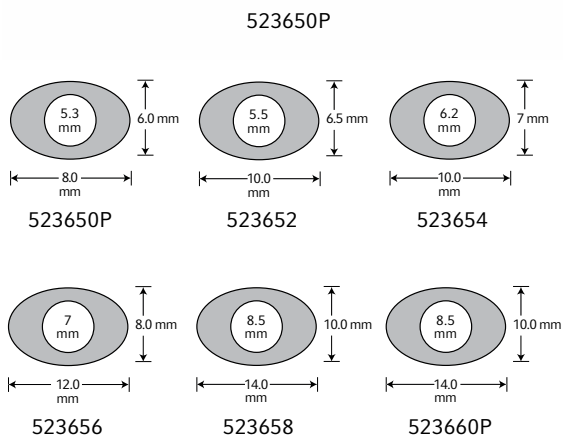

Drawings illustrate Nominal Proximal Internal Dimensions and Minimum Internal Diameter (I.D.), NOT TO SCALE.

CATALOG #	SCOPE SIZE	OVERALL LENGTH	MIN I.D.	NOMINAL PROXIMAL DIMENSIONS	MAX O.D.	REPLACE CARRIER
523650P	6 x 8 x 32	320 mm	5.3 mm	6.0 x 8.0 mm	12.6 mm	526268
523652	6.5 x 10 x 35	349 mm	5.5 mm	6.5 x 10.0 mm	15.7 mm	526270
523654	7 x 10 x 42	421 mm	6.2 mm	7.0 x 10.0 mm	16.2 mm	526276
523656	8 x 12 x 45	452 mm	7.0 mm	8.0 x 12.0 mm	15.4 mm	526278
523658	10 x 14 x 29	291 mm	8.5 mm	10.0 x 14.0 mm	18.5 mm	526264
523660P	10 x 14 x 50	504 mm	8.5 mm	10.0 x 14.0 mm	19.2 mm	526282



ESOPHAGOSCOPES

Holinger Design

HOLINGER FIBEROPTIC ESOPHAGOSCOPES



523570

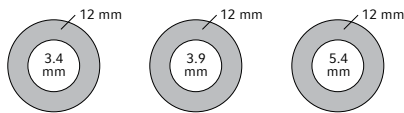

523570

523571

523572

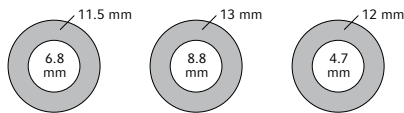

523573

523574

523575

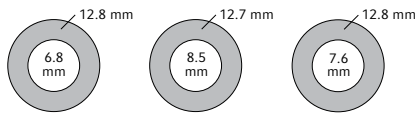

523577

523579

523581

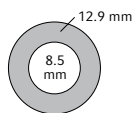

523582

Drawings illustrate Nominal Proximal Internal Dimensions and Minimum Internal Diameter (I.D.), NOT TO SCALE.

Designed by Dr. Paul Holinger, these fiberoptic esophagoscopes provide a nearly full view of the lumen with constant cool illumination. Special features of these esophagoscopes include:

- Large fiber bundle for increased distal illumination.
- Aspiration channel on the exterior of the scope to permit maximum lumen.
- Oval fiber optic light carrier to allow more viewing and instrumentation room in main tube.
- Smooth distal tip.
- 15 mm proximal end for attachment of accessories.
- Blue fiber optic cable sold separately (see pg. 467).

Holinger Fiberoptic Esophagoscopes are supplied with one light carrier and one window plug (522595).

CATALOG #	SCOPE SIZE	OVERALL LENGTH	MIN I.D.	NOMINAL PROXIMAL I.D.	MAX O.D.	REPLACE CARRIER
523570	3.5 x 30	300 mm	3.4 mm	12.0 mm	14.5 mm	527510
523571	4 x 30	300 mm	3.9 mm	12.0 mm	15.0 mm	527510
523572	6 x 30	300 mm	5.4 mm	12.0 mm	15.6 mm	527550
523573	7 x 30	300 mm	6.8 mm	11.5 mm	16.0 mm	527550
523574	9 x 30	300 mm	8.8 mm	13.0 mm	20.0 mm	527575
523575	5 x 35	349 mm	4.7 mm	12.0 mm	15.0 mm	527515
523577	7 x 45	451 mm	6.8 mm	12.8 mm	14.6 mm	527565
523579	9 x 53	530 mm	8.5 mm	12.7 mm	21.0 mm	527585
523581	8 x 45	451 mm	7.6 mm	12.8 mm	19.0 mm	527583
523582	9 x 45	451 mm	8.5 mm	12.9 mm	20.0 mm	527583

Dimensions are without window plug.



ESOPHAGOSCOPES

Jackson Design

JACKSON FIBER OPTIC OVAL ESOPHAGOSCOPES



In the oval model, the distal end is slightly flared to form a blunt, smooth edge without increasing the bulk of the tip unnecessarily. The light carrier is placed on the right side of the tube so that the cord is directed away from the hand of the operator. Supplied with one light carrier. Blue fiber optic cable sold separately (see pg. 467).

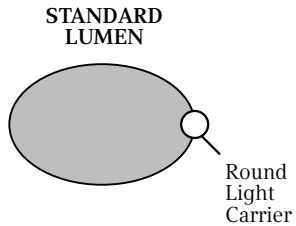

CATALOG #	SCOPE SIZE	OVERALL LENGTH	MIN I.D.	NOMINAL PROXIMAL DIMENSIONS	MAX O.D.	REPLACE CARRIER
523600P	7 x 10 x 25	251 mm	6.4 mm	7.0 x 10.0 mm	14.2 mm	526262
523602	8 x 12 x 50	502 mm	7.4 mm	7.0 x 11.0 mm	15.5 mm	526284
523604	9 x 13 x 25	251 mm	7.4 mm	7.9 x 11.0 mm	16.6 mm	526262
523606	10 x 14 x 30	302 mm	8.4 mm	8.8 x 12.2 mm	18.0 mm	526266
523608	10 x 14 x 40	401 mm	9.2 mm	8.0 x 12.0 mm	17.8 mm	526274
523610P	10 x 14 x 50	502 mm	8.2 mm	10.0 x 14.0 mm	17.5 mm	526284
523612	12 x 16 x 50	502 mm	9.0 mm	9.4 x 14.4 mm	18.8 mm	526284
523614	12 x 18 x 35	350 mm	9.4 mm	10.6 x 15.0 mm	20.7 mm	526272

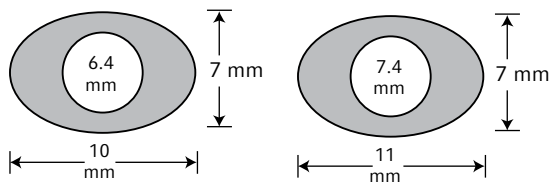

523600P

523602

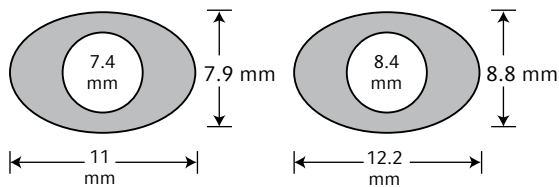

523604

523606

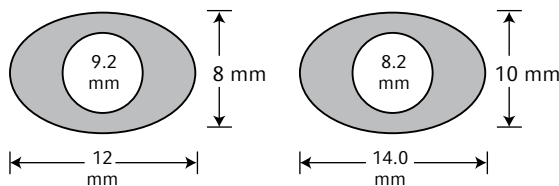

523608

523610P

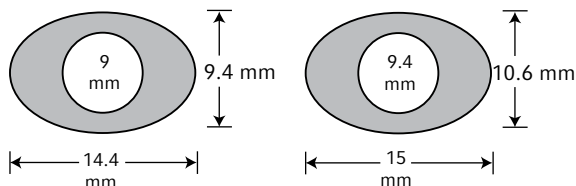

523612

523614

Drawings illustrate Nominal Proximal Internal Dimensions and Minimum Internal Diameter (I.D.), NOT TO SCALE.



ESOPHAGOSCOPES

Specula

FORBES ESOPHAGEAL SPECULA



523675

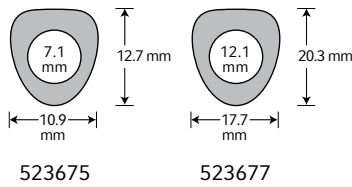

523675

523677

These specula are used for the retrieval of foreign objects lodged in the cervical esophagus. The lumen of these instruments is slightly off the round and the tube tapers gradually to the distal end. The length of the bevel of the tip varies according to the size of the instrument. Particularly useful in the removal of coins. Supplied with one light carrier. Blue fiber optic cable sold separately (see pg. 467).

CATALOG #	SCOPE SIZE	OVERALL LENGTH	MIN I.D.	NOMINAL PROXIMAL DIMENSIONS	MAX O.D.	REPLACE CARRIER
523675	Child	161 mm	7.1 mm	10.9 x 12.7 mm	14.4 mm	526020
523677	Adult	222 mm	12.1 mm	17.7 x 20.3 mm	23.0 mm	526046

HOLINGER INFANT ESOPHAGEAL SPECULUM



523505

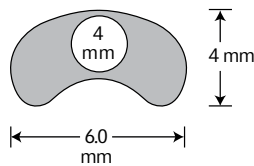

523505

The Holinger Infant Esophageal Speculum was designed for esophageal foreign body problems in small children. The length is adequate to reach foreign objects lodged in the cervical esophagus without the disadvantage of excess length. Supplied with one light carrier. Blue fiber optic cable sold separately (see pg. 467).

CATALOG #	SCOPE SIZE	OVERALL LENGTH	MIN I.D.	NOMINAL PROXIMAL DIMENSIONS	MAX O.D.	REPLACE CARRIER
523505	6 x 20	200 mm	4.0 mm	4.0 x 6.0 mm	10.0 mm	526218



INSTRUMENTATION FOR BRONCHOSCOPES AND ESOPHAGOSCOPES

The Pilling® Bronchial and Esophageal Instruments have been designed to meet the needs that may arise during the endoscopic surgical procedure. Biopsy forceps, grasping forceps, retrieval forceps, aspirating tubes and other related instruments have been designed specifically in length and diameter to be used with the appropriately sized Pilling® Scope.

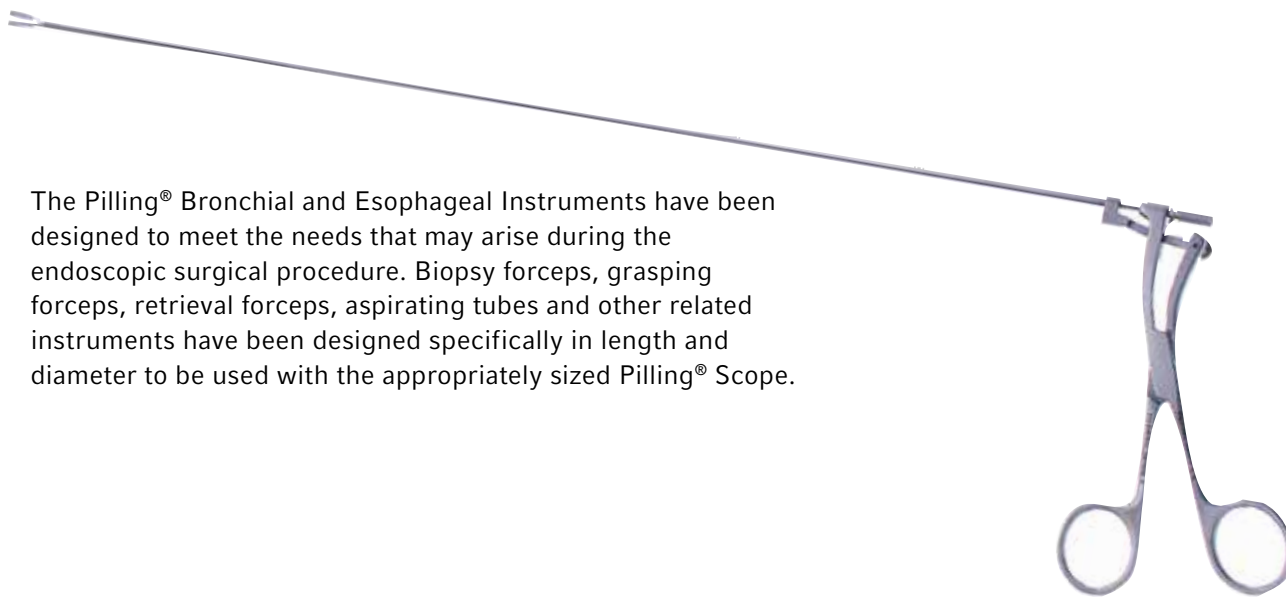

Biopsy Cup Forceps

EXTRA-LIGHTWEIGHT CONSTRUCTION FORCEPS

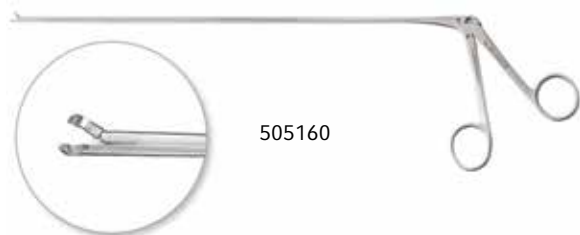

Very light shafts with small cup biting jaws, straight or slightly angled.

CATALOG #	CUP DIAMETER	SHAPE	WORKING LENGTH	FOR USE THRU SCOPES
505160	2 mm	Straight	35 cm	4.0 mm or larger
505162	2 mm	Straight	40 cm	4.0 mm or larger
505166	2 mm	Angular	35 cm	4.0 mm or larger
505168	2 mm	Angular	40 cm	4.0 mm or larger

INSTRUMENTATION FOR BRONCHOSCOPES AND ESOPHAGOSCOPES

Biopsy Cup Forceps

HOLINGER CUP BITING SPECIMEN FORCEPS



Cutting jaws with rounded tip and basket designed to prevent crushing of specimen. Cutting edges extend into box of instrument to permit clean, complete removal of specimen.

CATALOG #	CUP DIAMETER	SHAPE	WORKING LENGTH	FOR USE THRU SCOPES
505334	5 mm	Straight	60 cm	7.0 mm or larger

JACKSON SQUARE PUNCH SPECIMEN FORCEPS



Basket built into lower blade to hold excised tissue.

CATALOG #	CUP DIAMETER	SHAPE	WORKING LENGTH	FOR USE THRU SCOPES
505313	5 mm	Straight	45 cm	6.0 mm or larger

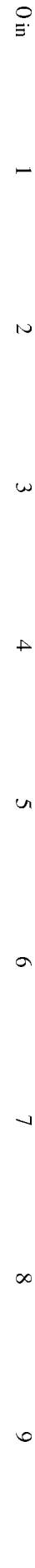

INSTRUMENTATION FOR BRONCHOSCOPES AND ESOPHAGOSCOPES

Biopsy Cup Forceps

SAM ROBERTS CUP BIOPSY FORCEPS - MOST POPULAR

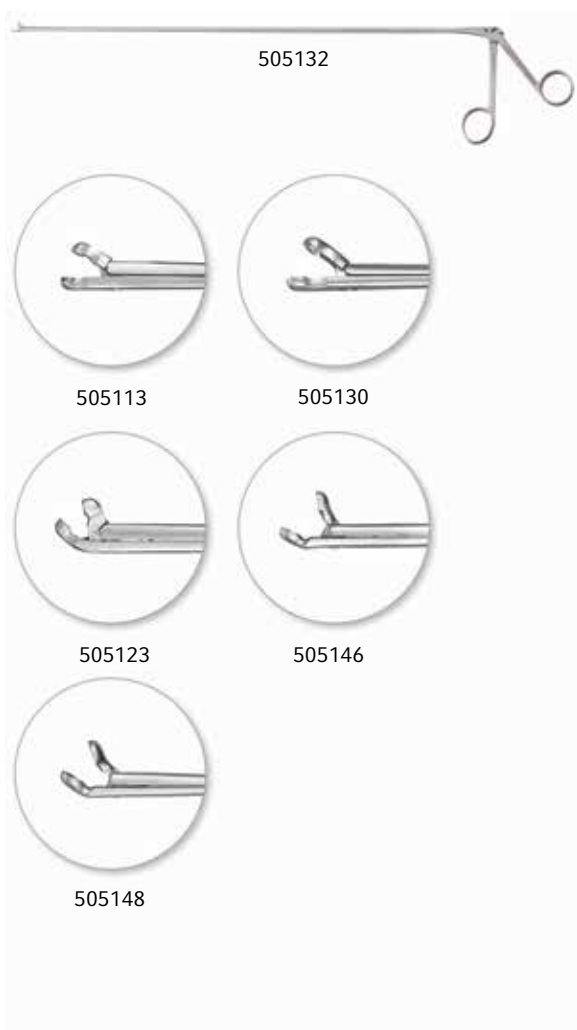

Roberts Forceps have jaws specially shaped and angled for use through bronchoscopes and esophagoscopes of definite sizes.

CATALOG #	CUP DIAMETER	SHAPE	WORKING LENGTH	FOR USE THRU STD. BRONCH	FOR USE THRU ESOPHAGOSCOPES
505113	2 mm	Straight	50 cm	4.5 mm	3.5 mm
505130	4 mm	Straight	40 cm	7.0 mm	7.0 mm
505132	4 mm	Straight	50 cm	7.0 mm	7.0 mm
505134	4 mm	Straight	60 cm	7.0 mm	7.0 mm
505136	6 mm	Straight	40 cm	9.0 mm	9.0 mm
505138	6 mm	Straight	50 cm	9.0 mm	9.0 mm
505140	6 mm	Straight	60 cm	9.0 mm	9.0 mm
505123	2 mm	Angular	50 cm	4.5 mm	3.5 mm
505142	4 mm	Angular	40 cm	8.0 mm	8.0 mm
505144	4 mm	Angular	50 cm	8.0 mm	8.0 mm
505146	4 mm	Angular	60 cm	8.0 mm	8.0 mm
505148	6 mm	Angular	40 cm	10.0 mm	10.0 mm
505150	6 mm	Angular	50 cm	10.0 mm	10.0 mm
505152	6 mm	Angular	60 cm	10.0 mm	10.0 mm



INSTRUMENTATION FOR BRONCHOSCOPES AND ESOPHAGOSCOPES

Grasping Forceps

JACKSON ALLIGATOR GRASPING FORCEPS - DOUBLE-ACTION



Double articulating jaws are finely serrated and grooved. For use through bronchoscopes or esophagoscopes.

CATALOG #	JAW WIDTH X LENGTH	WORKING LENGTH	FOR USE THRU SCOPES
505414	2.5 x 14 mm	50 cm	5.0 mm or larger
505415	2.5 x 14 mm	60 cm	5.0 mm or larger

JACKSON ALLIGATOR GRASPING FORCEPS - LIGHT CONSTRUCTION



Finely serrated tapered jaws. For use through bronchoscopes or esophagoscopes.

CATALOG #	JAW WIDTH X LENGTH	WORKING LENGTH	FOR USE THRU SCOPES
505420	1.5 x 17 mm	30 cm	5.0 mm or larger
505422	1.5 x 17 mm	40 cm	5.0 mm or larger

JACKSON ALLIGATOR GRASPING FORCEPS - EXTRA DELICATE



For use through infant laryngoscopes and 3.5 mm bronchoscopes.

CATALOG #	JAW WIDTH X LENGTH	WORKING LENGTH
505432	2.3 x 12 mm	30 cm
505433	2.3 x 12 mm	35 cm

JACKSON ALLIGATOR GRASPING FORCEPS - STANDARD



For use through bronchoscopes or esophagoscopes.

CATALOG #	JAW WIDTH X LENGTH	WORKING LENGTH	FOR USE THRU SCOPES
505400	4 x 23 mm	28 cm	6.0 mm or larger
505402	4 x 23 mm	35 cm	6.0 mm or larger
505403	4 x 23 mm	40 cm	6.0 mm or larger
505404	4 x 23 mm	50 cm	6.0 mm or larger
505406	4 x 23 mm	60 cm	6.0 mm or larger

INSTRUMENTATION FOR BRONCHOSCOPES AND ESOPHAGOSCOPES

Grasping Forceps

JACKSON ROTATION FORCEPS

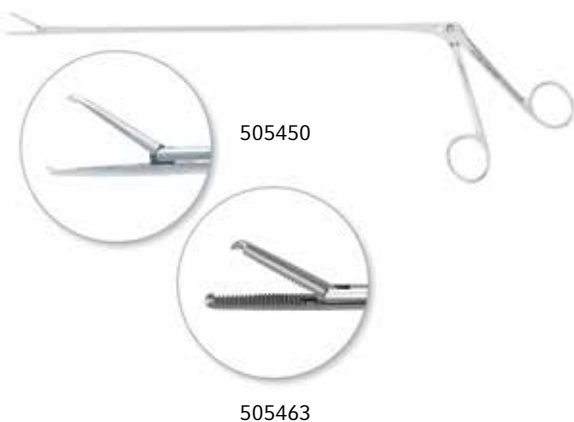

Serrated jaws terminate in sharp teeth. Standard forceps are sturdily constructed with large, strong teeth for use through bronchoscopes and esophagoscopes. Delicate forceps feature light construction with small, sharp teeth. Stainless Steel.

CATALOG #	DESCRIPTION	JAW WIDTH X LENGTH	WORKING LENGTH	FOR USE THRU SCOPES
505462	Delicate light	2.4 x 10 mm	30 cm	3.5 mm or larger
505463	Delicate light	2.4 x 10 mm	35 cm	3.5 mm or larger
505450	Standard	4 x 20 mm	28 cm	3.5 mm or larger
505455	Standard	4 x 20 mm	50 cm	7.0 mm or larger
505456	Standard	4 x 20 mm	60 cm	7.0 mm or larger

CLERF-ARROWSMITH SAFETY PIN CLOSING FORCEPS

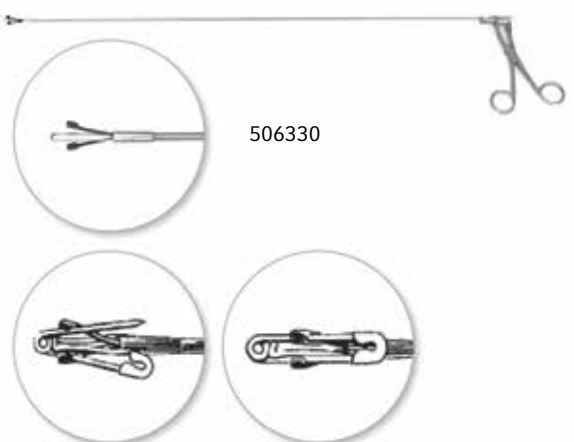

A notched brace pushes the loop of the pin away from the jaws which simultaneously grasps the limbs of the pin. This action results in approximation of the point and keeper.

CATALOG #	WORKING LENGTH	FOR USE THRU SCOPES	CONSTRUCTION WEIGHT
506330	45 cm	5.0 mm or larger	7/8" - 1-1/2"
506331	50 cm	5.0 mm or larger	7/8" - 1-1/2"

GORDON BEAD GRASPING FORCEPS



The four-bladed grasping unit is designed to completely surround a slippery, hard-surfaced, smooth object such as an oval bead or ball-bearing.

CATALOG #	WORKING LENGTH	FOR USE THRU SCOPES	CONSTRUCTION WEIGHT
506150	45 cm	5.0 mm or larger	Small
506152	50 cm	6.0 mm or larger	Large



INSTRUMENTATION FOR BRONCHOSCOPES AND ESOPHAGOSCOPES

Grasping Forceps

JACKSON DOUBLE PRONG GRASPING FORCEPS



Powerful, fenestrated, deeply serrated blades with distal points are especially valuable in grasping teeth and similar difficult objects.

CATALOG #	WORKING LENGTH	FOR USE THRU SCOPES	CONSTRUCTION WEIGHT
506251	45 cm	5.0 mm or larger	Medium
506252	50 cm	5.0 mm or larger	Medium

JACKSON DULL-POINTED RING ROTATION FORCEPS



CATALOG #	WORKING LENGTH	FOR USE THRU SCOPES	CONSTRUCTION WEIGHT
506220	35 cm	3.5 mm or larger	Extra-Small
506232	60 cm	5.0 mm or larger	Large

JACKSON FENESTRATED MEAT GRASPING FORCEPS



Large, deeply serrated blades.

CATALOG #	(MM) LENGTH	FOR USE THRU SCOPES	CONSTRUCTION WEIGHT
506075	50 cm	7.0 mm or larger	Large
506076	60 cm	7.0 mm or larger	Large

JACKSON FENESTRATED PEANUT GRASPING FORCEPS

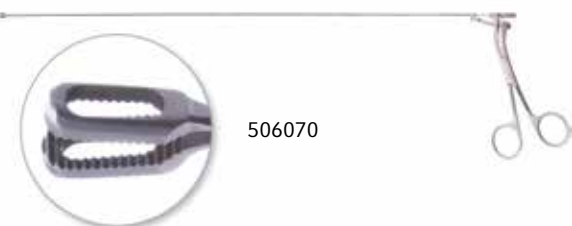

Jaws considerably lighter and smaller than meat grasping forceps.

CATALOG #	WORKING LENGTH	FOR USE THRU SCOPES	CONSTRUCTION WEIGHT
506060	35 cm	3.5 mm or larger	Extra-Small
506063	35 cm	4.0 mm or larger	Small
506070	60 cm	5.0 mm or larger	Medium

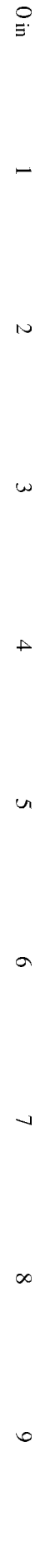

INSTRUMENTATION FOR BRONCHOSCOPES AND ESOPHAGOSCOPES

Grasping Forceps

JACKSON FORWARD GRASPING CUP FORCEPS

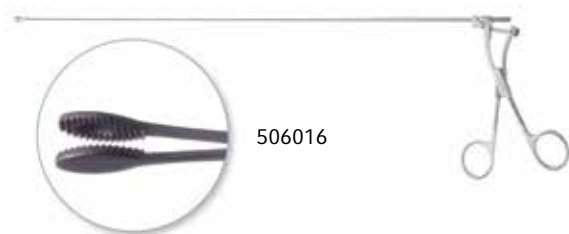

These cannulated forceps are constructed entirely of stainless steel. The jaws are carefully shaped and set to provide a secure grip on the object to be removed. They are strong and durable and will sustain any degree of traction it is safe to exert. Serrated, cupped jaws in various sizes.

CATALOG #	WORKING LENGTH	FOR USE THRU SCOPES	CONSTRUCTION WEIGHT
506000	35 cm	3.0 mm or larger	Extra-Small
506003	35 cm	4.0 mm or larger	Small
506004	40 cm	4.0 mm or larger	Small
506008	40 cm	4.0 mm or larger	Medium
506016	50 cm	5.0 mm or larger	Large
506017	60 cm	5.0 mm or larger	Large

JACKSON FORCEPS PARTS KIT



Contains various sizes of screws and pivot pins for Jackson cannulated-style forceps.

CATALOG #	DESCRIPTION
508590	12 parts total

508590

JESBERG FENESTRATED GRASPING FORCEPS



A multi-purpose forceps with fenestrated blades shaped to encircle an odd-shaped or globular object. Valuable as a forward grasping forceps for pebbles, beads, peanuts, meat, head presented tacks and nails. Light construction weight.

CATALOG #	WORKING LENGTH	FOR USE THRU SCOPES	CONSTRUCTION WEIGHT
506053	50 cm	4.0 mm or larger	Light

INSTRUMENTATION FOR BRONCHOSCOPES AND ESOPHAGOSCOPES

Grasping Forceps

TUCKER BEAD GRASPING FORCEPS

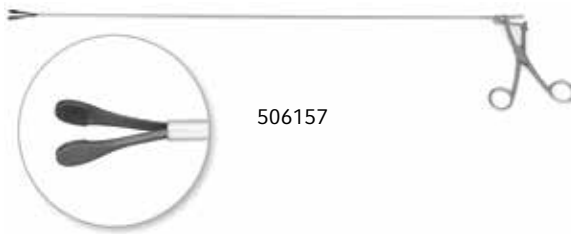

Forceps have stiff, expanding springs and jaws designed to grasp over and beyond the greatest circumference of the bead. Blades are concave and back-serrated at the tip for secure grasp.

CATALOG #	WORKING LENGTH	FOR USE THRU SCOPES	CONSTRUCTION WEIGHT
506155	40 cm	4.0 mm or larger	Small
506157	50 cm	5.0 mm or larger	Medium

KAHLER GRASPING FORCEPS



Jaws contain a series of teeth that provide a very secure grip on most foreign bodies.

CATALOG #	JAW WIDTH X LENGTH	WORKING LENGTH	FOR USE THRU SCOPES
505515	4 x 13 mm	60 cm	6.0 mm or larger

INSTRUMENTATION FOR BRONCHOSCOPES AND ESOPHAGOSCOPES

Grasping Forceps

PILLING® DELICATE CENTER-ACTION BRONCHOSCOPIC FORCEPS



The slender stem allows far greater visibility. Center-action handle and double-action jaws eliminate tendency of distal end to pull away from object and rise. Stem does not bend under pressure from handles. Stainless steel construction.

CATALOG #	DESCRIPTION	WORKING LENGTH	FOR USE THRU SCOPES
505005	Fenestrated, cupped grasping	38 cm	3.5 mm or larger
505010	Fenestrated, cupped grasping	38 cm	4.0 mm or larger
505014	Fenestrated, cupped grasping	50 cm	4.0 mm or larger
505016	Alligator grasping	38 cm	4.0 mm or larger
505018	Alligator grasping	45 cm	4.0 mm or larger
505020	Alligator grasping	50 cm	4.0 mm or larger
505022	Rotation, 1 x 2 teeth	38 cm	4.0 mm or larger
505028	Kahler grasping	38 cm	4.0 mm or larger
505030	Kahler grasping	45 cm	4.0 mm or larger
505032	Kahler grasping	50 cm	4.0 mm or larger
505046	Circular cup biopsy forceps	38 cm	5.0 mm or larger
505048	Circular cup biopsy forceps	45 cm	5.0 mm or larger
505050	Circular cup biopsy forceps	50 cm	5.0 mm or larger
505056	Oval cup biopsy forceps	50 cm	5.0 mm or larger



INSTRUMENTATION FOR BRONCHOSCOPES AND ESOPHAGOSCOPES

Forceps for Pediatric and Laser Scopes

PEDIATRIC BRONCHOSCOPIC INSTRUMENTS

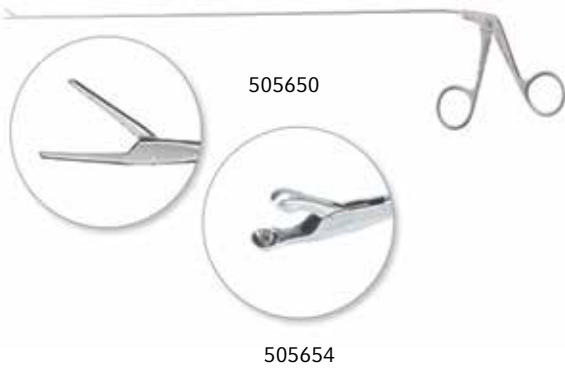

These miniature grasping and biopsy forceps and scissors with 2 mm stems have been designed to pass through the smaller pediatric bronchoscopes. The stems are slightly angled at the handle, affording unobstructed vision. Straight forward, 35 cm working length, will pass through a 3 mm or larger scope, 5 degree bend at handle.

CATALOG #	DESCRIPTION	SHAPE	WORKING LENGTH	FOR USE THRU SCOPES
505650	Grasping forceps	Straight forward	36 cm	3.0 mm or larger
505654	Biopsy forceps	Straight cup	36 cm	3.5 mm or larger
505662	Biopsy forceps	Oval cup	37 cm	3.5 mm or larger

PILLING® FLEXIBLE ENDOSCOPIC FORCEPS



The Pilling® Flexible Forceps were designed for use with Pilling® Laser and Standard Bronchoscopes. They easily pass through the instrument/fiber channel for the purpose of biopsy, foreign body retrieval and removal of char from laser ablation. These forceps are available in 1 mm and 2 mm sizes.

CATALOG #	OVERALL LENGTH	DESCRIPTION	FOR USE THRU SCOPES
505670	36.5 cm	1 mm alligator grasping	3.5 x 20 4.0 x 25
505674	36.5 cm	1 mm oval cup biopsy	3.5 x 20 4.0 x 25
505680	40 cm	1.5 mm alligator grasping, flexible	5.0 x 30 6.0 x 35
505682	40 cm	2 mm fenestrated grasping, flexible	5.0 x 30 6.0 x 35
505686	50 cm	2 mm alligator grasping, flexible	7.0 x 40 8.0 x 40 9.0 x 40
505690	50 cm	2 mm circular cup biopsy	7.0 x 40 8.0 x 40 9.0 x 40

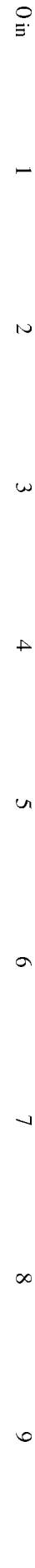

INSTRUMENTATION FOR BRONCHOSCOPES AND ESOPHAGOSCOPES

Suction Tubes

HOLINGER ASPIRATING TUBES

Holinger Tubes have an open distal tip as well as two opposing side openings. This allows for complete, rapid aspiration without clogging. These tubes are available in a standard model without thumb-valve and the thumb-valve control model.

Standard Model

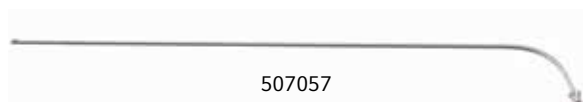

CATALOG #	WORKING LENGTH	FOR USE THRU SCOPES	TUBE DIAMETER
507050	45 cm	5.0 mm or larger	4 mm (12 Fr.)
507051	50 cm	5.0 mm or larger	4 mm (12 Fr.)
507052	60 cm	5.0 mm or larger	4 mm (12 Fr.)
507055	25 cm	4.0 mm or larger	3 mm (9 Fr.)
507057	35 cm	4.0 mm or larger	3 mm (9 Fr.)

Thumb Valve Control Model



CATALOG #	WORKING LENGTH	TUBE DIAMETER
507060	20 cm	3 mm (9 Fr.)
507065	35 cm	4 mm (12 Fr.)

For use through infant laryngoscopes for tracheal aspiration.

JACKSON "VELVET-EYE" ASPIRATING TUBES

These tubes have a smooth, oval-shaped opening on each side of the distal tip and a closed, blunt end.

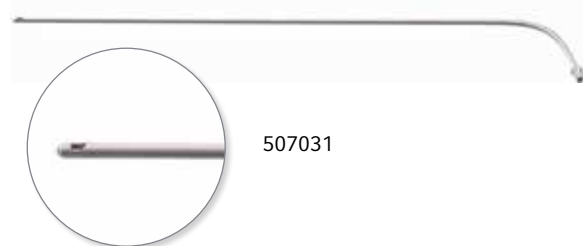

CATALOG #	WORKING LENGTH	FOR USE THRU SCOPES	TUBE DIAMETER
507030	20 cm	5.0 mm or larger	4 mm (12 Fr.)
507031	35 cm	5.0 mm or larger	4 mm (12 Fr.)
507032	40 cm	5.0 mm or larger	4 mm (12 Fr.)
507033	45 cm	5.0 mm or larger	4 mm (12 Fr.)
507034	50 cm	5.0 mm or larger	4 mm (12 Fr.)
507035	60 cm	5.0 mm or larger	4 mm (12 Fr.)
507040	35 cm	4.0 mm or larger	3 mm (9 Fr.)
507041	40 cm	4.0 mm or larger	4 mm (12 Fr.)

INSTRUMENTATION FOR BRONCHOSCOPES AND ESOPHAGOSCOPES

Suction Tubes

JACKSON OPEN END ASPIRATING TUBE

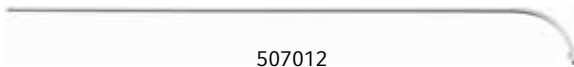

507012

Pilling® Aspirating Tubes, except in special designs, are constructed of stainless steel. They are measured in working length from distal tip to beginning of proximal curve or angle. Aspirating tubes should be 5 cm or 10 cm longer than the instruments through which they are used.

CATALOG #	WORKING LENGTH	FOR USE THRU SCOPES	TUBE DIAMETER
507010	20 cm	5.0 mm or larger	4 mm (12 Fr.)
507011	35 cm	5.0 mm or larger	4 mm (12 Fr.)
507012	40 cm	5.0 mm or larger	4 mm (12 Fr.)
507013	45 cm	5.0 mm or larger	4 mm (12 Fr.)
507014	50 cm	5.0 mm or larger	4 mm (12 Fr.)
507015	60 cm	5.0 mm or larger	4 mm (12 Fr.)
507020	35 cm	3.0 mm or larger	2.0 mm (6 Fr.)
507023	35 cm	3.5 mm or larger	2.6 mm (8 Fr.)
507027	35 cm	4.0 mm or larger	3.0 mm (9 Fr.)
507028	40 cm	4.0 mm or larger	3.0 mm (9 Fr.)

FULLY INSULATED SUCTION TUBE



507048

CATALOG #	DESCRIPTION
507048	With thumb-valve, 12 Fr. tip, working length 19-5/8" (50 cm). Supplied w/10 ft. Bovie cord and plug (507046)

BOVIE CORD FOR SUCTION TUBE



507046

CATALOG #	DESCRIPTION
507046	Replacement Bovie cord and plug for 507048, 10 ft.



INSTRUMENTATION FOR BRONCHOSCOPES AND ESOPHAGOSCOPES

Coagulation Suction Tubes

COAGULATION SUCTION TUBES



809600

Disposable foot control coagulation suction tubes, sterile, 10 per box.

CATALOG #	DESCRIPTION
809600	11 French, with stylet, 6" (15 cm)
809610	11 French, with stylet, 8" (20.5 cm)



LIGHTSOURCES

PILLING® SURGICAL LIGHTING SYSTEMS



528305XLTP

CATALOG #	DESCRIPTION
528300P	Xenon 300 Watt Lightsource, 5 Port Turret, 100-120V
528305XLTP	XenaLight™ XLT II Lightsource, 5 Port Turret, 100-120V
528302P	Xenon 300 Watt Lightsource Bulb/Cartridge
528303P	Xenon 300 Watt Lightsource Bulb
528308P	XenaLight™ XLT Bulb with Timer Board for Model 528305, 528305XLT
528310P	XenaLight™ XLT II Bulb with Timer Chip for Model 528305XLTP
528304P	Floorstand, Xenon 300 Watt, Base/Pole/Swivel
528309P	Floorstand, XenaLight™ XLT II, Base/Pole/Swivel
528341P	SurgiLux Headlight Variable 10-75 mm Spot with 8' XLG Cable
528342P	SurgiLux Headlight Fixed 100 mm Spot with 8' XLG Cable
528343P	SurgiLux Headlight Variable 10-75 mm Spot Headlight with 10' XLG Cable
528344P	SurgiLux Headlight Fixed 100 mm Spot with 10' XLG Cable
528339P	SurgiLux Headlight Variable 10-75 mm Spot with 8' XLG BIF Cable
528340P	SurgiLux Headlight Fixed 100 mm Spot with 8' XLG BIF Cable
W358XLGP	Headlight Cable 8', 3.5 mm, XLG Lensed (Wolf)
W3510XLGP	Headlight Cable, 10', 3.5 mm, XLG Lensed (Wolf)
W358LWP	Headlight Cable 8', 3.5 mm, Bifurcated Lensed (Wolf)
W3510LWP	Headlight Cable 10', 3.5 mm, Bifurcated Lensed (Wolf)
528351P	Headband Front Insert, Breath-O-Prene (Pkg of 5)
528352P	Headband Top Insert, Breath-O-Prene (Pkg of 5)
528353P	Headband Back Insert, Breath-O-Prene (Pkg of 5)
528354P	Joysticks (Pkg of 5)
528355P	Gown Clips (Pkg of 10)



FIBER OPTIC CABLES

PILLING® BLUE FIBER OPTIC CABLES

For use with Pilling® Laryngoscopes, Bronchoscopes and Esophagoscopes.



P358PRA



A358PRA



O358PRA



S358PRA



A358AFA



W358PXA



W356PXA

CATALOG #	DESCRIPTION
P358PRA	Pilling® Illuminator end, 3.5 mm bundle, 8 ft. length, Pilling® Rotating Instrument End
P356PRA	Pilling® Illuminator end, 3.5 mm bundle, 6 ft. length, Pilling® Rotating Instrument End
A358PRA	ACMI illuminator end, 3.5 mm bundle, 8 ft. length, Pilling® Rotating Instrument End (formally A358PR)
O358PRA	Olympus illuminator end, 3.5 mm bundle, 8 ft. length, Pilling® Rotating Instrument End
S358PRA	Storz illuminator end, 3.5 mm bundle, 8 ft. length, Pilling® Rotating Instrument End
W358PRA	Wolf illuminator end, 3.5 mm bundle, 8 ft. length, Pilling® Rotating Instrument End
A358AFA	ACMI illuminator end, 3.5 mm bundle, 8 ft. length, ACMI Female Instrument End
W358PXA	Bifurcated cable, Wolf illuminator end, 3.5 mm bundle, 8 ft. length, Pilling® Rotating Instrument End
W356PXA	Bifurcated cable, Wolf illuminator end, 3.5 mm bundle, 6 ft. length, Pilling® Rotating Instrument End



FIBER OPTIC CABLES

PILLING® ROTATING ENDFITTING REPLACEMENT TIP



50613AC

CATALOG #	DESCRIPTION
50613AC	Pilling® Rotating Endfitting Replacement tip for Pilling® Single Cables with catalog numbers ending in "PRA" (formerly 521166)

FIBER OPTIC INSTRUMENT CABLE END ADAPTERS

These adapters are to be used with standard Pilling® Fiber Optic Cables P358PRA or P356PRA.



50614AC



50615AC

CATALOG #	DESCRIPTION
50614AC	Pilling® to ACMI, adapts to Pilling® Single Cables with catalog numbers ending in "PRA" (formerly 521165) to have an ACMI illuminator end
50615AC	Pilling® to Wolf, adapts to Pilling® Single Cables with catalog numbers ending in "PRA" (formerly 521170) to have a Wolf illuminator end

ACMI ILLUMINATOR END ADAPTER FOR TYPE II CABLES



50616AC

This adapter attaches to fiber optic cables with a larger Pilling® End Fitting on one end and a light carrier permanently attached to the cable on the other end.

CATALOG #	DESCRIPTION
50616AC	Adapts to the following: 527850 Light Carrier Cable for Improved Tucker Mediastinoscope, long (522311) 527853 Light Carrier Cable for Improved Tucker Mediastinoscope, short (522306) 527860 Light Carrier Cable for Ossoff Adult Subglottoscopes (522244, 522245) 527862 Light Carrier Cable for Ossoff-Karlan-Dedo Laser Micro-Laryngoscope, adol (522238) 527863 Light Carrier Cable for Ossoff-Karlan-Dedo Laser Micro-Laryngoscope, child (522237)

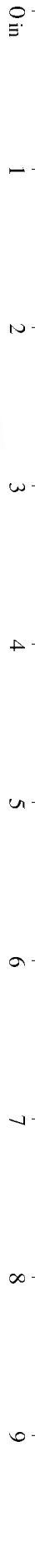

BOUGIES/DILATORS

Esophageal Bougies

PILLING® BOUGIES/DILATORS

The comprehensive line of Pilling® Laryngeal and Esophageal Dilators and Bougies includes designs by Drs. Jackson, Tucker and Maloney.



MALONEY-STYLE & HURST-STYLE BOUGIES (MADE OF SILICONE, MERCURY FREE)

The advantages of our exclusive new esophageal bougies start with what they don't have. Namely, mercury. Mercury is toxic and requires special handling and waste disposal procedures. But our patented tungsten gel-filling is completely nontoxic.

What's more, these bougies can be sterilized via steam; unlike mercury-filled bougies, they won't rupture during steam.

In addition, the silicone casing is non-slip when dry and slippery when wet. So it gives you a good grip, yet allows for easier, less traumatic insertion.

- Patented tungsten gel-filling is completely nontoxic, making it safer for patients and staff, with far less cost of disposal.
- Calibration marks, along with radio-opaque material in the flexible tip of the Maloney style, make it easy to determine the exact depth of insertion.
- Date stamp and three-year guarantee.

HURST TUNGSTEN-FILLED ESOPHAGEAL BOUGIES



507606

These tungsten-filled bougies have rounded distal tips. The closure on the proximal end is drilled through from side-to-side so a finger cord may be used. 29-1/2" (75 cm) approximate overall length.

CATALOG #	DESCRIPTION	CATALOG #	DESCRIPTION
507595	20 Fr.	507606	42 Fr.
507596	22 Fr.	507607	44 Fr.
507597	24 Fr.	507608	46 Fr.
507598	26 Fr.	507609	48 Fr.
507599	28 Fr.	507610	50 Fr.
507600	30 Fr.	507611	52 Fr.
507601	32 Fr.	507612	54 Fr.
507602	34 Fr.	507613	56 Fr.
507603	36 Fr.	507614	58 Fr.
507604	38 Fr.	507615	60 Fr.
507605	40 Fr.		

BOUGIES/DILATORS

Esophageal Bougies

MALONEY TAPERED TUNGSTEN-FILLED ESOPHAGEAL BOUGIES



507942

This tungsten-filled bougie provides a single style of dilator for treating cardiospasm, esophagitis, stenosis and other esophageal diseases. The small, flexible tip is easily introduced through the cricopharynx area, cardioesophageal junction or stenosis. Once the tip is through the involved area, the tapered end allows the single bougie to dilate this portion of the esophagus to its maximum limit. Overall length is approximately 29-1/2" (75 cm).

CATALOG #	DESCRIPTION	CATALOG #	DESCRIPTION
507920	20 Fr.	507942	42 Fr.
507922	22 Fr.	507944	44 Fr.
507924	24 Fr.	507946	46 Fr.
507926	26 Fr.	507948	48 Fr.
507928	28 Fr.	507950	50 Fr.
507930	30 Fr.	507952	52 Fr.
507932	32 Fr.	507954	54 Fr.
507934	34 Fr.	507956	56 Fr.
507936	36 Fr.	507958	58 Fr.
507938	38 Fr.	507960	60 Fr.
507940	40 Fr.		

BOUGIE TRAY



508000

Stainless steel. Separately holds 12 individual bougies (Maloney or Hurst). Two tiers with upper tier have hinged handle, perforated trays and lid. Holding pins hold bougie cap to keep bougie straight and in corrugated channels.

CATALOG #	DESCRIPTION
508000	31-5/8" x 11" (80.5 x 28 cm)

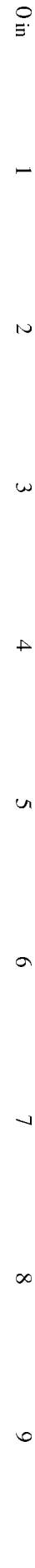

BOUGIES/DILATORS

Esophageal Dilators

JACKSON ESOPHAGEAL DILATORS



507820

The Pilling® Jackson Esophageal Dilator has proved popular and effective among surgeons. Now available in a durable silicone material. This configuration is the safest of all forms of dilators because of the thin, flexible stem that enables accurate ocular guidance of the dilator into the lumen of the stricture. A small size (12 Fr.) is often useful to make sure of a lumen ahead at the cricopharyngeal and hiatal levels during esophagoscopy as well as in cases of stenosis. The steel stem also permits the use of the tiniest filiform sizes. Overall length ranges from 25" (63.5 cm) for the 8 - 12 Fr. to 26-1/2" (67.5 cm) for the 20 - 42 Fr.

CATALOG #	DESCRIPTION
507807	Dilator Set, includes one of each size listed, 19 dilators, 8 Fr. - 42 Fr.
507808	8 Fr.
507809	9 Fr.
507810	10 Fr.
507812	12 Fr.
507814	14 Fr.
507816	16 Fr.
507818	18 Fr.
507820	20 Fr.
507822	22 Fr.
507824	24 Fr.
507826	26 Fr.
507828	28 Fr.
507830	30 Fr.
507832	32 Fr.
507834	34 Fr.
507836	36 Fr.
507838	38 Fr.
507840	40 Fr.
507842	42 Fr.

TUCKER LUMEN FINDERS



507876

Short, flexible, soft rubber tip affixed to 25-1/2" (65 cm) stem with removable handle extension. 30-3/4" (78 cm) overall length.

CATALOG #	DESCRIPTION
507875	14 Fr.
507876	16 Fr.
507877	18 Fr.

BOUGIES/DILATORS

Laryngeal Dilators

JACKSON LARYNGEAL DILATORS



Rigid metallic dilators for direct laryngoscopic treatment of laryngeal stenosis. Eighteen graduated sizes for consecutive use, corresponding approximately to the French sizes listed below. Sizes 10-14 Fr. have a round end; sizes 16-44 Fr. have a triangular-shaped end. 11-3/4" (30 cm) length from tip to angle.

CATALOG #	DESCRIPTION
507500	10 Fr.
507501	12 Fr.
507502	14 Fr.
507503	16 Fr.
507504	18 Fr.
507505	20 Fr.
507506	22 Fr.
507507	24 Fr.
507508	26 Fr.
507509	28 Fr.
507510	30 Fr.
507511	32 Fr.
507512	34 Fr.
507513	36 Fr.
507514	38 Fr.
507515	40 Fr.
507516	42 Fr.
507517	44 Fr.

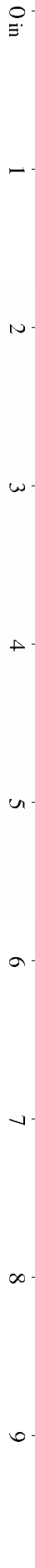

PILLING® TRACHEOSTOMY AND LARYNGECTOMY TUBES

Pilling® Tracheostomy and Laryngectomy Tubes are known for their innovation in the sterling silver and stainless steel products. Choose from the largest variety of tube available in standard sizes. In addition, special models and cuts are made to order. Pilling® Insertion Instruments, Speaking Valves and Decannulation Stoppers are also available.



Sterling silver and stainless steel trachea tube care and cleaning warning:

Do not soak, wash or expose the tubes to peroxide or enzyme cleaners, or sodium hydroxide. These chemical agents will cause the silver tubes to discolor, stain, tarnish and weaken the solder connection joints. These chemical agents will cause stainless steel to pit and stain.

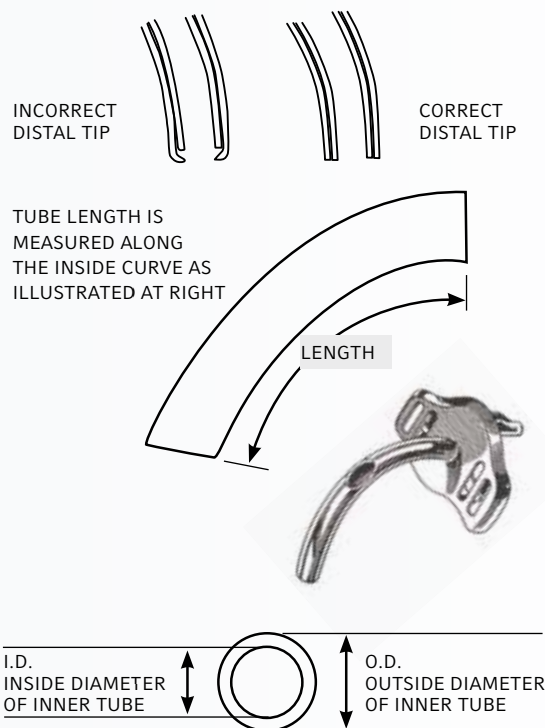

TRACHEOSTOMY AND LARYNGECTOMY TUBES

Specifications from the tube designer are rigidly followed. Locking mechanisms are well designed and operate properly.

The inner and outer tubes fit closely to provide maximum airway. The distal edge of the inner tube is flush with, and fits very closely to, that of the outer tube to allow for correct and complete cleaning.

Stainless steel and sterling silver are used in the construction of Pilling® Tubes. Plating is not used because it wears off due to galvanic action between the plating and the base metal.

Pilling® Tubes are offered in the largest variety available from any single source; special models and sizes are available.

FENESTRATED TRACHEOSTOMY TUBES

Any Pilling® Tracheostomy Tube may be fenestrated upon request. The standard fenestration is located at a point, measured from the neck plate, equal to one-third of the length of the tube. Special fenestrated tubes can be made to order. The size and position of special fenestrations must be specified by the prescribing physician.

TRACHEOSTOMY AND LARYNGECTOMY TUBE DIMENSIONS

The dimensions of Pilling® Tracheostomy and Laryngectomy Tubes are given in a numerical size, an outside tube diameter and an inside tube diameter. The outside diameter (O.D.) is the mm diameter of the outer tube, while the inside diameter (I.D.) is the mm diameter of the inner tube distal end.



PILLING® JACKSON TRACHEOSTOMY TUBES

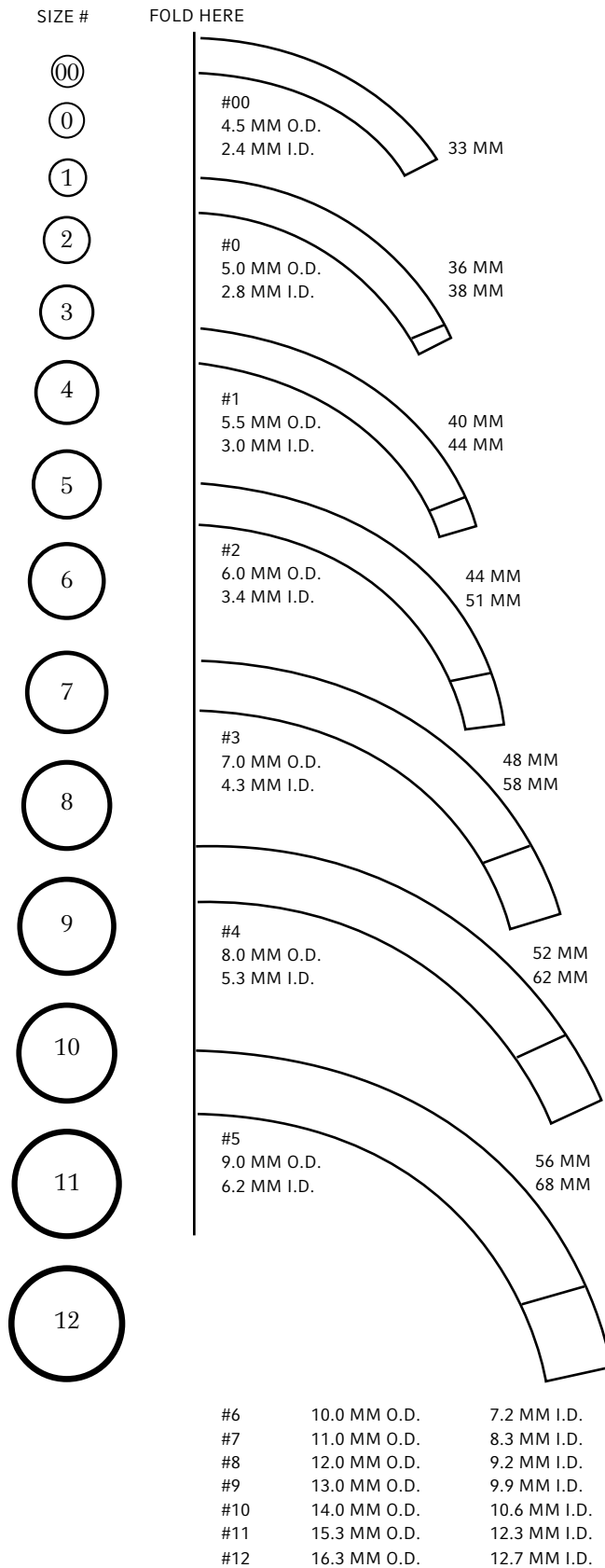

Stainless steel. Sterling silver.

SIZE AND SHAPE SPECIFICATIONS

To measure a tube, fold page on line where indicated and lay the tube on the outline with plate over the page edge. Dimensions shown are tube diameter in mm and Fr. size, and the length in mm around the inside curve. The shorter of the length indicated (48 mm on #3) applies to Jackson Short Length Tubes. The longer size (58 mm on #3) applies to Jackson Regular Length Tubes. The shape diagrams are quite accurate and are shown to aid in ordering special length tubes as well as standard lengths.

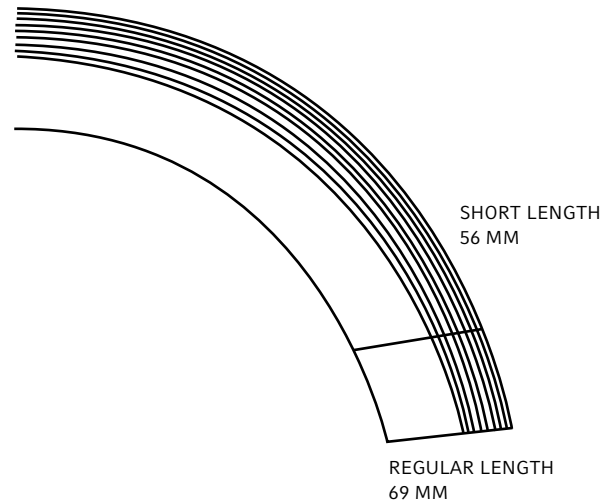

NOTE
 FIRST LINE ON LENGTH CURVE = SHORT
 FULL LENGTH CURVE = REGULAR
 16 MM PAST FULL LENGTH LINE = EXTRA-LONG



TRACHEOSTOMY TUBES

Jackson Improved Design

JACKSON IMPROVED TRACHEOSTOMY TUBES - REGULAR LENGTH



Stainless steel. The improved model with a rotating lock provides quick, easy removal of the inner tube. A set consists of an outer tube, inner tube and obturator.

CATALOG #	SIZE	(MM) O.D.	(MM) I.D.	(MM) LENGTH
518010	1	5.5	3.0	44.0
518015	2	6.0	3.4	51.0
518020	3	7.0	4.3	58.0
518025	4	8.0	5.5	62.0
518029*	4	8.0	5.5	62.0
518030	5	9.0	6.2	68.0
518034*	5	9.0	6.2	68.0
518035	6	10.0	7.2	69.0
518039*	6	10.0	7.2	69.0
518040	7	11.0	8.1	69.0
518044*	7	11.0	8.1	69.0
518045	8	12.0	9.2	69.0
518049*	8	12.0	9.2	69.0
518050	9	13.0	9.9	69.0
518055	10	14.0	10.6	69.0

* These Jackson Tubes are fenestrated to facilitate speech. The fenestration is located at a point measured from the neckplate equal to 1/3 of the length of the tube on both the inner and outer tubes.



* Fenestrated Jackson Tube

TRACHEOSTOMY TUBES

Jackson Improved Design

JACKSON EXTRA-LONG TRACHEOSTOMY TUBES WITH ROTATING LOCK



Stainless steel. The Jackson Extra-Long Tracheostomy Tubes are 16 mm longer than standard Jackson tubes. They are made in sizes 5 through 9 only in stainless steel. Size and shape may be chosen using the Jackson Tracheostomy Tubes diagram located at the beginning of this section. The length of the outer arc is 16 mm longer than the regular length. A set consists of an outer tube, inner tube and obturator.

CATALOG #	SIZE	(MM) O.D.	(MM) I.D.	(MM) LENGTH
518900	5	9.0	6.2	84.0
518902	6	10.0	7.2	85.0
518904	7	11.0	8.3	85.0
518906	8	12.0	9.2	85.0
518908	9	13.0	9.9	85.0



TRACHEOSTOMY TUBES

Jackson Improved Design

JACKSON IMPROVED TRACHEOSTOMY TUBES - SHORT LENGTH



Stainless steel. These tubes follow the regular Jackson curve and supply the need for tubes of lengths between the regular Jackson and the short Luer Tube. A set consists of an outer tube, inner tube and obturator.

CATALOG #	SIZE	(MM) O.D.	(MM) I.D.	(MM) LENGTH
518215	3	7.0	4.3	48.0
518220	4	8.0	5.5	52.0
518225	5	9.0	6.2	56.0
518230	6	10.0	7.2	56.0
518235	7	11.0	8.1	56.0
518240	8	12.0	9.2	56.0
518245	9	13.0	9.9	56.0
518250	10	14.0	10.6	56.0

JACKSON IMPROVED TRACHEOSTOMY TUBES WITH 15 MM ADAPTER - REGULAR LENGTH



Stainless steel. For use with positive pressure and anesthesia units. Adapters are permanently attached and not available as parts. A set consists of an outer tube, inner tube and obturator.

CATALOG #	SIZE	(MM) O.D.	(MM) I.D.	(MM) LENGTH
518426	4	8.0	5.5	63.0
518431	5	9.0	6.2	69.0
518436	6	10.0	7.2	70.0
518441	7	11.0	8.1	70.0
518446	8	12.0	9.2	70.0
518456	10	14.0	10.6	70.0

TRACHEOSTOMY TUBES

Jackson Improved Design

JACKSON IMPROVED TRACHEOSTOMY TUBES WITH 15 MM ADAPTER - SHORT LENGTH



Stainless steel. For use with positive pressure and anesthesia units. Adapters are permanently attached and not available as parts. A set consists of an outer tube, inner tube and obturator.

CATALOG #	SIZE	(MM) O.D.	(MM) I.D.	(MM) LENGTH
518620	4	8.0	5.5	52.0
518625	5	9.0	6.2	56.0
518630	6	10.0	7.2	56.0
518635	7	11.0	8.1	56.0
518640	8	12.0	9.2	56.0

JACKSON IMPROVED TRACHEOSTOMY TUBES MADE IN STERLING SILVER



Sterling silver. An improved model with a rotating lock to provide quick and easy removal of the inner tube. The unobstructed surface of the neckplate eliminates snagging of gauze wipes, and lessened bulk can be more easily hidden beneath patients' clothing. The inert properties of sterling silver construction reduce the allergic reaction to stainless steel. A set consists of an outer tube, inner tube and obturator. These sterling silver Jackson tubes may be used with Tucker Valved Inner Tubes.

CATALOG #	DESCRIPTION	SIZE	(MM) O.D.	(MM) I.D.	(MM) LENGTH
511125	Jackson Rotating Lock #4, inner and outer tubes, obturator	4	8.0	5.3	62.0
511130P	Jackson Rotating Lock #5, inner and outer tubes, obturator	5	9.0	6.1	68.0
511134P	Tucker Valve inner tube only to fit #5 Jackson Improved Tube	5	-	6.1	71.0
511135P	Jackson Rotating Lock #6, inner and outer tubes, obturator	6	10.0	7.1	69.0
511139P	Tucker Valve inner tube only to fit #6 Jackson Improved Tube	6	-	7.1	72.0
511140	Jackson Rotating Lock #7, inner and outer tubes, obturator	7	11.0	8.1	69.0
511144	Tucker Valve inner tube only to fit #7 Jackson Improved Tube	7	-	8.1	72.0
511145P	Jackson Rotating Lock #8, inner and outer tubes, obturator	8	12.0	9.1	69.0
511149	Tucker Valve inner tube only to fit #8 Jackson Improved Tube	8	-	9.1	72.0

TRACHEOSTOMY TUBES

Jackson Improved Design – Shikani Valve Compatible

JACKSON IMPROVED STYLE TRACHEA TUBES FOR USE WITH SHIKANI SPEAKING VALVE



Shikani French Speaking Valve shown attached to Jackson Trachea Tube.

Product codes with an "A" on the end are designed to accept the Shikani-French Speaking Valve. Complete tube consists of inner tube, outer tube and obturator (pictured: outer tube with inner tube insert, obturator). Valve sold separately.

CATALOG #	SIZE	(MM) O.D.	(MM) I.D.	(MM) LENGTH
518025A	4	8.0	5.5	62.0
518029A*	4	8.0	5.5	62.0
518030A	5	9.0	6.2	68.0
518034A*	5	9.0	6.2	68.0
518035A	6	10.0	7.2	69.0
518039A*	6	10.0	7.2	69.0
518040A	7	11.0	8.1	69.0

* These Jackson tubes are fenestrated to facilitate speech. The fenestration is located at a point measured from the neckplate equal to 1/3 of the length of the tube on both the inner and outer tubes.



* Fenestrated Jackson Tube

0 in

1

2

3

4

5

6

7

8

9

TRACHEOSTOMY TUBES

Jackson Improved Design – Shikani Valve Compatible

SHIKANI-FRENCH SPEAKING VALVE AND INNER TUBE COMBINATION



Patients using standard Pilling® Jackson Trachea Tubes can now realize the benefits provided by the Shikani-French Speaking Valve. By replacing the inner trachea tube with one of the tubes listed below, patients can attach the snap-on Shikani Valve. Each inner tube is provided with two speaking valves.

IF YOU ARE USING THIS STANDARD JACKSON TRACHEA TUBE ...	NON-FENESTRATED JACKSON IMPROVED INNER TUBE ONLY WITH 2 SHIKANI VALVES	SIZE (MM)	I.D. (MM)	LENGTH
518025 ORDER	518027	4	5.5	62.0
518030 ORDER	518032	5	6.2	71.0
518035 ORDER	518037	6	7.2	72.0
518040 ORDER	518042	7	8.1	72.0

SHIKANI-FRENCH TRACHEOSTOMY SPEAKING VALVE



A lower airway resistance speaking valve, the Shikani-French Speaking Valve attaches to the standard 15 mm hubs found on plastic and metal tracheostomy tubes. Certain patients may benefit from this unique ball valve design which provides less resistance to airflow at very low flow rates when compared to the membrane valves used on other brands of tracheostomy speaking tubes. The Shikani-French Speaking Valve requires less effort to move air through the valve at low inspiration pressures. Competitive valves are normally in a closed position and require greater inspiratory pressures to initially open the valve and allow airflow. An additional advantage of the Shikani-French Speaking Valve is its low profile, which makes it easy to conceal under clothing.

CATALOG #	DESCRIPTION
518085	Shikani-French Speaking Valve for use with Jackson Improved Stainless Steel Tracheostomy Tubes (package of 2)

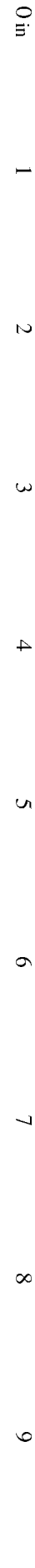

TRACHEOSTOMY TUBES

Jackson Original Design

JACKSON ORIGINAL TRACHEOSTOMY TUBES - REGULAR LENGTH



Stainless steel. These tubes have the neck plate of the original Jackson design with a small swivel lock holding the inner tube in place. A set consists of an outer tube, inner tube and obturator.

CATALOG #	SIZE	(MM) O.D.	(MM) I.D.	(MM) LENGTH
518100	00	4.5	2.4	33.0
518115	2	6.0	3.4	51.0
518120	3	7.0	4.3	58.0
518125	4	8.0	5.5	62.0
518129*	4	8.0	5.5	62.0
518130	5	9.0	6.2	68.0
518134*	5	9.0	6.2	68.0
518135	6	10.0	7.2	69.0
518139*	6	10.0	7.2	69.0
518140	7	11.0	8.1	69.0
518144*	7	11.0	8.1	69.0
518145	8	12.0	9.2	69.0
518149*	8	12.0	9.2	69.0
518150	9	13.0	9.9	69.0
518155	10	14.0	10.6	69.0

* These Jackson tubes are fenestrated to facilitate speech. The fenestration is located at a point measured from the neckplate equal to 1/3 of the length of the tube on both the inner and outer tubes.

* Fenestrated Jackson Tube

JACKSON ORIGINAL TRACHEOSTOMY TUBES - SHORT LENGTH



These tubes follow the original Jackson curve and supply the need for tubes of lengths between regular Jackson and the short Luer tube. A set consists of an outer tube, inner tube and obturator.

CATALOG #	SIZE	(MM) O.D.	(MM) I.D.	(MM) LENGTH
518315	3	7.0	4.3	48.0
518320	4	8.0	5.5	52.0
518325	5	9.0	6.2	56.0
518330	6	10.0	7.2	56.0
518335	7	11.0	8.1	56.0
518340	8	12.0	9.2	56.0

TRACHEOSTOMY TUBES

Jackson Original Design

JACKSON ORIGINAL TRACHEOSTOMY TUBES WITH 15 MM ADAPTER - REGULAR LENGTH



Stainless steel. For use with positive pressure and anesthesia units. Adapters are permanently attached and not available as parts. A set consists of an outer tube, inner tube and obturator.

CATALOG #	SIZE	(MM) O.D.	(MM) I.D.	(MM) LENGTH
518521	3	7.0	4.3	58.0
518526	4	8.0	5.5	62.0
518531	5	9.0	6.2	68.0
518536	6	10.0	7.2	69.0
518541	7	11.0	8.1	69.0
518546	8	12.0	9.2	69.0
518556	10	14.0	10.6	69.0

JACKSON ORIGINAL TRACHEOSTOMY TUBES WITH 15 MM ADAPTER - SHORT LENGTH



Stainless steel. For use with positive pressure and anesthesia units. Adapters are permanently attached and not available as parts. A set consists of an outer tube, inner tube and obturator.

CATALOG #	SIZE	(MM) O.D.	(MM) I.D.	(MM) LENGTH
518720	4	8.0	5.5	52.0
518730	6	10.0	7.2	56.0

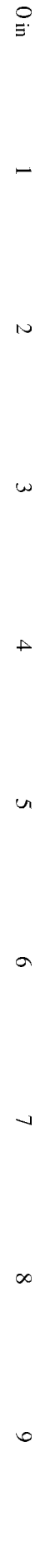

TRACHEOSTOMY TUBES

Tucker Design

TUCKER TRACHEA TUBES AND VALVES



511734

Tucker Tracheostomy Tubes

Sterling silver. Acutely curved to a full 90 degree arc. The neckplate, with small swivel lock, is of a distinctive design for identification purposes. A set consists of an outer tube, inner tube and obturator. Tucker-valved inner tubes (see below) are accessories.



511735

Tucker Speaker Valve

The Tucker Valve is built into an inner tube and allows for normal speech without covering the tube with a finger. The valve opens on inhalation through the tube. On exhalation, the valve leaflet closes, forcing air up through the upper airway. Tucker-valved inner tubes are available for regular length Jackson and Tucker Tubes as a standard item in sizes 4 through 9 in Tucker Tubes, and 4 through 8 in Jackson Tubes. Other sizes and styles are made on special order. The Tucker Valve is for use with sterling silver tubes only. Tucker Valve Inner Tubes are not supplied as part of the regular trachea tube and must be ordered separately. An obturator is supplied with the inner and outer tube sets.

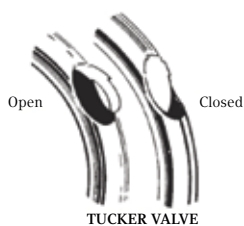

TUCKER VALVE

CATALOG #	DESCRIPTION	(MM) O.D.	(MM) I.D.	(MM) LENGTH
511725	Size 4, inner and outer tubes, obturator	8.0	5.3	55.0
511729	Tucker valve inner tube to fit #4 Tucker tube	-	5.3	58.0
511730	Size 5, inner and outer tubes, obturator	9.0	6.1	60.0
511734	Tucker valve inner tube to fit #5 Tucker tube	-	6.1	63.0
511735	Size 6, inner and outer tubes, obturator	10.0	7.2	60.0
511739	Tucker valve inner tube to fit #6 Tucker tube	-	7.2	63.0
511740	Size 7, inner and outer tubes, obturator	11.0	8.1	60.0
511744	Tucker Valve Inner Tube to fit #7 Tucker Tube	-	8.1	63.0
511745	Size 8, inner and outer tubes, obturator	12.0	9.1	60.0
511749	Tucker Valve Inner Tube to fit #8 Tucker Tube	-	9.1	63.0

TRACHEOSTOMY TUBES

Mayo Design

MAYO CLINIC TUBE



The Mayo Clinic Tube has a Holinger-Style Neckplate on a Jackson Stainless Steel tube.

CATALOG #	SIZE	(MM) O.D.	(MM) I.D.	(MM) LENGTH
511930	5	9.0	6.2	56.0
511940	6	10.0	7.2	56.0
511945	6	10.0	7.2	69.0
511955	7	11.0	8.1	69.0

Holinger Design

HOLINGER TRACHEOSTOMY TUBE



Sterling silver. The tube is attached to the plate-shield at an acute downward angle of 65 degrees rather than the usual 90 degree tube-to-plate alignment. The dimensions of the neckplate are in proportion to the tube size. Corners are rounded; there are no rough projections. Funnel-shaped opening provides for easy insertion of aspirating catheters. A set consists of an outer tube, inner tube and obturator. Available in size 6. Additional sizes available by special order.

CATALOG #	SIZE	(MM) O.D.	(MM) I.D.	(MM) LENGTH
512205	6	10.0	7.1	63.0

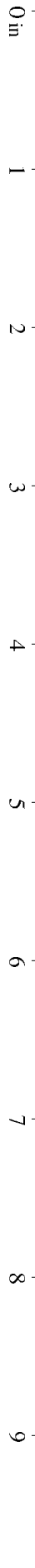

TRACHEOSTOMY TUBES

Luer Design

LUER TRACHEOSTOMY TUBE



Sterling silver. This short model tube is more acutely curved than Jackson types and has the original style neckplate. A set consists of an outer tube, inner tube and obturator. All are 42 mm long. Available in size 6. Additional sizes available by special order.

CATALOG #	SIZE	(MM) O.D.	(MM) I.D.	(MM) LENGTH
511635	6	10.0	7.1	42.0

TRACHEOSTOMY TUBES

Air-Lon® Design

AIR-LON® TRACHEA TUBE INHALATION SETS



Air-Lon® Tracheal Inhalation Cannula Set, nylon, includes an outer cannula, obturator and inner cannula with a permanently attached 15 mm male adapter; sizes 4, 6, 7 and 8.

CATALOG #	SIZE	(MM) O.D.	(MM) I.D.	(MM) INNER LENGTH	(MM) OUTER LENGTH
515106	4	8.0	5.0	62.0	76.0
515116	6	10.0	8.0	72.0	89.0
515121	7	11.0	9.0	76.0	95.0
515126	8	12.0	10.0	81.0	102.0

AIR-LON® TRACHEA TUBES



Air-Lon® Trachea Tube, nylon, 90 degree arc; sizes 4 through 8.

CATALOG #	SIZE	(MM) O.D.	(MM) I.D.	(MM) INNER LENGTH	(MM) OUTER LENGTH
515105	4	8.0	5.0	62.0	76.0
515110	5	9.4	7.0	65.0	83.0
515115	6	10.0	8.0	72.0	89.0
515120	7	11.0	9.0	76.0	95.0
515125	8	12.0	10.0	81.0	102.0

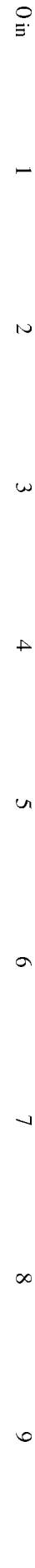

TRACHEOSTOMY TUBES

Laryngectomy Style Tubes

HOLINGER LARYNGECTOMY TUBES



516270

Sterling silver. The cannula is attached to the plate at an acute downward angle of approximately 65 degrees. The shield is shaped carefully to be flat and with no projections to catch gauze. Rotating lock mechanism. A set consists of outer tube, inner tube and obturator.

CATALOG #	SIZE	(MM) O.D.	(MM) I.D.	(MM) LENGTH
516270	7	12.0	9.0	50.0
516275	8	13.6	10.0	50.0
516280	9	14.0	10.6	50.0
516285	10	14.3	11.2	50.0

JACKSON LARYNGECTOMY TUBES



519005

Stainless steel. These tubes have the standard Jackson curve with an improved neckplate. The rotating lock provides a protrusion-free surface for ease in wiping. Flattened shape allows neckplate to be hidden more easily beneath clothing. A set consists of outer tube, inner tube and obturator.

CATALOG #	SIZE	(MM) O.D.	(MM) I.D.	(MM) LENGTH
519000	6	10.0	7.2	55.0
519005	7	12.0	9.1	55.0
519010	8	13.6	10.0	55.0
519015	9	14.0	10.7	55.0
519020	10	14.5	11.1	55.0
519025	11	15.4	12.3	55.0
519030	12	16.4	12.7	55.0

TRACHEOSTOMY TUBES

Laryngectomy Style Tubes

MARTIN LARYNGECTOMY TUBES - REGULAR AND EXTENSION



516390

Sterling silver. The Martin Cannula is short length and is attached to the neckplate shield at an acute downward angle. These tubes are available as a regular set consisting of outer tube, inner tube, and obturator. Martin Tubes are also available with the dressing extension cannula, a 2.5 mm extension projecting proximally to extend out past thick, bulky dressings. The Martin Extension set consists of outer tube, standard inner tube, special extension inner tube and obturator.

Regular Sets

COMPLETE TUBE	SIZE	(MM) O.D.	(MM) I.D.	(MM) LENGTH
516390	10	14.0	10.6	43.0
516400	12	16.3	12.7	43.0

Extension Set

COMPLETE TUBE	SIZE	(MM) O.D.	(MM) I.D.	(MM) LENGTH
516430	6	16.3	12.7	43.0

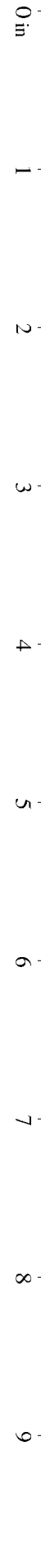

TRACHEOSTOMY TUBES

Trach Buttons

NORRIS TRACHEOSTOMY BUTTONS



512780

Useful in preventing contracture of the tracheal stoma. Machined of white PTFE.

CATALOG #	(MM) I.D.	(MM) A	(MM) B
512780	8.3	19.0	11.0
512782	9.1	19.0	12.0
512784	10.3	19.0	13.0

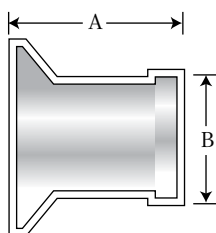

TRACHEOSTOMY TUBES

Decannulation Stoppers

DECANNULATION STOPPERS



1037806



1037816



1037826



1037836

A variety of colored, tapered plastic plugs with attached cords for insertion into the inner cannula of a trachea tube to obstruct, or partially obstruct, the lumen during decannulation. Available in four styles. Full-size plugs often used as catheter plugs.

CATALOG #	SIZE	COLOR	CLOSURE
1037800	0	Yellow	1/4
1037801	1	Yellow	1/4
1037802	2	Yellow	1/4
1037803	3	Yellow	1/4
1037804	4	Yellow	1/4
1037805	5	Yellow	1/4
1037806	6	Yellow	1/4
1037807	7	Yellow	1/4
1037808	8	Yellow	1/4
1037809	9	Yellow	1/4

1037810	0	Green	1/2
1037811	1	Green	1/2
1037812	2	Green	1/2
1037813	3	Green	1/2
1037814	4	Green	1/2
1037815	5	Green	1/2
1037816	6	Green	1/2
1037817	7	Green	1/2
1037818	8	Green	1/2
1037819	9	Green	1/2

1037820	0	Purple	3/4
1037821	1	Purple	3/4
1037822	2	Purple	3/4
1037823	3	Purple	3/4
1037824	4	Purple	3/4
1037825	5	Purple	3/4
1037826	6	Purple	3/4
1037827	7	Purple	3/4
1037828	8	Purple	3/4
1037829	9	Purple	3/4

1037830	0	White	Full
1037831	1	White	Full
1037832	2	White	Full
1037833	3	White	Full
1037834	4	White	Full
1037835	5	White	Full
1037836	6	White	Full
1037837	7	White	Full
1037838	8	White	Full
1037839	9	White	Full



TRACHEOSTOMY TUBES

Tracheal Dilators

JACKSON-TROUSSEAU TRACHEAL DILATORS



514376

2-blade design.

CATALOG #	DESCRIPTION
514375	Infant, tip width 4.0 mm, tip length 25.5 mm, 5-1/2" (14 cm)
514376	Child, tip width 4.4 mm, tip length 17.5 mm, 5-1/2" (14 cm)
514377	Adult, tip width 5.2 mm, tip length 25.5 mm, 5-1/2" (14 cm)

LABORDE TRACHEAL DILATOR



514380

3-blade design.

CATALOG #	DESCRIPTION
514380	5-1/2" (14 cm)

TRACHEOSTOMY TUBES

Miscellaneous

NEWS TRACHEA RETRACTOR



CATALOG #	DESCRIPTION
070114	Sharp, 10 mm hook, 5-7/8" (15 cm)

LUKENS THYMUS RETRACTOR



CATALOG #	DESCRIPTION
514412	Blade 3/8" wide x 1/4" deep (9 x 6 mm), Overall length 6-7/8" (17.5 cm)

JACKSON TRACHEAL TENACULUM



CATALOG #	DESCRIPTION
514413	Hook depth 1/4" (0.5 cm), 5-1/4" (13.5 cm)

JACKSON TRACHEAL RETRACTOR, DOUBLE-ENDED



Pilling® Pattern, satin finish.

CATALOG #	DESCRIPTION
514414	Double-pronged, 1" wide x 1/4" deep (2.5 cm x 0.5 cm) blade, 6-7/8" (17.5 cm)

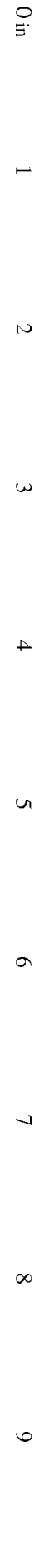

TRACHEOSTOMY TUBES

Miscellaneous

JACKSON TRACHEA RETRACTOR



Weck® Pattern, bright finish.

CATALOG #	DESCRIPTION
070116	2 prongs, 7" (18 cm)

BERNAY FINGER RAKE TRACHEAL RETRACTORS

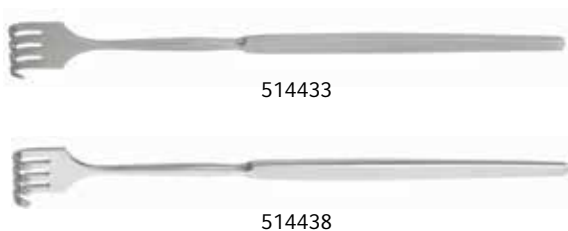

CATALOG #	DESCRIPTION
514430	1 prong, sharp, 6-5/8" (17 cm)
514431	2 prongs, sharp, 6-5/8" (17 cm)
514433	3 prongs, sharp, 6-5/8" (17 cm)
514435	1 prong, blunt, 6-5/8" (17 cm)
514436	2 prongs, blunt, 6-5/8" (17 cm)
514437	3 prongs, blunt, 6-5/8" (17 cm)
514438	4 prongs, blunt, 6-5/8" (17 cm)



TRACHEOSTOMY TUBES

Cleaning Brushes

HOLMAN TRACHEA TUBE BRUSHES



508545

For loosening hardened secretions not freed by washing.

CATALOG #	DESCRIPTION
508545	Set of three: small, medium, large
508546	Trachea tube brush, small 6.5 mm x 14.5 cm
508547	Trachea tube brush, medium 8 mm x 15 cm
508548	Trachea tube brush, large 9 mm x 20 cm

HOLMAN SCOPE BRUSHES - FOR BRONCHOSCOPES AND ESOPHAGOSCOPES



508540

For loosening hardened secretions not freed by washing.

CATALOG #	DESCRIPTION
508540	Set of three: small, medium, large
508541	Brush for large scopes, 15 mm x 62 cm
508542	Brush for medium scopes, 11 mm x 56 cm
508543	Brush for small scopes, 9 mm x 49 cm
508544	Special extra small brush for infant scopes, 6 mm x 46 cm

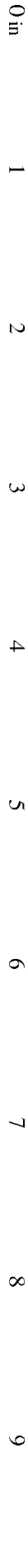

EAR INSTRUMENTS

Curettes

BILLEAU EAR LOOPS



411231

CATALOG #	DESCRIPTION
411230	Small, #1, 6-1/2" (16.5 cm)
411231	Medium, #2, 6-1/2" (16.5 cm)
411232	Large, #3, 6-5/8" (17 cm)

BUCK EAR CURETTES



411202

Blunt, 6-1/2" (16.5 cm).

CATALOG #	DESCRIPTION
411200	Size 00
411201	Size 0
411202	Size 1
411203	Size 2
411204	Size 3

DAY EAR HOOK



411241

CATALOG #	DESCRIPTION
411241	Small, #2, 6-3/4" (17 cm)



EAR INSTRUMENTS

Curettes

HOUSE CURETTES



7" (17.7 cm), Blade A 1.8 mm, Blade B 1.5 mm.

CATALOG #	DESCRIPTION
020300	Strongly angled
020302	Lightly angled

Elevators

HOUSE RETRACTOR



Double-ended.

CATALOG #	DESCRIPTION
029350	Blade A 20 x 7 mm, blade B 24 x 9.5 mm, 6" (15 cm)

Forceps

ALLIGATOR FORCEPS



Serrated jaws.

CATALOG #	DESCRIPTION
020120	6 mm, shaft 3-1/8" (8 cm)
020121	4.5 mm, shaft 3-1/8" (8 cm)

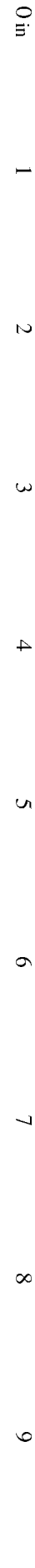

EAR INSTRUMENTS

Forceps

HARTMANN ALLIGATOR FORCEPS



KM55164

CATALOG #	DESCRIPTION
KM55164	Serrated, 12 mm jaw, 6-1/2" (16.5 cm)

HOUSE ALLIGATOR FORCEPS



020100

CATALOG #	DESCRIPTION
020100	Serrated, 8 mm jaws, shaft 3-1/8" (8 cm)

HARTMANN EAR DRESSING FORCEPS



411520

CATALOG #	DESCRIPTION
411520	Serrated, 2.5 x 7 mm jaws, 5-1/8" (13 cm)
KM55188	Delicate, serrated, 2.2 mm x 7 mm jaws, 5" (12.5 cm)

MICROMINIATURE ALLIGATOR FORCEPS



020571

CATALOG #	DESCRIPTION
020571	Straight, serrated, ebonized, shaft 3-1/8" (8 cm)



EAR INSTRUMENTS

Forceps

HOUSE STRUT FORCEPS



CATALOG #	DESCRIPTION
020130	Smooth jaws, 5 mm, 3-1/8" (8 cm)

TOBEY EAR FORCEPS



CATALOG #	DESCRIPTION
411515	Serrated, 2 x 3 mm jaws, working length 2" (5 cm)

NOYES EAR FORCEPS



CATALOG #	DESCRIPTION
411525	Serrated, 2 x 10 mm jaws, 3-1/2" (9 cm)

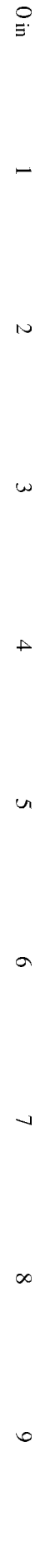

EAR INSTRUMENTS

Forceps

HARTMANN-HERZFELD CUP FORCEPS



Straight.

CATALOG #	DESCRIPTION
411535	2 mm cups, shaft length 3-3/8" (9 cm)
411540	3 mm cups, shaft length 3-3/8" (9 cm)

ROUND CUP FORCEPS



CATALOG #	DESCRIPTION
020165	0.75 mm cup jaws, shaft 3-1/8" (8 cm)

OVAL SPOON FORCEPS



CATALOG #	DESCRIPTION
020155	Straight, 1 mm cup, 3-1/8" (8 cm)



EAR INSTRUMENTS

Forceps

WILDE EAR FORCEPS



KM57176

CATALOG #	DESCRIPTION
KM57176	Angular, delicate, serrated, 4-1/8" (10.5 cm)

Scissors

BELLUCCI ALLIGATOR SCISSORS



020210

CATALOG #	DESCRIPTION
020210	Curved right, 5 mm blades, shaft 3-3/8" (8.5 cm)
020211	Curved left, 5 mm blades, shaft 3-3/8" (8.5 cm)

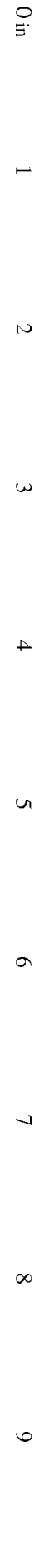

EAR INSTRUMENTS

Scissors

HOUSE BELLUCCI MINI ALLIGATOR SCISSORS



CATALOG #	DESCRIPTION
020204	Straight, sharp, 4.5 mm blades, 3-1/8" (8 cm)

Specula

BOUCHERON EAR SPECULUM



025101

Round.

CATALOG #	DESCRIPTION
025100	Complete set of four
025101	Size 1, diameter 3 mm
025102	Size 2, diameter 3.5 mm
025103	Size 3, diameter 4.5 mm
025104	Size 4, diameter 5 mm



EAR INSTRUMENTS

Specula

FARRIER OVAL SPECULUM



025163

Oval.

CATALOG #	DESCRIPTION
025160	Size 3 x 4 mm
025162	Size 4 x 5 mm
025163	Size 4.5 x 5.5 mm
025164	Size 5 x 6 mm
025165	Size 5.5 x 6.5 mm
025166	Size 6 x 7 mm
025167	Size 6.5 x 7.5 mm
025168	Size 7 x 8 mm
025169	Size 7.5 x 8.5 mm

HARTMANN EAR SPECULUM



411140

Round and oval.

CATALOG #	DESCRIPTION
411140	Round, chrome plated, set of four
411145	Oval, chrome plated, set of four

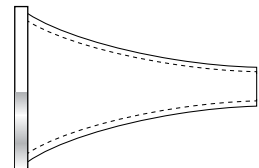
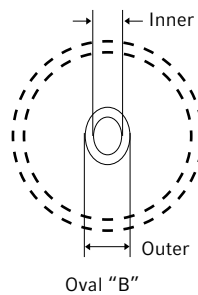
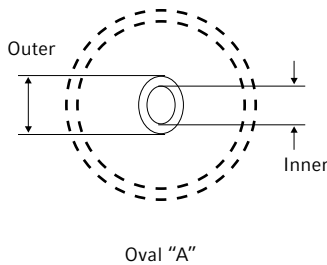
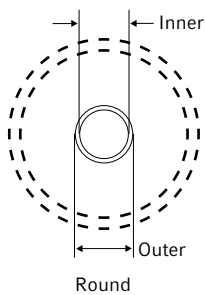
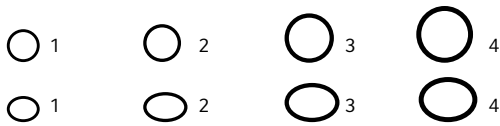

CATALOG #	SHAPE	SIZE 1		SIZE 2		SIZE 3		SIZE 4	
		I.D.	O.D.	I.D.	O.D.	I.D.	O.D.	I.D.	O.D.
411140	Round	3 mm	4 mm	4 mm	5 mm	5.5 mm	6.5 mm	7 mm	8 mm
411145	Oval A	3.5 mm	4.5 mm	4.5 mm	5.5 mm	5.5 mm	6.5 mm	6.5 mm	7.5 mm
	Oval B	2.5 mm	3.5 mm	3.5 mm	4.5 mm	4.5 mm	5.5 mm	5.5 mm	6.5 mm

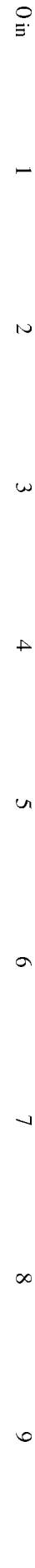

EAR INSTRUMENTS

Specula

GRUBER EAR SPECULUM

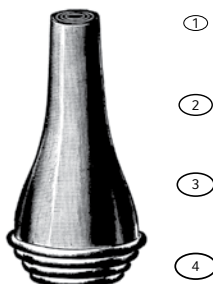

KM56172

Oval. Adult, chrome.

CATALOG #	DESCRIPTION
KM56168	# 1, 4 x 5 mm
KM56170	# 2, 5 x 6 mm
KM56172	# 3, 6 x 7 mm
KM56174	# 4, 7 x 8 mm

ENDAURAL EAR SPECULUM



029480

CATALOG #	DESCRIPTION
029480	26 mm blade, strongly curved shaft, 5-5/8" (14.5 cm)

Miscellaneous

FARRELL (LATHBURY) APPLICATOR



411165

CATALOG #	DESCRIPTION
411165	Twisted end, 6-1/4" (16 cm)
411166	Triangular end, 6-3/8" (16 cm)



EAR INSTRUMENTS

Miscellaneous

MYRINGOTOMY KNIFE



026510

CATALOG #	DESCRIPTION
026510	Straight, 7 x 2 x 0.5 mm blade, 6-1/2" (16.5 cm)

GROSS SPOON AND HOOK



KM56104

CATALOG #	DESCRIPTION
KM56104	3.5 mm diameter spoon, 4 mm right angle hook, 4-3/4" (12 cm)

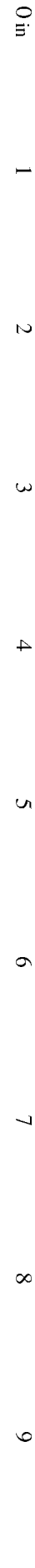

NASAL INSTRUMENTS

Elevators

BOIES NASAL ELEVATOR

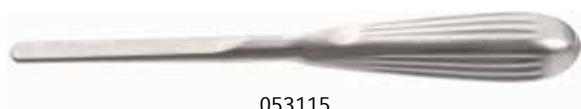

053115

CATALOG #	DESCRIPTION
053115	Straight, 9.5 mm tip, 7-3/4" (19.5 cm)

GOLDMAN SEPTUM DISPLACER



441730

CATALOG #	DESCRIPTION
441730	6.5 mm wide, 8" (20.5 cm)

COTTLE DOUBLE-ENDED ELEVATOR



053135

CATALOG #	DESCRIPTION
053135	Blade A 5 mm, blade B 3 mm, graduated in 10 mm increments, 8-7/8" (22.5 cm)

FREER DOUBLE-ENDED ELEVATORS



036500

Curved, sharp and blunt blades. Weck® Pattern, bright finish. 7-1/2" (19 cm).

CATALOG #	DESCRIPTION
036500	Narrow, 4.5 mm
036501	Wide, 6.5 mm

FREER DOUBLE-ENDED ELEVATOR



355194

Pilling® Pattern, satin finish.

CATALOG #	DESCRIPTION
355194	Blades are sharp and blunt, 4.5 mm wide, 7" (18 cm)

NASAL INSTRUMENTS

Elevators

FREER DOUBLE-ENDED ELEVATOR



KM57614

CATALOG #	DESCRIPTION
KM57614	Curved, sharp and blunt blades, 5 mm wide, 7-1/2" (19 cm)

GILLIES ZYGOMA ELEVATOR



441740

CATALOG #	DESCRIPTION
441740	1/4" (6 mm) blade, angled, 9" (23 cm)

JOSEPH PERIOSTEAL ELEVATOR



053120

CATALOG #	DESCRIPTION
053120	Curved, 4 mm blade, 6-3/4" (17 cm)

MCKENTY ELEVATOR



053102

CATALOG #	DESCRIPTION
053102	Curved, 5 mm blade, 5" (12.5 cm)

KLEINERT KUTZ ELEVATOR AND DISSECTOR



KM57615

CATALOG #	DESCRIPTION
KM57615	2 mm x 3 mm sharp ends, 7-5/8" (19.5 cm)

ALLERDYCE ELEVATOR AND DISSECTOR



KM57616

CATALOG #	DESCRIPTION
KM57616	8 mm semi-sharp and 8 mm blunt ends, 7-1/2" (19 cm)

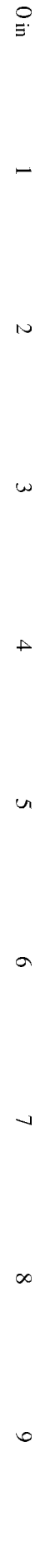

NASAL INSTRUMENTS

Forceps

ALLIGATOR NASAL FORCEPS



CATALOG #	DESCRIPTION
057150	Serrated 10 x 1 mm jaw, shaft 7" (18 cm)

NOYES NASAL ALLIGATOR FORCEPS



CATALOG #	DESCRIPTION
431325	Straight, serrated, 8 x 2 mm jaw, shaft 5-1/2" (14 cm)

BLAKESLEY NASAL FORCEPS



CATALOG #	DESCRIPTION
031430	Serrated, 13.5 x 7 mm jaw, shaft 7-1/2" (19 cm)



NASAL INSTRUMENTS

Forceps

TAKAHASHI FORCEPS



CATALOG #	DESCRIPTION
431360	2.5 mm wide, 4-7/8" (12.5 cm)
431362	4 mm wide, 4-7/8" (12.5 cm)

WILDE (BLAKESLEY) NASAL FORCEPS



Fenestrated cup, pointed tip.

CATALOG #	DESCRIPTION
431366	Medium, 10.5 x 4 mm jaw, 4-7/8" (12.5 cm)

RUBIN SEPTAL MORSELIZER



CATALOG #	DESCRIPTION
056650	Double-action serrated jaw, 15 x 4 mm, 8-1/4" (21 cm)

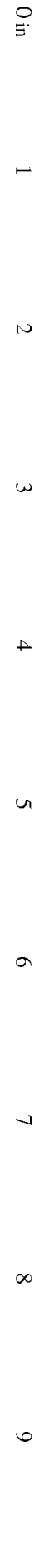

NASAL INSTRUMENTS

Forceps

JANSEN-MIDDLETON NASAL RONGEURS



CATALOG #	DESCRIPTION
031500	Thru cutting cup 13 x 4 mm, shaft 3-1/2" (9 cm)
031502	Thru cutting cup 14 x 5 mm, shaft 3-7/8" (10 cm)
031505	Spoon shaped biting cup 15 x 5 mm, shaft 3-5/16" (8.5 cm)

ASCH SEPTUM FORCEPS



CATALOG #	DESCRIPTION
443610	Angled, 28 mm tip, 9-1/8" (23 cm)

COTTLE COLUMELLA FORCEPS



CATALOG #	DESCRIPTION
443480	12 mm tip width, 4-3/8" (11 cm)



NASAL INSTRUMENTS

Knives

BALLENGER KNIVES



036111

Swivel knife.

CATALOG #	DESCRIPTION
036110	Straight 3 mm blade, 8" (20.5 cm)
036111	Straight 4 mm blade, 7-1/2" (19 cm)

COTTLE KNIFE GUIDE AND RETRACTOR



050190

CATALOG #	DESCRIPTION
050190	Delicate, knife guide 4 mm, retractor 14.5 mm, 7-3/4" (19.5 cm)

COTTLE NASAL KNIFE



050120

CATALOG #	DESCRIPTION
050120	Straight 32 x 5 mm blade, 5-5/8" (14.5 cm)

FREER D MODEL SEPTUM KNIFE



036100

CATALOG #	DESCRIPTION
036100	8 mm blade, 6-1/2" (16.5cm)

Osteotomes

ANDERSON-NIEVERT OSTEOTOMES



051191

Curved, 8" (20.5 cm).

CATALOG #	DESCRIPTION
051190	Right
051191	Left
051195	Straight

COTTLE OSTEOTOMES



051152

Rounded corners, 7-1/4" (18.5 cm).

CATALOG #	DESCRIPTION
051150	4 mm
051152	6 mm
051155	9 mm
051158	12 mm

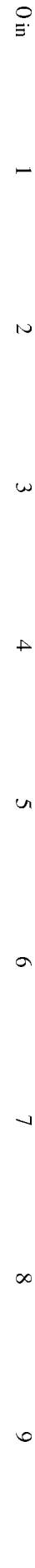

NASAL INSTRUMENTS

Osteotomes

MINI OSTEOTOMES



441208

Curved, 5" (12.5 cm).

CATALOG #	DESCRIPTION
441207	4 mm
441208	6 mm

LAMBOTTE-STYLE OSTEOTOMES



051086

5" (12.5 cm), flat thin blade.

CATALOG #	DESCRIPTION
051082	2 mm
051084	4 mm
051086	6 mm
051088	8 mm
051090	10 mm
051092	12 mm
051095	15 mm

HEX-HANDLE OSTEOTOMES



051104

6" (15.2 cm), flat thin blade.

CATALOG #	DESCRIPTION
051102	2 mm
051103	3 mm
051104	4 mm
051105	5 mm
051106	6 mm
051107	7 mm
051109	9 mm
051110	10 mm

Raspatories

AUFRICHT RASP



052162

CATALOG #	DESCRIPTION
052162	Curved, up-cutting blade, 25 x 9 mm, 8" (20.5 cm)



NASAL INSTRUMENTS

Raspatories

AUFRICHT-GLABELLA RASP



052165

CATALOG #	DESCRIPTION
052165	Up and down-cutting, curved blade, 9 x 30 mm, 7-1/2" (19 cm)

CONVERSE RASP



052180

CATALOG #	DESCRIPTION
052180	Double-ended, fine and course serrations, 7-1/8" (18 cm)

COTTLE RASP



052130

CATALOG #	DESCRIPTION
052130	Straight, down-cutting blade, 36 x 9 mm, 8-1/4" (21 cm)

JOSEPH RASP



441530

CATALOG #	DESCRIPTION
441530	Fine serrations, 6 -7/8" (15.5 cm)



NASAL INSTRUMENTS

Raspatories

KLEINERT-KUTZ RASP



441555

CATALOG #	DESCRIPTION
441555	4-sided tips, 7.5 mm wide, 8-5/8" (22 cm)

MALTZ RASP



052100

CATALOG #	DESCRIPTION
052100	Straight, down-cutting blade, 37 x 6 mm, 7-1/8" (18 cm)

WIENER ANTRUM RASP



037101

CATALOG #	DESCRIPTION
037101	Medium, 4 mm trocar point, 7-7/8" (20 cm)

NASAL INSTRUMENTS

Scissors

BECKER SEPTUM SCISSORS



CATALOG #	DESCRIPTION
431425	3/4" (2 cm) serrated blades, 7" (18 cm)

CAPLAN NASAL SCISSORS



CATALOG #	DESCRIPTION
031750	20 mm serrated blades angled 45 degrees, 7" (18 cm)

FOMAN NASAL SCISSORS



CATALOG #	DESCRIPTION
056400	40 mm angled, straight, smooth blades, 5-1/2" (14 cm)

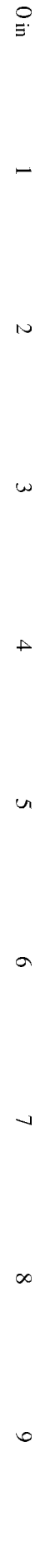

NASAL INSTRUMENTS

Scissors

FOMON LOWER LATERAL SCISSORS



CATALOG #	DESCRIPTION
056360	25 mm strongly curved blades, 5-1/4" (13.5 cm)

KNIGHT NASAL SCISSORS



CATALOG #	DESCRIPTION
031800	42 mm blades angled 30 degrees, 6-1/4" (16 cm)

RHINOPLASTY FLAT TIP SCISSORS



CATALOG #	DESCRIPTION
056302	35 mm curved blades, flat dissecting tips, 5-3/8" (13.5 cm)



NASAL INSTRUMENTS

Sinus Instruments

FESS SINOSCOPY FORCEPS



431433

CATALOG #	DESCRIPTION
431433	Serrated, 5-3/4" (14.5 cm)

THRU-CUT FORCEPS



431437

CATALOG #	DESCRIPTION
431437	Serrated upper jaw, 5-3/4" (14.5 cm)

BACKBITER FORCEPS



431440

CATALOG #	DESCRIPTION
431440	Straight, jaw 1.5 x 6 mm, 7" (18 cm)



NASAL INSTRUMENTS

Sinus Instruments

SIDE BITER FORCEPS



CATALOG #	DESCRIPTION
431445	Right-side downward cut, 3 mm tip, 5-1/8" (13 cm)
431446	Left-side downward cut, 3 mm tip, 5-1/8" (13 cm)

431446

KERRISON THRU-CUT RONGEURS



CATALOG #	DESCRIPTION
431451	Curved 30 degrees, 7-7/8" (20 cm)
431452	Curved 70 degrees, rotating, working length 5-5/8" (14.5 cm)
431461	Straight, rotating, working length 4-3/4" (12 cm)
431462	Angled 30 degrees, 8" (20.5 cm)
431463	Angled 45 degrees, 7-3/4" (19.5 cm)

431451



431461

FRONTAL SINUS THRU-CUT FORCEPS

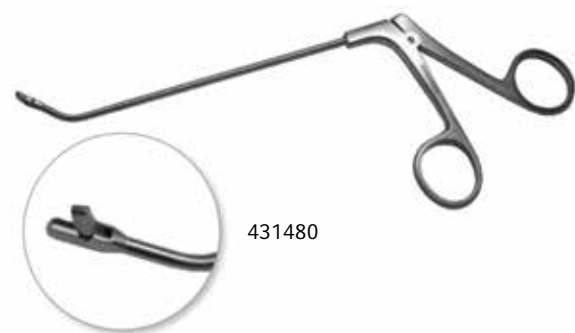

CATALOG #	DESCRIPTION
431480	3.5 mm tip, 8-5/8" (22 cm), 5-1/8" (13 cm)

431480



NASAL INSTRUMENTS

Sinus Instruments

FRONTAL SINUS FORCEPS



CATALOG #	DESCRIPTION
431481	5-1/8" (13 cm)

SINUS SEEKERS



CATALOG #	DESCRIPTION
431710	Maxillary Seeker: 1.5 mm and 1.8 mm ball tips, 8-1/8" (20.5 cm)
431711	Frontal Seeker: 1.8 mm ball tip and 0.9 mm tip, 7-7/8" (20 cm)

FRONTAL SINUS CURETTES

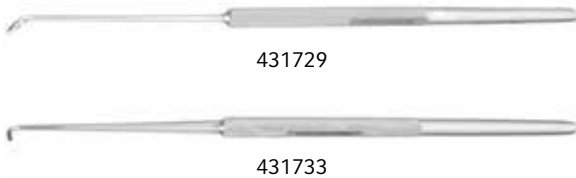

CATALOG #	DESCRIPTION
431728	Angled, 45 degrees, 2.8 mm tip, 7-1/2" (19 cm)
431729	Angled, 45 degrees, 3.5 mm tip, 7-5/8" (19.5 cm)
431732	Angled, 90 degrees, 2.8 mm tip, 7-1/2" (19 cm)
431733	Angled, 90 degrees, 3.5 mm tip, 7-5/8" (19.5 cm)

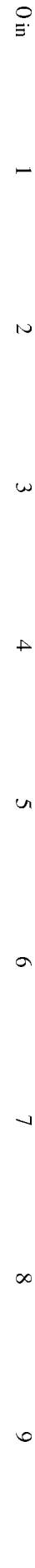

NASAL INSTRUMENTS

Snares

BRUENING BAYONET NASAL SNARE



037500

CATALOG #	DESCRIPTION
037500	9" (23 cm)

KRAUSE NASAL SNARES

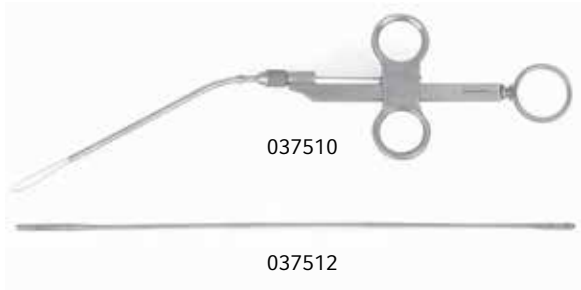

037510

037512

CATALOG #	DESCRIPTION
037510	10" (25.5 cm)
037512	Stylet only

NASAL SNARE WIRES



070704

4-3/8" (11 cm) precut. 144 per package.

CATALOG #	DESCRIPTION
070701	4 Ga., nose
070702	5 Ga., nose
070704	7 Ga., throat
070705	8 Ga., throat
070706	9 Ga., throat



NASAL INSTRUMENTS

Specula

TIECK INFANT NASAL SPECULUM



030100

CATALOG #	DESCRIPTION
030100	18 mm blade, spread 28 mm, 5-1/2" (14 cm)

SONNENSCHNCHILD NASAL SPECULUM



030180

CATALOG #	DESCRIPTION
030180	Small, 27 mm blade, spread 28 mm, angled 80 degrees, 6" (15 cm)

KILLIAN NASAL SPECULUMS



030303

Removable spring. 5-1/8" (13 cm).

CATALOG #	DESCRIPTION
030301	Size 1, 45 mm blade
030302	Size 2, 55 mm blade
030303	Size 3, 65 mm blade
030304	Size 4, 80 mm blade



NASAL INSTRUMENTS

Specula

COTTLE SEPTUM SPECULUM



431130

CATALOG #	DESCRIPTION
431130	5 cm blade, with locking screw, 5-1/2" (14 cm)

VIENNA NASAL SPECULUMS



431111

CATALOG #	DESCRIPTION
431110	Small, #1, 28 mm blade, 5-1/4" (13.5 cm)
431111	Medium, #2, 30 mm blade, 5-3/8" (13.5 cm)
431112	Large, #3, 33 mm blade, 5-3/8" (13.5 cm)

PECK-VIENNA NASAL SPECULUM



431120

CATALOG #	DESCRIPTION
431120	29 mm blade, 5-3/8" (13.5 cm)

NASAL INSTRUMENTS

Miscellaneous

AUFRICHT NASAL RETRACTOR



054720

CATALOG #	DESCRIPTION
054720	Small blade, 40 x 8 mm, angled shaft, 6-3/4" (17 cm)

CUTTING BLOCK



411331

CATALOG #	DESCRIPTION
411331	Made of POM (polyoxymethylene), 3" x 1-1/2" x 3/8" (7.5 x 4 x 1 cm)



MOUTH AND THROAT INSTRUMENTS

Adenotomes/Tonsillectomes

ADENOTOME BLADES



070522

Use with LaForce and Shambaugh Adenotomes.
Slanted catch knob.

CATALOG #	DESCRIPTION
070521	No. 1, small, 55 x 12.5 mm
070522	No. 2, medium, 55 x 16 mm
070523	No. 3, large, 55 x 19 mm

LA FORCE ADENOTOMES



070502

9" (23 cm).

CATALOG #	DESCRIPTION
070501	No. 1, small, blade 25 x 16 mm
070502	No. 2, medium, blade 26 x 19 mm
070503	No. 3, large, blade 30 x 22 mm

SHAMBAUGH REVERSE CURVE ADENOTOMES



070511

8-5/8" (22 cm).

CATALOG #	DESCRIPTION
070511	No. 1, small, blade 25 x 16 mm
070512	No. 2, medium, blade 26 x 19 mm

WECK DANIELS BLADES



070605

CATALOG #	DESCRIPTION
070604	No. 1, for 070600 (pg. 522)
070605	No. 2, for 070601



MOUTH AND THROAT INSTRUMENTS

Adenotomes/Tonselectomes

WECK DANIELS TONSILLECTOME



070600

4-1/2" (11.5 cm) fluted handle, overall 7-1/8" (18 cm).

CATALOG #	DESCRIPTION
070600	No. 1, 18 mm blade, 17 mm fenestration

Curettes

BARNHILL ADENOID CURETTES



461352

CATALOG #	DESCRIPTION
461350	# 0, 8-1/2" (21.5 cm)
461351	# 1, 8-1/2" (21.5 cm)
461352	# 2, 8-1/2" (21.5 cm)
461353	# 3, 8-1/2" (21.5 cm)
461354	# 4, 8 5/8" (22 cm)

SHAMBAUGH ADENOID CURETTES



072122

Reverse curve.

CATALOG #	DESCRIPTION
072120	Size 0, 11 x 13 mm, 8-1/4" (21 cm)
072122	Size 2, 15 x 18 mm, 8-1/4" (21 cm)
072124	Size 4, 19 X 22 mm, 8-1/4" (21 cm)

MOUTH AND THROAT INSTRUMENTS

Forceps

COLLINS TONGUE SEIZING FORCEPS



CATALOG #	DESCRIPTION
452510	Straight, 6-3/4" (17 cm)

COLVER COAKLEY TONSIL FORCEPS



CATALOG #	DESCRIPTION
461600	Straight, 7-1/2" (19 cm)
461605	Curved, 7-1/2" (19 cm)

MAGILL CATHETER FORCEPS

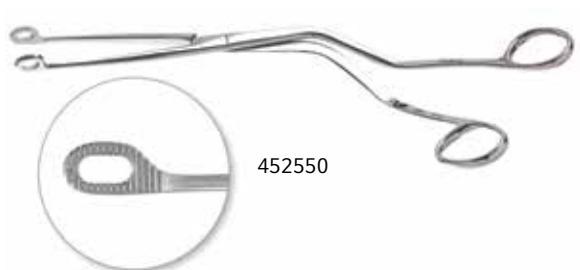

Catheter introducing forceps with cross serration.

CATALOG #	DESCRIPTION
452550	Adult, 9-1/4" (23.5 cm)
452551	Child, 7-1/8" (18 cm)



MOUTH AND THROAT INSTRUMENTS

Forceps

WHITE TONSIL FORCEPS



461615

Curved.

CATALOG #	DESCRIPTION
461610	7-1/8" (18 cm)
461615	9-1/2" (24 cm)

Laryngeal Mirrors

LARYNGEAL MIRRORS



508204

Extra thin, permanently mounted on handle.
Shaft length is 6-3/4" (17 cm). 8" overall length.

CATALOG #	DESCRIPTION
508200	#000, 8 mm diameter
508201	#00, 10 mm diameter
508202	#0, 12 mm diameter
508203	#1, 16 mm diameter
508204	#2, 18 mm diameter
508205	#3, 20 mm diameter
508206	#4, 22 mm diameter
508207	#5, 24 mm diameter
508208	#6, 28 mm diameter
508209	#7, 30 mm diameter

Mouth Gags

DAVIS & MCIVOR LEFT TONGUE BLADES

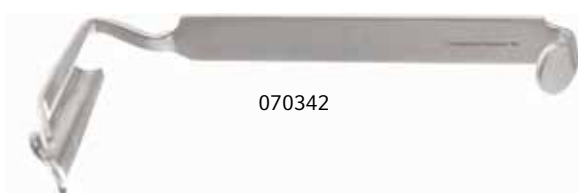

070342

6" (15 cm), for use with right bite Davis Mouth Gags.

CATALOG #	DESCRIPTION
070340	Blade Size 2, 2-7/16" x 15/16" (62 x 24 mm)
070342	Blade Size 3, 3" x 1-1/16" (76 x 27 mm)
070344	Blade Size 4, 3-9/16" x 1-5/16" (90 x 34 mm)

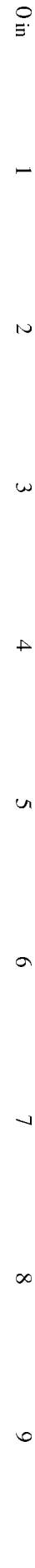

MOUTH AND THROAT INSTRUMENTS

Mouth Gags

DAVIS & MCIVOR RIGHT TONGUE BLADES



6" (15 cm), for use with left bite Davis Mouth Gags.

CATALOG #	DESCRIPTION
070330	Blade Size 2, 2-7/16" x 15/16" (62 x 24 mm)
070332	Blade Size 3, 3" x 1-1/16" (76 x 27 mm)
070334	Blade Size 4, 3-9/16" x 1-5/16" (90 x 34 mm)

DAVIS MOUTH GAG BLADE, SIZE 2



Without either tubes, fits Davis Mouth Gags only.

CATALOG #	DESCRIPTION
070312	Size 2, 70 x 24 mm blade



MOUTH AND THROAT INSTRUMENTS

Mouth Gags

DAVIS MOUTH GAGS



070300



070303

Double bite with silicone liner.

CATALOG #	DESCRIPTION
070300	Adult, right bite, 15 x 13 mm block, 80 mm spread, 6-1/8" (15.5 cm)
070301	Adult, left bite, 15 x 13 mm block, 80 mm spread, 6-1/8" (15.5 cm)
070302	Child, right bite, 15 x 9 mm block, 70 mm spread, 5-1/2" (14 cm)
070303	Child, left bite, 15 x 9 mm block, 70 mm spread, 5-1/2" (14 cm)
070305	One dozen replacement silicone liners for both Adult and Child



070305

DINGMAN MOUTH GAG



070450

CATALOG #	DESCRIPTION
070450	Set, frame with 3 blades (64 x 25 mm, 70 x 29 mm, 62 x 30 mm), 5-3/4" (14.5 cm)

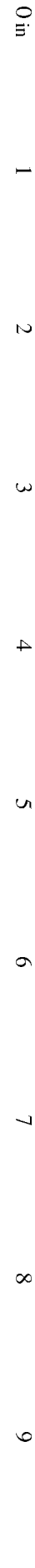

MOUTH AND THROAT INSTRUMENTS

Mouth Gags

JENNINGS MOUTH GAG



CATALOG #	DESCRIPTION
070202	Adult, working length 6" (15 cm), spread 66 mm, 7-3/4" (19.5 cm)

MCIVOR MOUTH GAG



CATALOG #	DESCRIPTION
461125	Set, frame with 3 blades (# 2.5, # 3, # 4), each 5-3/8" (13.5 cm)
461126	Frame only
461128	Blade # 3, 5-3/8" (13.5 cm)



MOUTH AND THROAT INSTRUMENTS

Mouth Gags

SLUDER-JANSEN MOUTH GAG



070232

CATALOG #	DESCRIPTION
070232	Curved, 28 x 13 mm blade, 5-1/8" (13 cm)

DENHARDT MOUTH GAG



070222

CATALOG #	DESCRIPTION
070222	Serrated, lead bit block 10 x 16 mm, 4-7/8" (12.5 cm)

Retractors

ANDREWS TONGUE DEPRESSOR



070107

CATALOG #	DESCRIPTION
070107	Deeply serrated, 21 x 48 mm blade, 30 degree angle, 4-1/2" (11.5 cm)

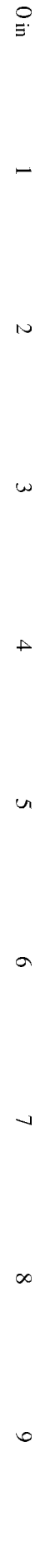

MOUTH AND THROAT INSTRUMENTS

Retractors

WIEDER TONGUE DEPRESSORS



070100

Fenestrated, serrated.

CATALOG #	DESCRIPTION
070100	Small blade, 41 x 36 mm, 5-9/16" (14 cm)
070101	Large blade, 43 x 43 mm, 6" (15 cm)

HURD DISSECTOR AND PILLAR RETRACTORS



073502

9" (23 cm).

CATALOG #	DESCRIPTION
073500	Small dissector 27 x 7 mm, retractor 11 mm
073502	Large dissector 27 x 9 mm, retractor 13 mm

LOTHROP UVULA RETRACTOR

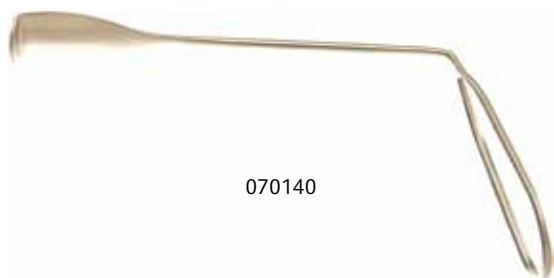

070140

CATALOG #	DESCRIPTION
070140	Grooved 36 x 19 mm blade with 5 mm deep lip, 5-3/8" (13.5 cm)



MOUTH AND THROAT INSTRUMENTS

Scissors

BOETTCHER TONSIL SCISSORS



CATALOG #	DESCRIPTION
074120	Slightly curved, 42 mm blades, 7-1/4" (18.5 cm)

DEAN TONSIL SCISSORS



CATALOG #	DESCRIPTION
074140	32 mm serrated blades, angled on flat, curved shanks, 6-3/4" (17 cm)

YANKAUER TONSIL SCISSORS



CATALOG #	DESCRIPTION
074115	Slightly curved, serrated, 42 mm blades, 7-1/8" (18 cm)



MOUTH AND THROAT INSTRUMENTS

Snares

EVE TONSIL SNARES



070651



070652

CATALOG #	DESCRIPTION
070651	Standard, 11-1/4" (28.5 cm)
070652	Ratcheted, 11-3/8" (29 cm)

NEIVERT-EVE TONSIL SNARE



070660

CATALOG #	DESCRIPTION
070660	10-3/8" (26.5 cm)

LEWIS TONSIL SNARE



070665

CATALOG #	DESCRIPTION
070665	10-1/4" (26 cm)



MOUTH AND THROAT INSTRUMENTS

Snares

SAGE TONSIL SNARE



070635

CATALOG #	DESCRIPTION
070635	Ratcheted, working length 8-5/8" (22 cm)

TYDING TONSIL SNARE



070640

CATALOG #	DESCRIPTION
070640	Straight tip, 10" (25.5 cm)

THROAT SNARE WIRES



070704

4-3/8" (11 cm) precut. 144 per package.

CATALOG #	DESCRIPTION
070701	4 Ga., nose
070702	5 Ga., nose
070704	7 Ga., throat
070705	8 Ga., throat
070706	9 Ga., throat

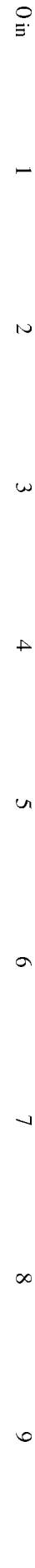

MOUTH AND THROAT INSTRUMENTS

Miscellaneous

FISHER TONSIL KNIFE AND DISSECTOR



073370

CATALOG #	DESCRIPTION
073370	17 x 7 mm serrated outer blade, 8-5/8" (22 cm)

HOLINGER KNIFE HANDLE



506705

For use with surgical blades no. 10, 11, 12 and 15.

CATALOG #	DESCRIPTION
506705	11" (28 cm)

MELTZER ADENOID PUNCH



461661

With basket.

CATALOG #	DESCRIPTION
461660	# 1, 5 mm, working length 5-1/2" (14 cm)
461661	# 2, 7 mm, working length 5-1/2" (14 cm)

SCOPE AND LIGHT CARRIERS

Identification Index

SCOPES

SCOPE NUMBER	SCOPE DESCRIPTION	LIGHT CARRIER NUMBER*	LIGHT CARRIER DESCRIPTION	NEW LC MARK	LC STAMP	OLD BR SERIES
501500	Laryn Holinger Infant	526204 (R)	LC Fiber optic 8PH	8PH	8PH	BR 145
501550	Laryn CLJ Infant	526000	LC Fiber optic 9	9	8PH	BR 145
501552	Laryn CLJ Child	526006	LC Fiber optic 12	12	12	BR 105
501554	Laryn CLJ Adolescent	526018	LC Fiber optic 16	16	16	BR 110
501556	Laryn CLJ Adol-Adult	526018	LC Fiber optic 16	16	16	BR 115
501558	Laryn CLJ Adult	526018	LC Fiber optic 16	16	16	BR 120
501560	Laryn CLJ Adult XL	526018	LC Fiber optic 16	16	16	BR 125
501580	Andrews Otoscope	526004	LC Fiber optic 11		11	
501648	Laryn CLJ Newborn	526202	LC Fiber optic 8C		8C	BR 100A
501650	Laryn CLJ Infant	526002	LC Fiber optic 9C		9C	BR 101
501652	Laryn CLJ Child	526010	Custom		12C	BR 106
501654	Laryn CLJ Adolescent	526022	LC Fiber optic 16C	16C	16C	BR 111
501656	Laryn CLJ Adol-Adult	526022	LC Fiber optic 16C	16C	16C	BR 116
501658	Laryn CLJ Adult	526022	LC Fiber optic 16C	16C	16C	BR 121
501660	Laryn CLJ Adult XL	526022	LC Fiber optic 16C	16C	16C	BR 126
501810	Laryn CLJ AC Child	526012	Custom		12AC	BR 171
501814	Laryn CLJ AC Adult	526032	LC Fiber optic 17SC	17SC	17SC	BR 176
501820	Laryn CLJ AC Child	526008	LC Fiber optic 12A	12A	12A	BR 170
501824	Laryn CLJ AC Adult	526026	LC Fiber optic 17	17	17	BR 175
501830	Tracheascope CLJ	526044	LC Fiber optic 20C		20C	BR 240
502002	Laryn Holinger AC Infant	526206	LC Fiber optic 9PH	9PH	9PH	BR 205
502004	Laryn Holinger AC Child	526210	LC Fiber optic 12PH	12PH	12PH	BR 207
502010	Laryn Holinger AC Adult 17	526028	LC Fiber optic 17H	17H	17H	BR 200
502012	Laryn Holinger AC Adult 18 Twin	526038	LC Fiber optic 18H	18H	18H	BR 209
502020	Laryn Holinger AC Adult 17 Twin	526028 (2)	LC Fiber optic 17H	17H	17H	BR 208
502022	Laryn Holinger AC Adult 18 Twin	526038 (2)	LC Fiber optic 18H	18H	18H	BR 209
502030	Laryn Holinger HG Adult 17	526212	LC Fiber optic 17HG	17HG	17HG	BR 201
502031	Laryn Holinger HG Adult 17 Twin	526212 (2)	LC Fiber optic 17HG	17HG	17HG	
502032	Laryn Holinger XL HG Adult 18	526214	LC Fiber optic 18HG	18HG	18HG	
502033	Laryn Holinger XL HG Ad 18 Twin	526214 (2)	LC Fiber optic 18HG	18HG	18HG	
502040	Laryn Holinger Adult Slot	526028	LC Fiber optic 17H	17H	17H	BR 204
502045	Laryn Holinger HG Adult Slot	526212	LC Fiber optic 17HG	17HG	17HG	
502060	Laryn Broyles	526026 (2)	LC Fiber optic 17	17	17	BR 230
502080	Laryn Tucker Newborn	526200	LC Fiber optic 7GT	7GT	7GT	BR 210
502082	Laryn Tucker Child	526208	LC Fiber optic 12GT		12GT	BR 212
502084	Laryn Tucker Adolescent	526220	LC Fiber optic 21GT	21GT	21GT	BR 215
502086	Laryn Tucker Adult	526222	LC Fiber optic 20T		20T	BR 217
502090	Laryn Tucker Reverse Bevel	526220	LC Fiber optic 21GT	21GT	21GT	BR 217A
502100	Laryn Atkins-Tucker	526220	LC Fiber optic 21GT	21GT	21GT	BR 232
502108	Laryngostat CLJ Child	526007	LC Fiber optic 12B		12	BR 220
502109	Laryngostat CLJ Adult	526026	LC Fiber optic 17	17	17	BR 225
502110	Laryngostat Priest Adult	526030	LC Fiber optic 17P	17P	17P	BR 227
502200	Laryn Roberts Adult	526024 (2)	LC Fiber optic 16SR		16SR	BR 245
502203	Laryn Roberts Child	526014 (2)	Custom		12SR	BR 245A
502300	Mediast Scope Carlen Short	526350	LC FO Carlen Short	S	S	
502301	Mediast Scope Carlen Long	526351	LC FO Carlen Long	L	L	
502302	Mediast Scope Carlen Extra Long	526352	LC FO Carlen Extra Long	XL	XL	
502500	Bronch CLJ 3 x 20	526218	LC Fiber optic 20PH	20PH	20PH	
502502	Bronch CLJ 3.5 x 25	526226	LC Fiber optic 25PH	25	25PH	
502504	Bronch CLJ 3.5 x 30	526230	LC Fiber optic 30PH	30PH	30PH	

* (L) INDICATES LEFT-SPECIFIC LIGHT CARRIER, (R) INDICATES RIGHT-SPECIFIC LIGHT CARRIER, (2) INDICATES LIGHT CARRIERS REQUIRED

SCOPE AND LIGHT CARRIERS

Identification Index

SCOPES

SCOPE NUMBER	SCOPE DESCRIPTION	LIGHT CARRIER NUMBER*	LIGHT CARRIER DESCRIPTION	NEW LC MARK	LC STAMP	OLD BR SERIES
502506	Bronch CLJ 4 x 30	526230	LC Fiber optic 30PH	30PH	30PH	
502508	Bronch CLJ 5 x 30	526230	LC Fiber optic 30PH	30PH	30PH	
502510	Bronch CLJ 6 x 35	526054	LC Fiber optic 35	35	35	
502512	Bronch CLJ 7 x 40	526060	LC Fiber optic 40	40	40	
502514	Bronch CLJ 8 x 40	526060	LC Fiber optic 40	40	40	
502516	Bronch CLJ 9 x 40	526060	LC Fiber optic 40	40	40	
502525	Bronch CLJ Aspirating 7 x 40	526060	LC Fiber optic 40	40	40	
502527	Bronch CLJ Aspirating 9 x 40	526060	LC Fiber optic 40	40	40	
502532	Bronch CLJ Full Lumen 5 x 30	526230	LC Fiber optic 30PH	30PH	30PH	
502534	Bronch CLJ Full Lumen 6 x 35	526054	LC Fiber optic 35	35	35	BR 1021
502536	Bronch CLJ Full Lumen 7 x 40	526060	LC Fiber optic 40	40	40	BR 1036
502538	Bronch CLJ Full Lumen 8 x 40	526060	LC Fiber optic 40	40	40	BR 1041
502550	Bronch Overholt 7 x 30	526048	LC Fiber optic 30	30	Regular 30	
502600	Bronch Old Holinger 3 x 20	526218	LC Fiber optic 20PH	20PH	20PH	BR 900
502602	Bronch Old Holinger 3.5 x 25	526226	LC Fiber optic 25PH	25	25PH	BR 905
502604	Bronch Old Holinger 3.5 x 30	526230	LC Fiber optic 30PH	30PH	30PH	BR 910
502606	Bronch Old Holinger 4 x 30	526230	LC Fiber optic 30PH	30PH	30PH	BR 915
502608	Bronch Old Holinger 5 x 30	526230	LC Fiber optic 30PH	30PH	30PH	BR 920
502620	Bronch Jesberg 3 x 25	526159	LC Fiber optic 25SJ		30PH	BR1170A
502622	Bronch Jesberg 3.5 x 30	526166	LC Fiber optic 30SJ		30SJ	BR1175A
502624	Bronch Jesberg 4 x 30	526166	LC Fiber optic 30SJ		30SJ	BR1185A
502626	Bronch Jesberg 5 x 30	526166	LC Fiber optic 30SJ		30SJ	BR1190A
502630	Bronch Jesberg 3 x 20	526150	LC Fiber optic 16SJ		16SJ	BR 1170
502632	Bronch Jesberg 3.5 x 26	526160	Custom		16SJ	BR 1175
502634	Bronch Jesberg 4 x 26	526160	Custom		26SJ	BR 1180
502636	Bronch Jesberg 5 x 30	526166	LC Fiber optic 30SJ		30SJ	BR 1190
502640	Bronch Rieker 3 x 20	526152	Custom		20RI	BR 1330
502641	Bronch Rieker 3.5 x 25	526158	LC Fiber optic 25RI		25RI	BR 1331
502642	Bronch Rieker 4 x 30	526164	LC Fiber optic 30RI		30RI	BR 1332
502643	Bronch Rieker 5 x 30	526164	LC Fiber optic 30RI		30RI	BR 1333
502644	Bronch Rieker 6 x 35	526054	LC Fiber optic 35	35	Regular 35	BR 1334
502645	Bronch Rieker 7 x 40	526060	LC Fiber optic 40	40	Regular 40	BR 1335
502646	Bronch Rieker 8 x 40	526060	LC Fiber optic 40	40	Regular 40	BR 1336
502647	Bronch Rieker 9 x 40	526060	LC Fiber optic 40	40	Regular 40	BR 1337
502650	Bronch Negus Suckling SM		Custom			
502651	Bronch Negus Suckling		Custom			
502652	Bronch Negus Infant		Custom			
502653	Bronch Negus Child Aspirating	526292	LC Fiber optic 30N		30N	
502654	Bronch Negus Child	526292	LC Fiber optic 30N		30N	
502655	Bronch Negus Adult Aspirating	526294	LC Fiber optic 40N		40N	
502656	Bronch Negus Adol SM	526294	LC Fiber optic 40N		40N	
502657	Bronch Negus Adol	526294	LC Fiber optic 40N		40N	
502658	Bronch Negus Adult SM	526294	LC Fiber optic 40N		40N	
502659	Bronch Negus Adult	526294	LC Fiber optic 40N		40N	
502750	Bronch Albert Slotted 4 x 35	526054	LC Fiber optic 35	35	35	BR 990
502752	Bronch Albert Slotted 5 x 40	526060	LC Fiber optic 40	40	40	BR 992
502754	Bronch Albert Slotted 6 x 40	526060	LC Fiber optic 40	40	40	BR 994
502756	Bronch Albert Slotted 7 x 40	526060	LC Fiber optic 40	40	40	BR 996
502758	Bronch Albert Slotted 8 x 45	526068	LC Fiber optic 45	45	45	BR 998
502765	Bronch Kernan Coagulating 7 x 40	526060	LC Fiber optic 40	40	40	BR 1300

* (L) INDICATES LEFT-SPECIFIC LIGHT CARRIER, (R) INDICATES RIGHT-SPECIFIC LIGHT CARRIER, (2) INDICATES LIGHT CARRIERS REQUIRED

SCOPE AND LIGHT CARRIERS

Identification Index

SCOPES

SCOPE NUMBER	SCOPE DESCRIPTION	LIGHT CARRIER NUMBER*	LIGHT CARRIER DESCRIPTION	NEW LC MARK	LC STAMP	OLD BR SERIES
502767	Bronch Kernan Coagulating 8 x 40	526060	LC Fiber optic 40	40	40	BR 1310
502800	Bronch CLJ Staple 4 x 6 x 35	526054	LC Fiber optic 35	35	35	BR 1275
502802	Bronch CLJ Staple 4 x 8 x 40	526060	LC Fiber optic 40	40	40	BR 1285
502804	Bronch CLJ Staple 4 x 12 x 40	526060	LC Fiber optic 40	40	40	BR 1290
502808	Bronch CLJ Expanding Staple	526060	LC Fiber optic 40	40	40	BR 1295
502815	Bronch CLJ Costophrenic 2 x 35		Custom			BR 1215
502817	Bronch CLJ Costophrenic 3 x 45	526068	LC Fiber optic 45	45	45	BR 1235
502819	Bronch CLJ Costophrenic 4 x 45	526068	LC Fiber optic 45	45	45	BR 1240
503500	Esoph Holinger 5 x 35	526226	LC Fiber optic 25PH	25	25PH	BR 394
503502	Esoph Holinger 3.5 x 30	526230	LC Fiber optic 30PH	30PH	30PH	BR 395
503505	Esoph Holinger 6 x 20	526218	LC Fiber optic 20PH	20PH	20PH	BR 397
503525	Esoph CLJ Standard 5 x 35	526238	LC Fiber optic 35PH	35PH	35PH	BR 456
503527	Esoph CLJ Standard 6 x 35	526054	LC Fiber optic 35	35	35	BR 466
503533	Esoph CLJ Standard 8 x 45	526068	LC Fiber optic 45	45	45	BR 496
503539	Esoph CLJ Standard 9 x 45	526068	LC Fiber optic 45	45	45	BR 511
503541	Esoph CLJ Standard 9 x 50	526070	LC Fiber optic 50	50	50	BR 516
503550	Esoph CLJ Full Lumen 4 x 35	526238	LC Fiber optic 35PH	35PH	35PH	BR 551
503552	Esoph CLJ Full Lumen 5 x 35	526238	LC Fiber optic 35PH	35PH	35PH	BR 556
503554	Esoph CLJ Full Lumen 6 x 35	526054	LC Fiber optic 35	35	35	BR 566
503556	Esoph CLJ Full Lumen 7 x 45	526068	LC Fiber optic 45	45	45	BR 576
503558	Esoph CLJ Full Lumen 8 x 45	526068	LC Fiber optic 45	45	45	BR 591
503560	Esoph CLJ Full Lumen 9 x 30	526048	LC Fiber optic Reg. 30	30	30	BR 596
503562	Esoph CLJ Full Lumen 9 x 45	526068	LC Fiber optic Reg. 45	45	Reg 45	BR 601
503564	Esoph CLJ Full Lumen 9 x 50	526070	LC Fiber optic 50	50	50	BR 604
503600P	Esoph CLJ 7 x 10 x 25	526262	LC Fiber optic 25R	25R	25R	BR 530
503602	Esoph CLJ 8 x 12 x 50	526284	LC Fiber optic 50R	50R	50R	BR 540
503604	Esoph CLJ 9 x 13 x 25	526262	LC Fiber optic 25R	25R	25R	BR 532
503606	Esoph CLJ 10 x 14 x 30	526266	LC Fiber optic 30R	30R	30R	BR 534
503608	Esoph CLJ 10 x 14 x 40	526274	LC Fiber optic 40R	40R	40R	BR 538
503610P	Esoph CLJ 10 x 14 x 50	526284	LC Fiber optic 50R	50R	50R	BR 542
503612	Esoph CLJ 12 x 16 x 50	526284	LC Fiber optic 50R	50R	50R	BR 544
503614	Esoph CLJ 12 x 18 x 35	526272	LC Fiber optic 35R	35R	35R	BR 536
503625	Esoph J Roberts 7 x 10 x 22	526260	LC Fiber optic 22R	22R	22R	BR 324
503627	Esoph J Roberts 9 x 13 x 22	526260	LC Fiber optic 22R	22R	22R	BR 325
503629	Esoph J Roberts 10 x 14 x 30	526266	LC Fiber optic 30R	30R	30R	BR 335
503631	Esoph J Roberts 10 x 14 x 40	526274	LC Fiber optic 40R	40R	40R	BR 340
503633	Esoph J Roberts 12 x 16 x 45	526280	LC Fiber optic 45R	45R	45R	BR 347
503635	Esoph J Roberts 12 x 16 x 50	526284	LC Fiber optic 50R	50R	50R	BR 350
503650	Esoph S Jesberg 6 x 8 x 32	526268	LC Fiber optic 32J	32J	32J	BR 375
503652	Esoph S Jesberg 6.5 x 10 x 35	526270	LC Fiber optic 35J	35J	35J	BR 377
503654	Esoph S Jesberg 7 x 10 x 42	526276	LC Fiber optic 42J	42J	42J	BR 379
503656	Esoph S Jesberg 8 x 12 x 45	526278	LC Fiber optic 45J	45J	45J	BR 381
503658	Esoph S Jesberg 10 x 14 x 29	526264	LC Fiber optic 29J	29J	29J	BR 383
503660P	Esoph S Jesberg 10 x 14 x 50	526282	LC Fiber optic 50J	50J	50J	BR 385
503675	Esoph Forbes Child	526020	LC Fiber optic 16A	16A	16A	BR 360
503676	Esoph Forbes Adolescent	526042	LC Fiber optic 19	19	19	BR 365
503677	Esoph Forbes Adult	526046	LC Fiber optic 22	22	22	BR 370
521450	Laryn Tucker Side Slide Child	526510	LC FO for 521450	7S		
521455	Laryn Tucker Side Slide Adol	526512	LC for Tucker Adol 521455	8S		

* (L) INDICATES LEFT-SPECIFIC LIGHT CARRIER, (R) INDICATES RIGHT-SPECIFIC LIGHT CARRIER, (2) INDICATES LIGHT CARRIERS REQUIRED

SCOPE AND LIGHT CARRIERS

Identification Index

SCOPES

SCOPE NUMBER	SCOPE DESCRIPTION	LIGHT CARRIER NUMBER*	LIGHT CARRIER DESCRIPTION	NEW LC MARK	LC STAMP	OLD BR SERIES
521460	Laryn Tucker Side Slide Adult	526515	LC FO for Tuck Adult 521460	9S		
521465	Laryn Tuck Side Slide Long Adult	526516	LC FO for Tuck Adult 521465	13S		
521500	Laryn Holinger Infant	526204	LC Fiber optic 8PH	8PH	8PH	BR 145
521550	FO Laryn CLJ Infant	526000	LC Fiber optic 9	9	9	BR 100
521552	FO Laryn CLJ Child	526006	LC Fiber optic 12	12	12	BR 105
521554	FO Laryn CLJ Adolescent	526018	LC Fiber optic 16	16	16	BR 110
521556	FO Laryn CLJ Adol-Adult	526018	LC Fiber optic 16	16	16	BR 115
521558	FO Laryn CLJ Adult	526018	LC Fiber optic 16	16	16	BR 120
521820	FO Laryn CLJ AC Child	526008	LC Fiber optic 12A	12A	12A	BR 170
521824	FO Laryn CLJ AC Adult	526026	LC Fiber optic 17	17	17	BR 175
522000	Tuck-Holin AC Laryn Infant Slotted	526203	LC for 522000	6S		
522001	Tuck-Holin AC Laryn Child Slotted	526201	LC Fiber optic for 522001	9S2		
522002	Laryn Holinger AC Infant	526206	LC Fiber optic 9PH	9PH		
522004	Laryn Holinger AC Child	526210	LC Fiber optic 12PH	12PH		
522010	Laryn Holinger AC Adult 17	526028	LC Fiber optic 17H	17H		
522012	Laryn Holinger AC Adult 18	526038	LC Fiber optic 18H	18H	18H	BR 203
522020	Laryn Holinger AC Adult 17 Twin	526028 (2)	LC Fiber optic 17H	17H	17H	BR 208
522022	Laryn Holinger AC Adult 18 Twin	526038	LC Fiber optic 18H	18H	18H	BR 209
522030	Laryn Holinger HG Adult 17	526212	LC Fiber optic 17HG	17HG	17HG	BR 201
522032	Laryn Holinger XL HG Adult 18	526214	LC Fiber optic 18HG	18HG	18HG	
522034	Laryn Holinger HG Adult 17	526500	LC FO Oval 17HG	17	17OV	
522035	Laryn Holinger XL HG Adult 18	526505	LC FO Oval 18HG	18	18OV	
522040	Laryn Holinger AC Adult Slotted 17 HG Oval	526028	LC Fiber optic 17H	17H	17H	BR 204
522045	Laryn Holinger HG Adult Slotted 17 HG Oval	526212	LC Fiber optic 17HG	17HG	17HG	
522190	Laryn Ossoff-Pilling®	527864	LC Fiber optic 522190	19		
522191	Laryn Ossoff-Pilling®	527865	LC Fiber optic 522191	25L		
522193	Laryn Ossoff-Pilling®	527866	LC Fiber optic 522193	25R2		
522194	Dual channel Video Laryn Ossoff-Pilling® Adult	527867	LC FO for Ossoff-Pilling® Adult	N/A		
522200P	Laryn Jako Type 1 FO Adult	526365	LC Jako I Right	JR	J	
522200P	Laryn Jako Type 1 FO Adult	526366	LC FO Jako I Left	JL	J	
522202	Laryn Holinger AC Infant	526206	LC Fiber optic 9PH	9PH	9PH	BR 205
522204	Laryn Holinger AC Child	526210	LC Fiber optic 12PH	12PH	12PH	BR 207
522205	Laryn Jako Type 2 FO Adult	527805	LCC Jako Adult II Right	(no mark)		
522205	Laryn Jako Type 2 FO Adult	527800	LCC Jako Adult II Left	(no mark)		
522206	Laryn Jako Type 3 FO Adult	526526	LC FO for Jako Adult III 522206	14Y		
522207	Laryn Jako-Cherry 1 FO Adol	526375	LC Jako Cherry I Adol Right	12JR	12J	
522207	Laryn Jako-Cherry 1 FO Adol	526376	LC Jako Cherry I Adol Left	12JL	12J	
522208	Laryn Jako-Cherry 2 FO Adol	527815	LCC Jako Cherry Adol II Right	(no mark)		
522208	Laryn Jako-Cherry 2 FO Adol	527810	LCC Jako Cherry Adol II Left	(no mark)		
522209	Laryn Jako-Cherry 3 FO Adol	526527	LC FO for Jako Adol III 522209	9Y2		
522210	Laryn Jako-Cherry 1 FO Child	526370	LC Jako Cherry I Child Right	9JR	9J	
522210	Laryn Jako-Cherry 1 FO Child	526371	LC Jako Cherry I Child Left	9JL	9J	
522215	Laryn Jako-Cherry 2 FO Child	527825	LCC Jako Cherry Child II Right	(no mark)		
522215	Laryn Jako-Cherry 2 FO Child	527820	LCC Jako Cherry Child II Left	(no mark)		
522216	Laryn Jako-Cherry 3 FO Child	526528	LC FO for Jako Child III 522216	8Y		
522220	Laryn Jako-Cherry 2 FO Newborn	527825	LCC Jako Cherry Child II Right	(no mark)		
522220	Laryn Jako-Cherry 2 FO Newborn	527820	LCC Jako Cherry Child II Left	(no mark)		

* (L) INDICATES LEFT-SPECIFIC LIGHT CARRIER, (R) INDICATES RIGHT-SPECIFIC LIGHT CARRIER, (2) INDICATES LIGHT CARRIERS REQUIRED

SCOPE AND LIGHT CARRIERS

Identification Index

SCOPES

SCOPE NUMBER	SCOPE DESCRIPTION	LIGHT CARRIER NUMBER*	LIGHT CARRIER DESCRIPTION	NEW LC MARK	LC STAMP	OLD BR SERIES
522222	MicroLarynx Dedo Child	526524	LC FO for Child Dedo 522222	9Y		
522224	MicroLarynx Dedo Adolescent	526529	LC FO for Dedo Adol 522224	11Y		
522225P	MicroLarynx Dedo Adult	526525	LC FO for Adult Dedo 522225	15Y		
522226	Dual channel Video Larynx Dedo-Pilling® Adult	527867	LC FO for Dedo-Pilling® Adult	N/A		
522227	MicroLarynx Dedo Type 2 Photo	527860	LCC for Ossoff Adult	(no mark)		
522228	Dedo Laser MicroLaryngoscope	527860	LCC for Ossoff Dedo Adult	(no mark)		
522229	Abramson-Dedo MicroLaryngoscope	527586	LC for Abramson Dedo Right	14R		
522229	Abramson-Dedo MicroLaryngoscope	527587	LC for Abramson Dedo Left	14L		
522230	Larynx Tucker AC Side Slotted	526520	LC Tucker Scope 522230	8S2		
522231	Larynx Ossoff-Karlan Dedo Laser	527860	LCC Ossoff Dedo Adult	(no mark)		
522232	Larynx Ossoff-Karlan Jako Laser	527805	LCC Jako Adult II Right	(no mark)		
522232	Larynx Ossoff-Karlan Jako Laser	527800	LCC Jako Adult II Left	(no mark)		
522233	Ossoff Commissure Laryngoscope	527860	LCC Ossoff Dedo Adult	(no mark)		
522234	522231 With Strong Extension	527860	LCC Ossoff Dedo Adult	(no mark)		
522235	522232 With Strong Extension	527860	LCC Ossoff Dedo Adult	(no mark)		
522236	522233 With Strong Extension	527860	LCC Ossoff Dedo Adult	(no mark)		
522237	Ossoff-Karlan Child Laser Larynx	527863	LCC for Ossoff Child	(no mark)		
522238	Ossoff-Karlan Adol Laser Larynx	527862 (2)	LCC for Ossoff Adolescent	(no mark)		
522242	Healy-Jako Subglottiscope	527830 (R)	LCC Healy-Jako Subglot Right	(no mark)		
522242	Healy-Jako Subglottiscope	527835 (L)	LCC Healy-Jako Subglot Left	(no mark)		
522243	Dedo Laser Larynx Extra Long	527860 (2)	LCC FO Ossoff Dedo Adult	(no mark)		
522244	Ossoff Adult Subglottiscope Female	527860	LCC FO Ossoff Dedo Adult	(no mark)		
522245	Ossoff Adult Subglottiscope Male	527860	LCC FO Ossoff Dedo Adult	(no mark)		
522250	MicroLarynx Tucker-Jako Adult	527850	LCC Tucker Jako	(no mark)		
522255	MicroLarynx Tucker-Jako Adol	527853	LCC Tucker Jako Med	(no mark)		
522260	MicroLarynx Tucker-Jako Child	527855	LCC Tucker Jako Short			
522261	522200 With Strong Extension	526365 (R)	LC FO Jako I Reg Right	JR	J	
522261	522200 With Strong Extension	526366 (L)	LC FO Jako I Reg Left	JL	J	
522262	522205 With Strong Extension	527800 (L)	LCC Jako Adult II Left	(no mark)		
522262	522205 With Strong Extension	527805 (R)	LCC Jako Adult II Right	(no mark)		
522263	522206 With Strong Extension	526526	LC FO for Jako Adult III 522206	14Y		
522264	522207 With Strong Extension	526375 (R)	LC FO Jako Cherry I Adol Right	12JR	12J	
522264	522207 With Strong Extension	526376 (L)	LC FO Jako Cherry I Adol Left	12JL	12J	
522265	522208 With Strong Extension	527810 (L)	LCC Jako Cherry Adol II Left	(no mark)		
522265	522208 With Strong Extension	527815 (R)	LCC Jako Cherry Adol II Right	(no mark)		
522266	522209 With Strong Extension	526527	LC FO for Jako Adol III 522209	9Y2		
522267	522210 With Strong Extension	526370 (R)	LC FO Jako Cherry I Child Right	9JR	9J	
522267	522210 With Strong Extension	526371 (L)	LC FO Jako Cherry I Child Left	9JL	9J	
522268	522215 With Strong Extension	527820 (L)	LCC Jako Cherry Child II Left	(no mark)		
522268	522215 With Strong Extension	527825 (R)	LCC Jako Cherry Child II Right	(no mark)		

* (L) INDICATES LEFT-SPECIFIC LIGHT CARRIER, (R) INDICATES RIGHT-SPECIFIC LIGHT CARRIER, (2) INDICATES LIGHT CARRIERS REQUIRED

SCOPE AND LIGHT CARRIERS

Identification Index

SCOPES

SCOPE NUMBER	SCOPE DESCRIPTION	LIGHT CARRIER NUMBER*	LIGHT CARRIER DESCRIPTION	NEW LC MARK	LC STAMP	OLD BR SERIES
522269	522216 With Strong Extension	526528	LC FO for Jako Child III 522216	8Y		
522270	522220 With Strong Extension	527820 (L)	LCC Jako Cherry Child II Left	(no mark)		
522270	522220 With Strong Extension	527825 (R)	LCC Jako Cherry Child II Right	(no mark)		
522271	522222 With Strong Extension	526524	LC FO for Child Dedo 522222	9Y		
522272	522225 With Strong Extension	526525	LC FO for Adult Dedo 522225	15Y		
522273	522227 With Strong Extension	527860 (2)	LCC Ossoff Dedo Adult	(no mark)		
522274	522230 With Strong Extension	526520	LC FO for Tucker 522230	8S2		
522275	522250 With Strong Extension	527850	L Cabl-Car Tucker Jako	(no mark)		
522276	522255 With Strong Extension	527853	L Cabl-Car TUC Jako Med	(no mark)		
522280	Ossoff Neonatal Subglottoscope	526210	LC Fiberoptic 12PH	12PH	12PH	
522290	Pilling® Dedo Dbl Action AC Adult	527860	LCC Ossoff Dedo Adult	(no mark)		
522291	Pilling® Ossoff Dbl Act Post Com	527860	LCC Ossoff Dedo Adult	(no mark)		
522292	Pilling® Dedo Dbl Action AC Adol	527863	LCC for Ossoff Child	(no mark)		
522293	Pilling® Dedo Dbl Action AC Child	527863	LCC Ossoff, PIL Dedo Child	(no mark)		
522294	Pilling® Feder Sgl Act Ant Com Adult	527860	LCC Ossoff, Dedo, Feder Adult	(no mark)		
522295	Pilling® Feder Single Act Post Adult	527860	LCC Ossoff, Dedo Adult	(no mark)		
522296	Pilling® Feder Single Act AC Adol	527863	LCC for Ossoff Child	(no mark)		
522297	Pilling® Feder Single Act AC Child	527863	LCC Ossoff, Pilling® Dedo, Feder Child	(no mark)		
522300P	Mediast Scope Carlen Short	526350	LC FO Carlen Short	S	S	
522301	Mediast Scope Carlen Long	526351	LC FO Carlen Long	L	L	
522302	Mediast Scope Carlen Extra Long	526352	LC FO Carlen Extra Long	XL	XL	
522305P	Mediast Scope Tucker Short	526361 (R)	LC FO Tucker Short Right	12BR	12B	
522305P	Mediast Scope Tucker Short	526360 (L)	LC FO Tucker Short Left	12BL	12B	
522306	Mediast Scope Tucker Imp Short	527853	LCC FO Tucker Jako Med	(no mark)		
522310P	Mediast Scope Tucker Long	526363 (R)	LC FO Tucker Long Right	16R	16	
522310P	Mediast Scope Tucker Long	526362 (L)	LC FO Tucker Long Left	16L	16	
522311	Mediast Scope Tucker Imp Long	527850	LCC FO Tucker Jako	(no mark)		
522401	Tucker Tracheascope 3 x 18	527521	LC FO 18CM Small Oval		18	
522402	Tucker Tracheascope 4 x 18	527521	LC FO 18CM Small Oval		18	
522403	Tucker Tracheascope 5 x 18	527521	LC FO 18CM Small Oval		18	
522404	Fearon Tracheascope 3 x 20	527500	LC Hol Oval 20 SM	20	20	
522408	Fearon Tracheascope 3 x 20	527500	LC Hol Oval 20 SM	20	20	
522412	Fearon Tracheascope 5 x 20	527500	LC Hol Oval 20 SM	20	20	
522500	Bronch CLJ FO 3 x 20	526218	LC Fiber optic 20PH	20PH	20PH	
522502	Bronch CLJ FO 3.5 x 25	526226	LC Fiber optic 25PH	25	25PH	
522504	Bronch CLJ FO 3.5 x 30	526230	LC Fiber optic 30PH	30PH	30PH	
522506	Bronch CLJ FO 4 x 30	526230	LC Fiber optic 30PH	30PH	30PH	
522508	Bronch CLJ FO 5 x 30	526230	LC Fiber optic 30PH	30PH	30PH	
522510	Bronch CLJ FO 6 x 35	526054	LC Fiber optic 35	35	35	
522512	Bronch CLJ FO 7 x 40	526060	LC Fiber optic 40	40	40	
522514	Bronch CLJ FO 8 x 40	526060	LC Fiber optic 40	40	40	
522516	Bronch CLJ FO 9 x 40	526060	LC Fiber optic 40	40	40	
522525	Bronch CLJ Aspirating 7 x 40	526060	LC Fiber optic 40	40	40	BR 1076
522527	Bronch CLJ Aspirating 8 x 40	526060	LC Fiber optic 40	40	40	BR 1081
522550	Pilling® Imp Holing Bronch 3 x 20	527500	LC FO for Hol Oval 20 SM	20	20	

* (L) INDICATES LEFT-SPECIFIC LIGHT CARRIER, (R) INDICATES RIGHT-SPECIFIC LIGHT CARRIER, (2) INDICATES LIGHT CARRIERS REQUIRED

SCOPE AND LIGHT CARRIERS

Identification Index

SCOPES

SCOPE NUMBER	SCOPE DESCRIPTION	LIGHT CARRIER NUMBER*	LIGHT CARRIER DESCRIPTION	NEW LC MARK	LC STAMP	OLD BR SERIES
522552	Pilling® Imp Holing Bronch 3.5 x 20	527500	LC FO for Hol Oval 20 SM	20	20	
522554	Pilling® Imp Holing Bronch 4 x 20	527500	LC FO for Hol Oval 20 SM	20	20	
522556	Pilling® Imp Holing Bronch 4 x 25	527505	LC FO for Hol Oval 25 SM	25HB	25	
522558	Pilling® Imp Holing Bronch 5 x 30	527510	LC FO for Hol Oval 30 SM	30HB	30	
522575	Bronch Holinger FO 3 x 20	527500	LC FO for Hol Oval 20 SM	20	20	
522576	Bronch Holinger FO 3.5 x 25	527505	LC FO for Hol Oval 25 SM	25HB	25	
522577	Bronch Holinger FO 3.5 x 30	527510	LC FO for Hol Oval 30 SM	30HB	30	
522578	Bronch Holinger FO 4 x 30	527510	LC FO for Hol Oval 30 SM	30HB	30	
522579	Bronch Holinger FO 5 x 30	527510	LC FO for Hol Oval 30 SM	30HB	30	
522580	Bronch Holinger FO 5 x 35	527515	LC FO for Hol Oval 35 SM	35H	35	
522581	Bronch Holinger FO 5 x 40	527520	LC FO for Hol Oval 40 SM	40H	40	
522582	Bronch Holinger FO 5 x 45	527525	LC FO for Hol Oval 45 SM	45HB	45	
522583	Bronch Holinger FO 6 x 35	527555	LC FO for Hol Oval 35 Med	35H2	35	
522584	Bronch Holinger FO 6 x 40	527560	LC FO for Hol Oval 40 Med	40H2	40	
522585	Bronch Holinger FO 7 x 40	527560	LC FO for Hol Oval 40 Med	40H2	40	
522586	Bronch Holinger FO 8 x 40	527580	LC FO for Hol Oval 40 LG	40H3	40	
522587	Bronch Holinger FO 9 x 40	527580	LC FO for Hol Oval 40 LG	40H3	40	
522600	Bronch Old Holinger 3 x 20	526218	LC Fiber optic 20PH	20PH	20PH	BR 900
522602	Bronch Old Holinger 3.5 x 20	526226	LC Fiber optic 25PH	25	25PH	BR 905
522604	Bronch Old Holinger 3.5 x 30	526230	LC Fiber optic 30PH	30PH	30PH	BR 910
522606	Bronch Old Holinger 4 x 30	526230	LC Fiber optic 30PH	30PH	30PH	BR 915
522608	Bronch Old Holinger 5 x 30	526230	LC Fiber optic 30PH	30PH	30PH	BR 920
523100P	Laser Bronchoscope 3.5 x 20	523101P	LC FO Oval Med 20		20	
523110P	Laser Bronchoscope 4 x 25	523111P	LC FO Oval Med 25	25	25	
523120P	Laser Bronchoscope 5 x 30	527575	LC FO for Hol Oval 30 Med	30LB	30	
523130P	Laser Bronchoscope 6 x 35	523131	LC FO for Hol Oval 35 LG	35LB	35	
523140P	Laser Bronchoscope 7 x 40	527580	LC FO for Hol Oval 40 LG	40H3	40	
523150P	Laser Bronchoscope 8 x 40	527580	LC FO for Hol Oval 40 LG	40H3	40	
523160P	Laser Bronchoscope 9 x 40	527580	LC FO for Hol Oval 40 LG	40H3	40	
523170	YAG Laser Bronch 3.5 x 20	523101P	LC FO Oval Medium 20		20	
523172	YAG Laser Bronch 4 x 25	523111P	LC FO Oval Medium 25	25	25	
523174	YAG Laser Bronch 5 x 30	527575	LC FO for Hol Oval 30 LG	30LB	30	
523176	YAG Laser Bronch 6 x 35	523131	LC FO for Hol Oval 35 LG	35LB	35	
523178P	YAG Laser Bronch 7 x 40	527580	LC FO for Hol Oval 40 LG	40H3	40	
523180P	YAG Laser Bronch 8 x 40	527580	LC FO for Hol Oval 40 LG	40H3	40	
523182	YAG Laser Bronch 9 x 40	527580	LC FO for Hol Oval 40 LG	40H3	40	
523500P	Esoph Holinger FO 5 x 35	526226	LC Fiber optic 25PH	25	25PH	BR 394
523502	Esoph Holinger FO 3.5 x 30	526230	LC Fiber optic 30PH	30PH	30PH	BR 395
523505	Esoph Holinger FO 6 x 20	526218	LC Fiber optic 20PH	20PH	20PH	BR 397
523525	Esoph CLJ Standard FO 5 x 35	526238	LC Fiber optic 35PH	35PH	35PH	BR 456
523527	Esoph CLJ Standard FO 6 x 35	526054	LC Fiber optic 35	35	35	BR 466
523529	Esoph CLJ Standard FO 7 x 45	526068	LC Fiber optic 45	45	45	BR 481
523533	Esoph CLJ Standard FO 8 x 45	526068	LC Fiber optic 45	45	45	BR 496
523535	Esoph CLJ Standard FO 8 x 50	526070	LC Fiber optic 50	50	50	BR 501
523537	Esoph CLJ Standard FO 9 x 30	526048	LC Fiber optic 30	30	30	BR 506
523539	Esoph CLJ Standard FO 9 x 45	526068	LC Fiber optic 45	45	45	BR 511
523541	Esoph CLJ Standard FO 9 x 50	526070	LC Fiber optic 50	50	50	BR 516
523550	Esoph CLJ Full Lumen FO 4 x 35	526238	LC Fiber optic 35PH	35PH	35PH	BR 551
523552	Esoph CLJ Full Lumen FO 5 x 35	526238	LC Fiber optic 35PH	35PH	35PH	BR 556
523554	Esoph CLJ Full Lumen FO 6 x 35	526054	LC Fiber optic 35	35	35	BR 566
523556	Esoph CLJ Full Lumen FO 7 x 45	526068	LC Fiber optic 45	45	45	BR 576

* (L) INDICATES LEFT-SPECIFIC LIGHT CARRIER, (R) INDICATES RIGHT-SPECIFIC LIGHT CARRIER, (2) INDICATES LIGHT CARRIERS REQUIRED



SCOPE AND LIGHT CARRIERS

Identification Index

SCOPES

SCOPE NUMBER	SCOPE DESCRIPTION	LIGHT CARRIER NUMBER*	LIGHT CARRIER DESCRIPTION	NEW LC MARK	LC STAMP	OLD BR SERIES
523558	Esoph CLJ Full Lumen FO 8 x 45	526068	LC Fiber optic 45	45	45	BR 591
523560	Esoph CLJ Full Lumen FO 9 x 30	526048	LC Fiber optic 30	30	30	BR 596
523560	Esoph CLJ Full Lumen FO 9 x 30	526048	LC Fiber optic 30	30	30	BR 596
523562	Esoph CLJ Full Lumen FO 9 x 45	526068	LC Fiber optic 45	45	45	BR 601
523564	Esoph CLJ Full Lumen FO 9 x 50	526070	LC Fiber optic 50	50	50	BR 604
523570	Esoph Holinger FO 3.5 x 30	527510	LC FO for Hol Oval 30 SM	30HB	30	
523571	Esoph Holinger FO 4 x 30	527510	LC FO for Hol Oval 30 SM	30HB	30	
523572	Esoph Holinger FO 6 x 30	527550	LC FO for Hol Oval 30 Med	30EH	30	
523573	Esoph Holinger FO 7 x 30	527550	LC FO for Hol Oval 30 Med	30EH	30	
523574	Esoph Holinger FO 9 x 30	527575	LC FO for Hol Oval 30 LG	30LB	30	
523575	Esoph Holinger FO 5 x 35	527515	LC FO for Hol Oval 35 SM	35H	35	
523576	Esoph Holinger FO 6 x 45	527565	LC FO for Hol Oval 45 Med	45H2	45	
523577	Esoph Holinger FO 7 x 45	527565	LC FO for Hol Oval 45 Med	45H2	45	
523578	Esoph Holinger FO 8 x 53	527585	LC FO for Hol Oval 53 LG	53	53	
523579	Esoph Holinger FO 9 x 53	527585	LC FO for Hol Oval 53 LG	53	53	
523580	Esoph Holinger FO 10 x 53	527585	LC FO for Hol Oval 53 LG	53	53	
523581	Esoph Holinger FO 8 x 45	527583	LC FO for Hol Oval 45 LG	45H3	45	
523582	Esoph Holinger FO 9 x 45	527583	LC FO for Hol Oval 45 LG	45H3	45	
523600P	Esoph CLJ 7 x 10 x 25	526262	LC Fiber optic 25R	25R	25R	BR 530
523602	Esoph CLJ 8 x 12 x 50	526284	LC Fiber optic 50R	50R	50R	BR 540
523604	Esoph CLJ 9 x 3 x 25	526262	LC Fiber optic 25R	25R	25R	BR 532
523606	Esoph CLJ 10 x 14 x 30	526266	LC Fiber optic 30R	30R	30R	BR 534
523608	Esoph CLJ 10 x 14 x 40	526274	LC Fiber optic 40R	40R	40R	BR 538
523610P	Esoph CLJ 10 x 14 x 50	526284	LC Fiber optic 50R	50R	50R	BR 542
523612	Esoph CLJ 12 x 16 x 50	526284	LC Fiber optic 50R	50R	50R	BR 544
523614	Esoph CLJ 12 x 18 x 35	526272	LC Fiber optic 35R	35R	35R	BR 536
523625	Esoph J Roberts 7 x 10 x 22	526260	LC Fiber optic 22R	22R	22R	BR 324
523627	Esoph J Roberts 9 x 13 x 22	526260	LC Fiber optic 22R	22R	22R	BR 325
523629	Esoph J Roberts 10 x 14 x 30	526266	LC Fiber optic 30R	30R	30R	BR 335
523631	Esoph J Roberts 10 x 14 x 40	526274	LC Fiber optic 40R	40R	40R	BR 340
523633	Esoph J Roberts 12 x 16 x 45	526280	LC Fiber optic 45R	45R	45R	BR 347
523635	Esoph J Roberts 12 x 16 x 50	526284	LC Fiber optic 50R	50R	50R	BR 350
523640	Pillsbury-Jesberg Esoph 6 x 8 x 32	526640	LC Pills-Jesberg 523640	32	32	
523642	Pillsbury-Jesberg Esoph 6.5 x 10 x 35	526642	LC Pills-Jesberg 523642	35PJ	35	
523644	Pillsbury-Jesberg Esoph 7 x 10 x 42	526644	LC Pills-Jesberg 523644	42	42	
523646	Pillsbury-Jesberg Esoph 8 x 2 x 45	526646	LC Pills-Jesberg 523646	45PJ	45	
523648	Pillsbury-Jesberg Esoph 10 x 14 x 29	526648	LC Pills-Jesberg 523648	29	29	
523649	Pillsbury-Jesberg Esoph 10 x 14 x 50	526649	LC Pills-Jesberg 523649	50PJ	50	
523650P	Esoph S Jesberg FO 6 x 8 x 32	526268	LC Fiber optic 32J	32J	32J	BR 375
523652	Esoph S Jesberg FO 6.5 x 10 x 35	526270	LC Fiber optic 35J	35J	35J	BR 377
523654	Esoph S Jesberg FO 7 x 10 x 42	526276	LC Fiber optic 42J	42J	42J	BR 379
523656	Esoph S Jesberg FO 8 x 12 x 45	526278	LC Fiber optic 45J	45J	45J	BR 381
523658	Esoph S Jesberg FO 10 x 14 x 29	526264	LC Fiber optic 29J	29J	29J	BR 383
523660P	Esoph S Jesberg FO 10 x 14 x 50	526282	LC Fiber optic 50J	50J	50J	BR 385
523675	Esoph Forbes Child	526020	LC Fiber optic 16A	16A	16A	BR 360
523676	Esoph Forbes Adolescent	526042	LC Fiber optic 19	19	19	BR 365
523677	Esoph Forbes Adult	526046	LC Fiber optic 22	22	22	BR 370
527664	Henderson Mitchell Dilating Esoph	526068	LC Fiber optic 45	45	45	
528700	Bellina Specula Small	528710 (2)	LC for Bellina Specula			
528701	Bellina Specula Medium	528710 (2)	LC for Bellina Specula			
528702	Bellina Specula Large	528710 (2)	LC for Bellina Specula			

* (L) INDICATES LEFT-SPECIFIC LIGHT CARRIER, (R) INDICATES RIGHT-SPECIFIC LIGHT CARRIER, (2) INDICATES LIGHT CARRIERS REQUIRED





CARDIAC, VASCULAR AND THORACIC (CVT) INSTRUMENTS

CHAPTER OVERVIEW

The Pilling® Brand is recognized worldwide for excellence achieved in the area of Cardiac, Vascular and Thoracic (CVT) surgical instrumentation. Proprietary Pilling® CVT Instruments were co-developed with leading surgeons to help improve the standard of patient care and offer a wide selection of unique designs and patterns.

Pilling® CVT Surgical Instruments are high quality OR grade instruments made of German and US stainless steel. Specialty instruments include retractors for IMA takedown and cardiac procedures as well as hand-held instruments used in Mediastinoscopy and Thoracoscopy procedures.

PRODUCTS

Our full line of Pilling® CVT Instruments includes:

- Retractors: IMA, Sternal and Rib Spreaders
- Technique® Needle Holders, Forceps and Scissors
- Mediastinoscopy Instruments
- Thoracic Instruments
- Instrumentation for Video-Assisted Thoracoscopy
- Vascular Instruments
- And many more

FEATURED PRODUCT

Pilling® IMA Retractor

Surgeon Control by Design

- Three-point retraction system spreads and lifts simultaneously for providing better visualization
- Patient-mounted design eliminates cumbersome table mounting
- Left or right IMA takedown capability
- Wide pivot capability permits large surface coverage, spreading retraction over a larger area

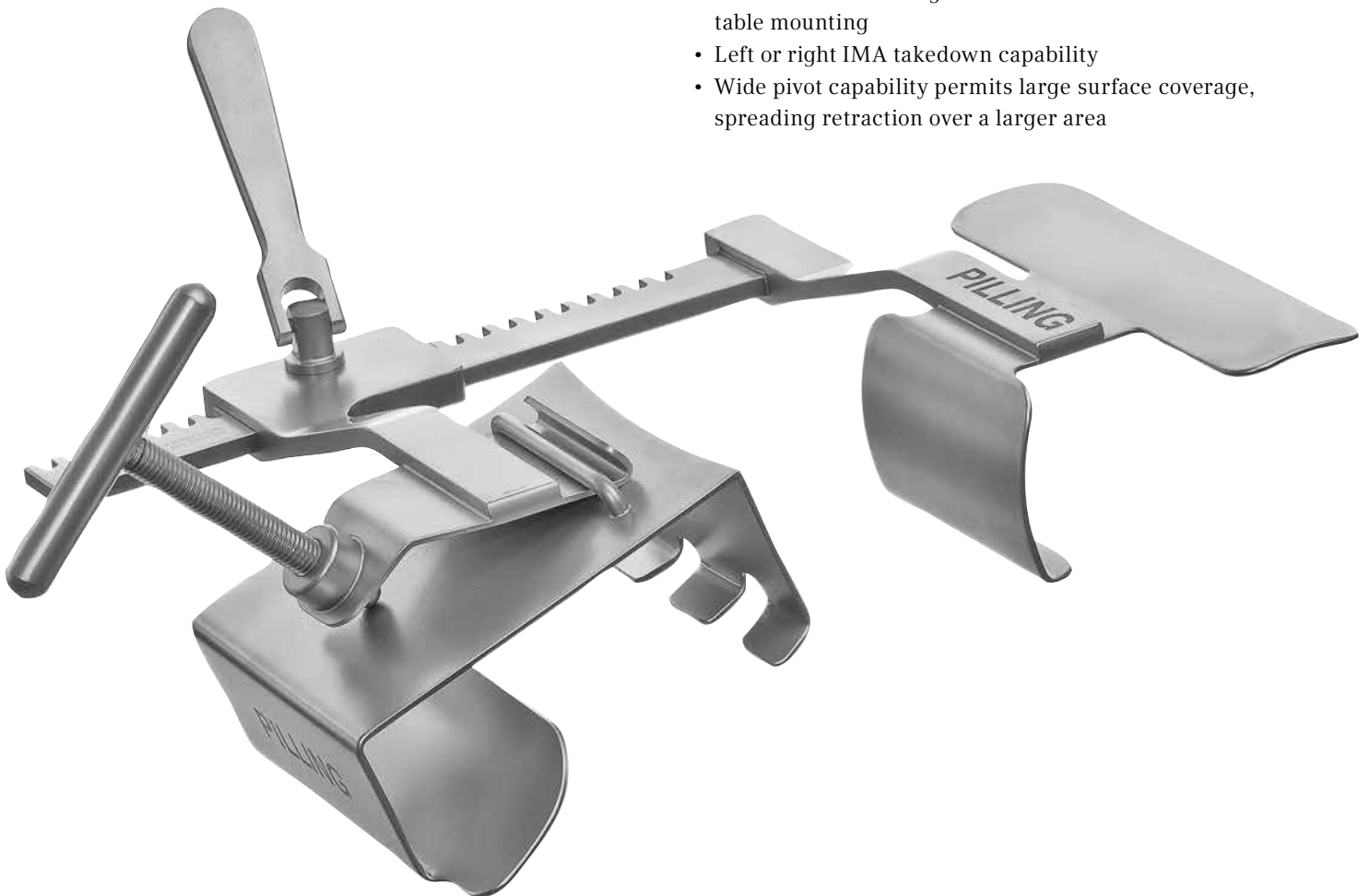

CVT FORCEPS AND CLAMPS

Tissue Forceps

DEBAKEY® THORACIC TISSUE FORCEPS



The row of 1 by 2 DeBakey®-type Serrations on the tips are designed to be large and strong enough to handle relatively large masses of tissue. Because of the groove construction and light spring tension, they may be used to hold and handle suture material as well. These forceps are of heavier design than the DeBakey® Vascular Tissue Forceps (351800 through 351814). The distal portion is tapered to a 3 mm DeBakey®-type Tip.

CATALOG #	DESCRIPTION
342980	Straight, 3 mm tip, 6-1/8" (15.5 cm)
342981	Straight, 3 mm tip, 7-3/4" (19.5 cm)
342982	Straight, 3 mm tip, 9-1/2" (24 cm)
342984	Straight, 3 mm tip, 12" (30.5 cm)
342986	Angled, 3 mm tip, 12" (30.5 cm)

DEBAKEY® VASCULAR TISSUE FORCEPS

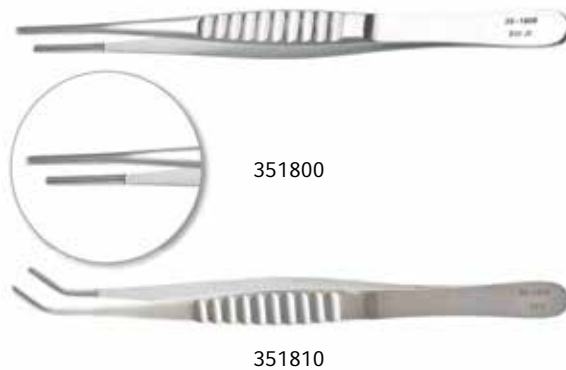

Standard. The distal 2 cm of these forceps is a narrow DeBakey®-type Tip with a width of 2 mm. The body of the instrument is constructed especially to prevent feathering, and all pins and projections have been omitted to help eliminate suture catchers. Jaws are very well fitted for handling tiny vessels as well as the smallest suture material.

CATALOG #	DESCRIPTION
351800	Straight, 2 mm tip, 6" (15 cm)
351802	Straight, 2 mm tip, 7-3/4" (19.5 cm)
351804	Straight, 2 mm tip, 9-1/2" (24 cm)
351808	Straight, 2 mm tip, 12" (30.5 cm)
351810	Angled, 2 mm tip, 6" (15 cm)
351812	Angled, 2 mm tip, 7-3/4" (19.5 cm)
351814	Angled, 2 mm tip, 9-1/2" (24 cm)



CVT FORCEPS AND CLAMPS

Tissue Forceps

DEBAKEY® CARBIDE FORCEPS

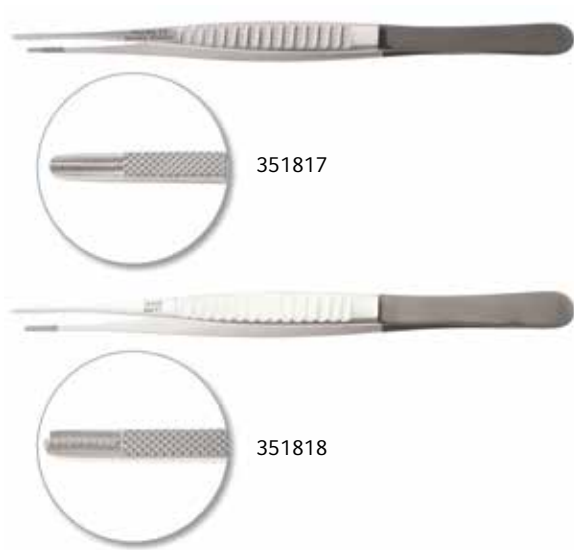

DeBakey®-type Jaws at distal tip. Tungsten carbide insert behind the jaw for secure needle pulling actions.

CATALOG #	DESCRIPTION
351815	Regular forceps, 6" (15 cm), TC
351817	Regular forceps, 7-3/4" (19.5 cm), TC
351819	Regular forceps, 9-1/2" (24 cm), TC
351818	Delicate forceps, 7-3/4" (19.5 cm), TC
351824	Delicate forceps, 9-1/2" (24 cm), TC

DEBAKEY® ULTRALIGHT FORCEPS

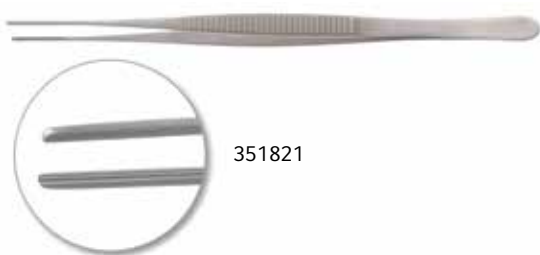

Approximately one-half the weight of standard DeBakey® Forceps, similar to that of titanium but at a much lower price. Ebonized stainless steel to reduce glare. Reduced tension minimizes fatigue and allows better control of delicate tissues.

CATALOG #	DESCRIPTION
351820	1.5 mm tip, 6" (15 cm)
351821	1.5 mm tip, 7-3/4" (19.5 cm)

CVT FORCEPS AND CLAMPS

Tissue Forceps

VASCULAR DEBAKEY® BAYONET TISSUE FORCEPS



351843



DeBakey®-type Jaws with a bayonet shape. Angled handles for difficult access and increased visibility.

CATALOG #	DESCRIPTION
351843	Standard, 2.0 mm tip, 7-3/4" (19.5 cm)
351845	Fine, 1.3 mm tip, 7-3/4" (19.5 cm)



351845

DEBAKEY® DIETHRICH DELICATE VASCULAR TISSUE FORCEPS



351803



Designed for micro-vascular and coronary artery surgery. The distal portion is tapered to a 1 mm extra-fine DeBakey®-type Tip.

CATALOG #	DESCRIPTION
351801	Straight, 1 mm tip, delicate, 1 mm tip, 6" (15 cm)
351803	Straight, 1 mm tip, delicate, 1 mm tip, 7-3/4" (19.5 cm)
351806	Straight, 1 mm tip, delicate, 1 mm tip, 9-1/2" (24 cm)

DEBAKEY® DIETHRICH DIAMA-GRIP TISSUE FORCEPS



351803DG



CATALOG #	DESCRIPTION
351803DG	Straight, 1.3 mm tip, 7-3/4" (20 cm)



CVT FORCEPS AND CLAMPS

Tissue Forceps

COOLEY JAW VASCULAR TISSUE FORCEPS



356000

Narrow double row of fine serrations on each jaw. For delicate handling of tiny vessels and fragile tissue.

CATALOG #	DESCRIPTION
356000	6-1/4" (16 cm)
356002	8" (21 cm)
356003	9-1/2" (24 cm)

CORONARY ULTRA FINE TISSUE FORCEPS



351838

CATALOG #	DESCRIPTION
351837	7" (18 cm)
351838	8" (21 cm)
351839	9" (23 cm)

GERALD DRESSING FORCEPS



351900

These are full-size dressing forceps with only the distal portion narrowed to provide light, delicate tips that maintain alignment.

CATALOG #	DESCRIPTION
351900	Serrated, 7" (18 cm)
351902	Serrated, 9-3/4" (25 cm)

GERALD DRESSING FORCEPS



466225

CATALOG #	DESCRIPTION
466225	Straight, serrated, 1.1 mm tip, 6-7/8" (17.5 cm), TC

CVT FORCEPS AND CLAMPS

Tissue Forceps

GERALD DEBAKEY® TISSUE FORCEPS



Delicate, tapered DeBakey®-type Jaws.



351901



351910

CATALOG #	DESCRIPTION
351901	7" (18 cm)
351908	8" (20.5 cm)
351909	9-1/2" (24 cm)
351910	Angled, 6-7/8" (17.5 cm)

GERALD TISSUE FORCEPS



351905

These are full-size tissue forceps with only the distal portion narrowed to provide light, delicate tips that maintain alignment.

CATALOG #	DESCRIPTION
351905	1 x 2 teeth, 7" (18 cm)
351907	1 x 2 teeth, 9-3/4" (25 cm)



CVT FORCEPS AND CLAMPS

Tissue Forceps

GERALD DIAMA-GRIP DRESSING FORCEPS



CATALOG #	DESCRIPTION
351901DG	Straight, 1.1 mm tip, 7" (18 cm)

CARDIAC VALVE FORCEPS



CATALOG #	DESCRIPTION
351748	9-1/2" (25 cm)

WHEELER TECHNIQUE® PLAQUE AND VESSEL FORCEPS



Very powerful grip at tips.

CATALOG #	DESCRIPTION
351825	DeBakey®-type Jaw, 1.6 mm, 5-1/2" (14 cm)
351827	DeBakey®-type Jaw, 1.6 mm, 7-1/8" (18 cm)
351829	DeBakey®-type Jaw, 1.6 mm, 8-3/4" (22 cm)

NELSON TISSUE FORCEPS



CATALOG #	DESCRIPTION
342950	6 x 7 sharp, fine teeth, 9" (23 cm)

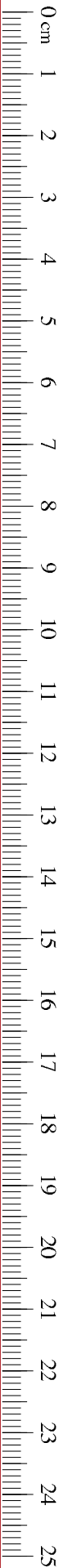

CVT FORCEPS AND CLAMPS

Tissue Forceps

SINGLEY TISSUE FORCEPS

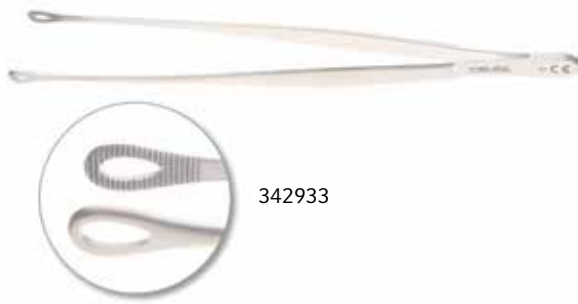

Serrated ring end 8.5 mm wide. Medium-heavy construction.

CATALOG #	DESCRIPTION
342933	9" (23 cm)

TUTTLE THORACIC TISSUE FORCEPS

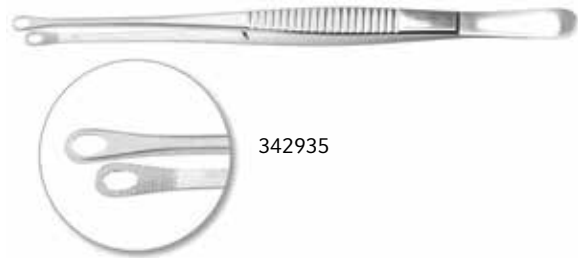

Light construction. Ring tips 6.8 mm wide.

CATALOG #	DESCRIPTION
342935	9" (23 cm)

Micro Forceps

MICRO GRASPING FORCEPS



8 mm round handle. 0.5 mm wide tips have fine cross-hatch serrations for secure yet delicate grip.

CATALOG #	DESCRIPTION
357681	Straight, 7-7/8" (20 cm)



CVT FORCEPS AND CLAMPS

Micro Forceps

MICRO TYING FORCEPS



Round handle, 8 mm diameter.

CATALOG #	DESCRIPTION
357658	Straight 0.5 mm wide tip with platform, 6" (15 cm)
357659	Curved 0.5 mm wide tip with platform, 6" (15 cm)
357660	Straight 0.5 mm wide tip with platform, 7-1/8" (18 cm)
357661	Curved 0.5 mm wide tip with platform, 7-1/8" (18 cm)

TEW TYING FORCEPS



Straight jaw with longitudinal serrations.

CATALOG #	DESCRIPTION
394430	Straight, 0.6 mm tip, 7-1/8" (18 cm)
394431	Straight, 1 mm tip, 7-1/8" (18 cm)

CVT FORCEPS AND CLAMPS

Micro Forceps

MICRO RING TIP FORCEPS



357645



357647



357648

The 0.5 mm ring tip forceps are designed for the mammary/coronary arteries and other 1-3 mm sized vessels (e.g., tibial arteries in the lower leg). The 1.5 mm ring tip forceps are designed for larger vessels such as the saphenous vein, femoral arteries, etc. The ring tip forceps allows for a more secure grip on the tissue, yet it still has a very fine tip. The sizing 1.5 mm and 0.5 mm pertains to the size of the hole in the tip.

CATALOG #	DESCRIPTION
357645	Saphenous/aorta, 1.5 mm ring tip forceps, 7" (18 cm)
357647	Mammary/coronary, 0.5 mm ring tip forceps, 7" (18 cm)
357648	Mammary/coronary, 0.5 mm ring tip forceps, 7-3/4" (20 cm)

MICRO DIAMA-GRIP RING FORCEPS



357645DG

Diama-Grip jaws.

CATALOG #	DESCRIPTION
357647DG	Small ring tip, 1 mm, 7" (18 cm)
357648DG	Small ring tip, 1.2 mm, 8" (21 cm)
357645DG	Large ring tip, 1.5 mm, 7" (18 cm)

CVT FORCEPS AND CLAMPS

Micro Forceps

DENIS MICRO RING FORCEPS



358007

CATALOG #	DESCRIPTION
358007	Straight, smooth, 1 mm tip, Diamo-Grip jaws, 8-1/4" (21 cm)

Ligature Carriers

DARLING TAPE PASSING CLAMP "AORTA GO AROUND"



353647

Specifically designed for passing ligature or tapes around the intrarenal abdominal aorta. Slightly angled, curved jaw with short segment of DeBakey®-type Teeth.

CATALOG #	DESCRIPTION
353647	Curved, DeBakey® Jaw, 2" (5 cm) tip length, curved shaft, 11-3/4" (29.5 cm)

DEBAKEY® MODIFIED SEMB LIGATURE CARRIER

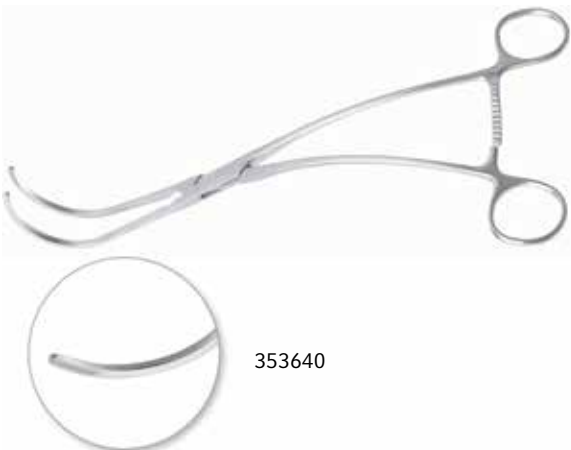

353640

The distal 1.5 mm of the jaws are a DeBakey®-type Design to securely hold a ligature or umbilical tape for passage around the aorta. Jaws curve on 2.5 cm radius.

CATALOG #	DESCRIPTION
353640	10-3/8" (26.5 cm)

CVT FORCEPS AND CLAMPS

Ligature Carriers

FAVALORO-SEMB LIGATURE CARRIERS



353645

Jaws are constructed so that only the distal DeBakey®-type surfaces approximate. The smooth portion of the jaws remains open to prevent inadvertent clamping of the aortic wall.

CATALOG #	DESCRIPTION
353645	Half curved, 11-1/4" (28.5 cm)
353646	Full curved, 10-7/8" (27.5 cm)

SEMB DISSECTING FORCEPS



342710

For dissecting and breaking adhesions.

CATALOG #	DESCRIPTION
342710	Slight curve, 10-1/4" (26 cm)

SEMB LIGATURE FORCEPS



342711

Acute curve. Tips perforated for use as a ligature carrier.

CATALOG #	DESCRIPTION
342711	9-3/4" (25 cm)

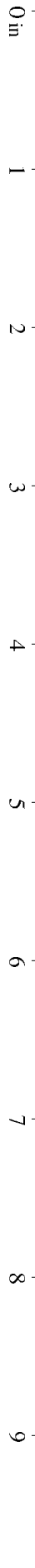

CVT FORCEPS AND CLAMPS

Bronchus and Lung Clamps

BABCOCK TISSUE FORCEPS



CATALOG #	DESCRIPTION
183010	6-1/4" (16 cm)
183020	7-7/8" (20 cm)
342725	Serrated, 3/8" (9.5 mm) jaw, 9-1/2" (24 cm)
342726	Serrated, 1/2" (12.5 mm) jaw, 9-1/2" (24 cm)

342726

BRONCHUS CLAMP

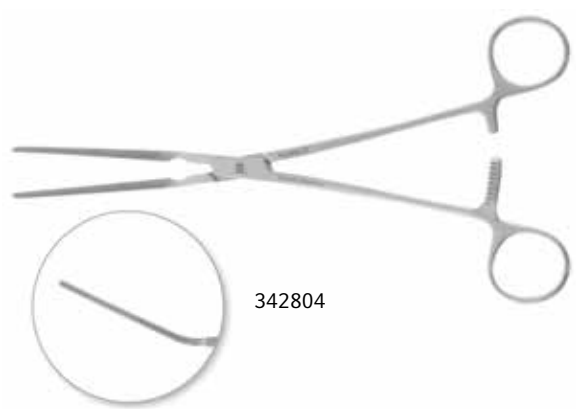

25 degree angled DeBakey®-type Jaws are 5.5 cm long beyond angle.

CATALOG #	DESCRIPTION
342804	9" (23 cm)

342804

COLLIN LUNG TISSUE FORCEPS

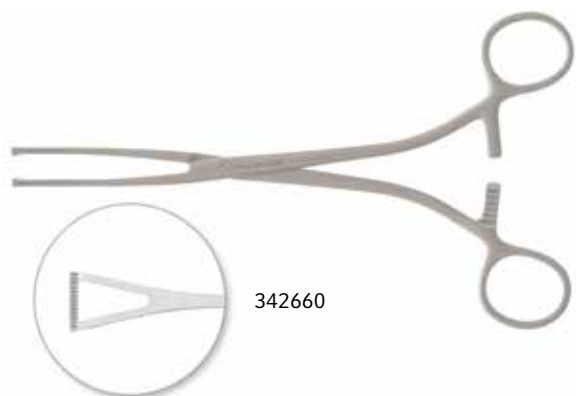

Light, screw lock box design. Teeth across entire distal edge.

CATALOG #	DESCRIPTION
342660	5/8" (16 mm) jaw, 8" (20.5 cm)
342662	1-1/8" (28.5 mm) jaw, 8" (20.5 cm)
342664	1-1/8" (28.5 mm) jaw, 9" (23 cm)

342660



CVT FORCEPS AND CLAMPS

Bronchus and Lung Clamps

DEBAKEY® LUNG GRASPING FORCEPS

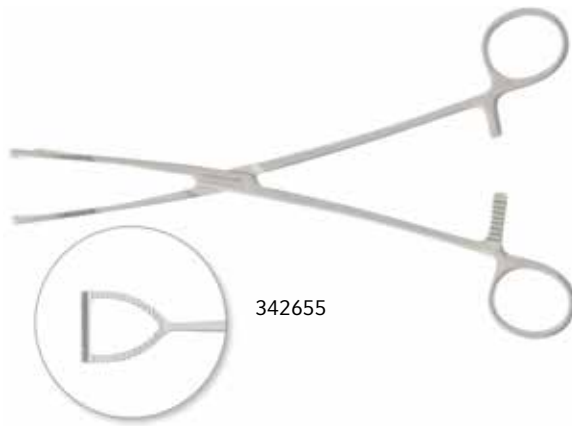

DeBakey®-type Distal Sections on specially shaped fenestrated jaws provide a soft but secure hold with minimum tissue damage. Distal edge of jaws is 2.5 cm wide.

CATALOG #	DESCRIPTION
342655	9" (23 cm)

DUVAL LUNG TISSUE FORCEPS

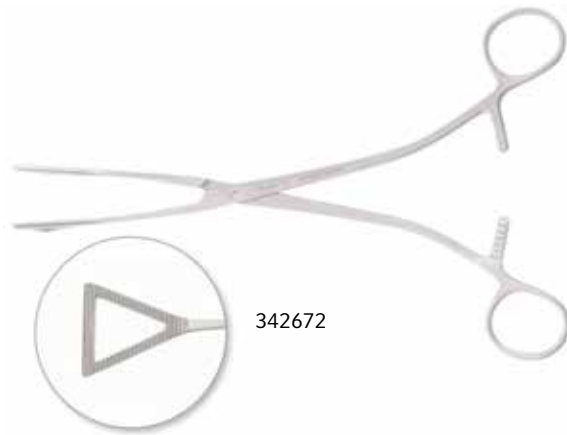

Light, screw lock box design. DeBakey®-type, serrated Jaws. Jaw width 1" (2.5 cm).

CATALOG #	DESCRIPTION
342670	8" (21 cm)
342672	9" (23 cm)



CVT FORCEPS AND CLAMPS

Bronchus and Lung Clamps

LEES BRONCHUS CLAMPS

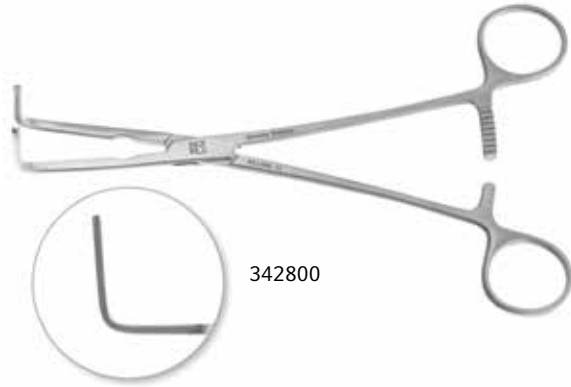

Also serves as a general purpose vascular clamp. DeBakey®-type Jaw is 4 cm long beyond angle.

CATALOG #	DESCRIPTION
342800	Right angle, 8-1/8" (20.5 cm)
342802	Angled, 10" (25.5 cm)

LOVELACE LUNG TISSUE FORCEPS



CATALOG #	DESCRIPTION
342675	Angled to side, 1" (2.5 cm) DeBakey®-type Jaw, 7-1/2" (19 cm)

REVUELTA-GARCIA ALLIS CURVED CLAMPS

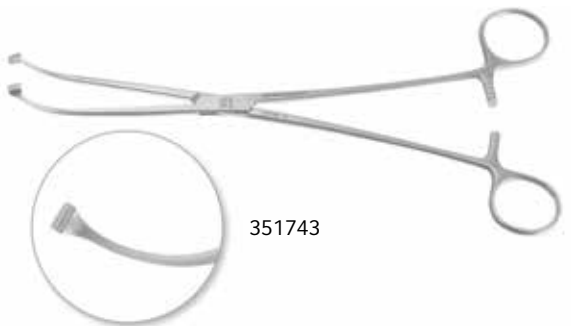

Half curved, DeBakey® Jaw.

CATALOG #	DESCRIPTION
351743	10-1/8" (25.5 cm)
351744	10-7/8" (27.5 cm)

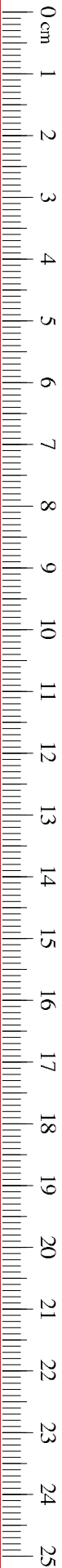

CVT FORCEPS AND CLAMPS

Bronchus and Lung Clamps

SAROT BRONCHUS CLAMPS



Teeth ensure a non-slipping hold on bronchus. Clamps are made in left and right models so that spiked blade will never be passed beneath the bronchus, thus avoiding trauma. Adult size 9-1/4" (23.4 cm) length to angle, 3.3 cm jaw length.

CATALOG #	DESCRIPTION
342822	Right
342823	Left

WILLAUER-ALLIS TISSUE FORCEPS

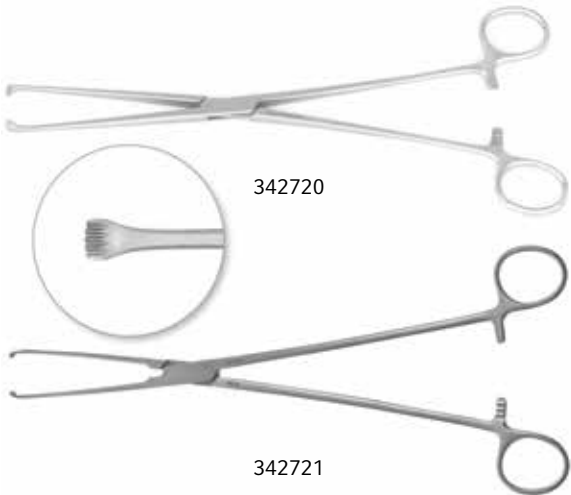

Extra long, springy, Allis-type forceps with 5 x 6 teeth. Dull, non-glare finish, stainless steel.

CATALOG #	DESCRIPTION
342720	10" (25.5 cm)
342721	11-1/4" (28.5 cm)



CVT FORCEPS AND CLAMPS

Chest Drain Pulling Clamp

CHEST DRAIN PULLING CLAMP



Pointed Rochester-Pean-type hemostat with three spikes in the jaw for tunneling, grasping and pulling chest drains.

CATALOG #	DESCRIPTION
343590	8-5/8" (22 cm)

BULLDOG® AND MICRO VESSEL CLAMPS

Bulldog® Clamps

DEBAKEY® CROSS ACTION BULLDOG® CLAMPS



353050



353052



353054



353062

These DeBaKEY®-type Jaw Clamps are used for temporary occlusion of major peripheral arteries. They are made in several sizes to facilitate their application under varying circumstances. They present a relatively smooth surface with particular attention to the elimination of suture-catching projections.

CATALOG #	DESCRIPTION
353050	Straight, 3/4" (2 cm) tip length, 3-1/8" (8 cm)
353052	Straight, 1-1/8" (3 cm) tip length, 3-1/2" (9 cm)
353054	Straight, 2" (5 cm) tip length, 4-1/4" (11 cm)
353056	Straight, 2-5/8" (6.8 cm) tip length, 4-7/8" (12.5 cm)
353060	Curved, 5/8" (1.5 cm) tip length, 2-7/8" (7.5 cm)
353062	Curved, 1" (2.5 cm) tip length, 3-1/4" (8 cm)
353064	Curved, 1-5/8" (4 cm) tip length, 3-7/8" (10 cm)
353066	Curved, 2-1/8" (5.5 cm) tip length, 4-1/4" (11 cm)



353066



BULLDOG® AND MICRO VESSEL CLAMPS

Bulldog® Clamps

DIETRICH BULLDOG® CLAMPS

Low tension clamps for coronary arteries.



353150



353151



353152



353153

CATALOG #	DESCRIPTION
353150	Straight, 3/8" (9.5 mm) jaw
353151	Straight, 1/2" (12 mm) jaw
353152	Straight, 3/4" (20 mm) jaw
353153	Angled, 5/16" (8 mm) jaw
353154	Angled, 1/2" (12 mm) jaw
353155	Angled, 3/4" (20 mm) jaw



353154



353155

EFFLER-GROVES SPECIAL LIGHTWEIGHT BULLDOG® CLAMP

Delicate model for clamping the mammary artery.



355819

CATALOG #	DESCRIPTION
355819	2-3/4" (7 cm)



BULLDOG® AND MICRO VESSEL CLAMPS

Bulldog® Clamps

GLOVER STYLE BULLDOG® CLAMPS

With DeBakey®-type Jaws. These clamps are designed to permit regulation of the tension by means of an adjusting screw. The largest sizes are made specifically for temporary occlusion of large arteries such as the carotid, subclavian and iliac.



353100



353102



353105



353112



CATALOG #	DESCRIPTION
353100	Straight, 3/4" (2 cm) jaw, 2-1/4" (5.5 cm)
353102	Straight, 1-1/4" (3.5 cm) jaw, 2-3/4" (7 cm)
353105	Straight, 1-5/8" (4 cm) jaw, 3-1/2" (9 cm)
353110	Curved, 5/8" (1.5 cm) jaw, 2" (5 cm)
353112	Curved, 1" (2.5 cm) jaw, 2-1/2" (6 cm)
353115	Curved, 1-3/8" (3.5 cm) jaw, 3-1/8" (8 cm)
353120	Angled, 1-1/4" (3.5 cm) jaw, 1-7/8" (5 cm)



353120



BULLDOG® AND MICRO VESSEL CLAMPS

Bulldog® Clamps

HESS ANGULAR MOSQUITO TIP SERREFINE



353025

The pointed, serrated tips greatly facilitate cannulation of very small blood vessels where exposure is limited. The weak spring avoids crushing the vasculature.

CATALOG #	DESCRIPTION
353025	2-1/8" (5.5cm)

JACOBSON BULLDOG® CLAMPS



353131

353132

CATALOG #	DESCRIPTION
353131	Straight, 1-7/8" (5 cm)
353132	Curved, 1-5/8" (4.5 cm)



BULLDOG® AND MICRO VESSEL CLAMPS

Bulldog® Clamps

JOHNS HOPKINS (BLALOCK) BULLDOG® CLAMPS



353001



353002



353003

CATALOG #	DESCRIPTION
353001	Straight, 1-1/2" (4 cm)
353002	Straight, 1-7/8" (5 cm)
353003	Straight, 2-1/4" (5.5 cm)
353011	Curved, 1-1/2" (4 cm)
353012	Curved, 1-7/8" (5 cm)
353014	Curved, 2-1/2" (6.5 cm)
353016	Curved, 3" (7.5 cm)



353012



353014

SANTULLI ANGULAR MODEL BULLDOG® CLAMP



353070

CATALOG #	DESCRIPTION
353070	Angled, DeBakey® Jaw length 1-5/8" (4 cm)

BULLDOG® AND MICRO VESSEL CLAMPS

Bulldog® Clamps

SENNING FEATHERWEIGHT BULLDOG® CLAMPS



353135

Very lightweight at 2 grams. Available in four tensions. Tension may be readjusted if necessary. Parallel jaws consist of double, opposing, finely serrated rows. 1-3/4" (4.5 cm).

CATALOG #	DESCRIPTION
353135	No. 1, Strong
353136	No. 2, Medium Strong
353137	No. 3, Medium Light
353138	No. 4, Light



353136



353137



353138



BULLDOG® AND MICRO VESSEL CLAMPS

Bulldog® Clamps

WOOD BULLDOG® CLAMPS



353123



353125



353124



353126

Strong closing pressure.

CATALOG #	DESCRIPTION
353123	Straight, 3/8" (8 mm) jaw, 1-3/4" (4.5 cm)
353125	Straight, 1/2" (12 mm) jaw, 1-7/8" (5 cm)
353127	Straight, 3/4" (19 mm) jaw, 2" (5 cm)
353124	Angled, 3/8" (8 mm) jaw, 1-5/8" (4 cm)
353126	Angled, 1/2" (12 mm) jaw, 1-3/4" (4.5 cm)
353128	Angled, 3/4" (19 mm) jaw, 1-7/8" (5 cm)



353128

WYLIE LUMBAR BULLDOG® CLAMP



353075

Jaw is more gently curved than the standard DeBakey® Bulldog® Jaw. Designed for placement posterior to the aorta for occlusion of lumbar arteries.

CATALOG #	DESCRIPTION
353075	7/8" (2 cm) jaw, 3" (7.5 cm)



BULLDOG® AND MICRO VESSEL CLAMPS

Micro Vessel Clamps

BRACHIAL LARGE VESSEL CLIPS



24 mm blade, 2.5 mm wide at tip. Overall length 1.61" (4 cm).

CATALOG #	DESCRIPTION
065110	Straight
065111	Tapered

BULLDOG® CLAMP APPLYING FORCEPS



This long clamp makes fast application and removal of any Bulldog® Clamp an easy task, even in the most inaccessible spot.

CATALOG #	DESCRIPTION
353035	9-1/2" (24 cm)

KLEINERT-KUTZ MICRO VESSEL CLIPS



065105



065145

CATALOG #	DESCRIPTION
065100	Straight blade, 1 x 3 mm, 0.34" (8.5 mm)
065105	Straight blade, 1 x 5 mm, 0.40" (10 mm)
065125	Angled blade, 1 x 5 mm
065145	Curved blade, 1 x 6 mm

BULLDOG® AND MICRO VESSEL CLAMPS

Micro Vessel Clamps

TEMPORARY OCCLUSION CLIPS



CATALOG #	DESCRIPTION
065108	7 x 2 mm blade
065109	12 x 2 mm blade

LOUISVILLE MICRO VESSEL APPROXIMATOR WITH CLIPS



With suture staying frame.

CATALOG #	DESCRIPTION
065172	1.5 x 8 mm blades, 1/2" (12.5 mm) bar
065173	1 x 5 mm blades, 7/16" (11 mm) bar

KLEINERT-KUTZ MICRO CLIP APPLYING FORCEPS



CATALOG #	DESCRIPTION
065155	2-1/2" (6.5 cm)



BULLDOG® AND MICRO VESSEL CLAMPS

Micro Vessel Clamps

RIZZUTI ANGLED MICRO CLIP APPLYING FORCEPS



Applier opens approximator simultaneously or individually.

CATALOG #	DESCRIPTION
065175	5-1/2" (14 cm)

SCHWARTZ MICRO-BULLDOG® CLAMPS



For temporary occlusion of minor vessels. 1" (2.5 cm).

CATALOG #	DESCRIPTION
353041	Straight
353042	Slight curve
353043	Acute curve

SCHWARTZ CLAMP HOLDING FORCEPS



CATALOG #	DESCRIPTION
353040	7-1/2" (19 cm)



BULLDOG® AND MICRO VESSEL CLAMPS

Micro Vessel Clamps

RENAL PERFUSION CLAMPS



- Designed to reduce risk of intimal damage.
- Eliminates necessity for artery cannulation.
- Minimizes disadvantages of en bloc perfusion and preservation.

CATALOG #	DESCRIPTION
353140	10 mm x 15 mm DeBakey®-type Jaw (Pediatric, single renal artery)
353142	10 mm x 25 mm DeBakey®-type Jaw (Adult, multiple renal arteries)



BULLDOG® AND MICRO VESSEL CLAMPS

Micro Vessel Clamps

MICRO-ANEURYSM BULLDOG® CLIPS AND APPLIERS



357580



357581



357582



357583



357586

Closing force is approximately 170 grams.
Recommended for single use only.

CATALOG #	DESCRIPTION
357580	Straight, 7 mm
357581	Straight, 8 mm
357582	Angled, 9 mm
357583	Slight curve, 9 mm
357586	Applying forceps for Micro-Aneurysm Clips, 7-1/2" (19 cm)

Caution: These clips should be compressed only when properly seated in the appropriate applying forceps, never with the fingers. If compression of a clip is started but the clip is not used, it must be discarded and a new clip used.



BULLDOG® AND MICRO VESSEL CLAMPS

Micro Vessel Clamps

MINI-ANEURYSM BULLDOG® CLIPS AND APPLIERS



357590



357591



357592



357593

Closing force is approximately 170 grams.
Recommended for single use only.

CATALOG #	DESCRIPTION
357590	Straight, 4 mm
357591	Straight, 6 mm
357592	Curved, 7 mm
357593	Applying forceps for Mini-Aneurysm Clips, 8-1/4" (21 cm)

Caution: These clips should be compressed only when properly seated in the appropriate applying forceps, never with the fingers. If compression of a clip is started but the clip is not used, it must be discarded and a new clip used.

MICRO CLIP TRAY



065199

CATALOG #	DESCRIPTION
065199	1-3/4" x 2-3/4" x 1/2" (4.5 x 7 x 1.5 cm)



PILLING® VASCULAR CLAMPS

DEBAKEY®-Type Clamp

A single row of finely serrated teeth opposing a double row, precisely crafted. Designed to deliver the most minimal trauma to tissue.

TIPS

Uniformly rounded. Virtually eliminates the potential for suture snag.

JAWS

Jaws on Pilling® Clamps are set with precision. Coordination of ratchet length and jaw setting provides the precise amount of required compression.

CREST

Prevents inadvertent pinching of tissue by providing an expansion area for the tissue.

RATCHETS

Provide the finite control necessary in cardiovascular thoracic surgery. They are designed to furnish the precise increments of pressure desired. Offered in 1 x 7, 1 x 9, 1 x 11 steps.

SHANKS

Tempered to eliminate rigidity while providing proportionate softness.

FINGER RINGS

Comfortably sized.

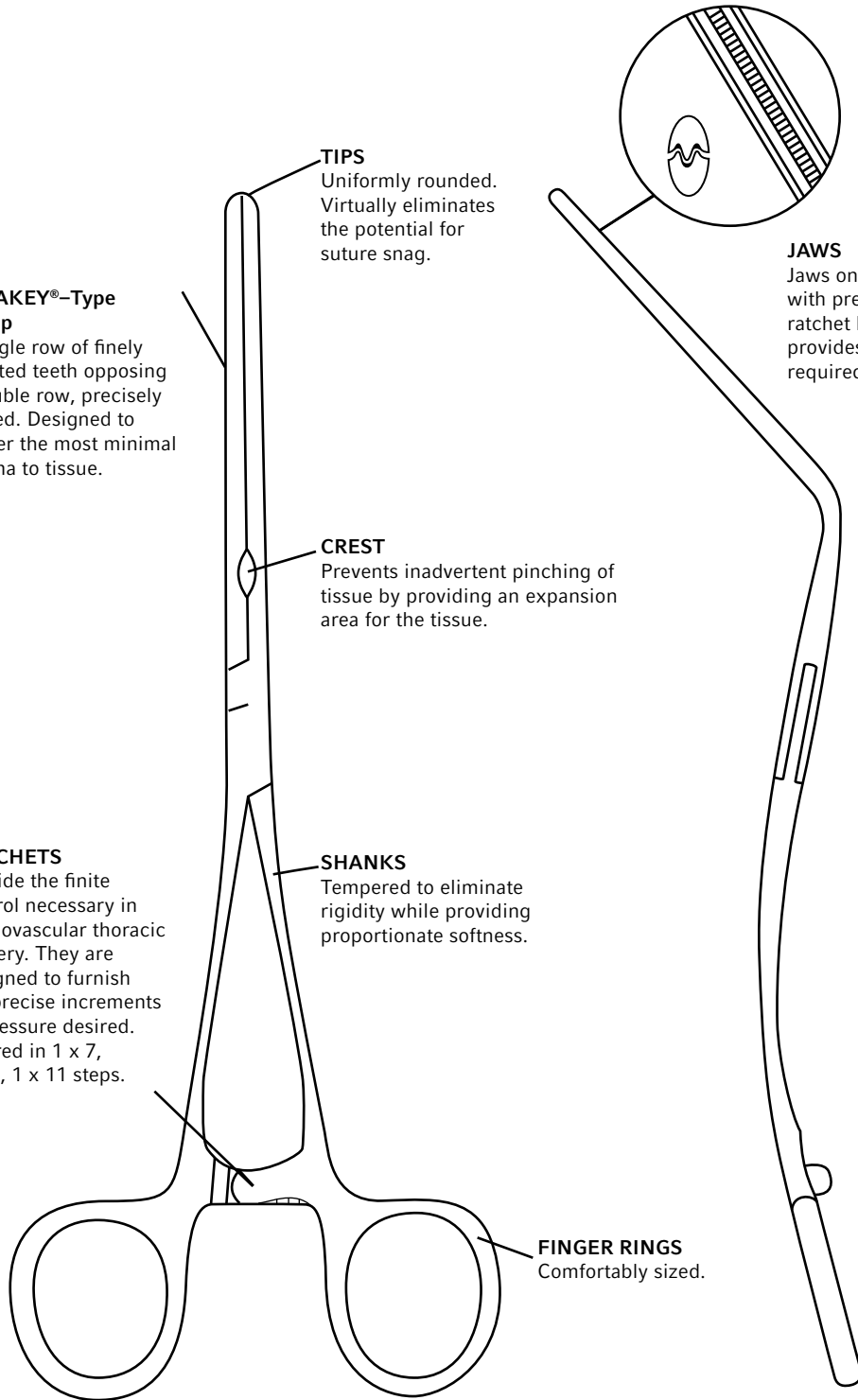

PILLING® VASCULAR CLAMPS

Types of Jaws Used in Pilling® Cardiovascular Clamps

JAW CROSS SECTIONS

Relative Size

Enlargement



DeBakey®-type

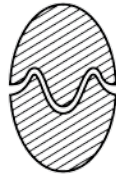

A single row of serrated teeth opposing a double row. The most commonly used jaw design (and most imitated). Proven through many years' use at hospitals throughout the world on adult peripheral vascular, aortic occlusion and partial occlusion clamps.



Small DeBakey®-type



A small version of the DeBakey®-type Jaws used on most bulldogs, vascular tissue forceps and numerous pediatric clamps.



Extra Fine DeBakey®-type



The smallest size DeBakey®-type Jaws used on many new pediatric and adult peripheral vascular clamps, bulldogs and forceps.



DeBakey®-type 2 x 3

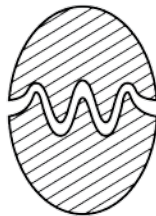

Double row of serrated teeth opposing a triple row. This modified version of the DeBakey®-type Serration, having a broader clamping surface, is used on large clamps for aortic cross clamping and on diseased and calcified arteries. Clamps with the 2 x 3 serration are also used frequently in general surgery as bowel clamps.



Cooley



Two opposing rows of atraumatic teeth. Designed especially for surgery on infants and children as the jaws grasp vessels firmly. Also available on a limited group of adult vascular clamps.



Pediatric, 1 mm



Narrow, single row of opposing teeth. Designed for neonatal vascular surgery, these clamps have also proven of value in adult surgery of the carotid femoral and popliteal arteries and for creating AV fistulas.



VASCULAR CLAMPS

Pediatric Clamps, 1 mm Jaw

CASTANEDA PEDIATRIC CLAMPS

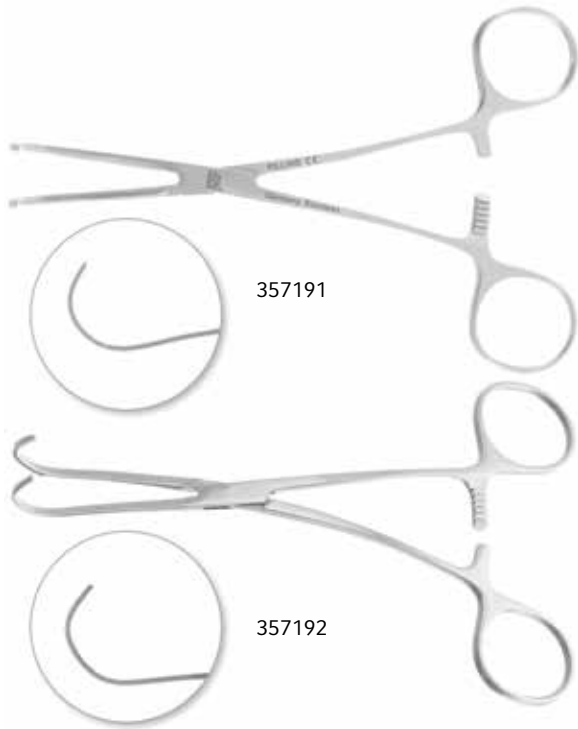

Versatile, multipurpose clamps designed for neonatal use. Long, slightly curved handles, 1 x 6 ratchets.

CATALOG #	DESCRIPTION
357191	Long, small jaw, 1 mm thick, 9/16" (1.5 cm), spring handle, 1 x 6 ratchets, 6" (15 cm)
357192	Long, large jaw, 1 mm thick, 3/4" (2 cm), spring handle, 1 x 6 ratchets, 6" (15 cm)

PILLING® LONG 1 MM PEDIATRIC CLAMPS

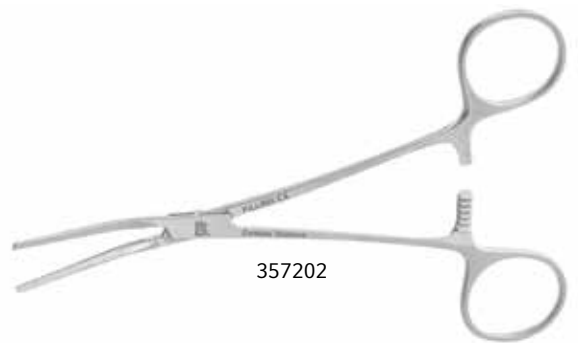

To determine the overall length of our vascular clamps, measure the handle type and the jaw type and add measurements together to obtain the overall size. Blades are scribed from the tips in 5 cm graduations.

CATALOG #	DESCRIPTION
357200	Straight handles, 6-1/8" (15.5 cm)
357202	Straight handles, 6-1/8" (15.5 cm)
357262	Angled handles, 5-5/8" (14.5 cm)
357270	Angled handles, 5-7/8" (15 cm)

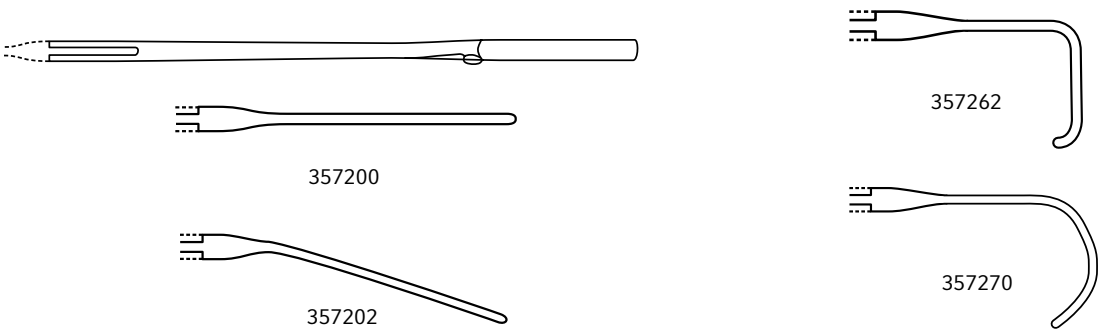



VASCULAR CLAMPS

Pediatric Clamps, 1 mm Jaw

PILLING® SHORT 1 MM PEDIATRIC CLAMPS

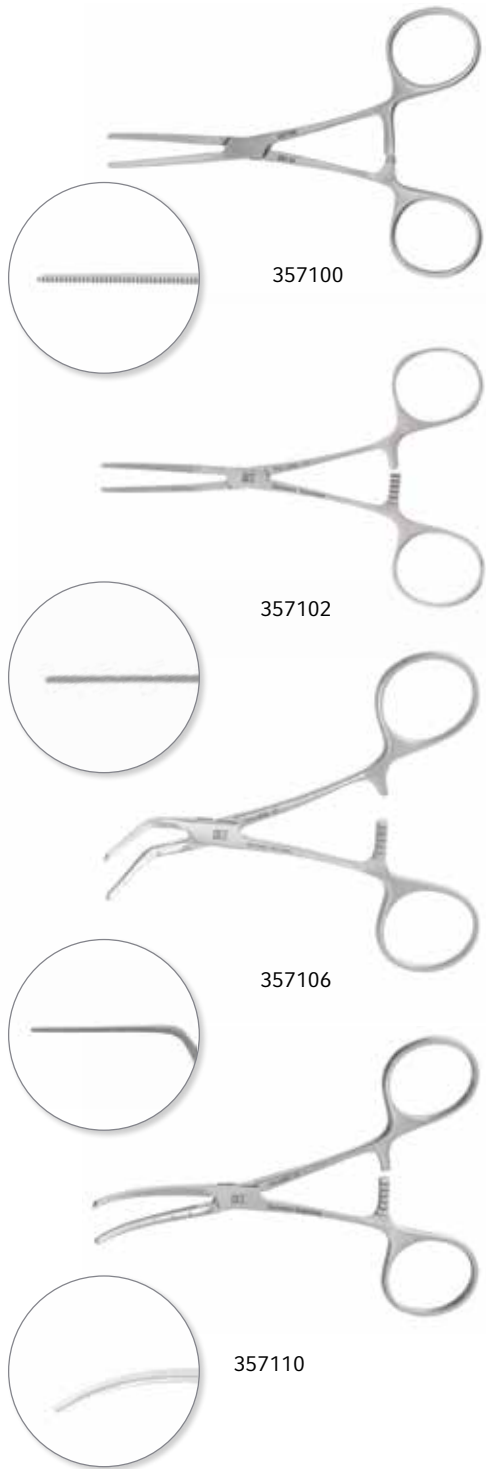

CATALOG #	DESCRIPTION
357100	Straight handles, 4-5/8" (12 cm)
357102	Straight handles, 4-1/2" (11.5 cm)
357106	Straight handles, 4" (10.5 cm)
357110	Straight handles, 4-1/2" (11.5 cm)



VASCULAR CLAMPS

Pediatric Clamps, 1.5 mm Jaw

DEBAKEY® COARCTATION CLAMPS

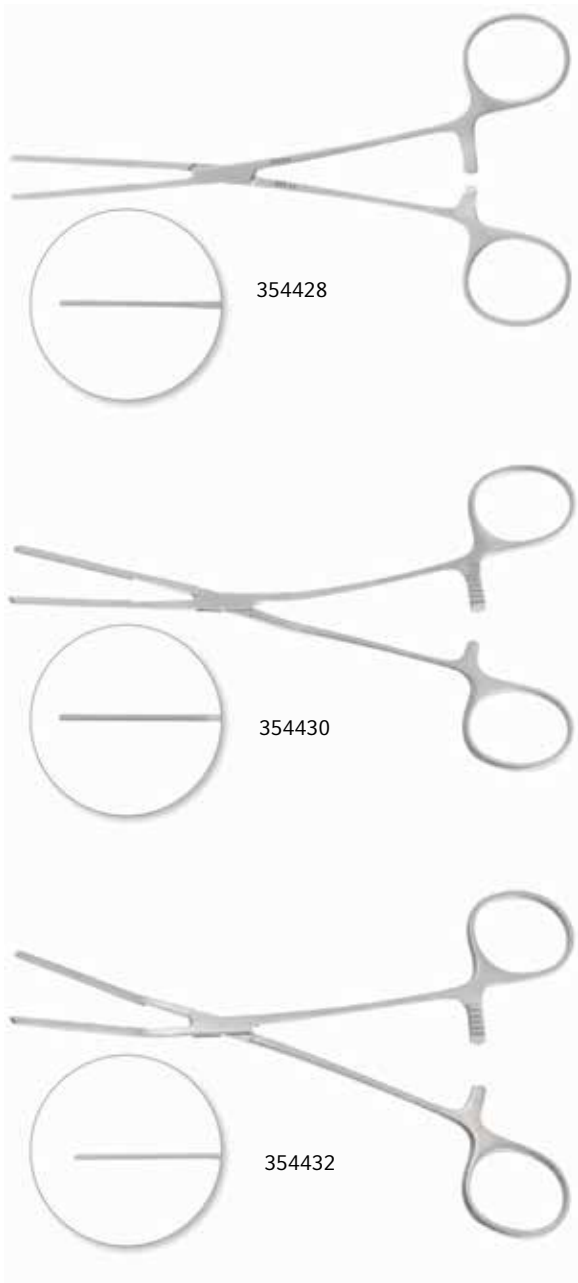

CATALOG #	DESCRIPTION
354428	Straight, 6-3/8" (16 cm)
354430	Angled shank, 6-1/4" (16 cm)
354432	Jaw angled 15 degrees, 6-1/2" (16.5 cm)



VASCULAR CLAMPS

Pediatric Clamps, 1.5 mm Jaw

DEBAKEY® PARTIAL OCCLUSION CLAMPS

CATALOG #	DESCRIPTION
354488	Small, 4-3/8" (11 cm)
354490	Medium, 4-3/8" (11 cm)
354494	Large, 6-1/4" (16 cm)
354496	Small, extra-long, 6-5/8" (17 cm)



354488

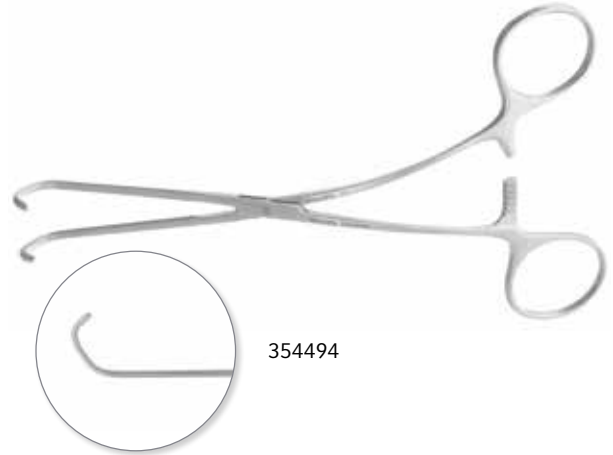

354494



354490

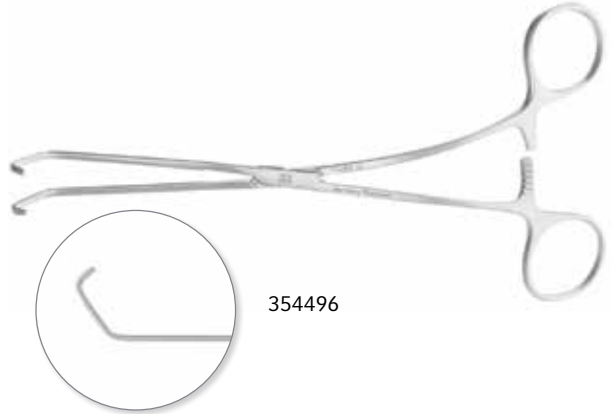

354496



VASCULAR CLAMPS

Pediatric Clamps, 1.5 mm Jaw

DEBAKEY® SPOON CLAMPS

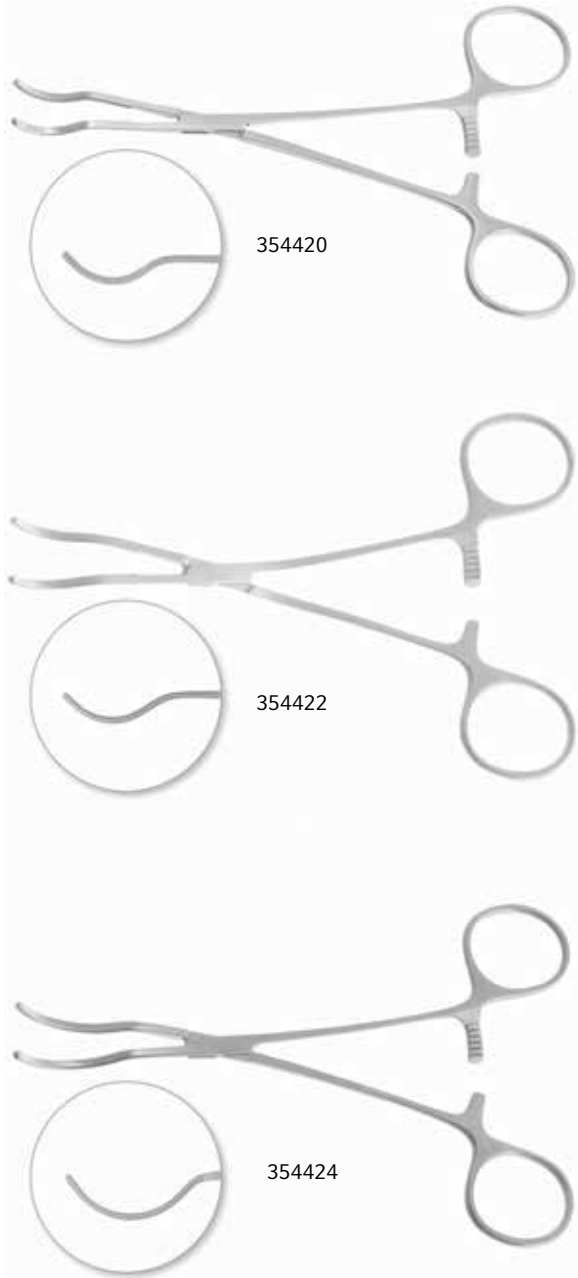

CATALOG #	DESCRIPTION
354420	Small spoon, 6-1/4" (16 cm)
354422	Small spoon, angled, 5-3/4" (14.5 cm)
354424	Large spoon, 6-1/8" (15.5 cm)

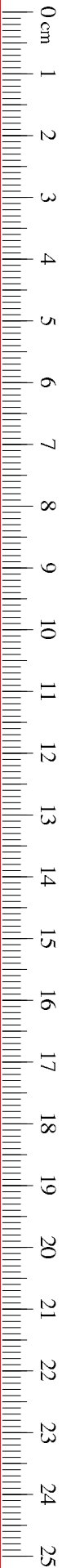

VASCULAR CLAMPS

Pediatric Clamps, 1.5 mm Jaw

DEBAKEY® MULTIPURPOSE VASCULAR CLAMPS

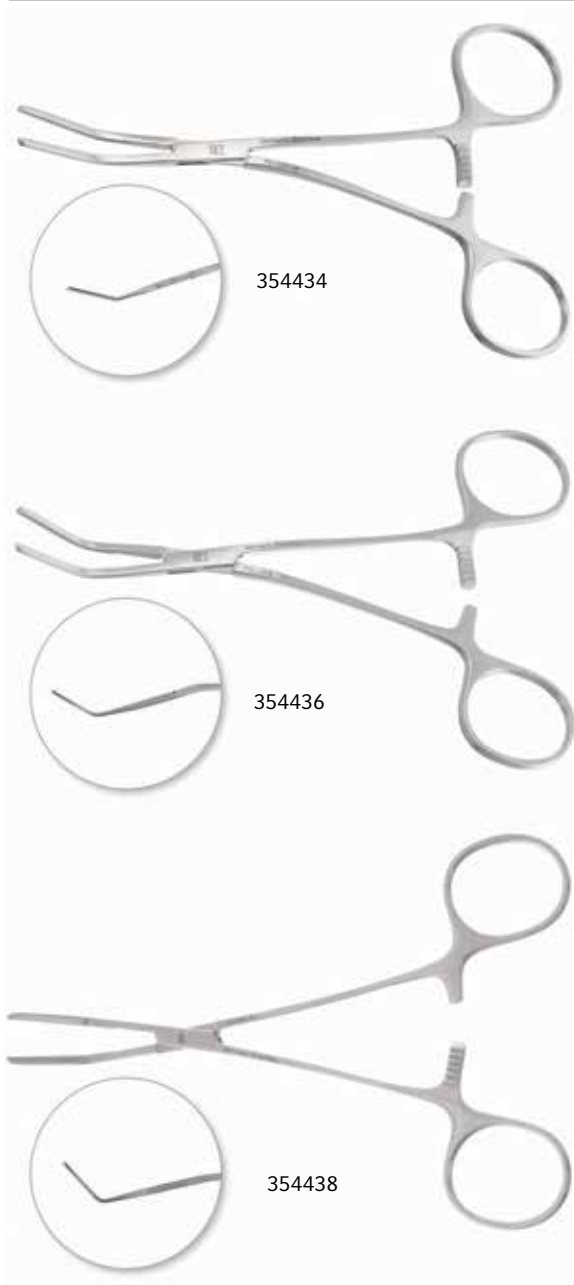

CATALOG #	DESCRIPTION
354434	Angled 30 degrees, jaw length 20 mm, 5-3/4" (14.5 cm)
354436	Angled 45 degrees, jaw length 20 mm, 5-1/2" (14 cm)
354438	Angled 60 degrees, jaw length 20 mm, 5-3/8" (13.5 cm)



VASCULAR CLAMPS

Pediatric Clamps, 1.5 mm Jaw

DEBAKEY® MULTIPURPOSE VASCULAR CLAMPS LONG

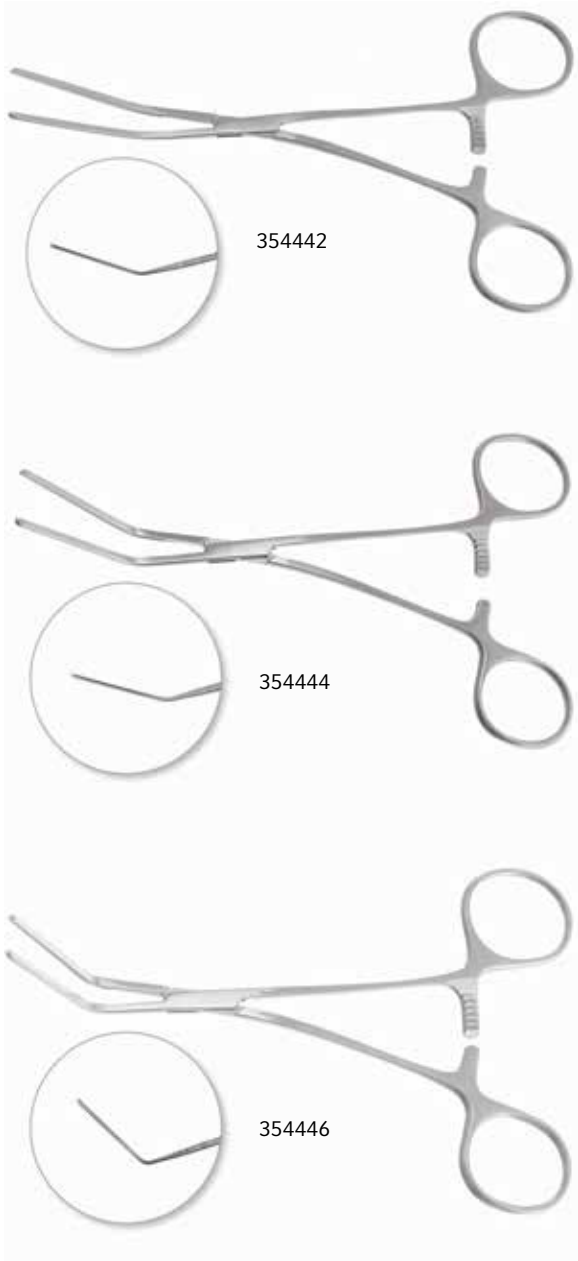

CATALOG #	DESCRIPTION
354442	Angled 30 degrees, 6-1/2" (16.5 cm)
354444	Angled 45 degrees, 6-1/8" (15.5 cm)
354446	Angled 60 degrees, 5-3/4" (14.5 cm)

VASCULAR CLAMPS

Pediatric Clamps, 1.5 mm Jaw

DEBAKEY® PEDIATRIC AND ADULT VASCULAR CLAMPS

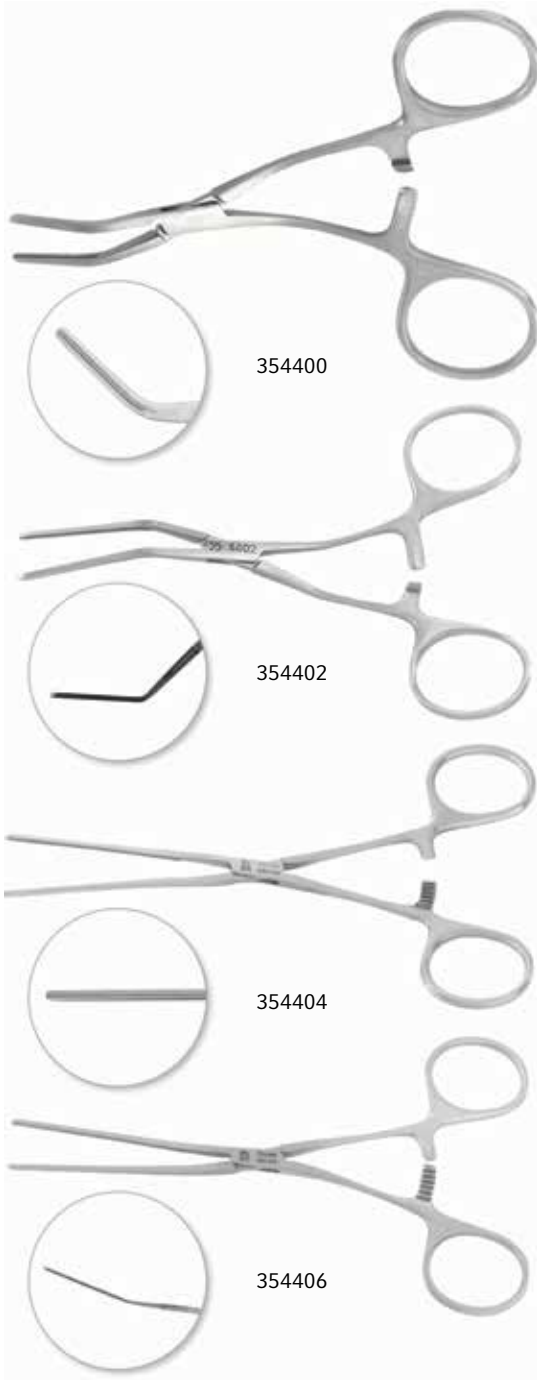

CATALOG #	DESCRIPTION
354400	Small, angled 45 degrees, 5/8" (1.5 cm) jaw, 3-7/8" (10 cm)
354402	Medium, angled 45 degrees, 4-1/8" (10.5 cm)
354404	Large, straight, 5-1/2" (14 cm)
354406	Angled 15 degrees, 5-1/4" (13.5 cm)



VASCULAR CLAMPS

Pediatric Clamps, 1.5 mm Jaw

DEBAKEY® PEDIATRIC AND ADULT VASCULAR CLAMPS

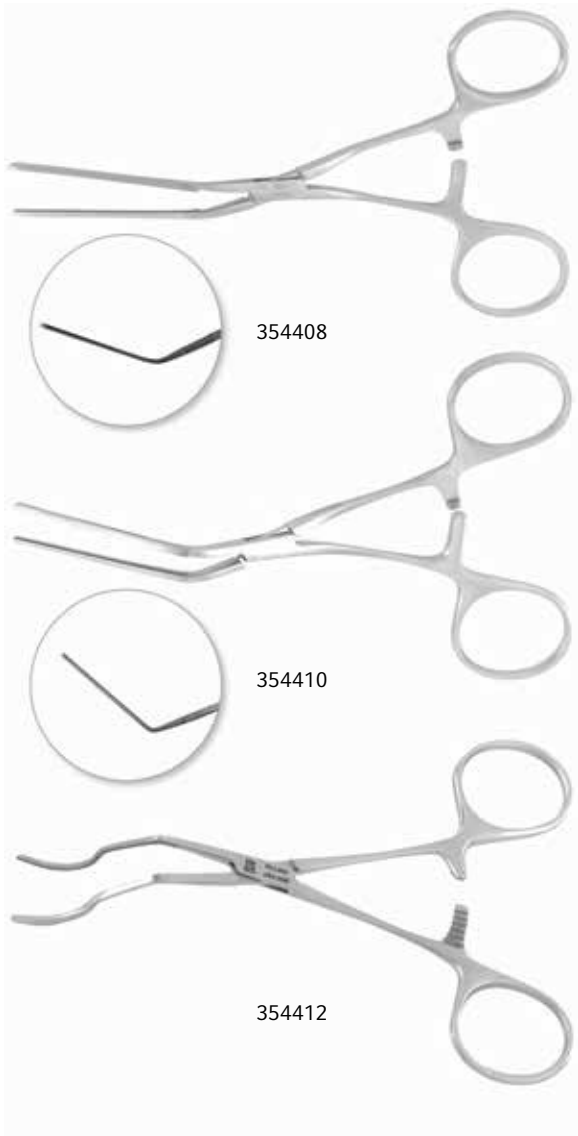

CATALOG #	DESCRIPTION
354408	Angled 45 degrees, 1-3/8" (3.5 cm) jaw, 4-7/8" (12.5 cm)
354410	Angled 60 degrees, 1-5/8" (4 cm) jaw, 4-3/8" (11 cm)
354412	Angled 90 degrees, 1-7/8" (4.8 cm) tip length, 3-3/4" (9.5 cm)

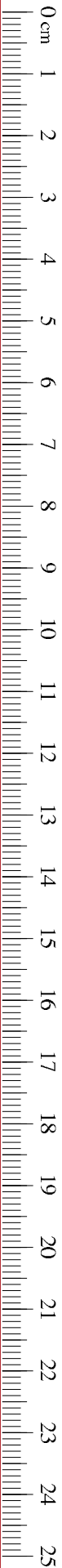

VASCULAR CLAMPS

Pediatric Clamps, 1.5 mm Jaw

DEBAKEY® PATENT DUCTUS CLAMPS

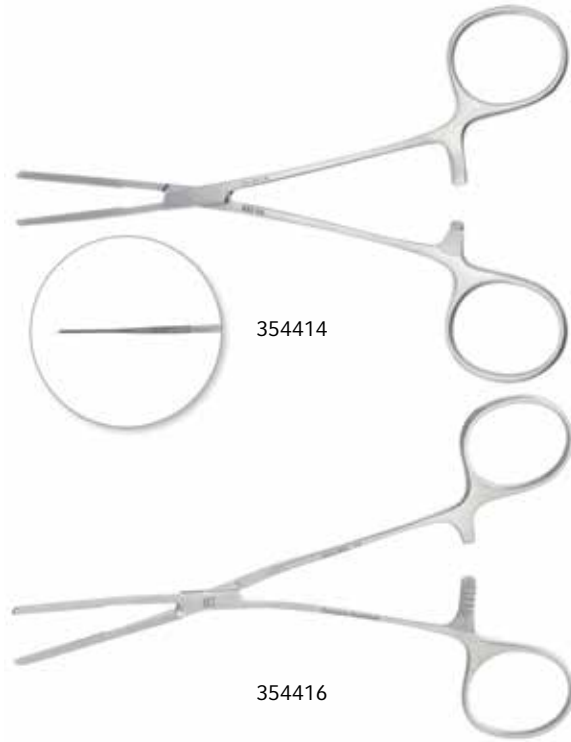

CATALOG #	DESCRIPTION
354414	Straight, 1.7 mm tip width, 6" (15 cm)
354416	Angled 20 degrees, 1.7 mm tip width, 6" (15 cm)

DEBAKEY® PEDIATRIC AND ADULT VASCULAR CLAMPS

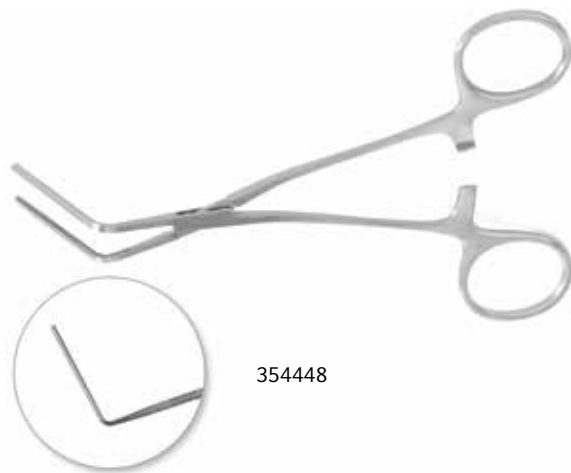

CATALOG #	DESCRIPTION
354448	Large, angled 90 degrees, 5-1/4" (13 cm)



VASCULAR CLAMPS

Pediatric Clamps, 1.5 mm Jaw

DEBORAH-CASTANEDA PARTIAL OCCLUSION CLAMPS

Jaw blades calibrated at 5 mm intervals.

CATALOG #	DESCRIPTION
354456	Small, 25 mm jaw, 4-1/2" (11.5 cm)
354458	Medium, 18 mm jaw, 5-5/8" (14 cm)
354460	Large, 21 mm jaw, 5-3/4" (14.5 cm)
354462	Extra-large, 26 mm jaw, 5-7/8" (15 cm)





VASCULAR CLAMPS

Pediatric Clamps, 1.5 mm Jaw

DEBORAH-CASTANEDA PERIPHERAL VASCULAR CLAMPS

Jaw blades calibrated at 5 mm intervals.

CATALOG #	DESCRIPTION
354450	Angled 30 degrees, 30 mm jaw, 4-3/4" (12 cm)
354452	Angled 50 degrees, 30 mm jaw, 4-5/8" (11.5 cm)
354454	Angled 90 degrees, 30 mm jaw, 3-3/4" (9.5 cm)

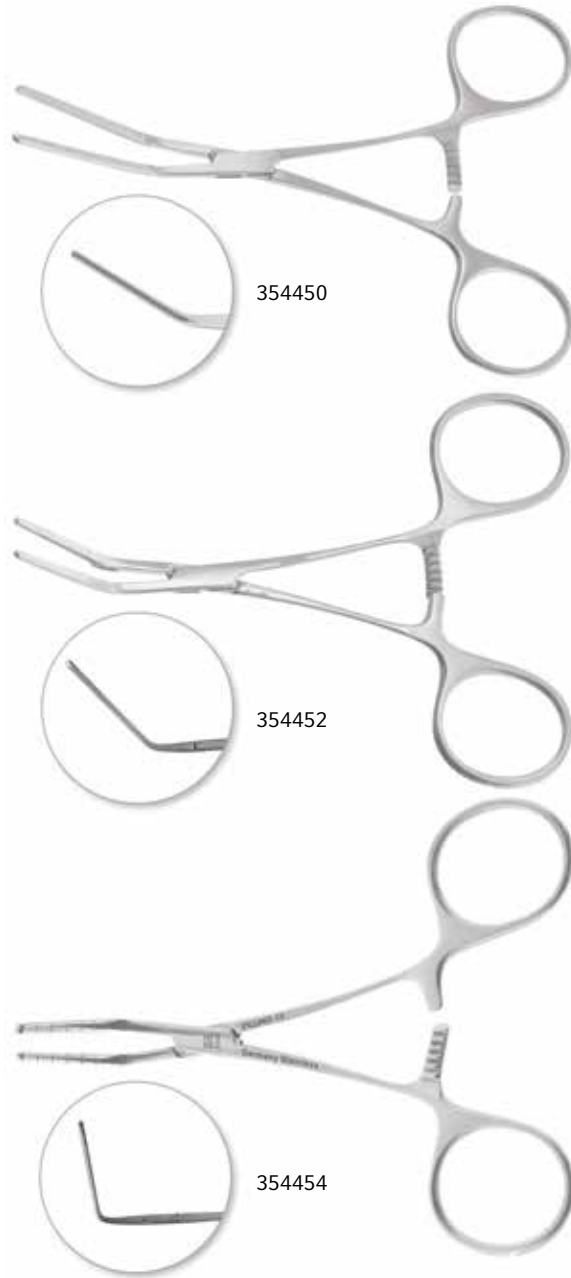



VASCULAR CLAMPS

Pediatric Clamps, 1.5 mm Jaw

DERRA PARTIAL OCCLUSION CLAMPS

CATALOG #	DESCRIPTION
354464	Short, small, 10 mm jaw, 4-3/8" (11 cm)
354466	Short, medium, 16 mm jaw, 4-3/8" (11 cm)
354468	Short, large, 28 mm jaw, 4-5/8" (11.5 cm)
354470	Small, curved handle, 17 mm jaw, 4-3/8" (11 cm)
354472	Medium, curved handle, 22 mm jaw, 4-3/4" (12 cm)

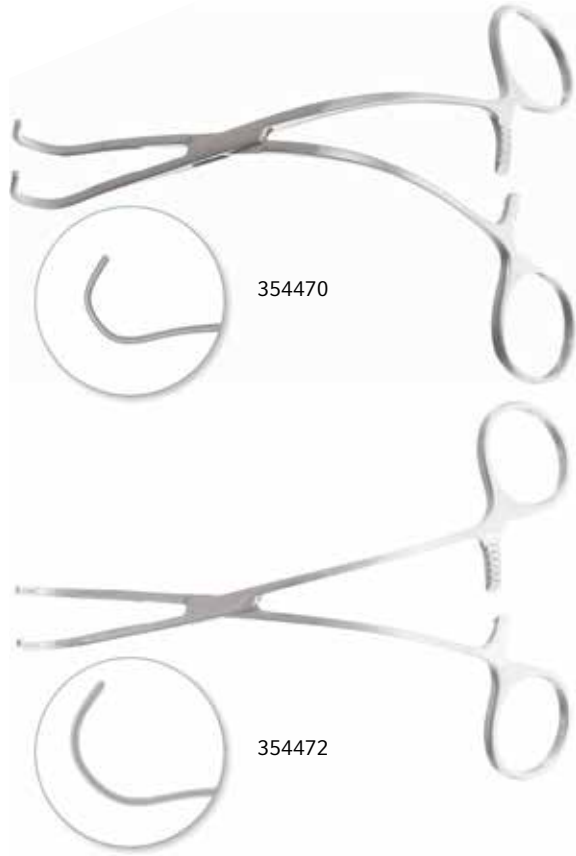

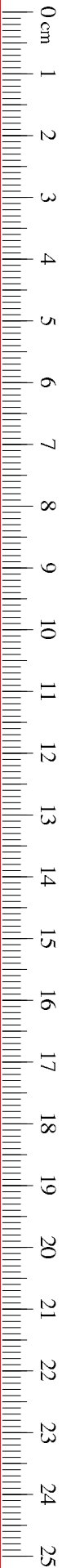

VASCULAR CLAMPS

Pediatric Clamps, 1.5 mm Jaw

DERRA PARTIAL OCCLUSION CLAMPS

CATALOG #	DESCRIPTION
354474	Large, curved handle, 25 mm jaw, 4-1/2" (11.5 cm)
354476	Deep, small, curved handle, 17 mm jaw, 5-5/8" (14 cm)
354482	Deep, small, extra-long, 18 mm jaw, 7" (18 cm)
354484	Deep, medium, extra-long, 22 mm jaw, 7" (18 cm)
354486	Deep, large, extra-long, 25 mm jaw, 7-1/4" (18.5 cm)

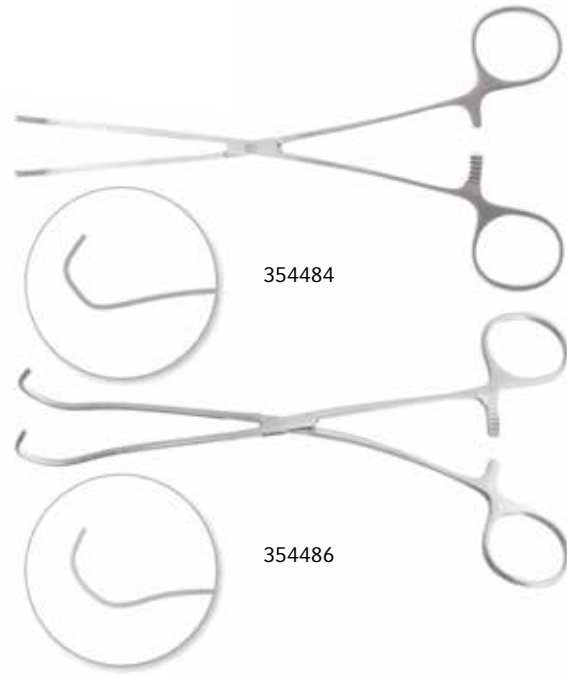
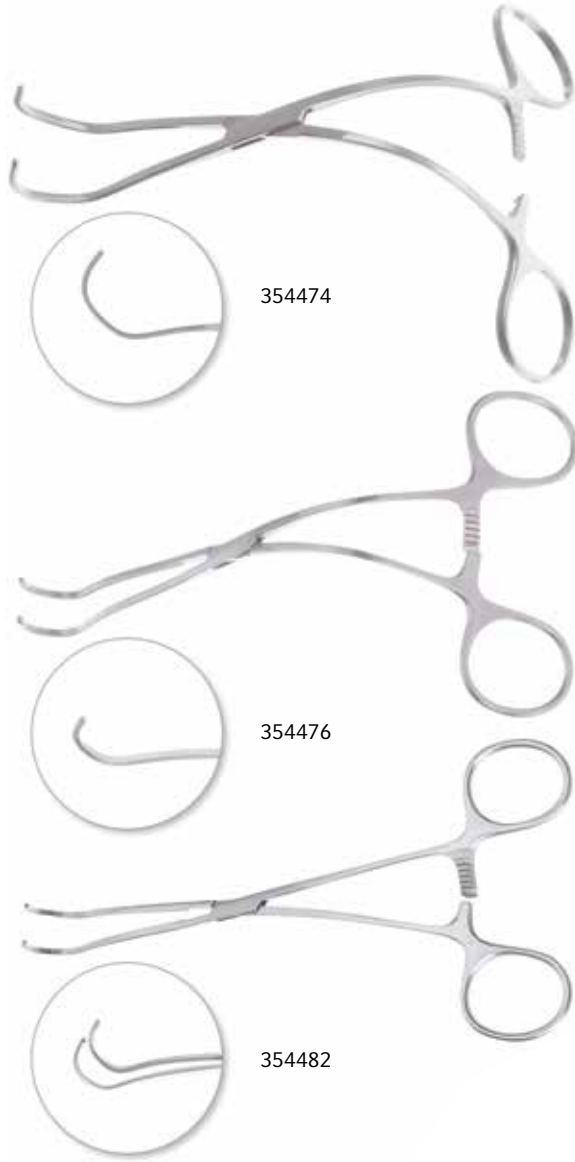



VASCULAR CLAMPS

Pediatric Clamps, 1.5 mm Jaw

REPLOGIE PEDIATRIC AORTA CROSS CLAMP

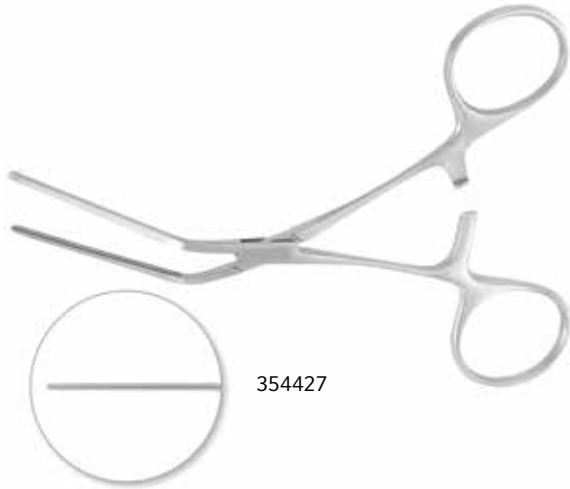

CATALOG #	DESCRIPTION
354427	Angled 60 degrees, 48 mm jaw, 4-5/8" (12 cm)

Pediatric Clamps, 2 mm Jaw

BECK MINIATURE PEDIATRIC AORTIC CLAMP



CATALOG #	DESCRIPTION
354750	Jaw length (A) 1" (2.5 cm), (A) depth 1/4" (5 cm), overall length 7" (18 cm)

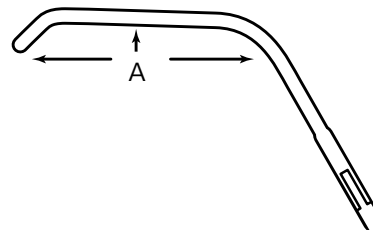

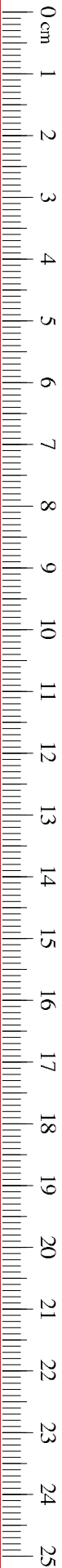

VASCULAR CLAMPS

Pediatric Clamps, 2 mm Jaw

BECK-TYPE VESSEL CLAMPS

Small, acutely curved DeBakey®-type Jaws.

CATALOG #	DESCRIPTION
354190	Small, 21 mm jaw, 6" (15 cm)
354191	Large, 32 mm jaw, 6-1/2" (16.5 cm)

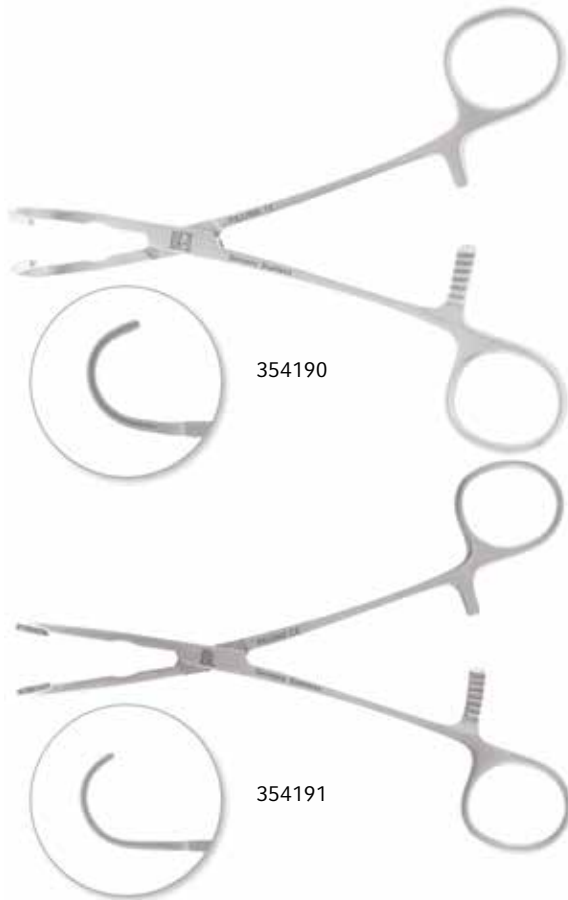

354190

354191



VASCULAR CLAMPS

Pediatric Clamps, 2 mm Jaw

DEBAKEY® ACUTELY CURVED CLAMPS

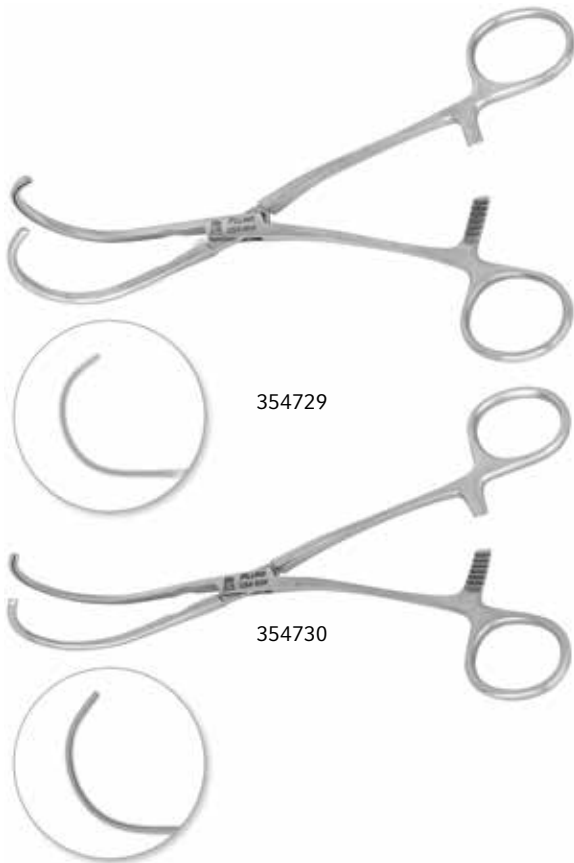

Jaws curve on 1-3/4" (4.5 cm) radius, entire length of jaws contain DeBakey®-type Serrations.

CATALOG #	DESCRIPTION
354729	6-3/4" (17 cm)
354730	Jaws are larger than 354729 Length (B) 2-3/4"(7 cm) Length (A) 1-3/4" (4.5 cm) Depth (A) 3/4" (2 cm) Overall length 6-7/8" (17.5 cm)

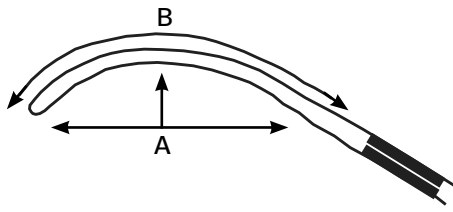

DEBAKEY® MINIATURE ANASTOMOSIS CLAMP

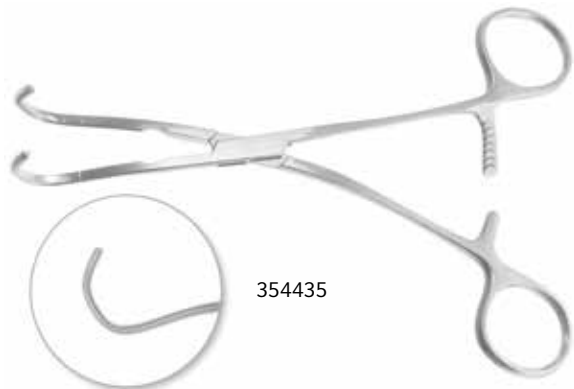

CATALOG #	DESCRIPTION
354435	Small jaw, 6-1/2" (16.5 cm)



VASCULAR CLAMPS

Pediatric Clamps, 2 mm Jaw

DEBAKEY® PEDIATRIC MULTIPURPOSE CLAMPS

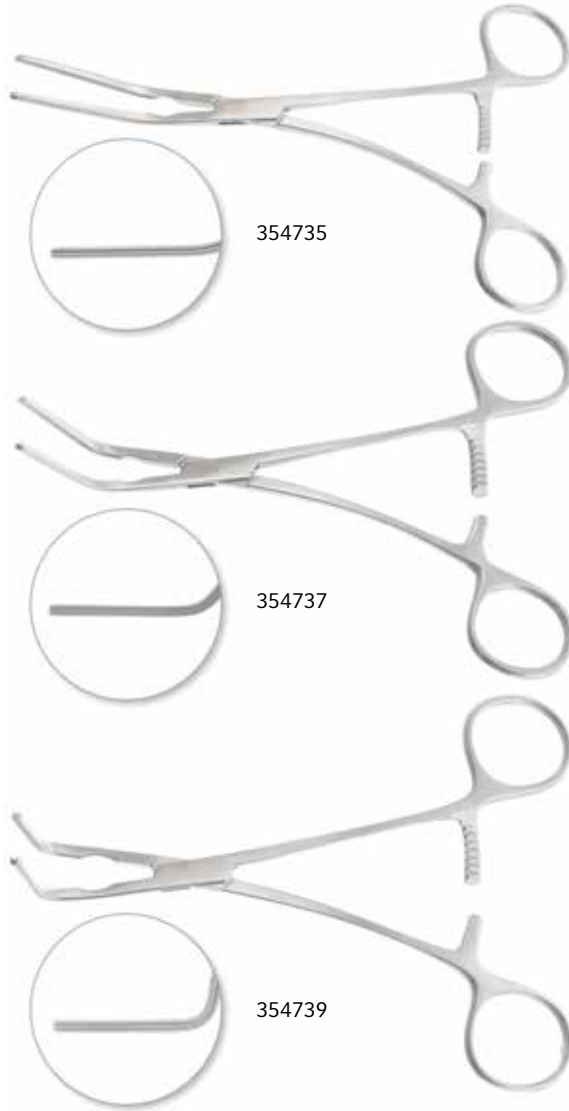

DeBaKEY®-type Jaw, spring handle, 1 x 7 ratchets.

CATALOG #	DESCRIPTION
354735	Angled 30 degrees, jaw 3/4" (19 mm) long past angle, 6-3/4" (17 cm)
354737	Angled 60 degrees, jaw 1-1/4" (32 mm) long past angle, 6-1/4" (16 cm)
354739	Angled 90 degrees, jaw 1-1/2" (37 mm) long past angle, 6" (15 cm)



VASCULAR CLAMPS

Pediatric Clamps, 2 mm Jaw

GLOVER CURVED MINIATURE PEDIATRIC CLAMP

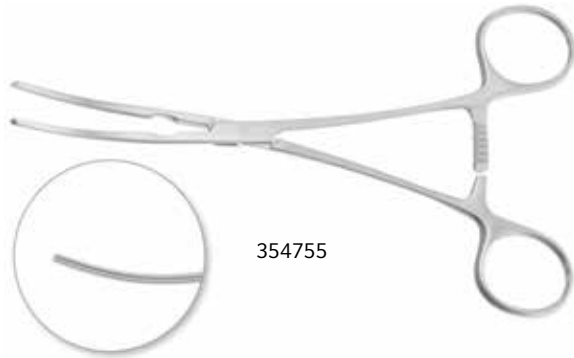

CATALOG #	DESCRIPTION
354755	Slightly curved jaws 1/2" (1.2 cm) long, 7-1/8" (18 cm)

MINIATURE SATINSKY REYNOLDS CLAMPS

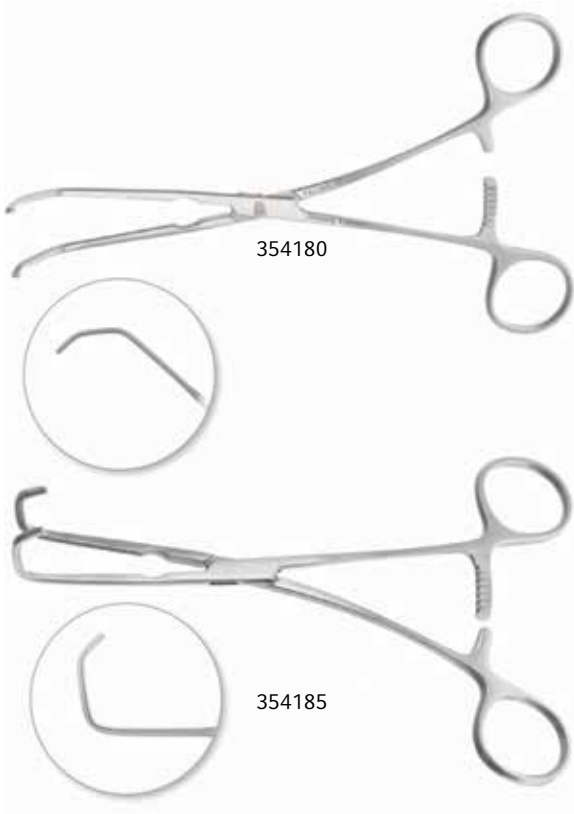

Reynolds-type clamps, baby size. These miniature models of the Satinsky Clamp have DeBakey®-type Jaws and are made in two jaw angles.

CATALOG #	DESCRIPTION
354180	Angled 50 degrees, small jaw, (A) length 1" (2.5 cm), (A) depth 1/4" (6 mm), 7-1/4" (18.5 cm)
354185	Angled 85 degrees, small jaw, (A) length 1-1/4" (3 cm), (A) depth 1/4" (6 mm), 6-3/4" (17 cm)

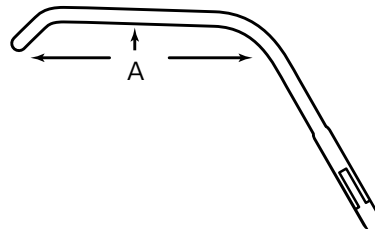



VASCULAR CLAMPS

Pediatric Clamps, 2 mm Jaw

PILLING® MINIATURE PEDIATRIC CLAMPS

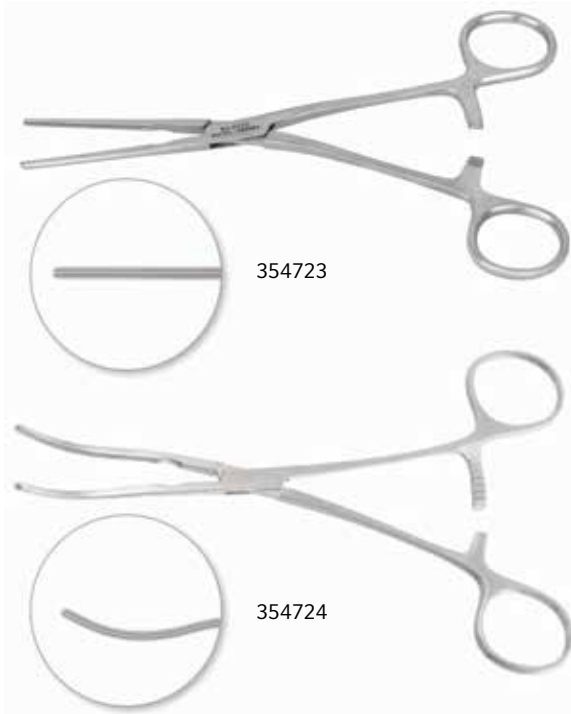

Pilling® Miniatures are all the same general size (approximately 4-1/4" (11 cm) to center of box lock) and weight. They are considerably lighter than "standard adult" instruments of the same model. The jaws are approximately 2 mm wide with medium size DeBakey®-type Serration.

CATALOG #	DESCRIPTION
354720	Patent Ductus, straight, 2" (5 cm) jaws, 6-3/4" (17 cm)
354721	Patent Ductus, straight, 1-7/8" (4.5 cm) jaws, 6-3/8" (16 cm)
354722	Coarctation, straight, 2-1/2" (6 cm) jaws, 7-1/8" (18 cm)
354723	Coarctation, angled, 2-3/8" (6 cm) jaws, 7" (17.5 cm)
354724	Spoon shape, 1-3/4" (4.5 cm) jaws, 7-1/8" (18 cm)

VASCULAR CLAMPS

Pediatric Clamps, Cooley-Type Jaw

COOLEY CLAMPS FOR PEDIATRIC CARDIOVASCULAR SURGERY

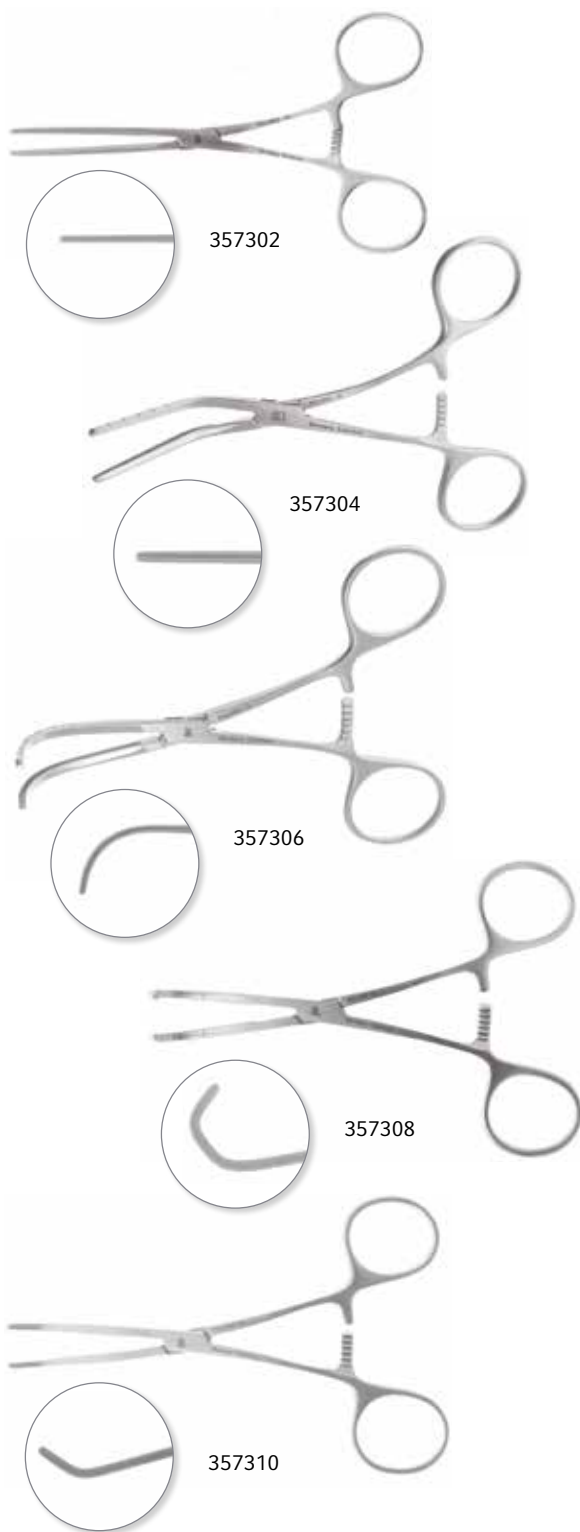

These clamps are designed especially for surgery in infants and small children. They have specially set ratchets to permit gradual application and release of the clamps.

Cooley-type Jaws. A double row of fine atraumatic teeth are arranged in opposing rows to grasp the vessel. The teardrop shape of the jaws allows for maximum length of divided vessel for suturing (as patent ductus arteriosus).

Calibrations. Jaws are engraved at 5 mm intervals to facilitate accurate measurements. The calibration is on the outer sides of the jaws on cross clamps and on the anterior surface of partial occlusion clamps.

The Cooley Clamps are all of the same general size and weight. Tension is carefully calculated to be in proportion to jaw length, shape and intended use. Length is approximately 4-1/4" (10.8 cm) to center of box-lock. Constructed of dull, non-glare finished stainless steel. Shafts or arms of Cooley Clamps are of three different shapes — straight, angled or curved as shown in diagram.

Jaw shapes are varied as shown, and are calibrated starting from distal tip toward box-lock or from center point of jaw, proceeding in both directions.

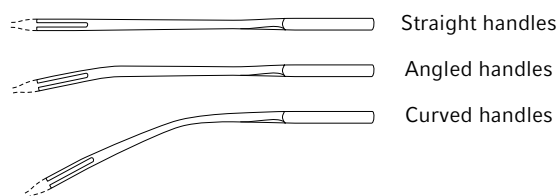

Spring handle, 1 x 6 ratchets.

CATALOG #	DESCRIPTION
357302	Straight jaw, angled shanks, 5-1/8" (13 cm)
357304	Angled jaw, curved shanks, 5" (12.5 cm)
357306	Curved 3/4" (19 mm) jaw, straight shanks, 4-5/8" (11.5 cm)
357308	Partial occlusion jaw, curved shanks, 4-5/8" (11.5 cm)
357310	Carotid jaw, curved shanks, 4-3/4" (12 cm)

VASCULAR CLAMPS

Pediatric Clamps, Cooley-Type Jaw

BECK-TYPE VESSEL CLAMP

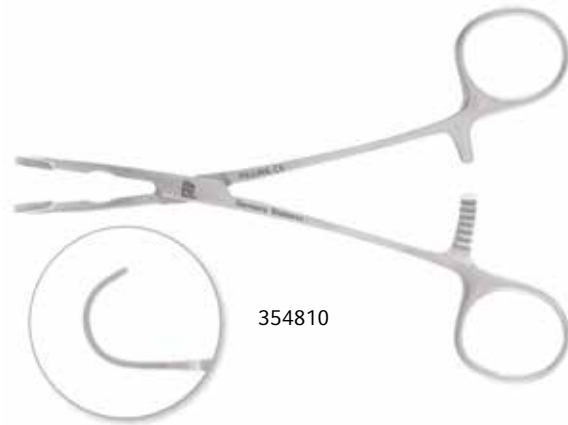

354810

Small, acutely curved jaws calibrated on anterior surface from center point outward.

CATALOG #	DESCRIPTION
354810	Straight handles, 1" (2.5 cm) jaw, 6-1/8" (15.5 cm)

COOLEY ANASTOMOSIS CLAMPS



354125

Jaws are calibrated on the anterior surface from center point outward. This miniature vascular clamp is designed for partial occlusion of a major vessel (aorta, inferior vena cava, carotid artery, etc.) where total occlusion may be undesirable. Calibrations at 5 mm intervals on the jaws are useful in aortico-pulmonary anastomosis in infants and children with tricuspid atresia or Tetralogy of Fallot. Lightweight, calibrated jaws 3/4" (2 cm) with Cooley serration.

CATALOG #	DESCRIPTION
354125	Spring handle, 1 x 7 ratchets, 7-1/8" (18 cm)
354845	1.5 mm extra-fine DeBakey®-type Jaws, spring handle, 1 x 7 ratchets, 7-1/8" (18 cm)

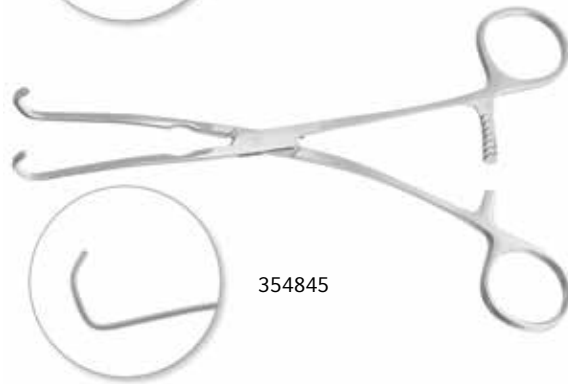

354845



VASCULAR CLAMPS

Pediatric Clamps, Cooley-Type Jaw

COOLEY CLAMPS

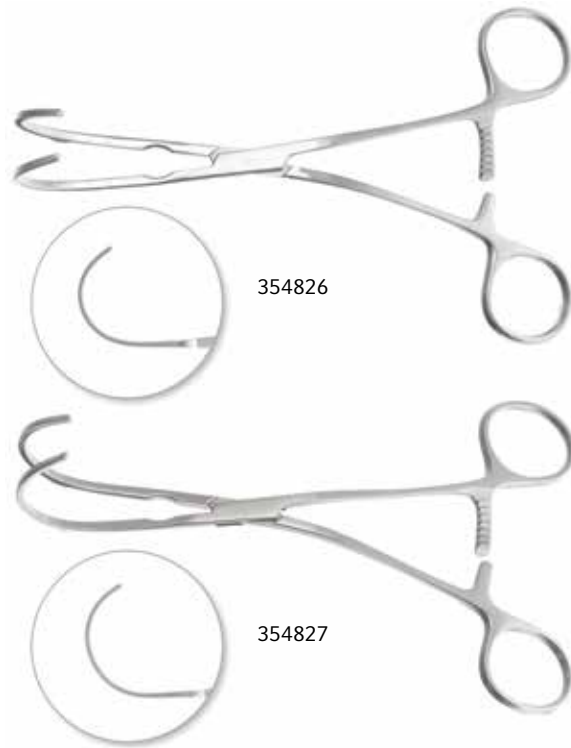

Acutely curved clamps. Jaws calibrated on anterior surface from center point outward. Angled shafts.

CATALOG #	DESCRIPTION
354826	Medium clamp, full length Cooley jaw serrations, 1-1/2" (3.8 cm), 6-5/8" (17 cm)
354827	Large clamp, full length Cooley jaw serrations, 1-3/4" (4.5 cm), 6-3/4" (17 cm)

COOLEY CLAMPS FOR PEDIATRIC AND INFANT CARDIOVASCULAR SURGERY



Double angle jaws calibrated on anterior surface from center point outward. Angled shafts.

CATALOG #	DESCRIPTION
354830	Angled 90 degrees, small jaws, 6-3/4" (17 cm)

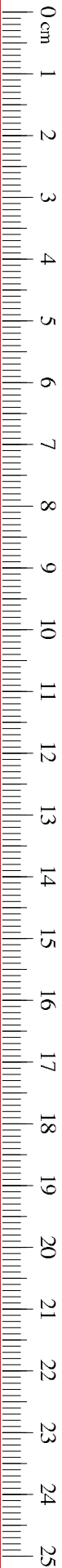

VASCULAR CLAMPS

Pediatric Clamps, Cooley-Type Jaw

COOLEY PEDIATRIC CARDIOVASCULAR CLAMPS

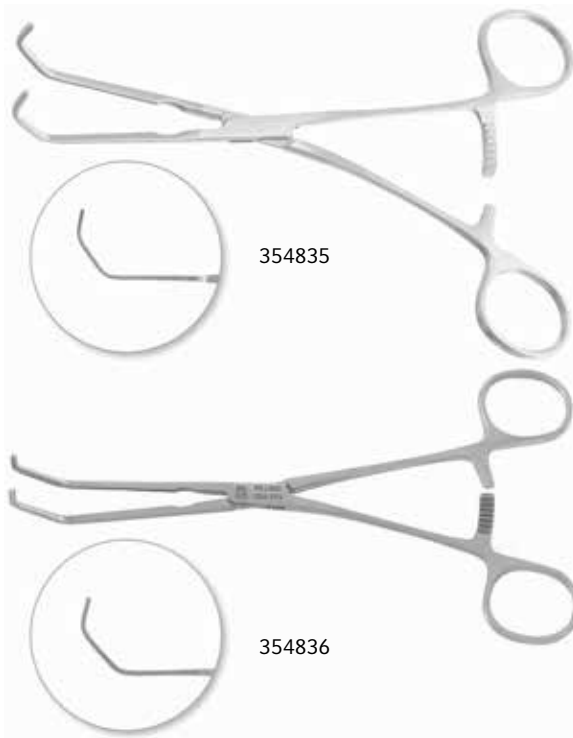

CATALOG #	DESCRIPTION
354835	Angled shafts, small, double angled 60 degree calibrated jaw, 7-1/8" (18 cm)
354836	Angled shafts, large, double angled 60 degree calibrated jaw, 7-1/8" (18 cm)



VASCULAR CLAMPS

Pediatric Clamps, Cooley-Type Jaw

COOLEY PEDIATRIC DERRA CLAMPS

Slightly curved shaft, spring handle, 1 x 7 ratchets.

CATALOG #	DESCRIPTION
354815	Small, calibrated 3/4" (2 cm) jaw, 7" (18 cm)
354816	Medium, calibrated 1-1/8" (3 cm) jaw, 7" (18 cm)
354817	Large, calibrated 1-1/8" (3 cm) jaw, 7-1/8" (18 cm)

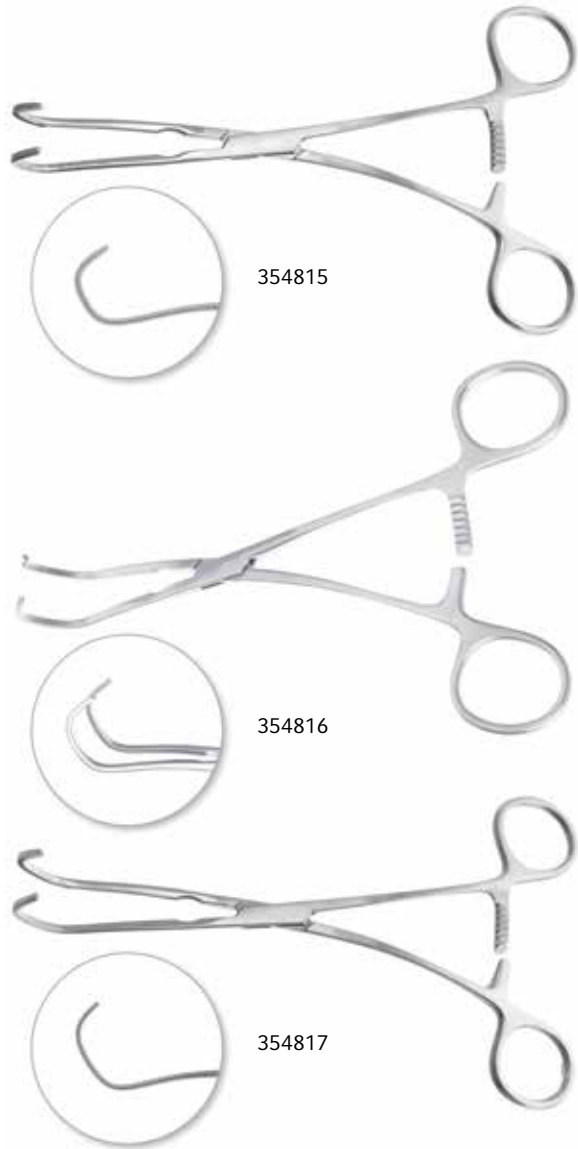

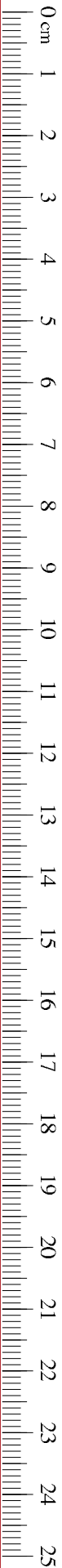

VASCULAR CLAMPS

Pediatric Clamps, Cooley-Type Jaw

COOLEY PEDIATRIC MODIFIED ANASTOMOSIS CLAMP

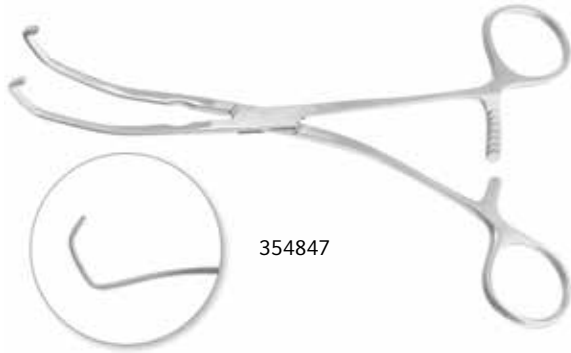

354847

CATALOG #	DESCRIPTION
354847	30 degree side angle, calibrated 5/8" (1.5 cm) jaw, spring handle, 1 x 7 ratchets, 7-1/8" (18 cm)

COOLEY PEDIATRIC MULTIPURPOSE CLAMPS

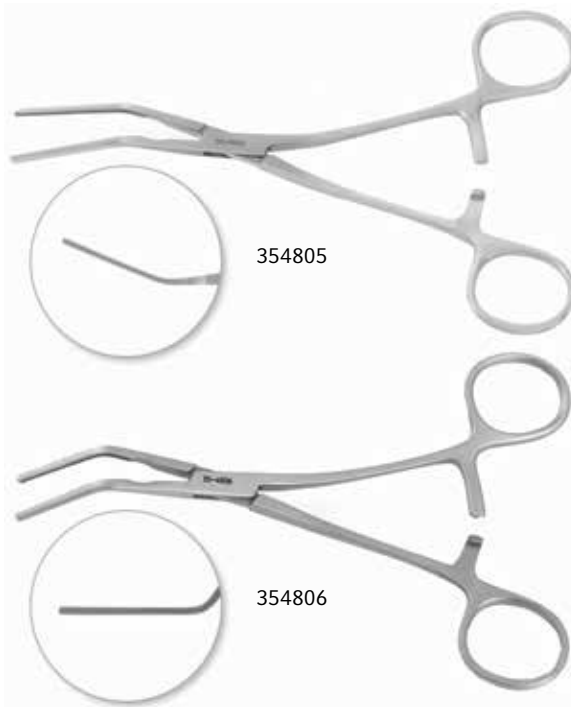

354805

354806

Long, angled shanks, spring handle, 1 x 7 ratchets.

CATALOG #	DESCRIPTION
354805	30 degree angled, calibrated 3/4" (2 cm) jaw, 6-3/4" (17 cm)
354806	60 degree angled, calibrated 1-1/4" (3.5 cm) jaw, 6-1/2" (16.5 cm)
354807	90 degree angled, calibrated 1-1/2" (4 cm) jaw, 5-3/4" (14.5 cm)



VASCULAR CLAMPS

Pediatric Clamps, Cooley-Type Jaw

COOLEY PEDIATRIC PATENT DUCTUS CLAMPS

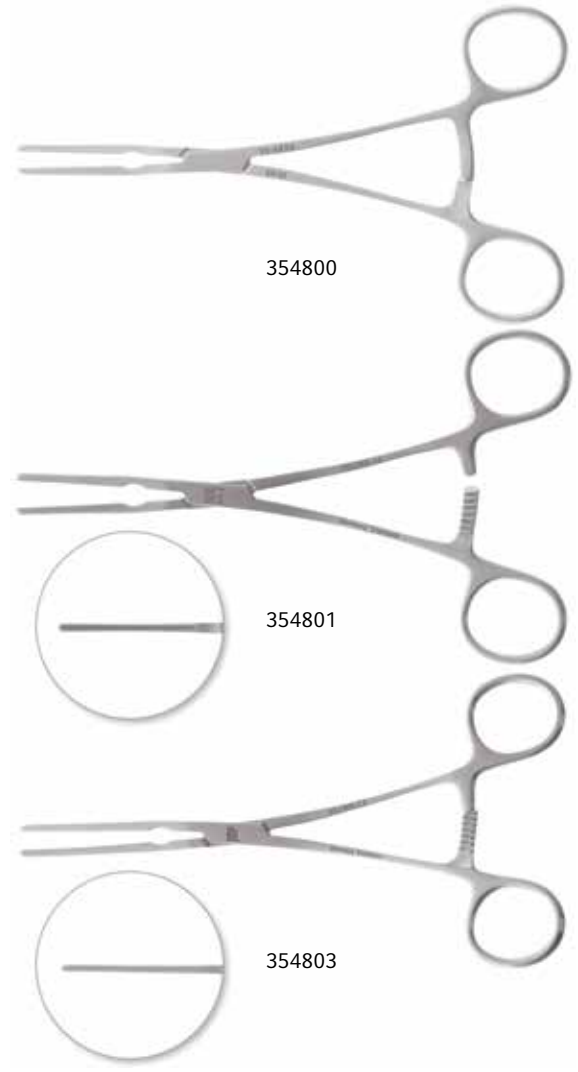

Spring handle, 1 x 7 ratchets.

CATALOG #	DESCRIPTION
354800	Straight, calibrated jaw, straight shanks, 6-3/4" (17 cm)
354801	Straight, calibrated jaw, angled shanks, 6-1/2" (16.5 cm)
354802	Straight, calibrated jaw, straight shanks, 7" (18 cm)
354803	Straight, calibrated jaw, angled shanks, 7" (18 cm)
354804	Curved, calibrated jaw, straight shanks, 7-1/4" (18.5 cm)

COOLEY PEDIATRIC PATENT DUCTUS CLAMPS



CATALOG #	DESCRIPTION
354808	Spoon-shaped, 5 mm calibrated jaws, straight handles, 7-1/8" (18 cm)



VASCULAR CLAMPS

Ring Handled Bulldog® Clamps

DEBAKEY® RING HANDLE BULLDOG® CLAMPS

These short, sturdy clamps are intended for use in place of the longer sizes of "squeeze handle" bulldogs. They measure only 2-3/4" (7 cm) from the center point of the box lock to the end of the ring handles, averaging approximately 4-3/4" (12 cm) to 5-1/8" (13 cm) overall length depending on shape. Narrow DeBakey®-type Jaws and spring handles provide firm, non-traumatizing grip.

CATALOG #	DESCRIPTION
353182	Straight, 2-1/4" (5.5 cm) jaw, 5-3/8" (13.5 cm)
353186	Curved, 2-3/8" (6 cm) jaw, 5-3/8" (13.5 cm)
353189	Angled 45 degrees, jaws 1-3/16" (3 cm) past angle, curved shafts, 5-3/8" (13.5 cm)
353192	Angled 90 degrees, jaws 1-3/4" (4.5 cm) past angle, straight shafts, 4-1/8" (10.5 cm)
353195	"S"-shaped, curved, 2-1/2" (6.5 cm) jaws, long and curved shafts, 5-1/8" (13 cm)

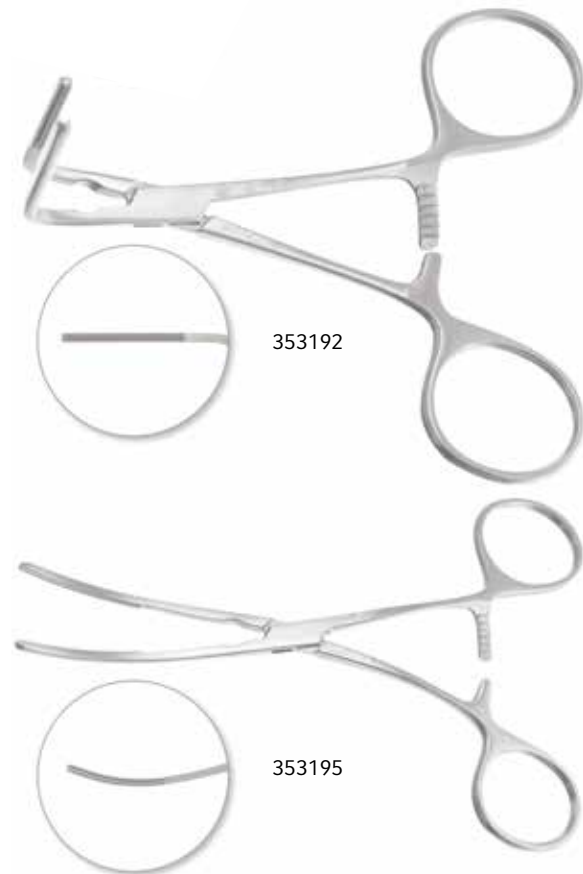
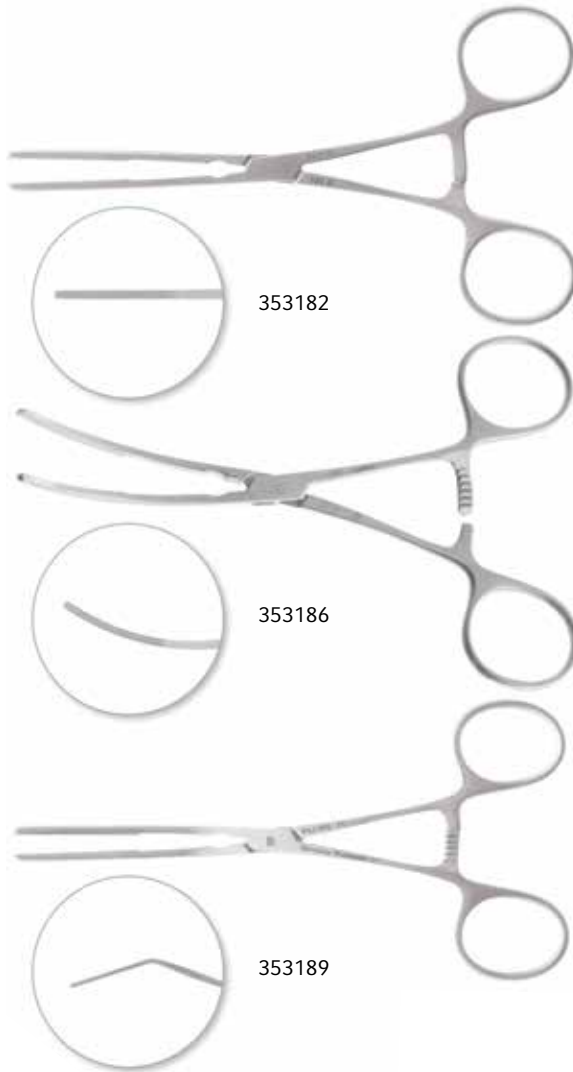



VASCULAR CLAMPS

Ring Handled Bulldog® Clamps

GREGORY MINIATURE VASCULAR CLAMPS

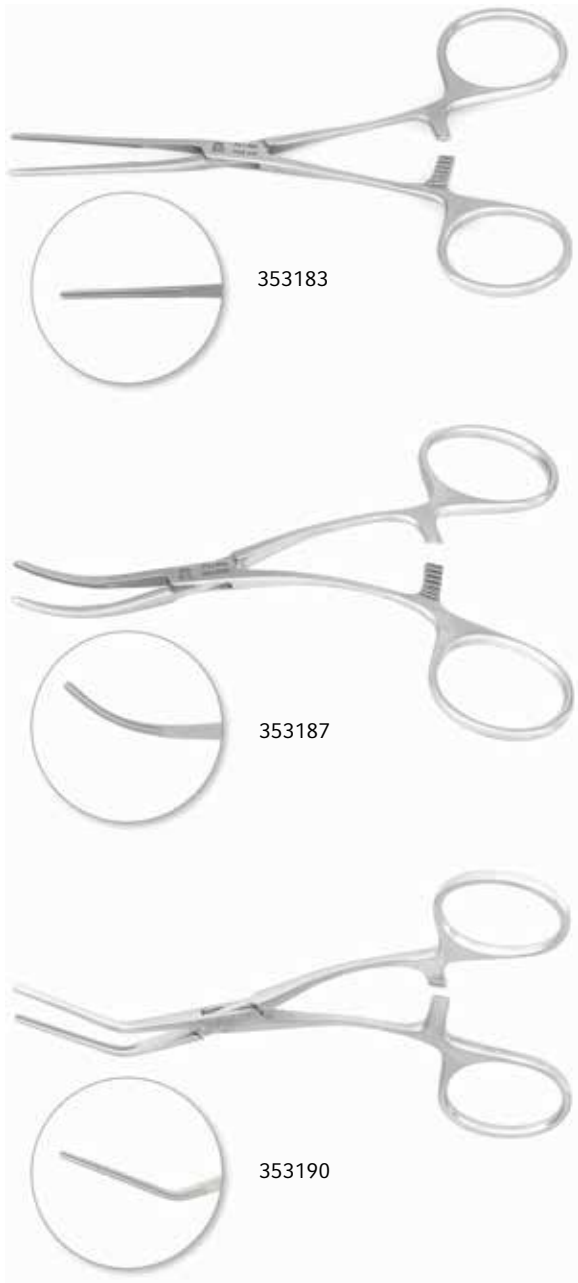

Very delicate, small vessel occlusion clamps, with DeBakey®-type Jaws 1.5 mm wide and LIFE-LOK® Box-Lock.

CATALOG #	DESCRIPTION
353183	Straight, extra-light, 4-3/4" (12 cm)
353187	Curved, extra-light, 4-1/8" (10.5 cm)
353190	Angled 45 degrees, extra-light, 4-3/8" (11 cm)

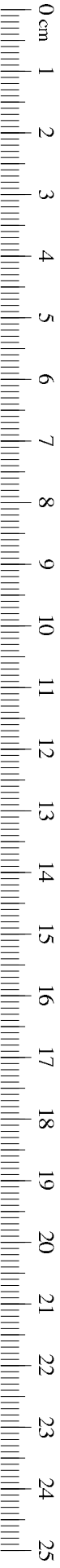

VASCULAR CLAMPS

Carotid Clamps

CALMAN CAROTID BULLDOG® CLAMPS



Ring-tipped Bulldog® Clamps designed to lay out of the way while holding the shunt in place during carotid endarterectomy. For use with Javid Shunts.

CATALOG #	DESCRIPTION
353080	Straight, with small ring, for use on the internal carotid artery superiorly holding the shunt in place, 5 mm ring, 3-1/2" (9 cm)
353085	Angled, with large ring, for use on the common carotid artery inferiorly, 8 mm ring, 3-3/4" (9.5 cm)

GREGORY INTERNAL CAROTID "SOFT" BULLDOG® CLAMP

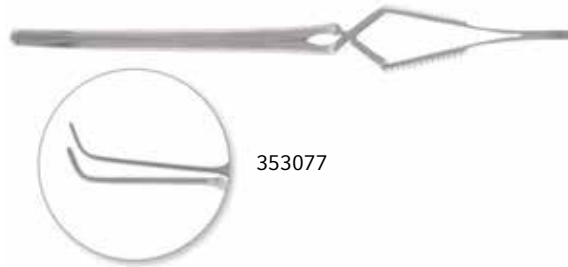

CATALOG #	DESCRIPTION
353077	5/8" (15 mm) distal tip, DeBakey®-type Jaw, 4-1/2" (11.5 cm)

GREGORY CAROTID ANGLED BULLDOG® CLAMP



CATALOG #	DESCRIPTION
353078	1/2" (12 mm) distal tip, DeBakey®-type Jaw, 4-1/2" (11.5 cm)

VASCULAR CLAMPS

Carotid Clamps

JAVID CAROTID SHUNT CLAMPS



353086

CATALOG #	DESCRIPTION
353086	Large 6.0 mm ring, 7-3/8" (18.5 cm)
353087	Small 3.5 mm ring, 6-7/8" (17.5 cm)

WYLIE CAROTID CLOSURE CLAMP

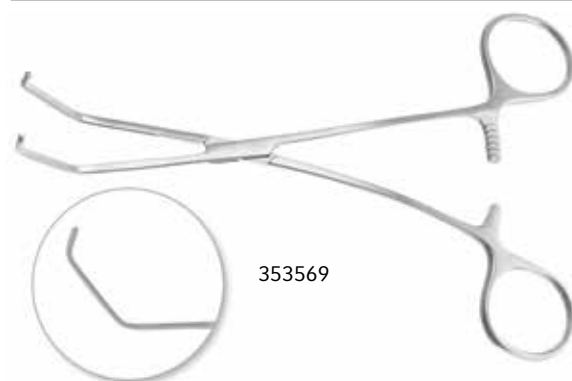

353569

CATALOG #	DESCRIPTION
353569	DeBakey®-type Jaw with 1.7 mm wide tip, 6-1/8" (15.5 cm)

WYLIE CAROTID DISSECTING CLAMP



355196

The endarterectomy dissection plane is developed just at the level of maximum disease. Once the plane has been developed to the depth of the artery, a special sharply curved clamp is used to continue the dissection to the opposite side of the arteriotomy. The Wylie Carotid Dissecting Clamp was designed for this purpose and may be preferred to a standard right angle clamp.

CATALOG #	DESCRIPTION
355196	5-7/8" (15 cm)



VASCULAR CLAMPS

Carotid Clamps

WYLIE EXTERNAL CAROTID CLAMP

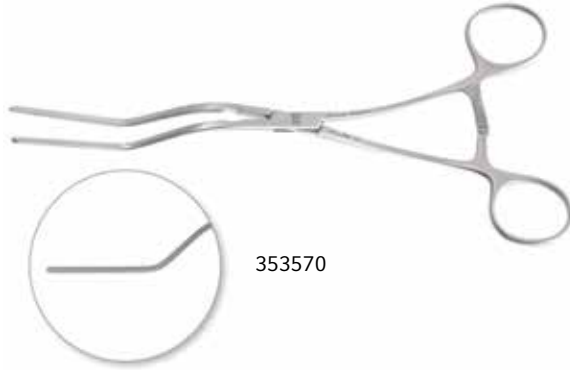

353570

CATALOG #	DESCRIPTION
353570	DeBakey®-type Jaw, spring handle, 1 x 7 ratchets, 8" (20.5 cm)

WYLIE INTERNAL CAROTID CLAMP

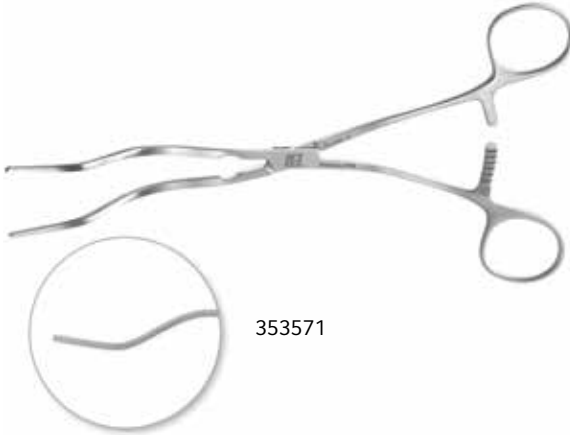

353571

CATALOG #	DESCRIPTION
353571	DeBakey®-type Jaw, spring handle, 1 x 7 ratchets, 8-1/4" (21 cm)

WYLIE HYPOGASTRIC CLAMP



353657

CATALOG #	DESCRIPTION
353657	DeBakey®-type Jaw, 9-5/8" (24.5 cm)



VASCULAR CLAMPS

Carotid Clamps

DOERING CAROTID END POINT MICRO RONGEUR FORCEPS



Spring handled rongeur forceps with a 2.5 mm cup to nip end point plaque during carotid endarterectomy.

CATALOG #	DESCRIPTION
355198	7-1/4" (18.5 cm)

Carotid Clamps, 1 mm Jaw

CALMAN CLAMP



CATALOG #	DESCRIPTION
357180	Angled handles, jaw 1" (2.5 cm) long and 1 mm thick, spring handle, 1 x 6 ratchets, 4-1/2" (11.5 cm)

EXAMPLE CLAMP



CATALOG #	DESCRIPTION
357185	Angled handles, jaw 1" (2.5 cm) long and 1 mm thick, spring handle, 1 x 6 ratchets, 5-5/8" (14 cm)

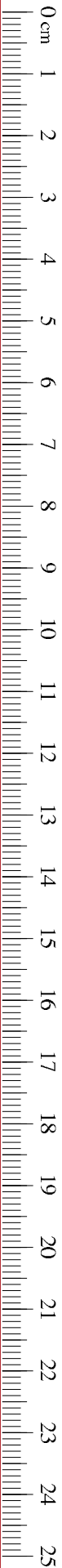

VASCULAR CLAMPS

Carotid Clamps, 1 mm Jaw

KARTCHNER INTERNAL CAROTID CLAMP



CATALOG #	DESCRIPTION
357197	Slightly curved handles, long jaw, 1 mm thick, spring handles, 1 x 6 ratchets, 6-3/8" (16.5 cm)

THOMPSON CLAMP

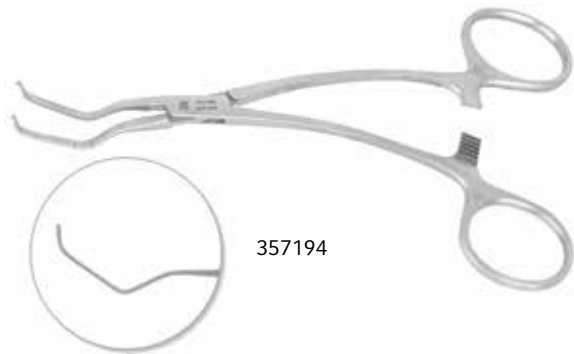

CATALOG #	DESCRIPTION
357194	Slightly curved handles, long jaw, 1 mm thick, spring handle, 1 x 6 ratchets, 6-1/8" (15.5 cm)



VASCULAR CLAMPS

Carotid Clamps, 1.5 mm Jaw

KARTCHNER INTERNAL CAROTID CLAMP

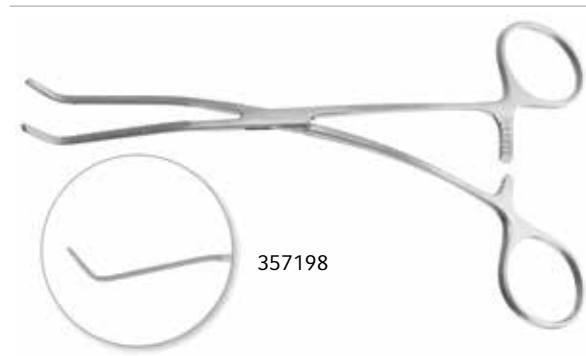

CATALOG #	DESCRIPTION
357198	Jaw length 10 mm, 6-1/4" (16 cm)

THOMPSON CAROTID CLOSURE CLAMP



CATALOG #	DESCRIPTION
357195	Jaw length 22 mm, 5-3/4" (14.5 cm)



VASCULAR CLAMPS

Renal Clamps

CLEVELAND CLINIC RENAL CLAMPS

Specifically designed to access renal arteries. Jaws angled left and right. DeBakey®-type Jaws.

CATALOG #	DESCRIPTION
353531	Left large, 9-5/8" (24.5 cm)
353532	Right large, 9-5/8" (24.5 cm)
353533	Left baby renal clamp, extra-fine, 1.7 mm jaws, 6-1/2" (16.5 cm)
353534	Right baby renal clamp, extra-fine, 1.7 mm jaws, 6-1/2" (16.5 cm)

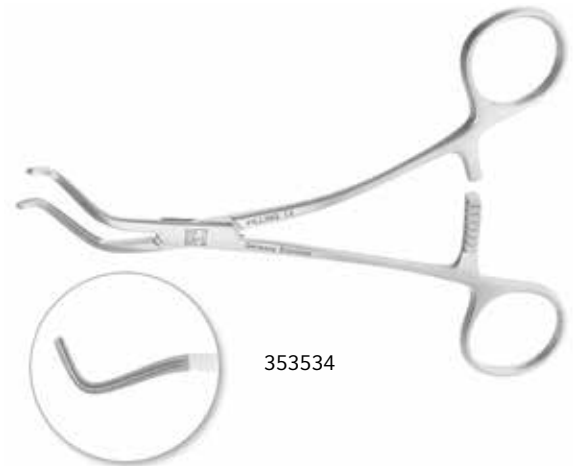
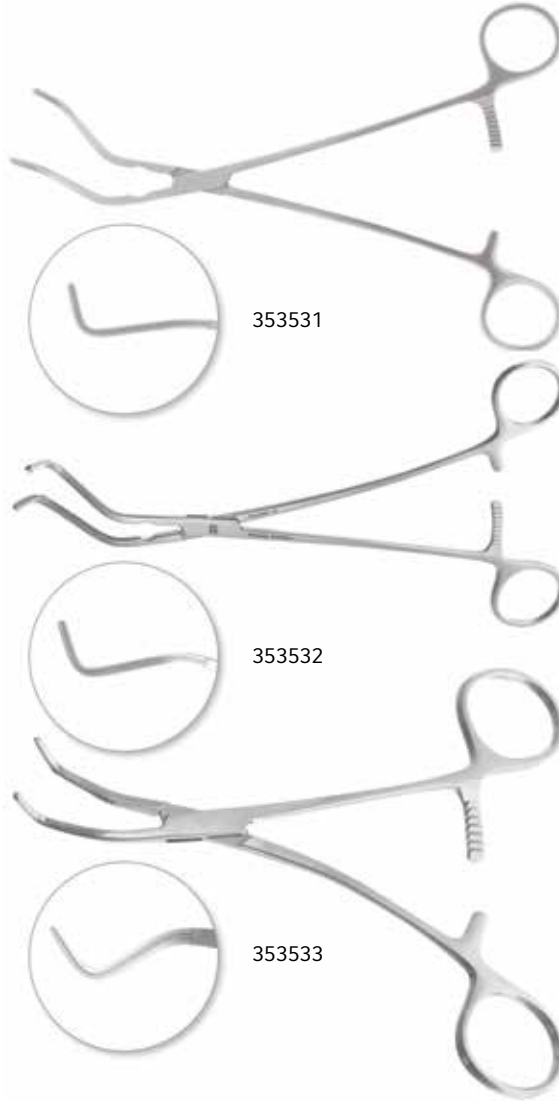



VASCULAR CLAMPS

Renal Clamps

DEBAKEY® RENAL ARTERY CLAMP



CATALOG #	DESCRIPTION
353515	DeBakey®-type Jaw, long, curved spring handle, 1 x 9 ratchets, 10-1/8" (25.5 cm)

STONEY SPLENO-RENAL SHUNT CLAMP



CATALOG #	DESCRIPTION
353524	Long, extra-fine DeBakey®-type Jaw, spring handle, 1 x 9 ratchets, 9-1/4" (23.5 cm)

WIRTHLIN SPLENO-RENAL SHUNT CLAMP



CATALOG #	DESCRIPTION
353522	Long, DeBakey®-type Jaw, spring handle, 1 x 6 ratchets, 6-1/2" (16.5 cm)



VASCULAR CLAMPS

Femoral-Popliteal Clamps

DALE FEMORAL-POPLITEAL ANASTOMOSIS CLAMP



353528

CATALOG #	DESCRIPTION
353528	DeBakey®-type Jaw, spring handle, 1 x 7 ratchets, 7-3/8" (19 cm)

DALE FEMORAL-POPLITEAL CLAMPS

Spring handle, 1 x 7 ratchets.

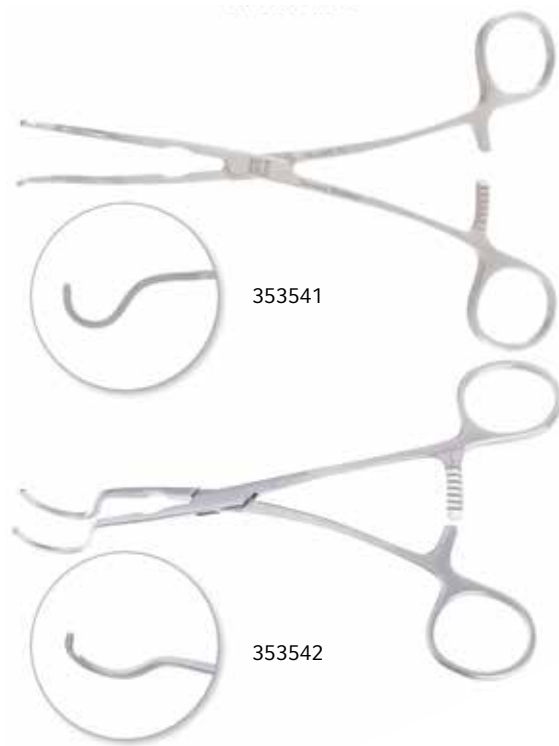

353541

353542

CATALOG #	DESCRIPTION
353541	Small, 7" (17.5 cm)
353542	Medium, 7-1/8" (18 cm)
353543	Large, 7-1/4" (18.5 cm)

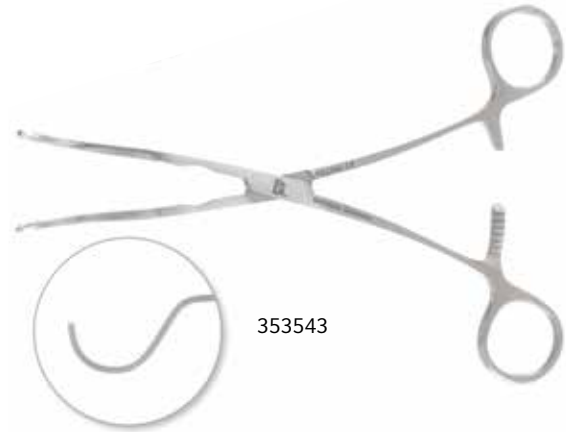

353543



VASCULAR CLAMPS

Femoral-Popliteal Clamps

DEMOS TIBIAL ARTERY CLAMP



Specially angled in the plane of the handle, this clamp reduces the tendency to twist or distort a vessel in procedures requiring distal popliteal or tibial occlusion.

CATALOG #	DESCRIPTION
353568	Straight, DeBakey®-type Jaw, 2-3/8" (6 cm) tip length, 2.1 mm tip width, angled shaft, 6-3/4" (17 cm)

Peripheral Vascular Clamps

DEBAKEY® "S" SHAPED PERIPHERAL VASCULAR CLAMP

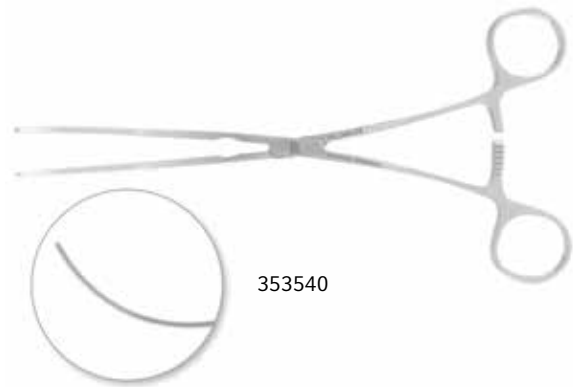

CATALOG #	DESCRIPTION
353540	Spring handles, 1 x 7 ratchets, 7-7/8" (20 cm)



VASCULAR CLAMPS

Peripheral Vascular Clamps

DEBAKEY® ANGLED PERIPHERAL VASCULAR CLAMP



353535

CATALOG #	DESCRIPTION
353535	Long, angled DeBakey®-type Jaw, spring handles, 1 x 7 ratchets, 7-1/8" (18 cm)

DEBAKEY® AORTIC EXCLUSION CLAMP



353545

Very light construction. Jaws and shafts curved to form an acute "S" shape. Spring handles.

CATALOG #	DESCRIPTION
353545	DeBakey®-type Curved Jaws, 7-1/8" (18 cm)

VASCULAR CLAMPS

Peripheral Vascular Clamps

DEBAKEY® BAINBRIDGE VASCULAR CLAMPS

Light, delicate construction throughout with narrow, DeBakey®-type Jaws. Very useful as peripheral vascular clamps.

CATALOG #	DESCRIPTION
353560	Straight, 4 cm jaws, overall length 7" (18 cm)
353562	Straight, 6 cm jaws, overall length 7-7/8" (20 cm)
353565	Curved, 4 cm jaws, overall length 7" (18 cm)
353567	Curved, 6 cm jaws, overall length 7-3/4" (19.5 cm)

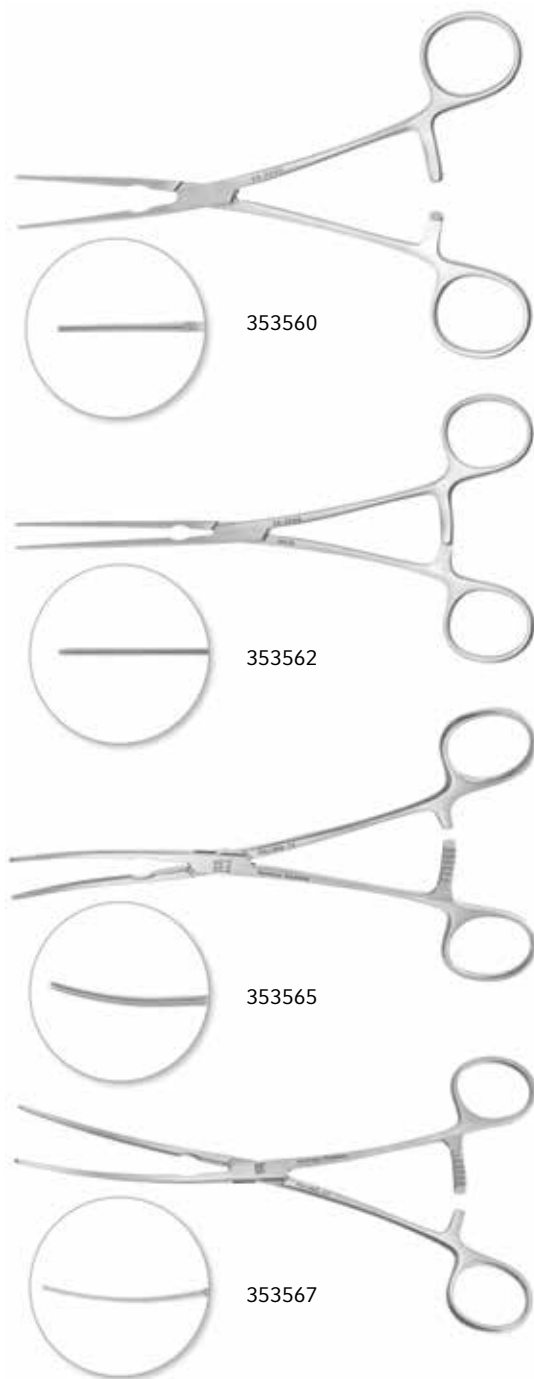

VASCULAR CLAMPS

Peripheral Vascular Clamps

DEBAKEY® COARCTATION CLAMPS

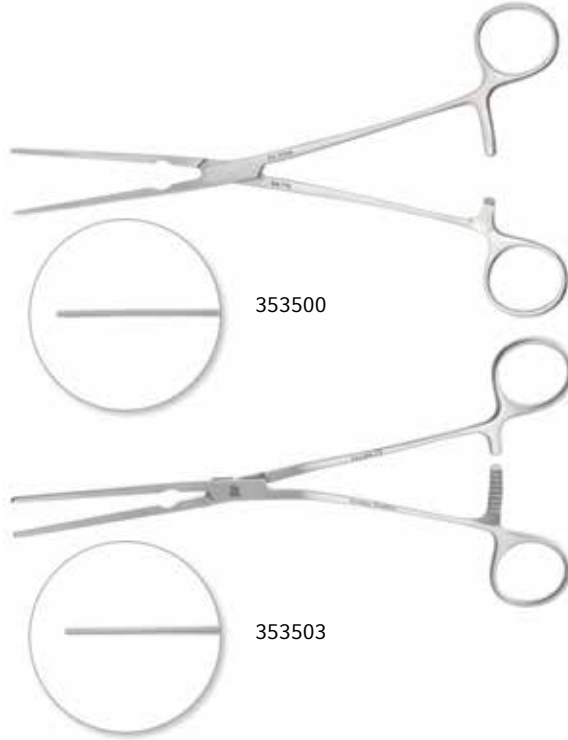

These are multipurpose clamps, full length but lightweight, with DeBakey®-type Jaws and spring handles. In addition to their use as Coarctation or Patent Ductus clamps, they are particularly useful for temporarily occluding renal arteries during cardiopulmonary by-pass. The special DeBakey®-type Jaws are only 2.5 mm wide. Spring handles minimize trauma to vessels during temporary occlusion of arteries. Spring handle, 1 x 9 ratchets.

CATALOG #	DESCRIPTION
353500	Long, straight, 3-1/8" (8 cm) jaw, 9" (23 cm)
353503	Long, angled, 3" (7.5 cm) jaw, 8-3/4" (22 cm)

DEBAKEY® CURVED PERIPHERAL VASCULAR CLAMP

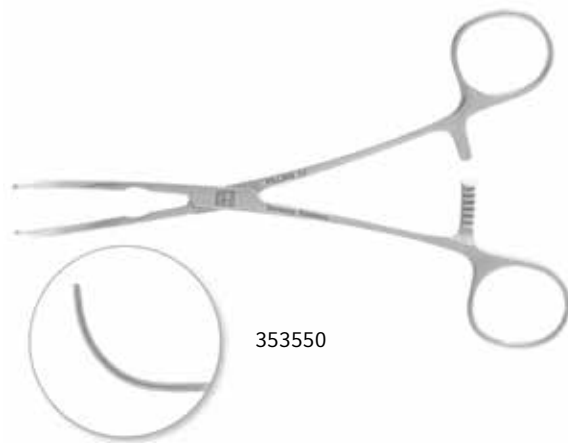

CATALOG #	DESCRIPTION
353550	Long, DeBakey®-type Jaw, spring handle, 1 x 7 ratchets, 6-3/4" (17 cm)



VASCULAR CLAMPS

Peripheral Vascular Clamps

DEBAKEY® PATENT DUCTUS CLAMPS

Long, DeBakey®-type Jaw, spring handle, 1 x 9 ratchets.

CATALOG #	DESCRIPTION
353510	Straight, 2-1/4" (5.5 cm) jaw, 8-1/4" (21 cm)
353513	Angled, 2-3/8" (6 cm) jaw, 8-1/8" (20.5 cm)

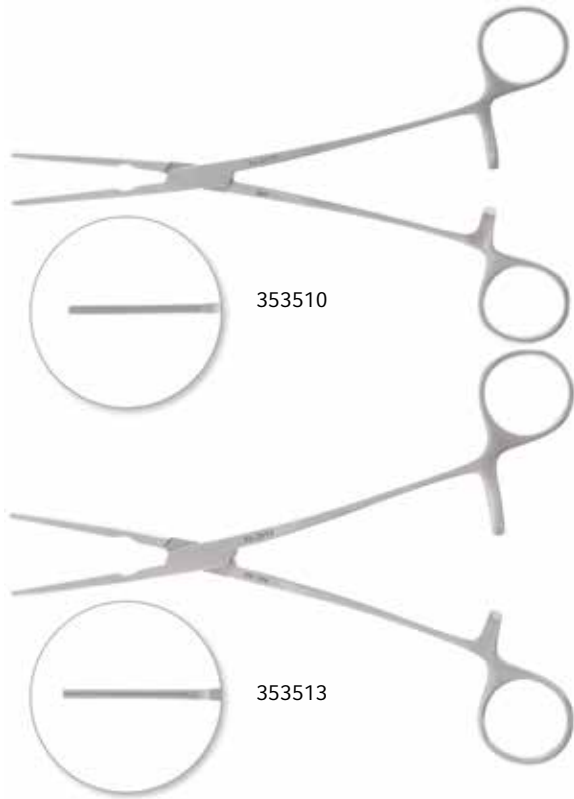



VASCULAR CLAMPS

Peripheral Vascular Clamps

DERRA MINIATURE ANASTOMOSIS CLAMPS

Long, DeBakey®-type Jaw, spring handle, 1 x 7 ratchets.

CATALOG #	DESCRIPTION
354135	Small, 3/4" (2 cm) jaw, 6-7/8" (17.5 cm)
354136	Medium, 1-1/8" (3 cm) jaw, 7" (18 cm)
354137	Large, 1-1/4" (3 cm) jaw, 7-1/8" (18 cm)

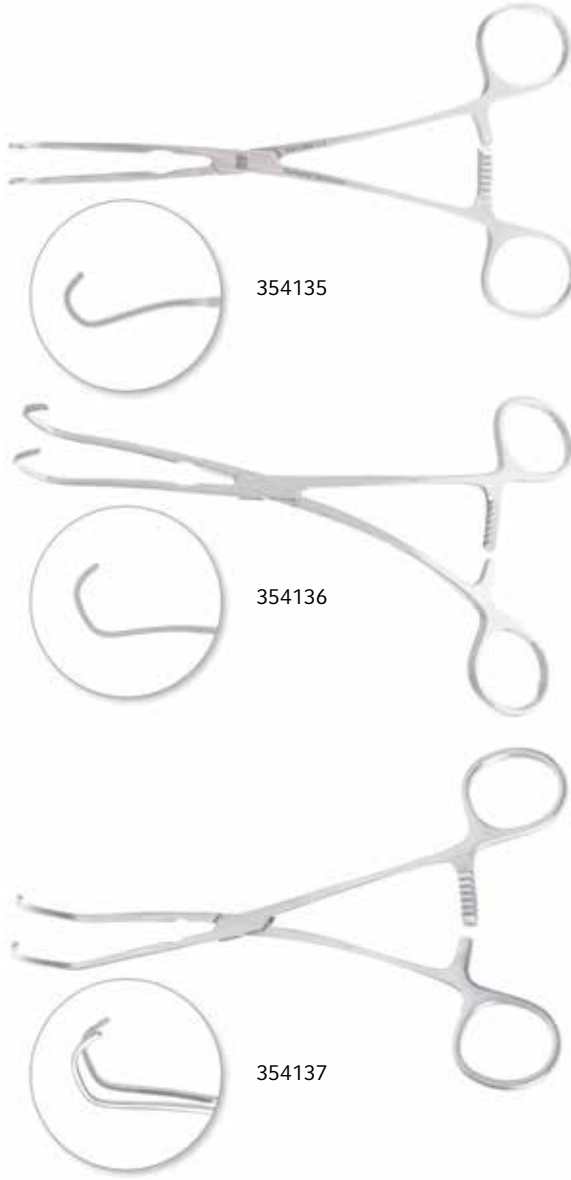



VASCULAR CLAMPS

Peripheral Vascular Clamps

DIETHRICH CAVAL OCCLUSION CLAMP

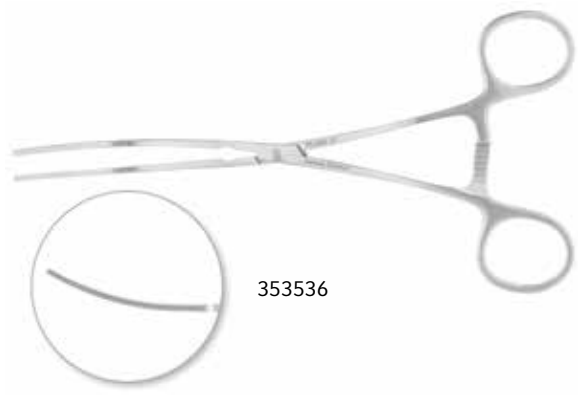

CATALOG #	DESCRIPTION
353536	9-3/4" (25 cm)

DIETHRICH CORONARY ARTERY CLAMP

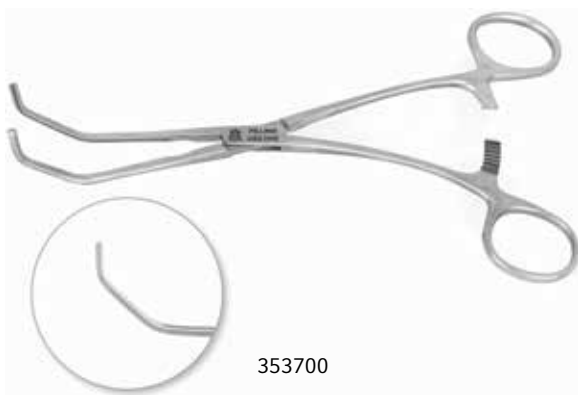

A delicate clamp with handles designed for partial occlusion in coronary artery surgery.

CATALOG #	DESCRIPTION
353700	Angled, DeBakey®-type Jaws, 1-1/4" (3 cm), 7-1/8" (18 cm)

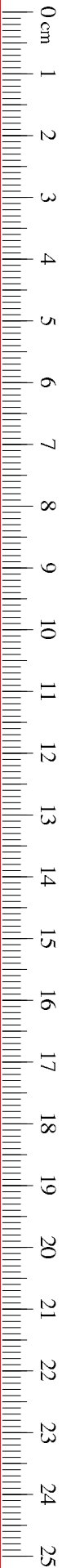

VASCULAR CLAMPS

Peripheral Vascular Clamps

GREGORY PROFUNDA CLAMPS

DeBakey®-type Jaw, 1 x 6 ratchets.

CATALOG #	DESCRIPTION
353494	Small, 2-1/4" (6 cm) extra-fine jaw, 4-3/4" (12 cm)
353495	Medium, 3-1/4" (8.5 cm) regular jaw, 6-1/8" (15.5 cm)
353496	Large, 4" (10 cm) jaw, 7" (18 cm)

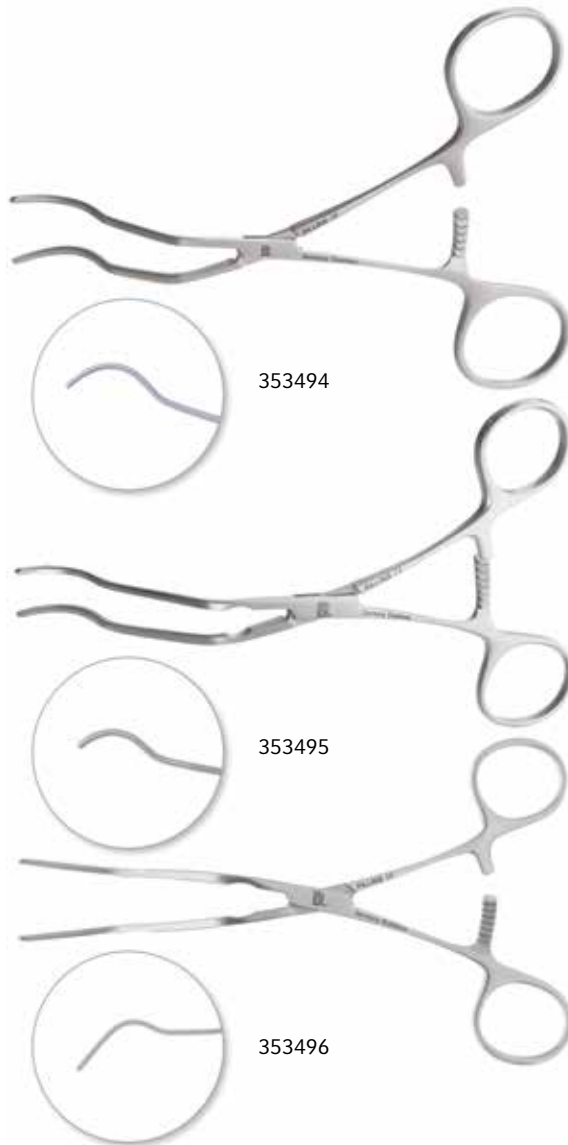



VASCULAR CLAMPS

Peripheral Vascular Clamps

HENLY SUBCLAVIAN ARTERY CLAMP

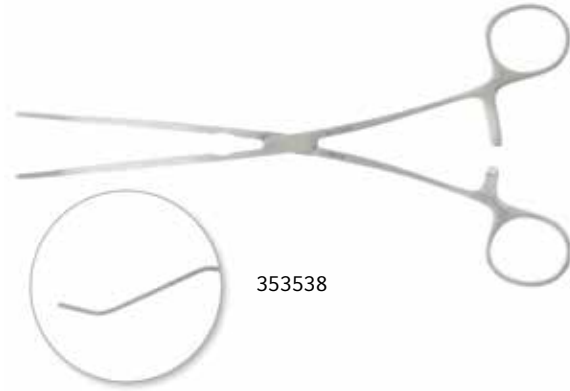

Double angled DeBakey®-type Jaws specially designed to allow clamping an artery of medium size from beneath the artery, allowing an unobstructed working area anteriorly. It is extremely useful for occlusion of the subclavian artery exposed through a supraclavicular incision or for occlusion of the femoral artery exposed through a groin incision.

CATALOG #	DESCRIPTION
353538	8-3/8" (21 cm)

LELAND JONES CLAMPS

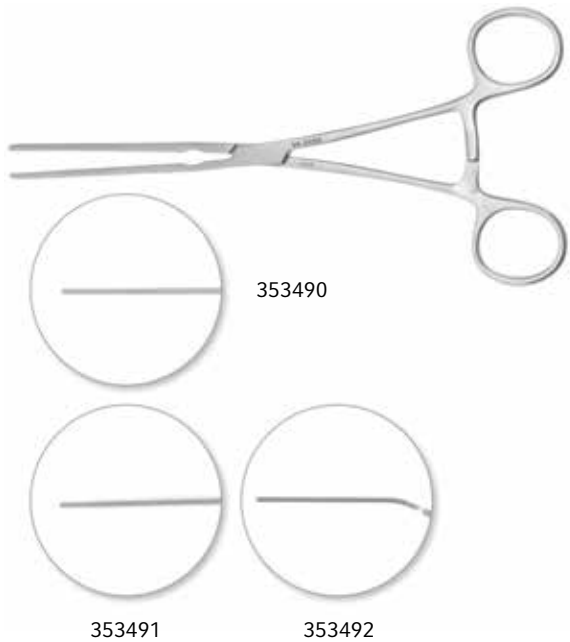

Delicate jaws, 2.4 mm wide. DeBakey®-type Serrations. LIFE-LOK® Box-Lock. Versatile clamps which have been found useful in small bowel procedures.

CATALOG #	DESCRIPTION
353490	Straight, 8-1/8" (20.5 cm)
353491	Angled 15 degrees, 8-1/8" (20.5 cm)
353492	Angled 30 degrees, 8" (20.5 cm)



VASCULAR CLAMPS

Peripheral Vascular Clamps

MITCHELL-ADAM MULTIPURPOSE CLAMP



A delicate vascular clamp 25 cm long with curved shanks. Designed as a multi-purpose clamp for vascular surgery. DeBakey®-type Jaws.

CATALOG #	DESCRIPTION
353639	9-7/8" (25 cm)

Cooley Vascular Clamps

COOLEY CAROTID, SUBCLAVIAN AND RENAL CLAMP



Long, slender clamp with jaws calibrated on outer sides from distal tip. Curved shafts, angled tips.

CATALOG #	DESCRIPTION
354839	Carotid, jaw length 5/8" (15 mm), 7-3/4" (19.5 cm)



VASCULAR CLAMPS

Cooley Vascular Clamps

COOLEY COARCTATION CLAMPS

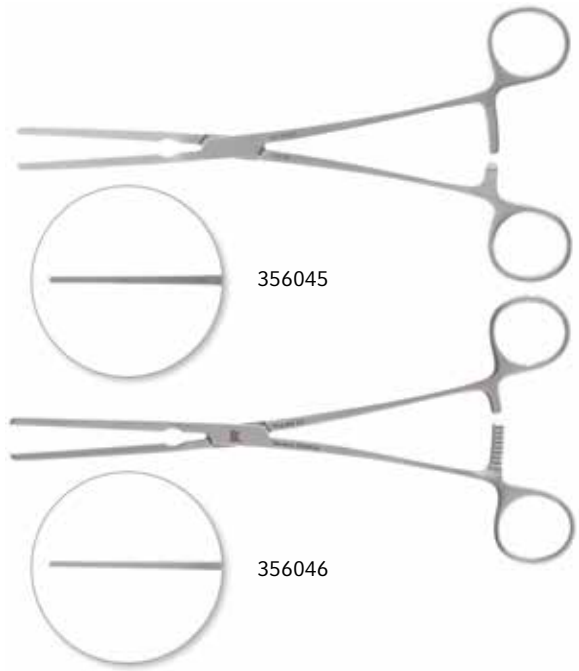

Standard length.

CATALOG #	DESCRIPTION
356045	Straight, jaw section 2-7/8" (7.5 cm) long, 8-3/4" (22.5 cm)
356046	Angled, jaw section 2-3/8" (6 cm) long, 8-7/8" (22.5 cm)

COOLEY ILIAC CLAMPS

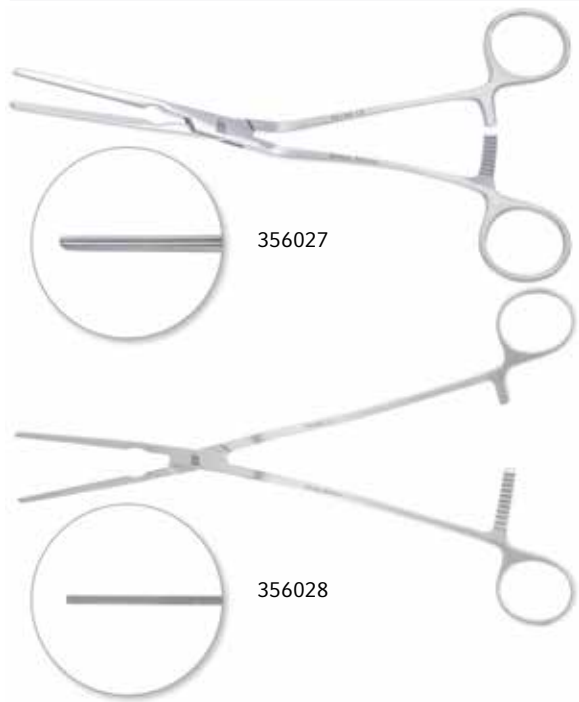

Angled jaws. Unusually long jaws contain Cooley-type serrations only on the distal portion.

CATALOG #	DESCRIPTION
356027	Light model, 8-1/4" (21 cm)
356028	9-3/4" (25 cm)

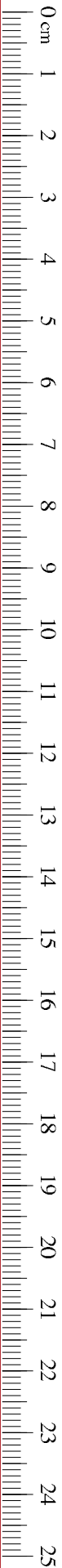

VASCULAR CLAMPS

Cooley Vascular Clamps

COOLEY JAW MULTIPURPOSE CLAMPS

60 degree angled jaws with curved shafts.

CATALOG #	DESCRIPTION
356070	No. 1, jaw length 1-1/2" (4 cm), 9-1/8" (23 cm)
356071	No. 2, jaw length 2-1/8" (5.5 cm), 8-1/2" (21.5 cm)
356072	No. 3, jaw length 2-1/2" (6.5 cm), 8-1/2" (21.5 cm)





VASCULAR CLAMPS

Cooley Vascular Clamps

COOLEY PARTIAL-OCCLUSION CLAMPS

Full adult size with Cooley 2 x 2 jaws, varying in length and jaw size. All have long distal sections adding to their value as partial tangential occlusion clamps.

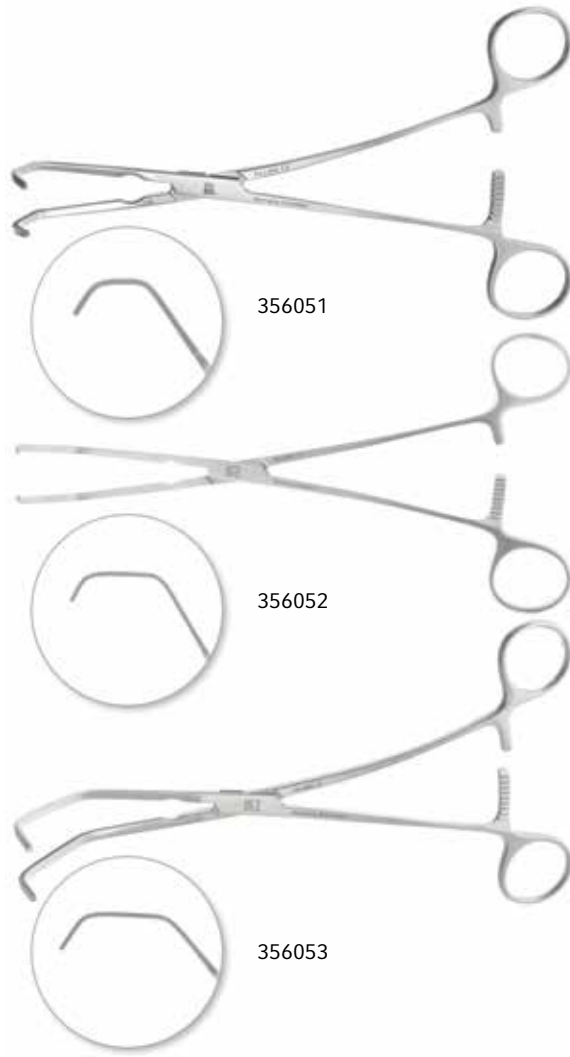

CATALOG #	DESCRIPTION
356051	No. 1, (A) length 1" (2.5 cm), overall 8-1/8" (20.5 cm)
356052	No. 2, (A) length 1-1/2" (4 cm), overall 8-7/8" (22.5 cm)
356053	No. 3, (A) length 1-7/8" (5 cm), overall 8-7/8" (22.5 cm)

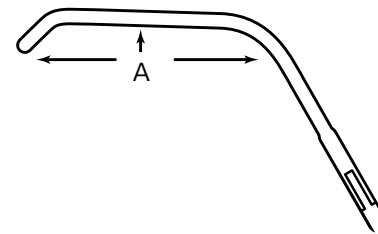



VASCULAR CLAMPS

Cooley Vascular Clamps

COOLEY PATENT-DUCTUS CLAMPS

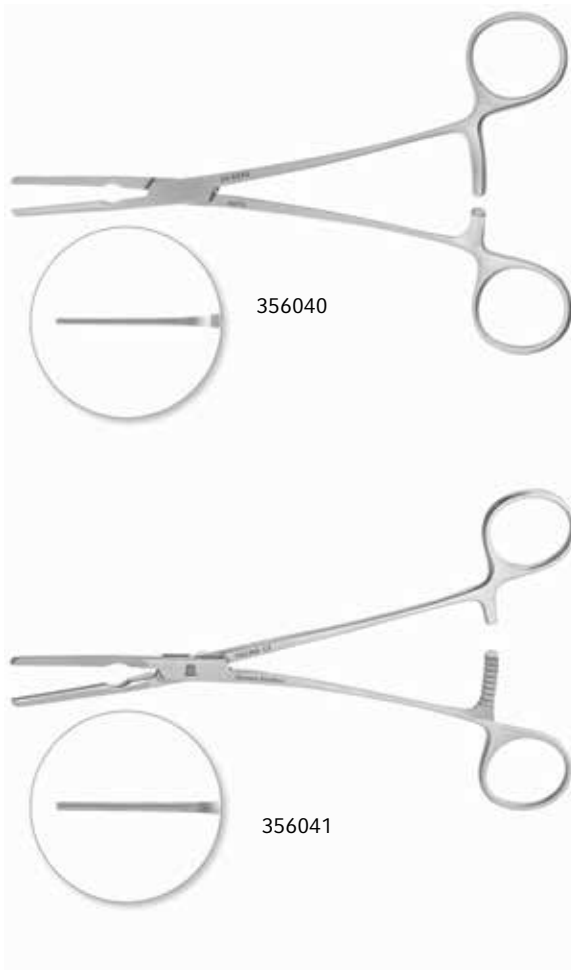

CATALOG #	DESCRIPTION
356040	Straight, 8" (20.5 cm)
356041	Angled, 7-7/8" (20 cm)



VASCULAR CLAMPS

Cooley Vascular Clamps

COOLEY PERIPHERAL VASCULAR CLAMPS

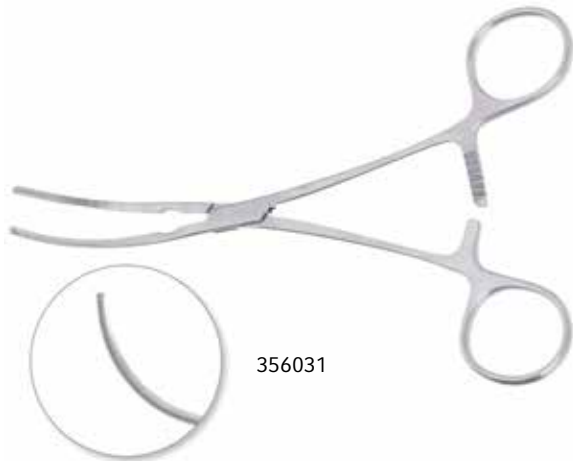

Useful for temporarily occluding the femoral, popliteal, subclavian and carotid arteries during performance of thromboendarterectomy or application of by-pass procedures. Relatively lightweight Cooley Jaws.

CATALOG #	DESCRIPTION
356025	Angled, 7-1/2" (19 cm)
356031	Curved, 6-3/4" (17 cm)

COOLEY VENA CAVA CLAMPS

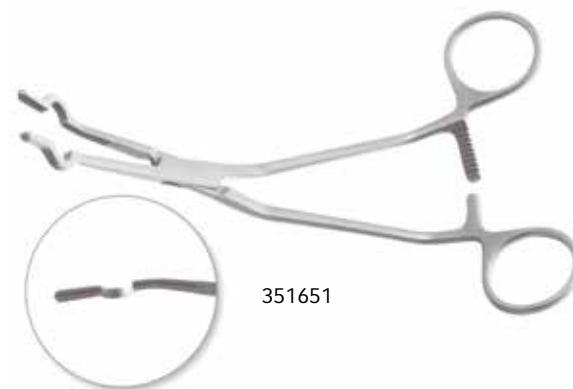

Occludes the vena cava and allows bloodflow through the cannula or catheter.

CATALOG #	DESCRIPTION
351645	Child size, 24 Fr. Ring tip width, 6-1/8" (15.5 cm)
351646	Child size, 26 Fr. Ring tip width, 7-1/4" (18.5 cm)
351650	Adult size, 28 Fr. Ring tip width, 7-1/4" (18.5 cm)
351651	Adult size, 30 Fr. Ring tip width, 7-1/4" (18.5 cm)
351652	Adult size, 32 Fr. Ring tip width, 7-1/4" (18.5 cm)
351654	Adult size, 34 Fr. Ring tip width, 7-1/4" (18.5 cm)
351653	Adult size, 36 Fr. Ring tip width, 7-1/4" (18.5 cm)

AORTIC VASCULAR CLAMPS

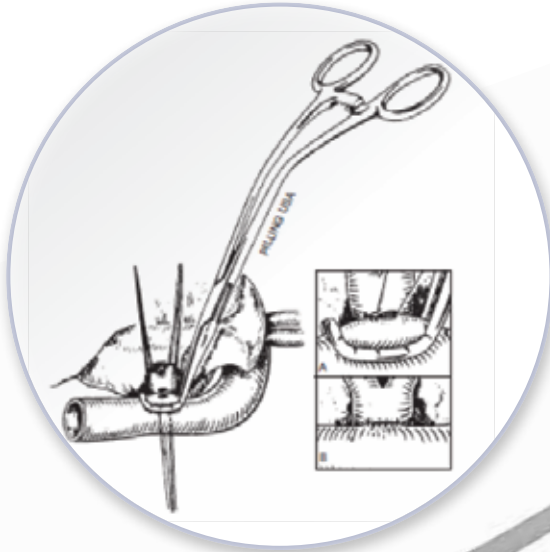

Many Pilling® Vascular Clamps feature the DeBakey® –type Non-Traumatic Jaws and LIFE-LOK® Mortise Box-Lock.

Ratchets on Pilling® Vascular Clamps provide the precision control needed for arterial clamping. Ratchets are designed with steps (1 x 7, 1 x 9, 1 x 11) to furnish the specific amounts of desired pressure. Jaws are precision-set by hand.

Coordination of ratchet length and jaw setting provides the accurate amount of required compression.

Many styles of DeBakey® –type Clamps are available with spring handles. With this construction feature, a portion of the shaft is flattened or otherwise altered and specially tempered to eliminate rigidity and provide a softness proportionate with the

overall size and purpose of the instrument. The intention is to minimize trauma to vessels with the soft spring handles but hold securely with DeBakey® –type Jaws.

HISTORY AND ACHIEVEMENTS

Since 1814, Pilling® has designed and manufactured high quality surgical instruments. As one of the oldest surgical instrument companies in the world, we have continued our tradition of craftsmanship and innovation.

THE PILLING® BRAND ADVANTAGE

Every cardiovascular instrument that we produce is set and checked by hand, then checked again to assure that it has the essential “feel” that is desired by surgeons. The Pilling® Brand has gained international acclaim for providing exceptional surgical tools. Working closely with the world’s top specialists, we continue to customize instrumentation to meet their exacting individual requirements. We have designed over 500 vascular clamps.

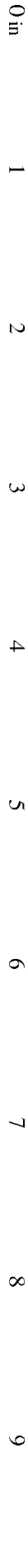

VASCULAR CLAMPS

Aortic Vascular Clamps

BAHNSON AORTA CLAMP

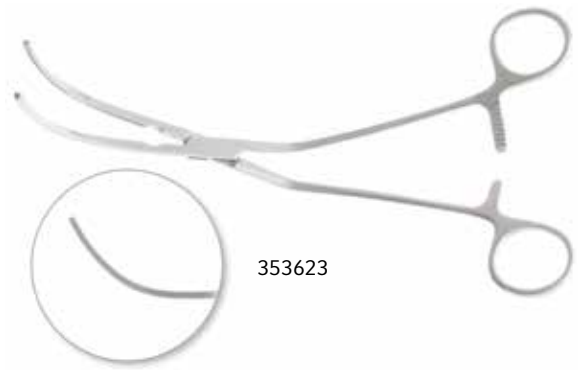

To occlude the aorta during a median sternotomy in the adult. Angle of handle puts it out of the way.

CATALOG #	DESCRIPTION
353623	Curved, DeBakey® Jaw, 2-3/4" (7 cm), 9" (23 cm)

BAILEY AORTA CLAMPS



Designed for exclusion of a portion of the vessel, these clamps are medium-weight and have DeBakey®-type Jaws.

CATALOG #	DESCRIPTION
354084	Angled shafts, extra-small size jaw, (A) length 1-1/8" (3 cm), 8" (20.5 cm)
354087	Angled shafts, large size jaw, (A) length 2-1/8" (5.5 cm), 9-3/4" (25 cm)

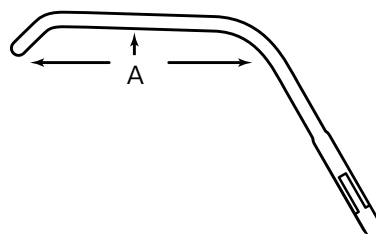

VASCULAR CLAMPS

Aortic Vascular Clamps

BECK-TYPE AORTA CLAMPS

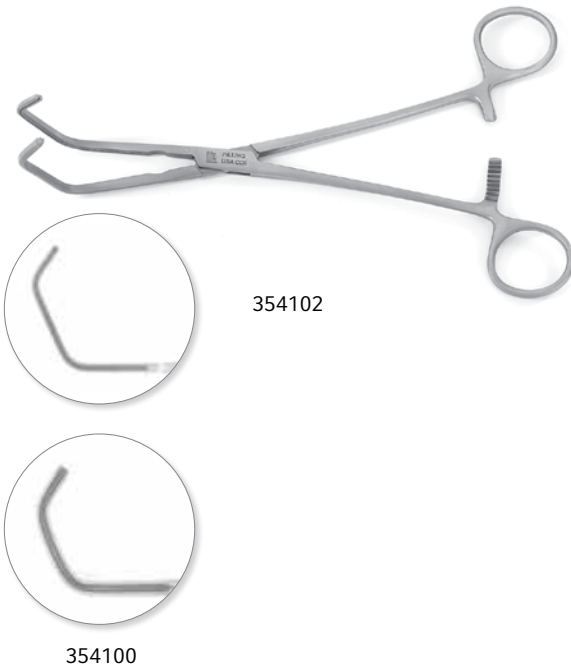

DeBakey®-type Jaws, acutely angled at approximately 65 degrees. Straight shafts.

CATALOG #	DESCRIPTION
354100	Angled, DeBakey® Jaw, 1-1/4" (3 cm) tip length (A), 8-1/8" (20.5 cm)
354102	Angled, DeBakey® Jaw, 2" (5 cm) tip length (A), 8-5/8" (22 cm)

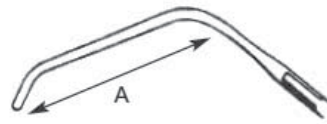

CHERRY SUPRACELIAC CLAMP

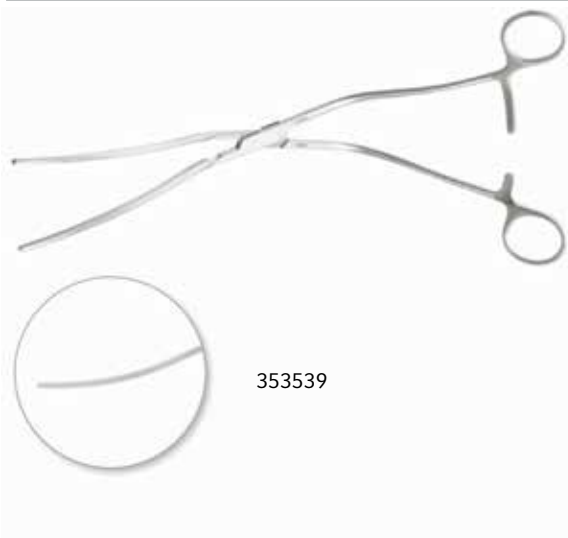

Used in thoracic and abdominal aortic aneurysm repairs, renal vascular procedures, mesenteric artery revascularization. For deep access to aorta superior to the celiac artery. Jaw length and curve combine with angled handle to provide optimum cross clamping capability and reduced operative field obstruction.

CATALOG #	DESCRIPTION
353539	Curved, 2 x 3 DeBakey®-type Jaw, 50 degree handle, LIFE-LOK® Box-Lock, 12-1/4" (31 cm)



VASCULAR CLAMPS

Aortic Vascular Clamps

CRAFOORD COARCTATION VASCULAR CLAMPS

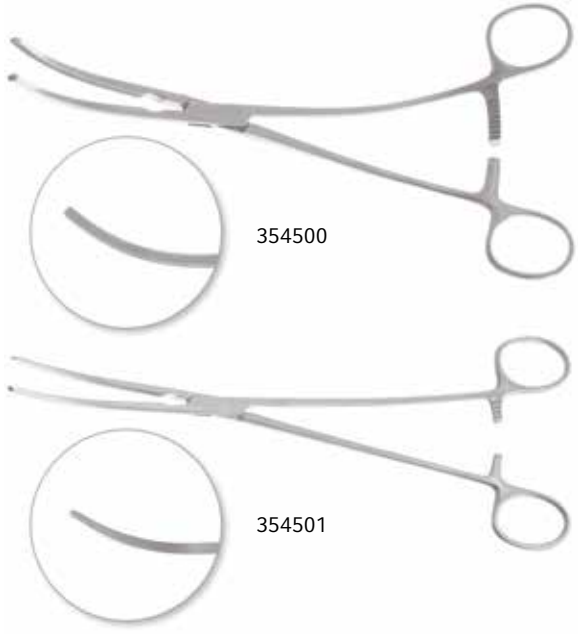

CATALOG #	DESCRIPTION
354500	Slightly curved, 3-3/8" (8.5 cm) DeBakey®-type Jaw, 1 x 9 ratchets, 9-5/8" (24.5 cm)
354501	Slightly curved, with original, longitudinal jaws, 9-5/8" (24.5 cm)

VASCULAR CLAMPS

Aortic Vascular Clamps

DEBAKEY® MULTI-PURPOSE ANGLED CLAMPS

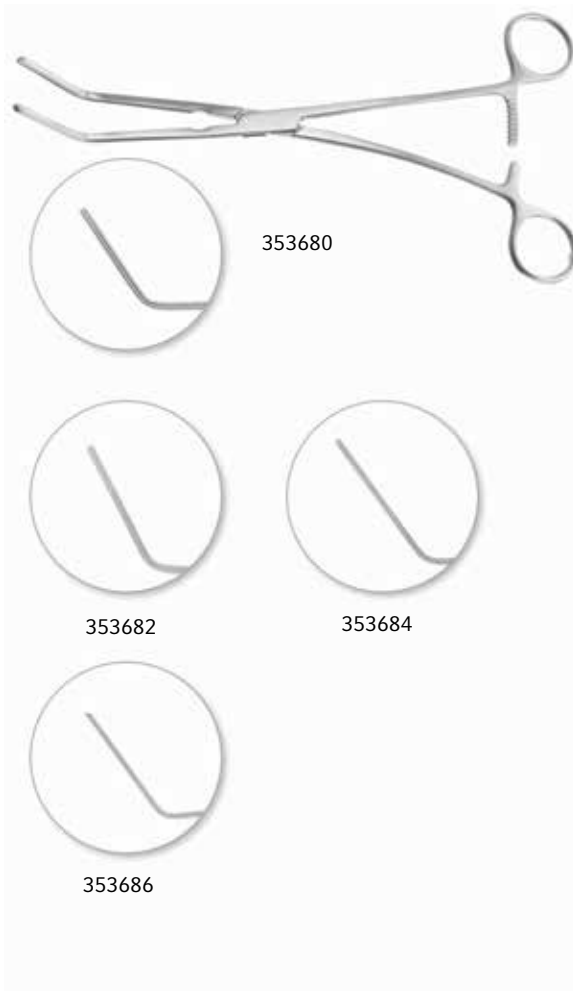

After considerable use and experimentation with a wide variety of standard pattern clamps, this assortment of matched design DeBakey® Clamps has been assembled. They are of various lengths with curved shafts. The DeBakey®-type Jaws are angulated at 60 or 90 degrees. In addition to their function as aortic clamps, they are available for use as bronchus and gastric clamps in general surgery.

CATALOG #	DESCRIPTION
353680	No. 1, 60 degree angle, 1-1/4" (3.5 cm) jaw, 1 x 9 ratchets, 9-1/2" (24 cm)
353682	No. 2, 60 degree angle, 1-3/4" (4.5 cm) jaw, 1 x 9 ratchets, 8-5/8" (22 cm)
353684	No. 3, 60 degree angle, 2" (5 cm) jaw, 1 x 9 ratchets, 9-7/8" (25 cm)
353686	No. 4, 60 degree angle, 3-1/2" (8.9 cm) jaw, 1 x 11 ratchets, 11-5/8" (29.5 cm)
353690	No. 1, 90 degree angle, 1-3/4" (4.5 cm) jaw, 9-1/2" (24 cm)
353692	No. 2, 90 degree angle, 2-1/4" (5.5 cm) jaw, 7-1/4" (18.5 cm)
353694	No. 3, 90 degree angle, 2-3/4" (7 cm) jaw, 9" (23 cm)
353696	No. 4, 90 degree angle, 4-1/8" (10.5 cm) jaw, 10-1/4" (26 cm)

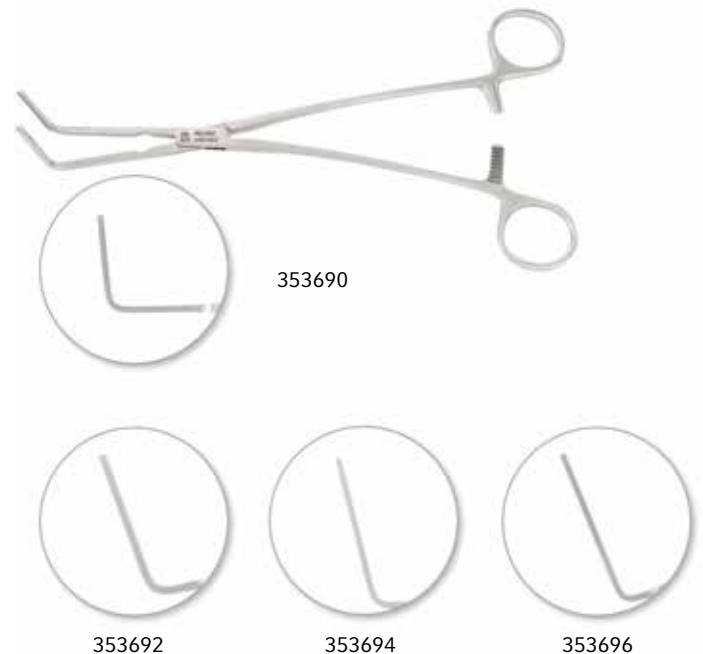



VASCULAR CLAMPS

Aortic Vascular Clamps

DEBAKEY® TANGENTIAL OCCLUSION CLAMPS

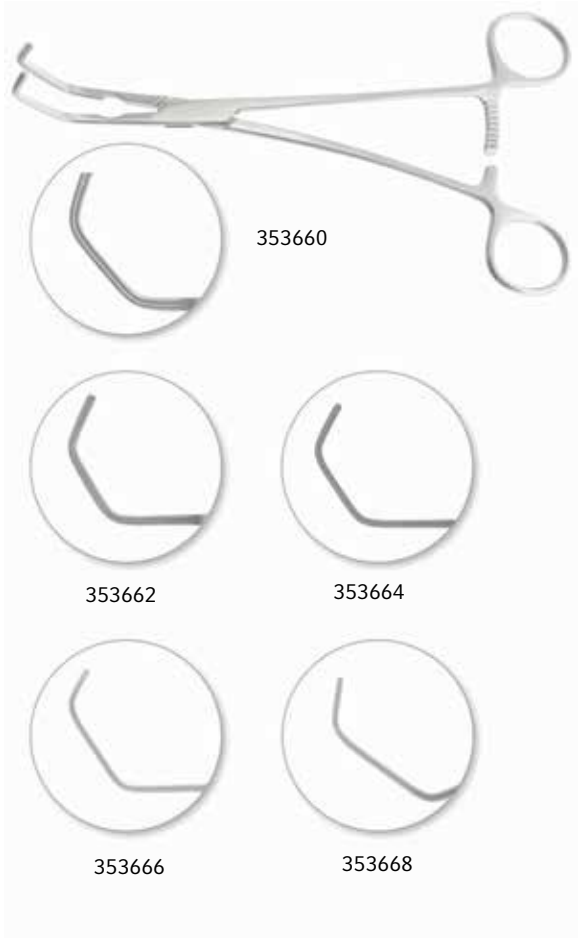

Since most of the double angle clamps now available are considered too shallow in the jaw section due to short distal tip section, this deep-jaw selection of DeBakey®-type Clamps was designed. The set consists of five instruments varying in length and jaw size. All have unusually long distal sections, adding to their value as partial tangential occlusion clamps. Dull, non-glare finished stainless steel.

CATALOG #	DESCRIPTION
353660	No. 1, 1-3/8" (3.5 cm) jaw, 1 x 9 ratchets, 7-3/4" (19.5 cm)
353662	No. 2, 1-7/8" (5 cm) jaw, 1 x 11 ratchets, 10" (25.5 cm)
353664	No. 3, 2" (5 cm) jaw, 1 x 11 ratchets, 10-3/8" (26.5 cm)
353666	No. 4, 2-3/8" (6 cm) jaw, 1 x 11 ratchets, 10" (25.5 cm)
353668	No. 5, 3-1/8" (8 cm) jaw, 1 x 11 ratchets, 10-1/8" (25.5 cm)
353670	Complete set of 5 clamps

FAVALORO PROXIMAL ANASTOMOSIS CLAMP

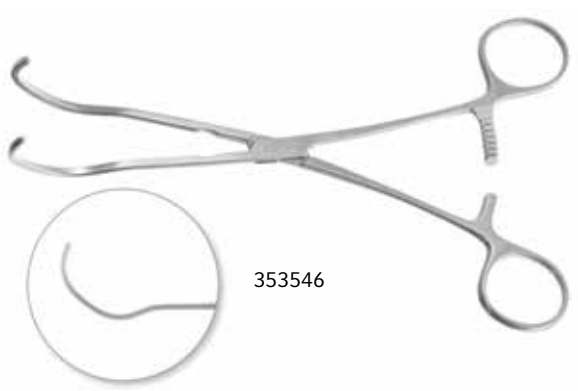

CATALOG #	DESCRIPTION
353546	Curved, 1-1/4" (3.5 cm) DeBakey®-type Jaws, 8" (20 cm)



VASCULAR CLAMPS

Aortic Vascular Clamps

GERBODE PATENT DUCTUS CLAMP

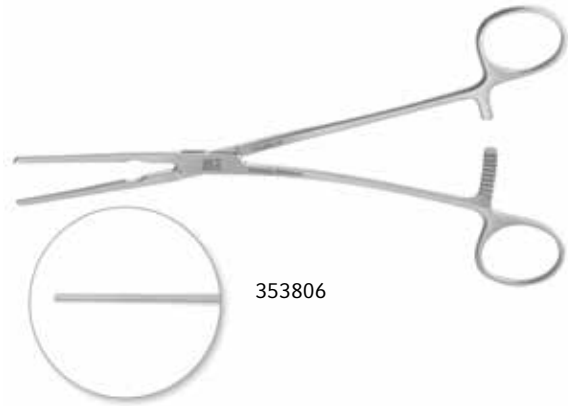

The Glover Patent Ductus Clamps on pg. 638 have been redesigned with extra-narrow 1" (2.5 cm) DeBakey®-type Jaws to provide for maximum length of cut vessel for more convenient suturing.

CATALOG #	DESCRIPTION
353806	Angled, 8" (20.5 cm)

GLOVER ATRIAL APPENDAGE CLAMP



DeBakey®-type Jaws. Specially designed for holding the atrial appendage at any level without crushing.

CATALOG #	DESCRIPTION
354170	Jaw (A) length 1-11/16" (43 mm), (A) depth 1/4" (7 mm), (C) 1-1/8" (30 mm), (D) 1/2" (13 mm), 9-1/2" (24 cm)

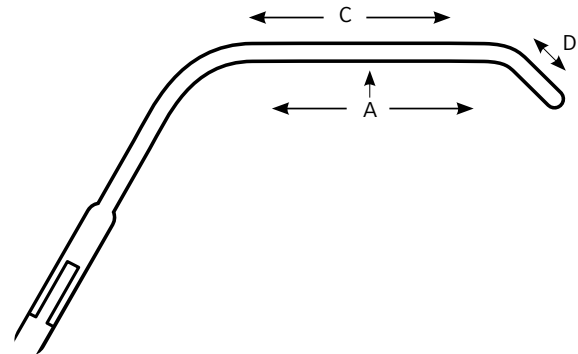



VASCULAR CLAMPS

Aortic Vascular Clamps

GLOVER COARCTATION CLAMPS

DeBakey®-type Jaw, 1 x 9 ratchets.

CATALOG #	DESCRIPTION
353810	Straight, 3-1/8" (8 cm) jaw, 9" (23 cm)
353812	Angled, 3-1/8" (8 cm) jaw, 8-7/8" (22.5 cm)
353815	Extra-long, straight, 3-3/4" (9.5 cm) jaw, 10-5/8" (27 cm)
353817	Extra-long, angled, 3-5/8" (9 cm) tip length, 10-3/8" (26.5 cm)

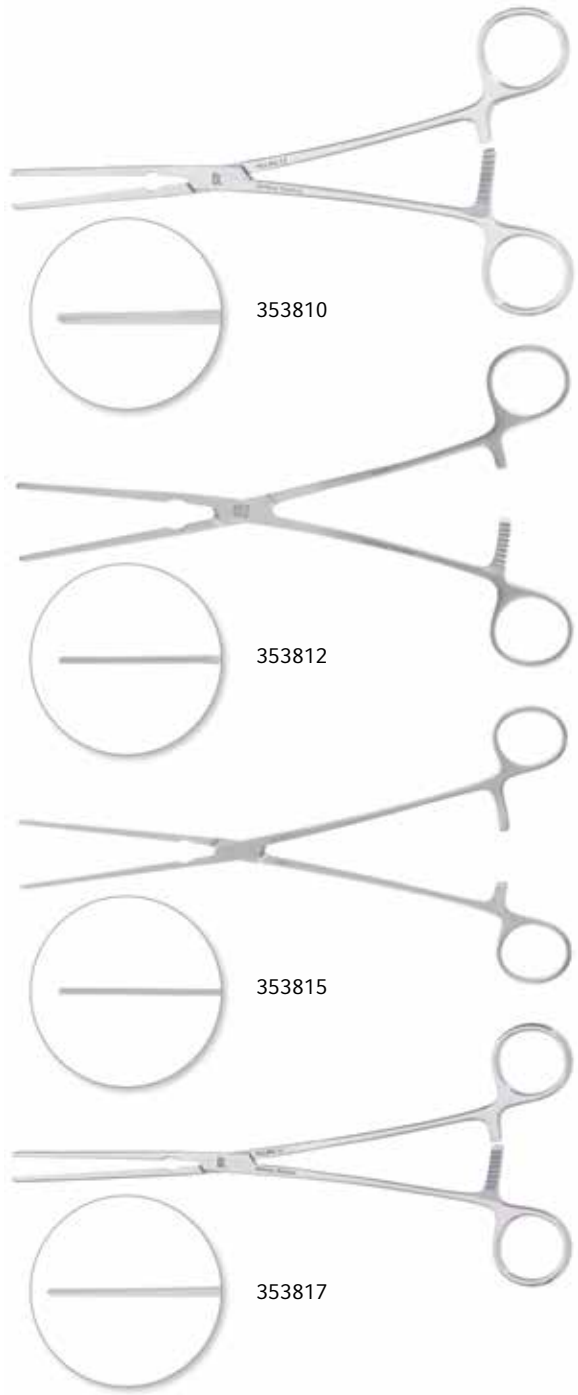



VASCULAR CLAMPS

Aortic Vascular Clamps

GLOVER CURVED CLAMPS

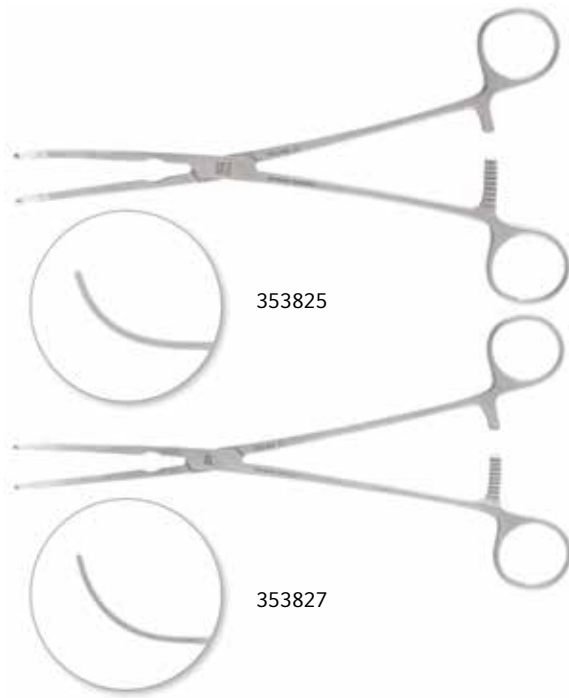

Curved DeBakey®-type Jaws.

CATALOG #	DESCRIPTION
353825	Standard size, 1-1/4" (3 cm) jaw, 8-1/2" (21.5 cm)
353827	Extra-long, 1-3/4" (4.5 cm) jaw, 9-7/8" (25 cm)

GLOVER PATENT DUCTUS CLAMPS

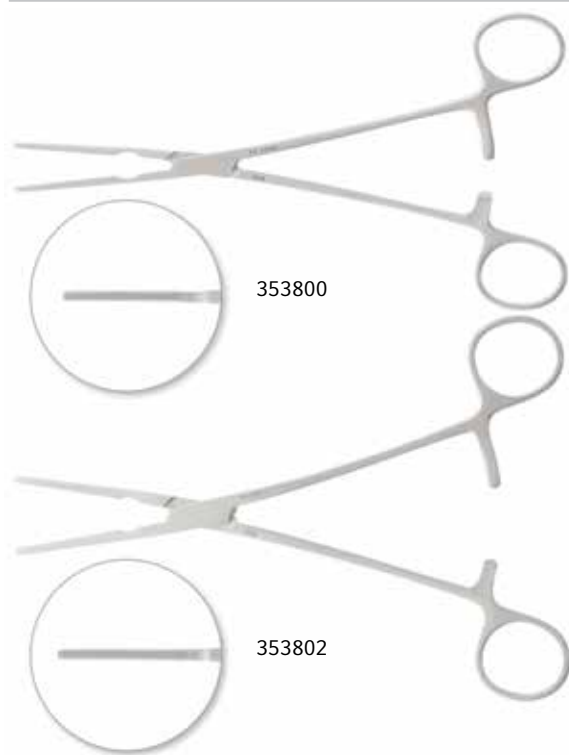

DeBakey®-type Jaws, 1 x 9 ratchets.

CATALOG #	DESCRIPTION
353800	Straight, 2-1/4" (5.8 cm) jaw, 8-1/8" (20.5 cm)
353802	Angled, 3/4" (1.9 cm) jaw, 8-1/4" (21 cm)



VASCULAR CLAMPS

Aortic Vascular Clamps

GLOVER RIGHT ANGLE CURVED CLAMPS

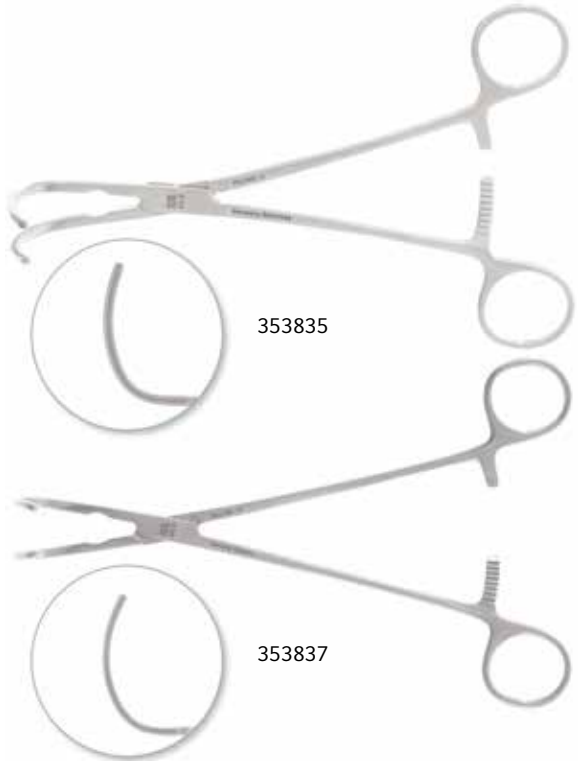

Curved DeBakey®-type Jaws.

CATALOG #	DESCRIPTION
353835	1-7/8" (4.8 cm) jaw, 7-5/8" (19.5 cm)
353837	2-3/8" (6 cm) jaw, 8-7/8" (22.5 cm)

GLOVER SPOON SHAPED CLAMPS

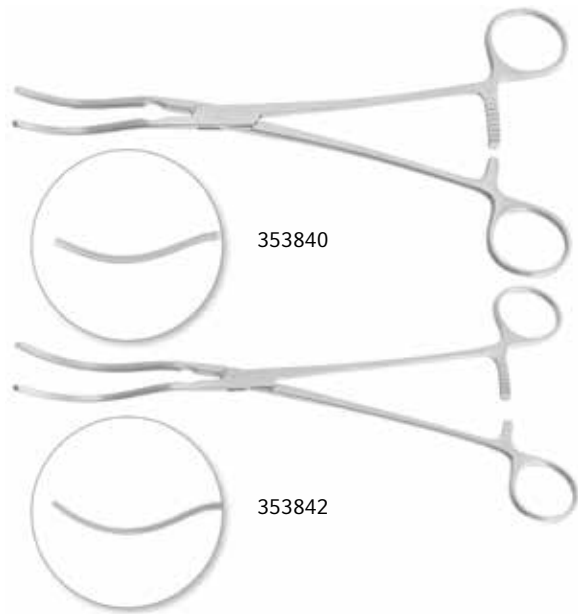

Curved DeBakey®-type Jaws.

CATALOG #	DESCRIPTION
353840	Standard size, 2-3/4" (7 cm) jaw, 8-5/8" (22 cm)
353842	Extra-long, 3-7/8" (10 cm) jaw, 10-1/2" (27 cm)

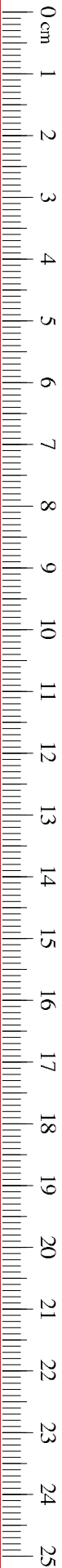

VASCULAR CLAMPS

Aortic Vascular Clamps

HARKEN CLAMPS

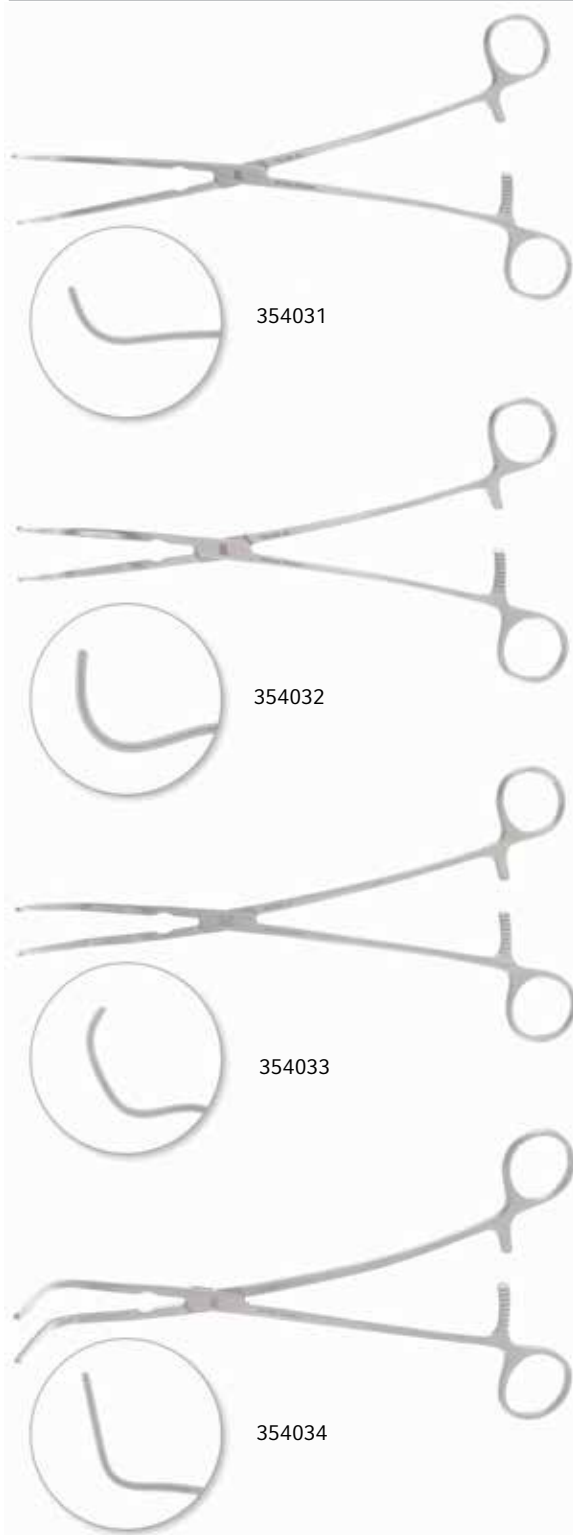

A matched set of four clamps identical in length and weight but with varying DeBakey®-type Jaw shapes.

CATALOG #	DESCRIPTION
354031	No. 1 curve, 10-1/2" (26.5 cm)
354032	No. 2 curve, 10-1/8" (25.5 cm)
354033	No. 3 curve, 10" (25.5 cm)
354034	No. 4 curve, 9-5/8" (24.5 cm)



VASCULAR CLAMPS

Aortic Vascular Clamps

HUFNAGEL AORTA CLAMPS

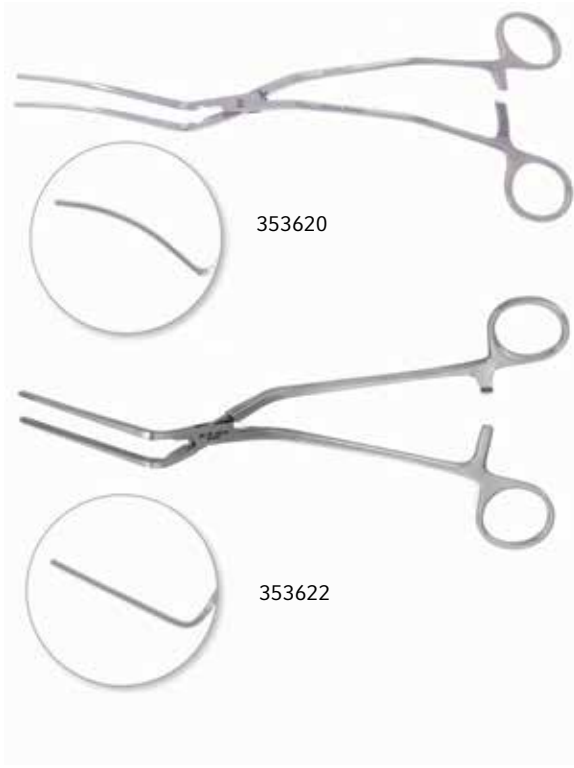

For the ascending aorta. Used to occlude the thoracic aorta in operations on the aortic root and the aortic valve. The curvature of the clamp allows it to be used with the midline sternotomy and to rest out of the operative field. DeBakey®-type Jaws.

CATALOG #	DESCRIPTION
353620	Curved, 3-1/8" (8 cm) jaws, 9-5/8" (24.5 cm)
353622	Straight, 3-1/8" (8 cm) jaws, 9-5/8" (24.5 cm)

AORTIC VASCULAR CLAMPS

Kay and Lambert-Kay Anastomosis Clamps

Three clamps designed primarily as side-biting clamps for ascending aorta to be used in lateral anastomosis in saphenous vein coronary artery by-pass procedures. Both clamps may also be applied for partial exclusion of other segments of aorta, large and small bowel. DeBakey®-type Jaws, 1 x 9 ratchets.

KAY-LAMBERT AORTIC ANASTOMOSIS CLAMP



CATALOG #	DESCRIPTION
353585	1-3/4" (4.5 cm) jaw, 8-1/8" (20.5 cm)

LAMBERT-KAY AORTIC ANASTOMOSIS CLAMP



CATALOG #	DESCRIPTION
353586	Large, 2" (5 cm) tip length, 8-1/8" (20.5 cm)



VASCULAR CLAMPS

Aortic Vascular Clamps

KAY AORTIC ANASTOMOSIS CLAMP



353580

CATALOG #	DESCRIPTION
353580	1-1/2" (4 cm) jaw, 7-5/8" (19.5 cm)

LEMOLE-STRONG AORTA CLAMPS



353582

353584

DeBakey®-type Jaw, 1 x 9 ratchets.

CATALOG #	DESCRIPTION
353582	Straight shanks, 7-7/8" (20 cm)
353584	Angled shanks, 8" (20.5 cm)

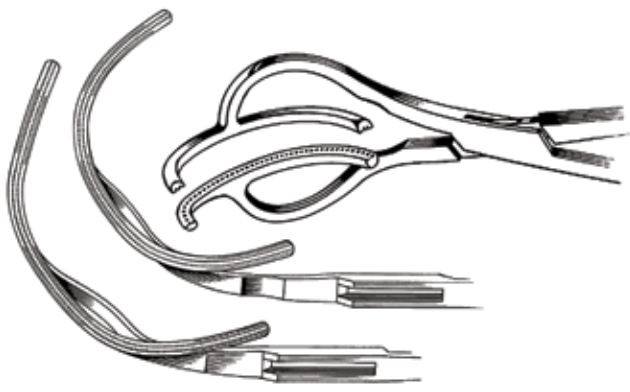



VASCULAR CLAMPS

Aortic Vascular Clamps

STRONG AORTA CLAMPS

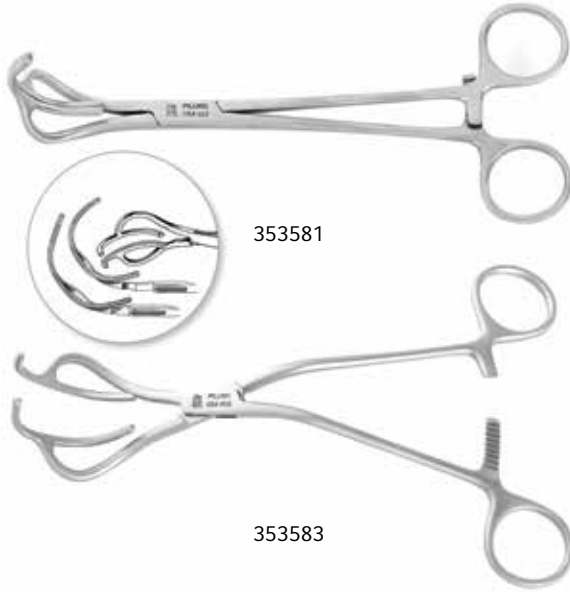

Unique design provides uniform pressure across entire jaw surface. 1 x 9 ratchets.

CATALOG #	DESCRIPTION
353581	Straight shanks, 8" (20 cm)
353583	Angled shanks, 8-1/8" (20.5 cm)

MITCHELL AORTOTOMY CLAMP

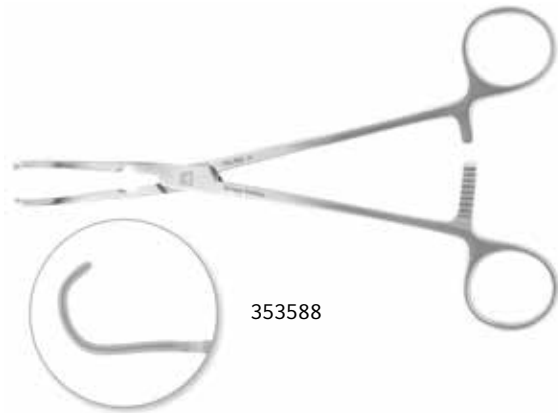

CATALOG #	DESCRIPTION
353588	DeBakey®-type Jaws, 1 x 9 ratchets, 8" (20.5 cm)



VASCULAR CLAMPS

Aortic Vascular Clamps

MORRIS ASCENDING AORTA CLAMPS

2 x 3 DeBakey®-type Jaws.

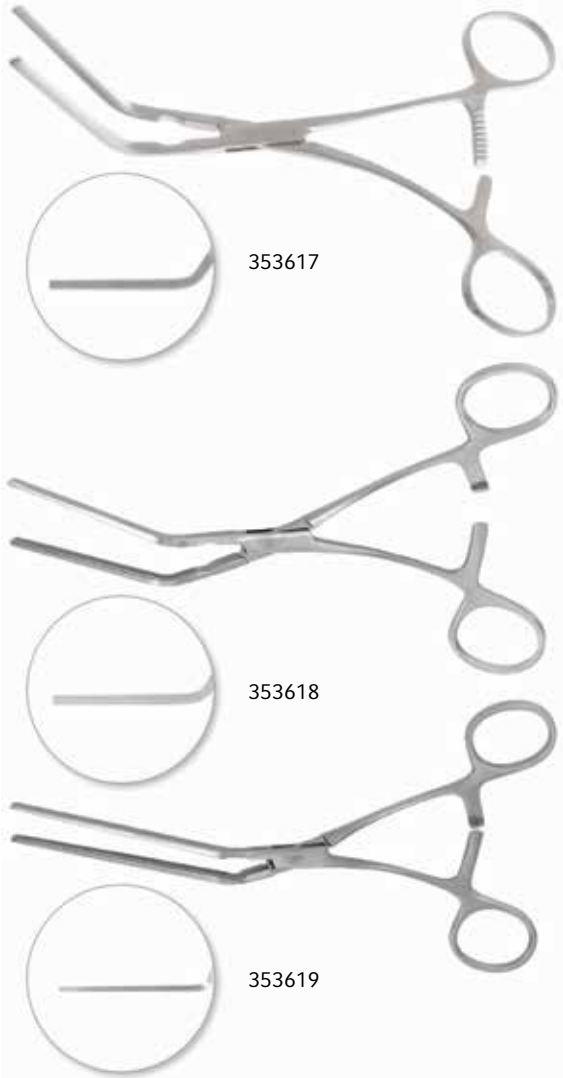

CATALOG #	DESCRIPTION
353617	Jaws 2-1/2" (6.5 cm) from angle, 8-1/8" (20.5 cm)
353618	Jaws 2-1/2" (6.5 cm) from angle, 9-1/2" (24 cm)
353619	Jaws 3-3/4" (9.5 cm) from angle, 9-1/2" (24 cm)

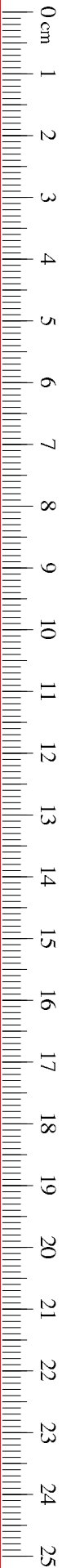

VASCULAR CLAMPS

Aortic Vascular Clamps

O'NEILL DOUBLE CURVED CLAMP



354165

This is a multipurpose instrument, actually a modification of the DeBakey®-type Satinsky. The jaw angles have been replaced by curves. Useful as a vena cava clamp and atrial appendage clamp, also for cross clamping or partially occluding vessels.

CATALOG #	DESCRIPTION
354165	(B) 3-1/8" (80 mm), 10-1/2" (26.5 cm)

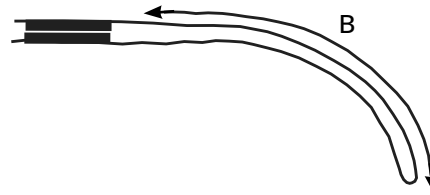

VASCULAR CLAMPS

Aortic Vascular Clamps

SATINSKY CLAMPS

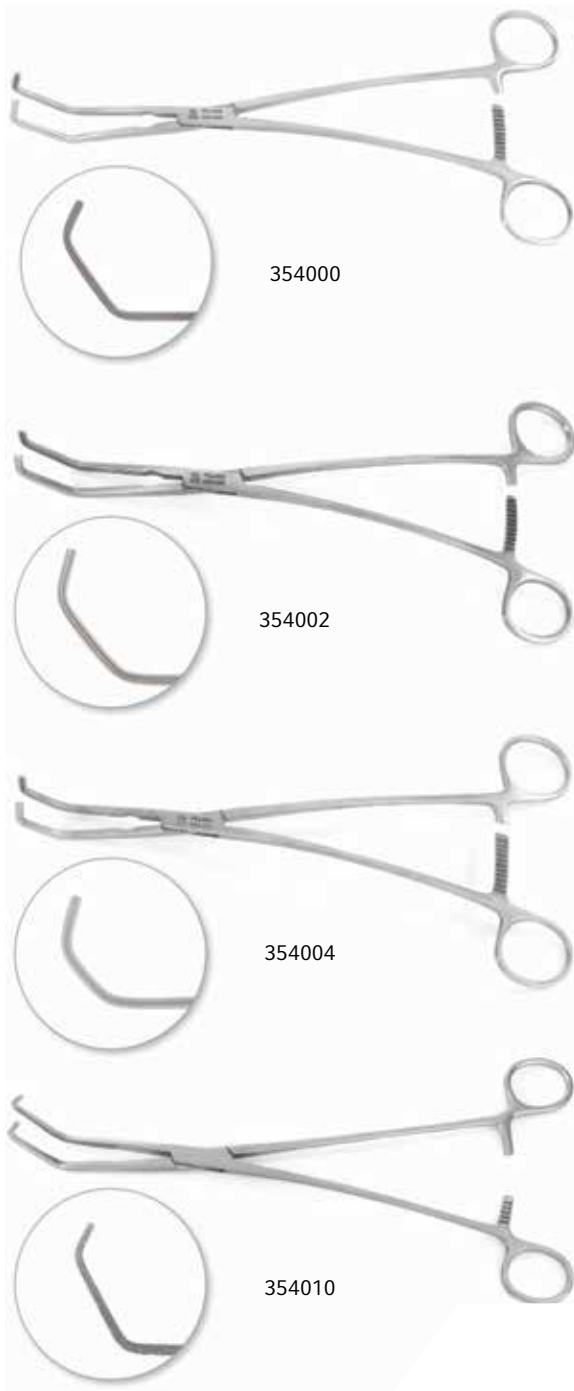

These instruments, originally designed for secure non-crushing grip in clamping the vena cava, have proven to be the most popular and versatile of all cardiac clamps. They are now provided in a variety of jaw types and sizes as listed. DeBakey®-type Jaws, 1 x 11 ratchets. Dull, non-glare finished stainless steel.

CATALOG #	DESCRIPTION
354000	Large, 2" (5 cm) jaw, 10-1/4" (26 cm)
354002	Medium, 1-1/2" (4 cm) jaw, 10" (25.5 cm)
354004	Small, 1-1/4" (3 cm) jaw, 9-3/4" (25 cm)
354005	Set of 3 (354000, 354002, 354004)
354010	Same as Large Satinsky Clamp (354000) except with original criss-cross serrated jaw

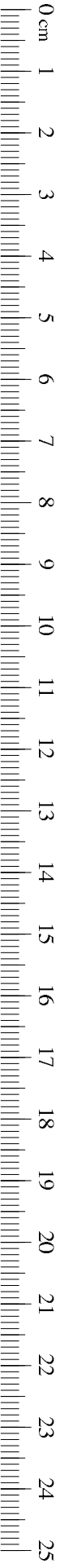

VASCULAR CLAMPS

Aortic Vascular Clamps

SCHUMAKER ANGULAR AORTA CLAMPS

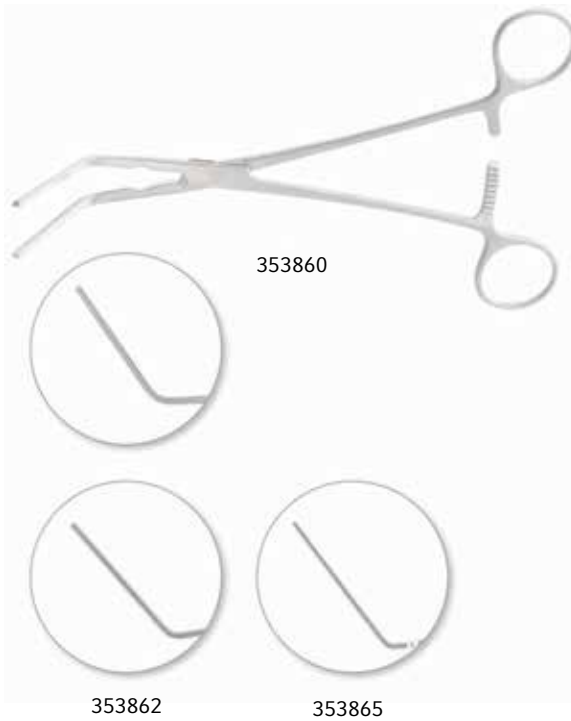

DeBakey®-type Jaws are angled at 60 degrees. These clamps are also used extensively in gastric surgery. Dull, non-glare finished stainless steel.

CATALOG #	DESCRIPTION
353860	Standard model, jaws 1-1/8" (5.5 cm) past angle, 8-1/2" (21.5 cm)
353862	Standard model, jaws 2-3/4" (7 cm) past angle, 8-7/8" (22.5 cm)
353865	Heavy model, jaws 3-15/16" (10 cm) past angle, jaw width 4 mm, 11-1/4" (28.5 cm)

STONEY DEEP AORTA CLAMPS

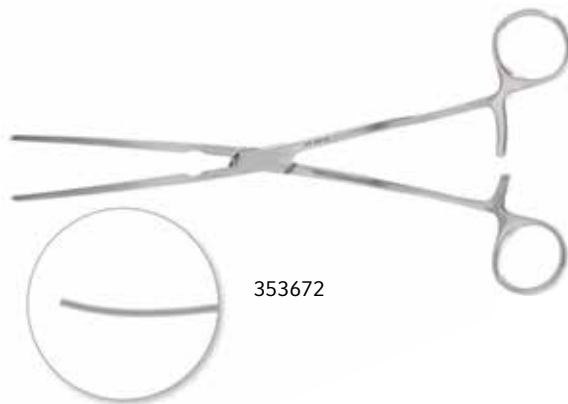

Features severely angled handles to lie across the xiphoid portion of the sternum.

CATALOG #	DESCRIPTION
353672	6-7/8" (17.5 cm)
353674	9" (23 cm)

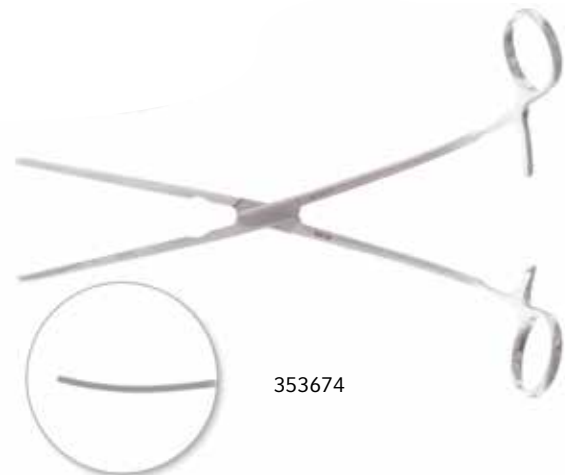



VASCULAR CLAMPS

Aortic Vascular Clamps

WYLIE "J" AORTIC CLAMPS

DeBakey®-type Jaws very acutely curved. Width at (A) 1-1/4" (3.5 cm), depth at (B) 1" (2.5 cm).

CATALOG #	DESCRIPTION
353655	Model No. 1, 9-5/8" (24.5 cm)
353656	Model No. 2, 9-1/4" (23.5 cm)



353655

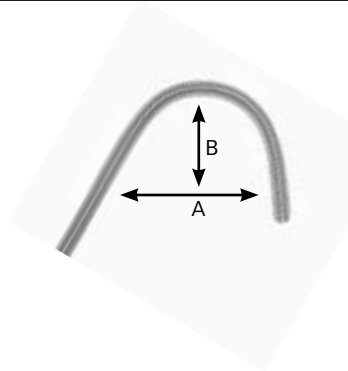

353656





VASCULAR CLAMPS

Aortic Aneurysm Clamps

COOLEY AORTA CLAMP

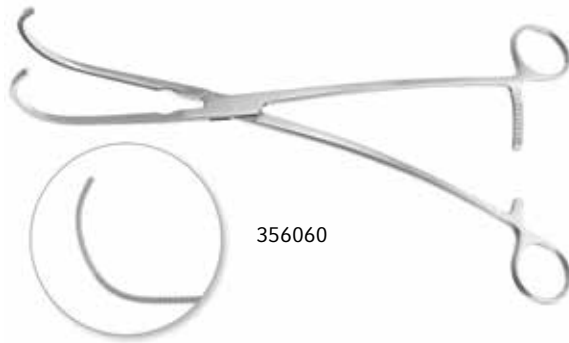

356060

For temporary occlusion of the abdominal and thoracic aorta during resection and graft replacement. Original Cooley Jaws.

CATALOG #	DESCRIPTION
356060	Jaw length 2" (5 cm), 11-1/4" (28.5 cm)

CRAWFORD THORACO-ABDOMINAL ANEURYSM CLAMPS

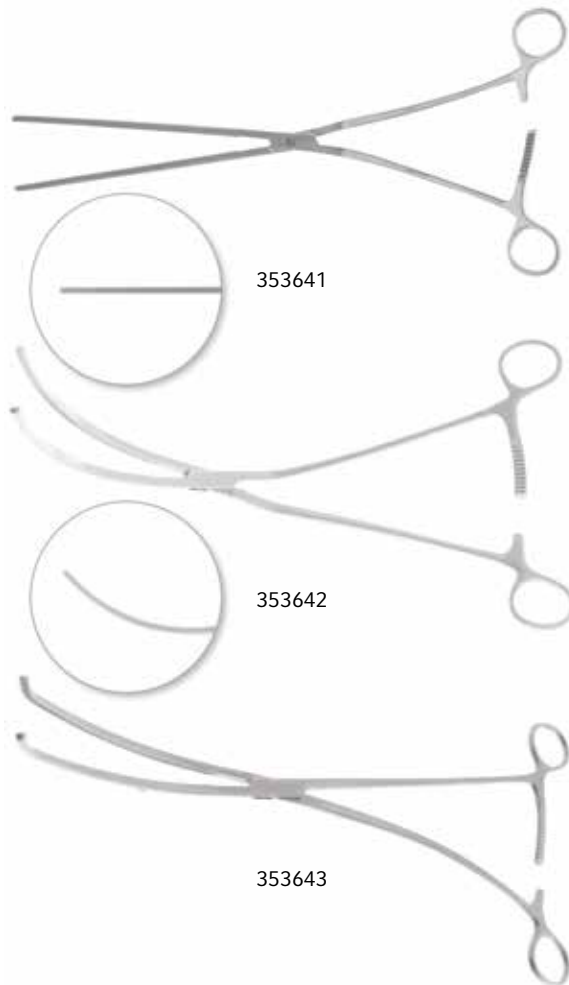

353641

353642

353643

CATALOG #	DESCRIPTION
353641	Straight jaw, 6-3/8" (16 cm), 13-1/2" (34 cm)
353642	Curved jaw, angled handle, 12-7/8" (32.5 cm)
353643	"S" curve, angled tip, 13-5/8" (34.5 cm)



VASCULAR CLAMPS

Aortic Aneurysm Clamps

DEBAKEY® AORTA CLAMP

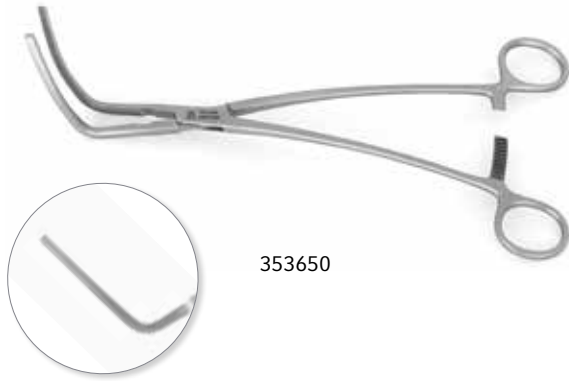

353650

Jaws angled on flat and spoon-shaped. This clamp with DeBakey®-type Jaws may be used for both the abdominal aorta and the thoracic aorta for temporary occlusion during performance of resection and graft replacement. The specially angled jaw permits convenient application of the clamp in such a manner as to maintain the handles of the clamp away from the field of operation.

CATALOG #	DESCRIPTION
353650	Angled on flat and spoon-shaped, 2-1/2" (6.5 cm) jaw, 1 x 11 ratchets, 10-1/4" (26 cm)



VASCULAR CLAMPS

Aortic Aneurysm Clamps

DEBAKEY® AORTIC ANEURYSM CLAMPS

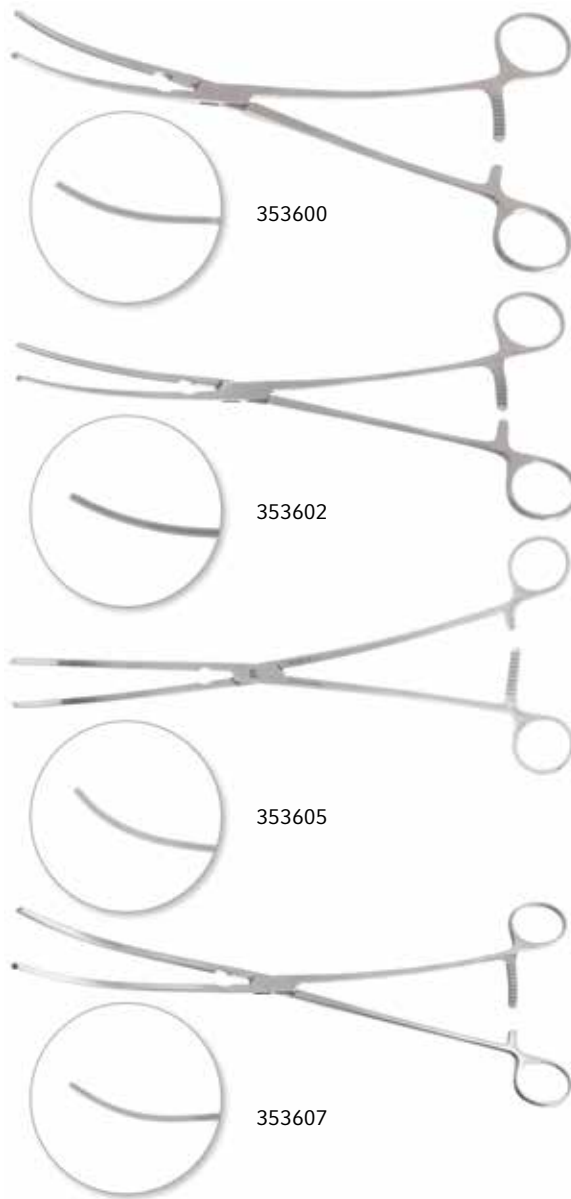

DeBakey®-type Jaws. For occlusion of the neck of sacciform aneurysms of the aorta in tangential excision of such aneurysms and subsequent aortography. Also for temporary occlusion of the aorta in resection of fusiform aneurysms of the aorta and restoration of continuity by aortic grafts.

CATALOG #	DESCRIPTION
353600	3-3/4" (9.5 cm) jaw, 1 x 9 ratchets, 10-3/8" (26.5 cm)
353602	4" (10 cm) jaw, 1 x 9 ratchets, 10-7/8" (27.5 cm)
353605	4-7/8" (12.5 cm) jaw, 1 x 11 ratchets, 12-1/2" (32 cm)
353607	5-3/4" (14.5 cm) jaw, 1 x 11 ratchets, 13-1/4" (33.5 cm)

VASCULAR CLAMPS

Aortic Aneurysm Clamps

DEBAKEY® CURVED CLAMPS

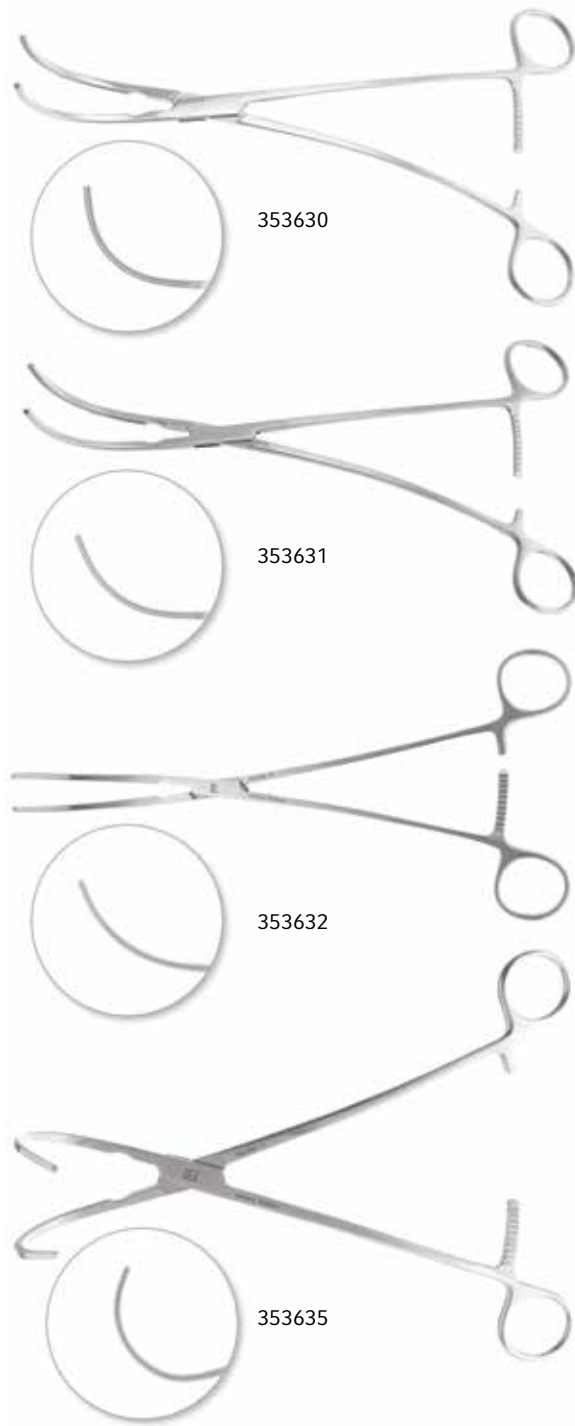

These matched instruments are useful in a wide variety of situations but were originally designed to temporarily occlude the iliac artery just distal to the aorta in resection of aneurysms of the abdominal aorta involving bifurcation. DeBakey®-type Jaws.

CATALOG #	DESCRIPTION
353630	Acutely curved, 1-1/4" (3.5 cm) jaw, spring handle, 1 x 11 ratchets, 9-5/8" (24.5 cm)
353631	Medium curved, Bahnson type, 1-1/4" (3 cm) jaw, spring handle, 1 x 9 ratchets, 10-1/8" (25.5 cm)
353632	Slightly curved, Bahnson type, 1-1/4" (3 cm) jaw, spring handle, 1 x 9 ratchets, 10-3/8" (26 cm)
353635	Extra-large, acutely curved, 2-1/2" (6.5 cm) jaw, 1 x 11 ratchets, 10-3/8" (26 cm)



VASCULAR CLAMPS

Aortic Aneurysm Clamps

DEBAKEY® FULL CURVED AORTIC ANEURYSM CLAMPS



DeBakey®-type Jaws. More acutely curved in both jaw and handle sections than aortic clamps 353600 to 353607. For occlusion of the neck of sacciform aneurysms of the aorta in tangential excision of such aneurysms and subsequent aortography. Also for temporary occlusion of the aorta in resection of fusiform aneurysms of the aorta in resection and restoration of continuity by aortic grafts.

CATALOG #	DESCRIPTION
353625	2-1/8" (5.5 cm) jaw, 9-1/2" (24 cm)
353626	11-1/8" (28.5 cm)
353627	2-1/4" (5.5 cm) jaw, 12-1/2" (31.5 cm)

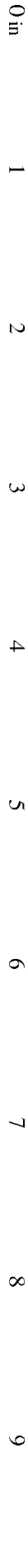

VASCULAR CLAMPS

Aortic Aneurysm Clamps

GRANT ABDOMINAL AORTIC ANEURYSM CLAMPS, "TEXAS TWISTER"

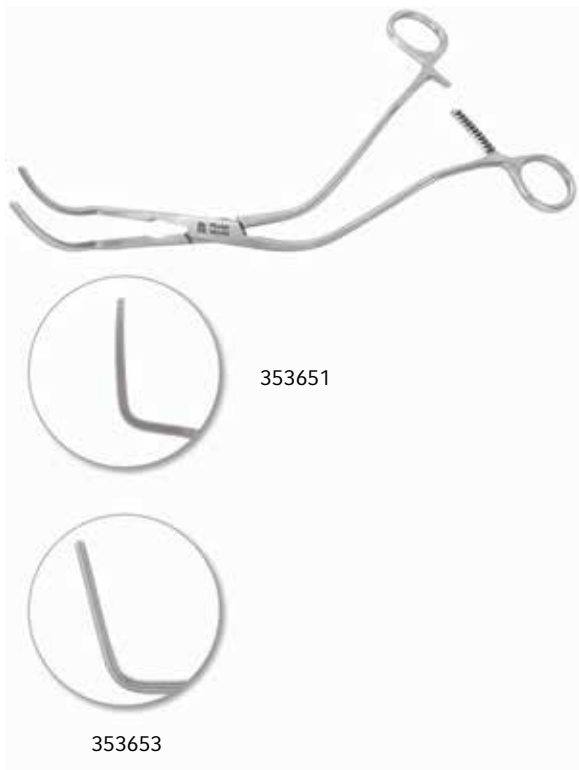

Unique design allows lateral cross clamping of aorta. On thin patients the multi-angled handle can be conveniently placed over left wound margin. In the heavy or obese patient, handles can be tucked under abdominal wall. Wide, secure, 2 x 3 DeBakey®-type Jaws, 1 x 11 ratchets for gradual declamping and graft flushing.

CATALOG #	DESCRIPTION
353651	Curved, 2-5/8" (6.5 cm) jaw, 7-7/8" (20 cm)
353653	Short, 2-1/8" (5.5 cm) jaw, 9-1/4" (23.5 cm)

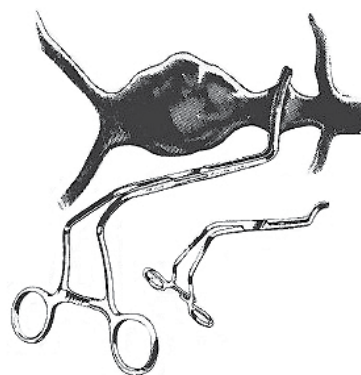

HOWARD-DEBAKEY® AORTIC ANEURYSM CLAMPS

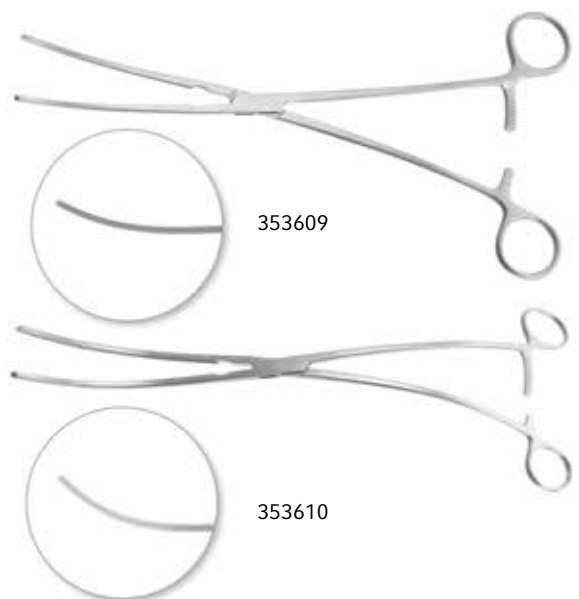

Reverse curve shafts, 1 x 9 ratchets, DeBakey®-type Jaws.

CATALOG #	DESCRIPTION
353609	1 x 2, 4-1/8" (10.5 cm) jaws, 10-3/4" (27.5 cm)
353610	2 x 3, 4" (10.5 cm) jaws, 12-1/2" (32 cm)

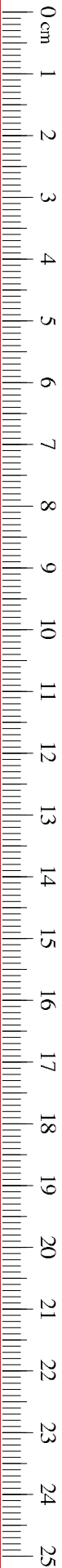

VASCULAR CLAMPS

Aortic Aneurysm Clamps

WYLIE ABDOMINAL AORTA CLAMP

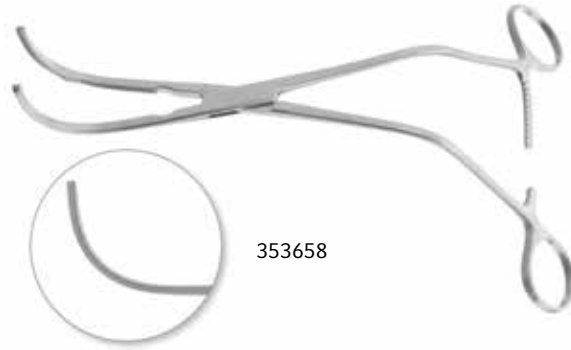

353658

CATALOG #	DESCRIPTION
353658	DeBakey®-type Jaws, 8-1/2" (21.5 cm)

ZANGER ABDOMINAL AORTA CLAMPS

Acutely curved handle, 1 x 9 ratchets.

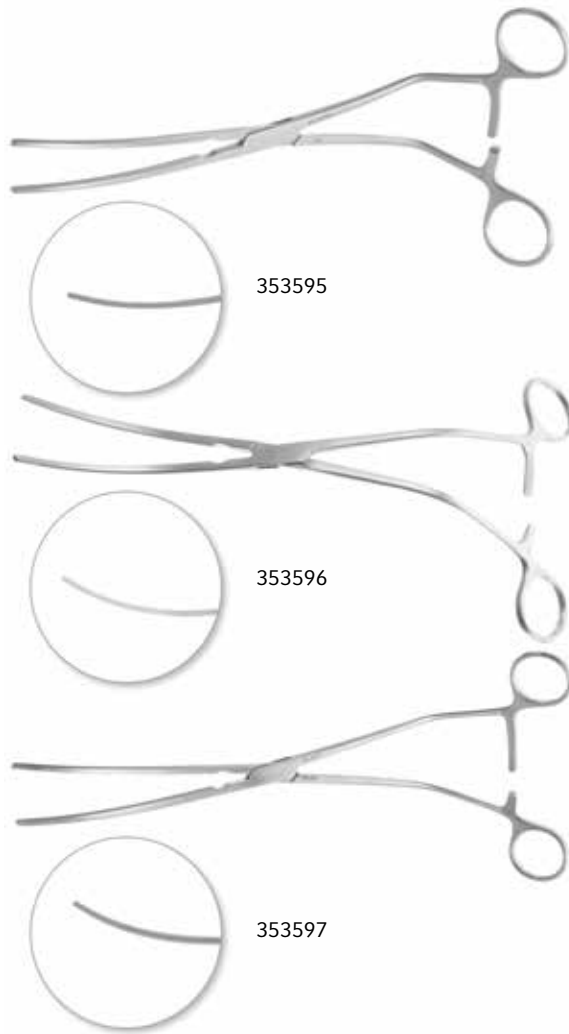

353595

353596

353597

CATALOG #	DESCRIPTION
353595	8-1/8" (20.5 cm)
353596	9-3/4" (25 cm)
353597	11-1/4" (28.5 cm)



VASCULAR CLAMPS

Aortic Aneurysm Clamps

PILLING RATCHET LOCK



354320

CATALOG #	DESCRIPTION
354320	Slips on the ratchets of most standard size cardiac clamps. Prevents ratchet from accidentally becoming disengaged and from springing open.

Aortic Compressor

CONN AORTIC COMPRESSOR



351715

A simple device used to gain initial control of the proximal circulation in suspected or known rupture of abdominal aortic aneurysms. Designed to allow surgeon additional time to dissect and cross clamp aorta.

CATALOG #	DESCRIPTION
351715	Compressor head 3-1/8" (8 cm) wide, overall length 15-1/2" (39.5 cm)

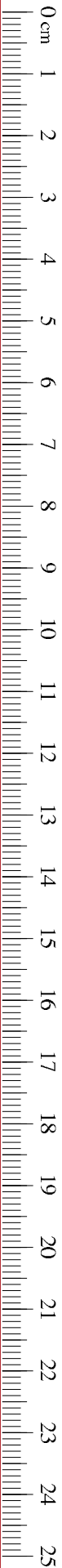

SCISSORS

Potts-Style Scissors

BEALL CIRCUMFLEX ARTERY SCISSORS

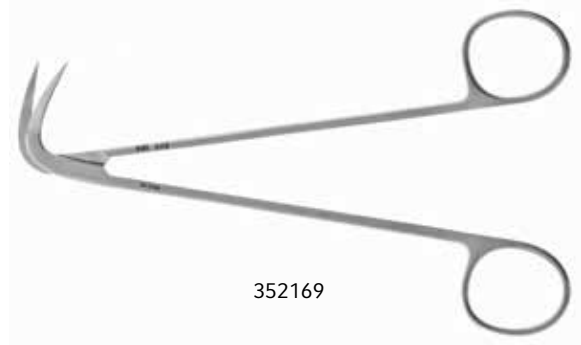

CATALOG #	DESCRIPTION
352169	Angled 110 degrees, delicate, 15 mm blades, 6" (15 cm)



SCISSORS

Potts-Style Scissors

BEALL MICRO CORONARY SCISSORS

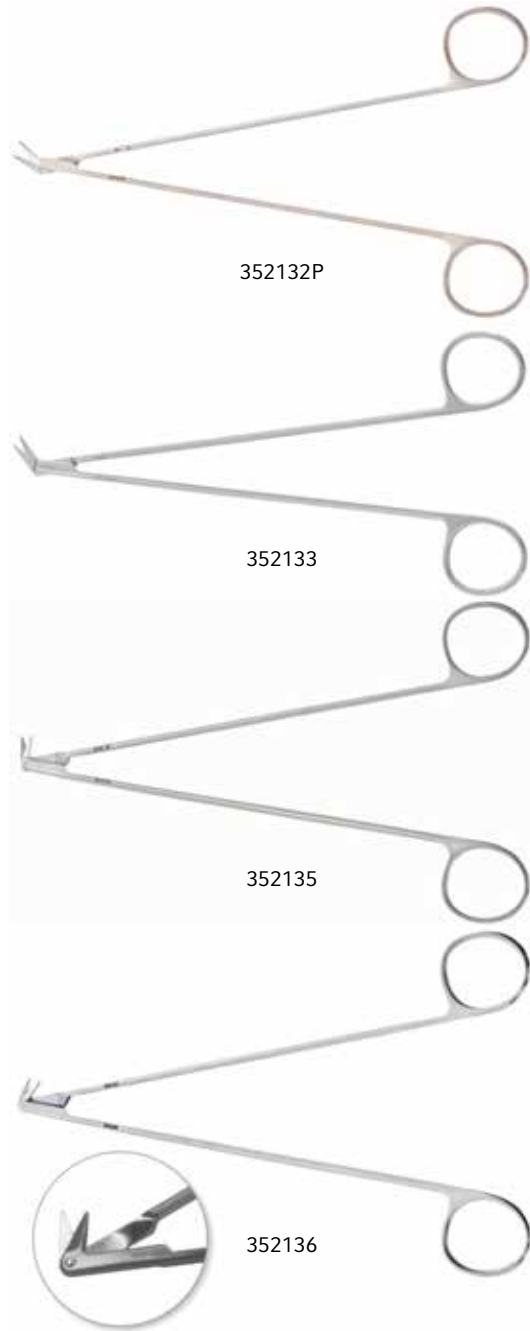

Delicately tapered shanks, thin narrow blades with micro blunt tips. Available in five angles. The 8-10 mm length blade is approximately 1/2 the length of common coronary artery scissors. This allows the surgeon to prepare smaller, more precise arteriotomy on the host coronary artery as an IMA grafting.

CATALOG #	DESCRIPTION
352132P	Angled 25 degrees, 8 mm blades, 7" (18 cm)
352133	Angled 45 degrees, 10 mm blades, 7" (18 cm)
352134	Angled 60 degrees, 10 mm blades, 6-7/8" (17.5 cm)
352135	Angled 90 degrees, 8 mm blades, 6-3/4" (17 cm)
352136	Angled 120 degrees, 10 mm blades, 6-3/4" (17 cm)



SCISSORS

Potts-Style Scissors

DEBAKEY® POTTS SCISSORS



CATALOG #	DESCRIPTION
352187	Angled 60 degrees, 25 mm blades, 6-1/4" (16 cm)



SCISSORS

Potts-Style Scissors

DEBAKEY® VASCULAR SCISSORS

Angled to the side. A lightweight, round pattern scissors with blunted tip blades. Supplied in 3 angles.

CATALOG #	DESCRIPTION
352173	45 degrees, 25 mm blades, 6-1/2" (16.5 cm), TC
352174	60 degrees, 25 mm blades, 6-1/4" (16 cm), TC
352177	60 degrees, 25 mm blades, 8-5/8" (22 cm), TC
352185	25 degrees, 25 mm blades, 6-5/8" (17 cm)
352191	45 degrees, 25 mm blades, 8-7/8" (22.5 cm)
352196	45 degrees, 25 mm blades, 11-1/8" (28 cm)
352197	60 degrees, 32 mm blades, 10-7/8" (27.5 cm)



352173



352177



352185

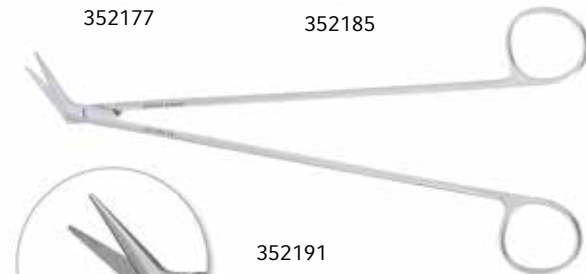

352191



352196



352197



SCISSORS

Potts-Style Scissors

DEBAKEY®-POTTS SCISSORS

Angled to side. A delicate modification of the Potts Scissors supplied in various angles for use in coronary artery surgery.

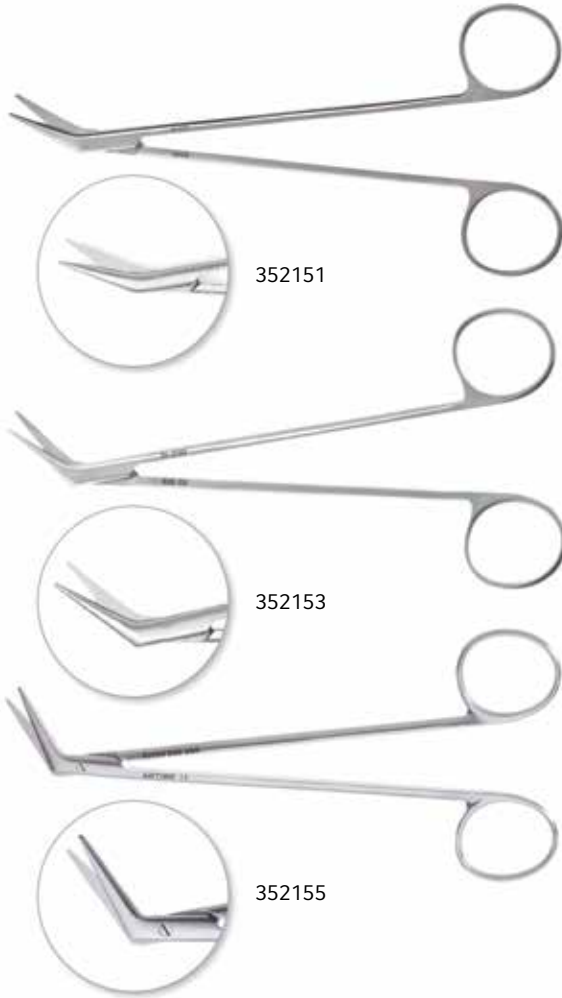

CATALOG #	DESCRIPTION
352151	Angled 20 degrees, 23 mm blades, 6-5/8" (17 cm)
352153	Angled 45 degrees, 20 mm blades, 6-1/2" (16.5 cm)
352155	Angled 60 degrees, 23 mm blades, 6-1/4" (16 cm)

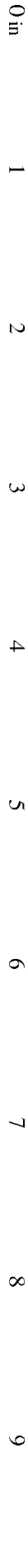

SCISSORS

Potts-Style Scissors

PILLING® CORONARY POTTS SCISSORS

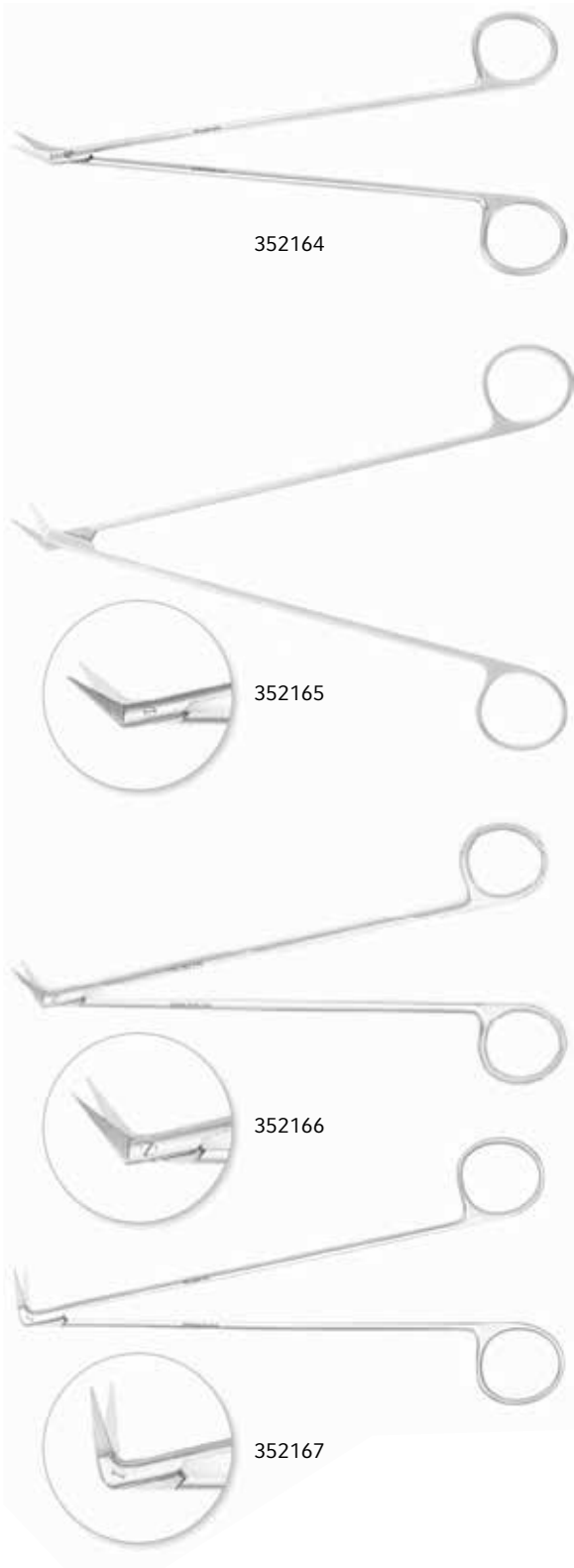

Designed for extending and tailoring coronary arteriotomies. Thin, narrow blades with microscopically blunt tips. Delicately tapered shanks. Available in 5 angles – 25, 45 and 60 degrees for L.A.D., and 90 and 120 degrees for less accessible sites on right and left circumflex.

CATALOG #	DESCRIPTION
352164	Angled 25 degrees, 16 mm blades, 7-1/8" (18 cm)
352165	Angled 45 degrees, 16 mm blades, 7" (18 cm)
352166	Angled 60 degrees, 16 mm blades, 7" (18 cm)
352167	Angled 90 degrees, 15 mm blades, 6-3/4" (17 cm)
352168	Angled 120 degrees, 16 mm blades, 6-3/4" (17 cm)
352178	Angled 120 degrees, 13 mm blades, 7" (18 cm)

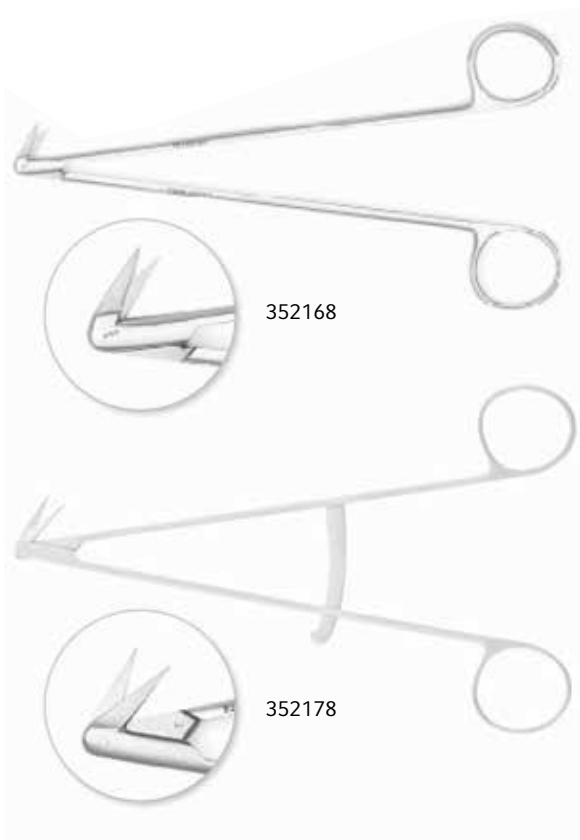



SCISSORS

Potts-Style Scissors

DIETHRICH DELICATE ANGLED CORONARY SCISSORS

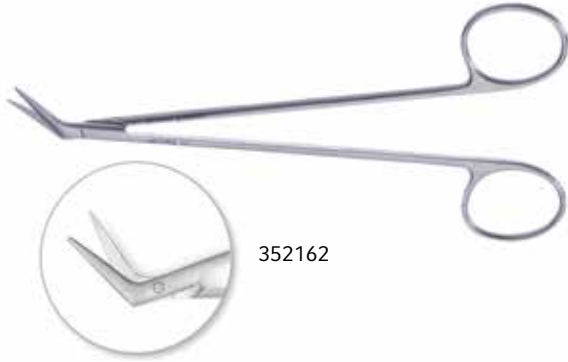

352162

CATALOG #	DESCRIPTION
352162	Angled 45 degrees, 15 mm blades, 6-1/4" (16 cm)

DIETHRICH-POTTS VASCULAR SCISSORS

Short blades, semi-sharp tips.



352146

CATALOG #	DESCRIPTION
352146	Angled 25 degrees, 15 mm blades, 5-1/2" (14 cm)
352147	Angled 45 degrees, 15 mm blades, 5-3/8" (13.5 cm)
352148	Angled 60 degrees, 5-1/4" (13.5 cm)
352149	Angled 90 degrees, 15 mm blades, 5" (12.5 cm)



352147



352148



352149



SCISSORS

Potts-Style Scissors

MICRO VASCULAR SCISSORS



357690



357691

CATALOG #	DESCRIPTION
357690	Angled 45 degrees, 7 mm blades, 6-1/2" (16.5 cm)
357691	Angled 120 degrees, 7 mm blades, 6-1/2" (16.5 cm)

POTTS SCISSORS



352140

CATALOG #	DESCRIPTION
352140	Angled 60 degrees, 25 mm blades, 3-3/4" (9.5 cm)



SCISSORS

Potts-Style Scissors

POTTS SMITH SCISSORS



352150



352170

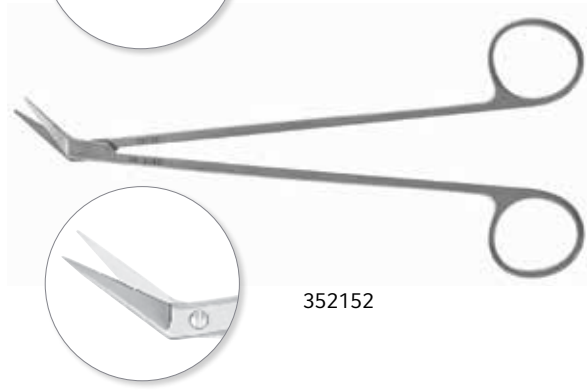

352152

Angled to side. Pilling® Pattern, satin finish.

CATALOG #	DESCRIPTION
352150	Angled 25 degrees, 25 mm blades, 7-1/2" (19 cm)
352170	Angled 25 degrees, 19 mm blades, 7-1/2" (19 cm), TC
352152	Angled 45 degrees, 23 mm blades, 7-1/4" (18.5 cm)
352171	Angled 45 degrees, 19 mm blades, 7-1/4" (18.5 cm), TC
352154	Angled 60 degrees, 23 mm blades, 7" (18 cm)



352171

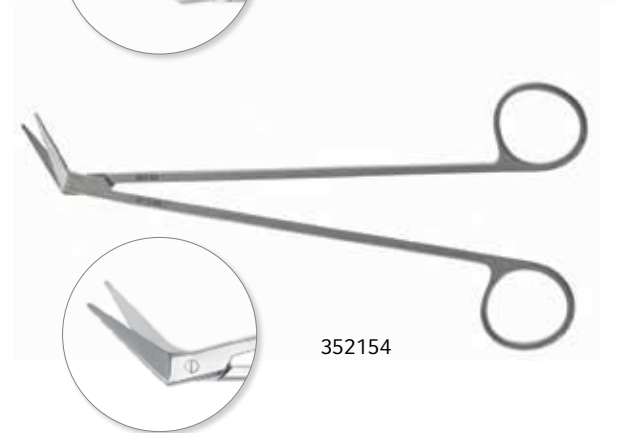

352154



SCISSORS

Potts-Style Scissors

POTTS SMITH VASCULAR SCISSORS

Standard, angled blades. Weck® Pattern, bright finish.

CATALOG #	DESCRIPTION
640210	Angled 25 degrees, 7" (18 cm)
640212	Angled 45 degrees, 7" (18 cm)
640214	Angled 60 degrees, 7" (18 cm)
640216	Angled 130 degrees, 6-3/4" (17 cm)
640225	Angled 25 degrees, 18 mm blades, 7-1/2" (19 cm)
640245	Angled 45 degrees, 18 mm blades, 7-1/4" (18.5 cm)
640260	Angled 60 degrees, 22 mm blades, 7" (18 cm)



640210



640212

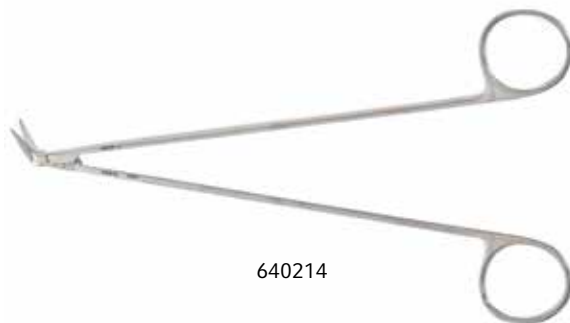

640214

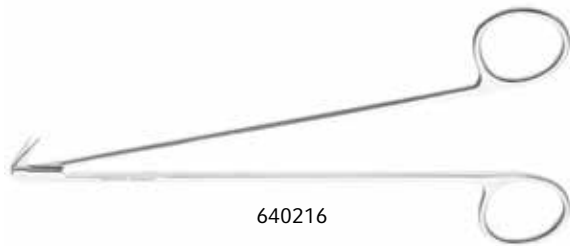

640216

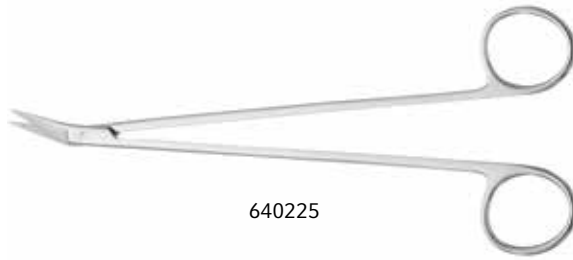

640225



640245

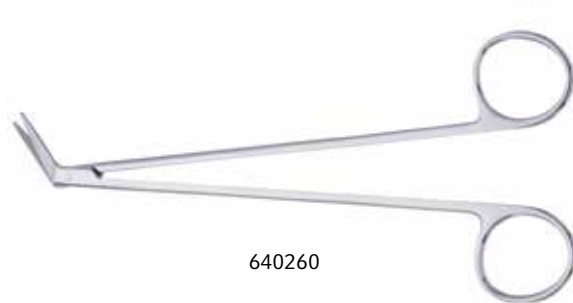

640260



SCISSORS

Potts-Style Scissors

YASARGIL VASCULAR SCISSORS



CATALOG #	DESCRIPTION
357594	Bayonet, angled 45 degrees, 10 mm blades, 7-1/2" (19 cm)
357595	Bayonet, reverse angled 125 degrees, 12 mm blades, 7-1/4" (18.5 cm)
357622	Straight, 12 mm blades, 7" (18 cm)

YOU-POTTS VASCULAR SCISSORS

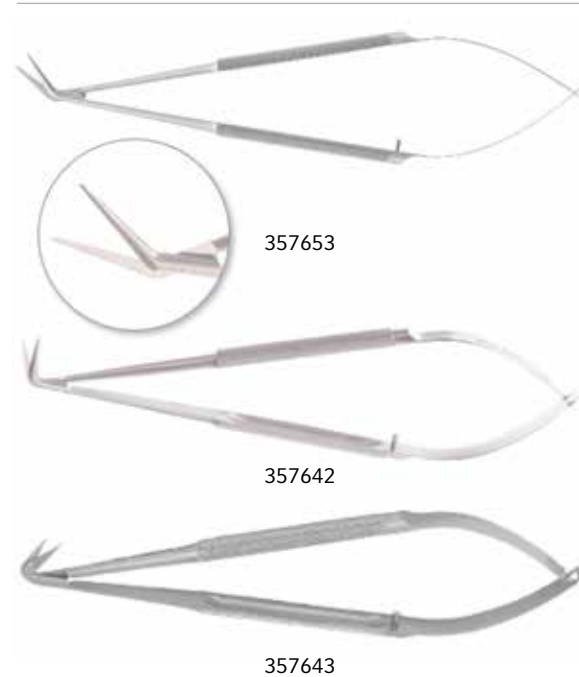

Narrow, thin blade and round spring handles designed for a more precise and controlled arteriotomy.

CATALOG #	DESCRIPTION
357653	Angled 45 degrees, 12 mm blades, 7-3/8" (18.5 cm)
357642	Angled 90 degrees, 14 mm blades, 7" (18 cm)
357643	Angled 120 degrees, 12 mm blades, 7" (18 cm). Designed for the circumflex artery.

SCISSORS

Vascular and Cardiac Scissors

BAKST CARDIAC SCISSORS



352232

A finely balanced dissecting scissors that can be used interchangeably in all endothoracic dissections. Blades curved to side.

CATALOG #	DESCRIPTION
352232	Curved, 7" (18 cm)

DEBAKEY® ENDARTERECTOMY SCISSORS



352180

A specially made, round pattern scissors with blades that taper to blunt tips, tempered for proper rigidity and sharpness despite their light weight. Blades curved to side.

CATALOG #	DESCRIPTION
352180	Slightly curved, 7" (18 cm)
352181	Acutely curved, 6-7/8" (17.5 cm)
352183	Slightly curved, 7" (18 cm), TC
352184	Acutely curved, 7" (18 cm), TC

DEBAKEY® SCISSORS



342166

Sturdy Metzenbaum-type scissors. Black rings for quick identification.

CATALOG #	DESCRIPTION
342160	Curved, 5-3/4" (14.5 cm), TC
342162	Curved, 7" (18 cm), TC
342166	Curved, 9-1/8" (23 cm), TC
342167	Curved, 10-1/4" (26 cm), TC
342168	Curved, 11-1/4" (28.5 cm), TC
342169	Curved, 12" (30.5 cm), TC

SCISSORS

Vascular and Cardiac Scissors

DEBAKEY® VALVE SCISSORS



Heavy construction.

CATALOG #	DESCRIPTION
352199	Acutely curved, 7-3/4" (19.5 cm)

DEBAKEY®-METZENBAUM DISSECTING SCISSORS



Curved blades. These scissors are proportionately matched in weight.

CATALOG #	DESCRIPTION
342200	Curved, 5-7/8" (15 cm)
342201	Curved, 7" (18 cm)
342202	Curved, 8-1/8" (20.5 cm)
342203	Curved, 9-1/8" (23 cm)
342204	Curved, 10-1/4" (26 cm)
342206	Curved, 12-1/4" (31 cm)

FERGUSON LONG DISSECTING SCISSORS



Metzenbaum-type blades. Strong but delicate scissors with rounded tips useful in any deep dissection.

CATALOG #	DESCRIPTION
342275	10-1/4" (26 cm)



SCISSORS

Vascular and Cardiac Scissors

HAIMOVICI SCISSORS



A delicate, acutely curved scissors.

CATALOG #	DESCRIPTION
352297	5-1/4" (13.5 cm)
352298	10" (25.5 cm)

JAMISON-METZENBAUM TENOTOMY SCISSORS



The standard Metzenbaum-style Curved Blades have specially narrowed tenotomy-type distal tips.

CATALOG #	DESCRIPTION
342220	6" (15 cm)
342221	7" (18 cm)
342222	8" (20.5 cm)
342223	9" (23 cm)

SCISSORS

Vascular and Cardiac Scissors

OFFSET METZENBAUM SCISSORS

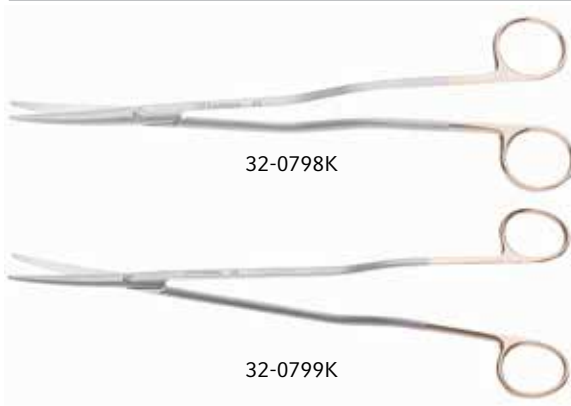

CATALOG #	DESCRIPTION
32-0798K	9" (23 cm)
32-0799K	11" (28 cm)

POTTS SMITH DISSECTING SCISSORS



Curved, 48 mm blades.

CATALOG #	DESCRIPTION
640200	Curved, 7-1/2" (19 cm)
640205	Curved, 9-1/8" (23 cm)

POTTS TENOTOMY SCISSORS



CATALOG #	DESCRIPTION
640280	Curved, 29 mm blades, 6" (15 cm)



SCISSORS

Vascular and Cardiac Scissors

REVUELTA-GARCIA VALVE SCISSORS



CATALOG #	DESCRIPTION
351745	Angled shanks, 10-7/8" (27.5 cm)

SATINSKY SCISSORS



For excision of a portion of the inferior vena cava prior to anastomosis with other vessels.

CATALOG #	DESCRIPTION
352295	9-3/4" (25 cm)

STRULLY PROBED TIP SCISSORS



CATALOG #	DESCRIPTION
462530	Curved, 25 mm blades, 8" (20.5 cm)



SCISSORS

Vascular and Cardiac Scissors

JACOBSON VASCULAR SCISSORS

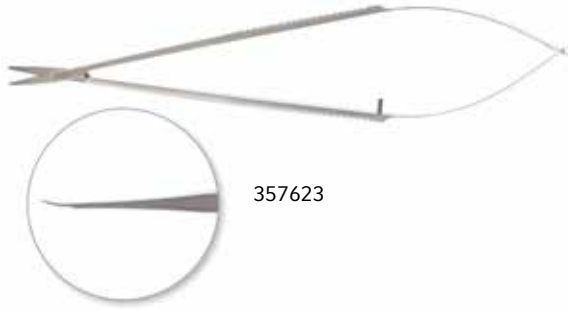

357623

CATALOG #	DESCRIPTION
357623	Curved, 12 mm blades, 7" (18 cm)

MICRO VASCULAR ANASTOMOSIS SCISSORS



357651

Round handle, 8 mm diameter.

CATALOG #	DESCRIPTION
357651	Straight, 12 mm blades, 7-3/8" (19 cm)
357652	Curved, 12 mm blades, 7-1/4" (18.5 cm)



357652

NEUROFEEL MICRO SCISSORS



395115

Bayonet with flat handle. Delicate, 5 mm micro blades.

CATALOG #	DESCRIPTION
395115	Curved blade, 7-1/4" (18.5 cm)
395128	Straight blade, 8-1/4" (21 cm)



SCISSORS

Vascular and Cardiac Scissors

MCCLURE IRIS SCISSORS



Angled on flat for increased control and visibility.

CATALOG #	DESCRIPTION
352144	Angled on flat, 12 mm blades, 4-1/2" (11.5 cm)

CASTROVIEJO SCISSORS



Spring handle for maximum control.

CATALOG #	DESCRIPTION
352145	Angled 45 degrees, 9 mm blades, 4-1/8" (10.5 cm)

Venous Valve

VENOUS VALVE SCISSORS

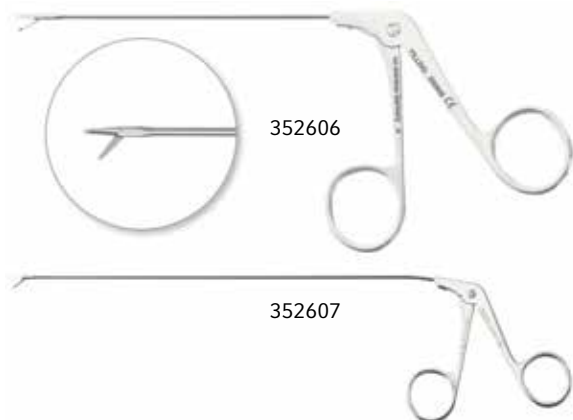

CATALOG #	DESCRIPTION
352606	4" (10 cm) scissors have ball tip to help minimize damage to the intima of the vein
352607	9-1/4" (23.5 cm)

CVT NEEDLE HOLDERS

Pilling® Technique® Design

Teleflex® takes great pride in presenting our line of finely crafted Pilling® Technique® Instruments. Technique® Instruments offer the balance, precision and craftsmanship you demand, assuring high quality instrument performance. All are easily identified by our signature black handle design.

BAILEY CARDIAC TECHNIQUE® NEEDLE HOLDER



Very light construction throughout with fine, tapered tips. Jaws are lightly scored for use with smallest size needles and sutures. Tungsten Carbide.

CATALOG #	DESCRIPTION
354931	17 x 2 mm jaw, 7" (18 cm), TC

DEBAKEY TECHNIQUE® NEEDLE HOLDERS

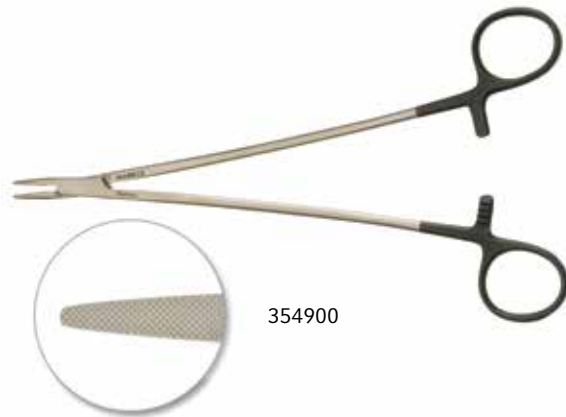

Carefully designed with light, short Tungsten Carbide jaws. Constructed in weight proportional to total length. May be purchased individually or as matched set of four.

CATALOG #	DESCRIPTION
354900	No. 1. Length, 18.2 x 2 mm jaw, 7" (18 cm), TC
354902	No. 2. Length, 21.5 x 1.8 mm jaw, 9-1/4" (23.5 cm), TC
354904	No. 3. Length, 21.5 x 2.3 mm jaw, 10-1/2" (26.5 cm), TC
354906	No. 4. Length, 19 x 2.6 mm jaw, 11-3/4" (30 cm), TC
354908	Matched set of four



CVT NEEDLE HOLDERS

Pilling® Technique® Design

GERBODE TECHNIQUE® NEEDLE HOLDER



343000

Medium-light construction. A strong full sized needle holder with jaws tapered to 2 mm width for holding fine needles.

CATALOG #	DESCRIPTION
343000	16.5 x 2 mm jaw, 10-1/2" (26.5 cm), TC

HOWELL CORONARY TECHNIQUE® NEEDLE HOLDER



354920

CATALOG #	DESCRIPTION
354920	14 x 1.6 mm jaw, 7-1/4" (18.5 cm), TC

HOWELL VALVE TECHNIQUE® NEEDLE HOLDER

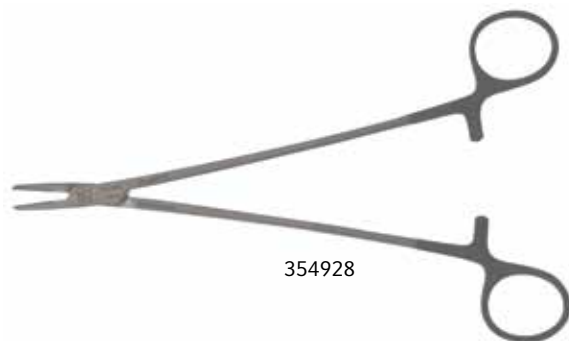

354928

CATALOG #	DESCRIPTION
354928	19 x 2 mm jaw, 8" (20.5 cm), TC

CVT NEEDLE HOLDERS

Pilling® Technique® Design

JAMISON TECHNIQUE® NEEDLE HOLDER



Long, slender needle holder. Jaws are lightly serrated.

CATALOG #	DESCRIPTION
354941	19.8 x 1.8 mm jaw, 9" (23 cm), TC

PILLING® EXTRA LIGHT TECHNIQUE® NEEDLE HOLDERS



Thinner shanks and box-locks than Pilling® Thin Needle Holders (opposite page) for reduced weight and more "feel."

CATALOG #	DESCRIPTION
354981	17 x 1.8 mm jaw, 6" (15 cm), TC
354982	17.5 x 1.6 mm jaw, 7" (18 cm), TC

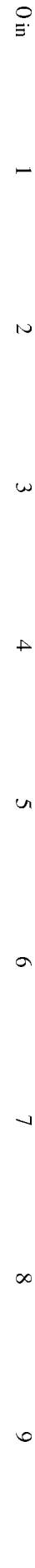

CVT NEEDLE HOLDERS

Pilling® Technique® Design

PILLING® INTRACARDIAC TECHNIQUE® NEEDLE HOLDERS



CATALOG #	DESCRIPTION
354985	17 x 1.8 mm jaw, 7" (18 cm), TC
354986	11.5 x 1.6 mm jaw, 8" (20.5 cm), TC
354987	20.5 x 2 mm jaw, 9-1/4" (23.5 cm), TC
354988	20.5 x 2 mm jaw, 10-1/4" (26 cm), TC

PILLING® THIN VASCULAR AND CORONARY TECHNIQUE® NEEDLE HOLDERS



Delicately proportioned, slender needle holders.

CATALOG #	DESCRIPTION
354958	20.5 x 1.8 mm jaw, 9" (23 cm), TC
354959	20.5 x 2.2 mm jaw, 10-1/4" (26 cm), TC
354960	16 x 1.8 mm jaw, 6" (15 cm), TC
354961	16 x 1.7 mm jaw, 7" (18 cm), TC
354962	20 x 1.8 mm jaw, 8-1/4" (21 cm), TC

CVT NEEDLE HOLDERS

Pilling® Technique® Design

RYDER EXTRA FINE TECHNIQUE® NEEDLE HOLDERS



Pilling® Pattern, satin finish. Sculptured 1 mm wide jaws designed for the finest vascular, plastic and nerve suture needles. Lightweight throughout (average weight 1 oz).

CATALOG #	DESCRIPTION
354990	11.5 x 1.3 mm jaw, 5-1/4" (13.5 cm), TC
354992	12.5 x 1.2 mm jaw, 6" (15 cm), TC
354994	14.3 x 1.2 mm jaw, 7" (18 cm), TC
354996	14.5 x 1.2 mm jaw, 8" (20.5 cm), TC
354998	15 x 1.3 mm jaw, 9" (23 cm), TC

W.M. LEMMON TECHNIQUE® NEEDLE HOLDERS

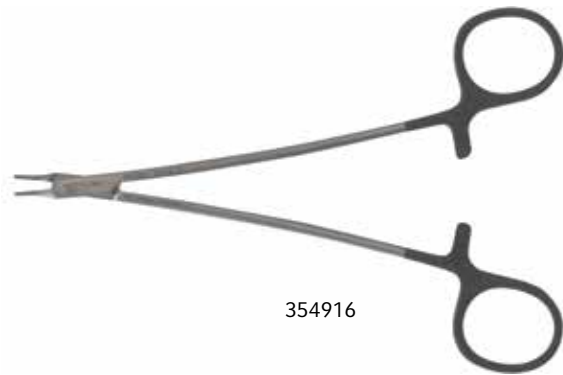

Delicate, very lightly serrated, 4 mm tapering to 1.5 - 2 mm tips, 13 mm long. The medium size was designed specifically for repair of the femoral arteriotomy site with fine sutures following completion of the by-pass.

CATALOG #	DESCRIPTION
354915	Delicate, 15.5 x 2.3 mm jaw, 5-3/4" (14.5 cm), TC
354916	14.5 x 1.5 mm jaw, 6-3/4" (17 cm), TC
354917	15.5 x 2.3 mm jaw, 7-1/2" (19 cm), TC

CVT NEEDLE HOLDERS

Pilling® Technique® Design

GREGORY TECHNIQUE® SUTURE "STAY" CLAMPS



Smooth jaw hemostats for tagging sutures. May be used with or without rubber shodding.

CATALOG #	DESCRIPTION
351830	Straight, 3-7/8" (10 cm), TC
351831	Curved, 3-7/8" (10 cm), TC

GIANNINI TECHNIQUE® NEEDLE HOLDER



Flat handles.

CATALOG #	DESCRIPTION
354971	Straight, 17.5 x 1.8 mm jaw, 10-1/4" (26 cm), TC

0 in

1

2

3

4

5

6

7

8

9

CVT NEEDLE HOLDERS

Pilling® Technique® Design

MICRO SURGERY TECHNIQUE® NEEDLE HOLDERS

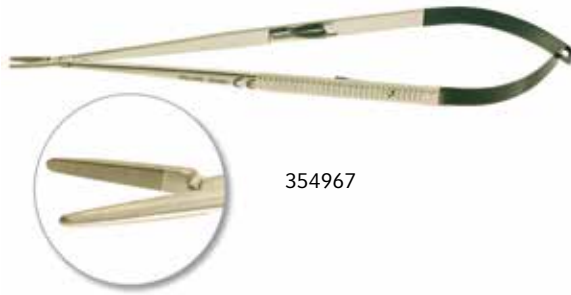

Flat handle, smooth jaws.

CATALOG #	DESCRIPTION
354966	Straight, 13 x 1.4 mm jaw, 7" (18 cm), TC
354967	Straight, 13 x 1.4 mm jaw, 8" (20.5 cm), TC

CASTROVIEJO TECHNIQUE® NEEDLE HOLDERS



CATALOG #	DESCRIPTION
354964	Straight, 13 x 1.4 mm jaw, 7-1/4" (18.5 cm), TC
354965	Straight, 13 x 1.4 mm jaw, 8" (20.5 cm), TC

SPENCER CORONARY TECHNIQUE® NEEDLE HOLDER



CATALOG #	DESCRIPTION
354969	Straight, smooth, 12 x 1.2 mm jaw, 0.9 mm tip, 7" (18 cm), TC

CVT NEEDLE HOLDERS

Castro-Type Micro Needle Holders

CASTROVIEJO MICRO NEEDLE HOLDERS



355558DG

Fine, straight, with round handle and lock. 1 mm Diama-Grip jaws.

CATALOG #	DESCRIPTION
355558DG	9" (23 cm)
355559DG	10" (25.5 cm)
355560DG	12" (30.5 cm)

CASTROVIEJO MICRO NEEDLE HOLDERS



357676DG

Round handle with Diama-Grip jaws.

CATALOG #	DESCRIPTION
357656DG	Straight, with lock, 1.2 mm, 7" (18 cm)
357676DG	Straight, with lock, 1.2 mm, 8" (20.5 cm)
357677DG	Curved, without lock, 1 mm, 8" (20.5 cm)

CASTROVIEJO NEEDLE HOLDERS



354964DG

Straight, with flat handle and lock. Diama-Grip jaws.

CATALOG #	DESCRIPTION
354972	Straight, 11.5 x 0.8 mm Diama-grip jaw, 6" (15 cm)
354973	Curved, 11.5 x 1 mm Diama-grip jaw, 6" (15 cm)
354974	Straight, 0.8 mm wide Diama-grip jaw, 7-1/4" (18.5 cm)
354964DG	Straight, 1.8 mm jaw, 7-1/4" (18.5 cm)
354965DG	Straight, 8" (20.5 cm)
354975	Straight, 0.7 mm wide Diama-grip jaw, 8-1/4" (21 cm)

CASTROVIEJO NEEDLE HOLDERS

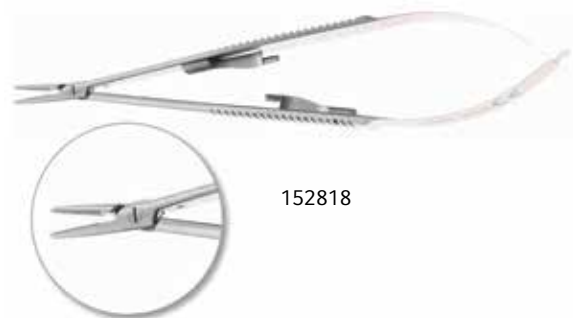

152818

CATALOG #	DESCRIPTION
152818	Straight, 11 x 1.4 mm jaw, 6" (15 cm), TC
152819	Curved, 12 x 1.4 mm jaw, 5-3/4" (14.5 cm), TC



CVT NEEDLE HOLDERS

Castro-Type Micro Needle Holders

JACOBSON MICRO NEEDLE HOLDER



357603DG

CATALOG #	DESCRIPTION
357603DG	Straight with flat handle, lock, 18 x 1.3 mm Diamo-Grip jaw, 8-1/2" (21.5 cm)

JACOBSON MICRO NEEDLE HOLDERS

Straight, round handle with lock. Diamo-Grip jaws.



358001

CATALOG #	DESCRIPTION
358001	11 x 0.8 mm jaw, 9" (23 cm)
358002	1.8 mm jaw, 9" (23 cm)
358003	16 x 0.9 mm jaw, 8-1/4" (21 cm)



358002



358003

CVT NEEDLE HOLDERS

Castro-Type Micro Needle Holders

JACOBSON MICRO-SURGICAL NEEDLE HOLDERS



357603

Smooth, straight, stainless steel jaws with Castroviejo-type Lock and flat handles. Lock can be removed if not required.

CATALOG #	DESCRIPTION
357601	13 x 1.3 mm jaw, 7" (18 cm)
357603	13.5 x 1.2 mm jaw, 8-1/2" (21.5 cm)

MICRO SURGERY NEEDLE HOLDERS

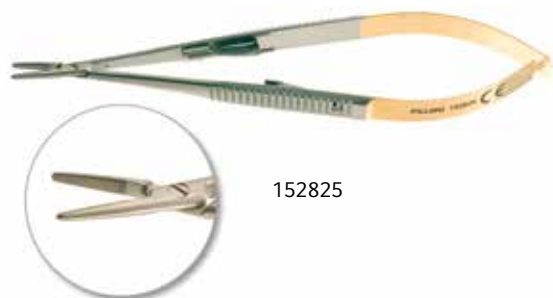

152825

Flat handle, smooth jaws.

CATALOG #	DESCRIPTION
152825	Straight, 12.5 x 1.4 mm jaw, 6" (15 cm), TC
152827	Curved, 13 x 1.4 mm jaw, 6" (15 cm), TC

MICRO VASCULAR ROUND HANDLE NEEDLE HOLDERS



357656

357657

Stainless steel jaws, round handles. Smooth jaws.

CATALOG #	DESCRIPTION
357667	Straight, 7-3/8" (18.5 cm), TC
357672	Straight, 0.6 mm smooth jaw, 8-1/8" (20.5 cm)
357674	Straight, 0.6 mm smooth jaw, 9" (23 cm)
357675	Curved, 0.6 mm smooth jaw, 9" (23 cm)
357676	Straight, 8" (20.5 cm), TC
357677	Straight, 1 mm jaw, 8" (20.5 cm), TC
357654	Straight, without lock, 1.15 mm jaw, 7-3/8" (18.5 cm)
357655	Curved, without lock, 7-3/8" (18.5 cm)
357656	Straight, with lock, 1.2 mm jaw, 7-1/2" (19 cm)
357657	Curved, with lock, 0.6 mm jaw, 7-3/8" (18.5 cm)

CVT NEEDLE HOLDERS

Castro-Type Micro Needle Holders

DIGITATE-HEIFETZ NEEDLE HOLDERS



066204

CATALOG #	DESCRIPTION
066200	Straight, 0.4 mm smooth jaw, 5-3/4" (14.5 cm)
066204	Curved, 0.6 mm smooth jaw, 5-3/4" (14.5 cm)

Wire Twisters

BERRY STERNAL "BIG UGLY" TECHNIQUE® NEEDLE HOLDER



343030

A large, heavy-duty needle holder with 6 mm-wide jaws designed to securely hold the large needles used to close sternotomies. LIFE-LOK® Box-Lock.

CATALOG #	DESCRIPTION
343030	28 x 6 mm jaw, 7-3/4" (19.5 cm), TC

BAUMGARTEN WIRE TWISTER



142521

Heavy, square jaw.

CATALOG #	DESCRIPTION
142521	18 x 5 mm heavy, square jaws, 8-1/8" (20.5 cm), TC

CVT NEEDLE HOLDERS

Wire Twisters

RUBIO TECHNIQUE® WIRE TWISTER



CATALOG #	DESCRIPTION
351349	12 x 4.5 mm jaw, 5" (12.5 cm), TC

WIRE TWISTING FORCEPS



For twisting ends of wire when securing pump tubing to fittings.

CATALOG #	DESCRIPTION
351348	5-3/8" (13.5 cm)

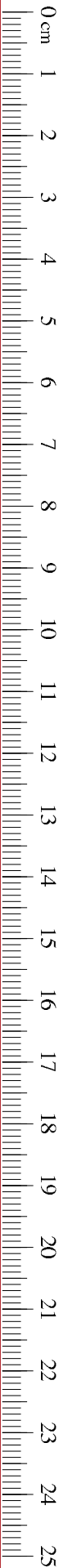

TITANIUM INSTRUMENTS

FORCEPS AND CLAMPS

Tissue and Dressing Forceps

ADSON TITANIUM DRESSING FORCEPS

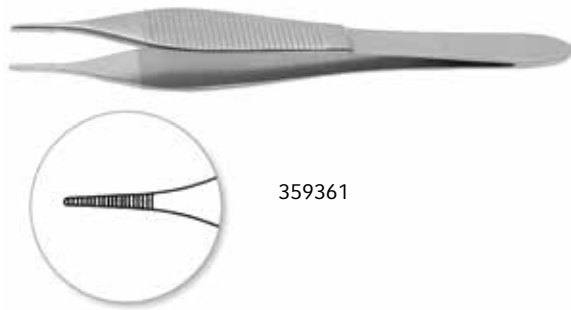

Flat handle.

CATALOG #	DESCRIPTION
359361	Serrated tip, 4-3/4" (12 cm)

ADSON TITANIUM TISSUE FORCEPS

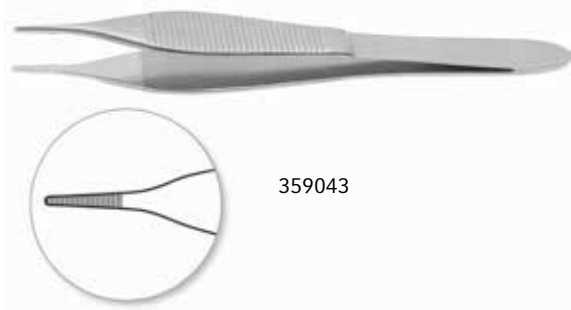

Flat handle.

CATALOG #	DESCRIPTION
359043	Serrated tip, 4-3/4" (12 cm), TC

ADSON-BROWN TITANIUM TISSUE FORCEPS



Flat handle.

CATALOG #	DESCRIPTION
359359	9 x 9 teeth, 4-3/4" (12 cm)

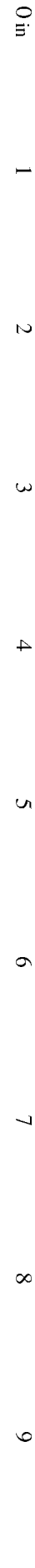

TITANIUM INSTRUMENTS FORCEPS AND CLAMPS

Tissue and Dressing Forceps

BARRAYA TITANIUM TISSUE FORCEPS



359053

Flat handle.

CATALOG #	DESCRIPTION
359053	2 x 3 teeth, 7-3/4" (20 cm)

CUSHING TITANIUM DRESSING FORCEPS

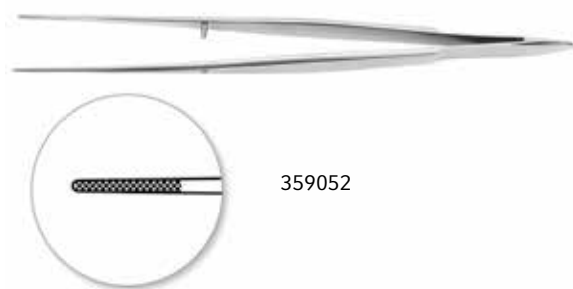

359052

Flat handle.

CATALOG #	DESCRIPTION
359052	Serrated, 7-1/8" (18 cm), TC

CUSHING TITANIUM TISSUE FORCEPS

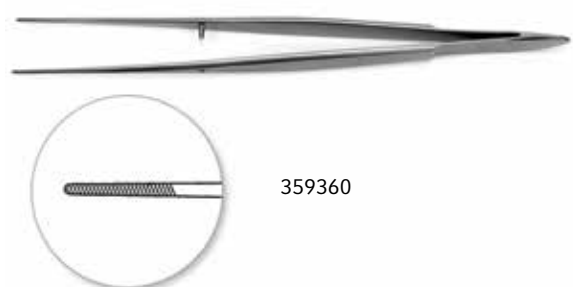

359360

Flat handle.

CATALOG #	DESCRIPTION
359360	Serrated, 7-7/8" (20 cm)

TITANIUM INSTRUMENTS

FORCEPS AND CLAMPS

Tissue and Dressing Forceps

DEBAKEY® TITANIUM TISSUE FORCEPS



359029

Flat handle.

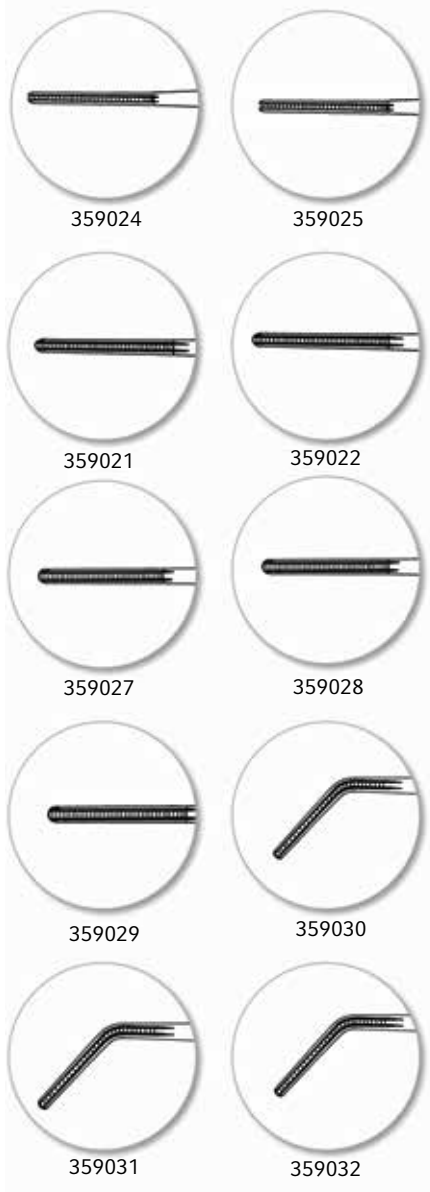

CATALOG #	DESCRIPTION
359024	Straight, 1.5 mm jaw width, 6" (15 cm)
359025	Straight, 1.5 mm jaw width, 7-5/8" (19.5 cm)
359021	Straight, 2.5 mm jaw width, 6" (15 cm)
359022	Straight, 2.5 mm jaw width, 7-5/8" (19.5 cm)
359027	Straight, 3 mm jaw width, 6" (15 cm)
359028	Straight, 3 mm jaw width, 7-5/8" (19.5 cm)
359029	Straight, 3 mm jaw width, 9-1/2" (24 cm)
359030	Angled, 2.5 mm jaw width, 5-7/8" (15 cm)
359031	Angled, 2.5 mm jaw width, 7-1/2" (19 cm)
359032	Angled, 2.5 mm jaw width, 9-1/4" (23.5 cm)

TITANIUM INSTRUMENTS

FORCEPS AND CLAMPS

Tissue and Dressing Forceps

GERALD TITANIUM DRESSING FORCEPS



Flat handle. Serrated tip.



359048

CATALOG #	DESCRIPTION
359048	6 7/8" (18 cm)

GERALD TITANIUM TISSUE FORCEPS



Flat handle. Serrated tip.



359049

CATALOG #	DESCRIPTION
359049	1 x 2 teeth, 6-7/8" (18 cm)

GILLIES TITANIUM TISSUE FORCEPS



Flat handle.



359051

CATALOG #	DESCRIPTION
359051	1 x 2 teeth, 5-7/8" (15 cm)

TITANIUM INSTRUMENTS

FORCEPS AND CLAMPS

Tissue and Dressing Forceps

GUILMET TITANIUM DRESSING FORCEPS



359054

Flat handle.

CATALOG #	DESCRIPTION
359054	Serrated tip, 7-7/8" (20 cm)

MCINDOE TITANIUM TISSUE FORCEPS

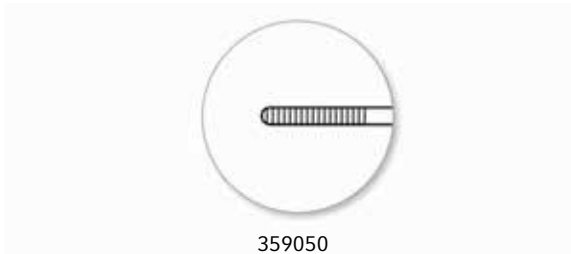

359050

Flat handle.

CATALOG #	DESCRIPTION
359050	Serrated tip, 5-7/8" (15 cm)

Micro Forceps

DENIS TITANIUM MICRO FORCEPS



359407

CATALOG #	DESCRIPTION
359407	Straight, 0.4 mm tip, Diamo-Grip jaws, 8-1/4" (21 cm)



TITANIUM INSTRUMENTS

FORCEPS AND CLAMPS

Micro Forceps

MICRO TITANIUM DIAMA-GRIP TYING FORCEPS

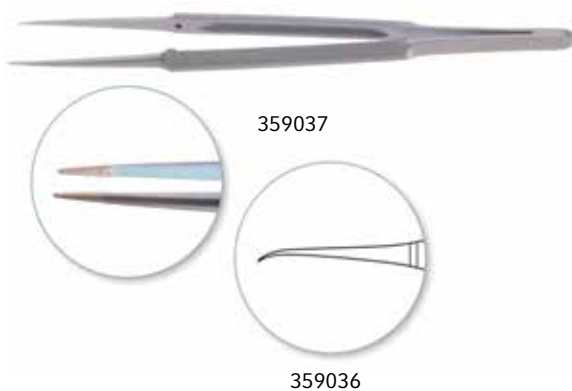

Round handle. Diama-Grip on tip.

CATALOG #	DESCRIPTION
359033	Straight, 4-3/4" (12 cm)
359034	Curved, 3-3/4" (9.5 cm)
359037	Straight, 7-1/8" (18 cm)
359036	Curved, 5-7/8" (15 cm), 6 mm Diama-Grip jaws

MICRO TITANIUM DIAMA-GRIP TYING FORCEPS

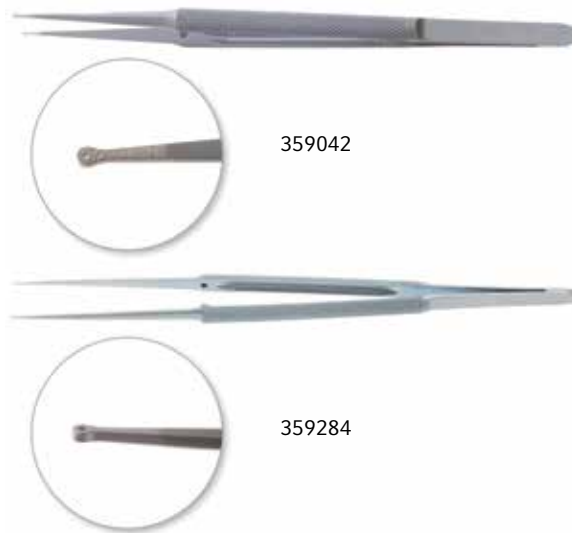

Straight with round handle. Diama-Grip ring tip.

CATALOG #	DESCRIPTION
359042	I.D. 0.4 mm, O.D. 1 mm, 7-1/8" (18 cm)
359283	I.D. 1 mm, O.D. 2 mm, 8-3/4" (22 cm)
359284	I.D. 0.4 mm, O.D. 1 mm, 8-3/4" (22 cm)

TITANIUM INSTRUMENTS

FORCEPS AND CLAMPS

Hemostatic Forceps

CRILE TITANIUM HEMOSTATIC FORCEPS

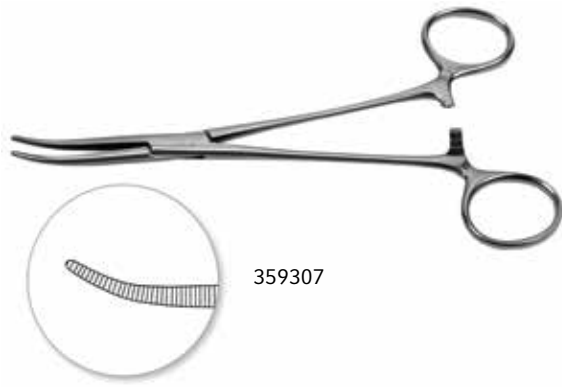

CATALOG #	DESCRIPTION
359307	Curved, serrated jaw, 5-5/8" (15 cm)

HALSTED TITANIUM HEMOSTATIC FORCEPS



CATALOG #	DESCRIPTION
359296	Curved, serrated jaws, 4-3/4" (12.5 cm)
359299	Delicate curved, serrated jaws, 4-3/4" (12.5 cm)

TITANIUM INSTRUMENTS

FORCEPS AND CLAMPS

Pediatric Vascular Clamps

CASTANEDA TITANIUM VASCULAR CLAMPING FORCEPS

Clamping Forceps (10 g).

CATALOG #	DESCRIPTION
359201	Straight jaw, 5-1/8" (13 cm)
359206	Curved jaw, 4-3/4" (12 cm)
359208	Curved jaw, 6-1/2" (17 cm)



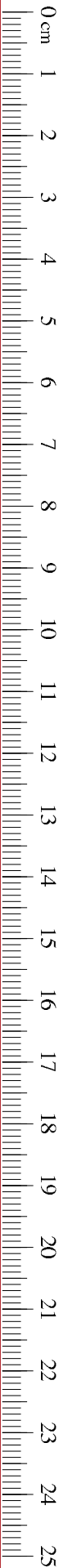

TITANIUM INSTRUMENTS FORCEPS AND CLAMPS

Pediatric Vascular Clamps

CASTANEDA TITANIUM VASCULAR CLAMPING FORCEPS



Clamping Forceps (15 g).

CATALOG #	DESCRIPTION
359209	Curved jaw, 6-1/2" (17 cm)
359210	Curved jaw, 6-3/8" (17 cm)
359211	Straight jaw, 6-5/8" (17 cm)
359212	30 degree angled jaw, 6-1/4" (16 cm)
359213	50 degree angled jaw, 6" (15 cm)
359214	70 degree angled jaw, 5-7/8" (15 cm)
359215	90 degree angled jaw, 5-3/8" (13.5 cm)

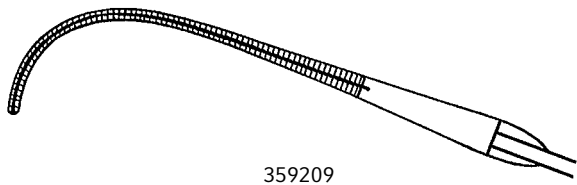

359209

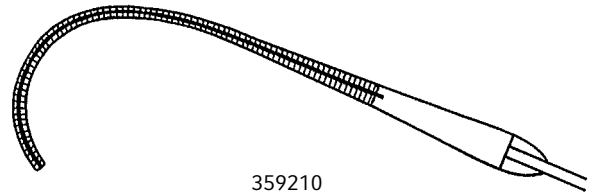

359210

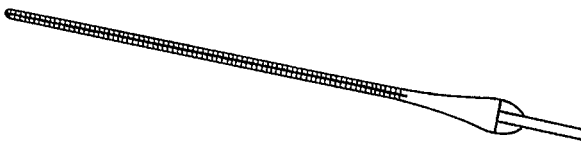

359211

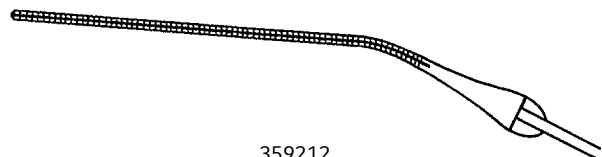

359212

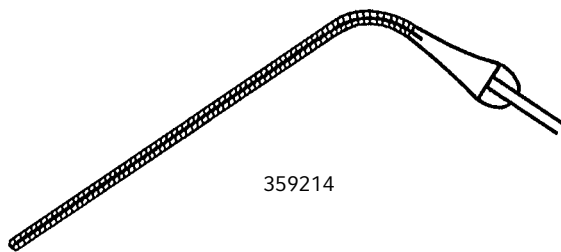

359214

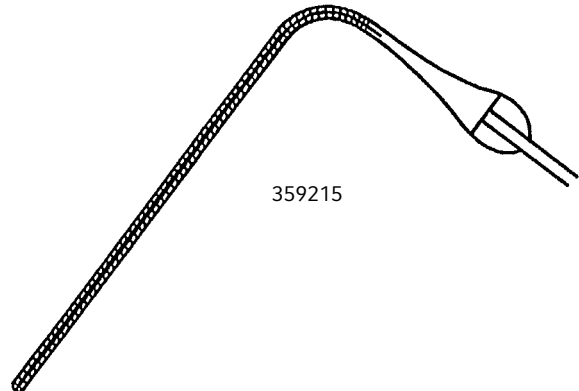

359215



TITANIUM INSTRUMENTS FORCEPS AND CLAMPS

Pediatric Vascular Clamps

COOLEY TITANIUM PEDIATRIC CLAMP



CATALOG #	DESCRIPTION
359221	Spoon-shaped for coarctation, 7-1/4" (18.5 cm)

DEBAKEY® TITANIUM PEDIATRIC CLAMPS



CATALOG #	DESCRIPTION
359354	Straight jaws, 4-3/8" (11 cm)
359355	60 degree angled jaws, 4" (10.5 cm)
359356	Anastomosis clamp with 9.5 mm angled operational jaw length, 3-7/8" (10 cm)
359357	Anastomosis clamp with 6 mm curved operational jaw length, 3-7/8" (9.5 cm)
359358	Anastomosis clamp with 16 mm operational jaw length, 4-1/8" (10.5 cm)



TITANIUM INSTRUMENTS

FORCEPS AND CLAMPS

Pediatric Vascular Clamps

DERRA TITANIUM ANASTOMOSIS CLAMPS



CATALOG #	DESCRIPTION
359236	Curved jaws, 6-11/16" (17 cm)
359237	Curved jaws, 6-13/16" (17.5 cm)

Vascular Clamps

CRAFOORD TITANIUM CLAMPING FORCEPS

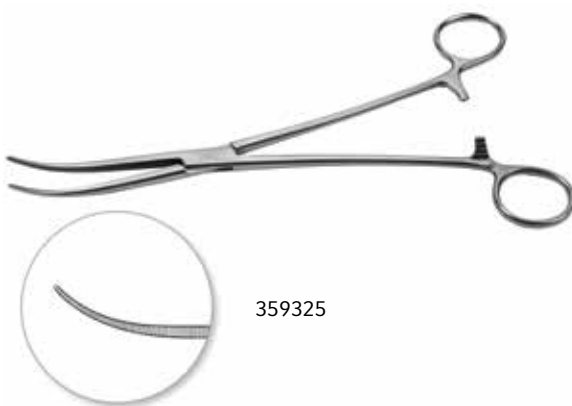

CATALOG #	DESCRIPTION
359325	Curved, serrated jaws, 9-1/2" (24 cm)



TITANIUM INSTRUMENTS FORCEPS AND CLAMPS

Vascular Clamps

DEBAKEY® TITANIUM VASCULAR CLAMPS



359162

CATALOG #	DESCRIPTION
359161	Aorta clamp, curved jaw, 11-1/8" (28.5 cm)
359162	Aorta clamp, curved jaw, 11-3/4" (30 cm)
359163	Aorta clamp, curved jaw, 12-5/8" (32 cm)
359185	Occlusion clamp with 50 mm operational jaw length, 10-3/4" (27 cm)
359186	Occlusion clamp with 40 mm operational jaw length, 10" (25 cm)
359187	Occlusion clamp with 30 mm operational jaw length, 10" (25 cm)
359188	Occlusion clamp with 25 mm operational jaw length, 9-1/2" (24 cm)

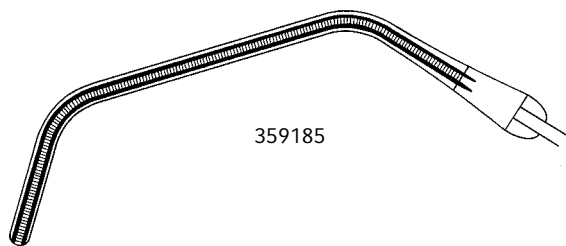

359185

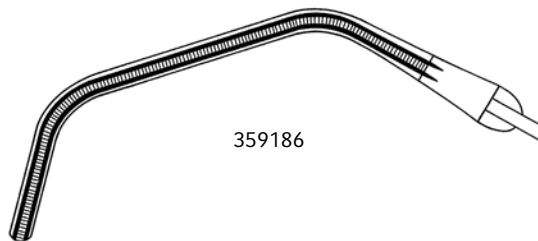

359186

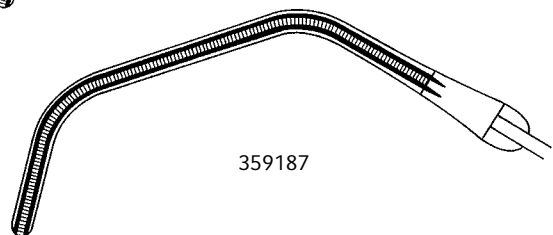

359187

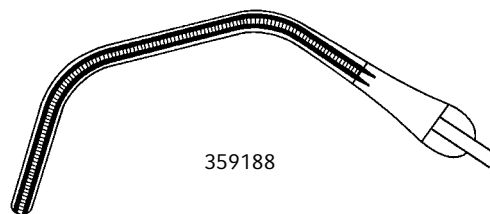

359188

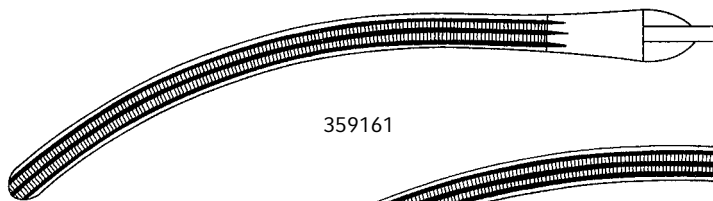

359161

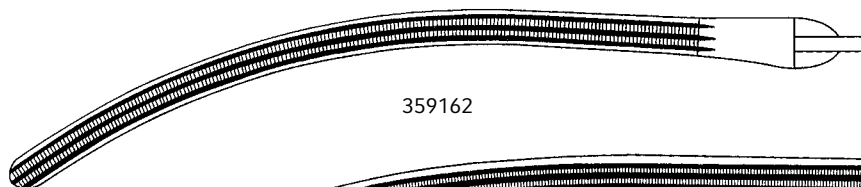

359162

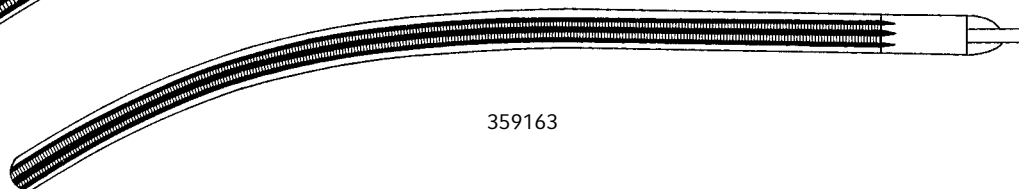

359163



TITANIUM INSTRUMENTS FORCEPS AND CLAMPS

Vascular Clamps

DEBAKEY® TITANIUM VASCULAR CLAMPS



359159

CATALOG #	DESCRIPTION
359159	70 degree angled jaw, 10-1/4" (26 cm)
359195	45 degree angled jaw, 10-1/2" (26.5 cm)
359181	60 degree angled jaw, 11-3/4" (30 cm)
359183	60 degree angled jaw, 9-3/8" (23.5 cm)
359184	60 degree angled jaw, 8-1/2" (21.5 cm)

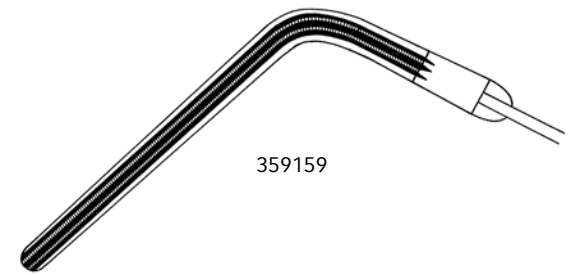

359159

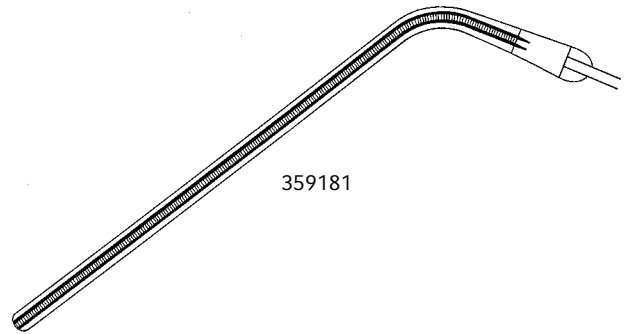

359181

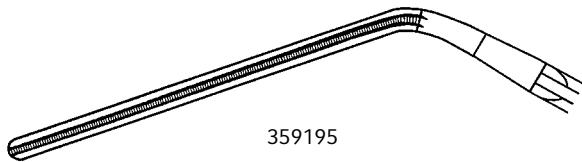

359195

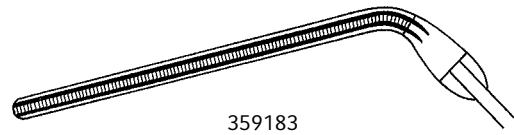

359183

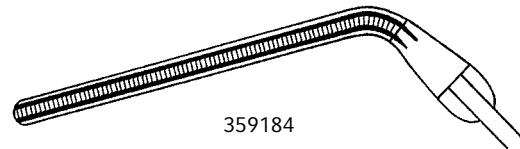

359184

DEBAKEY® TITANIUM VASCULAR CLAMPS

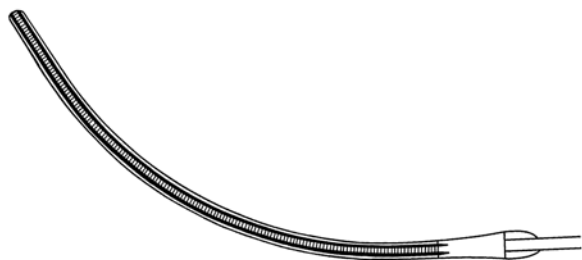

359173

CATALOG #	DESCRIPTION
359173	Curved jaw, 7-7/8" (20 cm)

TITANIUM INSTRUMENTS FORCEPS AND CLAMPS

Vascular Clamps

GLOVER TITANIUM AURICULAR CLAMP

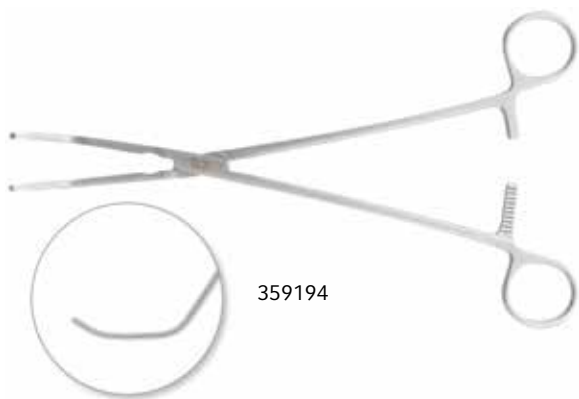

CATALOG #	DESCRIPTION
359194	Auricular handles with 30 mm operational jaw length, 10" (25 cm)

GLOVER TITANIUM COARCTATION VASCULAR CLAMPS

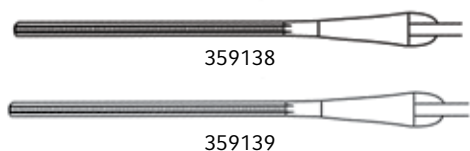

CATALOG #	DESCRIPTION
359138	Straight handles, DeBakey® Jaws, 8-5/8" (22 cm)
359139	Angled handles, DeBakey® Jaws, 8-5/8" (22 cm)

HEISS TITANIUM CLAMPING FORCEPS

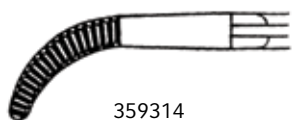

CATALOG #	DESCRIPTION
359314	Angled handles, DeBakey® Jaws, 8-5/8" (22 cm)

TITANIUM INSTRUMENTS

FORCEPS AND CLAMPS

Vascular Clamps

HUFNAGEL TITANIUM VASCULAR CLAMP

CATALOG #	DESCRIPTION
359160	Curved DeBakey® Jaw, 8-5/8" (22 cm)

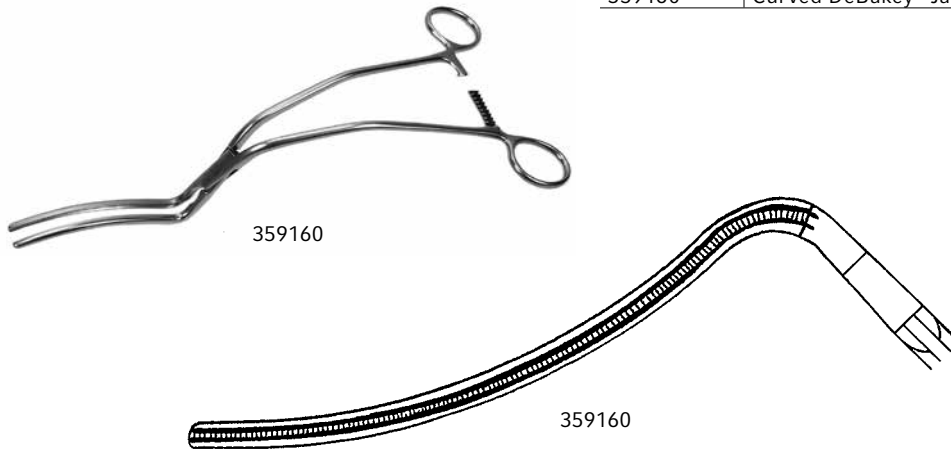

KAY TITANIUM VASCULAR CLAMP

CATALOG #	DESCRIPTION
359152	Curved DeBakey® Jaws, 7-7/8" (20 cm)

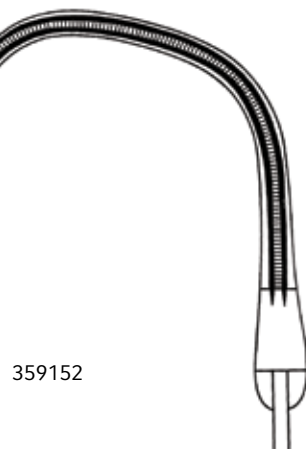



TITANIUM INSTRUMENTS

FORCEPS AND CLAMPS

Vascular Clamps

LELAND-JONES TITANIUM VASCULAR CLAMPS



CATALOG #	DESCRIPTION
359169	30 degree angled DeBakey® Jaws, 7-1/2" (19 cm)
359170	15 degree angled DeBakey® Jaws, 7-7/8" (20 cm)
359171	Straight, DeBakey® Jaw, 8-1/4" (21 cm)

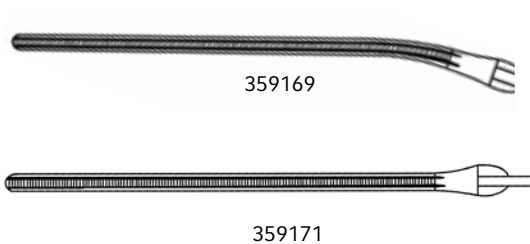

O'SHAUGHNESSY TITANIUM CLAMPING FORCEPS

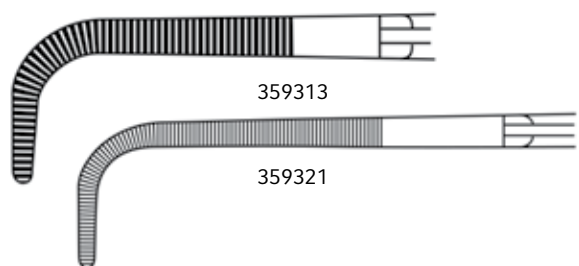

CATALOG #	DESCRIPTION
359313	Strong curve, serrated jaw, 8-1/4" (21 cm)
359321	Strong curve, serrated jaw, 9-5/8" (24.5 cm)



TITANIUM INSTRUMENTS FORCEPS AND CLAMPS

Vascular Clamps

RENAL ARTERY TITANIUM VASCULAR CLAMP

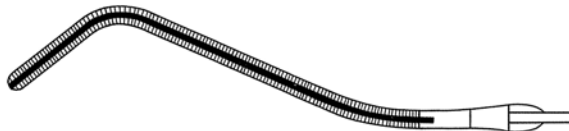

359238

CATALOG #	DESCRIPTION
359238	Curved jaws, 7-1/2" (19 cm)

SATINSKY TITANIUM VASCULAR CLAMPS



359191

359191

359193

CATALOG #	DESCRIPTION
359191	Vena cava clamp with 30 mm operational DeBakey® Jaw length, 9-5/8" (24.5 cm)
359193	Vena cava clamp with 20 mm operational DeBakey® Jaw length, 9-1/2" (24 cm)

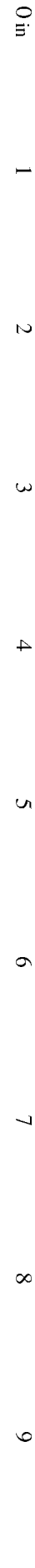

TITANIUM INSTRUMENTS FORCEPS AND CLAMPS

Bulldog® Clamps

DEBAKEY® TITANIUM BULLDOG® CLAMPS



359124



359127



359131

CATALOG #	DESCRIPTION
359122	Straight, 3" (7.5 cm)
359123	Straight, 3-3/8" (8.5 cm)
359124	Straight, 3-7/8" (10 cm)
359127	Curved, 3-1/4" (8.5 cm)
359128	Curved, 3-7/8" (10 cm)
359131	Angled 45 degrees, 4-3/4" (12 cm)

TITANIUM INSTRUMENTS

SCISSORS

Micro Scissors

MICRO TITANIUM SCISSORS



359006

With flat handle.

CATALOG #	DESCRIPTION
359003	Curved, 6-1/4" (16 cm)
359006	Straight, delicate, 6-1/4" (16 cm)
359250	Curved, serrated, 8-1/4" (21 cm)
359253	Straight, 9" (23 cm)

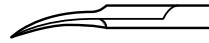

359003

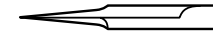

359006



359250

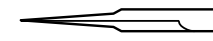

359253



TITANIUM INSTRUMENTS

SCISSORS

Micro Scissors

MICRO TITANIUM SCISSORS

With round handle.



359262

CATALOG #	DESCRIPTION
359259	Straight, 6-1/4" (16 cm)
359260	Curved, 6-1/4" (16 cm)
359261	Straight, serrated, 6-1/4" (16 cm)
359262	Curved, serrated, 6-1/4" (16 cm)
359263	Straight, delicate, 6-1/4" (16 cm)
359264	Curved, delicate, 6-1/4" (16 cm)
359265	Straight, 7-1/8" (18 cm)
359266	Curved, 7-1/8" (18 cm)
359267	Straight, serrated, 7-1/8" (18 cm)
359268	Curved, serrated, 7-1/8" (18 cm)
359269	Straight, delicate, 7-1/8" (18 cm)
359270	Curved, delicate, 7-1/8" (18 cm)
359271	Straight, 8-1/4" (21 cm)
359272	Curved, 8-1/4" (21 cm)
359273	Straight, serrated, 8-1/4" (21 cm)
359274	Curved, serrated, 8-1/4" (21 cm)
359275	Straight, delicate, 8-1/4" (21 cm)
359276	Curved, delicate, 8-1/4" (21 cm)
359277	Straight, 9" (23 cm)
359278	Curved, 9" (23 cm)
359279	Straight, serrated, 9" (23 cm)
359280	Curved, serrated, 9" (23 cm)
359281	Straight, delicate, 9" (23 cm)
359282	Curved, delicate, 9" (23 cm)



359259



359260



359261



359262



359263

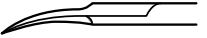

359264

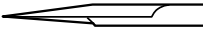

359265



359266



359267

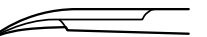

359268



359269



359270



359271

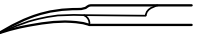

359272



359273



359274



359275

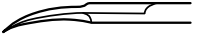

359276



359277



359278



359279

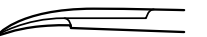

359280



359281



359282



TITANIUM INSTRUMENTS

SCISSORS

Potts-Style Scissors

POTTS MICRO TITANIUM SCISSORS



With flat handle, 16 mm blades.

CATALOG #	DESCRIPTION
359016	Angled 25 degrees, 7-1/4" (18.5 cm)
359017	Angled 45 degrees, 7-1/4" (18.5 cm)
359018	Angled 60 degrees, 7-1/4" (18.5 cm)
359019	Angled 90 degrees, 6-3/4" (17.0 cm)
359020	Angled 130 degrees, 6-3/4" (17.0 cm)

TITANIUM INSTRUMENTS

NEEDLE HOLDERS

Round Handle Micro Needle Holders

JACOBSON MICRO TITANIUM NEEDLE HOLDERS



359401

Straight, round handle with lock. Diama-Grip jaws.

CATALOG #	DESCRIPTION
359402	Heavyweight, 2 mm jaw, 9" (23 cm)
359401	12 x 1 mm jaw, 9" (23 cm)
359403	16 mm jaw, 8-1/4" (21 cm)

JACOBSON TITANIUM CASTROVIEJO NEEDLE HOLDERS



359343

Round handle with lock. Diama-Grip jaws.

CATALOG #	DESCRIPTION
359071	Straight, 1.8 mm jaw, 8-1/4" (21 cm)
359343	Curved, 1.1 mm jaw, 9" (23 cm)

MICRO TITANIUM CASTROVIEJO NEEDLE HOLDERS

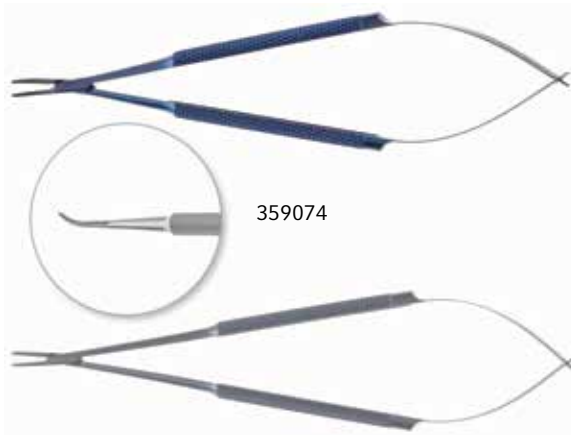

359074

359075

Round handle, Diama-Grip jaws.

CATALOG #	DESCRIPTION
359069	Straight, with lock, 1 mm jaw, 7-1/8" (18 cm)
359073	Straight, 1 mm jaw, 6-1/4" (16 cm)
359074	Curved, 1 mm jaw, 6-1/4" (16 cm)
359075	Straight, 1 mm jaw, 7-1/8" (18 cm)
359340	Straight, 1.1 mm jaw, 9" (23 cm)
359342	Curved, 1.1 mm jaw, 9" (23 cm)

TITANIUM INSTRUMENTS

NEEDLE HOLDERS

Round Handle Micro Needle Holders

MICRO TITANIUM CASTROVIEJO NEEDLE HOLDERS



Straight, round handle, serrated jaws.

CATALOG #	DESCRIPTION
359344	1 mm jaw, 6-1/4" (16 cm), TC
359345	With lock, 1 mm jaw, 6" (16 cm), TC
359346	7-1/8" (18 cm), TC
359347	With lock, 8.8 x 1.3 mm jaw, 7-1/8" (18 cm), TC
359349	1.5 mm jaw, 8-1/4" (21 cm), TC
359350	With lock, 1.4 mm jaw, 8-1/4" (21 cm), TC
359352	With lock, 1.5 mm jaw, 9" (23 cm), TC

Flat Handle Micro Needle Holders

MICRO TITANIUM CASTROVIEJO NEEDLE HOLDERS

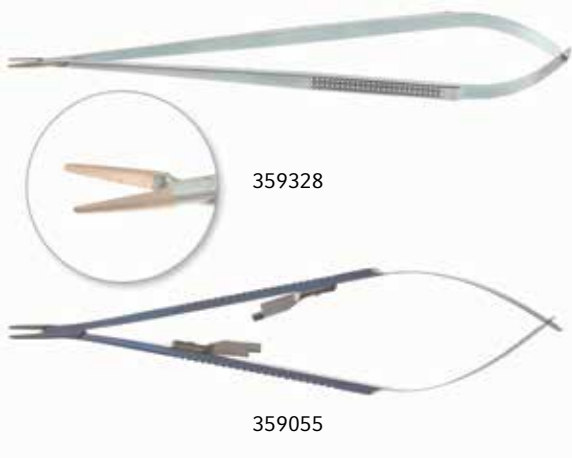

Diama-Grip jaws with flat handle.

CATALOG #	DESCRIPTION
359061	Straight, 9 x 1 mm jaw, 6-1/4" (16 cm)
359063	Straight, 9 x 1 mm jaw, 7-1/8" (18 cm)
359328	Straight, 9 x 1 mm jaw, 9" (23 cm)
359062	Curved, 8 x 1 mm jaw, 6-1/4" (16 cm)
359059	Straight with lock, 9 x 1 mm jaw, 8-1/4" (21 cm)
359329	Straight with lock, 9 x 1 mm jaw, 9" (23 cm)
359055	Straight with lock, 9 x 1 mm jaw, 6-1/4" (16 cm)
359058	Curved with lock, 8 x 1 mm jaw, 7-1/8" (18 cm)

MICRO TITANIUM CASTROVIEJO NEEDLE HOLDERS TC



Straight, serrated with flat handle and lock.

CATALOG #	DESCRIPTION
359335	Straight with lock, 9 x 1 mm jaw, 7-1/8" (18 cm), TC
359339	Straight with lock, 8 x 1.4 mm jaw, 9" (23 cm), TC

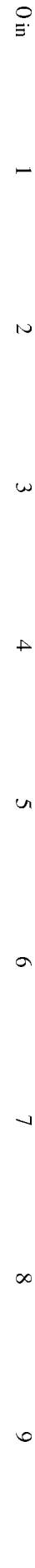

TITANIUM INSTRUMENTS

NEEDLE HOLDERS

Ring Handle Needle Holders

DEBAKEY® TITANIUM NEEDLE HOLDER

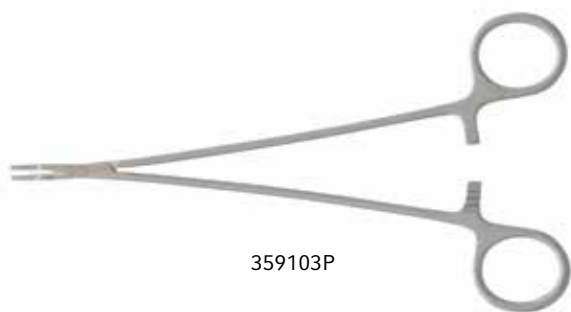

CATALOG #	DESCRIPTION
359103P	1.5 mm Diama-Grip jaw, 8" (20 cm)

DEBAKEY® TITANIUM RING HANDLE NEEDLE HOLDERS

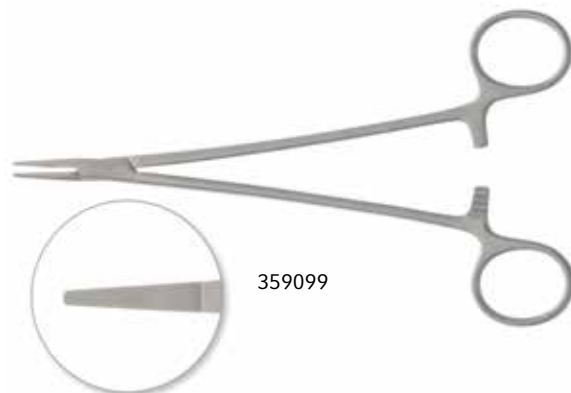

4000 teeth per square inch.

CATALOG #	DESCRIPTION
359381	1.5 mm jaw, 6-1/4" (16 cm), TC
359099	16 x 1.4 mm jaw, 8" (20.5 cm), TC

DEBAKEY® TITANIUM RING HANDLE NEEDLE HOLDERS

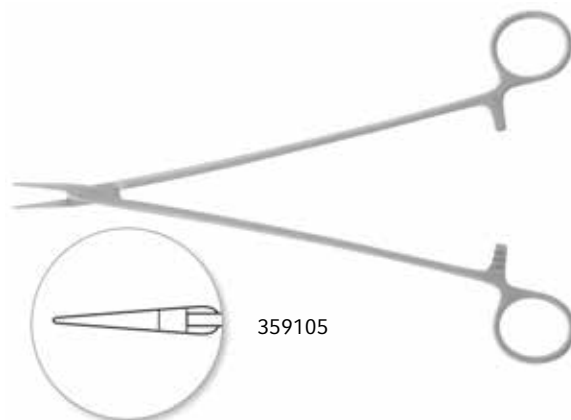

Diama-Grip jaws.

CATALOG #	DESCRIPTION
359102	1.6 mm jaw, 7" (18.5 cm)
359104	1.5 mm jaw, 8-5/8" (22 cm)
359105	1.6 mm jaw, 10" (25.5 cm)

TITANIUM INSTRUMENTS

NEEDLE HOLDERS

Ring Handle Needle Holders

DERF TITANIUM RING HANDLE NEEDLE HOLDER



4000 teeth per square inch.

CATALOG #	DESCRIPTION
359083	1.6 mm jaw, 4-1/2" (11.5 cm), TC

HALSEY TITANIUM RING HANDLE NEEDLE HOLDER



For suture sizes 4-0 to 6-0, 4000 teeth per square inch.

CATALOG #	DESCRIPTION
359085	15 x 1.5 mm jaw, 5" (12.5 cm), TC



TITANIUM INSTRUMENTS

NEEDLE HOLDERS

Ring Handle Needle Holders

INTRACARDIAC TITANIUM RING HANDLE NEEDLE HOLDER



359113P

CATALOG #	DESCRIPTION
359113P	1.8 mm jaw, 10" (25 cm), Diama-Grip

INTRACARDIAC TITANIUM RING HANDLE NEEDLE HOLDERS



359112

Diama-Grip jaws.

CATALOG #	DESCRIPTION
359110	21 x 2 mm jaw, 7" (18.5 cm)
359111	24 x 2 mm jaw, 8" (20.5 cm)
359112	24 x 2 mm jaw, 8-5/8" (22 cm)

MAYO HEGAR TITANIUM RING HANDLE NEEDLE HOLDERS

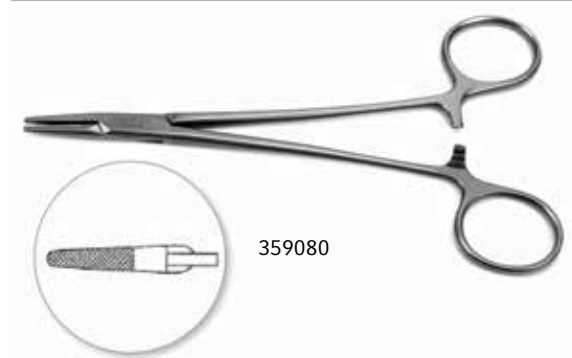

359080

1800 teeth per square inch.

CATALOG #	DESCRIPTION
359080	16 x 1.8 mm jaw, 7-1/8" (18 cm), TC
359082	16 x 1.8 mm jaw, 8-3/4" (22 cm), TC

TITANIUM INSTRUMENTS

NEEDLE HOLDERS

Ring Handle Needle Holders

MICROVASCULAR TITANIUM RING HANDLE NEEDLE HOLDERS

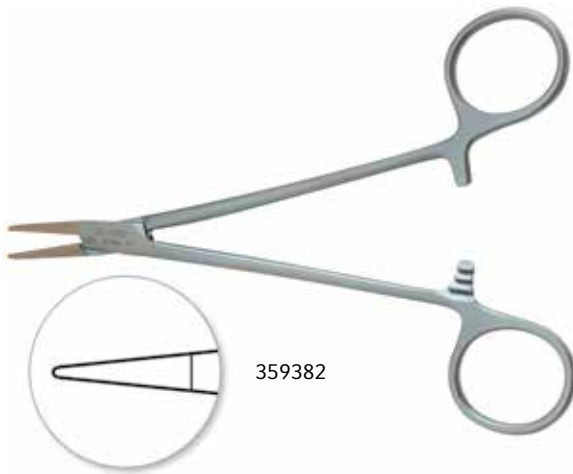

Diama-Grip jaws.

CATALOG #	DESCRIPTION
359382	1.8 mm jaw, 6" (16 cm)
359118	1.8 mm jaw, 7-1/4" (18.5 cm)
359119	1.8 mm jaw, 8" (20.5 cm)

RYDER TITANIUM RING HANDLE NEEDLE HOLDERS

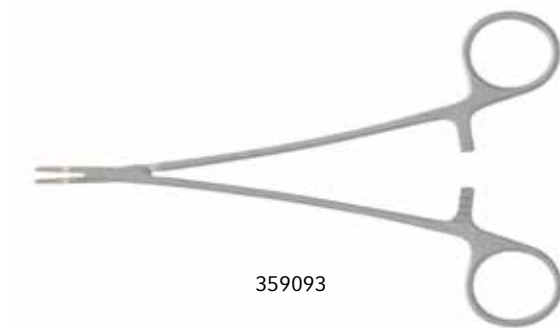

Diama-Grip jaws.

CATALOG #	DESCRIPTION
359092	10 x 1.4 mm jaw, 6" (16 cm)
359093	10 x 1.4 mm jaw, 6-3/4" (17 cm)

RYDER TITANIUM RING HANDLE NEEDLE HOLDERS



7000 teeth per square inch.

CATALOG #	DESCRIPTION
359097	8 x 1.6 mm jaw, 8" (19.5 cm), TC



TITANIUM INSTRUMENTS

Retractors

FINOCHIETTO TITANIUM STERNAL RETRACTOR



359383

CATALOG #	DESCRIPTION
359383	Arm length 52 mm

PEDIATRIC TITANIUM STERNAL SPREADER



359353

CATALOG #	DESCRIPTION
359353	2 pairs of blades, spread 2" (5 cm), arm length 52 mm

RIB INSTRUMENTS

Rongeurs

DALE FIRST RIB RONGEUR



342142

CATALOG #	DESCRIPTION
342142	3 x 15 mm jaw, 14-1/2" (37 cm)

URSCHEL-LEKSELL RONGEUR



342143

Strong, double action rongeur.

CATALOG #	DESCRIPTION
342143	8.5 x 15 mm jaw, 12-1/4" (31 cm)

PILLING® RUSKIN RONGEUR



341836

CATALOG #	DESCRIPTION
341836	4 mm bite, 6-1/8" (15.5 cm)

RIB INSTRUMENTS

Rongeurs

PILLING® STILLE-LUER DUCKBILL RONGEUR



CATALOG #	DESCRIPTION
341803	Angled, 5 mm wide jaw, 9" (23 cm)

SAUERBRUCH RONGEURS



Double action. Square bite, straight jaws, 11-3/4" (30 cm).

CATALOG #	DESCRIPTION
342102	13 mm
342105P	17 mm
342107	20 mm

URSHEL FIRST RIB RONGEUR



A specially designed, long, extra-heavy, pituitary-type rongeur to achieve complete removal of the neck and head of the first rib.

CATALOG #	DESCRIPTION
342141	5 x 12 mm jaw, working length 9" (23 cm)

RIB INSTRUMENTS

Approximators

BAILEY RIB APPROXIMATOR RETRACTORS



341448

Rib approximation is brought about by engaging jaws around ribs and turning large thumb screw. Automatic ratchet holds blades in place. Dull, non-glare finish stainless steel.

CATALOG #	DESCRIPTION
341448	Small size
341450	Regular, adult size



341450

BAILEY-GIBBON RIB APPROXIMATOR RETRACTOR



341460

CATALOG #	DESCRIPTION
341460	Same as Bailey except for lengthening of arms holding the blades. This raises the body of the retractor up, away from the ribs. Dull, non-glare finish, stainless steel.

Raspatories and Periosteal Elevators

ALEXANDER PERIOSTEOTOME



343145

Double-end, stainless steel blades. Cross-serrated handle.

CATALOG #	DESCRIPTION
343145	Standard model, 8-1/4" (21 cm)



RIB INSTRUMENTS

Raspatories and Periosteal Elevators

CUSHING BLUNT ELEVATOR



358344

CATALOG #	DESCRIPTION
358344	6 mm blunt blade, 7-1/4" (18.5 cm)

DOYEN RASPATORIES



343148



343153

Made in infant, child and adult sizes and in right and left side models. Stainless steel blades.

CATALOG #	DESCRIPTION
343148	Infant size, right side, 5-7/8" (15 cm)
343149	Infant size, left side, 5-7/8" (15 cm)
343152	Adult size, right side, 6-3/4" (17 cm)
343153	Adult size, left side, 6-1/2" (16.5 cm)

FREER DOUBLE-END ELEVATOR



355194

Pilling® Pattern, satin finish.

CATALOG #	DESCRIPTION
355194	Sharp and blunt, 7" (18 cm)

RIB INSTRUMENTS

Rib Shears/Sternum Cutters

BETHUNE RIB CUTTER



Double-curved shafts. For all ribs including first rib.

CATALOG #	DESCRIPTION
341950	13-3/4" (35 cm)

CORYLLOS-BETHUNE RIB SHEARS



With recessed points to protect brachial plexus.

CATALOG #	DESCRIPTION
341960	Right, 13-3/4" (35 cm)
341961	Left, 13-3/4" (35 cm)

ROOS FIRST RIB SHEAR



A right angle rib shear designed for posterior resection of the first rib through the axillary approach. By proper placement of the shear far posteriorly on the first rib, the remaining stump will be so short that it will not require revision with rongeurs. This adds greatly to the procedure by avoiding possible injury to the brachial plexus.

CATALOG #	DESCRIPTION
341985	12-1/2" (32 cm)

RIB INSTRUMENTS

Rib Shears/Sternum Cutters

STILLE PATTERN RIB SHEARS



341980

CATALOG #	DESCRIPTION
341980	10-1/4" (26 cm)

LEBSCHKE STERNUM KNIFE



342020

For splitting the sternum down the midline. Cross-serrated section is hit with mallet to provide cutting force. Recommended for use with the 11 oz Nylon Head Mallet (051525).

CATALOG #	DESCRIPTION
342020	9-7/8" (25 cm)

0 in

1

2

3

4

5

6

7

8

9

CVT RETRACTORS

Epicardial

PARSONNET EPICARDIAL RETRACTOR



342025

Designed to retract the epicardial fat during coronary by-pass procedures. Miniature spring style retractor. For low-profile epicardial tissue retraction at coronary anastomosis site.

CATALOG #	DESCRIPTION
342025	3 x 3-pronged, 1-1/16" (27 mm) spread, 1-7/8" (4.5 cm) long

IMA

CHAUX MULTIPURPOSE STERNAL IMA RETRACTOR



341150

The Chaux Sternal Retractor is a unique instrument that can be used not only for routine midline sternotomy, but also for exposure and dissection of the left or right internal thoracic artery. In addition, accessory interchangeable parts consisting of a full set of mitral retracting blades are available to allow self-retaining retraction during valve surgery.

- Four sternal blades with individual and independent dual movement.
- Sliding sternal blade assemblies allow finite positioning of sternal blades on the horizontal planes of side arms.
- For upward elevation required during IMA dissection, both side arms can be rotated and locked at 30 degrees or 60 degrees along its axis.
- All components of retractor remain in sterile field.

CATALOG #	DESCRIPTION
341150	Spread 8" (20.5 cm) Blades 1-1/8" wide x 1-7/16" deep (2.5 x 3.5 cm), Arm length 12" (30.5 cm)



CVT RETRACTORS

IMA

CHAUX STERNAL IMA-MITRAL VALVE RETRACTOR



341155

Three retractors in one, can be used as a sternal/IMA and valve retractor. Includes four sternal blades with individual and independent dual movement. Sliding sternal blade assemblies allow movement on horizontal planes of side arms to provide proper position adjustment according to length of sternum. Both side arms can be rotated and locked at 30 degrees or 60 degrees along its axis for flexibility in positioning the retractor for IMA exposure. All components of the retractor remain in the sterile field. The valve retractor fits directly onto arms of the sternal blade assembly and provides self-retaining valve retraction. The Chaux Sternal IMA Valve Retractor when used for valve surgery consists of the basic Chaux Retractor with the addition of a Lemole-Pilling® Valve Retractor Set (341501) and Valve Sternal Blade Assembly (341149).

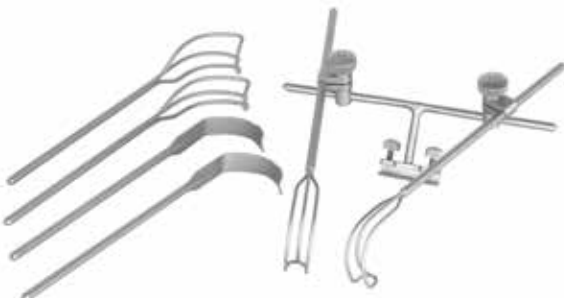

341501

CATALOG #	DESCRIPTION
341155	Chaux Sternal/IMA Valve Retractor Set Spread: 9-1/8" (23 cm) Blade measure: 1-1/8" (2.5 cm) wide x 1-1/4" (3 cm) deep
341501	Lemole-Pilling® Valve Retractor Set #1 Set #1 fits Cooley and Chaux Sternal Retractors
341520	Universal Clamp for Lemole
341522	Cooley Atrial Retractor, small, 9-1/2" (24 cm)
341523	Cooley Atrial Retractor, medium, 9-1/2" (24 cm)
341524	Cooley Atrial Retractor, large, 9-1/2" (24 cm)
341525	Malleable Atrial Retractor, 8-3/4" (22 cm)
341147	Lemole-Pilling® Valve Retractor (341501) and Valve Sternal Blade Assembly (341149) (Part of 341155)



341520



341522



341524



341523



341525



CVT RETRACTORS

IMA

CHAUX DEEP BLADE ASSEMBLY



341148

CATALOG #	DESCRIPTION
341148	1-3/4" (4.5 cm)

VALVE STERNAL BLADE ASSEMBLY



341149



341154



341156

CATALOG #	DESCRIPTION
341149	(Part of 341155)
341154	Chaux Sternal Assembly Thumb Screw
341156	Chaux Sternal Arm Take-up Screw

CVT RETRACTORS

IMA

COUËTIL IMA STERNAL RETRACTOR



341139

All components remain in the sterile field, giving you exposure and set-up control.

CATALOG #	DESCRIPTION
341139	Ratcheted blades slide freely on retractor arm

PILLING® IMA RETRACTOR

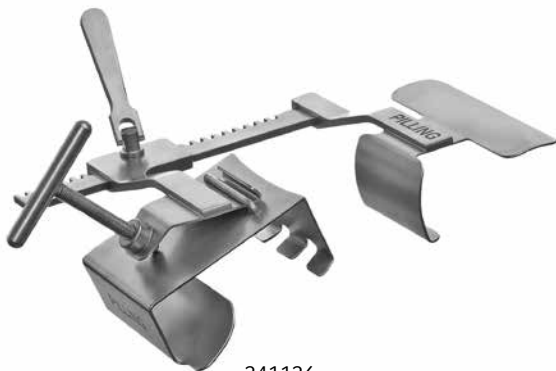

341136

All components remain in the sterile field, giving you exposure and set-up control.

CATALOG #	DESCRIPTION
341136	Replaces 341134 Pilling® Bugge IMA Retractor

OCHSNER-FAVALORO IMPROVED RETRACTOR SET WITH RAIL CLAMPS



341120

Designed for sternal retraction during internal mammary artery dissection. Rake retractors have screw-type handles for easier adjustment and blunt tips to prevent injury to the sternum. Supplied with two Gomez/Poly-tract Rail Clamps (Catalog # 341114) for ease of assembly over sterile drapes.

CATALOG #	DESCRIPTION
341120	Consists of: 2 each retractor uprights, 1 each crossbar, 2 each screw-type rake assemblies and 2 each 341114 Gomez/Poly-tract Rail Clamps

CVT RETRACTORS

IMA

OCHSNER-FAVALORO RETRACTOR PARTS

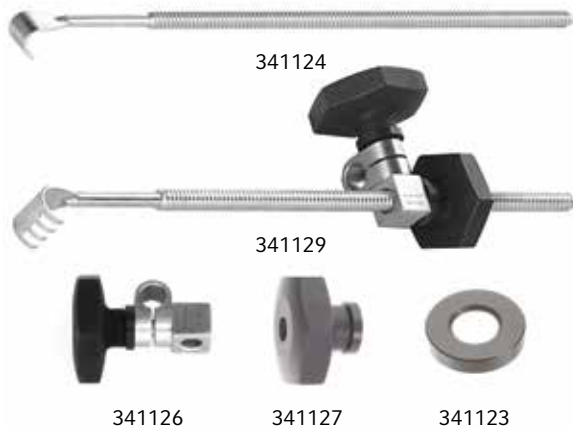

CATALOG #	DESCRIPTION
341123	Captive Washer for Knob
341124	Micro Adjustable Rake and Arm
341126	Knob and Clamp Assembly
341127	Micro Adjust Knob
341129	Rake Assembly for Ochsner-Favaloro Self-Retaining Retractors 341120 and 341128

OCHSNER-FAVALORO RETRACTOR SET



341128

The Favaloro Retractor modified with screw-type handles for ease of adjustment of retraction, longer arms for ease of assembly and blunt tips to help prevent injury to the sternum.

CATALOG #	DESCRIPTION
341128	Supplied with one pair of rail clamps for most standard OR tables.



CVT RETRACTORS

IMA

RAIL CLAMPS



343393

To facilitate transfer of the retractor to opposite side of the table, we suggest an additional pair of rail clamps.

CATALOG #	DESCRIPTION
343393	One pair

CHEANVECHAI RAKE ASSEMBLY



341131

CATALOG #	DESCRIPTION
341131	May be used with any existing Pilling®-made Favaloro-type cross bars and uprights (included with the Strong Retractor)

CHEANVECHAI-FAVALORO SWIVEL RAKE ASSEMBLY



341133

CATALOG #	DESCRIPTION
341133	Same as 341131 except rakes swivel

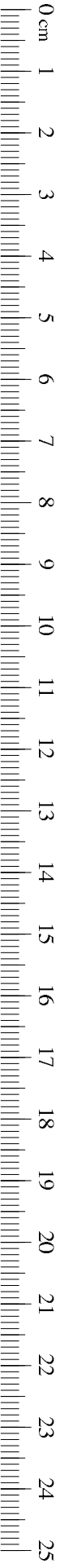

CVT RETRACTORS

IMA

STRONG T-BAR RETRACTOR SYSTEM



341100

Single post, table-mounted IMA Retractor with Cheanvechai Adjustable Rakes. (Shown with optional Retractor Light Beam, 163701.)

CATALOG #	DESCRIPTION
341100	Retractor System

STRONG T-BAR UNILATERAL SYSTEM COMPONENTS



341131

CATALOG #	DESCRIPTION
341112	Strong support bar, table upright diameter 5/8" (1.5 cm)
341113	Strong T-Bar
341131	Cheanvechai-Favaloro Rake Assembly
341114	Rail Clamp for Strong T-Bar, 5/8" (1.5 cm)
166002	Set of four 341114 Rail Clamps



341114

CVT RETRACTORS

Sternal Retractors/Rib Spreaders

PREEMIE RETRACTOR



341312

The smallest Pilling® Chest Retractor. For premature infants less than 2 kg body weight.

CATALOG #	DESCRIPTION
341312	Spread 1-9/16" (4.0 cm) Fixed blades 5/16" deep x 1/4" wide (8 x 6.5 mm) Arm length 1" (2.5 cm)

DAVIS-FINOCHIETTO INFANT RETRACTOR



341290

Miniature size for use in infants. Especially valuable in surgery for tracheoesophageal fistula. Stainless steel.

CATALOG #	DESCRIPTION
341290	Spread 2-3/4" (7 cm) Blades 1/2" deep x 5/8" wide (1.3 x 1.5 cm) Arm length 2-1/16" (5 cm)

FINOCHIETTO RIB RETRACTOR



341302

Infant size, for newborn and tiny infants. Aluminum construction.

CATALOG #	DESCRIPTION
341302	Spread 2-3/4" (7 cm) Blades 1/2" deep x 5/8" wide (1.3 x 1.5 cm) Arm length 2-1/4" (6 cm)



CVT RETRACTORS

Sternal Retractors/Rib Spreaders

WILCOX PEDIATRIC CARDIAC RETRACTOR



341315

A miniature model of the Finochietto. Light construction, stainless steel.

CATALOG #	DESCRIPTION
341315	Spread 2-3/4" (7 cm) Blades 7/8" deep x 7/8" wide (2.2 x 2.1 cm)

AMATO NEONATAL STERNAL RETRACTORS



341303

Specially designed infant sternal retractors to reduce post-operative sternal deformity by dispensing pressure over greater surface area. Selection of 3 sizes available for proper fit.

CATALOG #	DESCRIPTION
341303	Amato Retractor, 4 blade, small Swivel blades 3/8" wide x 3/8" deep (1 x 1 cm)
341304	Amato Retractor, 4 blade, medium Maximum spread 2-3/4" (7 cm) Swivel blades 1/2" wide x 1/2" deep (1.5 x 1.5 cm)
341305	Amato Retractor, 6 blade, large Spread 2-1/2" (6.5 cm) Swivel blades 1/2" wide x 1/2" deep (1.5 x 1.5 cm)



341304



341305

CVT RETRACTORS

Sternal Retractors/Rib Spreaders

DEBAKEY® CHILD RETRACTOR



341317

Lightweight aluminum arms and blades are dull finished to eliminate glare and curved to follow body contour. Rack is stainless steel.

CATALOG #	DESCRIPTION
341317	Spread 3-3/4" (9.5 cm) Blades 1-1/8" deep x 1-1/8" wide (3 x 3 cm) Arm length 3-1/8" (8 cm)

BURFORD-FINOCHIETTO INFANT-CHILD RETRACTOR



341250

Stainless steel. This retractor is equipped with interchangeable blades, an important feature that eliminates the need for more than one spreader. Smaller-scaled and lighter weight than the adult size, it provides a 5-7/8" (15 cm) spread.

CATALOG #	DESCRIPTION
341250	Infant-Child Spread 5-7/8" (15 cm) Supplied with four pairs of stainless side blades: 1" deep x 15/16" wide (2.5 x 2.4 cm) 1-1/4" deep x 1-5/16" wide (3.2 x 3.3 cm) 1-1/4" deep x 1-3/4" wide (3.2 x 4.4 cm) 1-7/8" deep x 1-3/4" wide (4.9 x 4.4 cm) Arm length 4-1/4" (10.8 cm)

GERBODE-BURFORD CHILD RETRACTOR



341200

Stainless steel. Has same projection-free construction as adult models but is proportionally reduced to child size.

CATALOG #	DESCRIPTION
341200	Child Spread 5-15/16" (15 cm) Supplied with four pairs of side blades: 3/4" deep x 1" wide (1.9 x 2.5 cm) 1-1/16" deep x 1-1/4" wide (2.7 x 3.2 cm) 1-1/16" deep x 1-3/4" wide (2.7 x 4.4 cm) 1-7/8" deep x 1-3/4" wide (4.8 x 4.4 cm) Arm length 4-1/2" (11.5 cm)

CVT RETRACTORS

Sternal Retractors/Rib Spreaders

HAIGHT BABY RETRACTOR



341296

Light construction. Spreader arms held apart by "ratchet" mechanism.

CATALOG #	DESCRIPTION
341296	Large Spread 4-3/4" (12 cm) Blades 1-3/8" deep x 1-1/8" wide (3.4 x 3 cm)

REPLOGLE INFANT STERNAL RETRACTOR

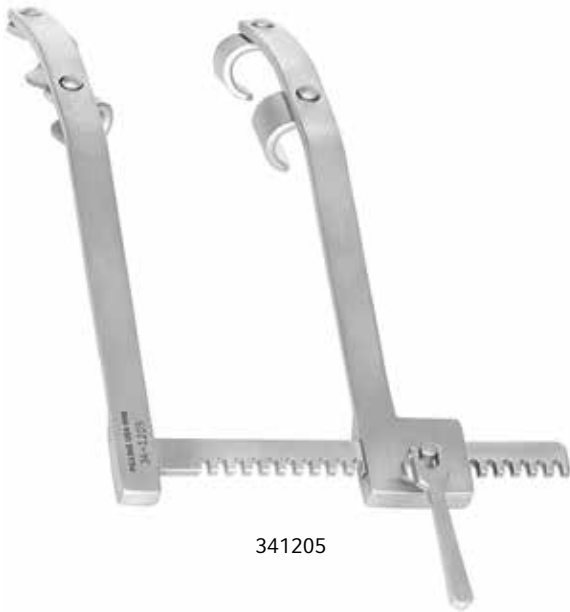

341205

Gently curved arms fit the natural contour of the infant sternum. Each blade swivels 45 degrees. 5-7/8" (15 cm) length arms place ratchet bar out of surgical field.

CATALOG #	DESCRIPTION
341205	Spread 2-15/16" (7.5 cm) Blades 5/8" deep x 1/2" wide (1.6 x 1.3 cm) Arm length 5-7/8" (15 cm)



CVT RETRACTORS

Sternal Retractors/Rib Spreaders

FINOCHIETTO RETRACTORS

The original model. Shafts curved to follow body contour. Dull, non-glare finished stainless steel.



341326

CATALOG #	DESCRIPTION
341326	Newborn size Spread 1-7/8" (4.9 cm) Blades 5/8" deep (1.5 cm) Straight arms
341328	Child size Spread 5-1/8" (13 cm) Blades 1-1/2" deep x 1-3/4" wide (3.8 x 4.4 cm) Arm length 5-1/4" (13.3 cm), curved arms
341330	Adult size Spread 7-1/2" (19 cm) Blades 2-1/8" deep x 2-5/8" wide (5.4 x 6.7 cm) Curved arms
341332	Adult size, large Spread 7-1/2" (19 cm) Blades 2-7/8" deep x 2-5/8" wide (7.3 x 6.7 cm) Curved arms



341328



341330



341332

CVT RETRACTORS

Sternal Retractors/Rib Spreaders

MORSE STERNAL RETRACTORS WITH DOUBLE BLADES

For sternal-splitting incisions. The double blades help prevent the narrow split sternal halves from breaking in their mid-portion.

CATALOG #	DESCRIPTION
341158	Child, age 2-5 Spread 3-7/8" (10 cm) Blades 3/8" deep x 5/8" wide (1.1 x 1.5 cm)
341160	Child Spread 6" (15.2 cm) Blades 5/8" deep x 13/16" wide (1.6 x 2.1 cm) Arm length 5" (12.7 cm)
341162	Adult Spread 8" (20.3 cm) Blades 15/16" deep x 1-1/8" wide (2.4 x 2.9 cm) Arm length 6" (15.2 cm)



341158



341160



341162



CVT RETRACTORS

Sternal Retractors/Rib Spreaders

FAVALORO-MORSE STERNAL RETRACTORS



341163

CATALOG #	DESCRIPTION
341163	Adult, Short Spread 8" (20.3 cm) Blades 1-1/2" deep x 1-1/8" wide (3.8 x 2.8 cm) Arm length 6" (15.2 cm)
341164	Large Adult, Long Spread 8" (20.3 cm) Blades 1-1/2" deep x 1-1/8" wide (3.8 x 2.8 cm) Arm length 8-1/16" (20.5 cm)

COOLEY STERNUM RETRACTORS



341194

CATALOG #	DESCRIPTION
341194	Adult Spread 6-1/2" (16.5 cm) Short blades 1-1/4" deep x 2-1/4" wide (3.2 x 5.7 cm) Arm length 5-3/4" (14.6 cm)
341195	Large Adult Spread 6-5/16" (16 cm) Long, concave blades 1-1/4" deep x 4" wide (3 x 10 cm) Arm length 6-1/2" (16.5 cm)



341195

CVT RETRACTORS

Sternal Retractors/Rib Spreaders

DEBAKEY® CHEST RETRACTORS



A group of three sizes, each supplied with 2 sets of curved aluminum blades designed for use with ribs or sternum. Blades attach by a simple slide arrangement without suture catching obstructions.

CATALOG #	DESCRIPTION
341175	Adult Spread 6-1/2" (16.5 cm) Blades 1-1/4" deep x 2-1/4" wide (3.2 x 5.7 cm) and 1-3/16" deep x 2-1/4" wide (3 x 5.7 cm)
341177	Adolescent Spread 5-1/2" (14 cm) Blades 1-1/4" deep x 1-1/8" wide (3.2 x 3 cm) and 1-3/4" deep x 1-1/8" wide (4.4 x 3 cm)
341178	Child Spread 3-7/8" (10 cm) Blades 1-1/4" deep x 1-1/8" wide (3.2 x 3 cm) and 1-1/2" deep x 1-1/8" wide (3.9 x 3 cm)



CVT RETRACTORS

Sternal Retractors/Rib Spreaders

KUYPER-MURPHY STERNAL RETRACTORS

Straight arms. Concave blades.



341397

CATALOG #	DESCRIPTION
341397	Small Spread 4-1/2" (11.5 cm) Blades 1-1/8" deep x 3-1/2" wide (3 x 9 cm)
341398	Medium Spread 6-5/16" (16 cm) Blades 1-3/16" deep x 3-1/2" wide (3 x 8.9 cm)



341398



CVT RETRACTORS

Sternal Retractors/Rib Spreaders

RIENHOFF RETRACTORS



341362



341366

Stainless steel.

CATALOG #	DESCRIPTION
341362	Spread 5-7/8" (15 cm) Blades 1-1/8" deep x 1-1/4" wide (3 x 3.3 cm)
341366	Spread 5-1/2" (14 cm) Blades 2" deep x 1-3/4" wide (5 x 4.4 cm) Arm height 4-5/8" (11.7 cm)

TUFFIER RETRACTOR



341390

Scored blades.

CATALOG #	DESCRIPTION
341390	Spread 5-7/8" (15 cm) Blades 2-3/16" deep x 1-7/8" wide (5.6 x 4.8 cm) Arm length 4-1/2" (11.4 cm)

CVT RETRACTORS

Sternal Retractors/Rib Spreaders

BONCHEK-CARPENTIER STERNAL/ATRIAL VALVE RETRACTOR



341198

- Cooley-type Sternal Blades with shorter outward curve designed for easier insertion.
- Allows critical adjustment of the retractor blades to apply traction to the atrial wall.
- Both models are supplied with four atrial valve retracting blades, two narrow and two wide.

CATALOG #	DESCRIPTION
341198	Modified Carpentier-Type Sternal/Atrial Retractor Spread 6-7/8" (17.5 cm) Sternal blades 3-15/16" wide x 1-1/4" deep (10 x 3.2 cm)

BURFORD ADULT RETRACTOR



341225

Stainless steel. Shanks are curved to fit body contour and blades are detachable. Blades have protruding points to help prevent spreader from moving during operation. Two pairs of blades are supplied.

CATALOG #	DESCRIPTION
341225	Minimum Spread 7-1/2" (19 cm) Small blades 2-1/2" deep x 2-1/2" wide (6.5 x 6.5 cm) Large blades 3-1/4" deep x 2-5/8" wide (8.1 x 6.5 cm) Arm length 8-1/8" (20.5 cm)

BURFORD ALUMINUM ADULT RETRACTOR



341227

Two pairs of blades are supplied.

CATALOG #	DESCRIPTION
341227	Spread 6-7/8" (17.5 cm) Small blades 1-7/8" deep x 2-3/8" wide (4.7 x 6.1 cm) Large blades 2-1/2" deep x 2-3/8" wide (6.5 x 6.1 cm) Arm length 7-11/16" (19.4 cm)

CVT RETRACTORS

Sternal Retractors/Rib Spreaders

FARRELL RUBIO RETRACTOR



341224

Two sets of interchangeable blades.

CATALOG #	DESCRIPTION
341224	Adult Spread 7-1/2" (19 cm) Blades 1-5/8" deep x 2-5/8" wide (4.1 x 6.7 cm) and 2-1/2" deep x 2-5/8" wide (6.3 x 6.7 cm) Arms curved 50 degrees

GERBODE-BURFORD ADULT RETRACTOR



341170

Stainless steel. The lugs and springs holding the detachable blades in place are located on the underside of the spreader arms. This presents a smooth projection-free upper surface which will not catch sutures. Shanks are curved to fit body contour and blades are detachable. Two pairs of blades are supplied.

CATALOG #	DESCRIPTION
341170	Adult Spread 7-1/2" (19 cm) 2-1/8" deep x 2-5/8" wide (5.5 x 6.7 cm) and 2-7/8" deep x 2-5/8" wide (7.3 x 6.7 cm) Arm length 7-1/4" (18.4 cm)



CVT RETRACTORS

Sternal Retractors/Rib Spreaders

GERBODE STERNAL RETRACTORS



Designed to provide retraction on a broad segment of sternum, thus preventing pressure on soft tissues. Sternal fracture from the retractor is less likely to occur. The blades are of simple, smooth construction without protuberances to catch sutures. Blades are designed to place pressure on sternum but not on overlying soft tissue.

CATALOG #	DESCRIPTION
341180	Standard spread Spread 5-7/8" (15 cm) Blades 1-3/16" deep x 3-15/16" wide (3 x 10 cm)
341181	Wide spread Spread 7-3/4" (19.5 cm) Blades 1-3/16" deep x 3-15/16" wide (3 x 10 cm)



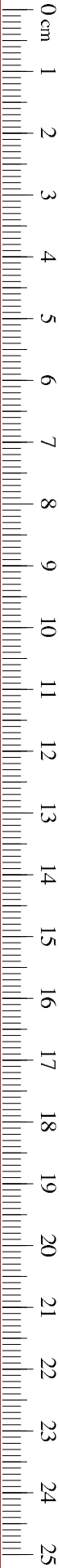

CVT RETRACTORS

Sternal Retractors/Rib Spreaders

TRANSPLANT DONOR STERNAL RETRACTORS

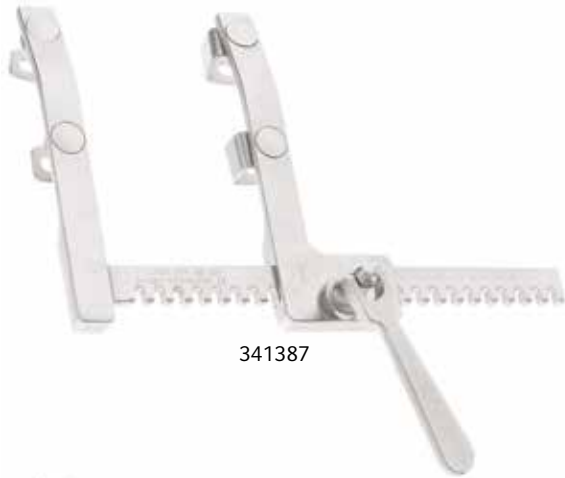

341387

Each Morse-Style Sternal Retractor blade has a prominent lip and a large spike to secure retractor in donor's sternum for maximum spread without slippage.

CATALOG #	DESCRIPTION
341387	Infant/Child Spread 4-3/8" (11 cm) Spiked blades 5/8" deep x 1/2" wide (1.4 x 1.3 cm)
341389	Adult Spread 7-1/2" (19 cm) Spiked blades 1-1/4" deep x 1" wide (3.2 x 2.5 cm)



341389

HEITMILLER MINI THORACOTOMY RETRACTOR



341310

This retractor provides excellent exposure for video-assisted thoracoscopy, open lung biopsies, transaxillary incisions and mid-CAB procedures in which mini-thoracotomy incisions are used. With its small "footprint," it also is ideal for mobilizing lung adhesions during redo thoracotomies.

CATALOG #	DESCRIPTION
341310	Spread 3-1/8" (7.9 cm) Blades 5/8" wide (1.6 cm)

CVT RETRACTORS

Pilling® Sternal Retractor and Rib Spreader Dimensions

All dimensions are in centimeters. All dimensions are approximate.

AGE	CATALOG #	BLADE STYLE	MINIMUM SPREAD	BLADE DEPTH	BLADE WIDTH	ARM LENGTH
PREEMIE						
Preemie	341312	Rib, Single, Fixed	4.0	0.8	0.65	2.5
NEWBORN						
Finochietto	341326	Rib, Single, Fixed	4.9	1.5	1.5	5.5
Amato	341303	Sternal, 4 Swivel Blades	7.0	1.0	1.0	4.0
INFANT TO YOUNG CHILDREN						
Aluminum Finochietto	341302	Rib, Single, Fixed	7.0	1.3	1.5	5.5
Amato Medium	341304	Sternal, 4 Swivel Blades	7.0	1.4	1.3	5.9
Amato Large	341305	Sternal, 6 Swivel Blades	7.0	1.4	1.3	9.0
Davis-Finochietto	341290	Rib, Single, Fixed	7.0	1.3	1.5	5.0
DeBakey®-Finochietto	341315	Rib, Single, Fixed	7.0	2.2	2.1	6.0
Replogle	341205	Sternal, 4 Swivel Blades	7.5	1.6	1.3	15.0
Aluminum DeBakey®	341317	Rib, Single, Fixed	9.5	3.0	3.0	8.0
Morse	341158	Sternal, 4 Swivel Blades	10.0	1.1	1.5	9.0
Transplant Donor	341387	Sternal, 4 Swivel, Spiked	11.0	1.4	1.3	9.5
Haight Large	341296	Rib, Single, Fixed	12.1	3.4	3.0	9.0
OLDER CHILD 6-10 YEARS						
DeBakey®	341178	Rib, Single, Interchangeable	10.0	3.2	3.0	8.0
Burford-Finochietto	341250	Rib, Single, Interchangeable	15.0	2.5	2.4	10.8
Morse	341160	Sternal, 4 Swivel Blades	15.2	1.6	2.1	12.7
ADOLESCENT						
Kuyper-Murphy Small	341397	Sternal, Fixed	11.5	3.0	9.0	13.5
Finochietto	341328	Rib, Single, Fixed	13.0	3.8	4.4	13.3
MIXED						
Gerbode-Burford	341200	Rib, Single, 4 Interchangeable Blades	15.0	1.9	2.5	11.5
SMALL ADULT						
Rienhoff	341366	Rib, Single, Fixed	14.0	5.0	4.4	11.7
DeBakey®	341177	Rib/Sternal, Interchangeable	14.0	3.2	3.0	13.0
Rienhoff Medium	341362	Rib, Single, Fixed	15.0	3.0	3.3	9.0
Tuffier	341390	Rib, Single, Fixed	15.0	5.6	4.8	11.4
Kuyper-Murphy Medium	341398	Sternal, Fixed	16.0	3.0	8.9	16.0

CVT RETRACTORS

Pilling® Sternal Retractor and Rib Spreader Dimensions

All dimensions are in centimeters. All dimensions are approximate.

AGE	CATALOG #	BLADE STYLE	MINIMUM SPREAD	BLADE DEPTH	BLADE WIDTH	ARM LENGTH
ADULT						
Gerbode	341180	Sternal, Fixed	15.0	3.0	10.0	23.0
Cooley	341194	Sternal, Fixed	16.5	3.2	5.7	14.6
Aluminum Burford	341227	Rib, Single, Interchangeable	17.5	4.7	6.1	19.4
DeBakey®	341175	Rib/Sternal, Interchangeable	18.5	3.2	5.7	18.0
Finochietto	341330	Rib, Single, Fixed	19.0	5.4	6.7	15.0
Burford	341225	Rib, Single, Interchangeable	19.0	5.4	6.2	19.5
Gerbode-Burford	341170	Rib, Single, Interchangeable	19.0	5.5	6.7	18.4
Farrell Rubio	341224	Rib/Sternal, Interchangeable	19.0	4.1	6.7	17.0
Adult Transplant Donor	341389	Sternal, Fixed, Spiked	19.0	3.2	2.5	15.0
Morse	341162	Sternal, 4 Swivel Blades	20.3	2.4	2.9	15.2
Favaloro-Morse	341163	Sternal, 4 Swivel Blades	20.3	3.8	2.8	15.2
Chaux	341150	Sternal/IMA, 4 Swivel Blade	20.3	3.7	2.7	20.0
Chaux-Lemole	341155	Sternal/IMA, 4 Swivel Blade, Valve Retractors	23.2	3.0	2.7	20.0
LARGE ADULT						
Cooley	341195	Sternal, Fixed	16.0	3.2	10.2	16.5
Bonchek-Carpentier	341198	Sternal, Fixed	18.5	3.2	10.0	16.0
Finochietto Large	341332	Rib, Single, Fixed	19.0	7.3	6.7	18.0
Gerbode	341181	Sternal, Fixed	19.5	3.0	10.0	23.0
Favaloro-Morse	341164	Sternal, 4 Swivel Blades	20.3	3.8	2.9	20.3

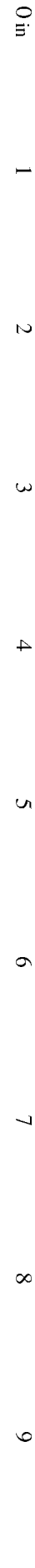

CVT RETRACTORS

Sternal Closure

PILLING®-WOLVEK STERNAL APPROXIMATION AND FIXATION SYSTEM



342000

The Wolvek System with its unique suture locking device affords positive, secure sternal approximation and elimination of the problems associated with twisted wire.

Low Profile Stainless Steel Locking Plate:

- Eliminates need for twisting wire.
- More secure closure, at least twice the tensile strength of twisted wire.
- Greater patient comfort.
- Eliminates chance of wire breakage associated with twisting action.
- Less chance of skin perforation.



342002

Sternal Approximator:

- Allows constant tension to be applied as each wire is tightened and locked.
- Provides rigid fixation which will lessen the motion between the edges of the sternum, hasten healing and provide more patient comfort.



342004

Complete P-W Approximator and Fixation System includes 1 Approximator, 1 Locking Plate Crimper, 1 Wire Cutter, Stainless Steel Storage and Case and 1 box 342006.



342006



142550

CATALOG #	DESCRIPTION
342000	Complete Pilling®-Wolvek Approximator and Fixation System Includes: 1 Approximator, 1 Locking Plate Crimper, 1 Wire Cutter, Stainless Steel Storage and Case and 1 box 342006 (Locking Plates).
342002	Sternal Approximator
342004	Locking Plate Crimper
342006	Locking Plates (suture not included) 8 plates per package (10 packages per box). Only the following sternal sutures and needles should be used with locking plates. Deknatel® Product No. 29-7271M4 Ethicon Product No. M650 The suture wire supplied by these manufacturers is manufactured from type 316L stainless steel as are the locking plates. Suture wire of unknown origin or type may not be metallurgically compatible with the locking plates.
142550	Pilling® Stainless Steel Wire Cutter, 6-7/8" (17.5 cm)
343030	Berry Sternal Needle Holder, 7-3/4" (19.5 cm), TC
342008	Stainless Steel Storage and Case for System, 15" x 10-1/2" x 2"

CVT RETRACTORS

Sternal Closure

KIRKLIN STERNAL AWLS



342043



342044

For use in wiring the sternum. Wrench included.

CATALOG #	DESCRIPTION
342043	Working length 2" (5 cm), 7-1/8" (18 cm)
342044	Needle only for Kirklin awl, 2-3/4" (7 cm)

SWEET MODIFIED STERNAL PUNCH



342040

Perforating blade is hook-shaped to bring suture material back through hole. Dull, non-glare finished stainless steel.

CATALOG #	DESCRIPTION
342040	10" (25.5 cm)

Hand-Held

ALLISON LUNG RETRACTORS



341678



341679

Wire, spatula-shaped blade.

CATALOG #	DESCRIPTION
341678	Child size, 10-1/4" (26 cm)
341679	Adult Size, 12-3/8" (31.5 cm)



CVT RETRACTORS

Hand-Held

CUSHING DECOMPRESSION RETRACTOR



CATALOG #	DESCRIPTION
481220	21 x 10 mm blade, 8-1/8" (20.5 cm)

CUSHING NERVE AND VEIN RETRACTOR



Pilling® Pattern, satin finish.

CATALOG #	DESCRIPTION
164865	12 mm wide blade, 8-1/2" (21.5 cm)

CUSHING NERVE AND VEIN RETRACTORS



Weck® Pattern, bright finish.

CATALOG #	DESCRIPTION
481230	16 x 15 mm blade, 8-5/8" (22 cm)
481231	14.5 x 15 mm blade, 12-3/4" (32.5 cm)

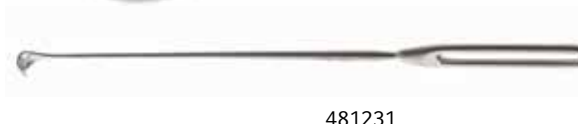

CVT RETRACTORS

Hand-Held

DAVIDSON SCAPULA RETRACTORS



CATALOG #	DESCRIPTION
341650	Small size, blade 2" (5 cm) wide, 7-3/4" (19.5 cm)
341651	Large size, blade 3-1/2" (9 cm) wide, 7-3/4" (19.5 cm)

HAIGHT RETRACTORS



Malleable "T"-shaped blades. For abdominal and intra-thoracic surgery.

CATALOG #	DESCRIPTION
341690	3" wide x 11-1/2" long (7.5 x 29 cm)
341692	3-1/2" wide x 11-3/4" long (9 x 30 cm)
341694	4" wide x 12" long (10 x 30.5 cm)
341696	4-3/4" wide x 12-3/4" long (12 x 32.5 cm)
341698	5-1/2" wide x 13-1/2" long (14 x 34.5 cm)



CVT RETRACTORS

Hand-Held

ROOS BRACHIAL PLEXUS ROOT RETRACTOR



341992

Designed to protect the T-1 cervical root from trauma by the rib shears or other instruments during posterior resection of the first rib. 14-1/4" (36 cm) length, 10" (25.5 cm) working length.

CATALOG #	DESCRIPTION
341992	Angled, 13.5 mm wide blade

WYLIE RENAL VEIN RETRACTORS



341795

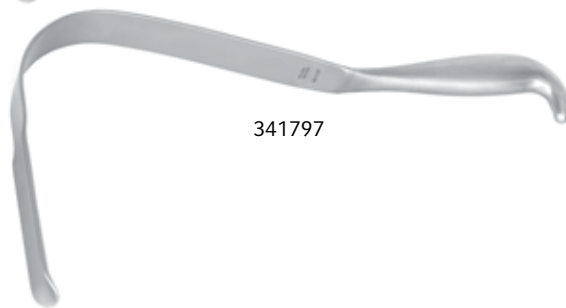

341797

Designed for the retraction of the left renal vein during procedures on the abdominal aorta or renal arteries. Gently curved distal tip for atraumatic control. Stainless steel.

CATALOG #	DESCRIPTION
341795	Short, 1" wide x 3-3/4" deep (2.5 x 9.5 cm) blade, 11-3/4" (30 cm)
341797	Long, 1" wide x 6-7/8" deep (2.5 x 17.5 cm) blade, 12-3/4" (32.5 cm)



CVT RETRACTORS

Henly-Type Retractors

PILLING® MULTIPURPOSE RETRACTORS



A versatile, self-retaining Henly-type retractor designed for use in the following surgical specialties: peripheral vascular surgery in the carotid, subclavian, femoral, popliteal and tibial regions. Spinal surgery in the cervical and lumbar regions. Orthopedic surgery in shoulder and hip procedures. General surgery for inguinal hernia, appendectomy and many minor procedures.

CATALOG #	DESCRIPTION
351666	Side blade 1-1/8" x 7/8" (3 x 2 cm) for 351675
351667	Side blade 2-1/8" x 7/8" (5.5 x 2 cm) for 351675
351668	Side blade 3-1/8" x 7/8" (8 x 2 cm) for 351675
351669	Center blade, 7/8" x 5/8" (2 x 1.5 cm) for 351675
351670	Center blade, 1-1/8" x 5/8" (3 x 1.5 cm) for 351675
351671	Center blade, 1-1/4" x 5/8" (3 x 1.5 cm) for 351675
351672	Center blade, 2" x 5/8" (5 x 1.5 cm) for 351675
351673	Center blade, 2-1/2" x 5/8" (6.5 x 1.5 cm) for 351675
351675	Pilling® Multipurpose Retractor, complete with: <ul style="list-style-type: none"> • 1 Frame with 3-1/8" (7.8 cm) spread • 3 Center Blades in sizes 7/8" (2.2 cm), 1-1/8" (2.8 cm), 1-1/4" (3.2 cm) deep x 5/8" (1.6 cm) wide • 3 pair of Side Blades 1-1/8" (2.9 cm), 2-1/8" (5.5 cm), and 3-1/8" (8.0 cm) deep x 7/8" (2.2 cm) wide • Self-retaining, with interchangeable center and side blades. Ball-snap attachment of side blades. Swivel side blades rotate 360 degrees.
351784	Two Extra Long Center Blades Sizes 1-1/2" (3.8 cm) and 1-3/4" (4.5 cm) deep x 5/8" (1.6 cm) wide Fits all Henly and Multipurpose Retractors

CVT RETRACTORS

Henly-Type Retractors

IMPROVED HENLY RETRACTORS



351679

With interchangeable center blades and side blades.

CATALOG #	DESCRIPTION
351679	Henly Retractor with straight arms, side blades slide onto arms, complete with blades
351680	Henly Retractor with arms spread outward. Both are complete with: 1 Frame 3 Center Blades in size 3/4" (2.2 cm), 1" (2.5 cm), 1-1/4" (3.2 cm) deep x 5/8" (16 mm) wide 1 Pair Side Blades, blunt prongs, 7/8" (2.2 cm) wide by 2" (5.1 cm) deep 1 Pair Side Blades, blunt prongs, 7/8" (2.2 cm) wide by 3" (7.6 cm) deep



351680

IMPROVED HENLY RETRACTOR SIDE BLADES



341676

Shallow, medium and deep interchangeable sliding side blades.

CATALOG #	DESCRIPTION
351676	1 pair, 1" x 7/8" (2.5 x 2 cm)
351677	1 pair, 2" x 7/8" (5 x 2 cm)
351678	1 pair, 3" x 7/8" (7.5 x 2 cm)

CVT RETRACTORS

Henly-Type Retractors

MAINI SIDE BLADE FOR IMPROVED HENLY RETRACTOR



351661

CATALOG #	DESCRIPTION
351661	2-3/4 x 2" (7 X 5 cm), slide-on

MAINI RICHARDSON DOUBLE-ENDED CENTER BLADE FOR HENLY RETRACTOR



351664

CATALOG #	DESCRIPTION
351664	Blade ends are 31 mm and 40 mm wide

ORIGINAL HENLY POPLITEAL RETRACTOR

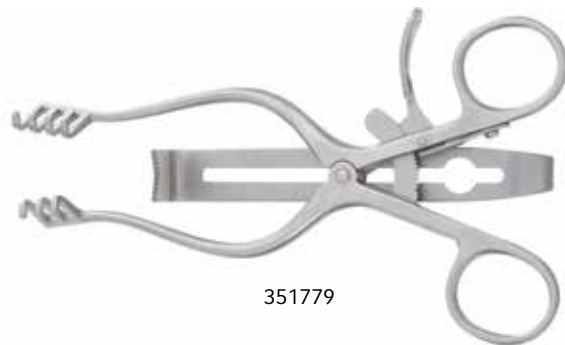

351779

A modification of the Weitlaner Retractor with provisions for attachment of a third retractor blade for improved exposure in either the popliteal or carotid positions. Supplied with 3 center blades. The retraction surfaces of the center blades are grooved for soft tissue retraction.

CATALOG #	DESCRIPTION
351779	4 x 3 prongs, center blades: 5/8" wide x 3/4" deep (1.5 x 2 cm), 5/8" wide x 1" deep (1.5 x 2.5 cm), 5/8" wide x 1-1/4" deep (1.5 x 3 cm), overall length 6-3/8" (16 cm)

VALVE INSTRUMENTS

Valve Retractors

COOLEY MITRAL VALVE RETRACTORS

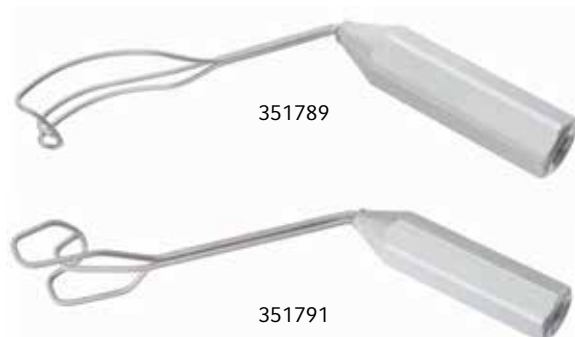

Designed to provide optimum exposure of the mitral valve, particularly for complete valve replacement. The wire frame blades are shaped to help solve exposure problems in the approach from a right or left thoracotomy and are therefore available as Right and Left Retractors.

CATALOG #	DESCRIPTION
351788	Right, small blade width 7/8" (2 cm), depth 1/2" (1.5 cm), overall length 7-1/4" (18.5 cm)
351789	Right, medium blade width 1-3/8" (3.5 cm), depth 3/4" (2 cm), overall length 7-1/2" (19 cm)
351790	Right, large blade width 1-7/8" (4.5 cm), depth 1-3/8" (3.5 cm), overall length 7-3/8" (19 cm)
351791	Left, large blade width 1-7/8" (4.5 cm), depth 3/8" (1 cm), overall length 8-7/8" (22.5 cm)

PEDIATRIC UNIVERSAL CLAMPS



341531

CATALOG #	DESCRIPTION
341531	Set of 2

CRAWFORD AORTIC RETRACTORS



351774

To retract aortic incision exposing aortic valve in replacement operation. Incision is made about an inch beyond the heart, about halfway around the circumference of the aorta. This retractor retracts the lower lip, exposing the valve.

CATALOG #	DESCRIPTION
351773	Small, blade 15 mm wide x 20 mm deep, 7-3/8" (18.5 cm)
351774	Large, blade 22 mm wide x 20 mm deep, 7-7/8" (20 cm)

VALVE INSTRUMENTS

Valve Retractors

DESMARRES VALVE RETRACTORS



351769

Lightweight blades of various sizes constructed of Beryllium Copper. Shafts are semi-malleable. Length 7-1/4" (18.5 cm).

CATALOG #	DESCRIPTION
351767	Width 4 mm
351768	Width 6 mm
351769	Width 8 mm
351770	Width 10 mm
351771	Width 12 mm
351772	Width 15 mm

MORSE VALVE RETRACTOR



351780

Cushing-shaped blades 12 mm deep.

CATALOG #	DESCRIPTION
351780	Blade 1-5/8" (42 mm) wide, 8-1/2" (21.5 cm)

REVUELTA GARCIA VALVE LEAFLET RETRACTOR



351747

CATALOG #	DESCRIPTION
351747	8" (20.5 cm) working length



VALVE INSTRUMENTS

Valve Retractors

LEMOLE-PILLING® VALVE RETRACTOR



341506

Provides self-retaining valve retraction. Fits directly onto arms of many types of sternal retractors. The T-Frame cross bar attaches to the sternal retractor by means of a "C" clamp. 8" (20.3 cm) T-Frame cross bar allows for addition of valve retractor blades without removing previously placed blades, using universal clamps. Set includes 6 valve retracting blades and 2 universal clamps. Various size blades available for any size atrium.



341511



341512



341513



341520



341522



341523

CATALOG #	DESCRIPTION	
341501	Lemole-Pilling® Valve Retractor Set #1 Fits Cooley and Chaux Sternal Retractors	
341502	Lemole-Pilling® Valve Retractor Set #2 Fits Morse-style Retractors	
341503	Lemole-Pilling® Valve Retractor Set #3 Fits Ankeney Retractor	
341506	Lemole-Pilling® Valve Retractor Set #1 with Cooley Retractor (341195)	
341511	Lemole-Pilling® T-Frame #1 only	
341512	Lemole-Pilling® T-Frame #2 only	
341513	Lemole-Pilling® T-Frame #3 only	
COMPLETE SET INCLUDES		QTY.
341520	Universal Clamp for Lemole	2
341522	Cooley Atrial Retractor, small, 9-1/2" (24 cm)	2
341523	Cooley Atrial Retractor, medium, 9-1/2" (24 cm)	1
341524	Cooley Atrial Retractor, large, 9-1/2" (24 cm)	1
341525	Malleable Atrial Retractor, 8-3/4" (22 cm)	2
341511, 341512, or 341513	T-Frame only for type #1, #2 and #3	1

VALVE INSTRUMENTS

Valve Retractors

CHAUX-LEMOLE BI-ANGLE T-FRAME



341514

Bi-Angle T-Frame, for additional third point atrial retraction during mitral valve surgery, fits Cooley-style and Chaux Retractors.

CATALOG #	DESCRIPTION
341514	Arm tip maximum diameter 0.252", overall width 9-7/8" (25 cm)

LEMOLE SELF RETAINING ATRIAL RETRACTOR



351783

Designed to eliminate the need for an assistant when retracting the left atrium during mitral valve repair or replacement. Will attach to most standard chest retractors.

CATALOG #	DESCRIPTION
351783	10-1/2" (26.5 cm)



VALVE INSTRUMENTS

Valve Retractors

LEMOLE SIDE ARM EXTENSION



341515

CATALOG #	DESCRIPTION
341515	For third point atrial retraction during mitral valve surgery, fits Cooley-style and Chaux Retractors.

ABLAZA-BLANCO CARDIAC VALVE RETRACTOR



351763

Notched to prevent slippage in use.

CATALOG #	DESCRIPTION
351763	Angulated, blade 9/16" (1.5 cm) wide, 13" (33 cm)

BLANCO VALVE INSTRUMENTS



351750



351752

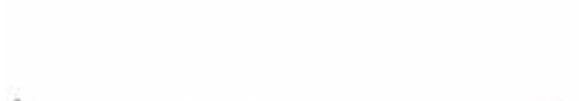

351754

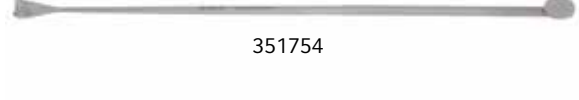

351755

Long, slender shaft retractors with small, thin blades specially made for use on heart valves. The "spreader" is a fenestrated retractor designed to allow the insertion of the scissors blades. All have a finger rest on a knurled handle. Working length of shaft is 7-1/16" (18 cm).

CATALOG #	DESCRIPTION
351750	Blanco Retractor, blade 5 mm wide x 7 mm deep, 11-1/2" (29 cm)
351752	Blanco Retractor, blade 7 mm wide x 7 mm deep, 11" (28 cm)
351754	Blanco Retractor, Cushing type, blade 12 mm wide x 7 mm deep, 11" (28 cm)
351755	Blanco Valve Spreader, blade 9 mm wide x 10 mm deep, 11-1/2" (29 cm)

VALVE INSTRUMENTS

Suture Rings

CRAWFORD SUTURE RING



352598

Affords a convenient method of retaining sutures in mitral and aortic valve replacement.

CATALOG #	DESCRIPTION
352598	Diameter 10" (25.5 cm)

GRUNWALD SUTURE GUIDE HOLDER



342015

The Grunwald Suture Guide Holder, when used with the Gabbay-Frater™ Suture Guides (pg. 1158), affords a convenient method of keeping numerous sutures properly aligned during cardiac valve replacement procedures. The holder can be positioned directly over the sternotomy retractor. Three spring clips on the underside of the holder secure it to the surgical drapes. Three sterile, disposable Gabbay-Frater™ Suture Guides may be placed on the retaining posts of the holder either before or after placement of the holder over the sternotomy. The Grunwald Holder provides a flat, constant and secure surface for the suture guides and speeds placement by eliminating the need for using numerous towel clips that can also tend to clutter the operative field. The Grunwald Suture Guide Holder is made of stainless steel and may be steam autoclaved.

CATALOG #	DESCRIPTION
342015	13-1/4" (33.5 cm)

VALVE INSTRUMENTS

Aortic Valve Rongeurs

BAILEY AORTIC VALVE RONGEURS



These instruments were designed for the removal of calcified material from the stenotic aortic valve. They have also proven useful in peripheral vascular surgery for trimming stenotic arteries and plaque removal. They are in six styles but all have the same 3.5 mm wide-bite. Working length 5-1/8" (13 cm).

CATALOG #	DESCRIPTION
352800	Straight biting
352802	Slight downward angle (25 degrees)
352804	Acute downward angle (70 degrees)
352806	Right downward angle (90 degrees)
352808	Angled to left side (45 degrees)
352810	Angled to right side (45 degrees)

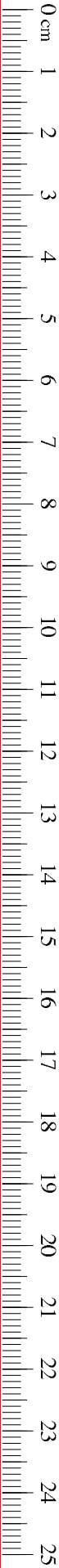

VALVE INSTRUMENTS

Valve Hooks

CARDIAC VALVE HOOK, CALIBRATED

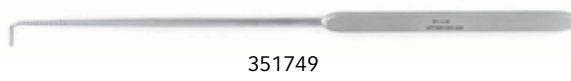

CATALOG #	DESCRIPTION
351749	9-3/4" (24.5 cm), 10 mm hook

COARCTATION HOOK

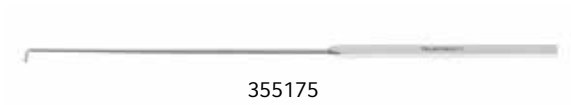

Stainless steel.

CATALOG #	DESCRIPTION
355175	Right angle bend, blunt tip, 7 mm hook, 10-1/8" (25.5 cm)

DEBAKEY VALVE HOOK

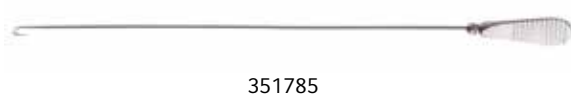

Slender shaft, sharp-pointed hooks used to aid in manipulation of valves in replacement operations.

CATALOG #	DESCRIPTION
351785	3/8" (8.5 mm) hook, 12-1/2" (31.5 cm)

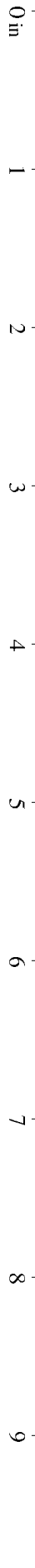

VALVE INSTRUMENTS

Valve Hooks

MICRO VASCULAR NERVE HOOK

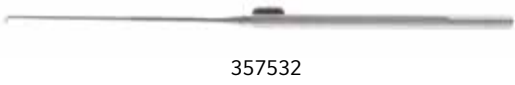

357532

CATALOG #	DESCRIPTION
357532	Micro hook, small, 7-1/4" (18.5 cm)

SISSON NERVE HOOK



060120

CATALOG #	DESCRIPTION
060120	90 degree angled, blunt, 6 mm hook, 6-1/8" (15.5 cm)

REVUELTA-GARCIA VALVE MIRROR



351737

CATALOG #	DESCRIPTION
351737	9" (23 cm)

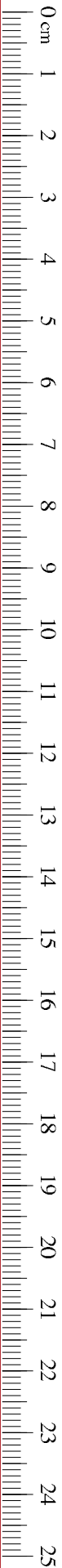

VALVE INSTRUMENTS

Valve Dilators

GERBODE VALVE DILATOR



For retrograde fracture of the mitral valve through a small incision in the apex of the left ventricle. It has a regulating screw so that the mitral valve can be gradually fractured. May also be used for fracture of the aortic and pulmonary valves.

CATALOG #	DESCRIPTION
352615	Blades adjustable, opening to 1-3/4" (4.5 cm) wide

TUBBS VALVE DILATOR



CATALOG #	DESCRIPTION
352630	Maximum blade opening 1-3/4" (4.5 cm) wide

VALVE INSTRUMENTS

Coronary Perfusion Catheters

JEHLE STERILE CORONARY CATHETERS



351476

Designed for aortic valve surgery and any cardiac or thoracic surgery requiring cardioplegia infusion directly into the coronary ostium or vein by-pass graft. Catheter is secured in the coronary ostium of the graft lumen due to the compression/expansion of the foam cuff, eliminating the need to suture catheter in position.

- Soft, tapered polyurethane foam cuff on distal end of catheter.
- Malleable, twisted stainless steel wire incorporated into distal end of catheter.
- Flexible silicone tubing.
- Pre-packaged sterile, for single use only.

CATALOG #	QUANTITY	OVERALL LENGTH	CUFF SIZE DIAMETER	CATHETER DIAMETER (ID/OD)
351470	Box of 5	20-1/4" (51.5 cm)	9/32" (7.1 mm)	1.14/2.54 mm
351472	Box of 5	20-1/4" (51.5 cm)	11/32" (8.7 mm)	1.14/2.54 mm
351474	Box of 5	20-1/4" (51.5 cm)	13/32" (10.3 mm)	1.73/3.45 mm
351476	Box of 5	20-1/4" (51.5 cm)	15/32" (11.9 mm)	1.73/3.45 mm



NICHOLAS-JEHLE STERILE MULTI-HEADED PERFUSION CATHETER



351490

Incorporates all four Jehle catheter/cuff sizes on one common catheter.

CATALOG #	DESCRIPTION
351490	Box of 5

AORTIC PUNCHES

Providing surgeons with the precise performance they demand during CABG surgery

Teleflex® Premium Diamond Edge Aortic Punch

FREE-FLOAT CUTTING ACTION TECHNOLOGY

By allowing the diamond edge blade to “float” around the punch core during operation, alignment is maintained and mechanical jamming is prevented. One punch can be used to create multiple punches in a single procedure.

DUAL-CUTTING ACTION

Two diamond-sharp cutting surfaces lift and cleanly cut through all layers of tough tissue. The smooth cutting action reduces trauma while the tapered distal portion increases visibility around the anastomotic site.

PREMIUM DIAMOND-EDGE AORTIC PUNCH, FULL LENGTH



DP-48K

CATALOG #	DESCRIPTION	SIZE	QUANTITY
DP-28K	Full Length Sterile (7-3/4" Handle)	2.8 mm	6
DP-36K	Full Length Sterile (7-3/4" Handle)	3.6 mm	6
DP-40K	Full Length Sterile (7-3/4" Handle)	4.0 mm	6
DP-44K	Full Length Sterile (7-3/4" Handle)	4.4 mm	6
DP-48K	Full Length Sterile (7-3/4" Handle)	4.8 mm	6
DP-52K	Full Length Sterile (7-3/4" Handle)	5.2 mm	6
DP-56K	Full Length Sterile (7-3/4" Handle)	5.6 mm	6
DP-60K	Full Length Sterile (7-3/4" Handle)	6.0 mm	6

PREMIUM DIAMOND-EDGE AORTIC PUNCH, MID-LENGTH



MDP-48K

CATALOG #	DESCRIPTION	SIZE	QUANTITY
MDP-28K	Mid-Length Sterile (6-3/4" Handle)	2.8 mm	6
MDP-36K	Mid-Length Sterile (6-3/4" Handle)	3.6 mm	6
MDP-40K	Mid-Length Sterile (6-3/4" Handle)	4.0 mm	6
MDP-44K	Mid-Length Sterile (6-3/4" Handle)	4.4 mm	6
MDP-48K	Mid-Length Sterile (6-3/4" Handle)	4.8 mm	6
MDP-52K	Mid-Length Sterile (6-3/4" Handle)	5.2 mm	6
MDP-56K	Mid-Length Sterile (6-3/4" Handle)	5.6 mm	6
MDP-60K	Mid-Length Sterile (6-3/4" Handle)	6.0 mm	6



AORTIC PUNCHES

Reusable Punches

WYLIE CALCIFIED ARTERIAL PUNCH



CATALOG #	DESCRIPTION
352825	Punches 1.3 mm hole, 8" (20.5 cm)



HEPARIN CANNULAE

HEPARIN CANNULA WITH LUER-LOK



A complete line of stainless steel, reusable heparin cannulae. A selection of sizes, shapes and lengths provides for a variety of uses in flushing, irrigation and injection. Applications include peripheral vascular, cardiac, general, orthopedic, urology and neuro surgery.

CATALOG #	DESCRIPTION
351560	Stoney Heparin Injector 1-7/8" (4.5 cm)
351573	Zanger Heparin Cannula, malleable, 4 mm tip, 2-1/2" (6.5 cm)
351574	Horsely Heparin Cannula, 2-3/8" (6 cm)
351575	DeBakey® Heparin Cannula, malleable, 3 mm tip, 2-1/2" (6.5 cm)
351576	DeBakey® Heparin Cannula, malleable, 3.7 mm tip, 2-7/8" (7.5 cm)
351577	DeBakey® Heparin Cannula, malleable, 4 mm tip, 6" (15 cm)
351578	23 gauge tip, 2-1/8" (5.5 cm)
351586	Garrett Heparin Injector, malleable, 5/16" (8 mm) tip, working length 3" (7.5 cm)
351587	Garrett Heparin Injector, malleable, 1/2" (12 mm) tip, working length 3" (7.5 cm)
351593	Samson Heparin Injector, malleable, small 7 mm tip, 3-3/8" (8.5 cm)
351594	Samson Heparin Injector, malleable, medium 9 mm tip, 3-3/8" (8.5 cm)





SUCTION TUBES

ANDREWS INFANT SUCTION TUBE



6 mm diameter tip, permanently attached.

CATALOG #	DESCRIPTION
162310	9-1/4" (23.5 cm)

ANDREWS PYNCHON SUCTION TUBE



CATALOG #	DESCRIPTION
536220	Curved, 6 mm tip, 3 mm diameter removable shaft, 9-5/8" (24.5 cm)

MORSE-ANDREWS SUCTION TUBE



Short length, small 3 mm outside diameter tube, terminating in 6 mm diameter tip which has one distal and four side openings. Handle is ebonized.

CATALOG #	DESCRIPTION
351505	10-1/4" (26 cm)

COOLEY SUMP SUCTION TUBE



Long, removable perforated outer tube with internal extension provides for fluid removal by sump-drain principle. Entire tube removable from handle for cleaning and rotatable for convenience.

CATALOG #	DESCRIPTION
351547	Curved, 9 mm tip, 12-7/8" (32.5 cm)



SUCTION TUBES

DEBAKEY® SUCTION TUBES



Small diameter, curved tubes with finger valve control.

CATALOG #	DESCRIPTION
351500	9.5 mm tip, 11-3/8" (29 cm)
351501	DeBakey® Suction Tube Tip for 351500, 3/8" (9.5 mm)
351502	3 mm diameter tip, 12-1/4" (31 cm)

DEBAKEY®-ADSON CORONARY SUCTION TUBES



Distal opening with four side openings 3 mm long, 4 mm diameter.

CATALOG #	DESCRIPTION
351504	6-1/8" (15.5 cm)
351506	8-1/8" (20.5 cm)

BONNIER CATHETER ADAPTER



For attachment of catheters to Luer Tip Syringes.

CATALOG #	DESCRIPTION
507335	Large lumen



SUCTION TUBES

LUER-LOK CATHETER ADAPTER



507336

For attachment of catheters to Luer-Lok® Syringes.

CATALOG #	DESCRIPTION
507336	Small lumen, 1-1/2" (4 cm)

ABRAMS PLEURAL BIOPSY NEEDLE

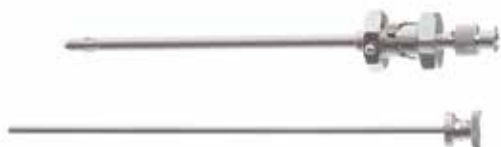

343295

Inner cannula acts as a guillotine to cut and retain specimen. Luer-Lok® Syringe Fitting.

CATALOG #	DESCRIPTION
343295	Needle, with trocar point, 13 gauge needle, 5-3/8" (13.5 cm)

VASCULAR DILATORS

Amato Design

AMATO PEDIATRIC DILATORS SET



352705

During the repair of complex congenital heart disease, the surgeon is required in many instances to locate orifices, trace the course of abnormal vessels, and perform various maneuvers of dilation and measurement of annulus or lumen diameters. In infants and children, the heart is usually confined within a small mediastinal space, precluding the use of conventional instruments presently available.

CATALOG #	DESCRIPTION
352705	Complete set of 10 with case. Tip lengths size 6-20 mm, handle and shaft lengths 6-1/2" (16.5 cm)

Cooley Design

COOLEY DILATORS



355315

5" (12.5 cm) long, aluminum handle.

CATALOG #	DESCRIPTION
355315	Set of 6, malleable aluminum shafts
355309	0.5 mm
355310	1.0 mm
355311	1.5 mm
355312	2.0 mm
355313	2.5 mm
355314	3.0 mm



VASCULAR DILATORS

DeBakey® Design

DEBAKEY® VASCULAR DILATORS



355287

Sets of dilators in graduated sizes, 1, 1.5, 2, 2.5, 3, 4, 5, 6, 7, 8, 9 and 10 mm. Supplied in 7-1/2" (19 cm) and 15" (38 cm) length.

CATALOG #	DESCRIPTION
355285	Set of 12, 7-1/2" (19 cm), in autoclavable stainless steel case
355287	Set of 12, 7-1/2" (19 cm), without case
355288	Coronary Set of 5, consists of 1.0 mm, 1.5 mm, 2.0 mm, 2.5 mm and 3.0 mm, with a length of 7-1/2" (19 cm) without case
355286	Case for 355287
355295	1.0 mm, 7-1/2" (19 cm) long
355296	1.5 mm, 7-1/2" (19 cm) long
355297	2.0 mm, 7-1/2" (19 cm) long
355298	2.5 mm, 7-1/2" (19 cm) long
355299	3.0 mm, 7-1/2" (19 cm) long
355300	4.0 mm, 7-1/2" (19 cm) long
355301	5.0 mm, 7-1/2" (19 cm) long
355302	6.0 mm, 7-1/2" (19 cm) long
355303	7.0 mm, 7-1/2" (19 cm) long
355304	8.0 mm, 7-1/2" (19 cm) long
355305	9.0 mm, 7-1/2" (19 cm) long
355306	10.0 mm, 7-1/2" (19 cm) long
355290	Coronary Set of 12, 15" (38 cm), in autoclavable stainless steel case, individual sizes of 15" dilators are available upon request
355292	Set of 12, 15" (38 cm), without case
355291	Case for 355292



355286



355292



355291

VASCULAR DILATORS

Garrett Design

GARRETT VASCULAR DILATORS



355089



355090

CATALOG #	DESCRIPTION
355089	Set of nine short dilators (1, 1.5, 2, 2.5, 3, 3.5, 4, 4.5 and 5 mm), 5-1/2" (14 cm) long in stainless steel storage cylinder
355080	Short 1 mm
355081	Short 1.5 mm
355082	Short 2.0 mm
355083	Short 2.5 mm
355084	Short 3.0 mm
355085	Short 3.5 mm
355086	Short 4.0 mm
355087	Short 4.5 mm
355088	Short 5.0 mm
355090	Set of nine long dilators (1, 1.5, 2, 2.5, 3, 3.5, 4, 4.5 and 5 mm), 8-1/4" (20.9 cm) long in stainless steel storage cylinder
355091	Long 1.0 mm
355092	Long 1.5 mm
355093	Long 2.0 mm
355094	Long 2.5 mm
355095	Long 3.0 mm
355096	Long 3.5 mm
355097	Long 4.0 mm
355098	Long 4.5 mm
355099	Long 5.0 mm



VASCULAR DILATORS

Garrett Design

GARRETT DILATOR HOLDERS



355100



355101

CATALOG #	DESCRIPTION
355100	8-1/8" (20.5 cm)
355101	5-1/8" (13 cm)

Hiebert Design

HIEBERT DOUBLE-ENDED VASCULAR DILATORS



355277

A half and full size dilating olive per dilator, saves time passing instruments back and forth. Malleable shafts. 6" (15.2 cm) overall length.

CATALOG #	DESCRIPTION
355275	0.5 mm x 1 mm
355276	1.5 mm x 2 mm
355277	2.5 mm x 3 mm
355278	3.5 mm x 4 mm



VALVULOTOMES

Antegrade Cut

VALVULOTOME ANTEGRADE CUT



352605

CATALOG #	DESCRIPTION
352605	5-7/8" (15 cm)

Mills-Type

MILLS VALVULOTOME



352610

For CABG vein grafts.

CATALOG #	DESCRIPTION
352610	Blade 2 mm long, 11-3/4" (30 cm)

In-Situ

IN-SITU VENOUS VALVULOTOME STERILIZING CASE



352611

A sturdy, stainless steel sterilizing case that holds up to four valvulotomes.

CATALOG #	DESCRIPTION
352611	Holds 4 In-Situ Valvulotomes, 14-5/8" (37 cm)

VALVULOTOMES

In-Situ

IN-SITU VENOUS VALVULOTOME



352613

Standard size blade inserted in an antegrade direction and withdrawn retrograde to incise valve cups.

CATALOG #	DESCRIPTION
352612	Blade 2 mm long, 9" (23 cm)
352614	Blade 2 mm long, 9-7/8" (25 cm)
352613	Blade 2 mm long, 11-3/4" (30 cm)

Bush

THE BUSH™ RETROGRADE VALVULOTOME



352692

THE BUSH™ Valvulotome provides a precise cutting instrument for the simultaneous cutting of both venous valve cusps in the greater saphenous vein during in-situ bypass surgery. The recessed "shark-tooth" blades penetrate the valve tissue, to cut the leaflets and reduce the possibility of traumatizing the vein wall intima and tributary branches. The surgeon can select from 2, 3 or 4 mm head sizes.

Dome-shaped head with 2 recessed opposing "shark-tooth" blades pierce valve tissue cutting both leaflets in one pass. The self-centering cutting head and dilating olive achieve proper cutting head alignment. Three head sizes in 2 different lengths provides a selection to fit most surgical needs. The control wire is a mono-filament stainless steel wire.

CATALOG #	DESCRIPTION
352680	Set of 3 (2, 3, 4 mm heads, 1 each), 15-3/4" (40 cm)
352681	2 mm head, 15-3/4" (40 cm)
352682	3 mm head, 15-3/4" (40 cm)
352683	4 mm head, 15-3/4" (40 cm)
352690	Set of 3 (2, 3, 4 mm heads, 1 each), 37-3/8" (95 cm)
352691	2 mm head, 37-3/8" (95 cm)
352692	3 mm head, 37-3/8" (95 cm)
352693	4 mm head, 37-3/8" (95 cm)

MEDIASTINOSCOPY

Mediastinoscopes

CARLENS MEDIASTINOSCOPES



522301

The Carlens Mediastinoscopes come in short, long and extra-long lengths. The short model is suitable for inspection of the mediastinum above the bifurcation, while the long and extra-long models are designed for the region of the carina. Supplied with one light carrier.

CATALOG #	SCOPE SIZE	OVERALL LENGTH	MIN. I.D.	NOMINAL PROXIMAL DIMENSIONS	MAX O.D.	REPLACE CARRIER
522300P	Short	116 mm	10.8 mm	16.0 mm	18.4 mm	526350
522301	Long	162 mm	11.0 mm	18.0 mm	22.3 mm	526351
522302	Extra-Long	191 mm	11.9 mm	19.0 mm	22.3 mm	526352

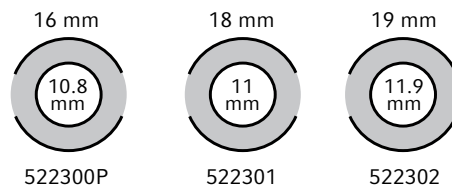

Drawings illustrate Nominal Proximal Internal Dimensions and Minimum Internal Diameter (I.D.), **NOT TO SCALE**

IMPROVED TUCKER MEDIASTINOSCOPE



522311

The Improved Tucker Mediastinoscope has the highest light output of any mediastinoscope and is suited for use in conjunction with the operating microscope. Scope is supplied with an extra-large diameter fiber optic light carrier and integral 6 ft. long, autoclaveable connecting cable.

CATALOG #	SCOPE SIZE	OVERALL LENGTH	MIN. I.D.	NOMINAL PROXIMAL DIMENSIONS	MAX O.D.	REPLACE CARRIER
522306	Short	147 mm	12.8 mm	24.1 x 14.2 mm	23.3 mm	527853
522311	Long	180 mm	12.3 mm	27.0 x 15.0 mm	23.2 mm	527850

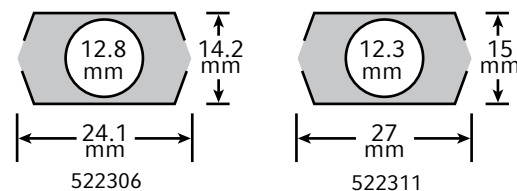

Drawings illustrate Nominal Proximal Internal Dimensions and Minimum Internal Diameter (I.D.), **NOT TO SCALE**



MEDIASTINOSCOPY

Instrumentation

ASPIRATING NEEDLE

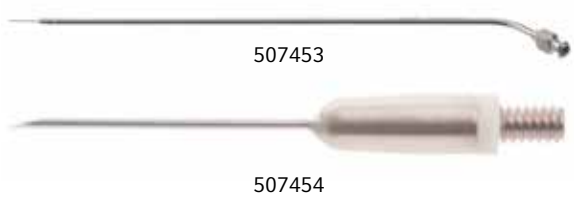

CATALOG #	DESCRIPTION
507453	Reinforced angled shaft, with protective cover, distal needle 23 Ga., working length 8-1/4" (21 cm)
507454	Spare distal needle tip for aspirating needle

INSULATED SUCTION CAUTERY TUBE



Fully insulated with thumb-valve for controlled suction.

CATALOG #	DESCRIPTION
507045	Supplied with 10 ft (305 cm) Bovie Cord and plug (507046)

BOVIE CORD FOR SUCTION TUBE



For insulated suction.

CATALOG #	DESCRIPTION
507046	10 ft (305 cm)

MEDIASTINOSCOPY

Instrumentation

BOVIE PENCIL HANDLE



351970

With connecting cord.

CATALOG #	DESCRIPTION
351970	5-1/8" (13 cm)

JACKSON ALLIGATOR GRASPING FORCEPS

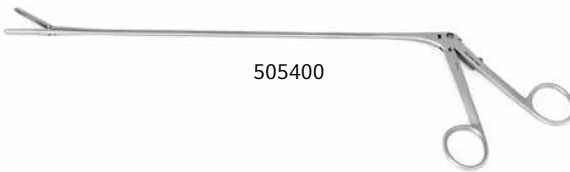

505400

CATALOG #	DESCRIPTION
505400	Standard, deeply serrated and grooved jaws, 4 mm wide by 23 mm long, working length 11-1/8" (28 cm)
505420	Small, finely serrated jaws taper from 3 mm to 1.55 mm width, 17 mm long, working length 11-3/4" (30 cm)

JACKSON CUP FORCEPS - STANDARD, MEDIUM LIGHTWEIGHT

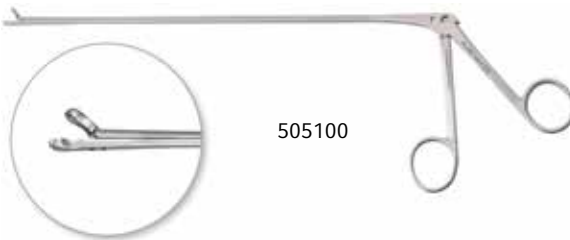

505100

Jackson Forceps come in standard and extra-lightweight construction that provides durability and strength. The jaw size, shape and angle are specially calculated for use through Jackson scopes.

CATALOG #	DESCRIPTION
505100	Straight, 4 mm diameter jaw, working length 28 cm
505104	Angled, 4 mm diameter jaw, working length 28 cm

MEDIASTINOSCOPY

Instrumentation

JACKSON CUP FORCEPS - EXTRA LIGHTWEIGHT



Jackson Forceps come in standard and extra-lightweight construction that provides durability and strength. The jaw size, shape and angle are specially calculated for use through Jackson scopes.

CATALOG #	DESCRIPTION
505110	Straight, 2 mm diameter jaw, working length 20 cm
505112	Straight, 2 mm diameter jaw, working length 28 cm
505114	Angled, 2 mm diameter jaw, working length 20 cm
505116	Angled, 2 mm diameter jaw, working length 28 cm

PATTERSON ELONGATED CUP BITING FORCEPS



CATALOG #	DESCRIPTION
505230	Regular, 4 mm jaw width, 11-1/8" (28 cm)

MEDIASTINAL BLUNT-TIPPED DISSECTING FORCEPS

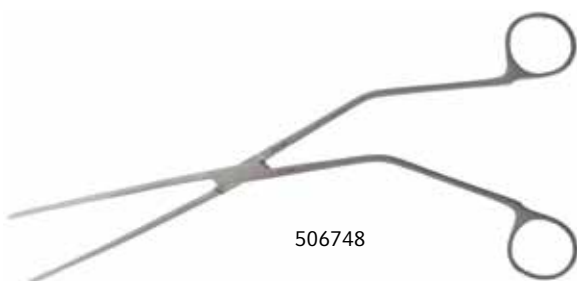

CATALOG #	DESCRIPTION
506748	Serrated, 16 mm tip, working length 7-1/2" (19 cm), 12" (31 cm)

0 in

1

2

3

4

5

6

7

8

9

MEDIASTINOSCOPY

Instrumentation

NORRIS SPONGE HOLDING FORCEPS



Bayonet-shaped, cross action forceps designed for use in mediastinoscopy. Straight distal portion of jaw is 16 cm long.

CATALOG #	DESCRIPTION
506747	Straight, serrated, 3.6 mm tip, 13-1/8" (34 cm)

Scope Holders

TOBEY LARYNGOSCOPE HOLDER



The laryngoscope/mediastinoscope holder with a quick attach/release mechanism that provides a secure hold of your laryngoscope. With the blue thumb tab mechanism on the Tobey Laryngoscope Holder, there is no more twisting or turning necessary to lock the laryngoscope into the holder. The Tobey Laryngoscope Holder also allows for fine-tune adjusting using the size adjustment knob for different laryngoscope handles.

CATALOG #	DESCRIPTION
502248	Overall width, 9" (23 cm)



MEDIASTINOSCOPY

Clips and Appliers

ALLIGATOR APPLYING FORCEPS AND LIGATING CLIPS

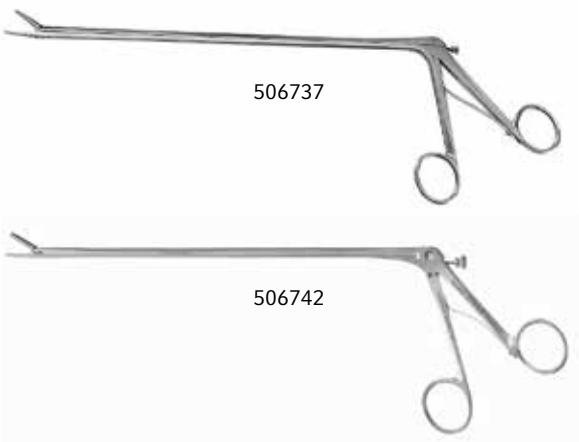

Drew and Scoville forceps for use with McKenzie "V" clips and Duane "U" clips. Jaw opening is controlled by screw mechanism in handle. Stainless steel. Length 9-3/4" (25 cm). McKenzie and Duane clips are non-magnetic and made of Sterling Silver.

CATALOG #	DESCRIPTION
506737	Drew Forceps, serrated jaws
506742	Scoville Forceps, slotted jaws
506743	McKenzie "V" clips, smooth, vial of 100
506744	McKenzie "V" clips, serrated, vial of 100
506746	Duane "U" clips, smooth, vial of 100
506749	Clip holding magazine, single row, weighted, manual loading for Duane and McKenzie clips



506743



506744



506746



506749

VIDEO-ASSISTED THORACOSCOPY

Retractors

HEITMILLER MINI THORACOTOMY RETRACTOR



341310

Designed by Dr. Richard Heitmiller.

CATALOG #	DESCRIPTION
341310	This retractor provides excellent exposure for video-assisted thoracoscopy, open lung biopsies, transaxillary incisions and mid-CAB procedures in which mini-thoracotomy incisions are used. With its small "footprint," it also is ideal for mobilizing lung adhesions during video thoracotomies.

Landreneau Design

Landreneau Thoracoscopy Instruments are used in video-assisted thoracoscopy and minimally invasive procedures. Their unique design overcomes the limitations of the central-hinge on standard open instruments, enabling the instruments to be fully functional when placed through a small incision. Elongated shafts and large jaws provide extended reach while the ring-handled design offers the comfort and familiarity of a traditional open instrument. A custom tray is available to protect your instrument investment.

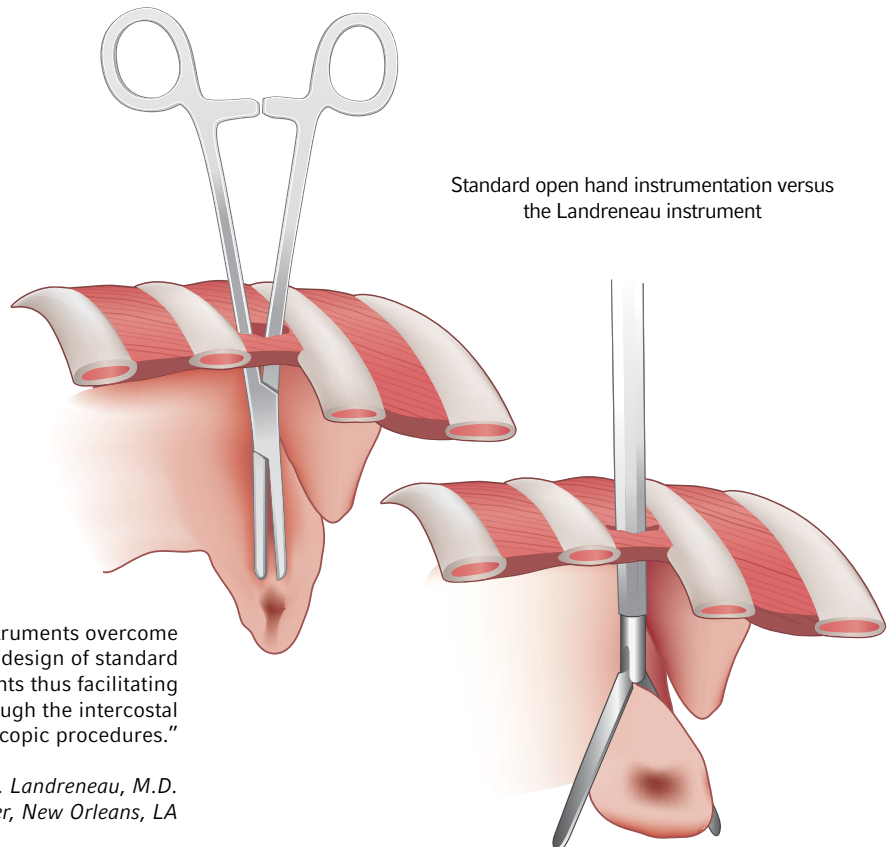

Standard open hand instrumentation versus the Landreneau instrument

"The Landreneau design instruments overcome the limitations of the central hinge design of standard (open) hand surgical instruments thus facilitating instrument manipulation through the intercostal access during thoracoscopic procedures."

*Rodney J. Landreneau, M.D.
Ochsner Medical Center, New Orleans, LA*



VIDEO-ASSISTED THORACOSCOPY

Landreneau Design

PENNINGTON GRASPING FORCEPS



131114A

CATALOG #	DESCRIPTION
131114A	10.2 mm tip width, 10 mm shaft diameter, 13 cm shaft length, locking, 7-7/8" (20 cm) working length

STRAIGHT MASHER GRASPING FORCEPS



211116A

CATALOG #	DESCRIPTION
211116A	Thin, teardrop-shaped, 10 mm diameter, 21 cm shaft length, locking, 7.8 mm tip width, 11-3/4" (30 cm) working length

CURVED MASHER GRASPING FORCEPS



211117A

CATALOG #	DESCRIPTION
211117A	Thin, teardrop-shaped, tip curved 20 degrees, 7.8 mm tip width, 21 cm shaft length, locking

VIDEO-ASSISTED THORACOSCOPY

Landreneau Design

STRAIGHT MASHER GRASPING FORCEPS



CATALOG #	DESCRIPTION
211118A	Round, 13.8 mm tip width, 21 cm shaft length, locking, 11-3/4" (30 cm) working length

STRAIGHT DEBAKEY GRASPING FORCEPS



CATALOG #	DESCRIPTION
211603A	10 mm diameter, 7 mm tip width, 21 cm shaft length, locking, 11-3/4" (30 cm) working length

LAWRENCE FINE DISSECTING FORCEPS

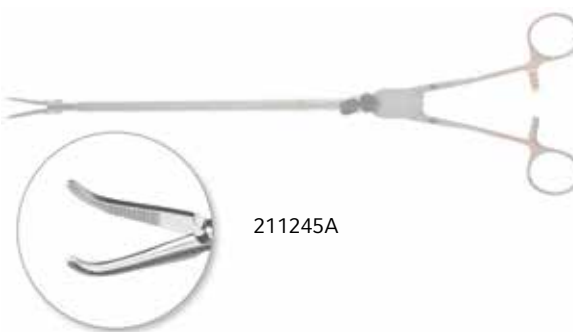

CATALOG #	DESCRIPTION
211245A	45 degree curved tip, 21 cm shaft length, locking, 9-7/8" (25 cm) working length, overall length 15-3/8" (39 cm)



VIDEO-ASSISTED THORACOSCOPY

Landreneau Design

MEEKER DISSECTING FORCEPS



211290A

CATALOG #	DESCRIPTION
211290A	90 degree curved, 2.7 mm tip width, 21 cm shaft length, locking, 9-3/4" (24.5 cm) working length

METZENBAUM SCISSORS CURVED



211325A

CATALOG #	DESCRIPTION
211325A	1.7 mm tip width, 10 mm diameter shaft, 21 cm shaft length, non-locking, 9-1/2" (24 cm) working length

STRAIGHT SINGLE ACTION NEEDLE HOLDER



215558A

CATALOG #	DESCRIPTION
215558A	5 mm diameter shaft, 21 cm shaft length, locking, 8-7/8" (23 cm) working length



VIDEO-ASSISTED THORACOSCOPY

Landreneau Design

LANDRENEAU THORACOSCOPY TRAY

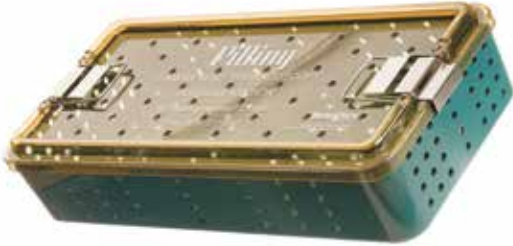

211500

CATALOG #	DESCRIPTION
211500	20-3/4" (52.5 cm) x 9-7/8" (25 cm)

LANDRENEAU THORACOSCOPY SET



211600

CATALOG #	DESCRIPTION
211600	Complete set. Includes all catalog codes in the Landreneau Design section (except 341310, the optional Heitmiller Mini Thoracotomy Retractor)

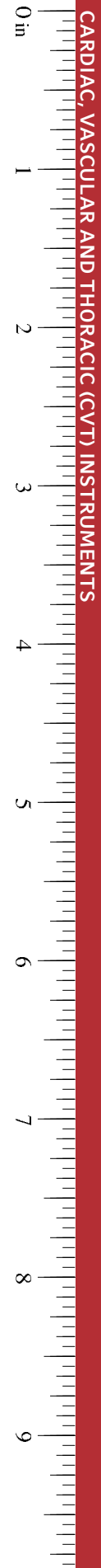

KAISER-PILLING® INSTRUMENTS

Instruments designed specifically for thoracoscopy that deliver the versatility you require and the feel to which you are accustomed.

Unique instruments with a “No Cannula” technique provide you with a versatility not found before in thoracoscopy procedures.

Elimination of cannulas allows for the use of traditional patterns of instruments that have been elongated and shaped to meet the special needs of the thoracoscopist. These new-dimensioned instruments provide you with the familiar feel,

weight and balance to which you are accustomed. This means you can rely on the practiced hand movements used in open procedures. The accessories extend your “reach” even farther.

Other advantages of the “No Cannula” procedure using these instruments are:

- Reduced patient costs since fewer cannulas are required
- Palpation of lesions is permitted
- Number of incisions is minimized as instrument length and shape permit access to all areas of the thoracic cavity

CATALOG #	DESCRIPTION
841000	Complete set includes: 166868, 841010, 841011, 841012, 841013, 841030, 841031, 841032, 841033, 841050, 841051, 841052, 841100, 841101, 841300, 841301, 841350, 841351, 841400, 841951
166868	Lahey instrument holder
841010	Ring forceps (1L)
841011	Ring forceps (2L)
841012	Ring forceps (4L)
841013	Ring forceps (3L)
841030	Ring forceps (1S)
841031	Ring forceps (2S)
841032	Ring forceps (4S)
841033	Ring forceps (3S)
841050	Atraugrip ring forceps (1AG)
841051	Atraugrip ring forceps (5AG)
841052	Atraugrip ring forceps (2AG)
841100	Biopsy forceps, malleable
841101	Biopsy forceps, rigid
841300	Spatula, slightly curved
841301	Spatula, acute curved
841350	Yankauer suction tube
841351	Andrews suction tube
841400	Hook, blunt
841951	2 tier storage tray



VIDEO-ASSISTED THORACOSCOPY

Kaiser-Pilling® Design

KAISER-PILLING® SHORT JAW RING FORCEPS



1 x 11 ratchets, 3-3/8" (8.5 cm) jaw.

CATALOG #	DESCRIPTION
841030	Straight (1S), 12-5/8" (32 cm)
841031	Curved (2S), 12-1/8" (31 cm)
841032	C-shaped (4S), 10-7/8" (28 cm)
841033	Curved on side (3S), 12" (30.5 cm)
841034	Curved handle, 11-7/8" (30 cm)

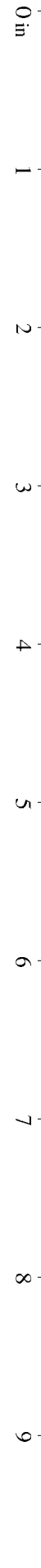

VIDEO-ASSISTED THORACOSCOPY

Kaiser-Pilling® Design

KAISER-PILLING® LONG JAW RING FORCEPS

1 x 11 ratchets, 6-3/8" (16 cm) jaw.

CATALOG #	DESCRIPTION
841010	Straight (1L), 6-3/8" (16 cm) jaw, 12-5/8" (32 cm)
841011	Curved (2L), 6-3/8" (16 cm) jaw, 12-1/4" (31 cm)
841012	"C" shaped (4L), 6-3/8" (16 cm) jaw, 10-7/8" (28 cm)
841013	Curved on side (3L), 12-1/8" (31 cm)
841014	Curved handle, 12-1/8" (31 cm)
841015	90 degree ring jaw, 11-7/8" (30 cm)
841016	45 degree ring jaw, 12-1/4" (31 cm)

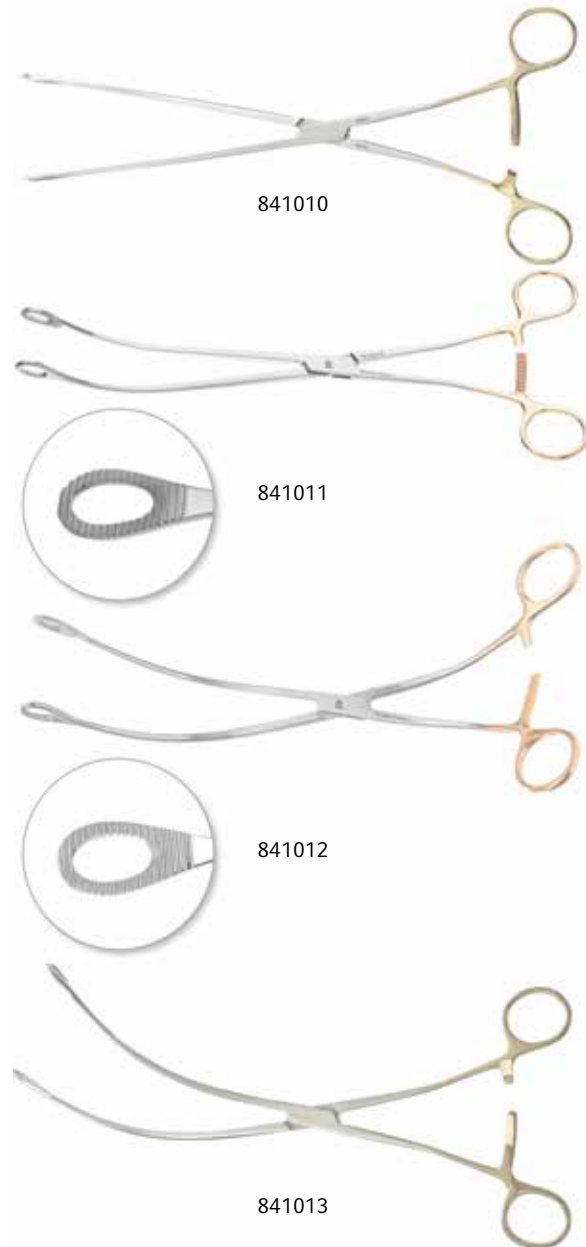

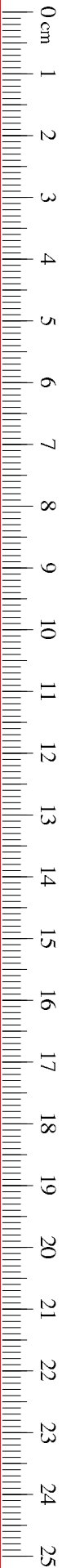

VIDEO-ASSISTED THORACOSCOPY

Kaiser-Pilling® Design

KAISER-PILLING® THORACOSCOPIC FORCEPS



CATALOG #	DESCRIPTION
841160	Straight, without ratchets, 12" (31 cm)
841161	Slight curve, without ratchets, 11-3/4" (30 cm)

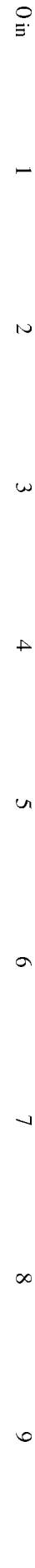

VIDEO-ASSISTED THORACOSCOPY

Kaiser-Pilling® Design

KAISER-PILLING® DEBAKEY®-TYPE RING FORCEPS



1 x 11 ratchets.

CATALOG #	DESCRIPTION
841050	Straight (1AG), 12-5/8" (32 cm)
841051	"S"-shaped (5AG), 11-3/4" (30 cm)
841052	Curved jaw (2AG), 12-1/4" (31 cm)

KAISER-PILLING® DEBAKEY®-TYPE ALLIS RING FORCEPS

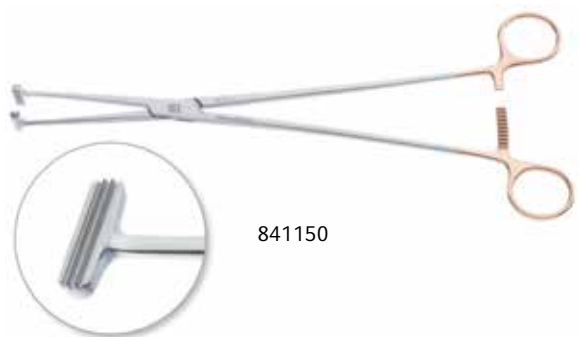

CATALOG #	DESCRIPTION
841150	2 x 3 DeBakey®-type Jaws, 21 mm, 12" (31 cm)



VIDEO-ASSISTED THORACOSCOPY

Kaiser-Pilling® Design

KAISER-PILLING® BIOPSY FORCEPS

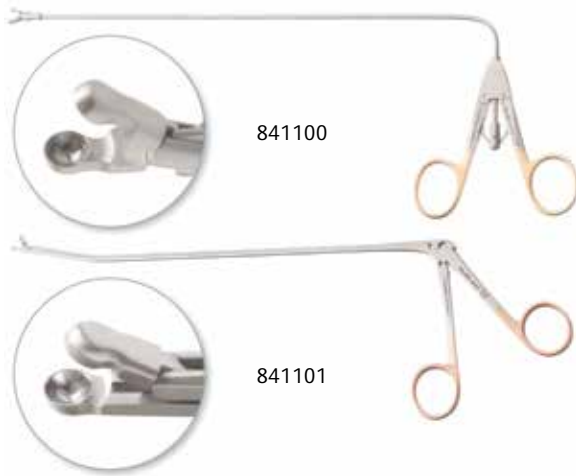

CATALOG #	DESCRIPTION
841100	Malleable, 4 mm cup, 12-5/8" (32 cm)
841101	Rigid, slightly curved, 4 mm cup, 11" (28 cm)

KAISER-PILLING® ANGLE SICKLE KNIFE

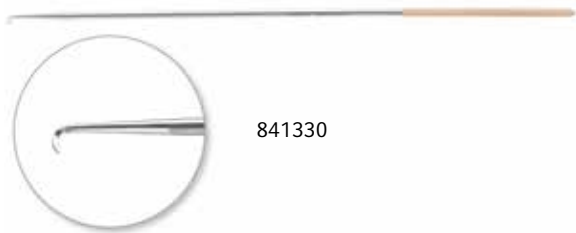

CATALOG #	DESCRIPTION
841330	Sharp tip, 13" length (33 cm)

KAISER-PILLING® BLUNT HOOK

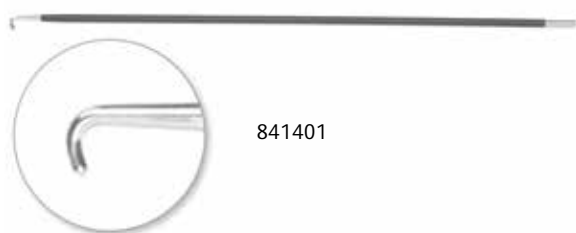

CATALOG #	DESCRIPTION
841401	Insulated, 13" (33 cm)

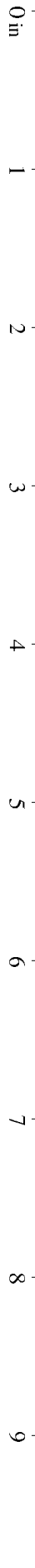

VIDEO-ASSISTED THORACOSCOPY

Kaiser-Pilling® Design

KAISER-PILLING® SPATULA



14" (35.5 cm).

841300

CATALOG #	DESCRIPTION
841300	Slight curve
841301	Acute curve
841302	Straight

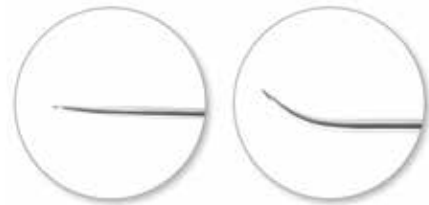

841300

841301

KAISER-PILLING® ANDREWS SUCTION



841351

CATALOG #	DESCRIPTION
841351	11-3/4" (30 cm)

KAISER-PILLING® HOOK

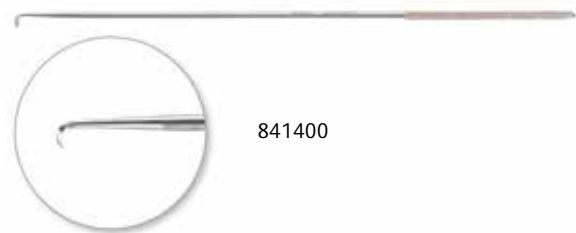

841400

CATALOG #	DESCRIPTION
841400	Blunt, 13" (33 cm)



VIDEO-ASSISTED THORACOSCOPY

Kaiser-Pilling® Design

KAISER-PILLING® SUCTION WITH THUMB VALVE



841350

CATALOG #	DESCRIPTION
841350	13-1/4" (33.5 cm)

KAISER-PILLING® TRAY

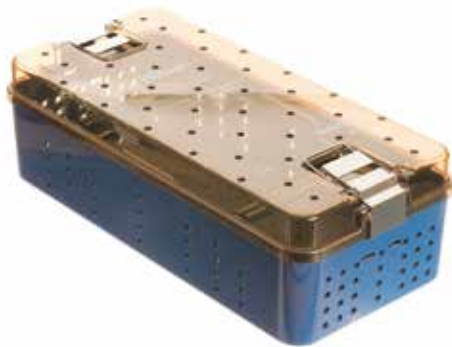

841951

CATALOG #	DESCRIPTION
841951	20-3/4" length x 10" width x 4-5/8" height (52.5 x 25.5 x 11.5 cm)



MISCELLANEOUS CVT

Endarterectomy Dissectors

EFFLER-GROVES DOUBLE-END DISSECTOR AND HOOK



355810

CATALOG #	DESCRIPTION
355810	Lightweight, 12-1/4" (31 cm)

LEMMON INTIMA DISSECTORS



355191

CATALOG #	DESCRIPTION
355191	Slight curve, 6-3/8" (16.5 cm)
355192	Acute curve, 6-3/8" (16.5 cm)

OLIVEKRONA DOUBLE-END DISSECTORS



355182



355186

Very useful as freeing instruments in endarterectomy.

CATALOG #	DESCRIPTION
355180	Lightweight, 7-1/4" (18.5 cm)
355182	Lightweight, 9-1/2" (24 cm)
355184	Heavy weight, 7-3/4" (19.5 cm)
355186	Heavy weight, 9-1/2" (24 cm)

FREER DOUBLE-END ELEVATOR



355194

Pilling® Pattern, satin finish.

CATALOG #	DESCRIPTION
355194	Sharp and blunt, 7" (18 cm)

MISCELLANEOUS CVT

Marking Rings

MARKING RING-VEIN GRAFT



355834

The aorta to coronary saphenous vein graft is widely used for the treatment of coronary atherosclerosis. Assessment of the post-operative result requires direct catheterization of the graft, and locating the proximal orifice can be difficult. The Vein Graft Ring is designed to be placed around the aortic end of the graft prior to completion of the proximal anastomosis. After completion of the proximal anastomosis the ring is sutured to the aorta by interrupted 5-0 or 6-0 sutures. The ring has been found helpful to the cardiologist in locating the aortic end of the graft. The rings are made of 20 Ga., type 316L medical grade stainless steel, available in diameters of 8, 10, 12 and 14 mm.

CATALOG #	DESCRIPTION
355830	CC Marking Ring, 8 mm, 10/pack
355832	CC Marking Ring, 10 mm, 10/pack
355834	CC Marking Ring, 12 mm, 10/pack
355838	CC Marking Ring, 14 mm, 10/pack

Obturator

FITCH OBTURATORS

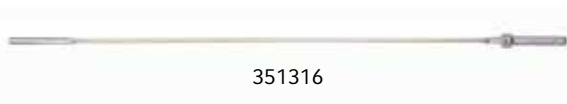

351316

Fitch Obturators, olive tipped, for use with plastic vena cava catheters in open heart surgery. These obturators permit introduction of the venous drainage catheters into the right atrium and vena cava. Olive-shaped tip allows easy introduction through a purse-stringed site in the right atrium. The elongated head of the obturator is designed to block any blood entering the multiple perforations of the catheter during introduction. The malleable shaft permits control of the catheter tip in the right atrium, and appropriately precurving the shaft allows the catheter to be steered into either vena cava.

CATALOG #	DESCRIPTION
351316	26 Fr., 17-7/8" (45.5 cm)
351318	30 Fr., 16-1/8" (41 cm)



MISCELLANEOUS CVT

Tourniquet Stylets

REPLACEMENT STYLET FOR RUMEL TOURNIQUET

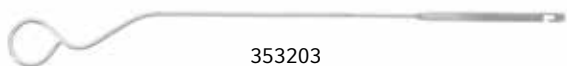

353203

CATALOG #	DESCRIPTION
353203	66 x 4 mm tip, working length 7-5/8" (19.5 cm), overall length 10-1/4" (26 cm)

STYLET FOR RUMEL TOURNIQUET, CHILD SIZE

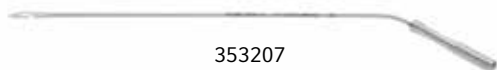

353207

CATALOG #	DESCRIPTION
353207	Often used with rubber tubing and Identi-Loops, 7" (18 cm)

STYLET FOR WECK® STYLE RUMEL TOURNIQUET

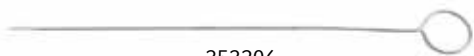

353206

CATALOG #	DESCRIPTION
353206	2 mm-wide tip, working length 8-1/4" (21 cm), overall length 9-3/8" (24 cm)

MISCELLANEOUS CVT

Tunnelers

BERRY ANGIO ACCESS TUNNELER

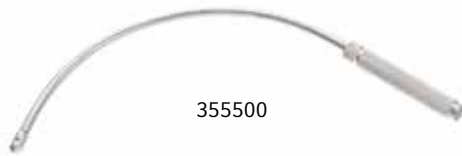

355500

Designed by William B. Berry, M.D. of Pasadena, Texas, Angio Access Tunneler (355500) is used to create forearm loop tunnels for placement of arteriovenous grafts for hemodialysis. Removable interchangeable handle and bullet tip allow:

- Simplified surgical procedure with better surgical control.
- Reduced likelihood of "kinking".
- Less patient trauma.

Diamond knurled handle for ease of control. Suture hole in bullet tip allows secure graft attachment.

CATALOG #	DESCRIPTION
355500	Available in 10-3/4" (27.5 cm) length (105 degree arc)

CRAWFORD-COOLEY GRAFT TUNNELER



355497

Graft is attached to obturator tip and drawn through the tube. Tube is then withdrawn, leaving graft placed in untwisted position.

CATALOG #	DESCRIPTION
355497	Tube slightly curved, 12 mm I.D., 17-1/2" (44.5 cm)

MISCELLANEOUS CVT

Tunnelers

DEBAKEY® FEMORAL BYPASS TUNNELER



355495

For use in by-pass operation for segmental occlusive disease of the iliac and femoral arteries. This instrument is designed with a slightly malleable stainless steel bar with a handle on one end and an olive tip dilator on the other. This blunt end, introduced through one of the incisions, is inserted through the subcutaneous tissue into the other incision. A by-pass graft end is then attached by a simple ligature to the olive tip end which is withdrawn, pulling the graft through the subcutaneous tunnel connecting the two incisions.

CATALOG #	DESCRIPTION
355495	20-3/4" (52.5 cm)

HALLMAN TUNNELING FORCEPS



355493

CATALOG #	DESCRIPTION
355493	14-5/8" (37 cm)

0 in

1

2

3

4

5

6

7

8

9



SPECIALTY SETS

Pilling® Micro Vascular Set

PILLING® MICRO VASCULAR SET OF 11 INSTRUMENTS



357651



357652



357653



357654



357655



357656



CATALOG #	DESCRIPTION
357650	Tray and Set
429594	Tray only 8" (20.5 cm) x 12 1/2" (31.5 cm)
357651	Micro Scissors, straight, 12 mm blades, 7-3/8" (19 cm)
357652	Micro Scissors, curved, 12 mm blades, 7-1/4" (18.5 cm)
357653	You-Potts Scissors, angled 45 degrees, 12 mm blades, 7-3/8" (18.5 cm)
357654	Micro Needle Holder, straight, no lock, 1.15 mm jaw, 7-3/8" (18.5 cm)
357655	Micro Needle Holder, curved, no lock, 1.2 mm jaw, 7-3/8" (18.5 cm)
357656	Micro Needle Holder, straight, lock, 1.2 mm jaw, 7-1/2" (19 cm)
357657	Micro Needle Holder, curved, no lock, 0.6 mm jaw, 7-3/8" (18.5 cm)
357658	Micro Tying Forceps, round handle 8 mm diameter, straight 0.5 mm wide tip with platform, 6" (15 cm)
357659	Micro Tying Forceps, round handle 8 mm diameter, curved 0.5 mm wide tip with platform, 6" (15 cm)
357660	Micro Tying Forceps, round handle 8 mm diameter, straight 0.5 cm wide tip with platform, 7-1/8" (18 cm)
357661	Micro Tying Forceps, round handle 8 mm diameter, curved 0.5 mm wide tip with platform, 7-1/8" (18 cm)



357657



357658

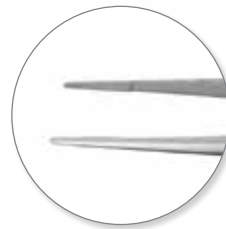

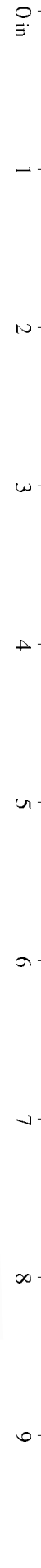

SPECIALTY SETS

Pilling® Micro Vascular Set

PILLING® MICRO VASCULAR SET OF 11 INSTRUMENTS



357659



357660



357661



357650



429594

SPECIALTY SETS

Vascular Access Set

THE PILLING® VASCULAR ACCESS SET



355600

COMPLETE SET:

355600 W.G.H. Pilling® Vascular Access Set complete with stainless steel storage case

341010 Stainless steel case for Pilling® Vascular Access Set

Designed for all Angle Access procedures — not just AV. fistula — a logically planned set of instruments suited for:

- End-to-end, end-to-side, AV. fistula — any extremity
- Fistulas with graft
- External shunts



341010

SPECIALTY SETS

Vascular Access Set

Vascular Access Sets suited for:



Brescia AV. fistula side to side

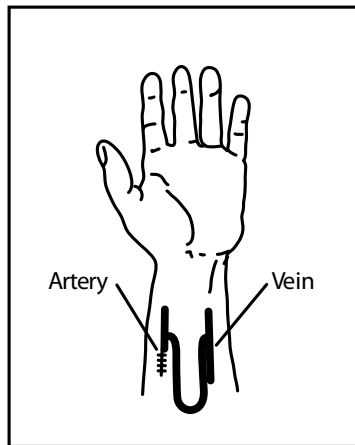

AV. fistula with external shunt

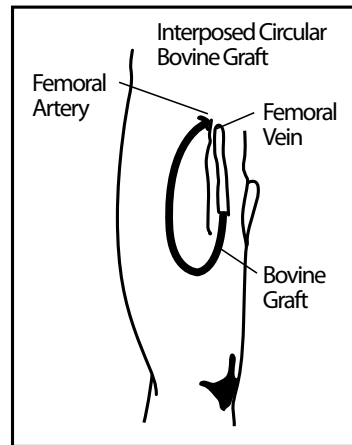

AV. fistula with graft

All instruments are supplied in a stainless steel storage case for protection and easy instrument counts.

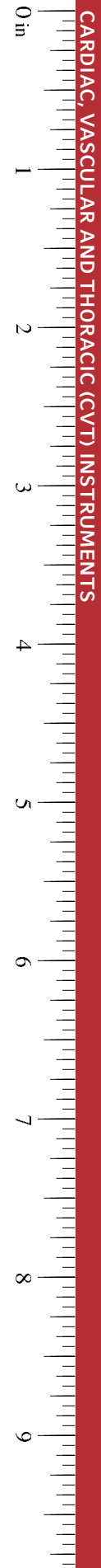



SPECIALTY SETS

Vascular Access Set

THE PILLING® VASCULAR ACCESS SET



CATALOG #	DESCRIPTION
353187	Gregory Mini-vascular Clamps, curved, extra-light, 4-1/8" (10.5 cm)
353190	Gregory Mini-vascular Clamps, angled 45 degrees, extra-light, 4-3/8" (11 cm)
165439	Two of the Short Model Gelpi, sharp prongs, 3-1/8" (8 cm) spread, 5-3/8" (13.5 cm)
355275	Hiebert Vascular Dilators, 0.5 mm x 1 mm
355276	Hiebert Vascular Dilators, 1.5 mm x 2 mm
355277	Hiebert Vascular Dilators, 2.5 mm x 3 mm
355278	Hiebert Vascular Dilators, 3.5 mm x 4 mm
152818	Castroviejo Needle Holder, straight, 11 x 1.4 mm jaw, 6" (15 cm), TC
354964	Castroviejo Needle Holder, straight, 13 x 1.4 mm jaw, 7-1/4" (18.5 cm), TC

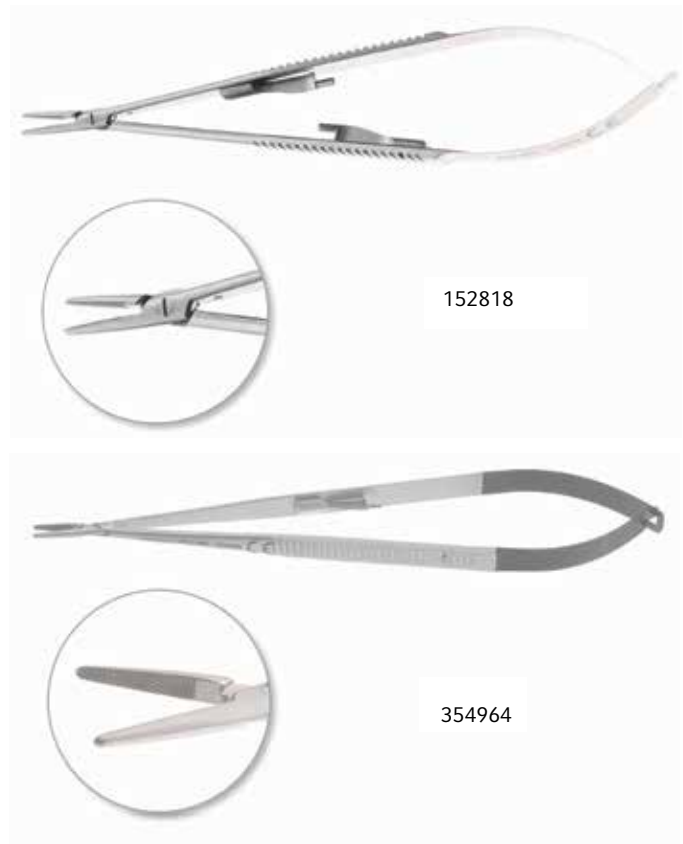

SPECIALTY SETS

Vascular Access Set

THE PILLING® VASCULAR ACCESS SET (CONTINUED)



352145



353600



351830



351575



351827

CATALOG #	DESCRIPTION
352145	Potts-Type Scissors, angled 45 degrees, 9 mm blades, 4-1/8" (10.5 cm)
353600	DeBakey® Aortic Aneurysm Clamp, 3-3/4" (9.5 cm) jaw, 1 x 9 ratchets, 10-3/8" (26.5 cm)
353011	Three of the Johns Hopkins Bulldog® Clamps, curved jaws, 1-1/2" (4 cm)
351830	Gregory Suture "Stay" Clamps, straight, 3-7/8" (10 cm), TC
351575	DeBakey® Heparin Cannula, malleable, 3 mm tip, 2-1/2" (6.5 cm)
351825	Wheeler Pick-up Forceps, DeBakey®-type Jaw, 1.6 mm, 5-1/2" (14 cm)
351827	Wheeler Pick-up Forceps, DeBakey®-type Jaw, 1.6 mm, 7-1/8" (18 cm)







ORTHOPEdic INSTRUMENTS

CHAPTER OVERVIEW

Pilling® and KMedic® Orthopedic Instruments represent a high quality line that offers the precision you require, the quality you demand and the pattern assortments that meet your needs. Our categories of Orthopedic instruments include:

- KMedic® Wire and Pin Implants
- Wire Twisters and Pin and Rod Cutters
- Pliers, Drills and Screwdrivers
- Rongeurs
- Ostetomes, Chisels and Gouges
- Nail Instruments
- Smartrack Storage Racks





KMEDIC® WIRE AND PIN IMPLANTS



Bend K-Wires up to 0.062" in diameter easily with our Gratloch Wire Bender KM48370.

KMEDIC® WIRE AND PIN IMPLANTS





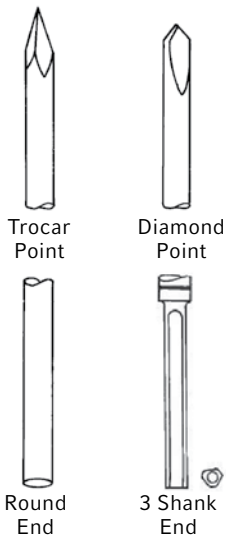





- Precision manufactured in Germany from certified implant stainless steel.
- Longer, gently tapered points for easier penetration.
- Smoothly hand-polished, causing less trauma when removed.
- K-Wires and Steinmann pins are sold six (6) per package.

Please inquire about availability of any sizes and styles not shown.

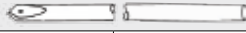
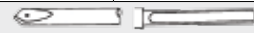

KIRSCHNER WIRES (SMOOTH) — PKG/6					
LENGTH	0.028" (.7 mm)	0.035" (.9 mm)	0.045" (1.1 mm)	0.054" (1.4 mm)	0.062" (1.6 mm)
DOUBLE-END TROCAR					
4"	KM71100	KM71101	KM71102	KM71104	KM71103
5"	KM71105	KM71106	KM71107	KM71108	KM71109
6"	KM71021	KM71022	KM71023	KM71024	KM71025
9"	KM71110	KM71111	KM71112	KM71114	KM71113
12"	KM71120	KM71121	KM71122	KM71124	KM71123
SINGLE TROCAR (ROUND END)					
4"	KM71130	KM71131	KM71132	KM71133	KM71134
5"	KM71170	KM71171	KM71172	KM71174	KM71175
6"	—	—	KM71182	—	KM71185
7"	—	KM71156	—	—	—
9"	KM71150	KM71151	KM71152	KM71154	KM71153
12"	KM71160	KM71161	KM71162	KM71164	KM71163
DOUBLE-END DIAMOND					
4"	KM71200	KM71201	KM71202	KM71203	KM71204
5"	KM71205	KM71206	KM71207	KM71208	KM71209
6"	KM71030	KM71031	KM71032	KM71034	KM71033
9"	KM71210	KM71211	KM71212	KM71214	KM71213
SINGLE DIAMOND (ROUND END)					
4"	KM71230	KM71231	KM71232	KM71233	KM71234
9"	KM71240	KM71241	KM71242	KM71244	KM71243
12"	KM71250	KM71251	KM71252	KM71254	KM71253
SUTURE PASSER SINGLE DIAMOND WITH SUTURE HOLE (ROUND END)					
9"	—	—	KM71262	—	KM71263
SUTURE PASSER SINGLE DIAMOND WITH SUTURE HOLE (3 SHANK END)					
9"	—	—	—	—	—
SINGLE TROCAR (3 SHANK END)					
9"	—	—	—	—	—
SINGLE DIAMOND (3 SHANK END)					
9"	—	—	—	—	—
KIRSCHNER WIRES (FULLY THREADED) — PKG/6					
LENGTH	0.028" (.7 mm)	0.035" (.9 mm)	0.045" (1.1 mm)	0.054" (1.4 mm)	0.062" (1.6 mm)
DOUBLE-END TROCAR					
6"	—	KM71290	KM71291	—	KM71293
9"	—	KM71301	KM71302	—	KM71303
SINGLE TROCAR (ROUND END)					
9"	—	KM71304	KM71305	—	KM71310
DOUBLE-END DIAMOND					
9"	—	KM71311	KM71312	—	KM71313
SINGLE DIAMOND (ROUND END)					
9"	—	KM71314	KM71315	—	KM71307
10"	—	—	—	—	—



STEINMANN PINS (SMOOTH) — PKG/6							
LENGTH	5/64" (2.0 mm)	3/32" (2.4 mm)	7/64" (2.8 mm)	1/8" (3.2 mm)	9/64" (3.5 mm)	5/32" (4.0 mm)	0.177" (4.5 mm)
DOUBLE-END TROCAR 							
4"	—	—	—	—	—	—	—
5"	—	—	—	—	—	—	—
6"	—	—	—	—	—	—	—
9"	KM71450	KM71453	KM71456	KM71459	KM71462	KM71465	KM71468
12"	—	—	—	—	—	—	—
SINGLE TROCAR (ROUND END) 							
4"	—	—	—	—	—	—	—
5"	—	KM71432	—	—	—	—	—
6"	—	—	—	—	—	—	—
7"	—	—	—	KM71434	—	—	—
9"	KM71510	KM71513	KM71516	KM71519	KM71522	KM71525	KM71528
12"	KM71674	KM71676	KM71677	KM71680	KM71681	KM71682	KM71683
DOUBLE-END DIAMOND 							
4"	—	—	—	—	—	—	—
5"	—	—	—	—	—	—	—
6"	—	—	—	—	—	—	—
9"	KM71600	KM71603	KM71606	KM71609	KM71612	KM71615	KM71618
SINGLE DIAMOND (ROUND END) 							
4"	—	—	—	—	—	—	—
9"	KM71660	KM71663	KM71666	KM71669	KM71672	KM71675	KM71678
12"	—	—	—	—	—	—	—
SUTURE PASSER SINGLE DIAMOND WITH SUTURE HOLE (ROUND END) 							
9"	—	—	—	—	—	—	—
SUTURE PASSER SINGLE DIAMOND WITH SUTURE HOLE (3 SHANK END) 							
9"	KM71880	KM71883	KM71886	KM71889	KM71892	KM71895	KM71898
SINGLE TROCAR (3 SHANK END) 							
9"	KM71480	KM71483	KM71486	KM71489	KM71492	KM71495	KM71498
SINGLE DIAMOND (3 SHANK END) 							
9"	KM71630	KM71633	KM71636	KM71639	KM71642	KM71645	KM71648
STEINMANN PINS (FULLY THREADED) — PKG/6							
LENGTH	5/64" (2.0 mm)	3/32" (2.4 mm)	7/64" (2.8 mm)	1/8" (3.2 mm)	9/64" (3.5 mm)	5/32" (4.0 mm)	0.177" (4.5 mm)
DOUBLE-END TROCAR 							
6"	—	—	—	—	—	—	—
9"	KM71750	KM71753	KM71756	KM71759	KM71762	KM71765	KM71768
SINGLE TROCAR (ROUND END) 							
9"	KM71770	KM71773	KM71776	KM71779	KM71782	KM71785	KM71788
DOUBLE-END DIAMOND 							
9"	KM71730	KM71733	KM71736	KM71739	KM71742	KM71745	KM71748
SINGLE DIAMOND (ROUND END) 							
9"	KM71700	KM71703	KM71706	KM71709	KM71712	KM71715	KM71718
10"	—	KM71679	—	—	—	—	—

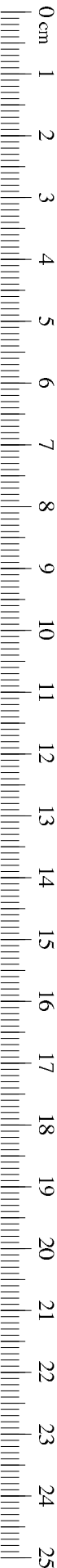

KMEDIC® WIRE AND PIN IMPLANTS

STEINMANN PINS CALIBRATED (GUIDE WIRES) WITH 1/2" GRADUATIONS					
LENGTH	0.062" (1.6 mm)	5/64" (2.0 mm)	3/32" (2.4 mm)	7/64" (2.8 mm)	1/8" (3.2 mm)
SINGLE TROCAR (ROUND END)					
9"	KM71173	—	—	—	—
SINGLE TROCAR 3 SHANK END					
9"	—	—	KM71833	—	—
SINGLE DIAMOND 3 SHANK END					
9"	—	—	KM71853	KM71856	KM71859
SINGLE DIAMOND 3 ROUND END					
9"	—	—	KM71873	—	—



KM71009

K-WIRE, STEINMANN PIN CASES

KM71009

13" x 5-1/4" x 2" (closed)

Holds 9" K-Wires; 9" Steinmann Pins.

K-WIRES - 1 ROW, HOLDS 4 EACH OF THE FOLLOWING:	
0.028" (0.7 mm)	0.045" (1.1 mm)
0.035" (0.9 mm)	0.062" (1.6 mm)
STEINMANN PINS - 2 ROWS, HOLDS 4 EACH OF THE FOLLOWING:	
5/64" (2.0 mm)	9/64" (3.5 mm)
3/32" (2.4 mm)	5/32" (4.0 mm)
7/64" (2.8 mm)	0.177" (4.5 mm)
1/8" (3.2 mm)	

K-WIRE, STEINMANN PIN CASES

KM71010

11-3/4" x 5-1/4" x 2" (closed)

Holds 4", 6" and 9" K-Wires; 9" Steinmann Pins.

K-WIRES - 3 ROWS, HOLDS 4 EACH OF THE FOLLOWING:	
0.028" (0.7 mm)	0.045" (1.1 mm)
0.035" (0.9 mm)	0.062" (1.6 mm)
STEINMANN PINS - 1 ROW, HOLDS 2 EACH OF THE FOLLOWING:	
5/64" (2.0 mm)	9/64" (3.5 mm)
3/32" (2.4 mm)	5/32" (4.0 mm)
7/64" (2.8 mm)	0.177" (4.5 mm)
1/8" (3.2 mm)	

KIRSCHNER WIRES, STEINMANN PIN, VICKERS K-WIRE DISPENSERS

K-WIRE DISPENSER 6-1/4"			
CATALOG #	LENGTH	DIAMETER	QTY. HELD
KM71001	up to 6"	0.031" (0.8 mm)	100
KM71002	up to 6"	0.039" (1.0 mm)	50
KM71003	up to 6"	0.047" (1.2 mm)	40
KM71004	up to 6"	0.054" (1.4 mm)	25
KM71006	up to 6"	0.062" (1.6 mm)	20
K-WIRE DISPENSER 12-1/4"			
KM71012	up to 12"	0.039" (1.0 mm)	50
KM71013	up to 12"	0.047" (1.2 mm)	40
KM71014	up to 12"	0.054" (1.4 mm)	25
KM71016	up to 12"	0.062" (1.6 mm)	20
STEINMANN PIN DISPENSER 12-1/4"			
KM71017	up to 12"	5/64" (2.0 mm)	10
KM71019	up to 12"	3/32" (2.5 mm)	5

- Stores and dispenses one size at a time.
- Sharp points are protected by silicone insert in cap.
- To avoid injury, load wire with blunt end down.
- Hexagonal shape of cap prevents unwanted movement of dispenser.
- Diameter is marked for easy identification.



KM71001 - KM71006
For K-Wire up to 6" long.



KM71012 - KM71019
For K-Wire and pins up to 12" long. Plastic cap.

VICKERS K-WIRE DISPENSER									
CATALOG #	LENGTH	CHAMBER #1		CHAMBER #2		CHAMBER #3		CHAMBER #4	
		DIAMETER	QTY. HELD	DIAMETER	QTY. HELD	DIAMETER	QTY. HELD	DIAMETER	QTY. HELD
KM46542	4"	0.039" (1.0 mm)	60	0.047" (1.2 mm)	40	0.055" (1.4 mm)	30	0.063" (1.6 mm)	18
KM46538	12"	0.039" (1.0 mm)	60	0.047" (1.2 mm)	40	0.055" (1.4 mm)	30	0.063" (1.6 mm)	18
KM46539	12"	0.070" (1.8 mm)	15	5/64" (2.0 mm)	12	0.086" (2.2 mm)	10	3/32" (2.5 mm)	8



KM46542
For 4" K-Wire.

- Easily stores and dispenses four different size wires.
- Dial on bottom enables for dispensing of one size at a time.
- To avoid injury, load wire with blunt end down.
- Dial can be locked to avoid accidental dispensing.
- Clearly marked chambers help to avoid mix-up.
- Dispenser is available exclusively from Teleflex®.



KM46538 - KM46539
For 12" K-Wire.



KMEDIC® WIRE AND PIN IMPLANTS

Wire and Pin Drivers and Benders

K-WIRE BENDER



KM49802

Bends up to 1.6 mm (0.062") K-Wire to 90 degree angle.

CATALOG #	DESCRIPTION
KM49802	3 prong, 5-3/4" (14.5 cm)

K-WIRE AND PLATE BENDER



KM49724

Bends mini plates and up to 1.1 mm (0.045") K-Wire to 90 degree angle.

CATALOG #	DESCRIPTION
KM49724	3 prong, 5" (12.5 cm)

VICKERS EASIDRIVER



NO MANUAL DEVICE HAS EVER ACHIEVED THIS FUNCTION

For years, surgeons have sought a simple pin driver that could actually be fully controlled with one hand. The Vickers Easidriver leaves the other hand free to manipulate tissue, leaving the patient in better hands.

IDEAL BACKUP UNIT FOR OFFICE AND HOSPITAL

What do you use when your power equipment fails during surgery? Now you have the handy Vickers Easidriver Instrument. Without loss of precious time, it is ready for use. In cases where power equipment is not indicated or available, the Vickers Instrument can become your primary driver, allowing for feel and control that power units don't offer.

EXCLUSIVELY FROM TELEFLEX®

Teleflex® is proud to be able to offer the Vickers Easidriver Instrument.

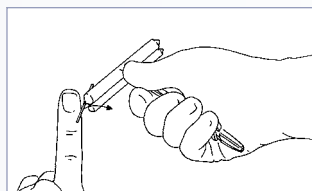
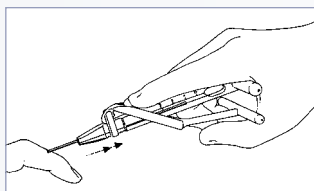
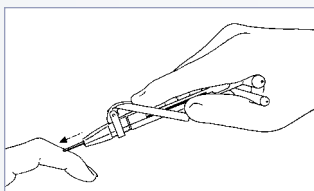

Now you can drive, bend and pull K-Wire for a fraction of the cost of power equipment.

VICKERS EASIDRIVER INSTRUMENT

KM46540

5-1/2"

German Stainless

- Single handed operation
- Chuckless
- Depthscale
- Wire bending facility
- No maintenance
- No set-up
- Autoclavable
- For wire from 0.028" to 0.062"

KMEDIC® WIRE AND PIN IMPLANTS

Wire and Pin Drivers and Benders

STEINMAN PIN CHUCK



For insertion and removal of Steinmann Pins. Includes chuck key. Cannulation accepts wires and pins up to 0.236" (6.0 mm). Chuck accepts wires and pins up to 1/4" (6.35 mm).

CATALOG #	DESCRIPTION
KM48374	Fully cannulated, 4" (10 cm)

UNIVERSAL CHUCK WITH T-HANDLE



No more lost keys! Keyless chuck for insertion and removal of Steinmann Pins. Cannulation accepts wires and pins up to 0.236" (6.0 mm). Chuck accepts wires and pins up to 1/4" (6.35 mm).

CATALOG #	DESCRIPTION
KM47901	Fully cannulated with reverse lock, 4-1/2" (11.5 cm)
KM47903	Fully cannulated, 4" (10 cm)

KMEDIC® GRATLOCH™ WIRE BENDER

The KMedic® Gratloch™ Wire Bender is designed to enable single-handed stabilization and bending of a Kirschner wire simultaneously. The unique design allows K-Wire to be bent close to the bone without sacrificing fracture or osteotomy stability.

TO BEND WIRE:

1. After the insertion of K-Wire in the bone, cut the wire, leaving a piece of 1/2" to 3/4" in length.
2. Insert the K-Wire into angled slot of Gratloch™ Bender as close to the bone as possible.
3. Press handles to bend wire (0.062" wire will bend 90 degrees; smaller diameters will bend slightly less than 90 degrees).
4. Additional features of the Gratloch™ Wire Bender are two angled cannulations at the proximal end of each handle for flush bending of wire (0.045" and 0.062").

KMedic® Gratloch™ Wire Bender Detail

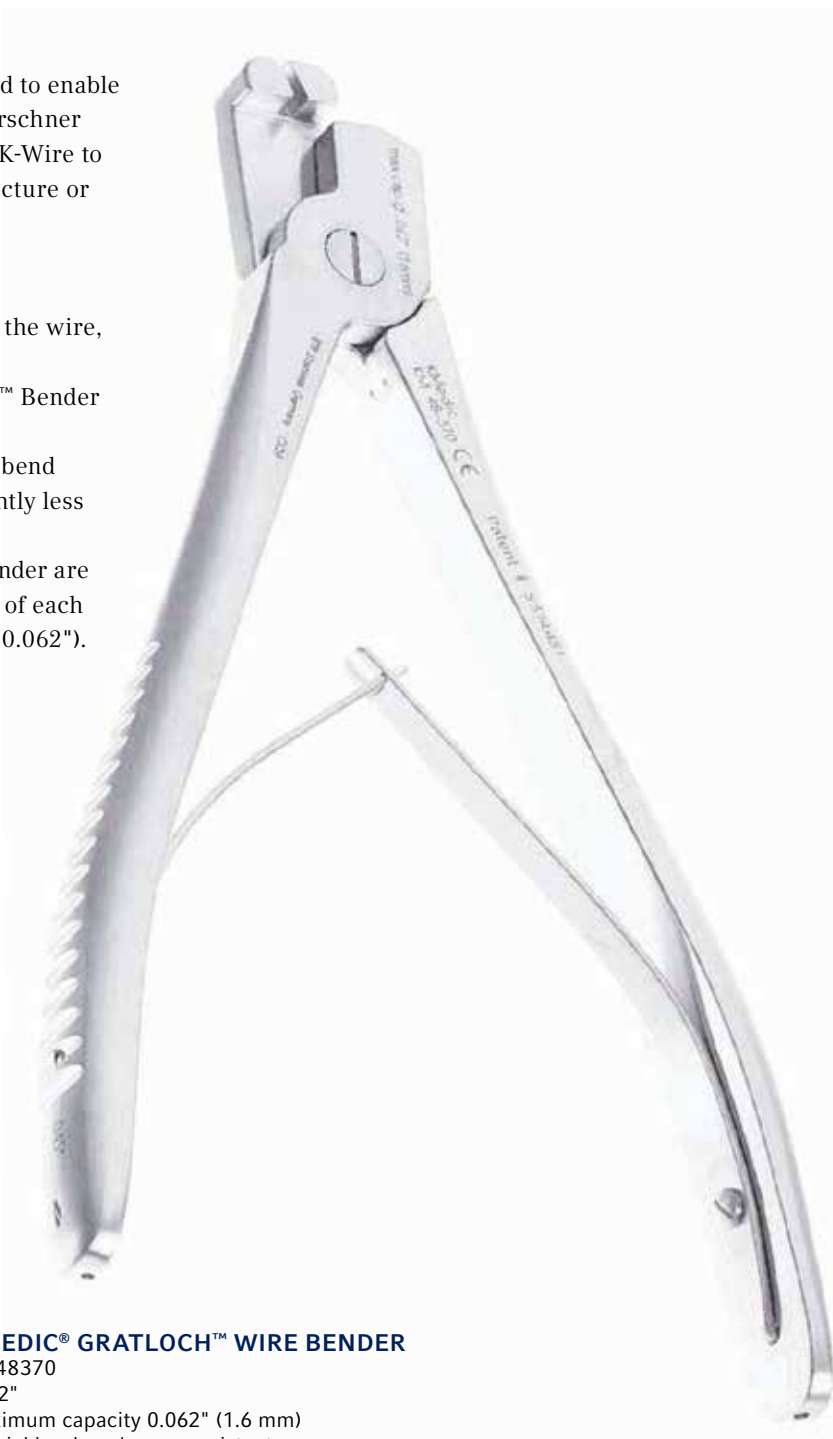
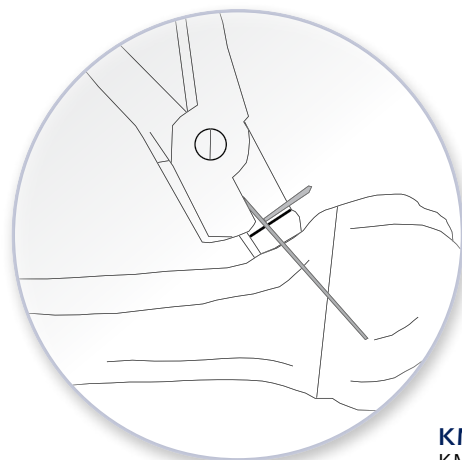

KMEDIC® GRATLOCH™ WIRE BENDER

KM48370

7-1/2"

Maximum capacity 0.062" (1.6 mm)

Special hardened, wear-resistant

Stainless tool-grade stainless steel



KMEDIC® WIRE AND PIN IMPLANTS

Wire and Pin Drivers and Benders

WIRE AND PIN BENDER



KM48372

Aids in bending pins and wires.

CATALOG #	DESCRIPTION
KM48372	Accepts wires and pins up to 1/8" (3.2 mm), overall length 5-7/8" (15 cm)

WIRE TWISTERS AND WIRE/PIN/ROD CUTTERS

Wire Twisters

LOUTIE WIRE TIGHTENER

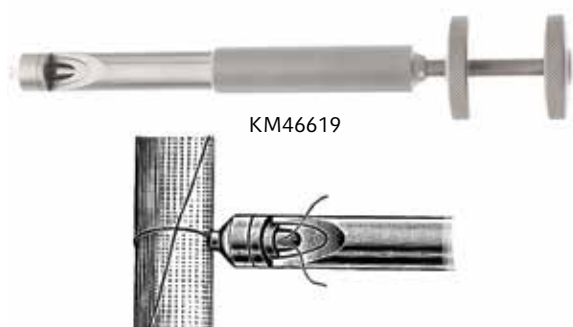

KM46619

CATALOG #	DESCRIPTION
KM46619	Maximum capacity 1.5 mm or 17 gauge cerclage wire, 8-1/2" (21.5 cm)

WIRE TWISTING FORCEPS

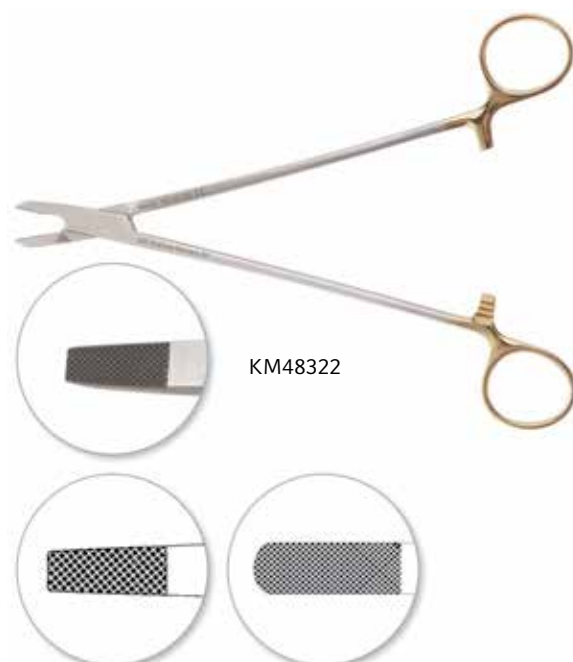

Carbide inserts.

CATALOG #	DESCRIPTION
KM48320	6" (15 cm), TC
KM48322	4 mm tip, 8" (21 cm), TC
KM48324	6 mm tip, 7-1/4" (19 cm), TC

KM48322

KM48320

KM48324



WIRE TWISTERS AND WIRE/PIN/ROD CUTTERS

Wire Twisters

WIRE PULLING FORCEPS



Facilitates holding and pulling of pins and wires.

CATALOG #	DESCRIPTION
KM46637	Maximum capacity 1 mm, 6-1/2" (17 cm)

KMEDIC® CORWIN WIRE TWISTER

HOW TO USE THE KMEDIC® CORWIN WIRE TWISTER:

1. Wrap wire around bone and position ends next to each other.
2. Grasp both ends of wire with jaws.
3. Engage the ratchet to enforce solid clamping.
4. Stabilize wiring site.
5. Pull back on center ring repeatedly until wire has reached desired tension.
6. Disengage ratchet.

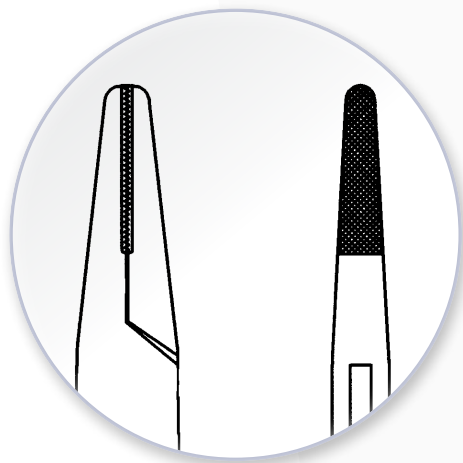

KMEDIC® CORWIN WIRE TWISTER

KM46582

6-1/4" (16 cm) with carbide inserts

Maximum capacity 0.8 mm or 21 gauge cerclage wire



Saves time by semi-automatically twisting soft wire.



KMEDIC® P.I. WIRE TWISTER AND TIGHTENER



KMEDIC® P.I. WIRE TWISTER AND TIGHTENER
 KM69846
 6-1/4" (16 cm)

FOLLOW THESE EASY STEPS TO TWIST AND TIGHTEN CERCLAGE WIRE:

1. Position wire around bone. Bend the ends of the wire slightly upwards.
2. Feed both twisted wire ends through the tongue and groove jaw and push out and up through the jaw fenestration.
3. Engage the ratchet. This will lock the wire in place. Turn the entire instrument, tightening the wire around the bone.

For more information please refer to the Instructions For Use.



KMEDIC® JET WIRE TWISTER

The KMedic® Jet Wire Twister is designed to provide fast, smooth and even twisting of soft wire, saving time in the OR. Suitable for the entire range of cerclage wire.

HOW TO USE THE KMEDIC® JET WIRE TWISTER:

1. Wrap wire around bone and position ends next to each other.
2. Grasp both ends of wire with jaw.
3. Engage the ratchet to enforce solid clamping.
4. Stabilize wiring site.
5. Pull back on t-handle repeatedly until wire has reached desired tension.
6. Disengage ratchet.

Note: Jaws can be customized. Please contact us for details.

For more information please refer to the Instructions For Use.



KMEDIC® JET WIRE TWISTER
 KM49810
 11" (28 cm)
 10 mm tip

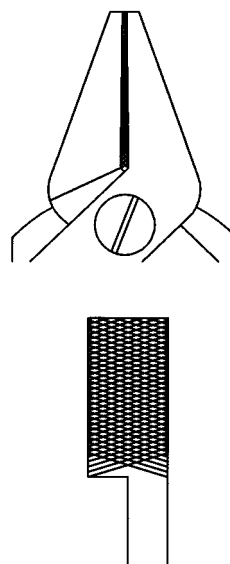

ABOUT KMEDIC® WIRE AND PIN CUTTERS

Teleflex® can meet all of your wire and pin cutting requirements with our complete line of KMedic® Stainless Steel Cutting Instruments.

MADE FROM STAINLESS STEEL

All of our wire cutters are engineered to meet the demanding needs of cutting rods, pins, cables and wires in the Operating Room. Jaws are made from the toughest specially tempered tool steel or have tungsten carbide inserts.

MORE CUTTING POWER

Cutters designed with double action give you more cutting power and help absorb the shock of wire cutting. There is better control and less fatigue for the surgeon.

MOST EXTENSIVE SELECTION

We offer more jaw and handle styles than any other instrument company.

NOTE ON CARBIDE INSTRUMENTS

Instruments with carbide inserts can be replaced; however, welded carbide jaws cannot be replaced.

TO ACHIEVE THE BEST RESULTS WHEN CUTTING WIRES AND PINS, FOLLOW THESE SIMPLE STEPS:

- Choose the appropriate cutter for the wire diameter you want to cut
- Do not exceed the maximum capacity marked on each cutter
- Cut wire in the middle of the jaw—not on the tip or in the corner
- Keep the jaw at right angles to the piece being cut. Do not twist or turn cutter

IMPORTANT NOTE ON MAXIMUM CAPACITIES

All maximum capacities noted in this catalog are based on tests using standard strength implant material. Cutting material which exceeds our recommended maximum capacities may damage or shorten the life of cutting edges and voids the instrument warranty. Please check the size of the material and the maximum capacity of the instrument before using.

For more information, please refer to the Instructions For Use.



WIRE TWISTERS AND WIRE/PIN/ROD CUTTERS

Wire Cutters

DELICATE WIRE CUTTER



KM46622

Delicate side-cutting jaws with carbide inserts. Especially useful for pediatric, foot and hand surgery.

CATALOG #	DESCRIPTION
KM46622	Side cutting with carbide inserts, maximum capacity 0.028" (0.7 mm), 4-7/8" (12.5 cm)

PILLING® STAINLESS STEEL WIRE CUTTING FORCEPS



142550

CATALOG #	DESCRIPTION
142550	6-7/8" (17.5 cm)

PILLING® WIRE CUTTERS



142519

CATALOG #	DESCRIPTION
142519	Single action, 7-7/8" (20 cm), TC
142520	Angled jaw, double action, 8-1/2" (21.5 cm), TC



142520



WIRE TWISTERS AND WIRE/PIN/ROD CUTTERS

Wire Cutters

SIDE CUTTER



KM46621

CATALOG #	DESCRIPTION
KM46621	Side cutting, welded carbide jaws, maximum capacity 0.062" (1.6 mm), 7-1/4" (18.5 cm)

KMEDIC® SIDE CUTTER



KM49736

Welded carbide jaws.

CATALOG #	DESCRIPTION
KM49736	Maximum capacity 3/32" (2.4 mm), 9" (23 cm)

K-WIRE SIDE CUTTER



KM49734

Welded hardened jaws.

CATALOG #	DESCRIPTION
KM49734	Maximum capacity 0.045" (1.1 mm), 6" (15 cm)

WIRE TWISTERS AND WIRE/PIN/ROD CUTTERS

Wire Cutters

KMEDIC® WIRE CUTTER WITH SAFETY INSERTS

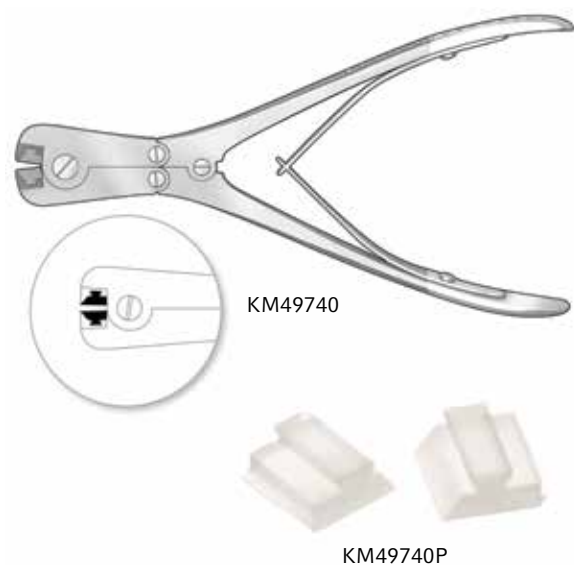

Combines maximum leverage and optimum safety. The KMedic® Wire Cutter with Safety Inserts can help prevent the potentially dangerous occurrence of flying K-Wire pieces in the OR. This instrument is designed to hold the cut piece of wire in its silicon inserts. After cutting, the remnant wire can be safely disposed of, thus preventing cut pieces from falling into the wound site or flying into the air. The silicon inserts are autoclavable and long-lasting. And since inserts are not glued into the jaws, replacement is fast and easy. Simply insert the new ones by pressing them into place. Inserts do not fall out or move under normal circumstances. Front and side cutting, double action.

CATALOG #	DESCRIPTION
KM49740	Maximum capacity 0.062" (1.6 mm), 6-7/8" (17.5 cm)
KM49740P	Set of replacement silicon inserts

DOUBLE ACTION WIRE CUTTERS



KM46623

Narrow jaw makes this cutter a favorite with hand and foot surgeons.

CATALOG #	DESCRIPTION
KM46623	Angled, side cutting with carbide inserts, maximum capacity 0.062" (1.6 mm), 6-5/8" (17 cm)
KM46624	Angled, side cutting with carbide inserts, maximum capacity 3/32" (2.4 mm), 8-1/2" (21.5 cm)



WIRE TWISTERS AND WIRE/PIN/ROD CUTTERS

Wire Cutters

FRONT AND SIDE WIRE CUTTER



KM46625

CATALOG #	DESCRIPTION
KM46625	Front and side cutting with carbide inserts, double action, maximum capacity 0.062" (1.6 mm), 6-3/4" (17 cm)

FLUSH WIRE CUTTER



KM46631

This improved version of our Front and Side Cutter cuts flush to the bone like no other wire cutter. This is a big advantage in buried wire procedures.

CATALOG #	DESCRIPTION
KM46631	Front and side cutting with carbide inserts, double action, maximum capacity 0.059" (1.5 mm), 6-3/4" (17 cm)

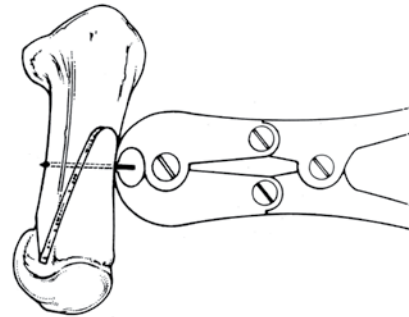

WIRE TWISTERS AND WIRE/PIN/ROD CUTTERS

Wire Cutters

K-WIRE END CUTTER



KM49735

CATALOG #	DESCRIPTION
KM49735	Maximum capacity 0.045" (1.1 mm), 5-1/2" (14 cm)

KMEDIC® END CUTTER



KM49738

Welded carbide jaws.

CATALOG #	DESCRIPTION
KM49738	Maximum capacity 3/32" (2.4 mm), 8-1/2" (21.5 cm)

Pin Cutters

CANNULATED PIN CUTTER



KM46647

Cannulation allows you to slide the cutter over the inserted wire. The piece cut off will be held safely inside the channel.

CATALOG #	DESCRIPTION
KM46647	End cutting, maximum capacity 0.062 (1.6 mm), 7-1/4" (18.5 cm)



WIRE TWISTERS AND WIRE/PIN/ROD CUTTERS

Pin Cutters

DIAMOND PIN CUTTER



KM46651

Disassembles easily for cleaning.

CATALOG #	DESCRIPTION
KM46651	End cutting, maximum capacity 5/64" (2 mm), 6-3/8" (16 cm)

END CUTTER



KM46649

CATALOG #	DESCRIPTION
KM46649	End cutting, welded carbide jaws, maximum capacity 0.062" (1.6 mm), 5-3/4" (14.5 cm)

DOUBLE ACTION PIN CUTTER



KM49800

Double action handles give more power to cut pins up to 1/8" (3.2 mm). Side cutting.

CATALOG #	DESCRIPTION
KM49800	Maximum capacity 1/8" (3.2 mm), 9-1/2" (24 cm)

WIRE TWISTERS AND WIRE/PIN/ROD CUTTERS

Pin Cutters

SIDE PIN CUTTER



KM46629

Heavy duty cutter for rods up to 4 mm and heavy Steinmann pins. Slightly angled jaws house long-lasting special carbide inserts for cutting hard titanium and stainless steel rods.

CATALOG #	DESCRIPTION
KM46629	Side cutting with carbide inserts, maximum capacity 5/32" (4 mm), 15" (38 cm)

SMALL PIN CUTTER



KM46632

CATALOG #	DESCRIPTION
KM46632	Maximum capacity 1/8" (3.2 mm), 10-1/4" (26 cm)

MEDIUM PIN CUTTER



KM46633

Heavy duty cutters with replaceable jaws.

CATALOG #	DESCRIPTION
KM46633	Maximum capacity 3/16" (4.7 mm), 14-3/8" (36.5 cm)



KMEDIC® LARGE PIN CUTTER

Only available from Teleflex®

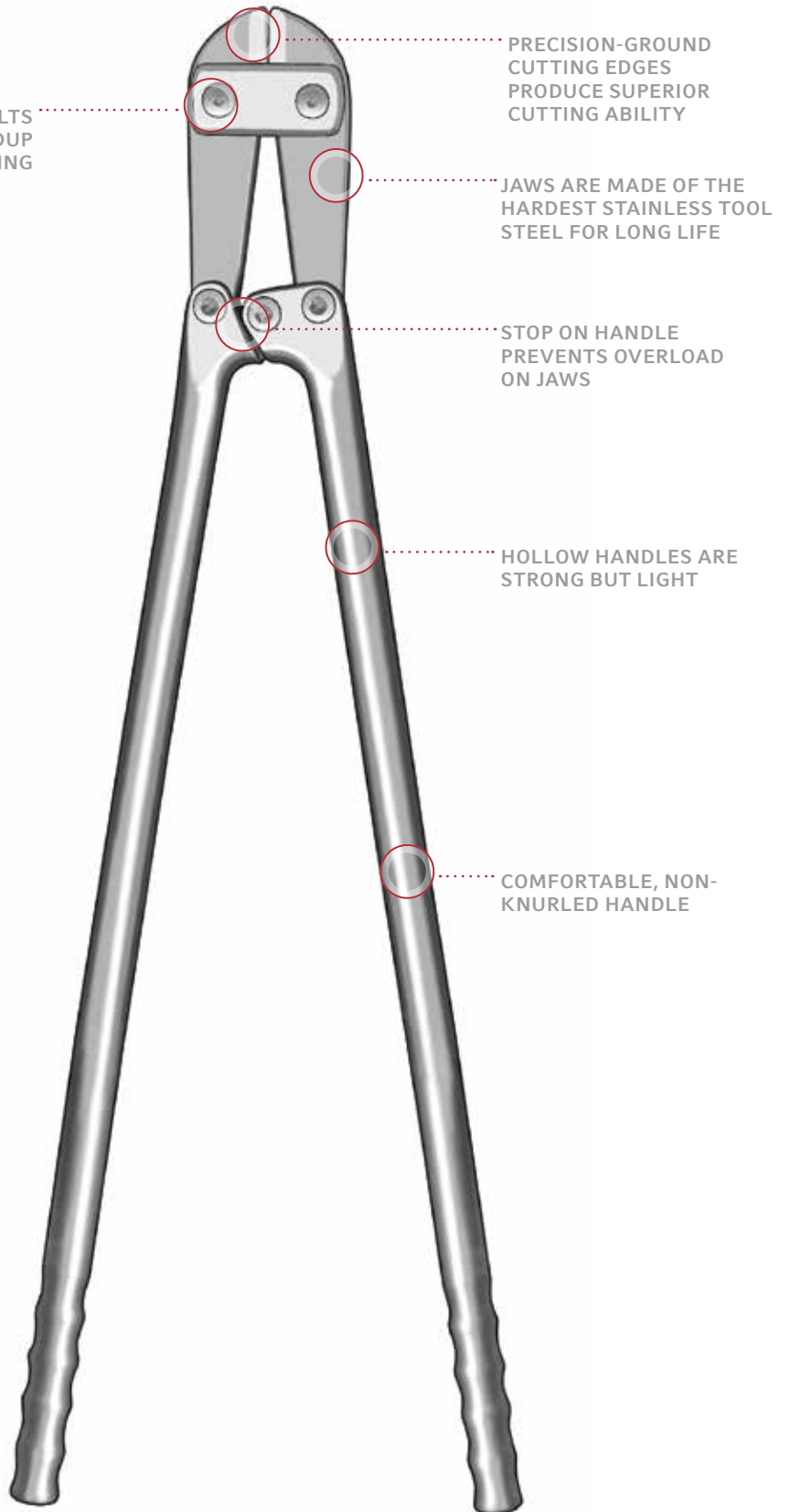

FREE-FLOATING BOLTS
PREVENT STRESS BUILDUP
AND TIGHTENING

PRECISION-GROUND
CUTTING EDGES
PRODUCE SUPERIOR
CUTTING ABILITY

JAWS ARE MADE OF THE
HARDEST STAINLESS TOOL
STEEL FOR LONG LIFE

STOP ON HANDLE
PREVENTS OVERLOAD
ON JAWS

HOLLOW HANDLES ARE
STRONG BUT LIGHT

COMFORTABLE, NON-
KNURLED HANDLE

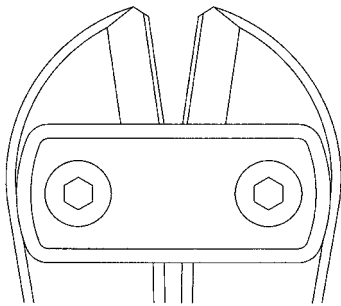
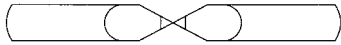

PIN CUTTER (LARGE)

KM46626

22-5/8" (57.5 cm)

Maximum capacity 1/4" (6.3 mm)

Precisely ground jaws are made from the hardest stainless steel available. This redesigned cutter will cut harder spinal rods for a longer period of time.

IMPORTANT: This large cutter is not designed to be used inside the patient's body.

WIRE TWISTERS AND WIRE/PIN/ROD CUTTERS

Pin Cutters

PLATE CUTTING FORCEPS



KM47932

For cutting stainless steel mini plates up to 1 mm.

CATALOG #	DESCRIPTION
KM47932	Straight, 9-1/4" (24 cm)

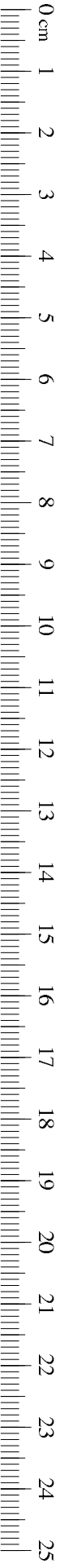

KMEDIC® CABLE CUTTER

Cuts cleanly through cables without fraying

DURABLE TUNGSTEN CARBIDE JAWS CUT HARD CABLES SMOOTHLY AND EASILY

STRONG JOINT DESIGN IS LONG-LASTING AND ALLOWS PRECISE CUTTING

HANDLE STOP FOR DEFINED JAW TRAVEL

JAW ANGLE CAPTURES THE CABLE, THEN CUTS THROUGH ALL STRANDS AT ONCE—ELIMINATING FRAYED ENDS

CUTS THROUGH CABLE WITH ONE CUT—REDUCING RISK OF SMALL CABLE PARTICLES FALLING INTO OPERATING SITE

CABLE CUTTER

KM48378
7" (18 cm)
Maximum capacity 2.0 mm
Cable jaws can be resharpened and replaced.

NOTE: This instrument should only be used for cutting cable. Lubricate joint to ensure proper function.

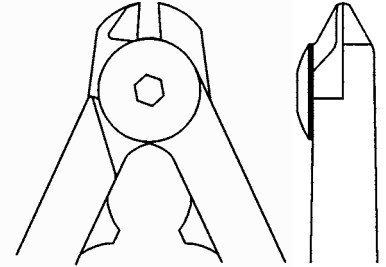

Small jaw design enables surgeon to get close to bone – even in tight spaces.

POSITIVE HANDLE BARS PROVIDE COMFORTABLE NON-SLIP GRIP AND PRECISE CONTROL

LONG-LASTING EXTRA-HEAVY SPRINGS PROVIDE SOLID RETURN

WIRE TWISTERS AND WIRE/PIN/ROD CUTTERS

Rod Cutters

HAND-HELD ROD CUTTER

All of the benefits of the table top cutter in a hand-held model. Cuts rods from 4.76 mm 3/16" to 6.35 mm (1/4"). **IMPORTANT:** This large cutter is not designed to be used inside the patient's body.

CATALOG #	DESCRIPTION
KM46635	Stainless steel with silicone handle, 27" (68.5 cm)



KM46635

TABLE TOP ROD CUTTER

Provides an easy and safe way to cut spinal rods



KMEDIC® TABLE TOP ROD CUTTER

KM46628

27-1/2" (70 cm)

Cuts rods from 4.76 mm (3/16") to 6.35 mm (1/4")

Powerful double-action jaws enable surgeons to cut 1/4" rods with one hand. Shearing action cuts cleanly – no raised burrs or sharp, jagged edges. Unique cutting process can help prevent the potentially dangerous occurrence of flying rod pieces in the OR.

Ergonomically designed Ortho-Grip™ Silicone Handle provides a comfortable, slip-proof grip. Base and handle are perfectly balanced to ensure stability and prevent lifting. Simple, efficient design has no folding levers, loose parts or bearings that can break down. Cuts rods from 4.76 mm (3/16") to 6.35 mm (1/4").

HOW TO USE THE KMEDIC® TABLE TOP ROD CUTTER:

1. Lift handle up.
2. Insert rod in proper diameter hole.
3. Press handle down.

Ortho-Grip is a trademark or registered trademark of Teleflex® Incorporated or its affiliates.

PLIERS

Pliers

NARROW NOSE WIRE PULLING FORCEPS



KM48253

Extra heavy jaws for pulling K-Wires and Steinmann Pins. An economical alternative to double action pliers. Jaw tapers to 3 mm.

CATALOG #	DESCRIPTION
KM48253	3 mm tip, 7-1/2" (19 cm)

NEEDLE NOSE PLIERS

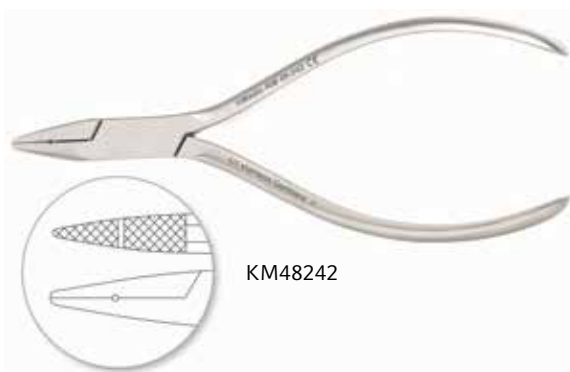

KM48242

Delicate needle nose jaws specifically designed to handle cerclage wire. Jaw tapers to 1 mm.

CATALOG #	DESCRIPTION
KM48242	Delicate, 5-3/8" (13.5 cm)



PLIERS

Pliers

NEEDLE NOSE PLIERS



Jaw tapers to 2 mm, making it easier to get close to the bone to remove K-Wires.

CATALOG #	DESCRIPTION
KM48245	5-3/8" (13.5 cm)

LONG JAW NEEDLE NOSE PLIERS



Long delicate jaws are 2 mm at the tip. Perfect for pulling K-Wires, especially in hard-to-reach sites.

CATALOG #	DESCRIPTION
KM48250	Parallel grooved 2" (50 mm) long jaws, 1.5 mm tip, 7" (18 cm)

PLIERS

Pliers

FLAT NOSE PLIERS



Delicate jaws taper to 2 mm. Made to twist and bend cerclage wire.

CATALOG #	DESCRIPTION
KM48248	Delicate, 2 mm tip, 6" (15 cm)

FLAT NOSE PLIERS



Combination plier and cutter. Cuts all sizes (0.2 mm to 1.5 mm) of cerclage wire. Jaws taper to 3.5 mm.

CATALOG #	DESCRIPTION
KM48243	6-1/2" (16.5 cm)



PLIERS

Pliers

FLAT NOSE PLIERS



For wire manipulation.

CATALOG #	DESCRIPTION
KM48246	Broad, 4 mm tip, 5-3/8" (13.5 cm)

PIN PULLING PLIERS



Tungsten carbide inserts and grooved opposing jaw design grips small pins securely. Small size is well suited for hand procedures. Jaws are 3 mm at tip.

CATALOG #	DESCRIPTION
KM46578	5-1/2" (14 cm), TC

SCREW REMOVAL FORCEPS



Useful for removing 3.0 mm to 4.5 mm screws.

CATALOG #	DESCRIPTION
KM49920	7" (18 cm), with speed lock, TC

PLIERS

Pliers

K-WIRE EXTRACTION PLIERS



KM48257

With screw lock.

CATALOG #	DESCRIPTION
KM48257	3 mm tip, 5" (13 cm)
KM48258	4 mm tip, 7" (18 cm)

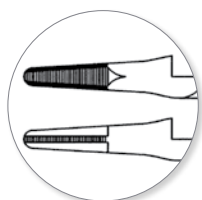

KM48257

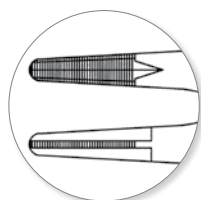

KM48258

WIRE BENDING PLIERS



KM48269

CATALOG #	DESCRIPTION
KM48269	5-7/8" (15 cm)



PLIERS

Pliers

SLIP JOINT PLIERS



KM48262

Traditional design utility pliers with adjustable jaws. Good all-purpose plier for handling Steinmann Pins, K-Wires, screws and rods. 10 mm jaw tip.

CATALOG #	DESCRIPTION
KM48262	Maximum opening 2" (5 cm), 8" (20.5 cm)

FLAT NOSE K-WIRE PLIERS



KM48256

Multi-purpose plier with flat jaws that taper to 6 mm for pulling K-Wire.

CATALOG #	DESCRIPTION
KM48254	6 mm tip, with side groove for cerclage wire, 6-3/4" (17 cm)
KM48256	6 mm tip, 6-3/4" (17 cm)

LINEMAN PLIERS

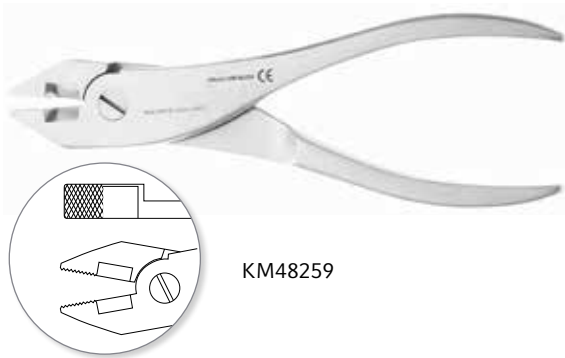

KM48259

Combination pliers and K-Wire Cutter. An economical general purpose instrument with cutting edge.

CATALOG #	DESCRIPTION
KM48259	Side cutting, maximum capacity .062" (1.6 mm), 8-1/2" (21.5 cm)

PLIERS

Pliers

DOUBLE ACTION WIRE EXTRACTION PLIERS



KM46574

- Recommended for heavy use. Double action and finely serrated carbide tips combine to provide a powerful grip on K-Wires and pins.
- 2 mm tip is ideal for removing K-Wire up to 0.62 mm from small, hard-to-reach sites.
- 4 mm and 6 mm jaws are ideal for grasping and pulling all sizes of K-Wires and pins.
- 7-1/4" (18.5 cm).

CATALOG #	DESCRIPTION
KM46572	2 mm delicate jaw, TC
KM46573	4 mm jaw, TC
KM46574	6 mm jaw, TC

PARALLEL PLIERS



KM48604

Parallel grooved 10 mm jaws provide enormous gripping power. Ideal for pin removal.

CATALOG #	DESCRIPTION
KM48604	Maximum opening 1/2", 7-1/4" (18.5 cm)

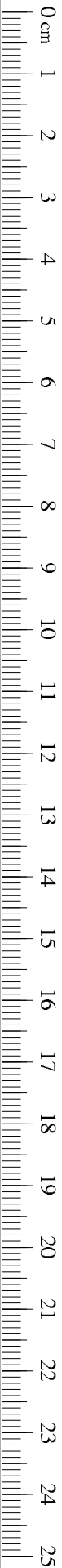

PLIERS

Pliers

PARALLEL PLIERS WITH CUTTER



Combination pliers and wire cutter has all the benefits of our Parallel Pliers plus a cutting jaw for K-Wires up to 0.062" (1.6 mm).



KM48605

CATALOG #	DESCRIPTION
KM48605	Maximum capacity .062" (1.6 mm), 7" (18 cm)

PLIERS

Locking Pliers

HEAVY DUTY LOCKING PLIERS

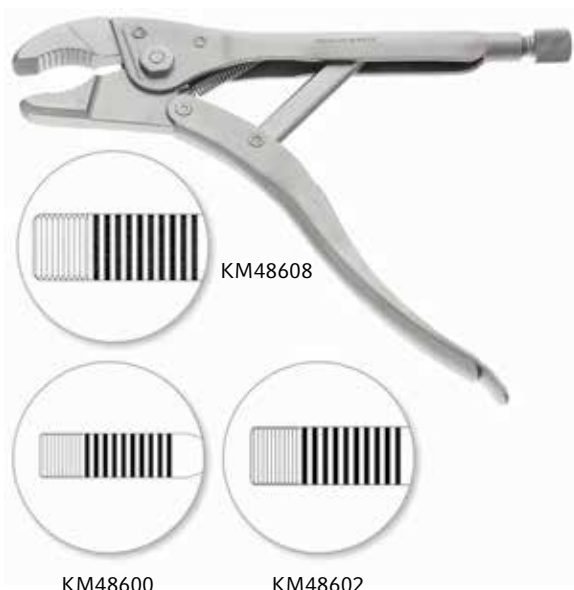

With a new, reinforced, more durable jaw.

- Heavy duty jaws lock securely onto pins.
- Reinforced jaw hinge and housing are more rigid to help prevent side to side shifting.
- Made from 300 and 400 series surgical grade stainless steel.
- Will not chip or contaminate other instrumentation.
- Adjustment screw for easy control of jaw opening.
- One-handed, quick release self-locking lever.
- Available in three sizes.

CATALOG #	DESCRIPTION
KM48600	Small, 7 mm wide tip, maximum opening 1" (25 mm), 6-3/4" (17 cm)
KM48602	Medium, 9 mm wide tip, maximum opening 1" (25 mm), 8" (20.5 cm)
KM48608	Large, 13 mm wide tip, maximum opening 1-1/2" (38 mm), 10" (25.5 cm)

NEEDLE NOSE LOCKING PLIERS



With a new reinforced, more durable jaw.

- New 12" model has an impressive, powerful jaw. The body is made from 2.5 mm stainless steel. This plier will hold up better in the OR than any other needle nose plier – we guarantee it!
- Both pliers have a more durable, reinforced jaw hinge and housing which helps keep the ends in alignment, especially when the plier is twisted.
- Other features: one tapered "V" grooved jaw which locks securely onto pins; adjustment screw; and one-handed, quick release self-locking lever.
- KMedic® Pliers are made from 300 and 400 series surgical grade stainless steel. Unlike "hardware store" quality, they will not chip or contaminate other instrumentation.

CATALOG #	DESCRIPTION
KM48606	9-1/2" (24 cm)
KM48610	Large, 12" (30.5 cm)

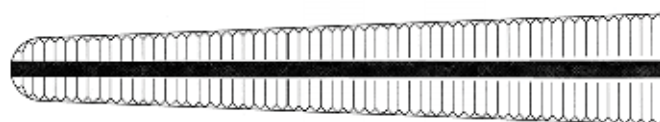

KM48610

PLIERS

Locking Pliers

LOCKING PLIERS WITH SLAPHAMMERS



A powerful combination of locked gripping strength and controlled hammer action.

- These stainless steel heavy duty locking pliers with slaphammers enable surgeons to more easily extract prostheses, intramedullary nails and hip fracture plates.
- The large pliers offer maximum versatility – slaphammers can be attached in three places; on the end or on either side. Small and medium pliers have end attachments only.
- If additional force is required, a mallet may be used on the hammer plate.

CATALOG #	DESCRIPTION
KM48614	Medium, end attachment only, 8" (20.5 cm)
KM48616	Large, end and side attachments, 10" (25.5 cm)
KM48620	Needle Nose Locking Pliers, medium, end attachment only, 9-1/2" (24 cm)
KM48622	Needle Nose Locking Pliers, large, end and side attachments, 12" (30.5 cm)

PLIERS

Plate Bending Pliers

BENDING PLIERS

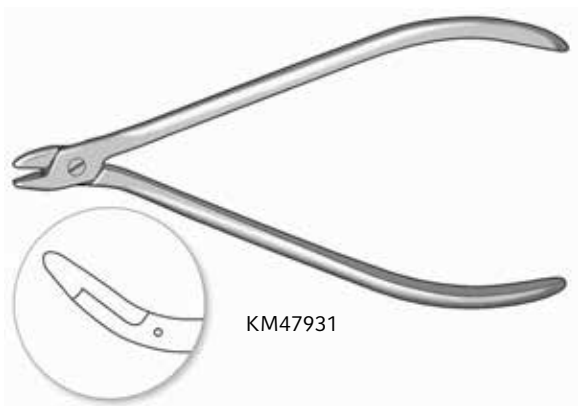

KM47931

For 1.5 mm and 2.0 mm plates.

CATALOG #	DESCRIPTION
KM47931	5-3/4" (14.5 cm)

MINI PLATE BENDING PLIERS

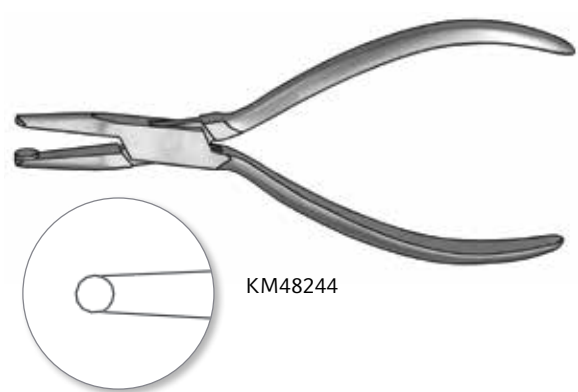

KM48244

For 1.5 mm and 2.0 mm plates.

CATALOG #	DESCRIPTION
KM48244	5-1/8" (13 cm)

PLATE BENDING PLIERS



KM47927

For reconstruction plates.

CATALOG #	DESCRIPTION
KM47927	9-3/8" (23.5 cm)

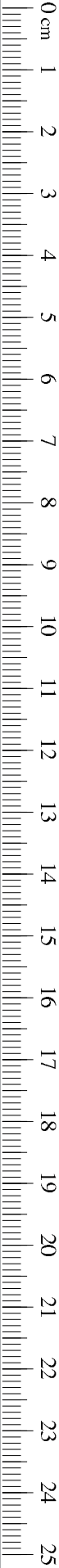

PLIERS

Plate Bending Pliers

SMALL PLATE BENDING PLIERS



KM47925

For 2.7 mm and 3.5 mm plates.

CATALOG #	DESCRIPTION
KM47925	7-5/8" (19.5 cm)

PLATE BENDING PRESS



KM47929

CATALOG #	DESCRIPTION
KM47929	13-3/4" (35 cm)

PLIERS

Socket Wrenches

COMBINATION WRENCH



KM45412

CATALOG #	DESCRIPTION
KM45412	11 mm, 5-1/2" (14 cm)

SOCKET WRENCH



KM47912

CATALOG #	DESCRIPTION
KM45410	11 mm, 7-3/4" (20 cm)
KM47912	Chrome vanadium, 11 mm, 6-3/4" (17 cm)

WRENCH



KM47914

For tightening 8 mm nuts.

CATALOG #	DESCRIPTION
KM47914	5-7/8" (15 cm)



WIRE GUIDES AND TRACTION BOWS

DEMEL WIRE GUIDES



KM48382

CATALOG #	DESCRIPTION
KM48380	30 mm diameter, 10-1/2" (26.5 cm)
KM48382	47 mm diameter, 11-1/2" (29 cm)
KM48384	57 mm diameter, 12-1/2" (32 cm)

WIRE AND PIN TRACTOR (BOEHLER)



KM48328

Each Wire and Pin Tractor comes with a pack of 6 trocar round-end Steinmann Pins as listed.

CATALOG #	SIZE	INSIDE LENGTH	INSIDE WIDTH	PIN INCLUDED	PIN SIZE AND DIAMETER
KM48326	Small	90 mm	75 mm	KM71432	5" 2.4 mm
KM48328	Medium	160 mm	90 mm	KM71434	7" 3.2 mm
KM48330	Large	210 mm	150 mm	KM71525	9" 4.0 mm

KIRSCHNER BOWS



KM48270

Each Kirschner Bow comes with three hooks.

CATALOG #	DESCRIPTION
KM48270	Small, 5-3/4" (14.5 cm)
KM48272	Large, 7-1/2" (19 cm)
KM48274	Extra large, 9-5/8" (24.5 cm)

LIGATURE CARRIERS AND WIRE PASSERS

WIRE PASSERS (CANNULATED)



Cannulation allows for easy feeding of wire around the bone.

CATALOG #	DESCRIPTION
KM48386	45 mm diameter, 7" (18 cm)
KM48388	70 mm diameter, 9-1/2" (24 cm)

SUTURE PASSERS



Used to pass sutures in shoulder surgery. Curved, 9-1/4" (23.5 cm).

CATALOG #	DESCRIPTION
KM46917	With crochet hook
KM46918	With suture hole

Autoclavable to 290°F (143°C)

DRILLS, DRILL BITS AND GUIDES

Drills — Hand Drills

BUNNELL DRILL



Accepts wires and pins up to 4.0 mm (5/32"). Store chuck key in handle. Body is made of aluminum.

CATALOG #	DESCRIPTION
KM48392	Cannulated, 3-jaw stainless Jacobs chuck, includes key chuck, 5-3/4" (14.5 cm)
KM48392P	Key only, stored in drill handle

MARTIN DRILL



Stainless drill, anodized aluminum handle.

CATALOG #	DESCRIPTION
KM48415	10-1/2" (26.5 cm)

MOORE DRILL AND BIT SET



Drill is chrome plated with stainless handle.

CATALOG #	DESCRIPTION
KM48423	Moore Drill and complete set of stainless drill bits
KM48420	Drill only, 11" (28 cm)
KM48421	Drill bit, 70 mm length, 3.2 mm diameter
KM48422	Drill bit, 90 mm length, 3.2 mm diameter

DRILLS, DRILL BITS AND GUIDES

Drills — Hand Drills

RALKS DRILL



Includes key chuck. Accepts wires and pins up to 6.35 mm (1/4"). Offset handle. Body is made of aluminum.

CATALOG #	DESCRIPTION
KM48390	Cannulated, 3-jaw stainless chuck, 5-3/4" (14.5 cm)
KM48390P	Key only

STILLE-SHERMAN DRILL



CATALOG #	DESCRIPTION
KM48469	Drill and complete set of stainless drill bits and burrs
KM48465	Drill only, with quick coupling, chrome plated, stainless handle, 9-1/2" (24 cm)
KM48466	Drill bit, 2.5 mm
KM48467	Drill bit, 3.0 mm
KM48468	Drill bit, 3.5 mm





DRILLS, DRILL BITS AND GUIDES

Drills — Hand Drills

UNIVERSAL DRILL



This hand drill has a two-to-one gear ratio to ensure accurate drilling. The comfortable pistol grip offset handle gives the user perfect control. The chuck shaft and the entire length of the drill are cannulated. The cannulated shaft accepts Steinmann Pins, K-Wire, long shank drills and screwdriver bits up to 4 mm (5/32").

CATALOG #	DESCRIPTION
KM48394	Cannulated, stainless chuck, includes key chuck. Chuck accepts wires and pins up to 6.35 mm (1/4"). Body is made of aluminum, 10" (25.5 cm)

HUDSON DRILL BITS

For use with KM48454 Hudson Drill.



CATALOG #	DESCRIPTION
KM48460	Cushing Drill bit, 14 mm
KM48461	Drill bit, 2 mm
KM48462	McKenzie Drill bit, 13 mm
KM48463	D'Errico Drill bit, 16 mm

DRILLS, DRILL BITS AND GUIDES

Drills — Hand Drills

HUDSON DRILL AND BURRS



KM48454

Burrs sold separately.

CATALOG #	DESCRIPTION
KM48454	Drill only, all stainless steel with improved snap-lock chuck, 10-1/2" (26.5 cm)
KM48456	Hudson Burr, 9 mm
KM48457	Hudson Burr, 14 mm
KM48458	Hudson Burr, 16 mm
KM48459	Hudson Burr, 22 mm
KM48455	Extension Piece, 3-7/8" (9.5 cm)



KM48456



KM48457



KM48458



KM48459



KM48455

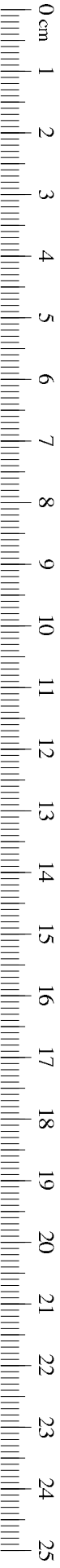

DRILLS, DRILL BITS AND GUIDES

Drills — Quick Coupling Handles

MINI QUICK COUPLING HANDLE



KM47902

For holding quick coupling drills, countersinks, taps and screwdrivers.

CATALOG #	DESCRIPTION
KM47902	For mini screw set, 4-1/8" (10.5 cm)
KM47908	Rounded phenolic handle, 4-3/8" (11 cm)

QUICK COUPLING T-HANDLE



KM47960

For holding quick coupling drills, countersinks, taps and screwdrivers.

CATALOG #	DESCRIPTION
KM47960	For small and large screw sets, 3-1/2" (8.5 cm)

QUICK COUPLING HANDLE



KM47904

For holding quick coupling drills, countersinks, taps and screwdrivers.

CATALOG #	DESCRIPTION
KM47904	4-1/2" (11.5 cm) <i>Autoclavable to 290°F (143°C)</i>

Drills — Adapters

ADAPTER (POWER DRILL)



KM45002

With quick coupling end.

CATALOG #	DESCRIPTION
KM45002	2-1/2" (6.5 cm)

KMEDIC® DRILL BIT CASE

The KMedic® Drill Bit Case provides easy access and can hold up to 19 5" (127 mm) Jacobs chuck* drill bits.

- Reduce OR footprint: Lid folds back and holds the case upright
- Prevent drill bit damage: Tray lowers and holds drill bits in place when closing lid
- Prevent accidental opening: Top of case locks when closed
- Quick identification: Drill bit sizes and part numbers are clearly noted on the inside of case

EASY TO CLEAN

- Innovative one-piece design eliminates the risk of losing drill bits
- Anodized aluminum case is lightweight, yet built to withstand abuse



KM48100

DRILL BIT CASE

KM48100

Drill Bit Case - 5" (127 mm)

Holds 2 each of the 5" Jacob's chuck drill bits

(1 each of size 6.0 mm):

5.5" x 4.25" x 1.75" (140 mm x 108 mm x 45 mm)

5" JACOB'S CHUCK DRILL BITS

CATALOG #	DESCRIPTION	FLUTE LENGTH
KM48129	1.0 mm x 127 mm	22.0 mm
KM48130	1.5 mm x 127 mm	22.0 mm
KM48132	2.0 mm x 127 mm	23.0 mm
KM48134	2.4 mm x 127 mm	22.0 mm
KM48136	2.7 mm x 127 mm	30.0 mm
KM48137	3.2 mm x 127 mm	42.0 mm
KM48138	3.5 mm x 127 mm	42.0 mm
KM48140	4.0 mm x 127 mm	35.0 mm
KM48142	4.7 mm x 127 mm	34.0 mm
KM48143	6.0 mm x 127 mm	37.0 mm

DRILL BIT CASE SET (FULLY LOADED)

KM48144

QUANTITY	INCLUDES	QUANTITY	INCLUDES
2	1.0 mm Drill Bit	2	3.2 mm Drill Bit
2	1.5 mm Drill Bit	2	3.5 mm Drill Bit
2	2.0 mm Drill Bit	2	4.0 mm Drill Bit
2	2.4 mm Drill Bit	2	4.7 mm Drill Bit
2	2.7 mm Drill Bit	1	6.0 mm Drill Bit



KM48137



KM48144

DRILLS, DRILL BITS AND GUIDES

Drill Bits — Jacobs Chuck End

DRILL BITS



KM48079

With round drill chuck end. Designed to fit any Jacobs chuck drill.

CATALOG #	DIAMETER	FLUTE LENGTH	OVERALL LENGTH
KM48070	1.0 mm	25 mm	2-1/8" (5.5 cm)
KM48072	1.1 mm	11 mm	1-3/4" (4.5 cm)
KM48071	1.5 mm	30 mm	2-3/4" (7 cm)
KM48073	2.0 mm	38 mm	3-3/8" (8.5 cm)
KM48076	2.5 mm	43 mm	3-3/4" (9.5 cm)
KM48077	2.7 mm	32 mm	3-3/8" (8.5 cm)
KM48080	3.2 mm	40 mm	5-1/8" (13 cm)
KM48079	3.2 mm	70 mm	7-1/8" (18 cm)
KM48081	3.5 mm	42 mm	3-3/4" (9.5 cm)
KM48082	3.5 mm	50 mm	7-1/8" (18 cm)
KM48085	4.5 mm	55 mm	5-1/8" (13 cm)
KM48086	6.0 mm	70 mm Extra-Long	7-1/8" (18 cm)

Drill Bits — Quick Coupling End

DRILL BITS



KM48057

With quick coupling ends. To drill gliding and threaded holes. Designed to fit quick coupling handles KM47902, KM47904 and KM47960.

CATALOG #	DIAMETER	FLUTE LENGTH	WORKING LENGTH	OVERALL LENGTH
KM48051	1.1 mm	20 mm	35 mm	2-3/8" (6 cm)
KM48052	1.5 mm	23 mm	60 mm	3-3/8" (8.5 cm)
KM48054	2.0 mm	50 mm	75 mm	3-7/8" (10 cm)
KM48057	2.5 mm	50 mm	85 mm	4-3/8" (11 cm)
KM48058	2.7 mm	50 mm	75 mm	3-7/8" (10 cm)
KM48061	3.2 mm	50 mm	120 mm	5-3/4" (14.5 cm)
KM48060	3.2 mm	50 mm	170 mm Extra-Long	7-5/8" (19.5 cm)
KM48063	3.5 mm	50 mm	85 mm	4-3/8" (11 cm)
KM48050	3.5 mm	50 mm	170 mm Extra-Long	7-5/8" (19.5 cm)
KM48067	4.5 mm	50 mm	120 mm	5-3/4" (14.5 cm)
KM48068	4.5 mm	50 mm	170 mm Extra-Long	7-5/8" (19.5 cm)
KM48069	6.0 mm	60 mm	170 mm Extra-Long	7-5/8" (19.5 cm)

DRILLS, DRILL BITS AND GUIDES

Drill Bits — Three-Fluted Drill Bits

THREE-FLUTED DRILL BITS

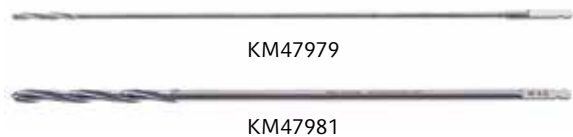

With quick coupling ends.

CATALOG #	DIAMETER	FLUTE LENGTH	WORKING LENGTH	OVERALL LENGTH
KM48091	2.5 mm	30 mm not calibrated	85 mm	4-3/8" (11 cm)
KM48092	2.5 mm	28 mm not calibrated	155 mm	7-1/8" (18 cm)
KM47986	2.5 mm	30 mm calibrated	205 mm	9" (23 cm)
KM48093	3.2 mm	38 mm not calibrated	120 mm	5-3/4" (14.5 cm)
KM48094	3.2 mm	38 mm not calibrated	170 mm	7-5/8" (19.5 cm)
KM47979	3.2 mm	30 mm calibrated	205 mm	9" (23 cm)
KM48095	4.5 mm	45 mm not calibrated	120 mm	5-3/4" (14.5 cm)
KM47981	4.5 mm	58 mm not calibrated	170 mm	7-5/8" (19.5 cm)



DRILLS, DRILL BITS AND GUIDES

Drill Bits — Countersinks

MINI COUNTERSINK



KM47920

For mini screws 1.5/2.0 mm. Mini quick coupling end.

CATALOG #	DESCRIPTION
KM47920	1.1 mm tip, 2-1/4" (5.5 cm)

SMALL COUNTERSINKS



KM47922

For small screws 2.7/3.5/4.0 mm. Quick coupling end.

CATALOG #	DESCRIPTION
KM47922	2.0 mm tip, 2-7/8" (7 cm)
KM47923	90 degrees, 2.0 mm tip, 2-1/2" (6 cm)

MALLEOLAR COUNTERSINK



KM47924

For malleolar screws. Quick coupling end.

CATALOG #	DESCRIPTION
KM47924	3.2 mm tip, 4-1/2" (11.5 cm)

DRILLS, DRILL BITS AND GUIDES

Drill Bits — Countersinks

LARGE COUNTERSINK



For large screws 4.5/6.5 mm.

CATALOG #	DESCRIPTION
KM47926	4.5 mm tip, 7-1/8" (18 cm)

Drill Bits — Taps

TAPS



With quick coupling ends, calibrated with cm graduations.

CATALOG #	DESCRIPTION
KM48104	3.5 mm diameter, for cortical screws, 7"
KM48102	Mini quick coupling, 4.5 mm diameter, for cortical screws, 7"
KM48122	6.5 mm diameter, for cancellous screws, 8"

TAPS



With quick coupling ends, for 4.5 mm cortical and 4.5 mm malleolar (shaft) screws.

CATALOG #	DESCRIPTION
KM48116	5"
KM48118	Long thread, 5"
KM48120	Extra-long thread, 5"



DRILLS, DRILL BITS AND GUIDES

Drill Bits — Taps

TAPS

Taps: Used to prepare thread path for insertion of bone screws. With quick coupling ends.

CATALOG #	DESCRIPTION
KM48106	Mini quick coupling, 1.5 mm diameter, for cortical screws, thread pitch 0.5 mm, 2"
KM48108	Mini quick coupling, 2.0 mm diameter, for cortical screws, thread pitch 0.6 mm, 2-1/8"
KM48110	2.7 mm diameter, for cortical screws, thread pitch 1.0 mm, 4"
KM48112	3.5 mm diameter, fine thread, for cortical screws, thread pitch 1.25 mm, 4-3/8"
KM48114	3.5 mm diameter, coarse thread, for 3.5 and 4.0 mm cancellous screws, thread pitch 1.75 mm, 4-3/8"



KM48106



KM48108



KM48110



KM48112



KM48114

DRILLS, DRILL BITS AND GUIDES

Drill Guides and Sleeves

DRILL GUIDES



Drill guide ends are color coded.

Green = neutral

Gold = load

CATALOG #	DESCRIPTION
KM47977	2.0 mm, neutral and load end, for 2.0 mm drill bit and 2.7 mm cortical screw, 5-3/8" (13.5 cm)
KM48003	2.0 mm, neutral and load end, for 1.5 mm drill bit and 2.0 mm cortical screw, 4-3/8" (11 cm)
KM47978	2.5 mm, neutral and load end, for 2.5 mm drill bit and 3.5 mm cortical screw, 6-1/8" (15.5 cm)
KM47980	3.2 mm, neutral and load end, for 3.2 mm malleolar (shaft) drill bit and 4.5 mm cortical screw, 6-1/2" (16.5 cm)

UNIVERSAL DRILL GUIDE



Can be used as neutral/load drill guide.

CATALOG #	DESCRIPTION
KM48004	For 3.5 mm cortical screws and 3.5 mm malleolar (shaft) screws and 2.5 mm drill bits, 5-1/2" (14 cm)
KM47985	For 4.5 mm cortical screws and 4.5 mm malleolar (shaft) screws and 3.2 mm drill bits, 7-1/8" (18 cm)

DRILLS, DRILL BITS AND GUIDES

Drill Guides and Sleeves

PARALLEL DRILL GUIDE AND DRILL SLEEVE



KM47970

CATALOG #	DESCRIPTION
KM47970	2 mm tip, three holes and one hole for 2.0 mm drill bits, 4-1/2" (11.5 cm)

DOUBLE DRILL SLEEVES



KM47972

CATALOG #	DESCRIPTION
KM47968	For 1.1 mm and 1.5 mm drill bits and tap for 1.5 mm cortical screws
KM47966	For 1.5 mm and 2.0 mm drill bits and tap for 2.0 mm cortical screws
KM48002	For 2.0 mm and 2.7 mm drill bits and tap for 2.7 mm cortical screws
KM47972	For 2.5 mm and 3.5 mm drill bits, tap for 3.5 mm cortical screws and tap for 4.0 mm cancellous screws
KM47967	For 3.2 mm and 4.5 mm drill bits, tap for 4.5 mm cortical screws and tap for 4.5 mm malleolar (shaft) screws
KM47965	For 3.2 mm drill bits and tap for 6.5 mm cancellous screws

DRILL SLEEVES



KM47976

CATALOG #	DESCRIPTION
KM47976	40 mm long tip, for 3.2 mm drill bits, for round hole and semi-tubular plates, 4-1/2" (11.5 cm)
KM47982	60 mm long tip, for 3.2 mm drill bits, for round hole plates, 5" (12.5 cm)

DRILLS, DRILL BITS AND GUIDES

Drill Guides and Sleeves

INSERT DRILL SLEEVE



KM47974

CATALOG #	DESCRIPTION
KM47974	For 2.5 mm drill bits and long 3.5 mm lag screws, 1-5/8" (4 cm)

INSERT DRILL SLEEVE



KM47973

CATALOG #	DESCRIPTION
KM47973	For 3.2 mm drill bits and 4.5 mm lag screws, 3-1/8" (8 cm)

TAP SLEEVES



KM47971

Also can be used as 3.2 mm drill bit guide.

CATALOG #	DESCRIPTION
KM47971	For 3.2 mm drill bits, 4-1/2" (11.5 cm)

DRILLS, DRILL BITS AND GUIDES

Drill Guides and Sleeves

TAP SLEEVES



KM47969

Also can be used as 4.5 mm drill bit guide.

CATALOG #	DESCRIPTION
KM47969	4.5 mm diagonal, with toothed tip and tissue protector sleeve for 4.5 mm tap, 5-1/2" (14 cm)

GUIDEWIRE W/DRILLPOINT

CATALOG #	DESCRIPTION
KM48282	2 mm x 98 cm
KM48284	3 mm x 98 cm

POINTED DRILL GUIDE



KM47975

Used with tap sleeve KM47969 or KM47967.

CATALOG #	DESCRIPTION
KM47975	For 4.5 mm cortical screws, 6" (15 cm)

TREPHINES

MICHELE TREPHINE



KM48240

Designed for bone biopsy. Also facilitates removal of broken bone screws. 7-1/2" (19 cm).

CATALOG #	DESCRIPTION
KM48239	Small, 3 mm I.D., 5 mm O.D.
KM48240	Medium, 4 mm I.D., 6 mm O.D.
KM48241	Large, 6 mm I.D., 8.1 mm O.D.

P.I. PLUG CUTTER



KM48252

When removing K-Wire, use the Plug Cutter to extract a tiny cylinder of bone around the tip of the wire.

CATALOG #	DESCRIPTION
KM48252	3 mm I.D., 5 mm O.D., length with obturator 4-1/2" (11.5 cm)

PLUG CUTTER



KM69832

- These cutters are especially useful for arthrodesis of small and large joints by plug cutter graft technique.
- The plug cutters are designed to be used in pairs.
- The smaller diameter instrument will cut the plug opening and the larger one will harvest a bone graft that will fit into the opening.
- The plug can then be tapped into place using the Bone Impactor (KM69980).
- 6" (15 cm).

CATALOG #	DESCRIPTION
KM69830	5 mm I.D., 7 mm O.D.
KM69832	7 mm I.D., 9 mm O.D.
KM69834	10 mm I.D., 12 mm O.D.
KM69836	12 mm I.D., 14 mm O.D.
KM69838	20 mm I.D., 22 mm O.D.
KM69840	22 mm I.D., 24 mm O.D.



SCREWDRIVERS

Hex Head

HEXAGONAL SCREWDRIVERS

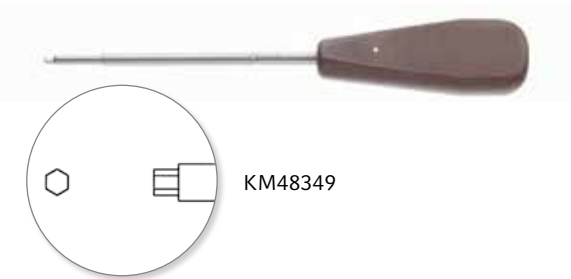
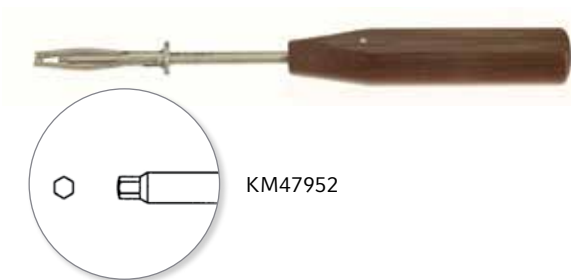

CATALOG #	DESCRIPTION
KM47952	2.5 mm screwdriver with sleeve, 7-7/8" (20 cm)
KM48368	2.5 mm screwdriver with notch, 8-1/4" (21 cm)
KM48349	3.5 mm screwdriver with notch, 9-5/8" (24.5 cm)
KM47955	Screw holding sleeve only for KM47952, 2" (5 cm)
KM48365	Screw holding sleeve only for KM48368, 3" (8 cm)
KM47983	Screw holding sleeve only for KM48349, 5" (12.5 cm)
KM47956	Screwdriver only for KM47952

Autoclavable to 290°F (143°C)

HEXAGONAL SCREWDRIVER SHAFT (PELVIC)



CATALOG #	DESCRIPTION
KM47951	2.5 mm with notch, quick coupling end, 6-1/2" (16.5 cm)
KM47953	2.5 mm without notch, quick coupling end, 4" (10 cm)
KM47961	3.5 mm with notch, quick coupling end, 6-1/2" (16.5 cm)
KM48365	Sleeve only for KM47951, 3" (8 cm)
KM47983	Sleeve only for KM47961, 5" (12.5 cm)

SCREWDRIVERS

Hex Head

SCREWDRIVER SLEEVES



CATALOG #	DESCRIPTION
KM48365	Sleeve only for KM47951, KM48348, KM48364, KM48368, 3" (8 cm)
KM47983	Sleeve only for KM48349, KM48353 and KM47961, 5" (12.5 cm)

LARGE HEXAGONAL SCREWDRIVER (PELVIC)

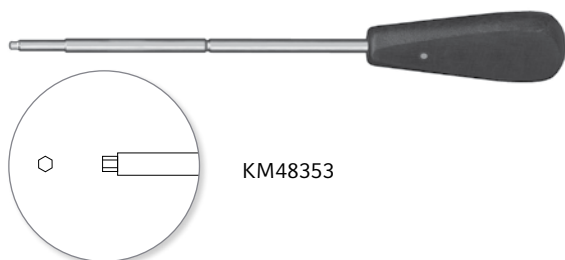

CATALOG #	DESCRIPTION
KM48353	3.5 mm screwdriver with notch, 11-3/4" (30 cm)
KM48364	Screwdriver only, 2.5 mm with notch, 11" (27 cm)
KM47983	Sleeve only for KM48353, 5" (12.5 cm)

Autoclavable to 290°F (143°C)

LARGE HEX SCREWDRIVER WITH UNIVERSAL JOINT



CATALOG #	DESCRIPTION
KM48396	3.5 mm tip, 11-5/8" (29.5 cm)

LARGE HEXAGONAL SCREWDRIVER



CATALOG #	DESCRIPTION
KM47954	3.5 mm, quick coupling end, 3-7/8" (10 cm)



SCREWDRIVERS

Hex Head

MINI HEXAGONAL SCREWDRIVER



KM47950

KM47950B

KM47959

CATALOG #	DESCRIPTION
KM47950	1.5 mm, mini quick coupling end, sleeve included, 2-1/4" (5.5 cm)
KM47950B	Shaft only, 1.5 mm with notch, mini quick coupling end, 2" (5 cm)
KM47959	Screw holding sleeve only

HEXAGONAL SCREWDRIVER SHAFT



KM48348

KM48365

CATALOG #	DESCRIPTION
KM48348	2.5 mm with notch, quick coupling end, 5-1/2" (14 cm)
KM48365	Sleeve only

SCREWDRIVERS

Hex Head

SCREWDRIVER

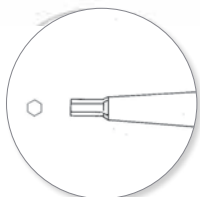

KM48350

CATALOG #	DESCRIPTION
KM48670	1.5 mm hexagonal, 7-7/16" (200 mm)
KM48350	2.5 mm hexagonal, 9-27/32" (250 mm)
KM48352	3.5 mm hexagonal, 9-27/32" (250 mm)
KM48354	Single slot, 9-27/32" (250 mm)
KM48356	Cruciform, 9-27/32" (250 mm)
KM48358	Phillips, 9-27/32" (250 mm)

Autoclavable to 290°F (143°C)

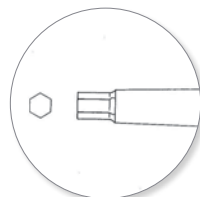

KM48352

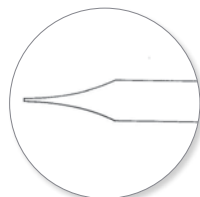

KM48354

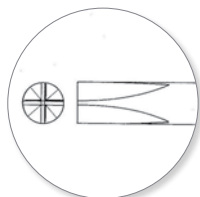

KM48356

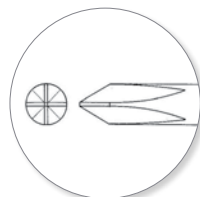

KM48358

SINGLE SLOT SCREWDRIVER

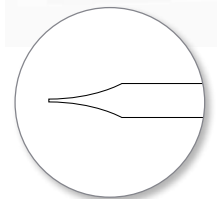

KM48355

CATALOG #	DESCRIPTION
KM48355	Phenolic handle, 6-3/4" (17 cm)

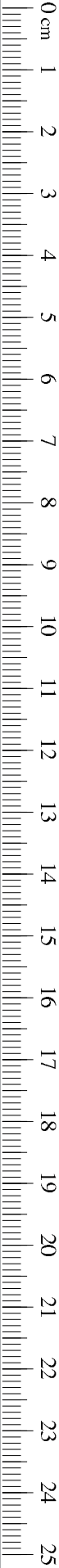

SCREWDRIVERS

Cruciform Head

CRUCIFORM SCREWDRIVER



CATALOG #	DESCRIPTION
KM47957	1.5 / 2.0 mm screwdriver with sleeve, 7-1/2" (19 cm)
KM47959	Screw holding sleeve only for KM47957
KM47958	Screwdriver only for KM47957

Autoclavable to 290°F (143°C)

MINI CRUCIFORM SCREWDRIVER BIT



CATALOG #	DESCRIPTION
KM45004	1.5 / 2 mm, mini quick coupling end, 2-1/2" (6.5 cm)

SCREWDRIVERS

T-Handle

LARGE HEX SCREWDRIVER W/ T-HANDLE

CATALOG #	DESCRIPTION
KM48395	3.5 mm, quick coupling end, 6-7/8" (17.5 cm)

Depth Gauge

SCREW DEPTH GAUGES



KM47934

Used to determine screw length required during internal fracture fixation (mm graduated). Snaps apart for easy cleaning. **IMPORTANT NOTE:** When not in use, retract measuring end inside gauge for probe protection.

CATALOG #	DESCRIPTION
KM47934	Mini, up to 30 mm, 4-3/4" (12 cm)
KM47936	Small, up to 50 mm, 6-1/4" (16 cm)
KM47940	Large, up to 100 mm, 8-3/4" (22 cm)
KM47935	Extra-long, up to 120 mm, 11" (28 cm)



SCREWDRIVERS

Screwdriver Sets

INTERCHANGEABLE SCREWDRIVER SET



KM48473



KM48474



KM48475



KM48476



KM48477

CATALOG #	DESCRIPTION
KM48473	Screwdriver handle. Allows K-Wire and pins to be inserted with Jacobs Universal Chuck KM48478. Cannulation 1/4" (6.3 mm), includes key, 5-1/2" (14 cm)
KM48474	Single slot, 5-1/2" (14 cm)
KM48475	Cruciform, 5-1/2" (14 cm)
KM48476	Phillips, 5-1/2" (14 cm)
KM48477	Small Phillips, 5-1/2" (14 cm)
KM48478	Jacobs Universal Chuck. Allows K-Wire and pins to be inserted with Jacobs Chuck. Cannulation 1/4" (6.3 mm), includes key, 3" (7.5 cm)
KM48478P	Key for KM48478 Jacobs Universal Chuck
KM48479	3.5 mm diameter, 5-1/2" (14 cm)
KM48480	2.5 mm diameter, 5-1/2" (14 cm)



KM48478



KM48479



KM48480

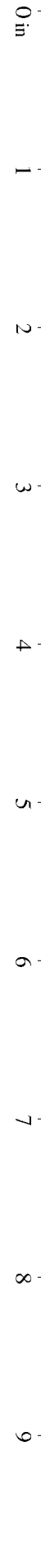

SCREWDRIVERS

Screw Holding Forceps

SELF-RETAINING SCREW HOLDING FORCEPS



KM47930

CATALOG #	DESCRIPTION
KM47930	3-1/2" (9 cm)

SELF-RETAINING SCREW HOLDING FORCEPS



KM45210

CATALOG #	DESCRIPTION
KM45208	For 1.5 mm to 2.7 mm screws
KM45210	For 3.5 mm to 6.5 mm screws



BENDING IRONS AND ROD HOLDERS

UNIVERSAL ROD BENDER



KM46664

CATALOG #	DESCRIPTION
KM46664	11-1/4" (28.5 cm)

IN SITU ROD BENDERS



KM49780



KM49781

Used in pairs, 13" (33 cm).

CATALOG #	DESCRIPTION
KM49780	Right, bends 3/16" (4.76 mm) rods
KM49781	Left, bends 3/16" (4.76 mm) rods
KM49782	Right, bends 1/4" (6.35 mm) rods
KM49783	Left, bends 1/4" (6.35 mm) rods

ONE-HANDED ROD BENDER



KM49812

For 3 mm and 4 mm diameter rods.

CATALOG #	DESCRIPTION
KM49812	7-1/2" (19 cm)

BENDING IRONS AND ROD HOLDERS

ROD HOLDERS



KM49830

With ratchet, 7-1/4" (18.5 cm).

CATALOG #	DESCRIPTION
KM49830	Holds 5/32" (4.0 mm) rods
KM49831	Holds 3/16" (4.76 mm) rods
KM49832	Holds 1/4" (6.35 mm) rods

ROD HOLDERS



KM49706

Curved tip, with ratchet, 8-1/4" (21 cm).

CATALOG #	DESCRIPTION
KM49701	Threaded hole, holds 5/32" (4.0 mm) rods
KM49702	Threaded hole, holds .177" (4.5 mm) rods
KM49706	Without threaded hole, holds .197" (5.0 mm) rods

ROD HOLDER



KM49850

With ratchet, 10" (25.5 cm).

CATALOG #	DESCRIPTION
KM49850	Holds 1/4" (6.35 mm) rods, threaded hole
KM49848	Prism holds 0.197" (5 mm) and 5.5 mm rods

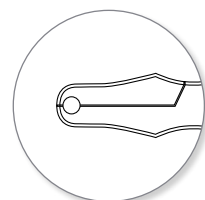

KM49850

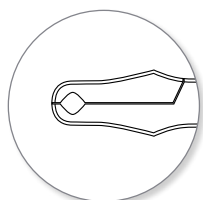

KM49848



BENDING IRONS AND ROD HOLDERS

MINI PLATE BENDING IRON



KM47917

For mini and finger plates.

CATALOG #	DESCRIPTION
KM47917	4-3/4"

SMALL PLATE BENDING IRONS



KM47916

Used in pairs. For 3.5 mm and 2.7 mm plates.

CATALOG #	DESCRIPTION
KM47916	5-1/2" (14 cm)
KM47915	5-1/2" (14 cm)



KM47915

STANDARD PLATE BENDING IRON



KM47918

For standard plates, with 4 holes.

CATALOG #	DESCRIPTION
KM47918	9-1/2"

BENDING IRONS AND ROD HOLDERS

PLATE BENDING IRON

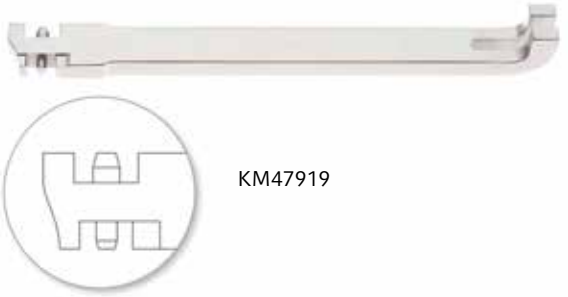

KM47919

CATALOG #	DESCRIPTION
KM47919	For 3.5 mm and 4.5 mm plates

BENDING IRONS



KM45501

CATALOG #	DESCRIPTION
KM45501	For 0.8 - 1.25 mm K-Wires, 4-1/2" (11.5 cm)
KM45502	For 1.25, 1.6 and 2 mm K-Wires, 4-3/4" (12 cm)

PLATE HOLDING CLIPS



KM47963

CATALOG #	DESCRIPTION
KM47962	2.0 mm
KM47963	2.7 mm
KM47964	3.5 mm



ORTHOPEDIC RETRACTORS

Hand-Held Orthopedic Retractors

FRAZIER HOOKS



5" (12.5 cm).

CATALOG #	DESCRIPTION
KM48158	1 sharp prong, 2.5 mm diameter
KM48161	1 blunt prong, 2.5 mm diameter

GILLIES HOOKS



7" (18 cm).

CATALOG #	DESCRIPTION
KM58077	Small
KM58083	Large

ADSON DISSECTOR HOOKS



8" (20.5 cm).

CATALOG #	DESCRIPTION
654180	Blunt
654181	Sharp

ORTHOPEDIC RETRACTORS

Hand-Held Orthopedic Retractors

FRAZIER DURA HOOKS



654191

CATALOG #	DESCRIPTION
654190	Blunt, 4-3/4" (12 cm)
654191	Sharp, 4-7/8" (12.5 cm)

HOEN HOOKS



594400

9-1/4" (23.5 cm).

CATALOG #	DESCRIPTION
594400	Short prong
594402	Long prong

SNOOK HOOK



KM71431

Veterinary.

CATALOG #	DESCRIPTION
KM71431	8" (20.5 cm)

SMITHWICK DISSECTOR AND HOOK



622700

CATALOG #	DESCRIPTION
622700	12-1/4" (31 cm)



ORTHOPEDIC RETRACTORS

Hand-Held Orthopedic Retractors

HOLSHER NERVE RETRACTORS

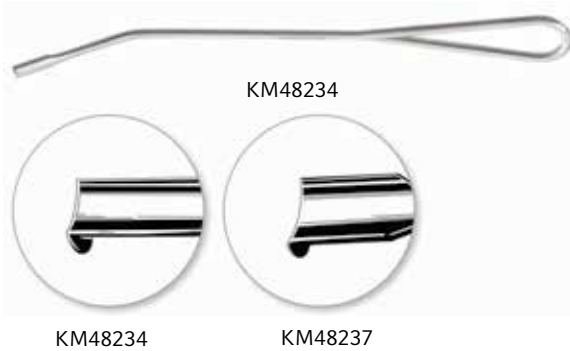

Primarily used to retract the nerve root. Blunt hook.
9-1/2" (24 cm).

CATALOG #	DESCRIPTION
KM48234	7 mm blade
KM48237	9 mm blade

NERVE ROOT RETRACTOR

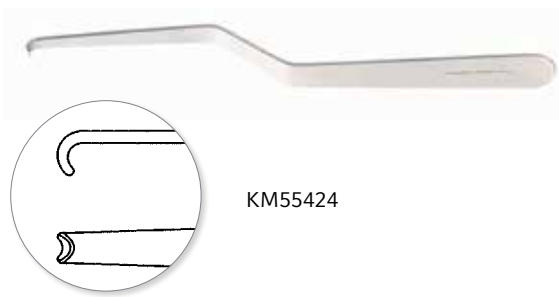

Retractor blade lies on same plane as surgeon's finger.
Gives surgeon unobstructed view.

CATALOG #	DESCRIPTION
KM55424	6 mm blade, 8-1/4" (21 cm)

BAYONET NERVE RETRACTOR

CATALOG #	DESCRIPTION
KM46932	7 mm wide x 1 mm deep blade

ORTHOPEDIC RETRACTORS

Hand-Held Orthopedic Retractors

SCOVILLE NERVE ROOT RETRACTORS



KM55426

Angled.

CATALOG #	DESCRIPTION
KM55426	8 mm blade, 8" (20.5 cm)
KM55428	13 mm blade, 7-5/8" (19.5 cm)

PERPENDICULAR NERVE RETRACTOR

CATALOG #	DESCRIPTION
KM46930	7 mm wide x 1 mm deep blade angled 90 degrees

RAGNELL-LINDE RETRACTOR



KM69982

Fine cross serrations help prevent slippage.
Double-ended with serrations, 5-1/4" (13.5 cm).

CATALOG #	DESCRIPTION
KM69982	4 x 8 mm and 6 x 15 mm blades



ORTHOPEDIC RETRACTORS

Hand-Held Orthopedic Retractors

BLADE RETRACTORS



KM55421

CATALOG #	DESCRIPTION
KM55420	18 mm wide blade, 7" (18 cm)
KM55421	20 mm wide blade, 7" (18 cm)
KM55422	23 mm wide blade, 7" (18 cm)

LANGENBECK RETRACTORS



KM51104

CATALOG #	DESCRIPTION
KM51100	#1, 3/8" x 1-1/4" (10 x 32 mm), 8-7/8" (22.5 cm)
KM51104	#2, 3/8" x 1-3/4" (10 x 45 mm), 8" (20.5 cm)
KM51108	#3, 1/2" x 1-3/4" (15 x 45 mm), 8-1/2" (21.5 cm)
KM51112	#4, 5/8" x 1-1/2" (16 x 38 mm), 8" (20.5 cm)

DEEP RAKE RETRACTORS



KM52294

10-1/2" (26.5 cm).

CATALOG #	DESCRIPTION
KM52292	4 blunt prongs, 2-1/4" wide x 1-1/2" deep (5.5 x 4 cm)
KM52294	4 blunt prongs, 2-1/4" wide x 2" deep (5.5 x 5 cm)
KM52296	4 blunt prongs, 2-1/4" wide x 2-1/2" deep (5.5 x 6.5 cm)
KM52298	4 blunt prongs, 2-1/4" wide x 3" deep (5.5 x 7.5 cm)

ORTHOPEDIC RETRACTORS

Hand-Held Orthopedic Retractors

ISRAEL RAKE RETRACTORS



9-1/2" (24 cm).

CATALOG #	DESCRIPTION
KM51078	3 blunt prongs, 30 mm wide x 37 mm deep
KM51080	4 blunt prongs, 40 mm wide x 40 mm deep

OLLIER RAKE RETRACTOR



CATALOG #	DESCRIPTION
KM52282	4 blunt prongs, 55 mm wide x 40 mm deep blade, 9" (23 cm)

MEYERDING LAMINECTOMY RETRACTORS



Sharp teeth.

CATALOG #	DESCRIPTION
KM51158	Small, 17 mm wide blade, 9-1/2" (24 cm)
KM51162	Medium, 25 mm wide blade, 9-1/2" (24 cm)
KM51164	Large, 50 mm wide blade, 10" (25.5 cm)



ORTHOPEDIC RETRACTORS

Hand-Held Orthopedic Retractors

TAYLOR SPINAL RETRACTORS



KM52458

CATALOG #	DESCRIPTION
KM52458	1-1/4" wide x 3" long blade (3 x 7.5 cm), 7-3/4" (19.5 cm)
KM52460	1-1/4" wide x 4" long blade (3 x 10 cm), 7-3/4" (19.5 cm)

TAYLOR RETRACTORS



KM46936

CATALOG #	DESCRIPTION
KM46934	Distal tip 3/4" wide and 3" long (20 x 76 mm), overall length 8-1/8" (20.5 cm)
KM46936	Distal tip 3/4" wide and 4" long (20 x 102 mm), overall length 8-1/8" (20.5 cm)

HIBBS RETRACTORS



KM51060

Used for deep soft tissue retraction. Sharp teeth, 9-1/2" (24 cm).

CATALOG #	DESCRIPTION
KM51059	25 mm wide x 50 mm deep blade
KM51060	26 mm wide x 75 mm deep blade
KM51061	25 mm wide x 100 mm deep blade

ORTHOPEDIC RETRACTORS

Hand-Held Orthopedic Retractors

AUFRANC COBRA RETRACTORS

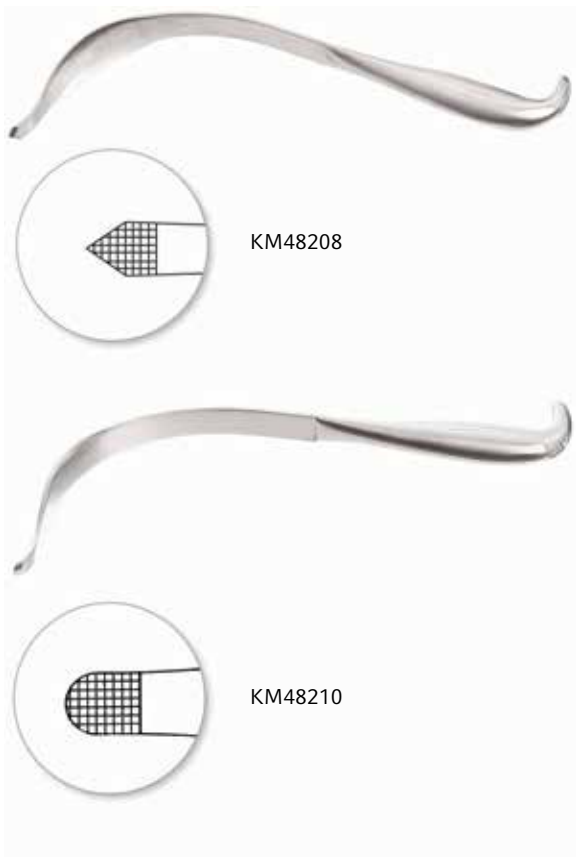

With hollow handle, 1-1/4" wide blade, 10-1/2" (26.5 cm).

CATALOG #	DESCRIPTION
KM48208	Serrated, pointed tip, 10 mm
KM48212	Smooth, blunt tip, 10 mm
KM48210	Serrated, blunt tip, 10 mm
KM48214	Smooth, pointed tip, 10 mm

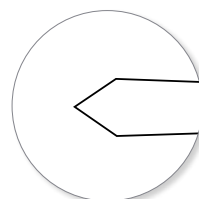
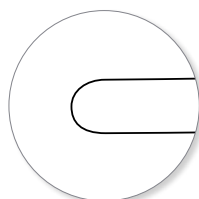
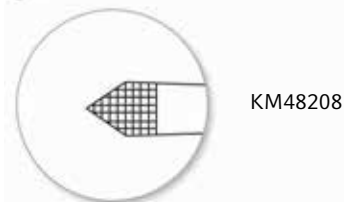

BENNETT BONE ELEVATOR AND RETRACTORS



Hollow handle, 10" (25.5 cm).

CATALOG #	DESCRIPTION
KM46880	Small, 1-3/4" (4.5 cm) wide blade
KM46884	Large, 2-1/2" wide blade

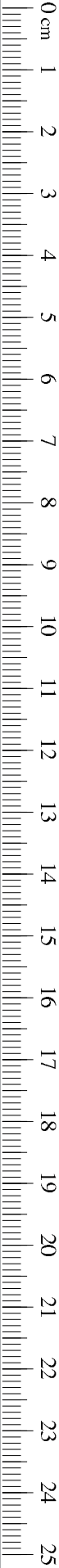

ORTHOPEDIC RETRACTORS

Hand-Held Orthopedic Retractors

PELVIC RETRACTOR



KM48201



CATALOG #	DESCRIPTION
KM48201	1" (24 mm) wide blade, 1/2" (12 mm) wide distal tip, 10-5/8" (27 cm)

MURPHY BONE SKID



KM46892

CATALOG #	DESCRIPTION
KM46892	11-3/4" (30 cm)

ORTHOPEDIC RETRACTORS

Shoulder and Knee Retractors

FUKUDA STYLE SHOULDER RETRACTORS



7" (18 cm).

CATALOG #	DESCRIPTION
KM46906	1-1/2" wide x 3-1/4" long blade (4 x 8 cm)
KM46907	1-1/4" wide x 3-1/4" long blade (3 x 8 cm)

CAPSULE RETRACTOR



CATALOG #	DESCRIPTION
KM46908	3 sharp prongs, 22 mm wide blade, 10" (25.5 cm)

BRISTOW/BANKART SOFT TISSUE RETRACTOR



CATALOG #	DESCRIPTION
KM46872	3 blunt prongs, 21 mm wide blade, 7-7/8" (20 cm)



ORTHOPEDIC RETRACTORS

Shoulder and Knee Retractors

BRISTOW/BANKART HUMERAL RETRACTOR

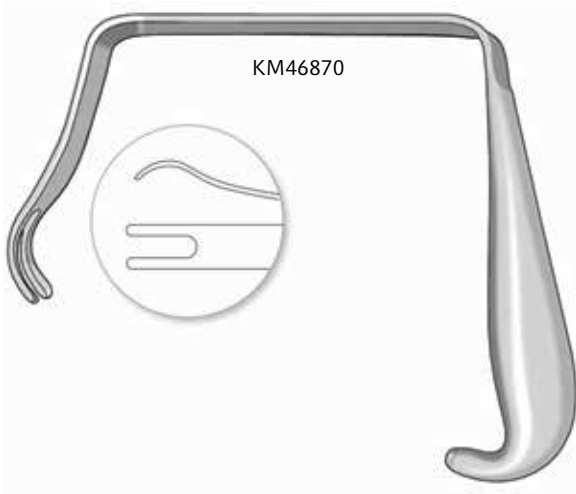

CATALOG #	DESCRIPTION
KM46870	2 blunt prongs, 25 mm wide x 102 mm deep, 7-1/2" (19 cm)

HUMERAL HEAD RETRACTOR



CATALOG #	DESCRIPTION
KM46860	18 mm wide blade, 8-3/4" (22 cm)

ORTHOPEDIC RETRACTORS

Shoulder and Knee Retractors

BLOUNT DOUBLE PRONG RETRACTOR



CATALOG #	DESCRIPTION
KM48204	1-3/4" (44 mm) wide blade, 10-1/2" (26.5 cm)

BLOUNT KNEE RETRACTOR



CATALOG #	DESCRIPTION
KM48206	6 mm wide distal tip, 6-7/8" (17.5 cm)

BLOUNT SINGLE PRONG RETRACTOR



CATALOG #	DESCRIPTION
KM48202	1-1/2" (37 mm) width blade, 10-1/2" (26.5 cm)



ORTHOPEDIC RETRACTORS

Shoulder and Knee Retractors

SMILLIE KNEE RETRACTORS

5-1/2" (14 cm).

CATALOG #	DESCRIPTION
KM48192	Reverse curve, 13 mm wide x 55 mm long blade
KM48198	19 mm wide x 30 mm long blade
KM48194	19 mm wide x 45 mm long blade
KM48196	19 mm wide x 60 mm long blade
KM48200	Full curve, 13 mm wide x 18 mm long blade

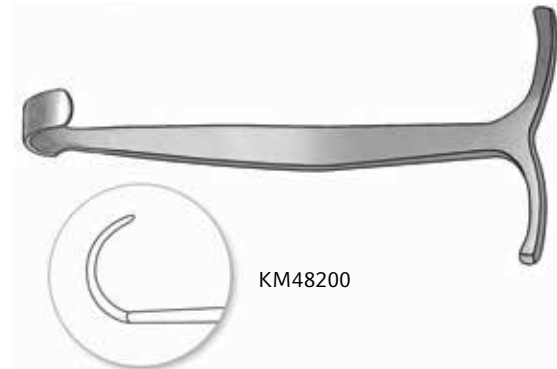

ORTHOPEDIC RETRACTORS

Hohmann Retractors

HAYES HAND RETRACTORS



Used to elevate carpals and phalanges during hand procedures.

CATALOG #	DESCRIPTION
KM46823	3 mm wide distal tip, 6-1/4" (16 cm)
KM46829	6 mm wide distal tip, 6" (15 cm)

MINI HOHMANN RETRACTORS

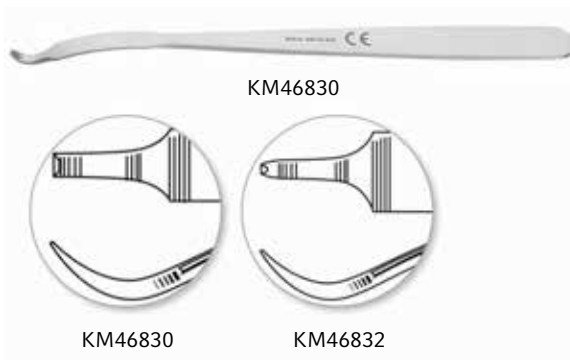

6-1/2" (16.5 cm).

CATALOG #	DESCRIPTION
KM46830	6 mm wide blade
KM46832	8 mm wide blade



ORTHOPEDIC RETRACTORS

Hohmann Retractors

HOHMANN RETRACTORS

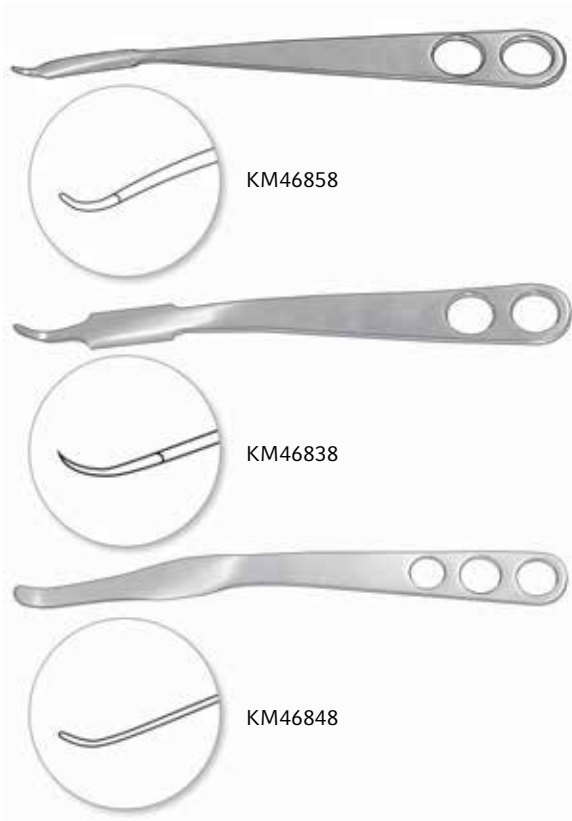

CATALOG #	DESCRIPTION
KM46858	8 mm wide blade, 8-1/2" (21.5 cm)
KM46836	10 mm wide blade, 9" (23 cm)
KM46838	18 mm wide blade, 9" (23 cm)
KM46848	22 mm wide blade, three holes, 11" (28 cm)

ORTHOPEDIC RETRACTORS

Hohmann Retractors

HOHMANN RETRACTORS

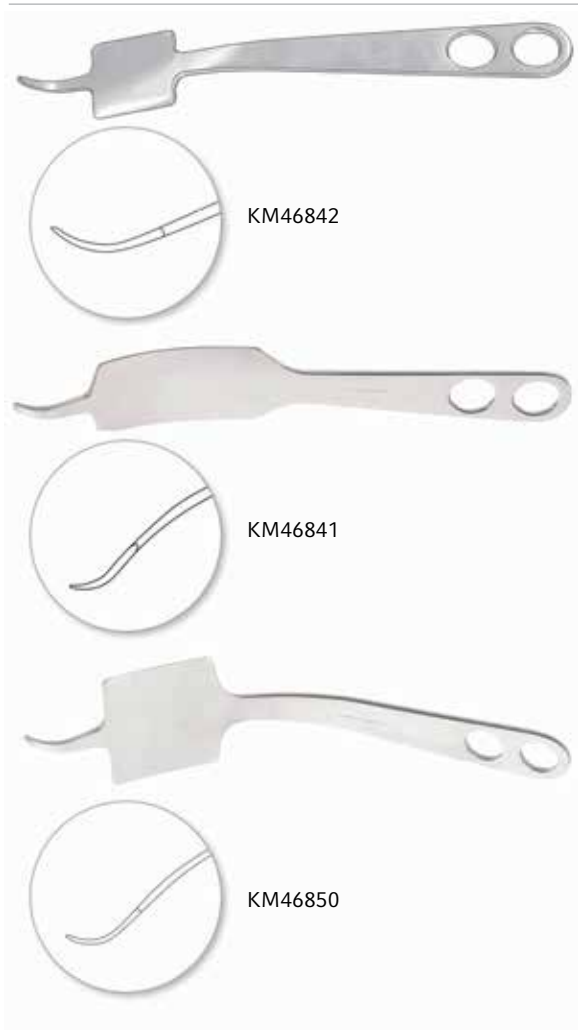

CATALOG #	DESCRIPTION
KM46842	43 mm wide blade, 9-1/2" (24 cm)
KM46841	43 mm wide blade, long 64 mm shank, 9" (23 cm)
KM46850	70 mm wide blade, 9-1/2" (24 cm)

HOHMANN RETRACTORS



For small fragments.

CATALOG #	DESCRIPTION
KM46826	Finger ring handle, broad tip, 16 mm wide blade, 4-3/4" (12 cm)



ORTHOPEDIC RETRACTORS

Hohmann Retractors

HOHMANN RETRACTORS



KM46827

CATALOG #	DESCRIPTION
KM46827	Broad tip, 15 mm wide blade, 6" (15 cm)

HOHMANN RETRACTORS

Useful in exposing acetabulum.

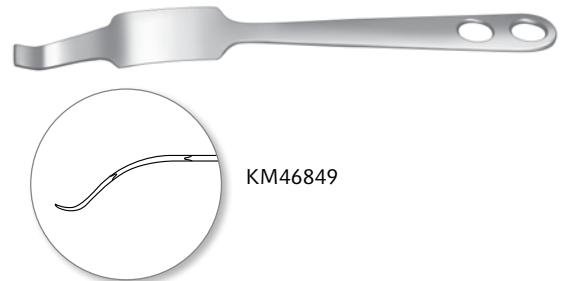

KM46849

CATALOG #	DESCRIPTION
KM46849	35 mm wide blade with wide tip, long 52 mm shank, 11-1/4" (28.5 cm)
KM46852	22 mm wide blade curved 120 degrees, 16" (40.5 cm)
KM46854	40 mm wide blade curved 90 degrees, 13" (33 cm)

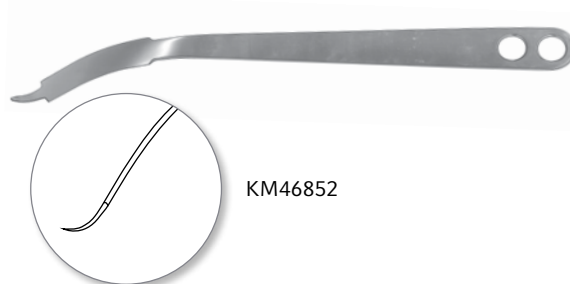

KM46852

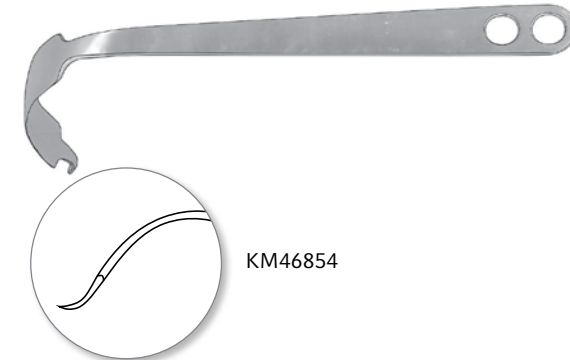

KM46854

VICKERS FINGER RETRACTOR

The new KMedic® Vickers Retractors are designed to provide excellent visibility during hand and wrist procedures. Each of the retractors is self-retaining and automatically expands the wound site.

Ideal for retracting wounds on either the front, back or sides of fingers or thumb.



VICKERS FINGER RETRACTOR
 KM52425
 2" x 3/4" x 1-1/4"
 (51 mm x 19 mm x 32 mm)
 2 x 2 blunt hooks
 Maximum opening: 19 mm



ORTHOPEDIC RETRACTORS

Self-Retaining Orthopedic Retractors

VICKERS LOW PROFILE SMALL WOUND RETRACTOR



KM52426

Useful for small wound retraction.

CATALOG #	DESCRIPTION
KM52426	10 mm deep x 12 mm high, curved, smooth blades, maximum opening 30 mm, center blade 10 mm x 16 mm, 2-1/2" x 3" (6.5 x 7.5 cm)

VICKERS LOW PROFILE HAND RETRACTOR



KM52427

With three blunt prongs to secure placement.

CATALOG #	DESCRIPTION
KM52427	3 x 3 prongs, 3-1/4" (8.5 cm)

VICKERS UNIVERSAL RETRACTOR



KM52428

With two blunt prongs to secure placement.

CATALOG #	DESCRIPTION
KM52428	2 x 2 blunt prongs, 8 mm deep x 17 mm high, maximum opening 30 mm, center blade 10 mm x 16 mm, 2-1/2" x 3" (64 x 75 mm)

ORTHOPEDIC RETRACTORS

Self-Retaining Orthopedic Retractors

COX METATARSAL SPREADER



- Specially designed thin serrated blades fit anatomically correct against the metatarsals.
- Precise design assures slip-proof hold on metatarsals.
- Affords excellent visibility for the surgeon.
- Designed by Dr. Kenneth Cox.
- A KMedic® Exclusive Product.

CATALOG #	DESCRIPTION
KM69990	11 mm wide blades, 4-1/2" (11.5 cm)

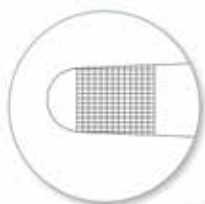

KM69990

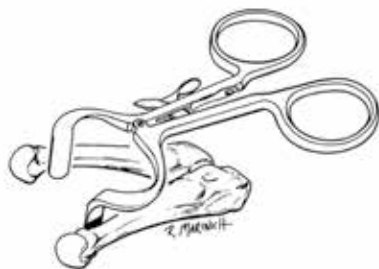

MALTZ-SEEBURGER RETRACTORS



KM58240

CATALOG #	DESCRIPTION
KM58240	4-1/2" (11.5 cm)
KM58242	5-1/2" (14 cm)

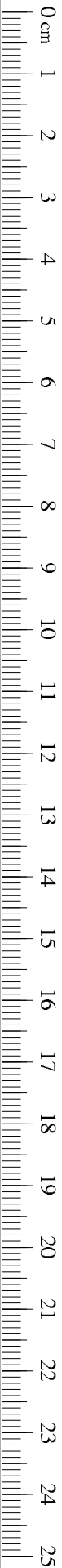

ORTHOPEDIC RETRACTORS

Self-Retaining Orthopedic Retractors

SNITMAN ENDAURAL RETRACTOR



KM55497

CATALOG #	DESCRIPTION
KM55497	3 x 3 sharp prongs

TISSUE RETRACTOR

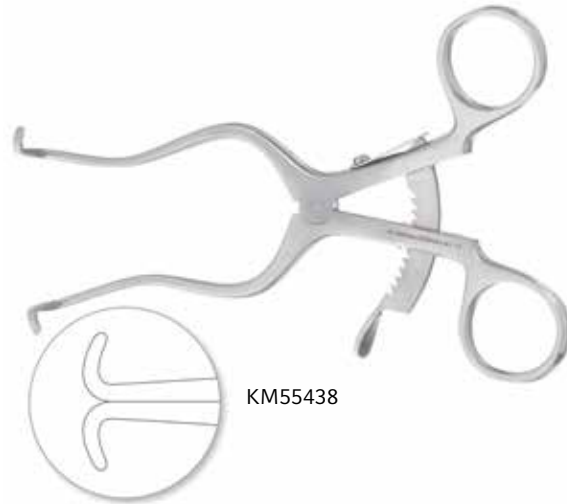

KM55438

CATALOG #	DESCRIPTION
KM55438	1 x 1 blunt prongs, 13 mm deep, 5-1/4" (13.5 cm)

ORTHOPEDIC RETRACTORS

Self-Retaining Orthopedic Retractors

KOLBEL SOFT TISSUE RETRACTOR



KM46922

CATALOG #	DESCRIPTION
KM46922	Angled, 2 x 2-pronged, 7" (18 cm)

SCALP CONTOUR RETRACTORS



KM52546

Useful in hand procedures because handle is non-obstructive.

CATALOG #	DESCRIPTION
KM52546	3 x 4 blunt prongs, 5-1/2" (14 cm)
KM52548	3 x 4 sharp prongs, 5-1/2" (14 cm)

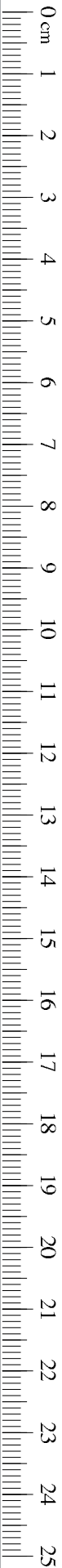

ORTHOPEDIC RETRACTORS

Self-Retaining Orthopedic Retractors

D'ERRICO-ADSON RETRACTOR



Angular prongs are heavier than those on a standard Adson.

CATALOG #	DESCRIPTION
KM55498	4 x 4 sharp prongs, 3/4" (2 cm) deep blade, 7-3/8" (19 cm)

ORTHOPEDIC RETRACTORS

Self-Retaining Orthopedic Retractors

MEYERDING LAMINECTOMY RETRACTORS



Sharp blades, 6-1/2" (16.5 cm).

CATALOG #	DESCRIPTION
KM55430	Blades 57 mm deep x 25 mm wide
KM55431	Blades 51 mm deep x 25 mm wide
KM55432	Blades 41 mm deep x 25 mm wide

MARKHAM-MEYERDING HEMILAMINECTOMY RETRACTORS



CATALOG #	DESCRIPTION
KM55440	Left sharp blade 60 mm deep x 25 mm wide, 7" (18 cm)
KM55441	Right sharp blade 60 mm deep x 25 mm wide, 7" (18 cm)

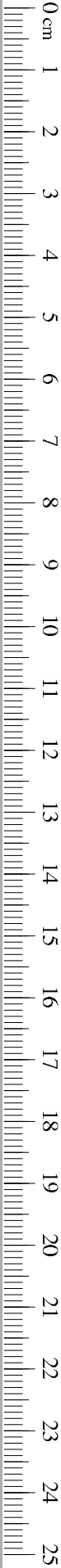

ORTHOPEDIC RETRACTORS

Self-Retaining Orthopedic Retractors

CERVICAL RETRACTOR SET

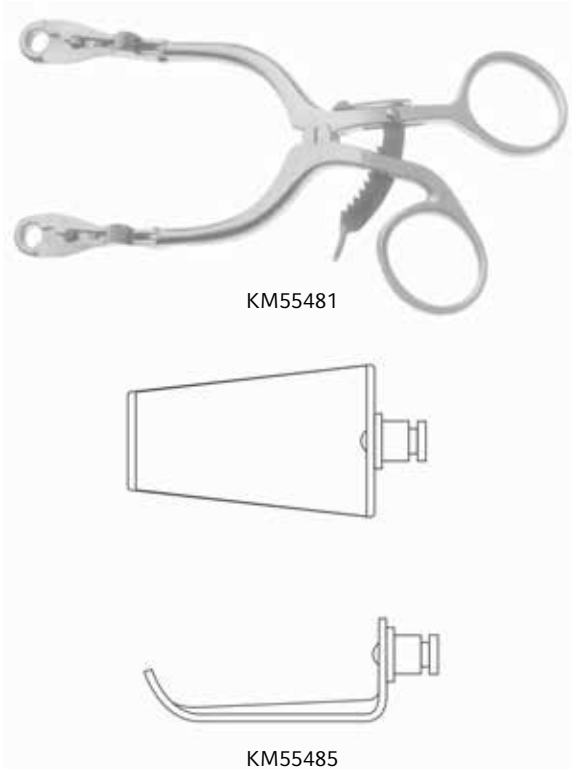

CATALOG #	DESCRIPTION
KM55481	Cervical retractor body, small, 6" (15 cm)
KM55482	25 mm deep blade, blunt
KM55483	30 mm deep blade, blunt
KM55484	35 mm deep blade, blunt
KM55485	40 mm deep blade, blunt
KM55486	45 mm deep blade, blunt
KM55487	50 mm deep blade, blunt
KM55488	55 mm deep blade, blunt

GELPI-SELETZ RETRACTOR



CATALOG #	DESCRIPTION
KM52765	Sharp points, deep blades, 6-1/4" (16 cm)

ORTHOPEDIC RETRACTORS

Self-Retaining Orthopedic Retractors

WILTSE-GELPI RETRACTOR

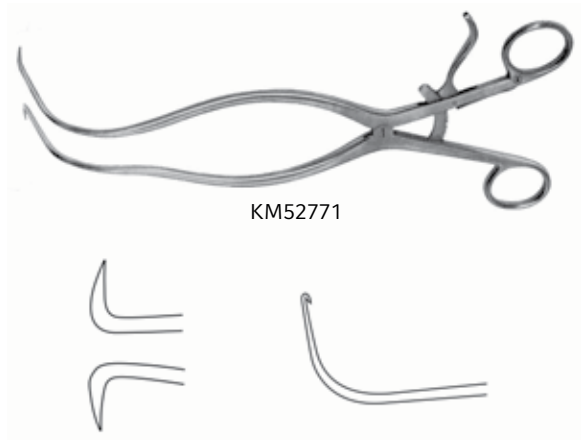

KM52771

CATALOG #	DESCRIPTION
KM52771	Deep blades, sharp points, 10-7/8" (27.5 cm)

ADSON RETRACTOR



KM52474

Hinged arm design.

CATALOG #	DESCRIPTION
KM52474	4 x 5 blunt prongs, 13" (33 cm)

BECKMAN RETRACTOR



KM52470

CATALOG #	DESCRIPTION
KM52470	4 x 4 sharp prongs, 27 mm, side blade 5/8" (1.5 cm) deep, 12-1/4" (31 cm)
KM52472	4 x 4 blunt prongs, 27 mm, side blade 5/8" (1.5 cm) deep, 12-1/4" (31 cm)



ORTHOPEDIC RETRACTORS

Self-Retaining Orthopedic Retractors

BECKMAN-EATON RETRACTOR



KM52476

CATALOG #	DESCRIPTION
KM52476	7 x 7 sharp prongs, 40 x 48 mm, 12-1/4" (31 cm)

BECKMAN-ADSON LAMINECTOMY RETRACTORS



KM52484

4 x 4 prongs, hinged blades 25 mm high, 12-1/4" (31 cm).

CATALOG #	DESCRIPTION
KM52484	Blunt, 25 mm deep
KM52488	Blunt, 44 mm deep, max. opening 6"
KM52486	Sharp, 44 mm deep
KM52490	Sharp, 25 mm deep, max. opening 5-11/16"

BECKMAN-WEITLANER RETRACTORS



KM52542

With hinged blades. KMedic® Pattern, satin finish, 9-1/2" (24 cm).

CATALOG #	DESCRIPTION
KM52542	3 x 4 sharp prongs, 22 mm
KM52544	3 x 4 blunt prongs, 22 mm

HORIZONTAL RETRACTOR

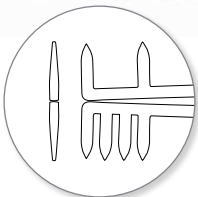

KM52602

Primarily used to retract detached trochanter from the stump of the femoral neck. Hinged arms allow handles to be angled away from surgical site to minimize interference.

CATALOG #	DESCRIPTION
KM52602	Hinged blades, 4 x 2 sharp prongs, 12-1/4" (31 cm)

ORTHOPEDIC RETRACTORS

Self-Retaining Orthopedic Retractors

VERTEBRA SPREADER (CLOWARD)



CATALOG #	DESCRIPTION
KM55490	#1 with ratchet, 3/4" (19 mm) spread, 5" (12.5 cm)

LUMBAR LAMINA SPREADERS



CATALOG #	DESCRIPTION
KM55495	#1, arm length, 3-1/2" (9 cm), 5-1/4" (13.5 cm)
KM55496	#2, arm length, 4-1/4" (11 cm), 5-1/4" (13.5 cm)

VERTEBRAL BODY DISTRACTORS



CATALOG #	DESCRIPTION
KM55410	Small
KM55412	Large, 11 mm wide x 3.8 mm deep jaws, 11-1/4" (28.5 cm)



ORTHOPEDIC RETRACTORS

Self-Retaining Orthopedic Retractors

INGE RETRACTOR



KM48217

Available with or without teeth.

CATALOG #	DESCRIPTION
KM48217	With teeth, 6-1/2" (16.5 cm)
KM48218	Without teeth, 6-1/2" (16.5 cm)
KM48230	With teeth, 10-3/8" (26.5 cm)

SAXENA BONE GRAFTING RETRACTOR



KM48220

- Ratchet is calibrated in millimeters to accurately assess how wide the lateral portion of the bone graft needs to be.
- Helpful in many types of procedures to accurately assess the amount of bone graft needed, such as for fusions and nonunions.
- Available exclusively from KMedic®.

CATALOG #	DESCRIPTION
KM48220	35 mm graduated ratchet, 6-1/2" (16.5 cm)

ORTHOPEDIC RETRACTORS

Self-Retaining Orthopedic Retractors

LAMINA SPREADERS

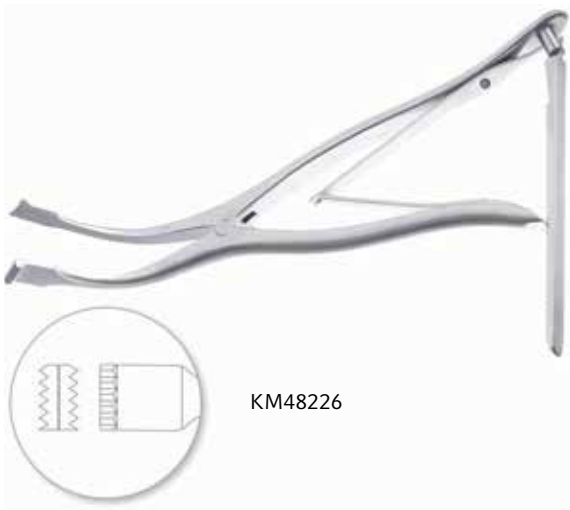

CATALOG #	DESCRIPTION
KM48228	Concave blades, 10-1/2" (26.5 cm)
KM48226	Flat blades, 10-3/4" (27.5 cm)

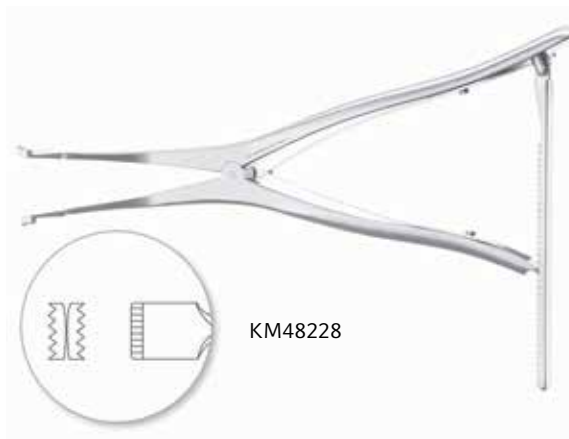



ORTHOPEDIC RETRACTORS

Self-Retaining Orthopedic Retractors

INITIAL INCISION (CHARNLEY) RETRACTOR



Used primarily for hip procedures.

CATALOG #	DESCRIPTION
KM52704	4 sharp prongs, stainless steel, maximum retraction width 9-3/4" (24.5 cm), prong depth 1-1/4" (32 mm), blade width 1" (25 mm), weight 3 lbs. Other blades are available
KM52704F	Frame only
KM52704S	Short blade, 1-1/4" deep x 1" wide (34 x 25 mm)
KM52705S	Short blade, 2" deep x 1" wide (51 x 25 mm)
KM52706S	Short blade, 2-1/4" deep x 1" wide (57 x 25 mm)
KM52707S	Short blade, 2-1/2" deep x 1" wide (64 x 25 mm)
KM52708S	Short blade, 3" deep x 1" wide (77 x 25 mm)
KM52709S	Short blade, 4" deep x 1" wide (102 x 25 mm)
KM52711S	Short blade, 5" deep x 1" wide (127 x 25 mm)
KM52704L	Long blade, 1-1/4" deep x 1" wide (34 x 25 mm)
KM52705L	Long blade, 2" deep x 1" wide (51 x 25 mm)
KM52706L	Long blade, 2-1/4" deep x 1" wide (57 x 25 mm)
KM52707L	Long blade, 2-1/2" deep x 1" wide (64 x 25 mm)
KM52708L	Long blade, 3" deep x 1" wide (77 x 25 mm)
KM52709L	Long blade, 4" deep x 1" wide (102 x 25 mm)
KM52711L	Long blade, 5" deep x 1" wide (127 x 25 mm)

SCOVILLE HEMILAMINECTOMY RETRACTOR BODY



CATALOG #	DESCRIPTION
KM55445	Spread 6-3/4" (17 cm), arm length 5-1/2" (14 cm)

ORTHOPEDIC RETRACTORS

Self-Retaining Orthopedic Retractors

HAVERFIELD-SCOVILLE HEMILAMINECTOMY RETRACTOR BODY



KM55446

CATALOG #	DESCRIPTION
KM55446	Body only, 8-3/8" (21.5 cm)

SCOVILLE-HAVERFIELD RETRACTOR BLADE



KM55455

CATALOG #	DESCRIPTION
KM55455	1" x 3-1/2"

MEYERDING BLADES



KM55459

CATALOG #	DESCRIPTION
KM55458	1" wide x 2 1/4" deep (25 x 57 mm)
KM55459	1" wide x 3" deep (25 x 76 mm)
KM55460	2" wide x 3-1/4" deep (51 x 83 mm)



ORTHOPEDIC RETRACTORS

Self-Retaining Orthopedic Retractors

SCOVILLE BLADES



KM55451

Solid.

CATALOG #	DESCRIPTION
KM55451	1" wide x 2-1/2" deep (25 mm x 64 mm)
KM55452	2" wide x 2-1/2" deep (51 mm x 64 mm)
KM55453	1-1/8" wide x 2-5/8" deep (29 mm x 67 mm)
KM55454	1" wide x 3-1/2" deep (25 mm x 89 mm)

HIBBS BLADES



KM55465

CATALOG #	DESCRIPTION
KM55461	1" wide x 2" deep (25 x 51 mm)
KM55463	1" wide x 2-1/2" deep (25 x 64 mm)
KM55465	1" wide x 3" deep (25 x 76 mm)
KM55468	1" wide x 4" deep (25 x 102 mm)
KM55464	1-1/2" wide x 2-1/2" deep (38 x 64 mm)
KM55466	1-1/2" wide x 3" deep (38 x 76 mm)
KM55462	2" wide x 2" deep (51 x 51 mm)
KM55467	2" wide x 3" deep (51 x 76 mm)
KM55469	2" wide x 4" deep (51 x 102 mm)

TAYLOR LAMINECTOMY BLADE



KM55473

CATALOG #	DESCRIPTION
KM55473	3 prongs, 1-1/2" wide x 1-3/4" deep (38 x 44 mm)

ORTHOPEDIC RETRACTORS

Self-Retaining Orthopedic Retractors

SCOVILLE BLADES



KM55456

4-prong.

CATALOG #	DESCRIPTION
KM55456	1-1/2" wide x 1-5/8" deep (38 x 41 mm)
KM55457	1-7/8" wide x 2-5/8" deep (48 x 67 mm)

TAYLOR LAMINECTOMY BLADES



KM55474

4-prong.

CATALOG #	DESCRIPTION
KM55474	2" wide x 1-7/8" deep (51 x 48 mm)
KM55476	2-1/4" wide x 3-1/8" deep (57 x 79 mm)
KM55475	2-1/2" wide x 2-1/2" deep (64 x 64 mm)

TAYLOR SPINAL BLADES



KM55472

CATALOG #	DESCRIPTION
KM55471	1-1/4" wide x 3" deep (32 x 76 mm)
KM55472	1-1/4" wide x 4" deep (32 x 102 mm)



ORTHOPEDIC RETRACTORS

Self-Retaining Orthopedic Retractors

SCOVILLE BLADES



KM55447

KM55449

Hook style.

CATALOG #	DESCRIPTION
KM55447	2" deep (51 mm)
KM55448	3" deep (76 mm)
KM55449	2" deep (51 mm) with cross bar
KM55450	2-3/4" deep (70 mm) with cross bar

FRAZIER LAMINECTOMY RETRACTOR

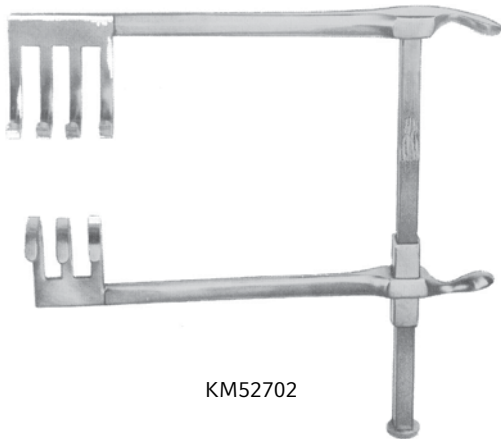

KM52702

CATALOG #	DESCRIPTION
KM52702	3 x 4 blunt prongs, spread 3-1/2" (9 cm), arm length 5" (12.5 cm)

ORTHOPEDIC RETRACTORS

Self-Retaining Orthopedic Retractors

CRUTCHFIELD TONGS



KM48249

CATALOG #	DESCRIPTION
KM48249	With two drills, 4-7/8" (12.5 cm)

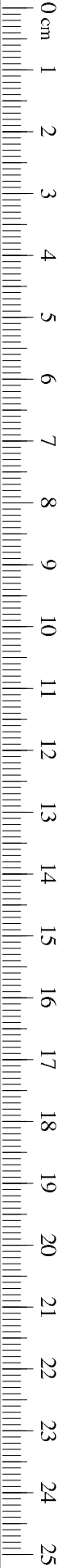

BONE HOLDING INSTRUMENTS

Bone Holding Forceps

LEWIN BONE HOLDING FORCEPS



KM47130

CATALOG #	DESCRIPTION
KM47130	Serrated, 7" (18 cm)

GLENOID PERFORATING FORCEPS

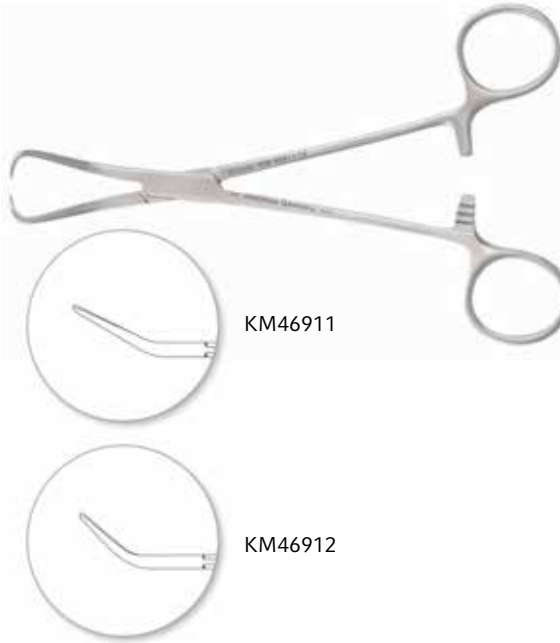

KM46911

KM46912

Pointed tips, 6-1/2" (17 cm).

CATALOG #	DESCRIPTION
KM46911	Slightly curved
KM46912	Strongly curved

BONE HOLDING INSTRUMENTS

Bone Holding Forceps

BONE HOLDING FORCEPS



KM45302

For positioning K-Wire up to 0.035" (0.9 mm).

CATALOG #	DESCRIPTION
KM45302	Curved, with 0.035" (0.9 mm) K-Wire guide, 6-3/4" (17 cm)

BONE HOLDING FORCEPS



KM45304

For positioning K-Wire up to 0.062" (1.6 mm).

CATALOG #	DESCRIPTION
KM45304	Curved, with 0.062" (1.6 mm) K-wire guide, 5-1/2" (14 cm)



BONE HOLDING INSTRUMENTS

Bone Holding Forceps

BONE HOLDING FORCEPS



Curved, with K-Wire guide, 5" (13 cm).

CATALOG #	DESCRIPTION
KM45305	0.035" (0.9 mm)
KM45306	0.045" (1.1 mm)
KM45307	0.062" (1.6 mm)

LOCKE PHALANGEAL FORCEPS



Very useful for removing the sesamoid bone.

CATALOG #	DESCRIPTION
KM69787	Serrated, 1 x 2 teeth, 6" (15 cm)

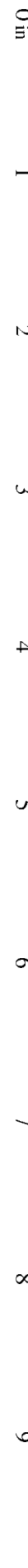

BONE HOLDING INSTRUMENTS

Bone Holding Forceps

BONE HOLDING FORCEPS

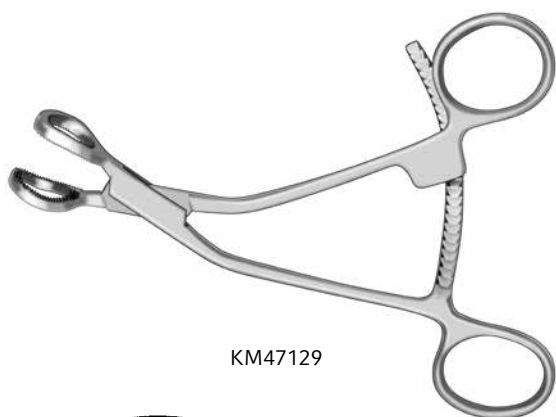

KM47129

Angled, with fenestration.

CATALOG #	DESCRIPTION
KM47129	Inside fenestration 22 x 14 mm, outside fenestration 30 x 20 mm, ratchet length 3" (76 mm), overall length 6" (15 cm)

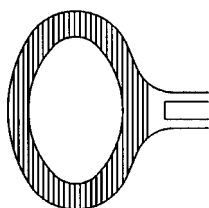
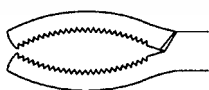

MALLEOLAR BONE HOLDING FORCEPS



KM47010

Grasping forceps for small bones.

CATALOG #	DESCRIPTION
KM47010	1 x 1 sharp points, 8-1/4" (21 cm)



BONE HOLDING INSTRUMENTS

Bone Holding Forceps

PARHAM-MARTIN BONE CLAMP



Fit thin end of band through slot in other end of band. Insert thin end into clamp. 8-1/4" (21 cm).

CATALOG #	DESCRIPTION
KM47172	Bands not included
KM47173	Single band only

PLATE AND BONE HOLDING FORCEPS



For positioning small bone plates.

CATALOG #	DESCRIPTION
KM47138	5-3/8" (14 cm)

BONE HOLDING INSTRUMENTS

Bone Holding Forceps

PLATE AND BONE HOLDING FORCEPS



KM47139

For positioning mini bone plates.

CATALOG #	DESCRIPTION
KM47139	1 pointed tip, 5-1/4" (14 cm)

SEMB BONE HOLDING FORCEPS

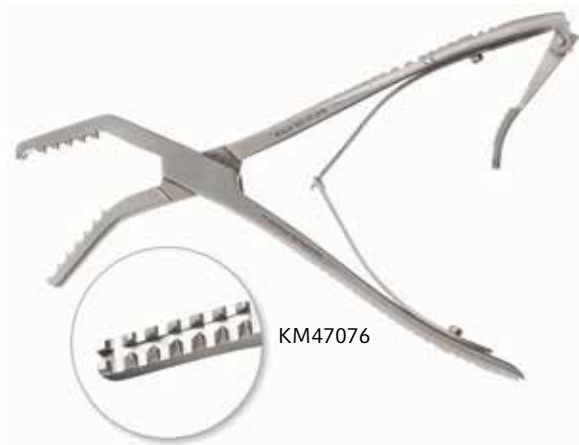

KM47076

Curved sideways. Deep teeth.

CATALOG #	DESCRIPTION
KM47074	4 x 5 teeth, without ratchet, 7-1/2" (19 cm)
KM47076	5 x 5 teeth, with ratchet, 8" (21 cm)

PATELLA BONE HOLDING FORCEPS

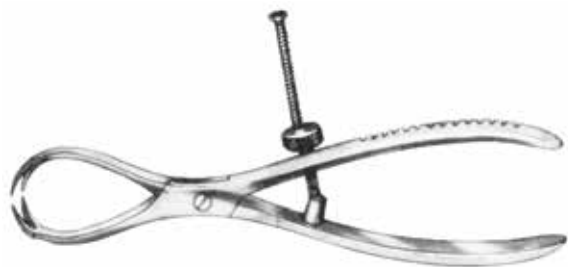

KM47012

CATALOG #	DESCRIPTION
KM47012	2 x 2 sharp teeth, with speed lock, 7" (18 cm)



BONE HOLDING INSTRUMENTS

Bone Holding Forceps

VAN BUREN SEQUESTRUM FORCEPS



KM47072

CATALOG #	DESCRIPTION
KM47072	Curved sideways, serrated, 9" (23 cm)

LANGENBECK BONE HOLDING FORCEPS



KM47200

CATALOG #	DESCRIPTION
KM47200	2 x 2 teeth, 8-1/4" (21 cm)

FARABEUF BONE HOLDING FORCEPS

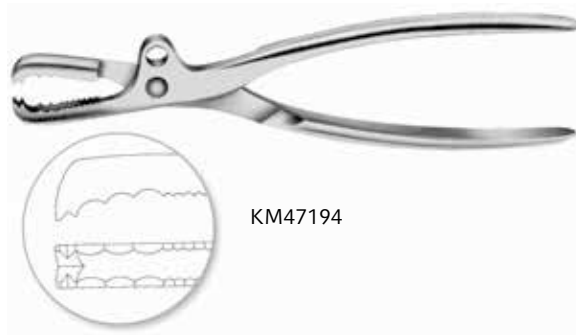

KM47194

Adjustable jaw.

CATALOG #	DESCRIPTION
KM47194	9" (23 cm)
KM47196	10" (25.5 cm)

BONE HOLDING INSTRUMENTS

Bone Holding Forceps

FARABEU-F-LAMBOTTE BONE HOLDING FORCEPS



KM47190

Adjustable jaw.

CATALOG #	DESCRIPTION
KM47190	7-1/2" (19 cm)
KM47192	10-1/2" (27 cm)

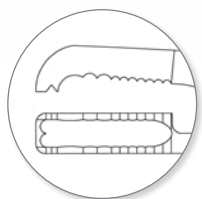

KM47190

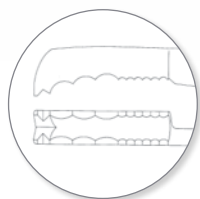

KM47192

FERGUSON BONE HOLDING FORCEPS



KM47198

CATALOG #	DESCRIPTION
KM47198	Deep teeth, 8-1/4" (21 cm)

FIBULA BONE HOLDING FORCEPS



KM47170

With angled tip and speed lock.

CATALOG #	DESCRIPTION
KM47170	8-1/2" (22 cm)



BONE HOLDING INSTRUMENTS

Bone Holding Forceps

KERN BONE HOLDING FORCEPS

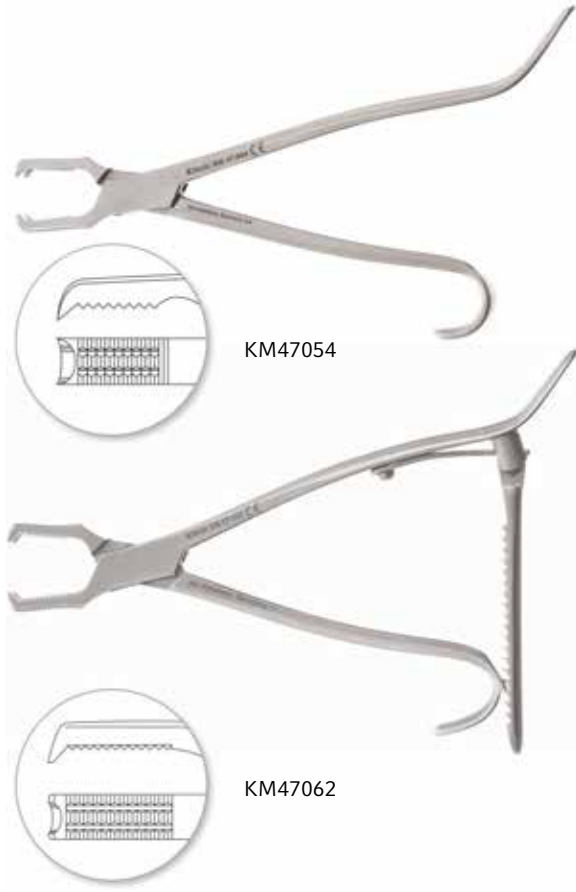

CATALOG #	DESCRIPTION
KM47054	Mini, 6-5/8" (17 cm), without ratchet
KM47056	9-1/2" (24 cm), without ratchet
KM47062	6-3/4" (17 cm), with ratchet
KM47064	9-1/2" (24 cm), with ratchet

LAMBOTTE BONE HOLDING FORCEPS



With swivel head, adjustable jaw.

CATALOG #	DESCRIPTION
KM47204	8-1/2" (22 cm)
KM47206	10-1/2" (27 cm)
KM47208	11-1/2" (29 cm)

BONE HOLDING INSTRUMENTS

Bone Holding Forceps

LANE BONE HOLDING FORCEPS



Particularly well suited for use during insertion of intermedullary nails.

CATALOG #	DESCRIPTION
KM47078	Light model, without ratchet, 13" (33 cm)
KM47080	Light model, with ratchet, 13" (33 cm)
KM47068	Standard model, without ratchet, 13" (33 cm)
KM47082	Standard model, with ratchet, 13" (33 cm)
KM47070	Without ratchet, 17" (43 cm)
KM47084	With ratchet, 17" (43 cm)

KM47082

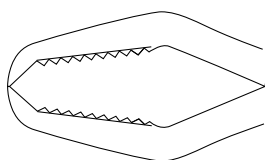

KM47078
KM47080

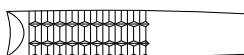
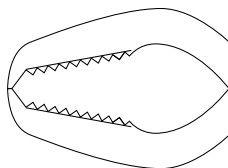

KM47068
KM47082

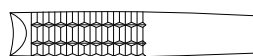
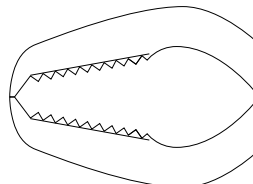

KM47070
KM47084



BONE HOLDING INSTRUMENTS

Bone Holding Forceps

ULRICH SELF-RETAINING BONE HOLDING FORCEPS



Straight, with speed lock.

CATALOG #	DESCRIPTION
KM47108	Mini, 7-1/4" (19 cm)
KM47110	8-1/2" (22 cm)
KM47112	9-7/8" (25 cm)
KM47114	10-1/4" (26 cm)



KM47108



KM47110

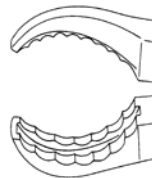

KM47112



KM47114

ULRICH SELF-RETAINING BONE HOLDING FORCEPS



Angled, with speed lock.

CATALOG #	DESCRIPTION
KM47109	7-1/4" (19 cm)
KM47116	11" (28 cm)

KM47116

BONE HOLDING INSTRUMENTS

Bone Holding Forceps

ULRICH SELF-RETAINING BONE HOLDING FORCEPS

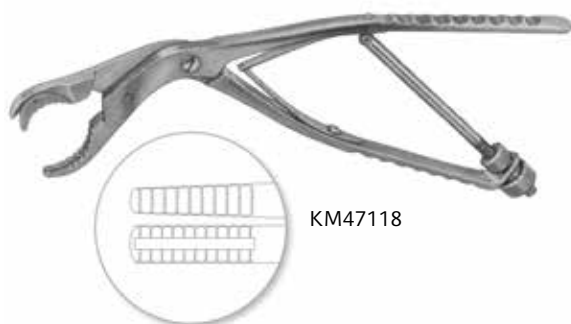

Angled, with speed lock and swivel jaw.

CATALOG #	DESCRIPTION
KM47118	11" (28 cm)

ANGLED BONE HOLDING FORCEPS



With swivel head, adjustable jaw.

CATALOG #	DESCRIPTION
KM47212	8-1/2" (22 cm)



BONE HOLDING INSTRUMENTS

Bone Holding Forceps

VEBRUGGE SELF-CENTERING BONE HOLDING FORCEPS



Self centering, with speed lock.

CATALOG #	DESCRIPTION
KM47090	5-3/4" (15 cm)
KM47092	7-1/4" (19 cm)
KM47094	9-1/4" (24 cm)
KM47096	10" (26 cm)
KM47098	11-1/4" (29 cm)

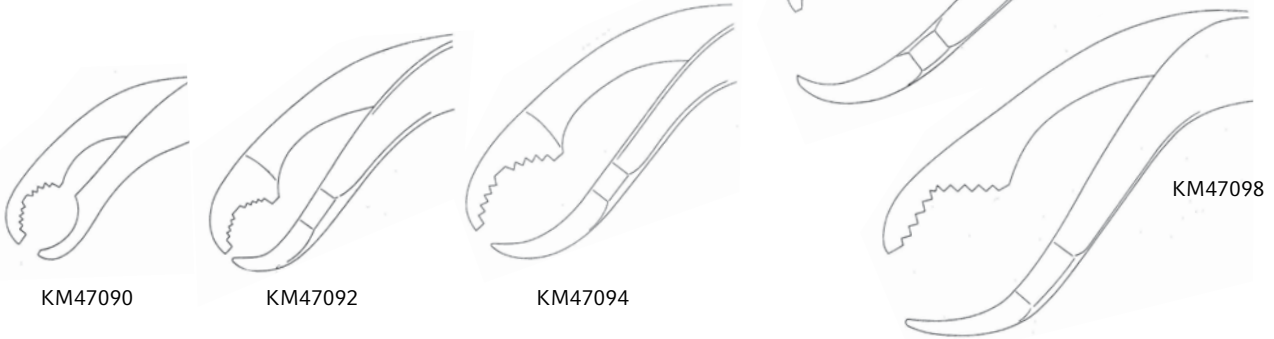

VEBRUGGE BONE HOLDING FORCEPS



With short ratchet.

CATALOG #	DESCRIPTION
KM47120	6-7/8" (18 cm)

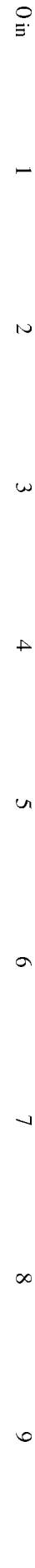

BONE HOLDING INSTRUMENTS

Bone Holding Forceps

VERBRUGGE BONE HOLDING FORCEPS



With long ratchet.

CATALOG #	DESCRIPTION
KM47122	10" (26 cm)
KM47124	10-1/2" (27 cm)
KM47126	11" (28 cm)

KM47122



Bone Reduction Forceps

STAGBEEBETLE BONE REDUCTION FORCEPS

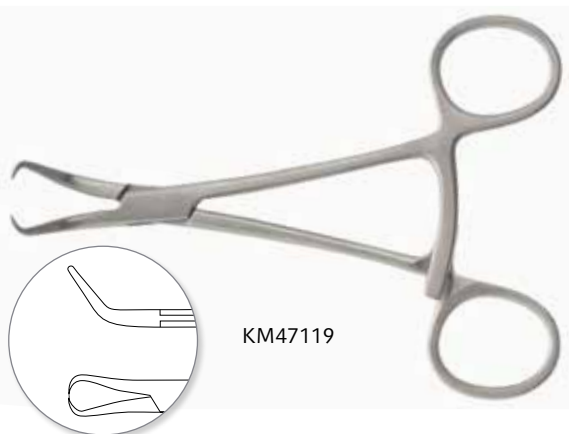

CATALOG #	DESCRIPTION
KM47119	Curved, pointed tips, 4-7/8" (13 cm)

KM47119



BONE HOLDING INSTRUMENTS

Bone Reduction Forceps

REILL BONE REDUCTION FORCEPS

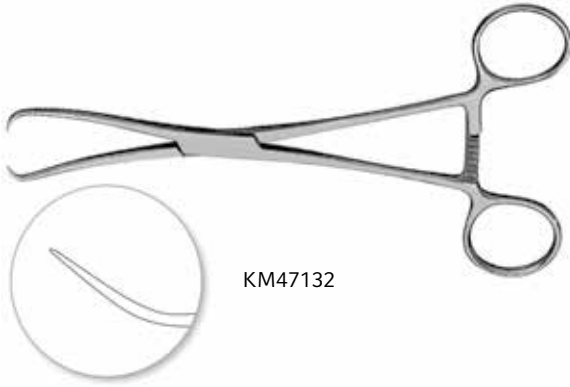

KM47132

CATALOG #	DESCRIPTION
KM47132	Curved, pointed tips, 6-3/4" (17 cm)

BONE REDUCTION FORCEPS

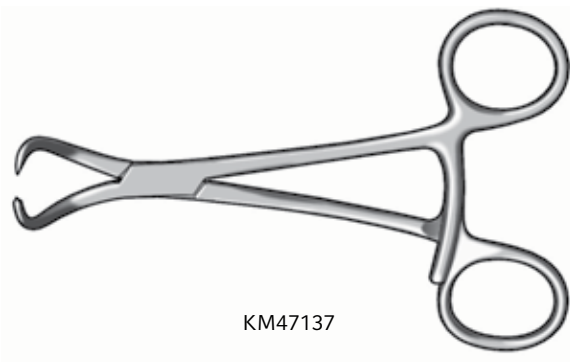

KM47137

Curved. One tip has a stepped point for a better hold on bone.

CATALOG #	DESCRIPTION
KM47137	5-1/4" (14 cm)
KM47136	6-3/4" (17 cm)

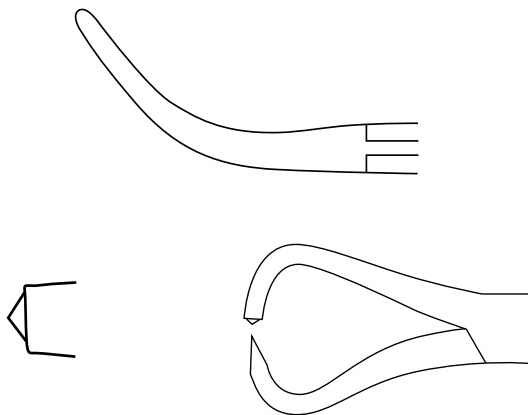

BONE HOLDING INSTRUMENTS

Bone Reduction Forceps

BONE REDUCTION FORCEPS

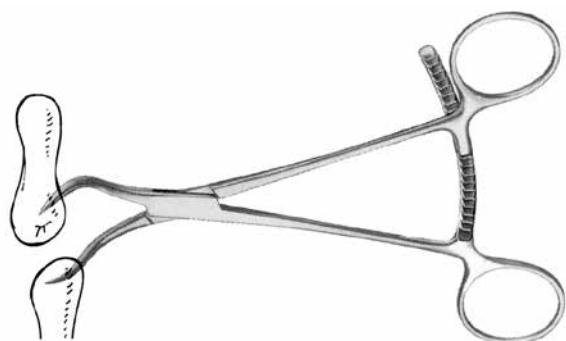

KM45300

CATALOG #	DESCRIPTION
KM45300	Curved, pointed tips, 5" (13 cm)



BONE REDUCTION FORCEPS



KM47134

With ratchet completely engaged, the jaw opening is 9 mm wide.

CATALOG #	DESCRIPTION
KM47134	Ratchet length: 2" (5 cm) Opens to 4" (10 cm) 8" (21 cm)

BONE HOLDING INSTRUMENTS

Bone Reduction Forceps

BONE REDUCTION FORCEPS

Curved and serrated with pointed tips.

CATALOG #	DESCRIPTION
KM47133	Narrow, 5-1/4" (14 cm)
KM47135	Broad, 5-1/2" (14 cm)



KM47133

KM47135

BONE HOLDING INSTRUMENTS

Bone Reduction Forceps

BONE REDUCTION FORCEPS



KM47105

Curved, with speed lock.

CATALOG #	DESCRIPTION
KM47105	7" (18 cm)
KM47107	9-5/8" (25 cm)

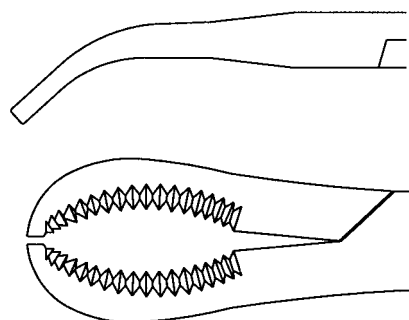

BONE REDUCTION FORCEPS



KM47128

CATALOG #	DESCRIPTION
KM47128	Small, curved, ratchet length 1-1/8" (28 mm), 5-1/2" (14 cm)

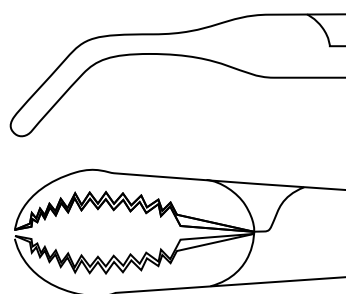



BONE HOLDING INSTRUMENTS

Bone Reduction Forceps

ANGLED PELVIC BONE REDUCTION FORCEPS

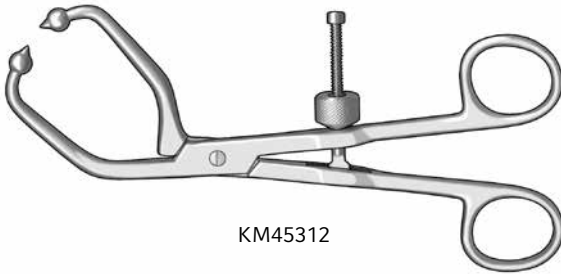

KM45312

Short tips.

CATALOG #	DESCRIPTION
KM45312	Short pointed-ball tips, 7-3/8" (19 cm)

ANGLED PELVIC BONE REDUCTION FORCEPS

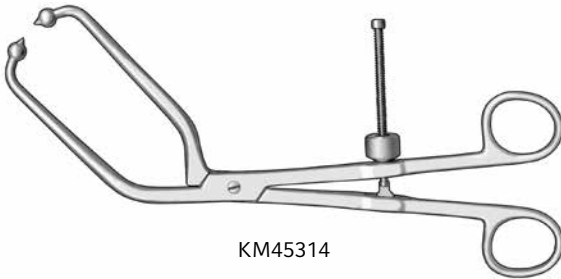

KM45314

Long tips.

CATALOG #	DESCRIPTION
KM45314	Long pointed-ball tips, 9-5/8" (25 cm)

ASYMETRIC PELVIC REDUCTION FORCEPS



KM45310

CATALOG #	DESCRIPTION
KM45310	Short pointed-ball tips, 16" (41 cm)



BONE HOLDING INSTRUMENTS

Bone Reduction Forceps

PELVIC REDUCTION FORCEPS



KM47100

CATALOG #	DESCRIPTION
KM47100	With screws, 13-1/2" (35 cm)

PELVIC REDUCTION FORCEPS

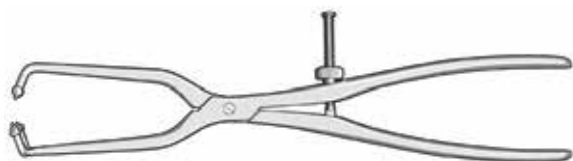

KM47101

CATALOG #	DESCRIPTION
KM47101	1 x 2 jaws, long pointed-ball tips, 16-1/8" (41 cm)



BONE HOLDING INSTRUMENTS

Bone Reduction Forceps

PELVIC REDUCTION FORCEPS

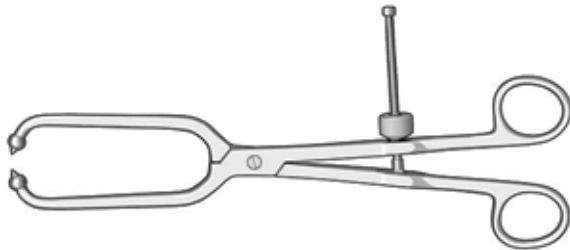

KM47102

CATALOG #	DESCRIPTION
KM47102	Angled tips, short pointed-ball tips, 10-1/8" (26 cm)

PELVIC REDUCTION FORCEPS

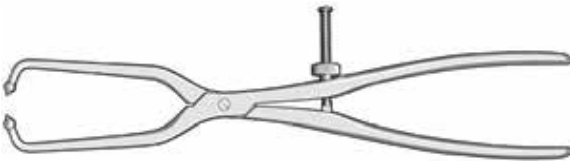

KM47103

CATALOG #	DESCRIPTION
KM47103	Pointed tips, long pointed-ball tips, 16-1/8" (41 cm)

BONE HOLDING INSTRUMENTS

Bone Clamps

BISHOP BONE CLAMP



CATALOG #	DESCRIPTION
KM47202	Adjustable jaw, 8-7/8" (22.5 cm)

KM47202

LAMBERT-LOWMAN BONE CLAMPS



2 x 2 jaws. Calibrated in inches to measure bone diameter.

CATALOG #	DESCRIPTION
KM47167	7-1/4" (18.5 cm)
KM47168	8" (20.5 cm)

KM47167



KM47167



KM47168

LOWMAN BONE CLAMPS



1 x 2 jaws. Calibrated in inches to measure bone diameter.

CATALOG #	DESCRIPTION
KM47140	4-3/4" (12 cm)
KM47154	5-5/8" (14.5 cm)
KM47156	6-3/4" (17 cm)



KM47154

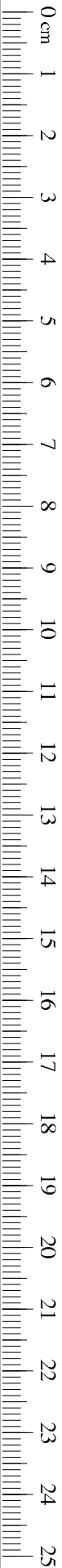

BONE HOLDING INSTRUMENTS

Bone Clamps

LOWMAN BONE CLAMPS



1 x 1 jaws. Calibrated in inches to measure bone diameter.

CATALOG #	DESCRIPTION
KM47160	4-3/4" (12 cm)
KM47164	5-3/4" (14.5 cm)
KM47166	6-7/8" (17.5 cm)

ROSENBLOOM SESAMOID CLAMP



CATALOG #	DESCRIPTION
KM69795	Slightly curved, 6-1/2" (16.5 cm)

BONE HOLDING INSTRUMENTS

Bone Clamps

VOGEN SESAMOID CLAMP

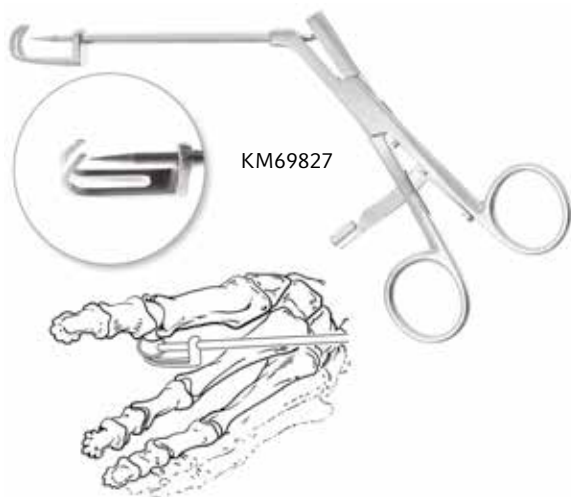

- Designed to grasp and hold a sesamoid while dissecting it free.
- The sesamoid is first exposed within the capsule, then the two-pronged tip is hooked beneath the sesamoid. The plunger is then seated in the bone to secure it for manipulation and dissection.

CATALOG #	DESCRIPTION
KM69827	4" (10 cm) shaft

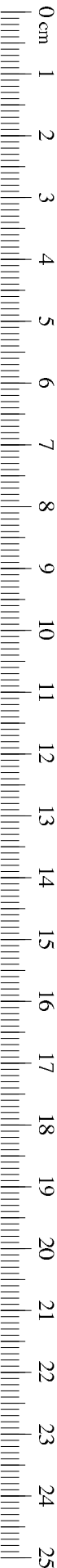

BONE HOOKS AND AWLS

Bone Hooks

SHARP HOOK



KM47880

To check fracture and remove ingrown tissue.

CATALOG #	DESCRIPTION
KM47880	6" (15 cm)

BONE HOOKS



KM48343

Sharp with grip handle, 9" (23 cm).

CATALOG #	DESCRIPTION
KM48342	Small, 6 mm high x 10 mm deep
KM48343	Medium, 11 mm high x 18 mm deep
KM48344	Large, 12 mm high x 21 mm deep

KM48344

VOLKMANN BONE HOOKS



KM48331

CATALOG #	DESCRIPTION
KM48331	Sharp, 15 mm high x 20 mm deep, 9" (23 cm)
KM48335	Sharp, 15 mm high x 20 mm deep, 9-3/4" (25 cm)
KM48334	Sharp, 19 mm high x 27 mm deep, 8-5/8" (22 cm)
KM48333	Blunt, 15 mm high x 20 mm deep, 9" (23 cm)

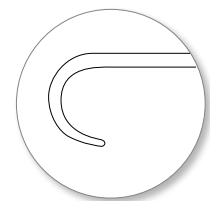
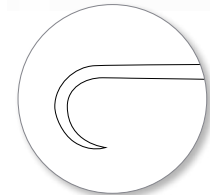

KM48333

BONE HOOKS AND AWLS

Bone Hooks

BONE HOOK



Large, for femurs. With T-handle.

CATALOG #	DESCRIPTION
KM48332	18 mm high x 21 mm deep, 7-7/8" (20 cm)

Awls

BONE AWL



CATALOG #	DESCRIPTION
KM48336	Square taper, 6-1/4" (16 cm)

KUNTSCHER DIAMOND POINTED AWL



CATALOG #	DESCRIPTION
KM48303	With handle, 11-5/8" (29.5 cm)

BONE HOOKS AND AWLS

Awls

PERTHES BONE AWL



KM48337

CATALOG #	DESCRIPTION
KM48337	8-1/4" (21 cm)

RUSH AWL AND REAMERS



KM48339

For penetrating cortex of bone. Used as grooved director for insertion of pins.

CATALOG #	DESCRIPTION
KM48338	0.1" (2.5 mm) diameter, working length 7-1/2" (19 cm), pointed, 9-7/8" (25 cm)
KM48339	0.1" (3 mm) diameter, working length 8-1/4" (21 cm), pointed, 10-5/8" (27 cm)
KM48340	0.2" (5 mm) diameter, working length 8-1/2" (21.5 cm), pointed, 10-7/8" (27.5 cm)
KM48341	0.25" (6 mm) diameter, working length 10-1/2" (26.5 cm), pointed, 12-3/4" (32.5 cm)

SHOULDER PENETRATING AWL

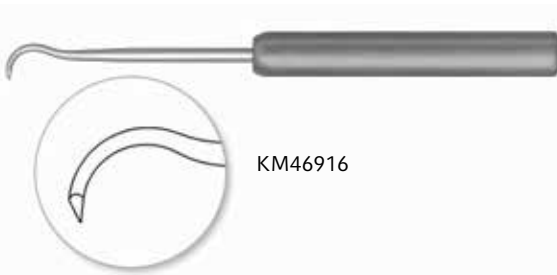

KM46916

Phenolic handle.

CATALOG #	DESCRIPTION
KM46916	9-1/4" (23.5 cm)

Autoclavable to 290°F (143°C)

BONE HOOKS AND AWLS

Awls

SHOULDER PERCUSSION AWLS

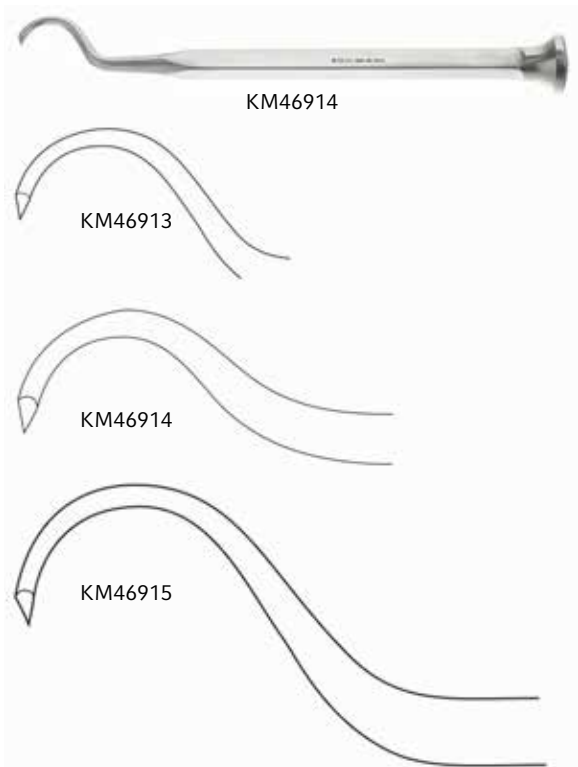

8-1/2" (21.5 cm).

CATALOG #	DESCRIPTION
KM46913	Small
KM46914	Medium
KM46915	Large



CARTILAGE AND TENDON INSTRUMENTS

Clamps and Forceps

MARTIN CARTILAGE CLAMPS

Deep teeth.

CATALOG #	DESCRIPTION
KM46802	7-3/8" (18.5 cm)
KM46814	8-1/8" (20.5 cm)



WALTON CARTILAGE CLAMP

CATALOG #	DESCRIPTION
KM46818	Slightly curved, 8-1/2" (21.5 cm)

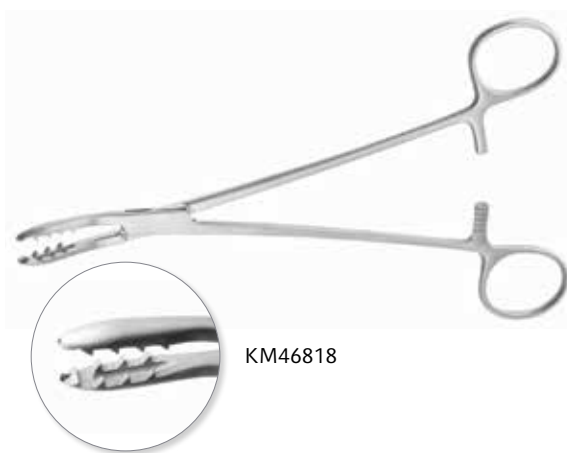

CARTILAGE AND TENDON INSTRUMENTS

Clamps and Forceps

DINGMAN FORCEPS



CATALOG #	DESCRIPTION
KM46804	Angular, 2 x 2 sharp teeth, serrated jaws, 7-1/2" (19 cm)

MENISCUS CLAMP

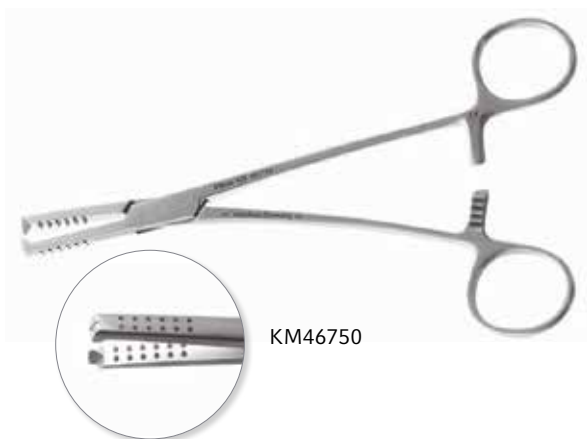

CATALOG #	DESCRIPTION
KM46750	Curved shaft, 7-1/8" (18 cm)

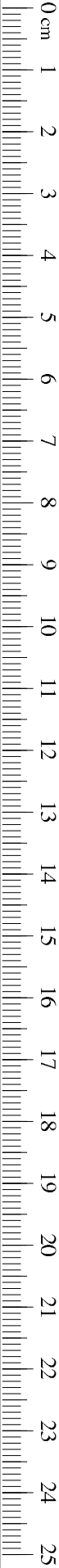

CARTILAGE AND TENDON INSTRUMENTS

Clamps and Forceps

MENISCUS CLAMPS



KM46744

Serrated, 5-3/8" (13.5 cm).

CATALOG #	DESCRIPTION
KM46744	Straight
KM46746	Angled 20 degrees



KM46746

PRESTON LIGAMENTUM FLAVUM FORCEPS (MENISCUS)



KM46748

For grasping tags of the meniscus.

CATALOG #	DESCRIPTION
KM46748	Serrated jaw with 1 x 2 tip, 7-1/4" (19 cm)

HOEN ALLIGATOR FORCEPS



KM55170

For retrieving tendons or foreign bodies.

CATALOG #	DESCRIPTION
KM55170	Serrated jaw with 1 x 2 tip, 5-7/8" (15 cm) shaft

CARTILAGE AND TENDON INSTRUMENTS

Clamps and Forceps

KLEINERT-KUTZ TENDON RETRIEVERS

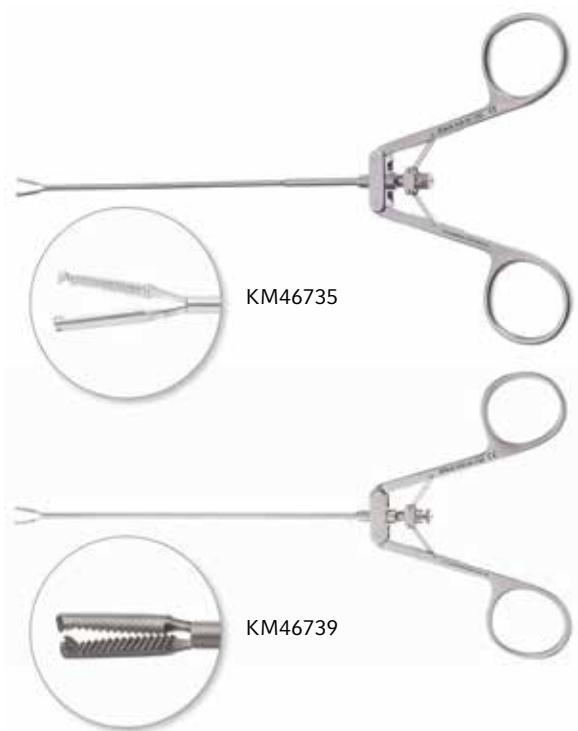

Serrated with sharp teeth, 8" (20.5 cm).

CATALOG #	DESCRIPTION
KM46735	Flexible shaft
KM46739	Rigid shaft

CARROLL TENDON RETRIEVER



CATALOG #	DESCRIPTION
065325	Curved shaft, 6" (15 cm)



CARTILAGE AND TENDON INSTRUMENTS

Clamps and Forceps

BRAND TENDON PULLING FORCEPS



Angular shaft.

CATALOG #	DESCRIPTION
KM46736	6" (15 cm)
KM46737	7-1/2" (19 cm)
KM46738	9-1/2" (24 cm)

Cartilage Knives

DOWNING CARTILAGE KNIFE



CATALOG #	DESCRIPTION
KM46772	Curved blade, concave edge. With guards, 10" (25.5 cm)

SMILLIE KNIVES

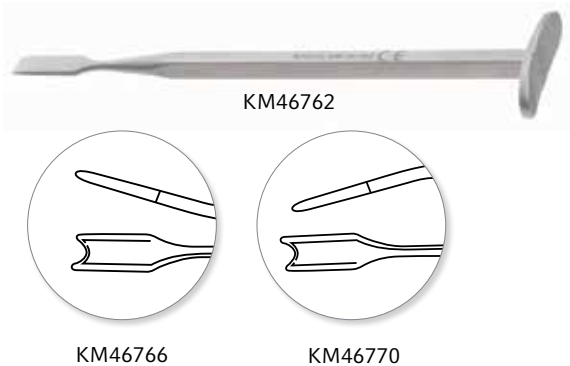

Also known as a meniscus knife. Useful for fasciotomies, 6-1/4" (16 cm).

CATALOG #	DESCRIPTION
KM46762	Straight, chisel type
KM46766	Curved left
KM46770	Curved right



CARTILAGE AND TENDON INSTRUMENTS

Cartilage Scissors

MARTIN CARTILAGE SCISSORS

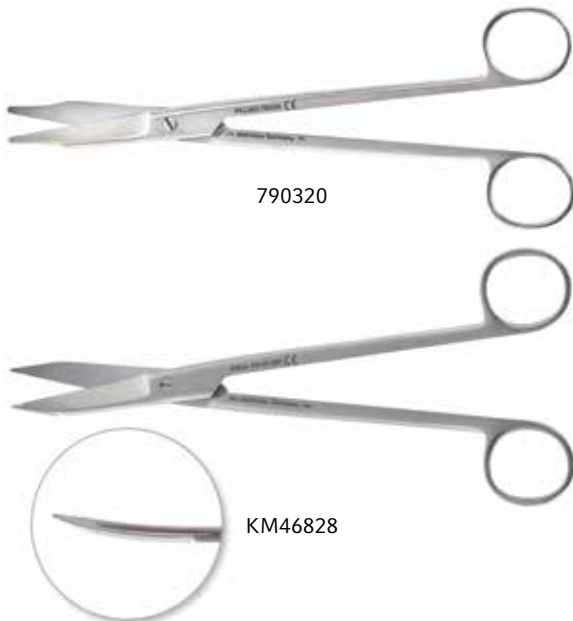

CATALOG #	DESCRIPTION
790320	Curved, two serrated blades, 8" (20.5 cm)
KM46828	Two serrated blades, 8" (20.5 cm)

MUELLER CAPSULE SCISSORS



CATALOG #	DESCRIPTION
KM46821	Angled, 9-1/2" (24 cm)



CARTILAGE AND TENDON INSTRUMENTS

Tendon Strippers

BUNNELL TENDON STRIPPERS



KM46732

6" (15 cm).

CATALOG #	DESCRIPTION
KM46730	3 mm
KM46731	4 mm
KM46732	5 mm
KM46733	6 mm
KM46734	7 mm



Note: gaps in circles are accurate.

DISSECTORS AND ELEVATORS

SMITHWICK HOOK AND DISSECTOR



KM49320

CATALOG #	DESCRIPTION
KM49320	Double-ended, 12" (30.5 cm)

WOODSON DURAL SEPARATOR AND PACKER



KM55302

CATALOG #	DESCRIPTION
KM55302	Double-ended with grooved blade, 3 mm blunt end, 7" (18 cm)

WOODSON ELEVATOR AND SPATULA



KM55300

CATALOG #	DESCRIPTION
KM55300	Double-end, semi-sharp, angled, both ends 3 mm, 10" (25.5 cm)

RHOTON BALL-TIPPED DISSECTORS



KM55346

7-1/2" (19 cm).

CATALOG #	DESCRIPTION
KM55344	Straight, 0.8 mm
KM55345	Angled 90 degrees, 3 mm
KM55346	Angled 90 degrees, 5 mm
KM55347	Angled 40 degrees, 4 mm
KM55348	Angled 40 degrees, 8 mm

RHOTON ELEVATORS



KM55333

7-1/2" (19 cm).

CATALOG #	DESCRIPTION
KM55333	Curved
KM55334	Angled



DISSECTORS AND ELEVATORS

RHOTON MICRO CURETTES



7-1/2" (19 cm).

CATALOG #	DESCRIPTION
KM55342	Straight, 1 x 2 mm
KM55343	Angled, 1 x 2 mm

RHOTON MICRO DISSECTION HOOKS



CATALOG #	DESCRIPTION
KM55338	Sharp, angled 90 degrees
KM55339	Blunt, angled 90 degrees
KM55340	Sharp, angled 45 degrees

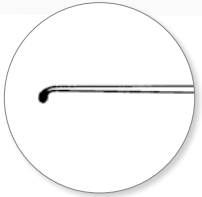

KM55338

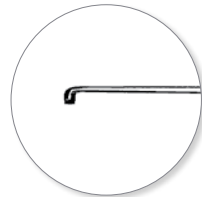

KM55339

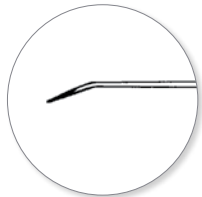

KM55340

RHOTON NEEDLE SHARP

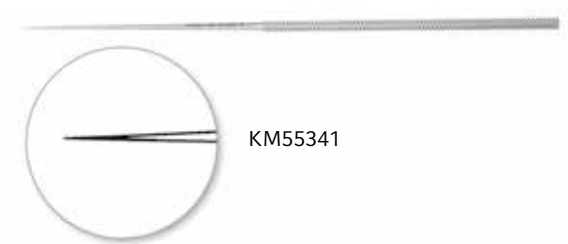

CATALOG #	DESCRIPTION
KM55341	Straight, sharp

KM55341

DISSECTORS AND ELEVATORS

RHOTON ROUND DISSECTORS



CATALOG #	DESCRIPTION
KM55330	Angled, 1 mm
KM55331	Angled, 2 mm
KM55332	Angled, 3 mm

RHOTON SPATULA DISSECTORS



CATALOG #	DESCRIPTION
KM55335	#6 Small, angled
KM55336	#7 Medium, angled
KM55337	#8 Large, angled



DISSECTORS AND ELEVATORS

Penfield Elevators/Dissectors

PENFIELD ELEVATORS



KM57624

CATALOG #	DESCRIPTION
KM57624	Style #1, double-ended, 7" (18 cm)
KM57626	Style #2, double-ended, 7-3/4" (19.5 cm)
KM57628	Style #3, double-ended, 7-3/4" (19.5 cm)
KM57630	Style #4, single-ended, 8" (20.5 cm)
KM57632	Style #5, double-ended, 7-1/2" (19 cm)



KM57626



KM57628

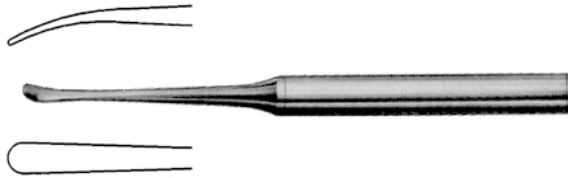

KM57630

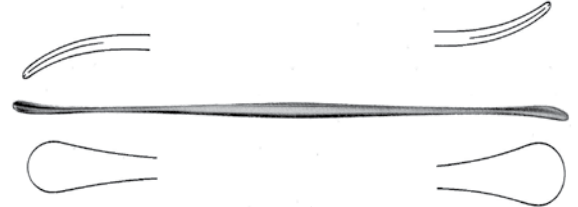

KM57632

DISSECTORS AND ELEVATORS

Double-Ended Elevators

ALLERDYCE ELEVATOR AND DISSECTOR



KM57616

CATALOG #	DESCRIPTION
KM57616	Double-ended, 8 mm semi-sharp end, 8 mm blunt end, 7-1/2" (19 cm)

FREER DOUBLE-END ELEVATOR



355194

Pilling® Pattern, satin finish.

CATALOG #	DESCRIPTION
355194	Double-ended, sharp and blunt, 7" (18 cm)

FREER DOUBLE-END ELEVATOR



KM57614

KMedic® Pattern, satin finish.

CATALOG #	DESCRIPTION
KM57614	Double-ended, 5 mm sharp and 5 mm blunt ends, 7-1/4" (18.5 cm)

KLEINERT-KUTZ ELEVATOR AND DISSECTOR



KM57615

CATALOG #	DESCRIPTION
KM57615	Double-ended, 2 mm and 3 mm sharp ends, 7-5/8" (19.5 cm)

KLEINERT-KUTZ ELEVATOR AND DISSECTOR



065300

CATALOG #	DESCRIPTION
065300	Double-ended, 2.4 mm and 3.2 mm ends, 7-3/4" (19.5 cm)



DISSECTORS AND ELEVATORS

Metatarsal Elevators

MCGLAMERY® METATARSAL ELEVATOR



CATALOG #	DESCRIPTION
KM69758	Sharp, curved, 9 mm, 6-1/2" (16.5 cm)

MCGLAMERY® METATARSAL ELEVATORS



For foot surgeons, the McGlamry® Elevator is indispensable. It's the perfect tool to deglove a metatarsal head, and it's invaluable in numerous other procedures. Sharp edge, 6-1/2" (16.5 cm).



CATALOG #	DESCRIPTION
KM69760	11 mm
KM69762	13 mm
KM69764	15 mm
KM69766	17 mm

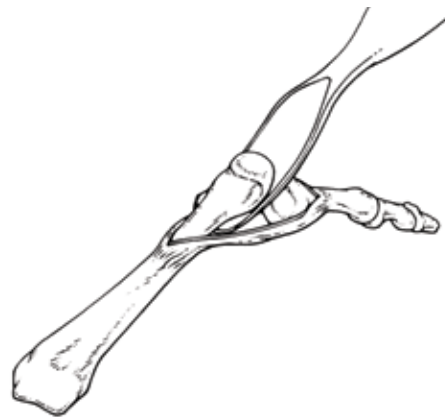

DISSECTORS AND ELEVATORS

Periosteal Elevators

COTTLE DOUBLE-ENDED ELEVATOR



Graduated in 10 mm increments.

CATALOG #	DESCRIPTION
053135	Blade A 5 mm Blade B 3 mm 8-7/8" (22.5 cm)

053135

MCKENTY ELEVATORS



Semi-sharp, 5-1/2" (14 cm).

KM57620

CATALOG #	DESCRIPTION
KM57620	4 mm
KM57622	5 mm



KM57620

KM57622



DISSECTORS AND ELEVATORS

Periosteal Elevators

KEY PERIOSTEAL ELEVATORS



KM46262

Sharp edge.

CATALOG #	DESCRIPTION
KM46258	1/4" (6.4 mm) wide, 7" (17.5 cm)
KM46260	3/8" (9.5 mm) wide, 7-1/2" (19 cm)
KM46262	1/2" (13 mm) wide, 7-1/2" (19 cm)
KM46264	3/4" (19 mm) wide, 7-7/8" (20 cm)
KM46266	1" (25.4 mm) wide, 8-3/8" (21.5 cm)

KEY PERIOSTEAL ELEVATOR



586250

CATALOG #	DESCRIPTION
586250	1/8" (3 mm) jaw, 7" (18 cm)

ADSON PERIOSTEAL ELEVATORS



KM49310

Also known as Joseph Elevator, 7 mm, 6-3/4" (17 cm).

CATALOG #	DESCRIPTION
KM49310	Sharp, straight
KM49311	Blunt, curved
KM49313	Semi-sharp, straight
KM49312	Semi-sharp, curved

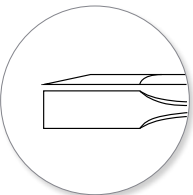

KM49310

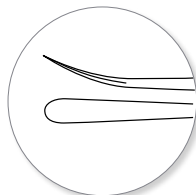

KM49311

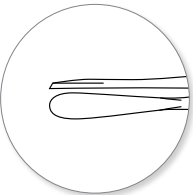

KM49313

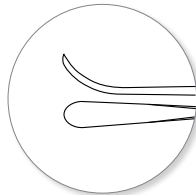

KM49312

DISSECTORS AND ELEVATORS

Periosteal Elevators

CUSHING LITTLE JOKER ELEVATOR



358350

CATALOG #	DESCRIPTION
358350	8 mm tip, 6-5/8" (16.5 cm)

CUSHING PERIOSTEAL ELEVATORS



7-1/2" (19 cm).

KM49322

CATALOG #	DESCRIPTION
KM49322	15 mm sharp, curved edge
KM49324	15 mm sharp, straight edge
KM49326	15 mm serrated, curved edge

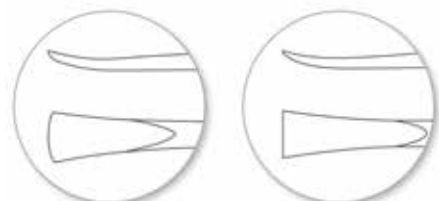

KM49322

KM49324



KM49326

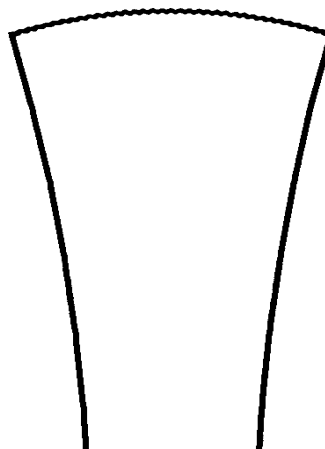

KM49326



DISSECTORS AND ELEVATORS

Periosteal Elevators

CREGO PERIOSTEAL ELEVATOR

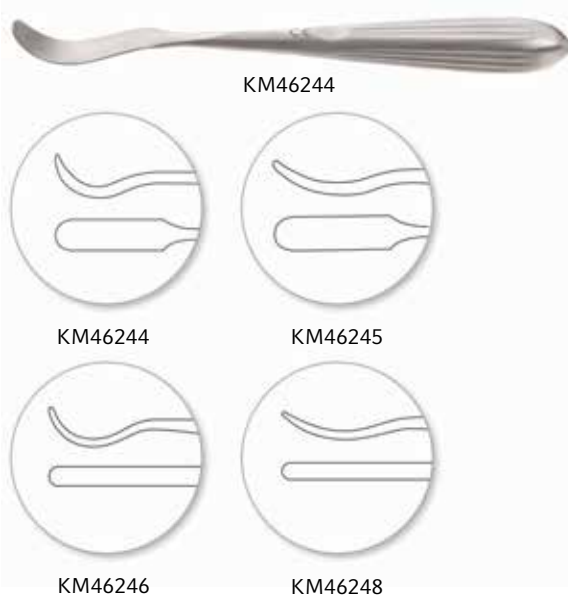

CATALOG #	DESCRIPTION
KM46244	Blunt, full curved, 15 mm, 7-3/8" (18.5 cm)
KM46245	Sharp, slightly curved, 15 mm, 7-3/4" (19.5 cm)
KM46246	Sharp, full curved, 7 mm, 7-3/4" (19.5 cm)
KM46248	Sharp, slightly curved, 7 mm, 8" (20.5 cm)

LANE PERIOSTEAL ELEVATOR

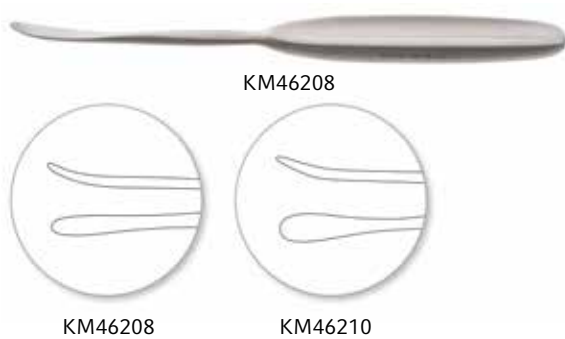

Blunt, 7-3/4" (19.5 cm).

CATALOG #	DESCRIPTION
KM46208	Narrow, 6 mm
KM46210	Broad, 10 mm

LANGENBECK PERIOSTEAL ELEVATOR



7-3/4" (19.5 cm)

CATALOG #	DESCRIPTION
KM46222	Narrow, 6 mm, blunt edge
KM46224	Broad, 17 mm, sharp edge

DISSECTORS AND ELEVATORS

Periosteal Elevators

SEDILLOT PERIOSTEAL ELEVATOR



KM58085

CATALOG #	DESCRIPTION
KM58085	16 mm, 7" (18 cm)

SAYRE PERIOSTEAL ELEVATOR



586240

CATALOG #	DESCRIPTION
586240	Double-ended, 4 mm straight blunt end, 8 mm curved sharp end, 6-5/8" (17 cm)

SAYRE PERIOSTEAL ELEVATOR



KM58076

CATALOG #	DESCRIPTION
KM58075	Double-ended, 5 mm sharp end, 9 mm sharp end, 6-1/2" (16.5 cm)
KM58076	Double-ended, 5 mm blunt end, 9 mm blunt end, 6-1/2" (16.5 cm)

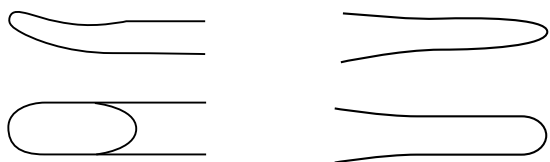



DISSECTORS AND ELEVATORS

Periosteal Elevators

PERIOSTEAL ELEVATOR



Phenolic handle, 7-1/2" (19 cm).

KM46211



KM46211



KM46206



KM46207



KM46212

CATALOG #	DESCRIPTION
KM46206	Sharp, curved blade, 3 mm straight edge
KM46207	Sharp, curved blade, 6 mm straight edge
KM46211	Sharp, straight blade, 6 mm straight edge
KM46212	Sharp, curved blade, 6 mm round edge

Autoclavable to 290°F (143°C)

PERIOSTEAL ELEVATOR



Phenolic handle.

KM46213



KM46213



KM46214

CATALOG #	DESCRIPTION
KM46213	Sharp, straight blade, 14 mm oval edge, 7-7/8" (20 cm)
KM46214	Sharp, curved blade, 14 mm oval edge, 7-5/8" (19.5 cm)

Autoclavable to 290°F (143°C)

DISSECTORS AND ELEVATORS

Periosteal Elevators

PERIOSTEAL ELEVATOR

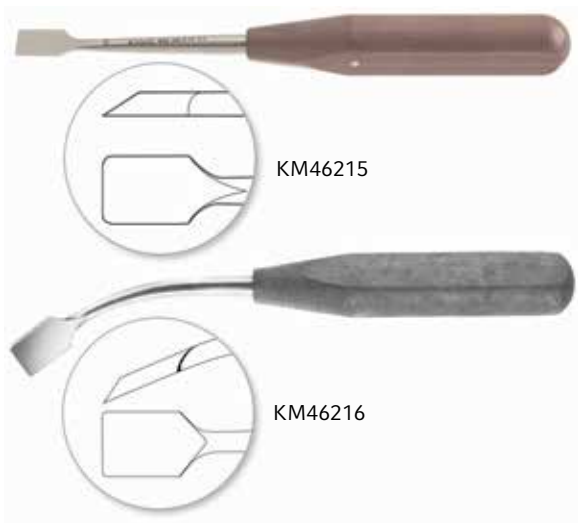

Phenolic handle.

CATALOG #	DESCRIPTION
KM46215	Sharp, straight blade, 13 mm straight edge, 7-1/4" (18.5 cm)
KM46216	Sharp, curved blade, 13 mm straight edge, 7-5/8" (19.5 cm)
KM46217	Sharp, straight blade, 20 mm round edge, 7-7/8" (20 cm)

Autoclavable to 290°F (143°C)



Cobb Elevators

COBB SPINAL ELEVATORS, HEX HANDLE



KM49342

All stainless steel and hexagonal handle.
Sharp, 9-1/2" (24 cm).

CATALOG #	TIP WIDTH
KM49340	1/2" (13 mm)
KM49342	3/4" (19 mm)
KM49344	1" (25.5 mm)
KM49346	1-1/4" (32 mm)

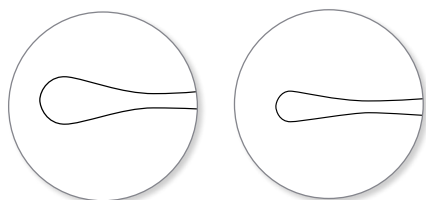

KM49342

KM49340

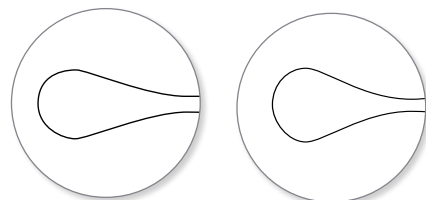

KM49344

KM49346



DISSECTORS AND ELEVATORS

Cobb Elevators

COBB SPINAL ELEVATORS, ALUMINUM HANDLE



KM46414

All stainless steel working end and anodized aluminum handle. Sharp, 11" (28 cm).

CATALOG #	TIP WIDTH
KM46413	3/8" (10 mm)
KM46414	1/2" (12 mm)
KM46416	3/4" (19 mm)
KM46418	1" (25 mm)
KM46420	1-1/4" (32 mm)

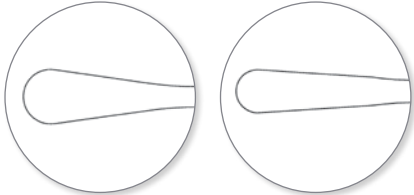

KM46414

KM46413

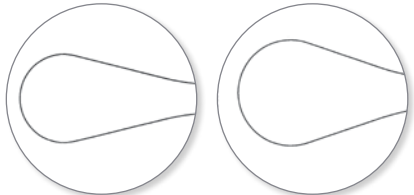

KM46416

KM46418

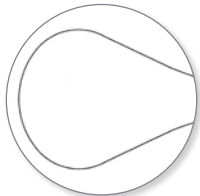

KM46420

DISSECTORS AND ELEVATORS

Cobb Elevators

COBB SPINAL ELEVATORS, STAINLESS STEEL HANDLE



All stainless steel working end and handle.
Sharp, 11" (28 cm).

KM46414S

CATALOG #	TIP WIDTH
KM46413S	3/8" (10 mm)
KM46414S	1/2" (12 mm)
KM46416S	3/4" (19 mm)
KM46418S	1" (25 mm)
KM46420S	1-1/4" (32 mm)

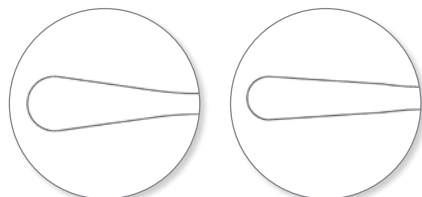

KM46414S

KM46413S

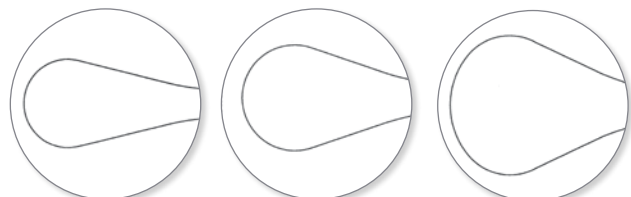

KM46416S

KM46418S

KM46420S

Endoscopic Elevators

ENDOSCOPIC COBB ELEVATORS



KM55614

Phenolic handle.

CATALOG #	TIP WIDTH	TIP LENGTH	SHAFT LENGTH	SHAFT DIAMETER	HANDLE LENGTH	OVERALL LENGTH
KM55620	1/4" (6 mm)	2.7"	9.3"	0.285" (7.2 mm)	5"	17" (43 cm)
KM55610	1/4" (6 mm)	3-1/2"	10"	0.45" (11.5 mm)	6-1/2"	20" (51 cm)
KM55612	3/8" (10 mm)	3-1/2"	10"	0.45" (11.5 mm)	6-1/2"	20" (51 cm)
KM55614	0.49" (12.5 mm)	3-1/2"	10"	0.45" (11.5 mm)	6-1/2"	20" (51 cm)

Phenolic handles autoclavable to 290°F (143°C)

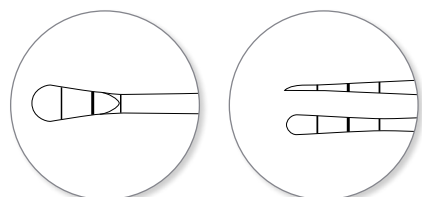

KM55614

KM55620

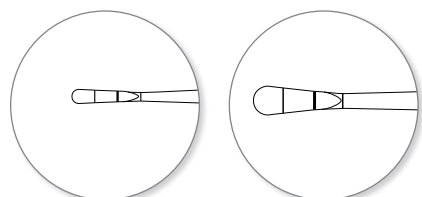

KM55610

KM55612



DISSECTORS AND ELEVATORS

Endoscopic Elevators

ENDOSCOPIC RIB ELEVATORS



Sharp, with phenolic handle.

KM55640

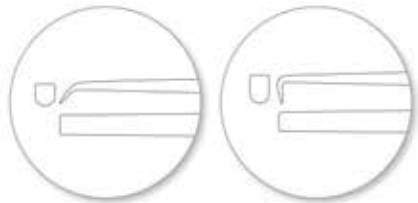

KM55640

KM55644

CATALOG #	TIP SHAPE	TIP WIDTH	TIP LENGTH	SHAFT LENGTH	SHAFT DIAMETER	HANDLE LENGTH	OVERALL LENGTH
KM55640	Angled 45 degrees	9 mm radius	4"	8"	0.45" (11.5 mm)	5"	17" (43 cm)
KM55644	Curved 90 degrees	9 mm radius	4"	8"	0.45" (11.5 mm)	5"	17" (43 cm)

Phenolic handles autoclavable to 290°F (143°C)

Specialty Elevators

DARRACH ELEVATORS



Useful in shoulder surgery. Blunt tips with serrations can be used to elevate or retract soft tissue and muscle from the operative site.

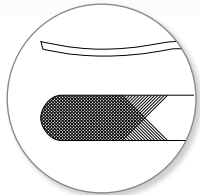

KM46903

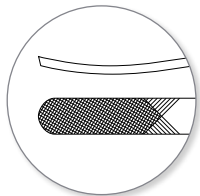

KM46902

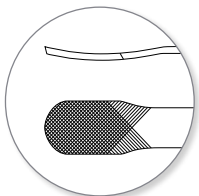

KM46904

CATALOG #	DESCRIPTION
KM46902	Small, 1/2" (12 mm) wide at tip, 10-1/4" (26 cm)
KM46903	Medium, 3/4" (19 mm) wide at tip, 10-1/4" (26 cm)
KM46904	Large, 1" (25 mm) wide at tip, 13-3/4" (35 cm)

DISSECTORS AND ELEVATORS

Specialty Elevators

HARRINGTON SPINAL ELEVATOR



KM55798

All stainless steel.

CATALOG #	DESCRIPTION
KM55798	Sharp, 3/4" (19 mm) wide tip, 12" (30.5 cm)

CHANDLER ELEVATORS



KM46252

Blunt, slightly curved.

CATALOG #	TIP WIDTH	LENGTH
KM46250	8 mm	7-1/8" (18 cm)
KM46252	12 mm	8" (20.5 cm)
KM46254	17 mm	9" (23 cm)
KM46256	19 mm	10" (25.5 cm)



KM46250

KM46252



KM46254

KM46256

SACHS NERVE ELEVATOR

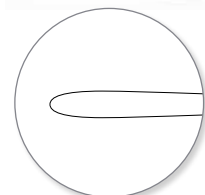

KM57618

CATALOG #	DESCRIPTION
KM57618	3 mm blunt, 7-1/2" (19 cm)

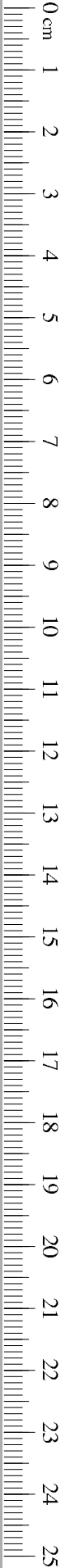

BONE FILES AND RASPS

Bone Files

BONE FILE #10



KM69542

CATALOG #	DESCRIPTION
KM69542	Double-ended, plain serrations, 5 mm width, 7-1/8" (18 cm)



BONE FILE #12



KM69543

CATALOG #	DESCRIPTION
KM69543	Double-ended, plain serrations, 7 and 5 mm width, 7-1/8" (18 cm)

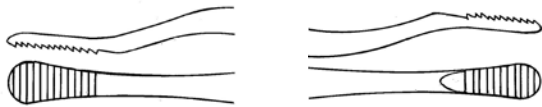

BONE FILE #12A



KM69544

CATALOG #	DESCRIPTION
KM69544	Double-ended, plain and cross serrations, 5 mm width, 7-1/8" (18 cm)

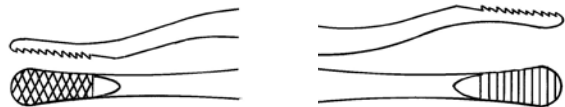

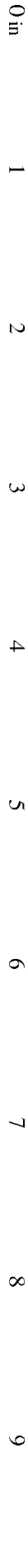

BONE FILES AND RASPS

Bone Files

BONE FILE #12CA



KM69545

CATALOG #	DESCRIPTION
KM69545	Double-ended, cross serrations, 5 and 7 mm width, 7-1/8" (18 cm)

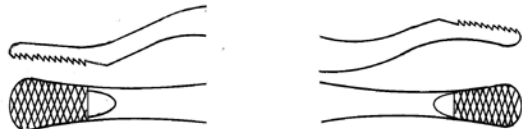

BONE FILE #33



KM69546

CATALOG #	DESCRIPTION
KM69546	Double-ended, plain serrations, 6 and 5 mm width, 7-1/8" (18 cm)



BONE FILE #45



KM69549

CATALOG #	DESCRIPTION
KM69549	Double-ended, plain serrations, 6 and 5 mm width, 7-1/4" (18.5 cm)





BONE FILES AND RASPS

Bone Files

BONE RASP #64

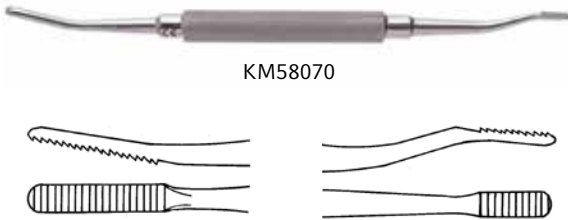

KM58070

CATALOG #	DESCRIPTION
KM58070	Double-ended, plain serrations, 3 and 4 mm width, 7-1/8" (18 cm)

BONE FILE #92A



KM69530

Single-ended, delicate, plain serrations.

CATALOG #	DESCRIPTION
KM69530	Angled downward

BONE FILE #92B



KM69534

Single-ended, delicate, plain serrations.

CATALOG #	DESCRIPTION
KM69534	Angled upward

NAIL RASP #93



KM69538

CATALOG #	DESCRIPTION
KM69538	Double-ended, 2 mm wide, angled, 6-3/4" (17 cm)

BONE FILES AND RASPS

Bone Files

BONE FILE



Single-ended, 2-sided, convex and flat blade 23 mm wide tapers to 6 mm.

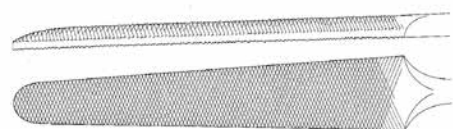

KM46705

CATALOG #	DESCRIPTION
KM46705	11" (28 cm)

BONE FILE



Single-ended, bayonet shank, half round blade.



KM46650

CATALOG #	DESCRIPTION
KM46650	Fine teeth, 15 mm wide, 9-1/2" (24 cm)

Bone Rasps

PUTTI BONE RASP



KM46652

Double-ended. One round blade, 10 mm wide, tapers to 4 mm, and one half round blade, 15 mm wide, tapers to 5 mm.

CATALOG #	DESCRIPTION
KM46652	12" (30.5 cm)

PUTTI BONE RASP



KM46654

Double-ended. Flat blades, 18 mm wide, taper to 4 mm. One blade end is curved up and one end is curved sideways.

CATALOG #	DESCRIPTION
KM46654	10-3/8" (26.5 cm)



BONE FILES AND RASPS

Bone Rasps

AUFRICHT RASPS



CATALOG #	DESCRIPTION
052162	Forward-cutting, 25 x 9 mm, 8" (20.5 cm)
KM58050	Forward-cutting, 8.5 mm wide, 8-1/4" (21 cm)
KM58052	Backward-cutting, 9 mm wide, 8-1/4" (21 cm)

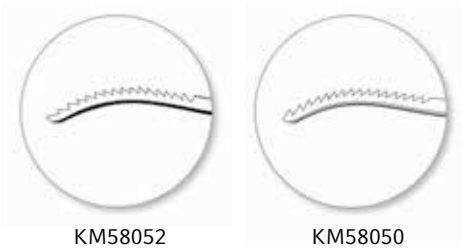

AUFRICHT-GLABELLA RASP



CATALOG #	DESCRIPTION
052165	Up and down-cutting, 9 x 30 mm, 7-1/2" (19 cm)

BONE RASP

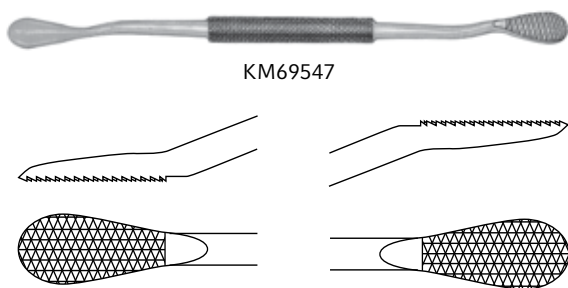

For rapid shaping of bone.

CATALOG #	DESCRIPTION
KM69547	Double-ended, fine and coarse cross serrations, 13 mm wide, 8-1/2" (21.5 cm)

BONE FILES AND RASPS

Bone Rasps

CONVERSE RASP



052180

CATALOG #	DESCRIPTION
052180	Double-ended, fine and coarse serrations, 7-1/8" (18 cm)

COTTLE RASP



052130

CATALOG #	DESCRIPTION
052130	Straight down-cutting blade, 9 mm width, 8-1/4" (21 cm)

FOMAN RASP



KM46655

Double-ended. Fine and coarse serrations. 4-sided, convex and flat blades.

CATALOG #	DESCRIPTION
KM46655	8-1/2" (21.5 cm)

JOSEPH RASP



441530

CATALOG #	DESCRIPTION
441530	Fine serrations, 6-1/8" (15.5 cm)



BONE FILES AND RASPS

Bone Rasps

KLEINERT-KUTZ BONE RASP



KM46653

Double-ended. Fine and coarse serrations. 4-sided, convex and flat blades.

CATALOG #	DESCRIPTION
KM46653	8-7/8" (22.5 cm)

KLEINERT-KUTZ RASP



441555

CATALOG #	DESCRIPTION
441555	4-sided tips, 7.5 mm wide, 8-5/8" (22 cm)

LEWIS RASPS



KM58072

Single-ended bayonet shank, plain serrations, 8 mm wide, 7-1/2" (19 cm).

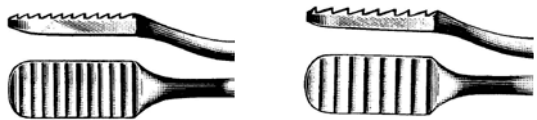

KM58072

KM58073

CATALOG #	DESCRIPTION
KM58072	Fine serrations
KM58073	Coarse serrations

BONE FILES AND RASPS

Bone Rasps

MALTZ RASP



052100

CATALOG #	DESCRIPTION
052100	Straight down-cutting blade, 6 mm width, 7-1/8" (18 cm)

MALTZ RASP IMPROVED



KM58062

CATALOG #	DESCRIPTION
KM58062	Double-ended, forward and backward-cutting, 8 mm wide, 8-1/4" (21 cm)

POLOKOFF BONE RASPS



KM69540

Double-ended, plain serrations.

CATALOG #	DESCRIPTION
KM69540	6 mm wide, 7-7/8" (20 cm)
KM69541	3 and 4 mm wide, 7-7/8" (20 cm)

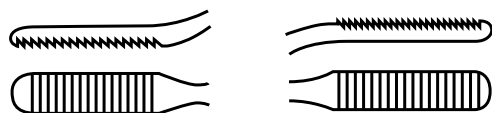

KM69540



KM69541

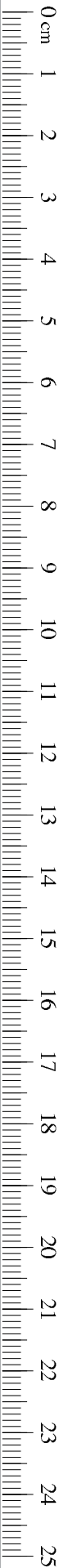

BONE FILES AND RASPS

Rib Rasps

ALEXANDER PERIOSTEAL RASP

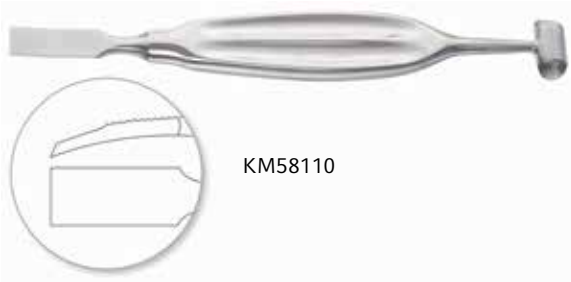

KM58110

CATALOG #	DESCRIPTION
KM58110	11 mm sharp, 8-1/8" (20.5 cm)

FARABEU PERIOSTEAL RASPS



KM58108

Single-ended, sharp, 5-7/8" (15 cm).

CATALOG #	DESCRIPTION
KM58106	Straight blade, 13 mm curved edge
KM58108	Curved blade, 13 mm straight edge

KIRMISSION PERIOSTEAL RASP



KM58112

CATALOG #	DESCRIPTION
KM58112	Sharp, 6-3/4" (17 cm)

CURETTES

Brun Currettes

BRUN (SPRATT) CURETTES

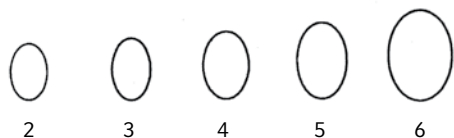
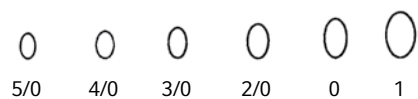

Oval cup, hollow handle.

CATALOG #	TIP SHAPE	SIZE	LENGTH
KM46511	Straight	#5/0	7" (18 cm)
KM46512	Straight	#4/0	7" (18 cm)
KM46513	Straight	#3/0	7" (18 cm)
KM46515	Straight	#2/0	7" (18 cm)
KM46517	Straight	#0	7" (18 cm)
KM46519	Straight	#1	7" (18 cm)
KM46521	Straight	#2	7" (18 cm)
KM46523	Straight	#3	7" (18 cm)
KM46525	Straight	#4	7" (18 cm)
KM46529	Straight	#5	7" (18 cm)
KM46531	Straight	#6	7" (18 cm)
KM46563	Straight	#3/0	9" (23 cm)
KM46564	Straight	#2/0	9" (23 cm)
KM46565	Straight	#0	9" (23 cm)
KM46566	Straight	#1	9" (23 cm)
KM46567	Straight	#2	9" (23 cm)
KM46568	Straight	#3	9" (23 cm)
KM46569	Straight	#4	9" (23 cm)
KM46570	Straight	#5	9" (23 cm)
KM46571	Straight	#6	9" (23 cm)
KM49110	Angled 45 degrees	#3/0	9" (23 cm)
KM49111	Angled 45 degrees	#2/0	9" (23 cm)
KM49112	Angled 45 degrees	#0	9" (23 cm)
KM49113	Angled 45 degrees	#1	9" (23 cm)
KM49114	Angled 45 degrees	#2	9" (23 cm)
KM49115	Angled 45 degrees	#3	9" (23 cm)
KM49116	Angled 45 degrees	#4	9" (23 cm)
KM49117	Angled 45 degrees	#5	9" (23 cm)
KM49118	Angled 45 degrees	#6	9" (23 cm)



CURETTES

Brun Currettes

BRUN (SPRATT) CURETTES

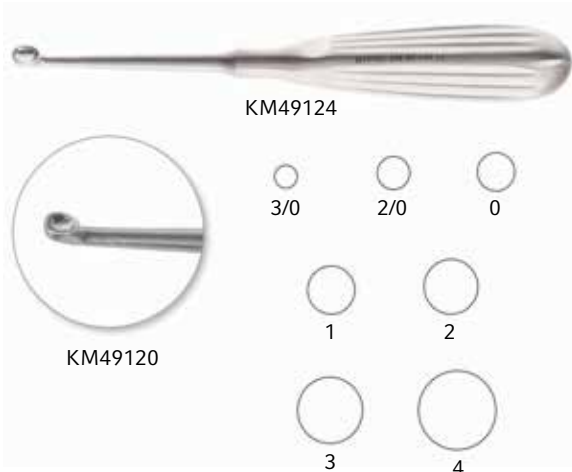

Round up, hollow handle.

CATALOG #	TIP SHAPE	SIZE	LENGTH
KM49120	Straight	#3/0	6-3/4" (17 cm)
KM49121	Straight	#2/0	6-3/4" (17 cm)
KM49122	Straight	#0	6-3/4" (17 cm)
KM49123	Straight	#1	6-3/4" (17 cm)
KM49124	Straight	#2	6-3/4" (17 cm)
KM49125	Straight	#3	6-3/4" (17 cm)
KM49126	Straight	#4	6-3/4" (17 cm)

CURETTES

Brun Currettes

BRUN CURETTES

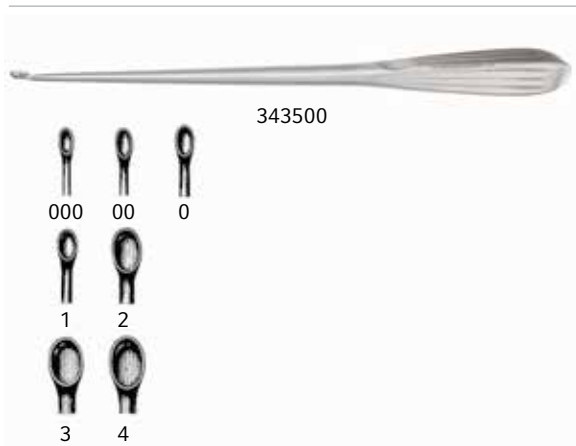

Pilling® Pattern, 8-7/8" (22.5 cm).

CATALOG #	DESCRIPTION
343500	Size 000
343501	Size 00
343502	Size 0
343503	Size 1
343504	Size 2
343505	Size 3
343506	Size 4

BRUN CURETTES

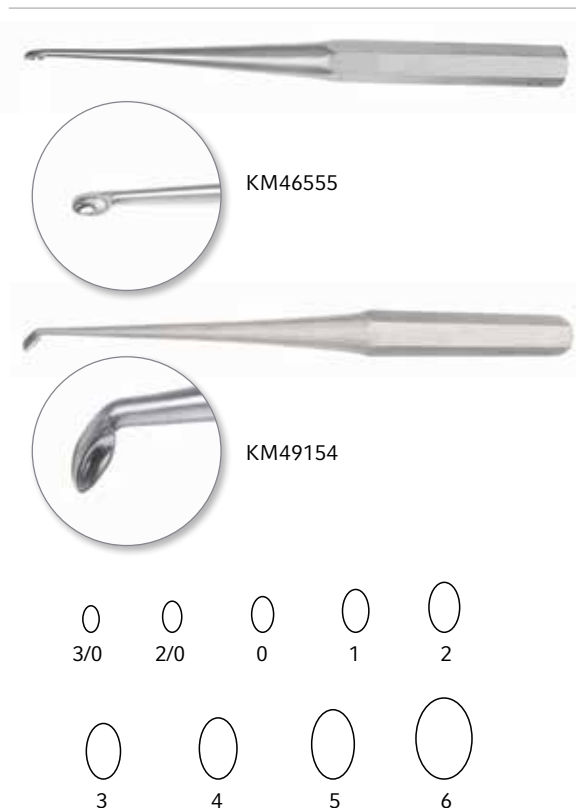

Solid hexagonal handle, 9" (23 cm).

CATALOG #	TIP SHAPE	SIZE
KM46551	Straight	#3/0
KM46552	Straight	#2/0
KM46553	Straight	#0
KM46554	Straight	#1
KM46555	Straight	#2
KM46556	Straight	#3
KM46557	Straight	#4
KM46558	Straight	#5
KM46559	Straight	#6

KM49150	Angled 45 degrees	#3/0
KM49151	Angled 45 degrees	#2/0
KM49152	Angled 45 degrees	#0
KM49153	Angled 45 degrees	#1
KM49154	Angled 45 degrees	#2
KM49155	Angled 45 degrees	#3
KM49156	Angled 45 degrees	#4
KM49157	Angled 45 degrees	#5
KM49158	Angled 45 degrees	#6



CURETTES

Cobb Currettes

COBB CURETTES, ALUMINUM HANDLE



All stainless steel working end and anodized aluminum, knurled handle, 11" (28 cm).

CATALOG #	TIP SHAPE	SIZE
KM46422	Straight	#3/0
KM46423	Straight	#2/0
KM46424	Straight	#0
KM46425	Straight	#1
KM46426	Straight	#2
KM46427	Straight	#3
KM46428	Straight	#4
KM46429	Straight	#5
KM46430	Straight	#6
KM46433	Angled	#3/0
KM46434	Angled	#2/0
KM46435	Angled	#0
KM46436	Angled	#1
KM46437	Angled	#2
KM46438	Angled	#3
KM46439	Angled	#4
KM46440	Angled	#5
KM46441	Angled	#6



CURETTES

Cobb Curettes

COBB CURETTES, STAINLESS STEEL HANDLE



All stainless steel working end and stainless steel, knurled handle, 11" (28 cm).



KM46427S



KM46438S

CATALOG #	TIP SHAPE	SIZE
KM46422S	Straight	#3/0
KM46423S	Straight	#2/0
KM46424S	Straight	#0
KM46425S	Straight	#1
KM46426S	Straight	#2
KM46427S	Straight	#3
KM46428S	Straight	#4
KM46429S	Straight	#5
KM46430S	Straight	#6
KM46433S	Angled	#3/0
KM46434S	Angled	#2/0
KM46435S	Angled	#0
KM46436S	Angled	#1
KM46437S	Angled	#2
KM46438S	Angled	#3
KM46439S	Angled	#4
KM46440S	Angled	#5
KM46441S	Angled	#6





CURETTES

Specialty Bone Curettes

EPSTEIN CURETTES



KM49584

Reverse angle, hollow handle, 8" (20.5 cm).

CATALOG #	DESCRIPTION
KM49580	#000
KM49582	#00
KM49584	#0

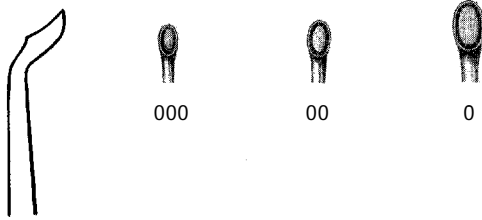

SCOVILLE CURETTES



KM49574

CATALOG #	DESCRIPTION
KM49574	Straight, 10" (25.5 cm)
KM49576	Down angle, 10" (25.5 cm)
KM49578	Up angle, 10" (25.5 cm)

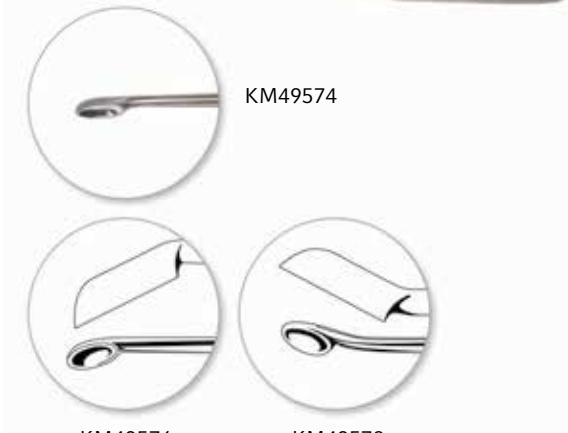

KM49576

KM49578

CURETTES

Specialty Bone Currettes

HATFIELD BONE CURETTES



Stainless steel with satin finish. Oval shaped tips, overall length 9" (23 cm). Complete set of nine currettes.

CATALOG #	SIZE	TIP WIDTH	TIP LENGTH
584160	000	2.5 mm	4.0 mm
	00	2.8 mm	4.6 mm
	0	3.3 mm	5.0 mm
	1	3.8 mm	6.0 mm
	2	4.8 mm	7.6 mm
	3	5.8 mm	9.2 mm
	4	7.2 mm	11.6 mm
	5	8.7 mm	12.8 mm
	6	10.5 mm	15.5 mm

JANSEN CURETTE



CATALOG #	DESCRIPTION
KM29632	Double-ended, oval cups, 6" (15 cm)



CURETTES

Specialty Bone Curettes

MARTINI BONE CURETTE



KM29620

CATALOG #	DESCRIPTION
KM29620	Double-ended, 4 mm and 5 mm round cups, 5-1/2" (14 cm)

WILLIGER BONE CURETTE

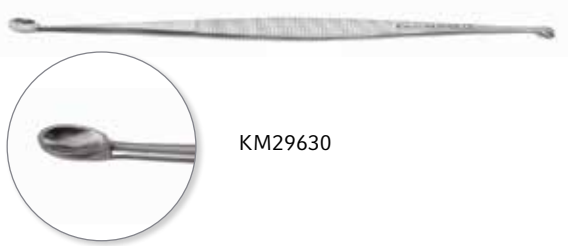

KM29630

CATALOG #	DESCRIPTION
KM29630	Double-ended, 3 mm and 4 mm oval cups, 5-1/2" (14 cm)

VOLKMANN CURETTES



KM49202

Double-ended, oval cups.

CATALOG #	DESCRIPTION
KM49200	Double-ended, straight, 5" (12.5 cm)
KM49202	Double-ended, straight, 5 1/2" (14 cm)
KM46550	Double-ended, oval cups, 6 1/2" (16.5 cm)
KM49204	Double-ended, straight, 8" (20.5 cm)

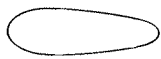

KM49200



KM46550

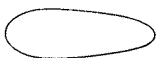

KM49202



KM49204



CURETTES

Specialty Bone Curettes

VOLKMANN CURETTES

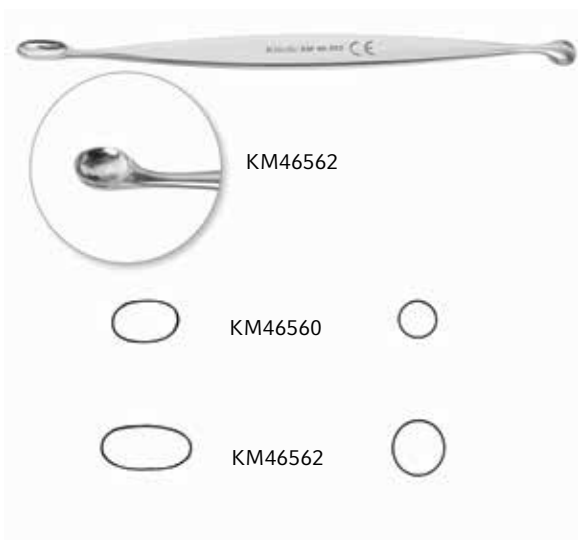

Double-ended, oval and round cups.

CATALOG #	DESCRIPTION
KM46560	5" (12.5 cm)
KM46561	8" (20.5 cm)
KM46562	6-1/2" (16.5 cm)

CONE RING CURETTES



Knurled handle and fenestrated cup, 9" (23 cm).

CATALOG #	TIP SHAPE	SIZE	TIP
KM49450	Straight	#1	8 mm diameter
KM49452	Straight	#2	6 mm diameter
KM49454	Straight	#3	3 mm diameter
KM49456	Angled 35 degrees	#1	8 mm diameter
KM49458	Angled 35 degrees	#2	6 mm diameter
KM49460	Angled 35 degrees	#3	3 mm diameter



CURETTES

Specialty Bone Curettes

RING CURETTES



KM55685

Hollow handle with fenestrated cup.

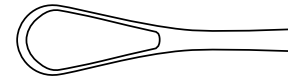

KM55681
KM55685

CATALOG #	DESCRIPTION
KM55680	Size 0, small, 10" (25.5 cm)
KM55684	Size 0, small, 11-1/2" (29 cm)
KM55681	Size 2, medium, 10" (25.5 cm)
KM55685	Size 2, medium, 11-1/2" (29 cm)
KM55682	Size 6, large, 10-1/4" (26 cm)
KM55686	Size 6, large, 12" (30.5 cm)

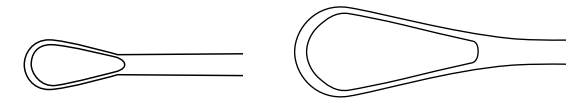

KM55680
KM55684

KM55682
KM55686

RAY PITUITARY CURETTES



KM49405

7-1/2" (19 cm).



KM49424

CATALOG #	TIP SHAPE	TIP
KM49403	Vertical angle 45 degrees	3 mm
KM49404	Vertical angle 45 degrees	4 mm
KM49405	Vertical angle 45 degrees	5 mm
KM49413	Vertical angle 90 degrees	3 mm
KM49414	Vertical angle 90 degrees	4 mm
KM49415	Vertical angle 90 degrees	5 mm
KM49423	Horizontal angle 45 degrees	3 mm
KM49424	Horizontal angle 45 degrees	4 mm
KM49425	Horizontal angle 45 degrees	5 mm
KM49433	Horizontal angle 90 degrees	3 mm
KM49434	Horizontal angle 90 degrees	4 mm
KM49435	Horizontal angle 90 degrees	5 mm



KM49403

KM49413

3 mm

4 mm



KM49423

KM49433

5 mm



CURETTES

Endoscopic Currettes

ENDO BRUN CURETTES

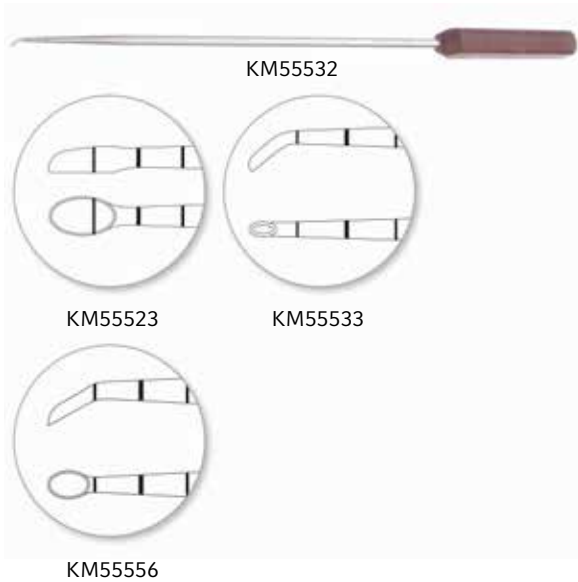

Endoscopic with phenolic handle.

CATALOG #	TIP SHAPE	TIP	TIP LENGTH	SHAFT LENGTH	SHAFT DIA.	HANDLE LENGTH	OVERALL LENGTH
KM55532	Angled 40°	2 x 4 mm cup	2.7"	9.3"	0.285"	5"	17" (43 cm)
KM55523	Straight	3 x 6 mm cup	2.7"	9.3"	0.285"	5"	17" (43 cm)
KM55533	Angled 40°	3 x 6 mm cup	2.7"	9.3"	0.285"	5"	17" (43 cm)
KM55543	Angled 40°	3 x 6 mm cup	3-1/2"	10"	0.45"	6-1/2"	20" (51 cm)
KM55556	Angled 30°	6 x 9 mm cup	3-1/2"	10"	0.45"	6-1/2"	20" (51 cm)



CURETTES

Endoscopic Curettes

ENDO CONE RING CURETTES

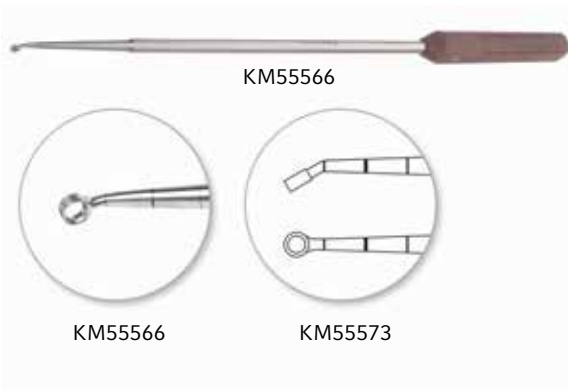

Endoscopic with phenolic handle.

CATALOG #	TIP SHAPE	TIP	TIP LENGTH	SHAFT LENGTH	SHAFT DIA.	HANDLE LENGTH	OVERALL LENGTH
KM55573	Angled 40°	3 mm	2.7"	9.3"	0.285"	5"	17" (43 cm)
KM55566	Angled 30°	6 mm	3-1/2"	10"	0.45"	6-1/2"	20" (51 cm)

ENDO EPSTEIN CURETTES

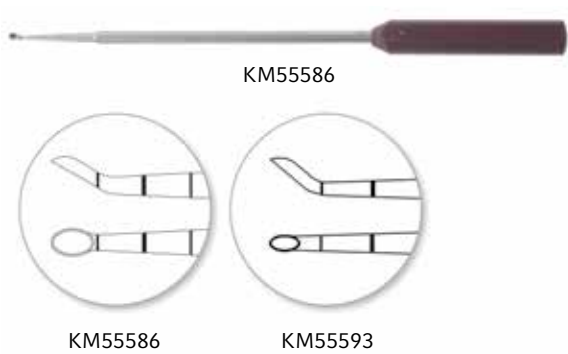

CATALOG #	TIP SHAPE	TIP	TIP LENGTH	SHAFT LENGTH	SHAFT DIA.	HANDLE LENGTH	OVERALL LENGTH
KM55593	Reverse-angled 40°	3 x 6 mm	2.7"	9.3"	0.285"	5"	17" (43 cm)
KM55586	Reverse-angled 30°	6 x 9 mm	3-1/2"	10"	0.45"	6-1/2"	20" (51 cm)

ENDO SCOVILLE CURETTE

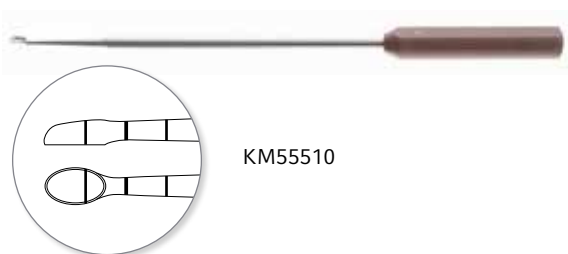

Endoscopic with phenolic handle.

CATALOG #	TIP SHAPE	TIP	TIP LENGTH	SHAFT LENGTH	SHAFT DIA.	HANDLE LENGTH	OVERALL LENGTH
KM55510	Straight	9 x 15 mm	3-1/2"	10"	0.45"	6-1/2"	20" (51 cm)

CURETTES

SmartTrack Curette Trays

BRUN SMARTRACK FOR 7" CURETTES



KM98160

Aluminum and stainless steel.

CATALOG #	DESCRIPTION
KM98160	Holds 12 7" KMedic® Brun Currettes

COBB SMARTRACK FOR 11" INSTRUMENTS



KM98170

Aluminum and stainless steel.

CATALOG #	DESCRIPTION
KM98170	Holds nine 11" KMedic® Cobb Currettes, Elevators or Gouges

HIBBS AND BRUN SMARTRACK FOR 9" INSTRUMENTS



KM98180

Aluminum and stainless steel.

CATALOG #	DESCRIPTION
KM98180	Holds 12 9" KMedic® Brun Currettes, or Hibbs Chisels, Gouges or Osteotomes



OSTEOTOMES

Lambotte

MINI-LAMBOTTE OSTEOTOMES, STRAIGHT 5"



KM46342

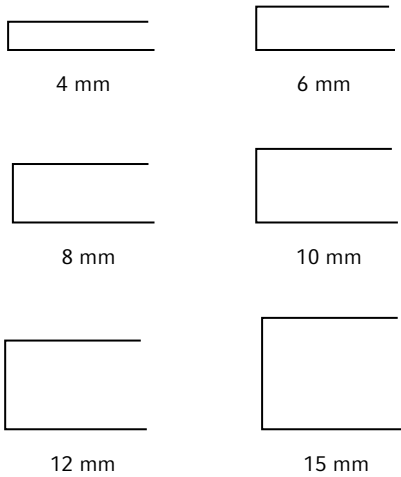

Straight, without calibration lines, 5" (12.5 cm).

CATALOG #	DESCRIPTION
KM46336	1/8" (4 mm)
KM46338	1/4" (6 mm)
KM46340	5/16" (8 mm)
KM46342	3/8" (10 mm)
KM46344	1/2" (12 mm)
KM46343	9/16" (14 mm)
KM46345	5/8" (15 mm)
KM46346	11/16" (18 mm)
KM46347	3/4" (19 mm)
KM46335	13/16" (20 mm)

LAMBOTTE-STYLE OSTEOTOMES



051086

Pilling® Pattern, flat thin blade, 5" (12.5 cm).

CATALOG #	DESCRIPTION
051082	2 mm
051084	4 mm
051086	6 mm
051088	8 mm
051090	10 mm
051092	12 mm
051095	15 mm

OSTEOTOMES

Lambotte

LAMBOTTE OSTEOTOMES, STRAIGHT 7"



KM46348

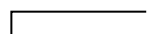

4 mm

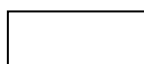

8 mm

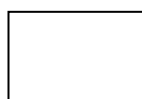

12 mm

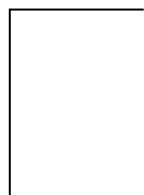

25 mm

Straight, with calibration lines, 7" (18 cm).

CATALOG #	DESCRIPTION
KM46348	1/8" (4 mm)
KM46349	3/16" (5 mm)
KM46350	1/4" (6 mm)
KM46358	5/16" (8 mm)
KM46351	3/8" (10 mm)
KM46352	1/2" (12 mm)
KM46353	5/8" (16 mm)
KM46354	3/4" (19 mm)
KM46355	7/8" (22 mm)
KM46356	1" (25 mm)

LONG BEVEL OSTEOTOMES



KM69940

The unusually long bevel allows the cut bone to bend gradually as it is cut. Calibration lines, 7" (18 cm).

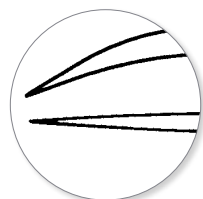

KM69970



10 mm



20 mm

CATALOG #	DESCRIPTION
KM69940	Straight, 10 mm
KM69946	Straight, 20 mm
KM69950	Straight, 25 mm
KM69970	Curved, 5 mm
KM69975	Curved, 10 mm



OSTEOTOMES

Lambotte

LAMBOTTE OSTEOTOMES, STRAIGHT 9"



KM46310

Straight, without calibration lines, 9" (23 cm).

CATALOG #	DESCRIPTION
KM46304	1/4" (6 mm)
KM46306	1/2" (13 mm)
KM46310	3/4" (19 mm)
KM46314	1" (25 mm)
KM46318	1-1/4" (32 mm)
KM46322	1-1/2" (38 mm)

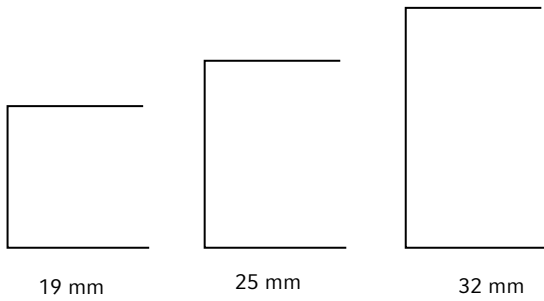
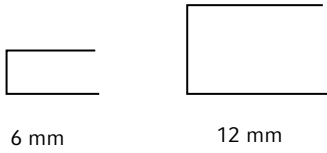

LAMBOTTE OSTEOTOMES, CURVED 9"



KM46330

Curved, without calibration lines, 9" (23 cm).

CATALOG #	DESCRIPTION
KM46328	1/4" (6 mm)
KM46329	1/2" (12 mm)
KM46330	3/4" (19 mm)
KM46331	1" (25 mm)
KM46332	1-1/4" (32 mm)
KM46333	1-1/2" (38 mm)

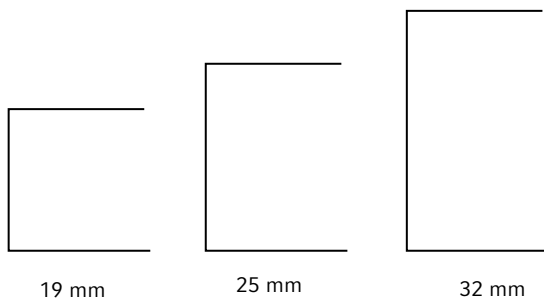
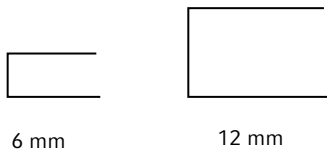

OSTEOTOMES

Specialty

OSTEOTOMES



051104

Flat thin blade, 6" (15 cm).

CATALOG #	DESCRIPTION
051102	2 mm
051103	3 mm
051104	4 mm
051105	5 mm
051106	6 mm
051107	7 mm
051110	10 mm

MINI OSTEOTOMES



441208

Curved, 5" (12.5 cm).

CATALOG #	DESCRIPTION
441207	4 mm
441208	6 mm

Hoke

HOKE OSTEOTOMES



KM46499

5-1/4" (13.5 cm).

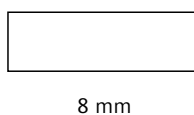
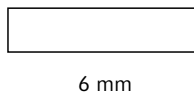
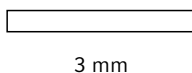

CATALOG #	TIP	TIP WIDTH
KM46497	Straight	1/8" (3 mm)
KM46498	Straight	3/16" (4 mm)
KM46499	Straight	1/4" (6 mm)
KM46500	Straight	5/16" (8 mm)
KM46501	Straight	3/8" (10 mm)
KM46502	Straight	1/2" (13 mm)
KM46503	Straight	5/8" (16 mm)
KM46504	Straight	3/4" (19 mm)
KM46700	Curved	1/8" (3 mm)
KM46701	Curved	3/16" (4 mm)
KM46702	Curved	1/4" (6 mm)
KM46703	Curved	5/16" (8 mm)
KM46704	Curved	3/8" (10 mm)
KM46706	Curved	1/2" (13 mm)
KM46708	Curved	5/8" (16 mm)
KM46709	Curved	3/4" (19 mm)



OSTEOTOMES

Sheehan

SHEEHAN OSTEOTOMES



KM46274

Straight, 6-1/4" (16 cm).

CATALOG #	DESCRIPTION
KM46268	2 mm
KM46270	4 mm
KM46272	6 mm
KM46274	8 mm
KM46276	10 mm
KM46278	12 mm
KM46280	15 mm

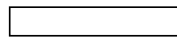

4 mm

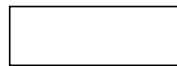

8 mm

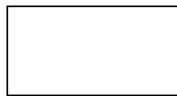

12 mm

Silver

SILVER OSTEOTOMES



KM58100

Single guard, 7" (18 cm).

CATALOG #	DESCRIPTION
KM58100	Straight
KM58102	Guard, right
KM58104	Guard, left

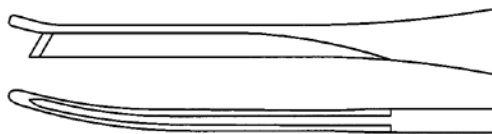

KM58102

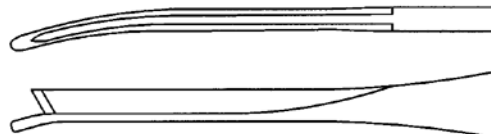

KM58104

OSTEOTOMES

U.S. Army

U.S. ARMY PATTERN OSTEOTOMES



KM46286

7" (18 cm).

CATALOG #	DESCRIPTION
KM46284	6 mm
KM46286	12 mm
KM46288	18 mm

Stille

STILLE OSTEOTOMES

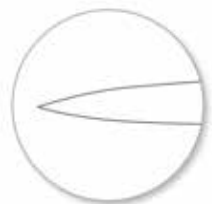

KM49002

Straight, 8" (20.5 cm).

CATALOG #	DESCRIPTION
KM49002	10 mm
KM49004	14 mm
KM49006	18 mm
KM49008	22 mm



OSTEOTOMES

Hibbs

HIBBS OSTEOTOMES



KM46363



KM46379

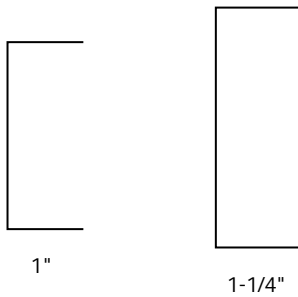

9" (23 cm).

CATALOG #	TIP	TIP WIDTH
KM46359	Straight	1/4"
KM46360	Straight	3/8"
KM46361	Straight	1/2"
KM46362	Straight	5/8"
KM46363	Straight	3/4"
KM46364	Straight	7/8"
KM46365	Straight	1"
KM46366	Straight	1-1/8"
KM46367	Straight	1-1/4"
KM46368	Straight	1-1/2"
KM46373	Curved	1/4"
KM46376	Curved	3/8"
KM46377	Curved	1/2"
KM46378	Curved	5/8"
KM46379	Curved	3/4"
KM46380	Curved	7/8"
KM46381	Curved	1"
KM46382	Curved	1-1/8"
KM46383	Curved	1-1/4"
KM46384	Curved	1-1/2"

HIBBS ENDOSCOPIC OSTEOTOME



KM55642



Straight tip, 18-1/2" (47 cm).

CATALOG #	TIP WIDTH	TIP LENGTH	SHAFT LENGTH	SHAFT DIAMETER	HANDLE LENGTH
KM55642	3/8" (10 mm)	3-1/2"	10-3/4"	0.43" (11 mm)	4-1/4"



OSTEOTOMES

Smith Peterson

SMITH PETERSON OSTEOTOME



KM46457



KM46462



8" (20.5 cm).

CATALOG #	TIP	TIP WIDTH
KM46448	Straight	1/4"
KM46449	Straight	3/8"
KM46450	Straight	1/2"
KM46451	Straight	5/8"
KM46452	Straight	3/4"
KM46453	Straight	1"
KM46454	Straight	1-1/4"
KM46457	Curved	1/4"
KM46458	Curved	3/8"
KM46459	Curved	1/2"
KM46460	Curved	5/8"
KM46461	Curved	3/4"
KM46462	Curved	1"
KM46463	Curved	1-1/4"

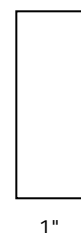

Cobb

COBB OSTEOTOME



KM49350



All stainless steel, 11" (28 cm).

CATALOG #	DESCRIPTION
KM49350	Straight, 1/4"
KM49351	Straight, 3/8"
KM49352	Straight, 1/2"
KM49353	Straight, 5/8"
KM49354	Straight, 3/4"
KM49355	Straight, 1"
KM49356	Straight, 1-1/4"
KM49357	Curved, 1/4"
KM49358	Curved, 3/8"
KM49359	Curved, 1/2"
KM49360	Curved, 5/8"
KM49361	Curved, 3/4"
KM49362	Curved, 1"
KM49363	Curved, 1-1/4"

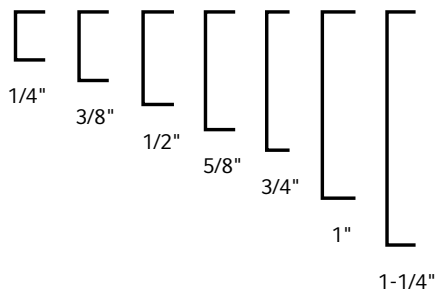



OSTEOTOMES

Interchangeable Osteotome, Chisel and Gouge Set

INTERCHANGEABLE OSTEOTOME, CHISEL AND GOUGE SET



KM49630

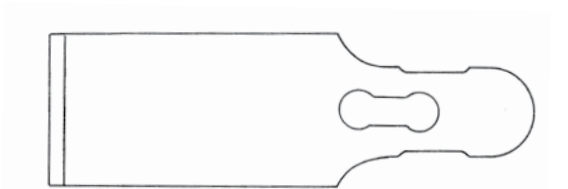

KM49664

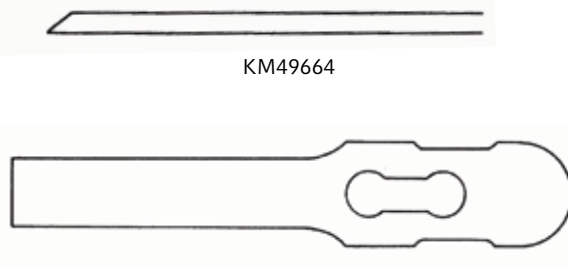

KM49672

CATALOG #	DESCRIPTION
KM49630	Complete set with handle, key and all blades
KM49632	Phenolic handpiece only, 7-3/8" (18.5 cm)
KM49634	Key only
KM49668	Osteotome blade, 5 mm
KM49672	Osteotome blade, 10 mm
KM49676	Osteotome blade, 16 mm
KM49680	Osteotome blade, 25 mm
KM49652	Chisel blade, 5 mm
KM49656	Chisel blade, 10 mm
KM49660	Chisel blade, 16 mm
KM49664	Chisel blade, 25 mm
KM49640	Gouge blade, 1" wide, 50 mm radius
KM49644	Gouge blade, 1" wide, 60 mm radius
KM49648	Gouge blade, 1" wide, 70 mm radius

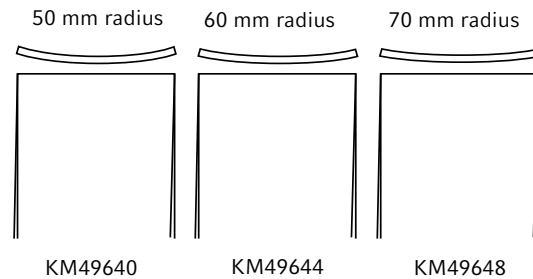

Blades should be discarded after use.
Phenolic handle is autoclavable to 290° F (143° C).

SMARTRACKS FOR OSTEOTOMES



LIGHTWEIGHT STORAGE RACKS

- Nylon coated brackets help avoid metal-to-metal contact.
- Plastic plate on underside of top bracket helps protect sharp tips from being damaged.
- Side arm stays locked to help prevent instruments from falling out, even when turned upside down.
- Deep brackets hold instruments in place.
- Custom designed base keeps instruments upright during loading and unloading.
- Reinforced, sturdier frames are made from corrosion-resistant anodized aluminum.
- Quick reference chart easily identifies the type and size instrument rack holds.
- Manufactured only by Teleflex®.

HOKE SMARTRACK

KM98150
 8-1/4" x 5" x 2-1/4"
 (21 cm x 12.5 cm x 5.5 cm)
 Holds eight 5-1/4" (13.5 cm)

LAMBOTTE SMARTRACK

KM98190
 11-3/4" x 5-1/2" x 3-3/8"
 (30 cm x 8.5 cm x 14 cm)
 Holds 12 9" (23 cm) KMedic® Lambotte Osteotomes





CHISELS AND GOUGES

Chisels

ALEXANDER CHISELS



7-1/8" (18 cm).

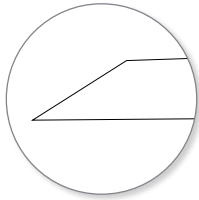

KM49042



4 mm



6 mm



8 mm



10 mm



12 mm



14 mm

CATALOG #	DESCRIPTION
KM49040	4 mm
KM49041	6 mm
KM49042	8 mm
KM49043	10 mm
KM49044	12 mm
KM49045	14 mm

ARMY PATTERN CHISELS



7-1/8" (18 cm).



KM46289



6 mm



12 mm

CATALOG #	DESCRIPTION
KM46289	6 mm
KM46290	12 mm
KM46291	18 mm

CHISELS AND GOUGES

Chisels

HIBBS CHISELS

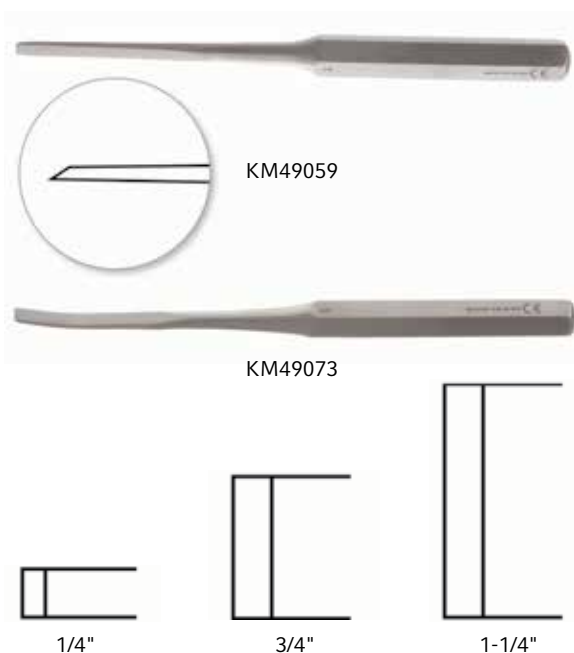

9" (23 cm).

CATALOG #	TIP	TIP WIDTH
KM49059	Straight	1/4"
KM49060	Straight	3/8"
KM49061	Straight	1/2"
KM49062	Straight	5/8"
KM49063	Straight	3/4"
KM49064	Straight	7/8"
KM49065	Straight	1"
KM49066	Straight	1-1/8"
KM49067	Straight	1-1/4"
KM49068	Straight	1-1/2"
KM49073	Curved	1/4"
KM49074	Curved	3/8"
KM49075	Curved	1/2"
KM49076	Curved	5/8"
KM49077	Curved	3/4"
KM49078	Curved	7/8"
KM49079	Curved	1"
KM49080	Curved	1-1/8"
KM49081	Curved	1-1/4"
KM49082	Curved	1-1/2"

HOKE CHISELS

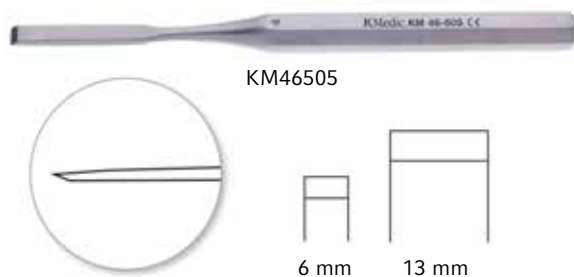

Straight, 5-1/4" (13.5 cm).

CATALOG #	DESCRIPTION
KM46505	3/16" (4 mm)
KM46506	1/4" (6 mm)
KM46507	3/8" (10 mm)
KM46508	1/2" (13 mm)
KM46509	3/4" (19 mm)



CHISELS AND GOUGES

Chisels

LEXER CHISELS



Phenolic handle, 8-5/8" (22 cm).

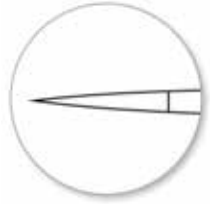

KM49248

CATALOG #	DESCRIPTION
KM49246	5 mm
KM49248	7 mm
KM49250	10 mm
KM49252	15 mm
KM49254	20 mm
KM49256	25 mm
KM49258	30 mm

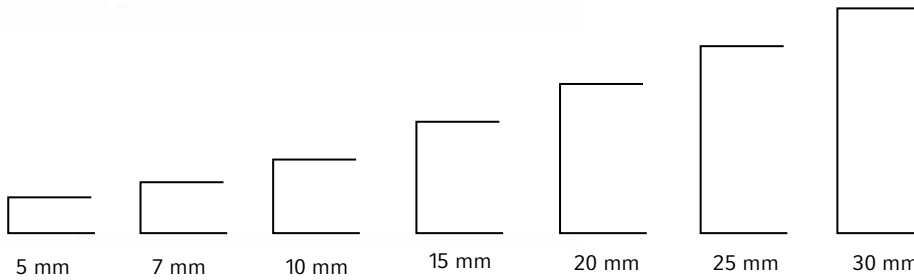

LEXER MINI CHISELS



Phenolic handle, 7-1/8" (18 cm).



KM49260

CATALOG #	DESCRIPTION
KM49260	4 mm
KM49262	6 mm
KM49264	8 mm
KM49266	10 mm
KM49268	12 mm

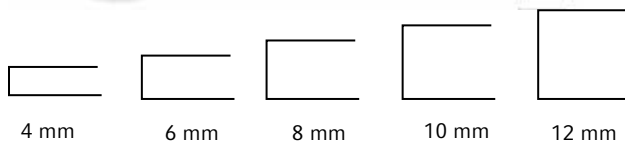

STILLE-TYPE CHISELS



8-1/8" (20.5 cm).

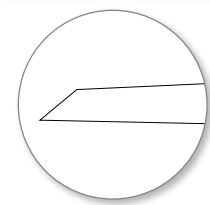

KM49012

CATALOG #	DESCRIPTION
KM49010	10 mm
KM49012	14 mm
KM49014	18 mm
KM49016	22 mm

CHISELS AND GOUGES

Gouges

ALEXANDER GOUGES



7" (18 cm).

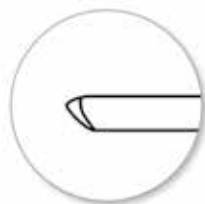

KM49052

CATALOG #	DESCRIPTION
KM49050	4 mm
KM49051	6 mm
KM49052	8 mm
KM49053	10 mm
KM49054	12 mm
KM49055	14 mm

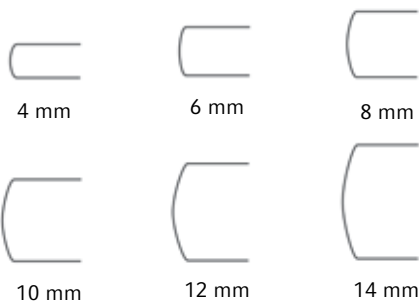

U.S. ARMY PATTERN GOUGES



7" (18 cm).

KM46292

CATALOG #	DESCRIPTION
KM46292	6 mm
KM46293	12 mm
KM46294	14 mm

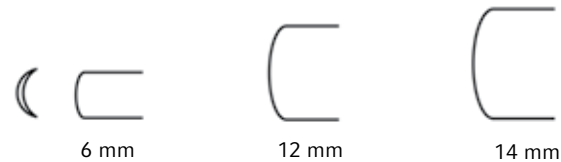



CHISELS AND GOUGES

Gouges

STILLE-TYPE GOUGES

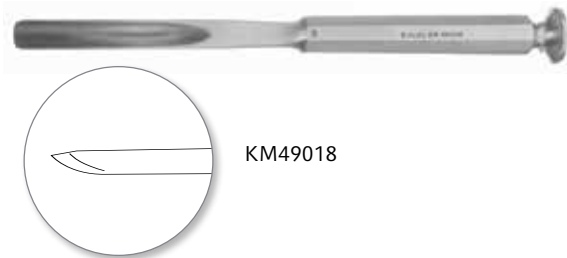

KM49018

8" (20.5 cm).

CATALOG #	DESCRIPTION
KM49018	10 mm
KM49020	14 mm
KM49022	18 mm
KM49024	22 mm

SHOULDER PENETRATING GOUGE



KM46919

CATALOG #	DESCRIPTION
KM46919	3 mm tip, 8-1/2" (21.5 cm)

SMITH PETERSON GOUGES

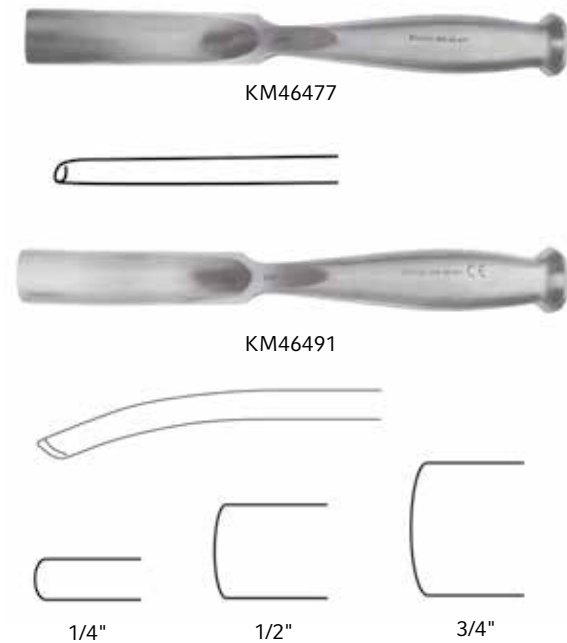

KM46477

KM46491

CATALOG #	TIP	TIP WIDTH
KM46466	Straight	1/4"
KM46467	Straight	3/8"
KM46468	Straight	1/2"
KM46476	Straight	5/8"
KM46477	Straight	3/4"
KM46478	Straight	1"
KM46479	Straight	1-1/4"
KM46487	Curved	1/4"
KM46488	Curved	3/8"
KM46489	Curved	1/2"
KM46490	Curved	5/8"
KM46491	Curved	3/4"
KM46493	Curved	1"
KM46495	Curved	1-1/4"

1/4"

1/2"

3/4"

CHISELS AND GOUGES

Gouges

HIBBS GOUGES

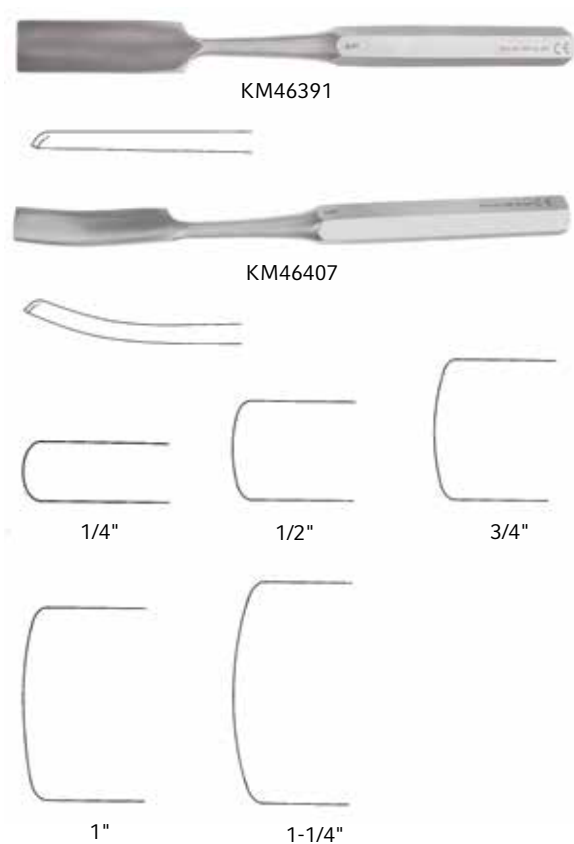

9" (23 cm).

CATALOG #	TIP	TIP WIDTH
KM46387	Straight	1/4"
KM46388	Straight	3/8"
KM46389	Straight	1/2"
KM46390	Straight	5/8"
KM46391	Straight	3/4"
KM46392	Straight	7/8"
KM46393	Straight	1"
KM46394	Straight	1-1/8"
KM46395	Straight	1-1/4"
KM46401	Straight	1-1/2"
KM46402	Curved	1/4"
KM46403	Curved	3/8"
KM46404	Curved	1/2"
KM46405	Curved	5/8"
KM46407	Curved	3/4"
KM46408	Curved	7/8"
KM46409	Curved	1"
KM46410	Curved	1-1/8"
KM46411	Curved	1-1/4"
KM46412	Curved	1-1/2"

SWAN NECK GOUGE



CATALOG #	DESCRIPTION
KM49084	1" distal tip, 9" (23 cm)

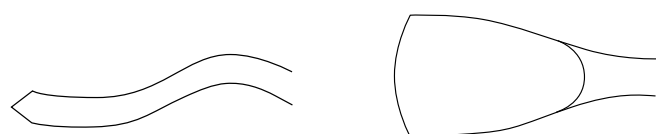



CHISELS AND GOUGES

Gouges

COBB-TYPE SPINAL GOUGES

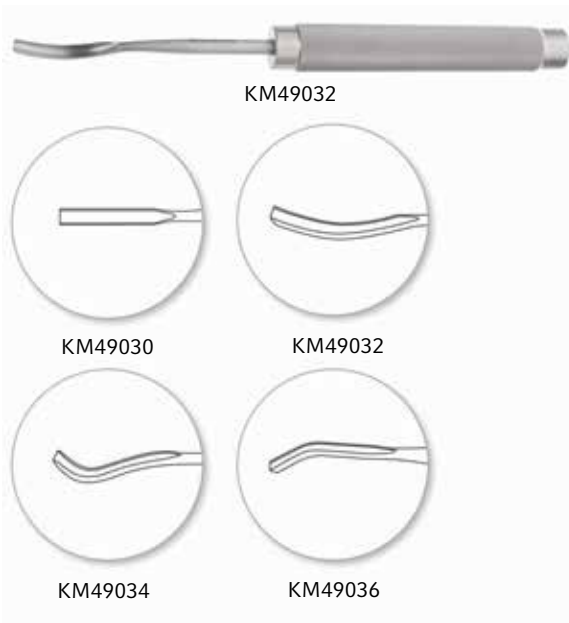

All stainless, with knurled handle, 5/32" (7 mm) distal tip, 11" (28 cm).

CATALOG #	DESCRIPTION
KM49030	Straight
KM49032	Medium curve
KM49034	Strong curve
KM49036	Reverse curve

HIBBS ENDOSCOPIC GOUGE



Straight tip, stainless steel handle, 18-1/2" (47 cm).

CATALOG #	TIP WIDTH	TIP LENGTH	SHAFT LENGTH	SHAFT DIAMETER	HANDLE LENGTH
KM55630	0.28" (7 mm)	3-1/2"	10-3/4"	0.43"	4-1/4"

BONE TAMPS AND IMPACTORS

Bone Tamps

BONE TAMPS



Cross-serrated tip, 6-1/4" (16 cm).

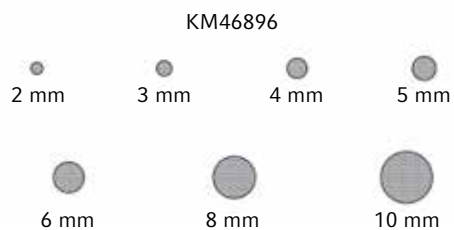

KM46896

CATALOG #	DESCRIPTION
KM46893	2 mm diameter
KM46894	3 mm
KM46895	4 mm
KM46896	5 mm
KM46897	6 mm
KM46898	8 mm
KM46899	10 mm

BONE IMPACTOR



Designed to tap bone graft or bone parts into place with minimal trauma to the bone. The compactor head is nylon with a grid surface to prevent slippage.

KM69980

CATALOG #	DESCRIPTION
KM69980	Anodized aluminum handle with replaceable nylon caps, head diameter 20 mm, 6-1/2" (16.5 cm)

Autoclavable to 250°F (121°C)

BONE CHIP PACKERS



Stainless steel handle, 9-7/8" (25 cm).

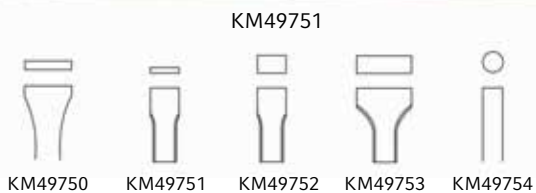

KM49751

CATALOG #	DESCRIPTION
KM49750	3 mm x 16 mm
KM49751	2 mm x 9 mm
KM49752	6 mm x 9 mm
KM49753	6 mm x 19 mm
KM49754	1/4" (5 mm)



BONE TAMPS AND IMPACTORS

Impactors

ENDOSCOPIC BONE TAMP

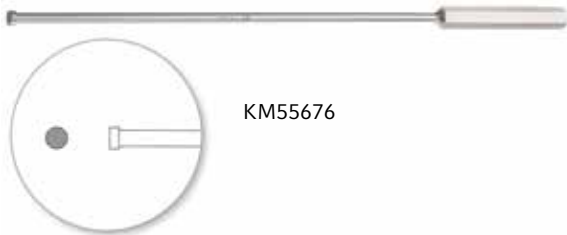

KM55676

Straight, stainless steel handle, 17" (43 cm).

CATALOG #	TIP WIDTH	TIP LENGTH	SHAFT LENGTH	SHAFT DIAMETER	HANDLE LENGTH
KM55676	3/8" (10 mm)	0.16"	12.59"	0.280" (7.1 mm)	4-1/4"

LUMBAR AND CERVICAL IMPACTORS AND DRIVERS



KM55373

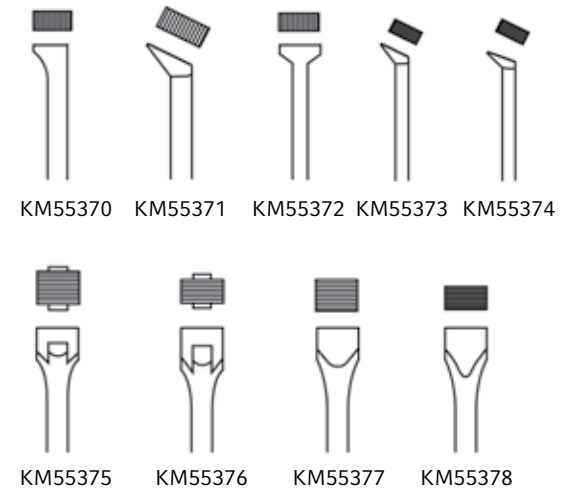

KM55370 KM55371 KM55372 KM55373 KM55374
KM55375 KM55376 KM55377 KM55378

CATALOG #	DESCRIPTION
KM55370	Impactor, standard offset, 6 mm x 12 mm, 8-1/2" (21.5 cm)
KM55371	Impactor, central canal, 7 mm x 16 mm, 8-1/2" (21.5 cm)
KM55372	Impactor, lateral narrow, 6 mm x 13 mm, 8-1/2" (21.5 cm)
KM55373	Impactor, micro offset, 4 mm x 9.5 mm, 7" (18 cm)
KM55374	Impactor, micro lateral, 4 mm x 10 mm, 7" (18 cm)
KM55375	Graft driver, lumbar, guarded, 10 mm x 13 mm, 8-1/2" (21.5 cm)
KM55376	Graft driver, anterior, guarded, 7 mm x 13 mm, 8-1/2" (21.5 cm)
KM55377	Graft driver, lumbar, unguarded, 10 mm x 13 mm, 8-1/2" (21.5 cm)
KM55378	Graft driver, anterior, unguarded, 7 mm x 13 mm, 8-1/2" (21.5 cm)

MALLETS

Light and Medium Weight Mallets

NARROW TIP MALLET



KM49764

Useful for hand surgery and in areas where access is limited.

CATALOG #	WEIGHT	HEAD WEIGHT	HEAD DIAMETER	OVERALL LENGTH
KM49764	7 oz (198 g)	3 oz (85 g)	18 x 18 mm (square contact surface) 7 mm (round contact surface)	8" (20.5 cm)

Autoclavable to 290°F (143°C)

SOLID COPPER HEAD MALLET



051510

CATALOG #	WEIGHT	HEAD DIAMETER	OVERALL LENGTH
051510	4 oz (113 g)	3/4" (20 mm)	6-1/2" (16.5 cm)

MINI MALLET



KM49765

Solid stainless steel.

CATALOG #	WEIGHT	HEAD WEIGHT	HEAD DIAMETER	OVERALL LENGTH
KM49765	4 oz (113 g)	3 oz (85 g)	20 mm	7" (18 cm)



MALLETS

Light and Medium Weight Mallets

LUCAE BONE MALLETS



Solid stainless steel handles.

CATALOG #	WEIGHT	HEAD	HEAD WEIGHT	HEAD DIAMETER	OVERALL LENGTH
KM49761	7 oz (198 g)	Stainless steel	3 oz (85 g)	19 mm	7-1/2" (19 cm)
KM46660	9 oz (260 g)	Brass	5 oz (142 g)	25 mm	8" (20.5 cm)

MALLET #49



Lead filled and faced.

CATALOG #	WEIGHT	HEAD WEIGHT	HEAD DIAMETER	OVERALL LENGTH
KM46656	7 oz (198 g)	5 oz (142 g)	22 mm	7-3/4" (19.5 cm)

Lead filled mallets should only be used to strike flat surfaces. Do not use to hit sharp objects as doing so can lead to flake off.

MALLET



Lightweight. Includes two replaceable nylon caps, anodized aluminum handle.

CATALOG #	WEIGHT	HEAD WEIGHT	HEAD DIAMETER	OVERALL LENGTH
KM46662	7 oz (198 g)	4 oz (113 g)	25 mm	7-1/2" (19 cm)

Autoclavable to 250°F (121°C)

MALLET CAPS



CATALOG #	DESCRIPTION
KM46662P	Pair of nylon caps for KM46662, 1" (2.5 cm)

MALLETS

Light and Medium Weight Mallets

NYLON HEAD MALLETS



CATALOG #	WEIGHT	HEAD DIAMETER	OVERALL LENGTH
051520	8 oz (227 g)	1" (25 mm)	7-1/2" (19 cm)
051525	11 oz (312 g)	1-1/4" (32 mm)	7-5/8" (19.5 cm)

NYLON HEAD MALLET FACES



051526

CATALOG #	DESCRIPTION
051521	Extra 1" nylon face for 051520
051526	Extra 1-1/2" nylon face for 051525

COLLIN MALLET



Solid stainless steel.

CATALOG #	WEIGHT	HEAD WEIGHT	HEAD DIAMETER	OVERALL LENGTH
KM49760	7 oz (198 g)	5 oz (142 g)	30 mm	8" (20.5 cm)

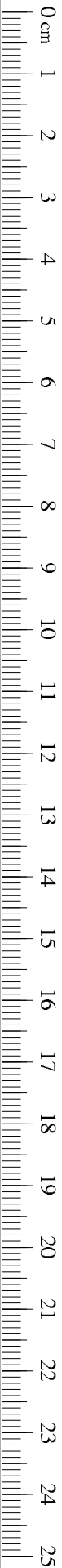

MALLETS

Light and Medium Weight Mallets

PECK MALLETT



441420

CATALOG #	WEIGHT	OVERALL LENGTH
441420	7.7 oz (218 g)	7-7/8" (20 cm)

MEAD MALLETT

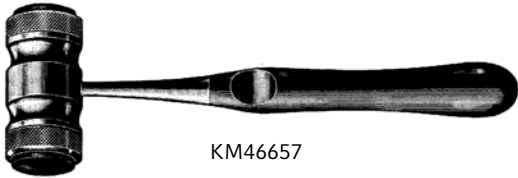

KM46657

Includes replaceable nylon caps.

CATALOG #	WEIGHT	HEAD WEIGHT	HEAD DIAMETER	OVERALL LENGTH
KM46657	11 oz (315 g)	6 oz (170 g)	20 mm	7-1/2" (19 cm)

Autoclavable to 250°F (121°C)

GERZOG BONE MALLETT



KM46661

Lead filled and faced.

CATALOG #	WEIGHT	HEAD WEIGHT	HEAD DIAMETER	OVERALL LENGTH
KM46661	10 oz (285 g)	7 oz (200 g)	25 mm	7-1/2" (19 cm)

Lead filled mallets should only be used to strike flat surfaces. Do not use to hit sharp objects as doing so can lead to flake off.

MALLETS

Light and Medium Weight Mallets

BERGMAN MALLETS



Aluminum alloy handle.

CATALOG #	WEIGHT	HEAD WEIGHT	HEAD DIAMETER	OVERALL LENGTH
KM49766	15 oz (425 g)	9 oz (255 g)	30 mm	8-7/8" (22.5 cm)
KM49767	1 lb 1 oz (482 g)	11 oz (312 g)	45 mm	9-1/2" (24 cm)

COMBINATION MALLETS



With one nylon cap and one solid stainless side.

CATALOG #	WEIGHT	HEAD WEIGHT	HEAD DIAMETER	OVERALL LENGTH
KM46686	9 oz (260 g)	5 oz (142 g)	25 mm	7-1/2" (19 cm)
KM46687	12 oz (340 g)	8 oz (227 g)	32 mm	7-1/2" (19 cm)

Autoclavable to 250°F (121°C)

COMBINATION Mallet CAPS



With one nylon cap and one solid stainless side.

CATALOG #	DESCRIPTION
KM46686P	Nylon cap for KM46686, 1" (2.5 cm)
KM46687P	Nylon cap for KM46687, 1-1/4" (3.2 cm)

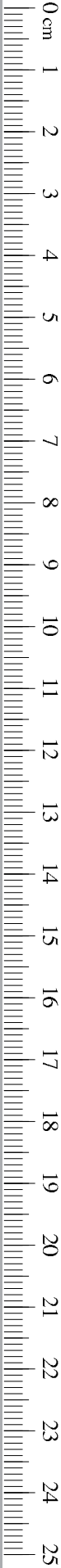

MALLETS

Light and Medium Weight Mallets

CLOWARD-STYLE MALLETS



KM55400

Solid stainless steel.

CATALOG #	WEIGHT	HEAD WEIGHT	HEAD DIAMETER	BALL PEEN DIAMETER	OVERALL LENGTH
KM55400	8 oz (227 g)	4 oz (113 g)	20.5 mm	17.5 mm	7-1/2" (19 cm)
KM55401	16 oz (454 g)	8 oz (227 g)	25 mm	22 mm	9" (23 cm)

ORTHOPEDIC MALLETS



KM49763

Solid stainless steel.

CATALOG #	HANDLE LENGTH	WEIGHT	HEAD WEIGHT	HEAD DIAMETER	OVERALL LENGTH
KM49763	Short	1 lb 2 oz (510 g)	8 oz (227 g)	30.5 mm	7" (18 cm)
KM46666	Normal	2 lbs (900 g)	1 lb (455 g)	32 mm	10-3/4" (27.5 cm)



KM46666

MALLETS

Heavyweight Mallets

KIRK MALLET



Brass filled with stainless steel face.

CATALOG #	WEIGHT	HEAD WEIGHT	HEAD DIAMETER	OVERALL LENGTH
KM46658	1 lb 7 oz (650 g)	1 lb 4 oz (570 g)	38 mm	8" (20.5 cm)

Head is brass filled and should only be used to strike flat surfaces.

HEATH MALLET



Heavyweight, solid stainless steel.

CATALOG #	WEIGHT	HEAD WEIGHT	HEAD DIAMETER	OVERALL LENGTH
KM46663	2 lbs (907 g)	1 lb 4 oz (570 g)	40 mm	7-1/2" (19 cm)

ORTHOPEDIC MALLETS



Solid stainless steel.

CATALOG #	HANDLE LENGTH	WEIGHT	HEAD WEIGHT	HEAD DIAMETER	OVERALL LENGTH
KM49762	Short	2 lbs (900 g)	1 lb 5 oz (595 g)	38 mm	7-1/2" (19 cm)
KM46667	Normal	3 lbs (1360 g)	2 lbs (900 g)	50 mm	11" (28 cm)

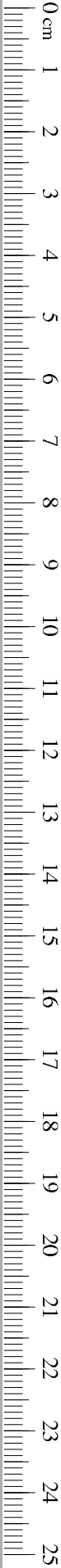

MALLETS

Heavyweight Mallets

PHENOLIC HANDLE MALLETS



Grooved phenolic handle for comfortable and safe grip.

CATALOG #	WEIGHT	HEAD WEIGHT	HEAD DIAMETER	OVERALL LENGTH
KM46688	1 lb 11 oz (765 g)	1 lb (455 g)	32 mm	11" (28 cm)
KM46689	2 lbs 9 oz (1162 g)	2 lbs (900 g)	45 mm	11" (28 cm)

Autoclavable to 290°F (143°C)

REPERCUSSION FREE MALLETT



Also known as a dead blow mallet. One nylon cap and one stainless steel side. Grooved phenolic handle for comfortable grip.

CATALOG #	WEIGHT	HEAD WEIGHT	HEAD DIAMETER	OVERALL LENGTH
KM46690	1 lb 5 oz (600 g)	10 oz (285 g)	30 mm	11" (28 cm)

Autoclavable to 250°F (121°C)

REPERCUSSION FREE MALLETT CAP



CATALOG #	DESCRIPTION
KM46690P	Cap only for KM46690

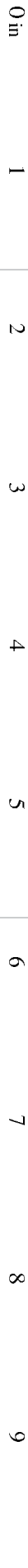

BONE CUTTING FORCEPS

CLEVELAND BONE CUTTING FORCEPS



KM47270

For small bones.

CATALOG #	DESCRIPTION
KM47270	5-3/4" (15 cm)
KM47272	6-1/2" (17 cm)



KM47270



KM47272

MCINDOE BONE CUTTING FORCEPS



KM47546

CATALOG #	DESCRIPTION
KM47546	Angled, very delicate, 7" (18 cm)



BONE CUTTING FORCEPS

LISTON BONE CUTTING FORCEPS



KM47402

CATALOG #	DESCRIPTION
KM47398	Straight, 5-1/2" (14 cm)
KM47410	Angled on flat, 5-1/2" (14 cm)
KM47400	Straight, 6-3/4" (17 cm)
KM47404	Angled on flat, 6-3/4" (17 cm)
KM47402	Straight, 7-7/8" (20 cm)
KM47412	Angled, 7-7/8" (20 cm)
KM47406	Straight, 8-5/8" (22 cm)
KM47408	Angled on flat, 8-1/2" (22 cm)



KM47398



KM47410



KM47400



KM47404



KM47402



KM47412

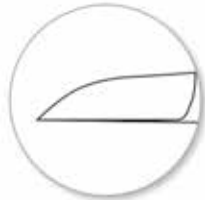

KM47406



KM47408

BONE CUTTING FORCEPS

RUSKIN-LISTON BONE CUTTING FORCEPS

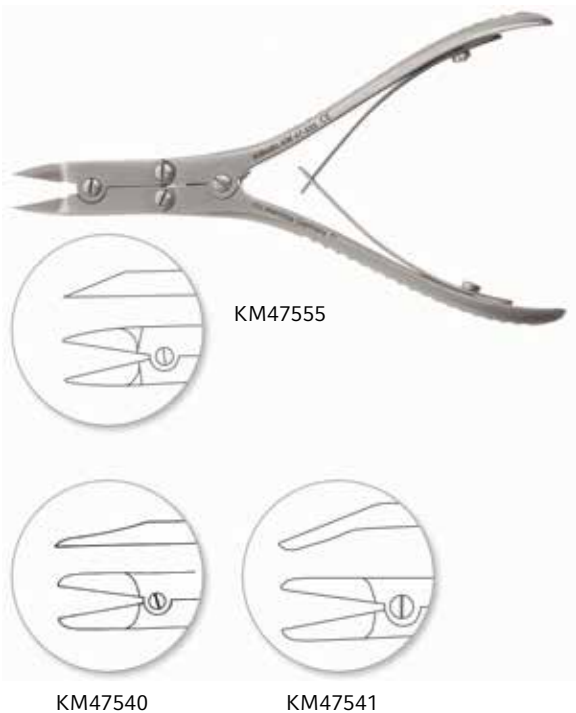

Delicate blades.

CATALOG #	DESCRIPTION
KM47555	Straight, 5-5/8" (15 cm)
KM47557	Angled, 5-1/2" (14 cm)
KM47540	Straight, 7-1/8" (18 cm)
KM47541	Angled on flat, 7" (18 cm)

STILLE-LISTON BONE CUTTING FORCEPS

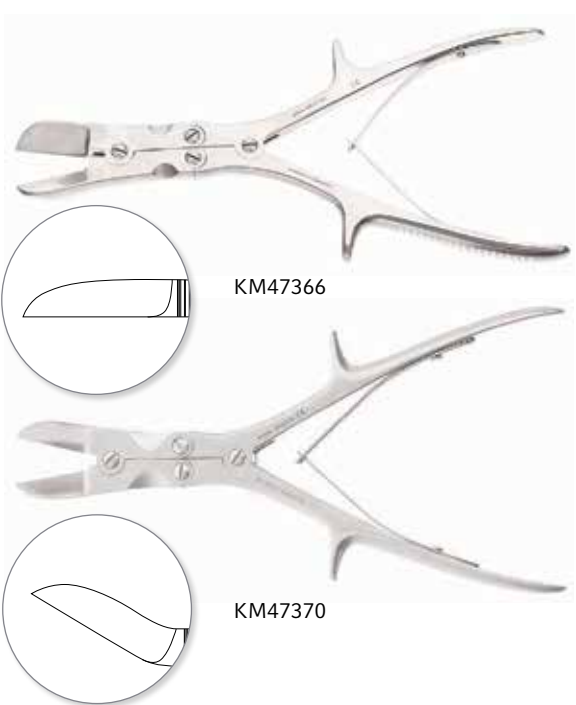

10-1/2" (27 cm).

CATALOG #	DESCRIPTION
KM47366	Straight
KM47370	Angled on flat



BONE CUTTING FORCEPS

RUSKIN-LISTON BONE CUTTING FORCEPS

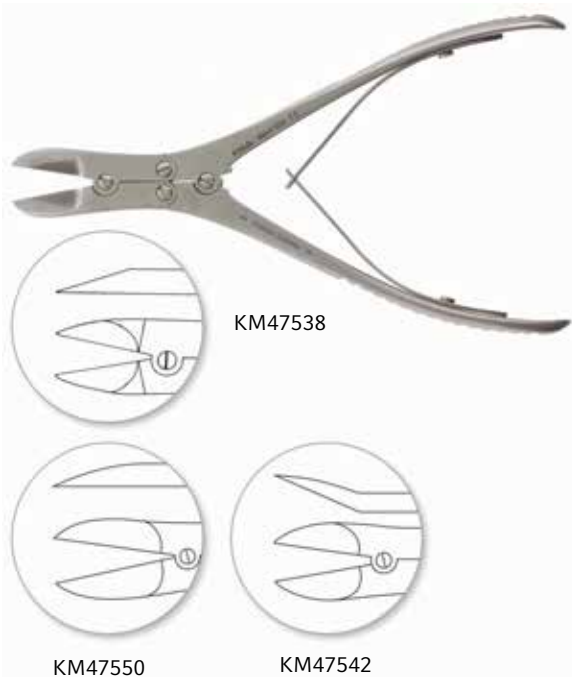

CATALOG #	DESCRIPTION
KM47550	Straight, 6" (15 cm)
KM47538	Straight, 7-1/4" (19 cm)
KM47542	Angled, 7-1/4" (19 cm)

STILLE-HORSLEY BONE CUTTING FORCEPS



CATALOG #	DESCRIPTION
KM47374	Angled, 9-3/8" (24 cm)

RONGEURS

Single Action Design

SYNOVECTOMY RONGEURS



2 x 5 mm bite, extremely delicate.

CATALOG #	DESCRIPTION
KM47252	Slightly curved, 6-7/8" (17.5 cm)
KM47253	Strongly curved, 6-3/4" (17 cm)

RONGEUR #4



CATALOG #	DESCRIPTION
KM47274	Curved, 4 x 9 mm bite, 5-1/2" (14 cm)

RONGEUR #4A



CATALOG #	DESCRIPTION
KM47275	Curved, 4 x 7 mm bite, 6-1/2" (16.5 cm)



RONGEURS

Single Action Design

MICRO FRIEDMAN RONGEURS



1.5 x 5 mm bite. For soft tissue and cancellous bone only. Extremely delicate.

CATALOG #	DESCRIPTION
KM47240	Straight, 5-3/4" (14.5 cm)
KM47242	30 degree angled, 5-1/2" (14 cm)
KM47244	90 degree angled, 5-1/2" (14 cm)

RONGEURS

Single Action Design

MINI FREIDMAN FONGEURS



Delicate, 2 x 8 mm bite, 6" (15 cm).

CATALOG #	DESCRIPTION
KM47263	Straight
KM47264	Curved

FRIEDMAN RONGEUR



CATALOG #	DESCRIPTION
KM47262	Curved, delicate, 4 x 11 mm bite, 5-3/4" (14.5 cm)

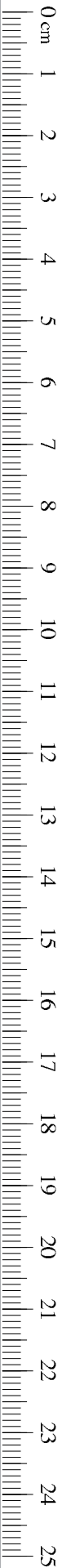

RONGEURS

Single Action Design

KLEINERT-KUTZ SYNOVECTOMY RONGEUR



CATALOG #	DESCRIPTION
065202	25 degrees strongly curved, 5-1/4" (13.5 cm)

BANE RONGEUR



CATALOG #	DESCRIPTION
KM47310	Curved, 3 x 16 mm bite, 7" (18 cm)

RONGEURS

Single Action Design

DEAN RONGEUR



CATALOG #	DESCRIPTION
KM47286	Curved, 3 mm bite, 5-3/4" (14.5 cm)

CHICHIRELLI (BLUMENTHAL) RONGEUR



CATALOG #	DESCRIPTION
KM47267	Curved 45 degrees, 4 x 13 mm bite, 6" (15 cm)

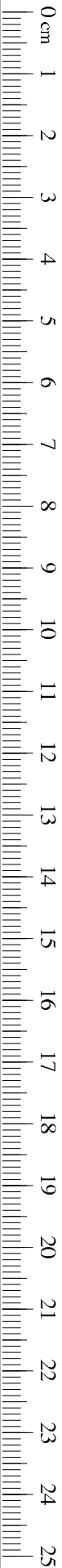

RONGEURS

Single Action Design

BACON RONGEUR



CATALOG #	DESCRIPTION
KM47308	Curved on side, 5 x 15 mm bite, 8" (20.5 cm)

LEMPERT RONGEURS



Delicate, 3 x 7 mm bite.

CATALOG #	DESCRIPTION
KM47258	Straight, 6" (15 cm)
KM47260	Curved, 6" (15 cm)
KM47254	Straight, 7-1/2" (19 cm)
KM47256	Curved, 7-1/2" (19 cm)

RONGEURS

Single Action Design

BEYER BONE BITING RONGEUR



CATALOG #	DESCRIPTION
028120	Curved jaw, 16 x 3 mm cup, 6-3/4" (17 cm)

DEAN (BLUMENTHAL) RONGEURS



4 x 11 mm, 6" (15 cm).

CATALOG #	DESCRIPTION
KM47266	Curved 30 degrees
KM47268	Curved 90 degrees

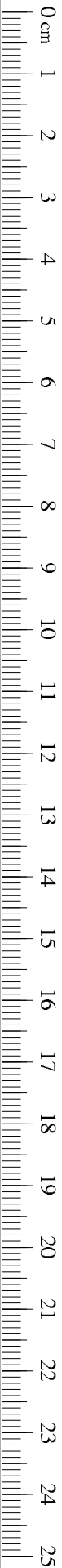

RONGEURS

Single Action Design

HARTMANN RONGEUR



KM47285

CATALOG #	DESCRIPTION
KM47285	Curved, 4 x 14 mm bite, 7-1/4" (18.5 cm)

MEAD RONGEUR

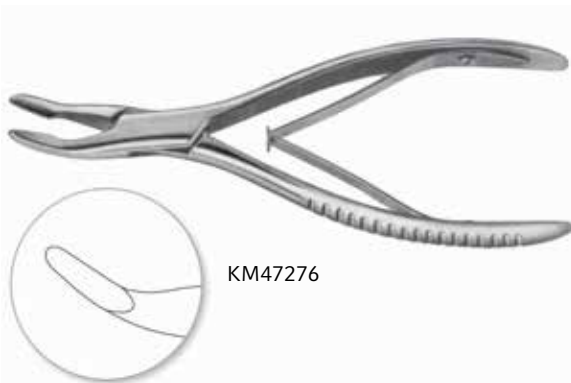

KM47276

CATALOG #	DESCRIPTION
KM47276	Curved, 5 x 13 mm bite, 6-1/2" (16.5 cm)

RONGEURS

Single Action Design

ADSON RONGEURS



7 x 15 mm bite, 8" (20.5 cm).

CATALOG #	DESCRIPTION
KM47302	Straight
KM47306	Curved

ADSON RAT TOOTH RONGEUR



Teeth facilitate easier bone excision.

CATALOG #	DESCRIPTION
KM47304	Straight with teeth, 8 x 15 mm bite, 8" (20.5 cm)



RONGEURS

Single Action Design

LEUR RONGEURS



KM47284

8 x 12 mm bite, 7-1/8" (18 cm).

CATALOG #	DESCRIPTION
KM47278	Straight
KM47284	Curved

Double Action Design

KLEINERT-KUTZ SYNOVECTOMY RONGEUR



KM47553

CATALOG #	DESCRIPTION
KM47553	Curved on side, delicate, 2 x 10 mm bite, 6" (15 cm)

RONGEURS

Double Action Design

KLEINERT-KUTZ SYNOVECTOMY RONGEUR



KM47558

CATALOG #	DESCRIPTION
KM47558	Fully curved, delicate, 3 mm bite, 6-1/8" (15.5 cm)

KLEINERT-KUTZ SYNOVECTOMY RONGEURS



KM47560

KM47562

Delicate, 6-1/8" (15.5 cm).

CATALOG #	DESCRIPTION
KM47560	Curved, 2 mm bite
KM47562	Curved, 3 mm bite

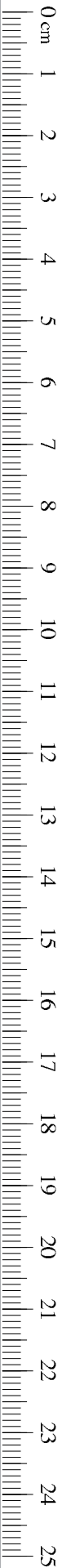

RONGEURS

Double Action Design

KLEINERT-KUTZ DOUBLE ACTION RONGEUR



065212

CATALOG #	DESCRIPTION
065212	10 degrees lightly curved, 18.5 x 5 mm cup, 7-1/4" (18.5 cm)

BEYER RONGEURS



KM47520

KM47520

KM47522

Curved, 7" (18 cm).

CATALOG #	DESCRIPTION
KM47520	3 x 14 mm bite
KM47522	4 x 15 mm bite

RONGEURS

Double Action Design

RUSKIN RONGEURS



6" (15.5 cm).

CATALOG #	DESCRIPTION
KM47523	Straight, 2 x 14 mm bite
KM47532	Straight, 3 x 15 mm bite
KM47533	Curved, 2 x 15 mm bite
KM47534	Curved, 3 x 15 mm bite



KM47523

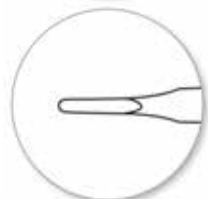

KM47523



KM47533



KM47532



KM47534

RUSKIN RONGEURS



7-1/4" (18.5 cm).

CATALOG #	DESCRIPTION
KM47526	Straight, 4 x 16 mm bite
KM47528	Straight, 6 x 16 mm bite
KM47531	Curved, 6 x 16 mm bite



KM47528

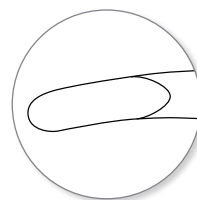

KM47531

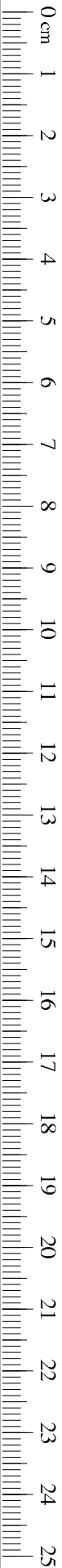

RONGEURS

Double Action Design

RUSKIN RONGEUR

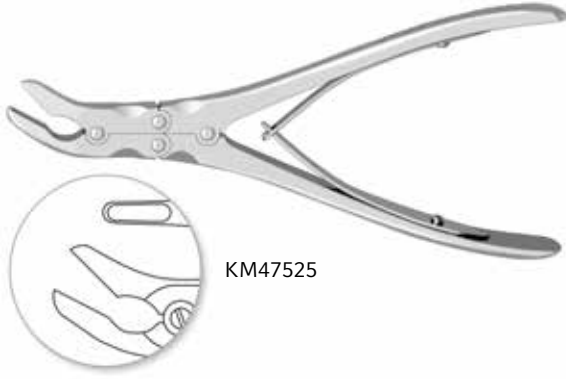

KM47525

CATALOG #	DESCRIPTION
KM47525	Curved, 5 x 10 mm bite, 7-1/4" (18.5 cm)

PILLING® RUSKIN RONGEUR



341836

CATALOG #	DESCRIPTION
341836	Double action, curved, 4 mm bite, 6-1/8" (15.5 cm)

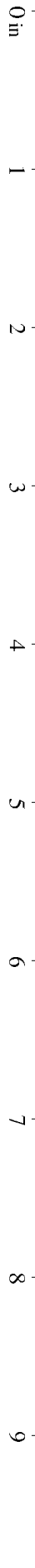

RONGEURS

Double Action Design

ZAUFAL-JANSEN RONGEUR



KM47524

CATALOG #	DESCRIPTION
KM47524	Curved, 5 x 15 mm bite, 7" (18 cm)

SMITH-PETERSON LAMINECTOMY RONGEUR



386152

CATALOG #	DESCRIPTION
386152	Double action, curved 15 degrees, 7-1/2" (19 cm)



RONGEURS

Double Action Design

SMITH-PETERSON LAMINECTOMY RONGEURS

3 x 16 mm bite, 9-1/2" (24 cm).

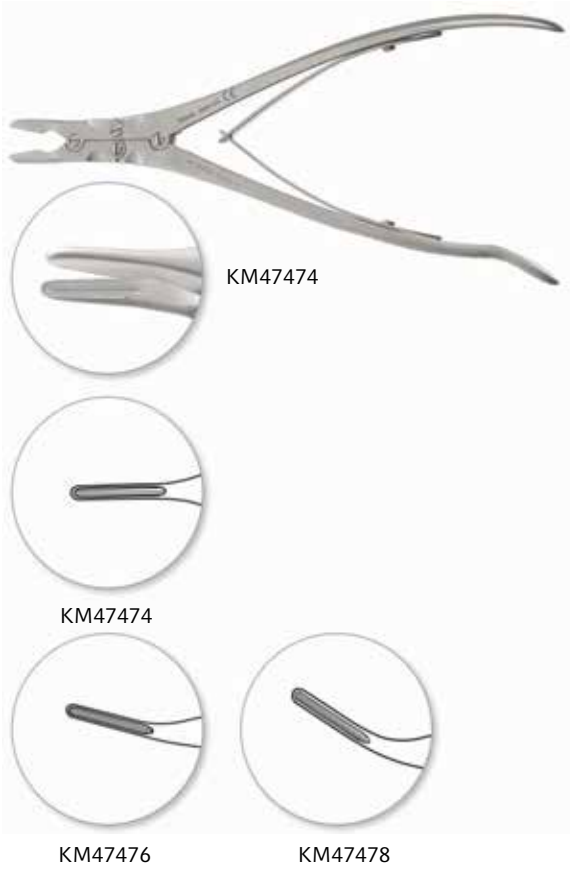

CATALOG #	DESCRIPTION
KM47474	Straight
KM47476	Curved
KM47478	Full curved

RONGEURS

Double Action Design

LEKSELL RONGEURS



Curved 15 degrees, 9" (23 cm).

CATALOG #	DESCRIPTION
KM47492	3 x 16 mm bite
KM47486	4.5 x 16 mm bite
KM47487	5 x 16 mm bite
KM47488	6 x 16 mm bite
KM47489	7 x 16 mm bite
KM47490	8 x 16 mm bite



KM47488



KM47492



KM47486



KM47487



KM47488



KM47489



KM47490



RONGEURS

Double Action Design

LEKSELL RONGEURS



Curved 50 degrees, 9-1/2" (24 cm).

CATALOG #	DESCRIPTION
KM47494	3 x 13 mm bite
KM47495	4 x 13 mm bite
KM47497	5 x 13 mm bite
KM47498	6 x 13 mm bite
KM47499	7 x 13 mm bite
KM47496	8 x 16 mm bite

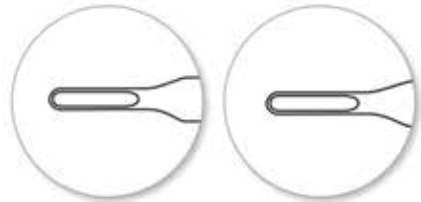

KM47494

KM47495

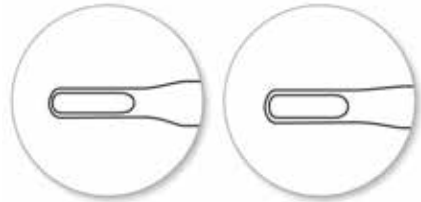

KM47497

KM47498

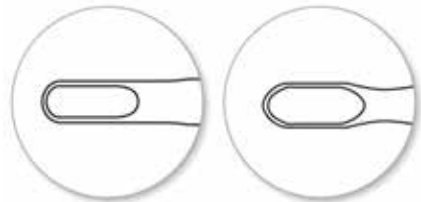

KM47499

KM47496

RONGEURS

Double Action Design

ECHLIN DUCKBILL RONGEURS

Curved on side, 9" (23 cm).

CATALOG #	DESCRIPTION
KM47480	2 x 12 mm bite
KM47482	3 x 12 mm bite
KM47484	4 x 12 mm bite

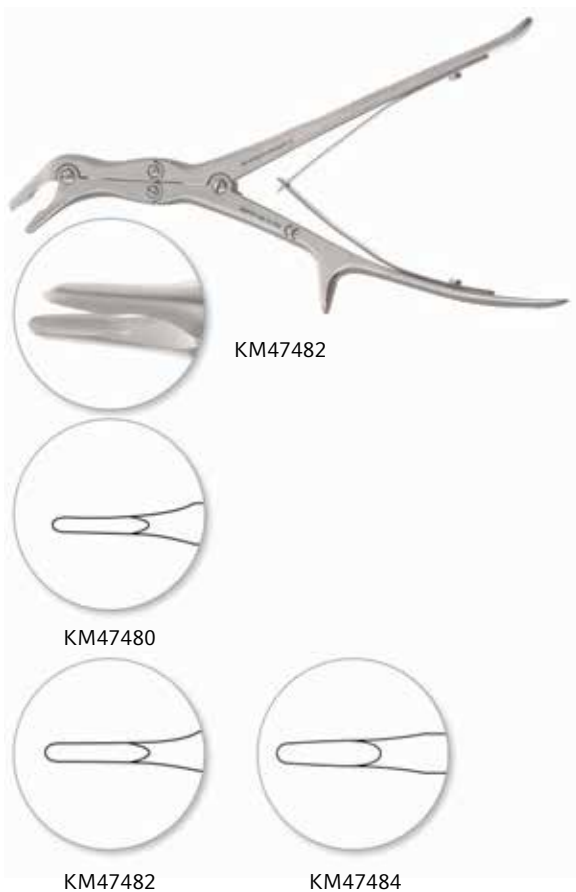

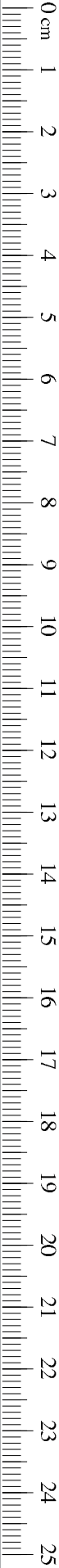

RONGEURS

Double Action Design

STILLE-LUER ECHLIN DUCKBILL RONGEURS



Curved on side, 9" (23 cm).

CATALOG #	DESCRIPTION
KM47472	6 x 13 mm bite
KM47473	6 x 15 mm bite

RONGEURS

Double Action Design

STILLE-LEUR RONGEURS



KM47458

CATALOG #	DESCRIPTION
KM47458	Straight, 10 x 18 mm, 8-1/2" (21.5 cm)
KM47462	Straight, 10 x 18 mm, 10-1/2" (26.5 cm)
KM47460	Curved, 10 x 18 mm, 8-3/8" (21 cm)
KM47464	Curved, 10 x 18 mm, 10-1/2" (26.5 cm)
KM47461	Curved on side, 10 x 16 mm, 8-1/2" (21.5 cm)

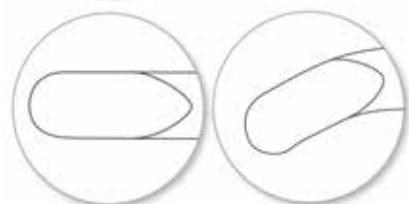

KM47458
KM47462

KM47460
KM47464

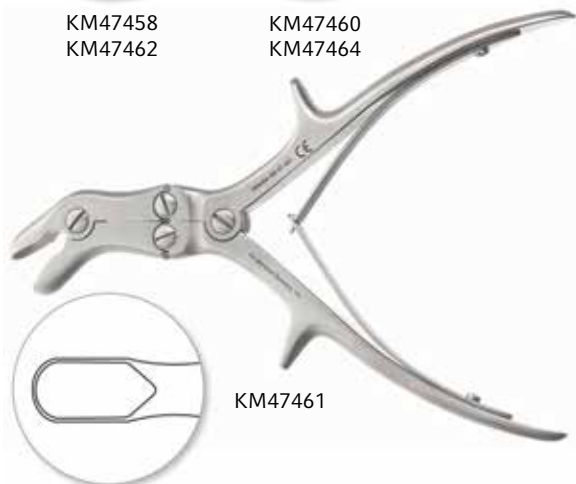

KM47461

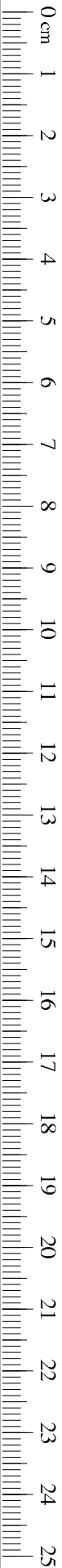

RONGEURS

Double Action Design

SYPERT RONGEURS

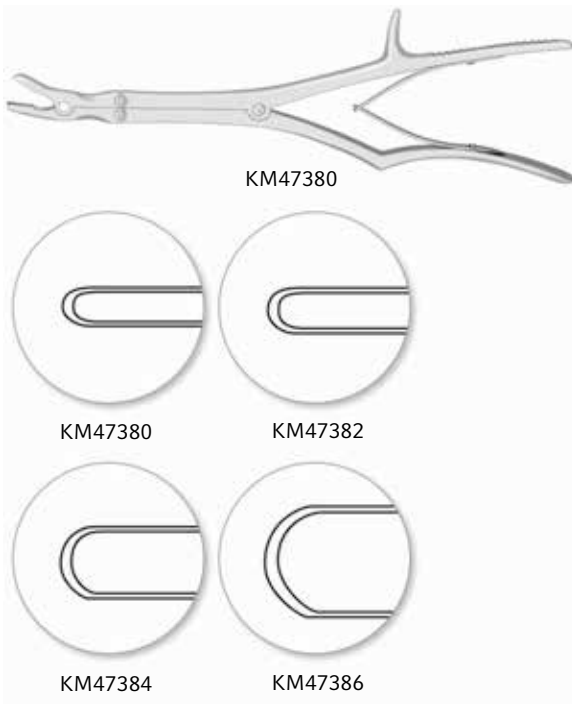

14" (35.5 cm).

CATALOG #	DESCRIPTION
KM47380	4 x 16 mm
KM47382	5 x 16 mm
KM47384	8 x 16 mm
KM47386	12 x 16 mm

KMEDIC® SPINAL RONGEURS AND PUNCHES

SHAFT LENGTH *measured in closed position*



IDENTIFICATION CHART

BITE STYLES *punch jaws, thin footplate*

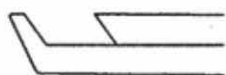

Forward 40°

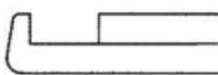

Up 90°

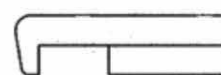

Down 90°

BITE STYLES *punch jaws, regular footplate*



Forward 40°

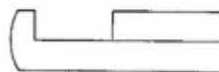

Up 90°



Down 90°

BITE STYLES *cup jaws*



Straight

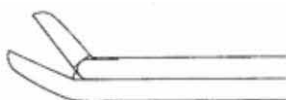

Up



Down

PUNCH JAWS

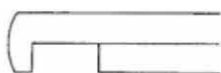

Foot plate

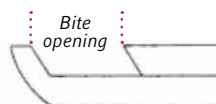

Bite opening

Bite size



Bite size is etched on handles of spinal rongeurs and punches



Handle Styles

STYLE I
Ring Handle
Handle Height 4"



STYLE II
Kerrison Handle
Handle Height 6-1/4"



STYLE III
Love-Kerrison Handle
(Cherry)
Handle Height 6"



STYLE IV
Large Kerrison Handle
Handle Height 6-1/4"



STYLE V
Small Kerrison Handle
Handle Height 5"



STYLE VI
Ferris-Smith
Kerrison Ring Handle
Handle Height 5"



STYLE VII
Spurling Kerrison Handle
Handle Height 4-3/4"
Wider grip improves
comfort and control.



STYLE VIII
Medium Kerrison Handle
Handle Height 5-1/4"



All KMedic® Spinal Rongeurs and Punches have bite size etched on handles for easy identification

KMEDIC® CLEANPUNCH® RONGEUR

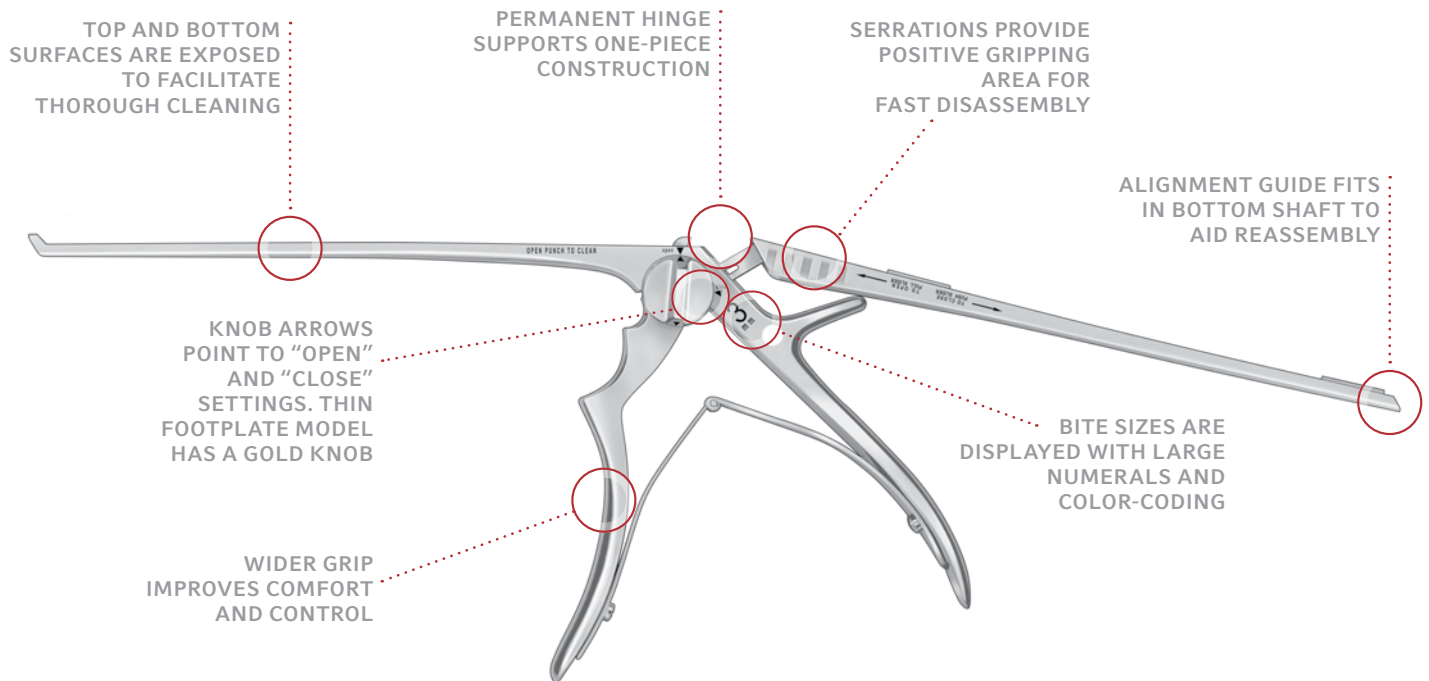

FEATURES AND BENEFITS:

- Patented design enables the instrument to be completely cleaned, eliminating the "buildup" of bone, tissue and fluids that cause sticking and resistance to action.
- Provides a consistently smooth cutting action.
- Eliminates distractions that interrupt a surgeon's concentration required in delicate spinal procedures.
- Instant identification enables surgeons to quickly locate the right bite size. Large, legible mm sizes are etched on handles, as well as color coded.

COLOR-CODED FOR INSTANT BITE SIZE RECOGNITION

- 1 mm – Red
- 2 mm – Blue
- 3 mm – Yellow
- 4 mm – Black
- 5 mm – Green
- 6 mm – White

HANDLING THE KMEDIC® CLEANPUNCH® RONGEUR TO OPEN:

1. Hold punch in left hand. Turn knob to "open" position (align arrows).
2. Push knob up with left thumb. Grip top slider on serrations with right hand and pull back.
3. Clean interior surfaces.

TO CLOSE:

1. Put knob in "open" position.
2. Align guides on top slider.
3. Push top slider forward until it clicks into place.
4. Turn knob to "close" position.
5. Test for proper functioning

RONGEURS

Kerrison Rongeurs — CleanPunch® 2

KERRISON CLEANPUNCH® 2 LAMINECTOMY RONGEURS



Handle style VII, thin footplate, 7" (18 cm).

CATALOG #	BITE	SIZE
KM59300	Forward	1 mm
KM59303	Forward	2 mm
KM59306	Forward	3 mm
KM59309	Forward	4 mm
KM59312	Forward	5 mm

KERRISON CLEANPUNCH® 2 LAMINECTOMY RONGEURS



Handle style VII, thin footplate, 8" (20.5 cm).

CATALOG #	BITE	SIZE
KM59313	Forward	1 mm
KM59315	Forward	2 mm
KM59316	Forward	3 mm
KM59321	Forward	4 mm
KM59322	Forward	5 mm

CLEANPUNCH® CLEANING SYSTEM



- Holds six CleanPunches in open position for maximum exposure during cleaning.
- Lightweight anodized aluminum construction.
- Minimize footprint – compact design has removable lid that fits under rack.
- When open, instrument handles are exposed for quick identification and easy access in the OR.
- Silicone-coated brackets prevent metal to metal contact.
- Protects sharp cutting edge during cleaning.
- Fits inside a standard container or can be wrapped separately.

KM59200

CATALOG #	DESCRIPTION
KM59200	Approximately 13-1/2" x 7" x 6"



RONGEURS

Kerrison Rongeurs — Thin Footplate Design

CERVICAL KERRISON THIN FOOTPLATE RONGEURS



KM55895



Forward 40°
Thin Footplate



Up 90°
Thin Footplate



Down 90°
Thin Footplate



1 mm



2 mm



3 mm



4 mm



5 mm

- Thin footplate designed specifically for small bone in the cervical area.
- Gold hexagonal screw denotes thin footplate.
- Bite size etched on handle for quick identification.
- Care should be taken when using delicate thin footplate punches.
- Do not twist or pry instrument while cutting
- Do not use on large bones.

See the Instructions For Use for all instructions and contraindications.

Handle style VII, thin footplate.

CATALOG #	BITE	SIZE	OVERALL LENGTH
KM55891	Forward	1 mm	6" (15 cm)
KM55892	Forward	2 mm	6" (15 cm)
KM55895	Forward	3 mm	6" (15 cm)
KM55898	Forward	4 mm	6" (15 cm)
KM55901	Forward	5 mm	6" (15 cm)
KM55904	Forward	1 mm	7" (18 cm)
KM55908	Forward	2 mm	7" (18 cm)
KM55911	Forward	3 mm	7" (18 cm)
KM55914	Forward	4 mm	7" (18 cm)
KM55917	Forward	5 mm	7" (18 cm)
KM55925	Forward	1 mm	8" (20.5 cm)
KM55926	Forward	2 mm	8" (20.5 cm)
KM55927	Forward	3 mm	8" (20.5 cm)
KM55928	Forward	4 mm	8" (20.5 cm)
KM55929	Forward	5 mm	8" (20.5 cm)
KM55905	Up	1 mm	7" (18 cm)
KM55909	Up	2 mm	7" (18 cm)
KM55912	Up	3 mm	7" (18 cm)
KM55915	Up	4 mm	7" (18 cm)
KM55918	Up	5 mm	7" (18 cm)
KM55906	Down	1 mm	7" (18 cm)
KM55910	Down	2 mm	7" (18 cm)
KM55913	Down	3 mm	7" (18 cm)
KM55916	Down	4 mm	7" (18 cm)
KM55919	Down	5 mm	7" (18 cm)

RONGEURS

Kerrison Rongeurs — Standard Design

LOVE-KERRISON LAMINECTOMY PUNCHES



Handle style IV, large handle, regular footplate.

CATALOG #	BITE	SIZE	OVERALL LENGTH
KM47676	Forward	2 mm	8" (20.5 cm)
KM47670	Forward	3 mm	6" (15 cm)
KM47671	Forward	3 mm	7" (18 cm)
KM47678	Forward	3 mm	8" (20.5 cm)
KM47680	Forward	4 mm	8" (20.5 cm)
KM47674	Forward	5 mm	6" (15 cm)
KM47682	Forward	5 mm	8" (20.5 cm)
KM47689	Forward	6 mm	11" (28 cm)





RONGEURS

Kerrison Rongeurs — Standard Design

LOVE-KERRISON LAMINECTOMY PUNCHES



Handle style IV, large handle, regular footplate.

CATALOG #	BITE	SIZE	OVERALL LENGTH
KM47644	Up	3 mm	6" (15 cm)
KM47645	Up	4 mm	6" (15 cm)
KM47646	Up	5 mm	6" (15 cm)
KM47648	Down	3 mm	6" (15 cm)
KM47649	Down	4 mm	6" (15 cm)
KM47650	Down	5 mm	6" (15 cm)

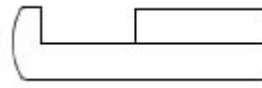

Up 90° Regular Footplate

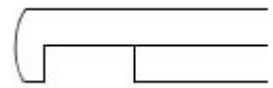

Down 90° Regular Footplate

RONGEURS

Kerrison Rongeurs — Standard Design

LOVE-KERRISON RONGEURS



KM47622

Handle style II, large handle, regular footplate, 8" (20.5 cm).

CATALOG #	BITE	SIZE
KM47620	Forward	1 mm
KM47621	Forward	2 mm
KM47622	Forward	3 mm
KM47623	Forward	4 mm
KM47624	Forward	5 mm

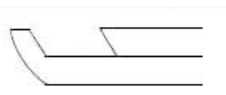

Forward 40° Regular Footplate





RONGEURS

Kerrison Rongeurs — Standard Design

LOVE-KERRISON LAMINECTOMY PUNCHES



KM47644

Handle style IV, large handle, regular footplate.

CATALOG #	BITE	SIZE	OVERALL LENGTH
KM47644	Up	3 mm	6" (15 cm)
KM47645	Up	4 mm	6" (15 cm)
KM47646	Up	5 mm	6" (15 cm)
KM47648	Down	3 mm	6" (15 cm)
KM47649	Down	4 mm	6" (15 cm)
KM47650	Down	5 mm	6" (15 cm)
KM47652	Up	3 mm	8" (20.5 cm)
KM47853	Up	4 mm	8" (20.5 cm)
KM47654	Up	5 mm	8" (20.5 cm)
KM47656	Down	3 mm	8" (20.5 cm)
KM47657	Down	4 mm	8" (20.5 cm)
KM47658	Down	5 mm	8" (20.5 cm)



KM47648

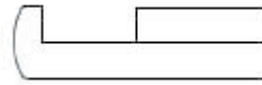

Up 90° Regular Footplate

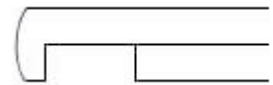

Down 90° Regular Footplate



SPURLING-KERRISON PUNCHES



KM55871

Handle style IV, regular footplate, 8" (20.5 cm).

CATALOG #	BITE	SIZE
KM55870	Forward	3 mm
KM55871	Forward	4 mm
KM55872	Forward	5 mm



Forward 40° Regular Footplate



RONGEURS

Kerrison Rongeurs — Standard Design

SPURLING-KERRISON PUNCHES



Compact handle design to accommodate smaller hands. Handle style V, regular footplate.

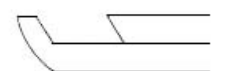

Forward 40° Regular Footplate

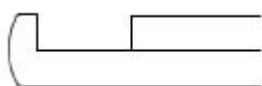

Up 90° Regular Footplate

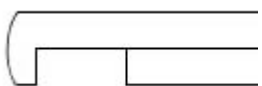

Down 90° Regular Footplate



CATALOG #	BITE	SIZE	OVERALL LENGTH
KM47879	Forward	1 mm	7" (18 cm)
KM47996	Forward	2 mm	7" (18 cm)
KM48024	Forward	2 mm	8" (20.5 cm)
KM47685	Forward	2 mm	11" (28 cm)
KM47997	Forward	3 mm	7" (18 cm)
KM48025	Forward	3 mm	8" (20.5 cm)
KM47686	Forward	3 mm	11" (28 cm)
KM47998	Forward	4 mm	7" (18 cm)
KM48026	Forward	4 mm	8" (20.5 cm)
KM47687	Forward	4 mm	11" (28 cm)
KM47999	Forward	5 mm	7" (18 cm)
KM48027	Forward	5 mm	8" (20.5 cm)
KM47688	Forward	5 mm	11" (28 cm)
KM47855	Forward	6 mm	7" (18 cm)
KM48028	Forward	6 mm	8" (20.5 cm)
KM48029	Forward	6 mm	11" (28 cm)
KM47988	Up	2 mm	7" (18 cm)
KM48016	Up	2 mm	8" (20.5 cm)
KM47989	Up	3 mm	7" (18 cm)
KM48017	Up	3 mm	8" (20.5 cm)
KM47990	Up	4 mm	7" (18 cm)
KM48018	Up	4 mm	8" (20.5 cm)
KM47991	Up	5 mm	7" (18 cm)
KM48019	Up	5 mm	8" (20.5 cm)
KM47857	Up	6 mm	7" (18 cm)
KM47992	Down	2 mm	7" (18 cm)
KM48020	Down	2 mm	8" (20.5 cm)
KM47993	Down	3 mm	7" (18 cm)
KM48021	Down	3 mm	8" (20.5 cm)
KM47994	Down	4 mm	7" (18 cm)
KM48022	Down	4 mm	8" (20.5 cm)
KM47995	Down	5 mm	7" (18 cm)
KM48023	Down	5 mm	8" (20.5 cm)
KM47856	Down	6 mm	7" (18 cm)



RONGEURS

Kerrison Rongeurs — Standard Design

SCHLESINGER CERVICAL LAMINECTOMY RONGEURS



KM47612

Handle style IV, large handle, regular footplate, 6" (15 cm).

CATALOG #	BITE	SIZE
KM47610	Up	3 mm
KM47612	Up	5 mm
KM47614	Down	3 mm
KM47616	Down	5 mm

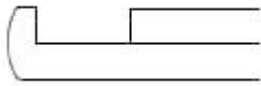

Up 90° Regular Footplate

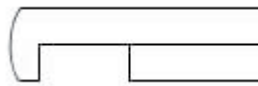

Down 90° Regular Footplate



3 mm



5 mm

FERRIS-SMITH KERRISON RONGEURS



KM48041

Handle style IV, thin footplate, 7" (18 cm).

CATALOG #	BITE	SIZE
KM48041	Down	6 mm



Down 90°
Thin Footplate



6 mm

RONGEURS

Kerrison Rongeurs — Standard Design

FERRIS-SMITH KERRISON RONGEURS



KM48010

Handle style V, regular footplate.

CATALOG #	BITE	SIZE	OVERALL LENGTH
KM48010	Forward	1 mm	6" (15 cm)
KM47987	Up	6 mm	7" (18 cm)

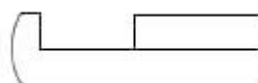

Up 90° Regular Footplate

1 mm

FERRIS-SMITH KERRISON PUNCHES

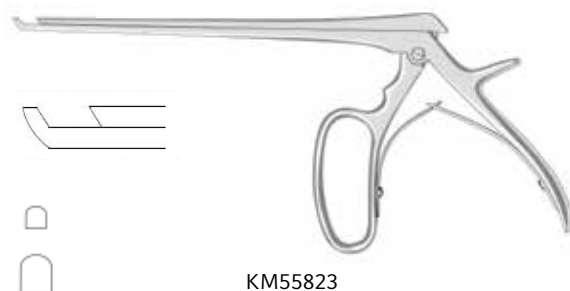

KM55823

Ring handle (handle style VI), regular footplate.

CATALOG #	BITE	SIZE	OVERALL LENGTH
KM55813	Forward	3 mm	7" (18 cm)
KM55823	Forward	3 mm	8" (20.5 cm)
KM55815	Forward	5 mm	7" (18 cm)
KM55825	Forward	5 mm	8" (20.5 cm)

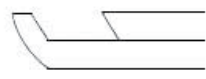

Forward 40° Regular Footplate

3 mm

5 mm



RONGEURS

Kerrison Rongeurs — Standard Design

FERRIS-SMITH ENDOSCOPIC KERRISON RONGEURS



Graduated tip, ring handle, 3-1/4" tip length, .470" shaft diameter, working length 14" (35.5 cm), overall 20" (51 cm).

CATALOG #	BITE	SIZE
KM55788	Forward	2.5 mm
KM55790	Forward	4 mm
KM55782	Down	4 mm

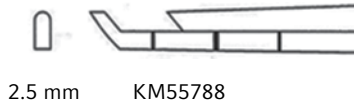

2.5 mm KM55788

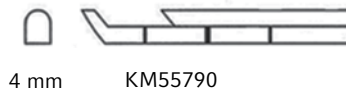

4 mm KM55790

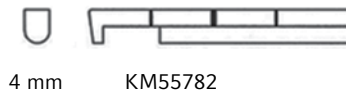

4 mm KM55782

KERRISON RONGEUR



CATALOG #	BITE	SIZE	OVERALL LENGTH
411625	Up	3 mm	3-1/2" (9 cm)

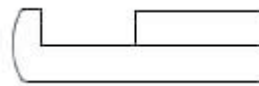

Up 90° Regular Footplate



3 mm

411625

RONGEURS

Kerrison Rongeurs — Standard Design

KERRISON MULTI-BITE PUNCHES



Fenestrated upper shaft ejects cut pieces of bone and tissue. Delicate, thin footplate, for cervical use only, 7" (18 cm).

CATALOG #	BITE	SIZE
KM55980	Up, fenestrated	2 mm
KM55981	Up, fenestrated	3 mm



Up 90°
Thin Footplate



2 mm



3 mm

MOORELAND RONGEUR



CATALOG #	DESCRIPTION
KM47850	5 x 15 mm, 13-3/4" (35 cm)

FORAMINOTOMY PUNCHES



Handle style V, regular footplate, 8" (20.5 cm).

CATALOG #	BITE	SIZE
KM48030	Curved up	2 mm
KM48033	Curved up	3 mm
KM48032	Curved up	4 mm



2 mm



3 mm



4 mm



RONGEURS

IVD Rongeurs

DECKER IVD RONGEUR



CATALOG #	BITE	SIZE	OVERALL LENGTH
KM55858	Straight	2 x 6 mm	6" (15 cm)

PEAPOD IVD RONGEUR



CATALOG #	BITE	SIZE	OVERALL LENGTH
KM55842	Up angle	2 x 6 mm	5-1/2" (14 cm)

SELVERSTONE IVD RONGEUR



CATALOG #	BITE	SIZE	OVERALL LENGTH
KM55860	Straight	2 x 3 mm	6" (15 cm)

RONGEURS

IVD Rongeurs

WILDE IVD RONGEURS



KM47708

Fenestrated jaws, straight.

CATALOG #	DESCRIPTION	OVERALL LENGTH
KM47707	Small, 4 x 9 mm bite	5" (12.5 cm)
KM47708	Medium, 5 x 10 mm bite	5" (12.5 cm)
KM47709	Large, 6 x 11 mm bite	5" (12.5 cm)

CUSHING IVD RONGEURS



KM47710

KM47732

CATALOG #	BITE	SIZE	OVERALL LENGTH
KM47710	Straight	2 x 10 mm	5" (12.5 cm)
KM47730	Straight	2 x 10 mm	7" (18 cm)
KM47712	Up angle	2 x 10 mm	5" (12.5 cm)
KM47732	Up angle	2 x 10 mm	7" (18 cm)
KM47714	Down angle	2 x 10 mm	5" (12.5 cm)
KM47734	Down angle	2 x 10 mm	7" (18 cm)

LOVE-GRUENWALD IVD RONGEURS



KM47760

CATALOG #	BITE	SIZE	OVERALL LENGTH
KM47760	Straight	3 x 10 mm	5" (12.5 cm)
KM47780	Straight	3 x 10 mm	7" (18 cm)
KM47762	Up angle	3 x 10 mm	5" (12.5 cm)
KM47782	Up angle	3 x 10 mm	7" (18 cm)
KM47764	Down angle	3 x 10 mm	5" (12.5 cm)
KM47784	Down angle	3 x 10 mm	7" (18 cm)



RONGEURS

IVD Rongeurs

SPURLING IVD RONGEURS



CATALOG #	BITE	SIZE	OVERALL LENGTH
KM47800	Straight	4 x 10 mm	5" (12.5 cm)
KM47840	Straight	4 x 10 mm	7" (18 cm)
KM47802	Up angle	4 x 10 mm	5" (12.5 cm)
KM47842	Up angle	4 x 10 mm	7" (18 cm)
KM47804	Down angle	4 x 10 mm	5" (12.5 cm)
KM47844	Down angle	4 x 10 mm	7" (18 cm)

CASPAR IVD RONGEURS



Fenestrated jaw, serrated cup.

CATALOG #	BITE	SIZE	OVERALL LENGTH
KM55935	Straight	2 x 12 mm	6-1/4" (16 cm)
KM55936	Straight	3 x 12 mm	6-1/4" (16 cm)
KM55937	Straight	4 x 14 mm	6-1/4" (16 cm)
KM55938	Straight	5 x 14 mm	6-1/4" (16 cm)
KM55960	Straight	2 x 12 mm	7-1/4" (18.5 cm)
KM55961	Straight	3 x 12 mm	7-1/4" (18.5 cm)
KM55962	Straight	4 x 14 mm	7-1/4" (18.5 cm)
KM55963	Straight	5 x 14 mm	7-1/4" (18.5 cm)
KM55964	Straight	6 x 16 mm	7-1/4" (18.5 cm)
KM55972	Up angle	3 x 12 mm	7-1/4" (18.5 cm)
KM55973	Up angle	4 x 14 mm	7-1/4" (18.5 cm)
KM55974	Up angle	5 x 14 mm	7-1/4" (18.5 cm)
KM55966	Down angle	3 x 12 mm	7-1/4" (18.5 cm)
KM55967	Down angle	4 x 14 mm	7-1/4" (18.5 cm)



2 x 12 mm

bite straight
KM55935
KM55960

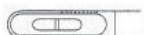

3 x 12 mm

bite straight
KM55936
KM55961



4 x 14 mm

bite straight
KM55937
KM55962



5 x 14 mm

bite straight
KM55938
KM55963



6 x 16 mm

bite straight
KM55964

bite up angle
KM55972

bite up angle
KM55973

bite up angle
KM55974

bite down angle
KM55966

bite down angle
KM55967

RONGEURS

IVD Rongeurs

CASPAR IVD RONGEURS



6" (15 cm).

CATALOG #	BITE	SIZE
KM55946	Straight	2 x 10 mm
KM55947	Straight	3 x 10 mm
KM55948	Straight	4 x 10 mm
KM55949	Straight	5 x 10 mm
KM55952	Up angle	2 x 10 mm
KM55953	Up angle	3 x 10 mm
KM55954	Up angle	4 x 10 mm
KM55940	Down angle	2 x 10 mm
KM55941	Down angle	3 x 10 mm
KM55942	Down angle	4 x 10 mm

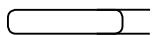

2 x 10 mm

bite straight
KM55946

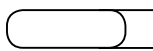

3 x 10 mm

bite straight
KM55947

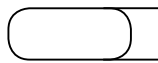

4 x 10 mm

bite straight
KM55948



5 x 10 mm

bite straight
KM55949

bite up angle
KM55952

bite up angle
KM55953

bite up angle
KM55954

bite down angle
KM55940

bite down angle
KM55941

bite down angle
KM55942

SCHLESINGER IVD RONGEURS



Serrated jaws.

CATALOG #	BITE	SIZE	OVERALL LENGTH
KM47700	Straight	2 x 10 mm	6" (15 cm)
KM47702	Straight	3 x 10 mm	6" (15 cm)
KM47704	Straight	4 x 10 mm	6" (15 cm)
KM47703	Up angle	3 x 10 mm	6" (15 cm)

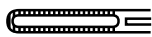

2 x 10 mm

bite straight
KM47700



3 x 10 mm

bite straight
KM47702



4 x 10 mm

bite straight
KM47704

bite up angle
KM47703



RONGEURS

IVD Rongeurs

SCHLESINGER IVD RONGEURS

9" (23 cm).



CATALOG #	BITE	SIZE
KM55690	Straight	3 x 10 mm
KM55691	Straight	5 x 10 mm
KM55693	Up angle	3 x 10 mm
KM55694	Up angle	5 x 10 mm

OLDBERG IVD RONGEUR



CATALOG #	BITE	SIZE	OVERALL LENGTH
KM55856	Round	6 mm	7" (18 cm)

RONGEURS

IVD Rongeurs

FERRIS-SMITH IVD RONGEURS



Ring handle lessens chance of slippage.
Handle style VI, 7" (18 cm) shaft.

CATALOG #	BITE	SIZE
KM47858	Straight	2 x 10 mm
KM47864	Straight	3 x 10 mm
KM47870	Straight	4 x 10 mm
KM47878	Straight	6 x 12 mm
KM47860	Up angle	2 x 10 mm
KM47866	Up angle	3 x 10 mm
KM47872	Up angle	4 x 10 mm
KM47873	Up angle	6 x 12 mm
KM47862	Down angle	2 x 10 mm
KM47868	Down angle	3 x 10 mm
KM47874	Down angle	4 x 10 mm
KM47875	Down angle	6 x 12 mm



2 x 10 mm

bite straight
KM47858

bite up
KM47860

bite down
KM47862



3 x 10 mm

bite straight
KM47864

bite up
KM47866

bite down
KM47868



4 x 10 mm

bite straight
KM47870

bite up
KM47872

bite down
KM47874



6 x 12 mm

bite straight
KM47878

bite up
KM47873

bite down
KM47875

FERRIS-SMITH ENDOSCOPIC IVD RONGEURS

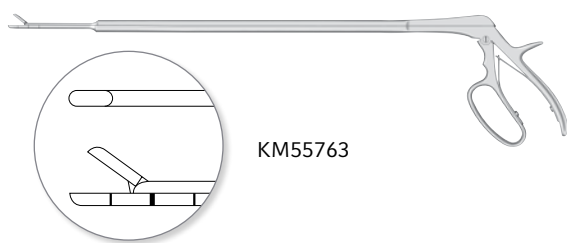

Handle style VI, ring handle, 3-1/4" tip length,
0.470" (12 mm) shaft diameter, 10-3/4" shaft length,
6" handle length, 20" (51 cm).

CATALOG #	BITE	SIZE
KM55762	Straight	2.5 x 10 mm
KM55763	Straight	4 x 10 mm
KM55767	Up angle	4 x 10 mm
KM55777	Straight, serrated	8 x 12 mm

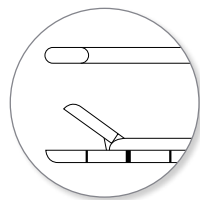

KM55763

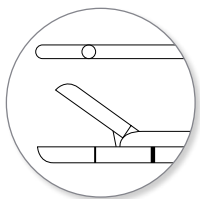

KM55762

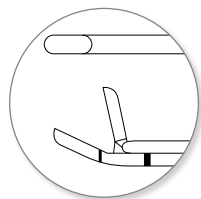

KM55767

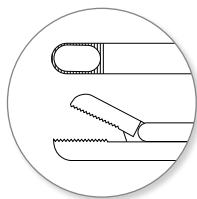

KM55777

TL SPINAL IMPLANT REMOVAL SYSTEM

THORACOLUMBAR SPINAL IMPLANT REMOVAL SET

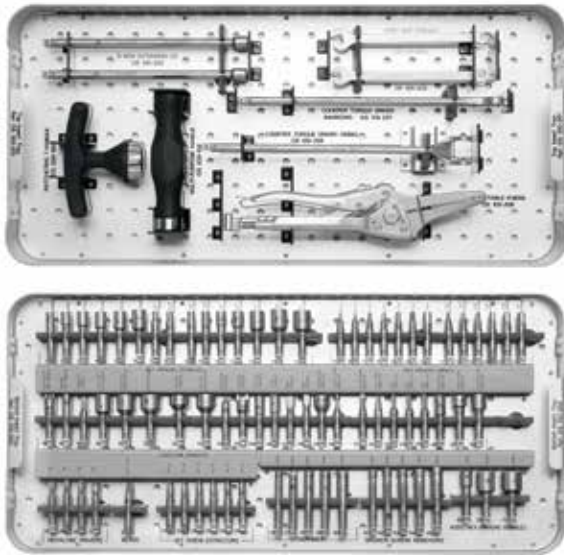

OS100200

The new **OrthoSpecialties by KMedic™ Spinal Implant Removal Set** will satisfy a surgeon's instrument needs when conducting thoracic and lumbar implant revisions.

This set offers a unique combination of implant-specific instruments in one convenient yet comprehensive set, including more than 80 standard drivers, broken screw removers, trephines, and custom bits.

CATALOG #	DESCRIPTION
OS100200	Complete Thoracolumbar Set
OS100199	Case Components Only
CASE COMPONENTS	
OS100201	Upper Tray Insert
OS100202	Bottom Tray Insert
OS100209	Case Lid
OS100210	Case Bottom
GENERAL INSTRUMENTS	
OS100203	8" Extender
OS100204	Open End Wrench, 1/4" & 3/8"
OS100205	Open End Wrench, 7/32" & 9/32"
OS100206	Counter Torque Wrench, Wide
OS100207	Counter Torque Wrench, Narrow
OS100208	Adjustable Needle Nose Pliers
OS200102	Multi-purpose Handle
OS200182	Racheting T-Handle
CUSTOM DRIVERS	
OS100211	Advanced Spine®, Sleeve Nut
OS100212	Advanced Spine®, Anchor Screw
OS100216	Aesculap®, 4-Prong
OS100221	Corin®, 3-Lok
OS100217	Cross®, 13.8 mm Hex
OS100220	Cross®, 2-Prong
OS100218	Cross®, Cap Nut Remover
OS100224	Cross®, External Hex Scr Ext.
OS100219	Cross®, Pentalobe
OS100228	DePuy®, Cam Tightener
OS100225	DePuy®, Dodecagon
OS100293	DePuy®, Isola, Open
OS100294	DePuy®, Isola, Closed
OS100226	DePuy®, Locking & Inner
OS100292	DePuy®, Monarch Pedicle
OS100227	DePuy®, Outer Bone
OS100229	DePuy®, X15, Hexalobe
OS100290	DePuy®, X20 Hexalobe
OS100291	DePuy®, X25 Hexalobe
OS100215	SpineTech®, Octagon
OS100214	Synthes®, 11 mm (12 pt) Hex
HEX DRIVERS-MALE	
OS100230	2.5 mm
OS100231	3.0 mm
OS100232	3.5 mm
OS100234	4.5 mm
OS100235	5.0 mm
OS100236	7.0 mm
OS100237	7/64" (2.78 mm)
OS100238	1/8" (3.18 mm)
OS100239	5/32" (3.97 mm)
OS100240	3/16" (4.76 mm)
OS100241	7/32" (5.56 mm)
OS100242	1/4" (6.35 mm)

TL SPINAL IMPLANT REMOVAL SYSTEM

THORACOLUMBAR SPINAL IMPLANT REMOVAL SET (CONTINUED)

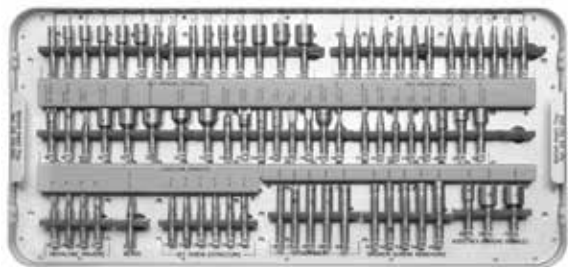
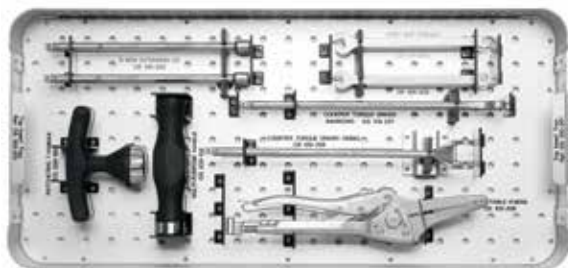

OS100200

CATALOG #	DESCRIPTION
HEX DRIVERS - FEMALE	
OS100250	5.0 mm
OS100251	6.0 mm
OS100252	7.0 mm
OS100295	7.5 mm
OS100253	8.0 mm
OS100254	9.0 mm
OS100255	10.0 mm
OS100296	13.0 mm
OS100297	15.0 mm
OS100256	1/8" (3.18 mm)
OS100257	5/32" (3.97 mm)
OS100258	3/16" (4.76 mm)
OS100259	7/32" (5.56 mm)
OS100260	1/4" (6.35 mm)
OS100261	5/16" (7.94 mm)
OS100262	3/8" (9.53 mm)
OS100263	7/16" (11.11 mm)
OS100264	1/2" (12.70 mm)
STANDARD DRIVERS	
OS100213	Phillips Driver
OS100222	Saddle, 5 mm
OS100223	Saddle, 6 mm
OS100274	Medium Blade
HEXALOBE DRIVERS	
OS100270	T20
OS100271	T25
OS100272	T30
OS100273	T40
SET SCREW EXTRACTORS	
OS100275	For 2.5 mm Hex
OS100276	For 3.0 mm Hex
OS100277	For 3.5 mm Hex
TREPHINES	
OS100280	For 4 mm Screw
OS100281	For 5 mm Screw
OS100282	For 6 mm Screw
OS100283	For 7 mm Screw
OS100284	For 8 mm Screw
BROKEN SCREW REMOVERS	
OS100285	For 4 mm Screw
OS100286	For 5 mm Screw
OS100287	For 6 mm Screw
OS100288	For 7 mm Screw
OS100289	For 8 mm Screw



NAIL INSTRUMENTS

Nail Nippers

TURNBULL NAIL NIPPERS

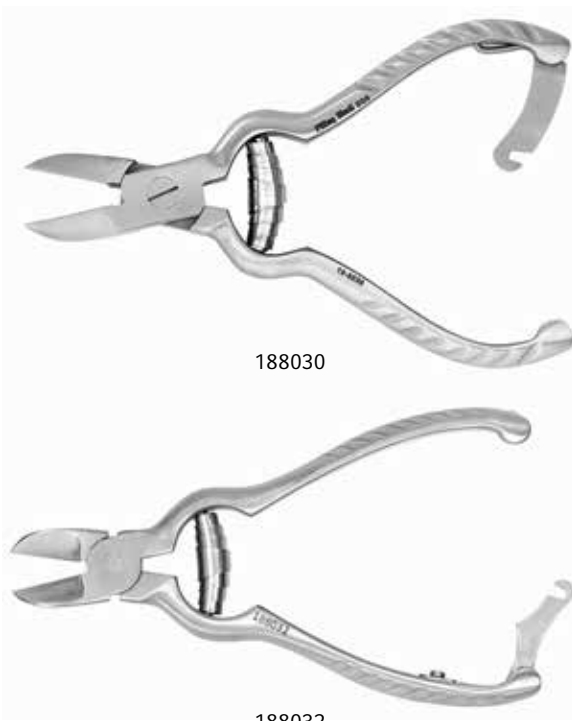

CATALOG #	DESCRIPTION
188030	4-1/2" (11.5 cm)
188032	5-5/8" (14.5 cm)

MYCOTIC NAIL NIPPERS



Double action helps prevent hand fatigue. Ideal for Mycotic and Onychiauxis nails. Stainless, double action, barrel spring, 6" (15.5 cm).

CATALOG #	DESCRIPTION
KM69445	Straight
KM69446	Concave



KM69445

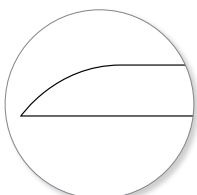

KM69445

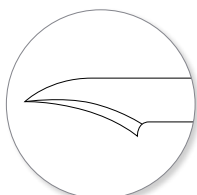

KM69446

NAIL INSTRUMENTS

Nail Nippers

NAIL NIPPERS



Stainless steel. Angled, concave, 5-1/2" (14 cm).

CATALOG #	DESCRIPTION
KM69440	Sharp end
KM69441	Blunt end



KM69440



KM69441

NAIL NIPPERS



Stainless steel, 5-1/2" (14 cm).

CATALOG #	DESCRIPTION
KM69418	Narrow, concave
KM69430	Heavy, concave
KM69432	Heavy, straight
KM69438	Heavy, concave, super size

KM69430

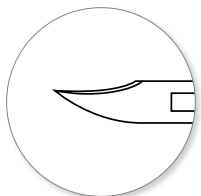

KM69418

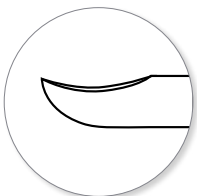

KM69430

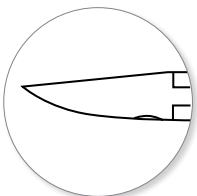

KM69432

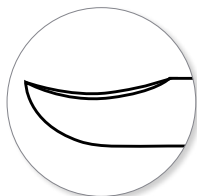

KM69438

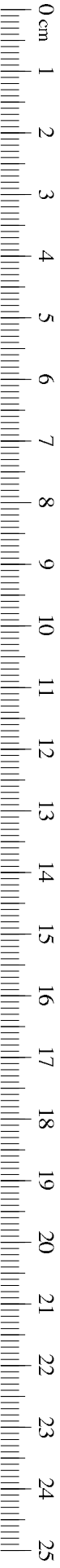

NAIL INSTRUMENTS

Nail Nippers

TISSUE NIPPERS



Stainless steel.

CATALOG #	DESCRIPTION
KM69290	6 mm, 4" (10 cm)
KM69291	9 mm, 4" (10 cm)
KM69292	11 mm, 4-1/2" (11.5 cm)
KM69294	14 mm, 5" (12.5 cm)

Nail Splitters

NAIL SPLITTERS



CATALOG #	DESCRIPTION
KM69557	Small, straight blade, single-ended, 5" (12.5 cm)

NAIL INSTRUMENTS

Nail Splitters

NAIL SPLITTERS



With grooved handles to improve grip.

CATALOG #	DESCRIPTION
KM69320	4" (10 cm)
KM69322	4-1/2" (11.5 cm)
KM69326	Heavy jaw, 5" (12.5 cm)
KM69327	Narrow jaw, 5" (12.5 cm)
KM69340	6" (15 cm)



KM69320



KM69322



KM69326



KM69327



KM69340

NAIL SPLITTERS



Our splitters have the true feel of superb craftsmanship. The cutting edge is expertly ground and specially heat treated. For a sure grip, our stainless splitters come with grooved handles. Stainless steel.

CATALOG #	DESCRIPTION
KM69341	Tapered, 4" (10 cm)
KM69342	Tapered, 4-1/2" (11.5 cm)
KM69343	Tapered, 5" (12.5 cm)
KM69344	Tapered, 6" (15 cm)
KM69448	Delicate, 4-1/2" (11.5 cm)



KM69341



KM69342



KM69343



KM69344



KM69448



NAIL INSTRUMENTS

Nail Splitters

SHORT JAW NAIL SPLITTERS



KM69930

Short jaw design provides increased leverage for easier cutting of thick nails — less strain on hand and splitter. Stainless steel.

CATALOG #	DESCRIPTION
KM69930	Straight, 5" (12.5 cm)
KM69932	Straight, 6" (15 cm)

Nail Forceps

INGROWN NAIL FORCEPS

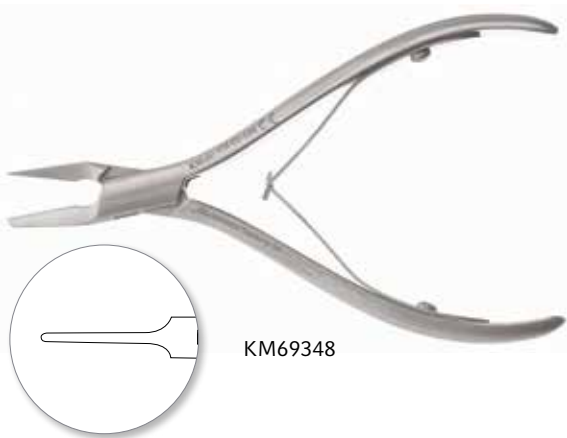

KM69348

Very delicate anvil design slides easily under nails.

CATALOG #	DESCRIPTION
KM69348	Anvil pattern, narrow blade, 5" (12.5 cm)

NAIL INSTRUMENTS

Nail Forceps

PLATYPUS NAIL REMOVING FORCEPS



CATALOG #	DESCRIPTION
KM69792	3 mm, narrow, 5-1/2" (14 cm)
KM69793	6 mm, broad, 5-1/2" (14 cm)

Nail Scissors

INGROWN NAIL INSTRUMENT #81



CATALOG #	DESCRIPTION
KM69595	Single-ended, 5" (12.5 cm)

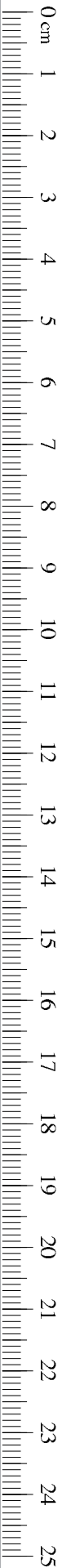

NAIL INSTRUMENTS

Nail Scissors

INGROWN NAIL SPLITTING SCISSORS



KM69805

CATALOG #	DESCRIPTION
KM69805	One serrated blade, 6" (15 cm)

NAIL SCISSORS



KM69106

CATALOG #	DESCRIPTION
KM69106	Curved, 4" (10.5 cm)

BONE SAWS AND KNIVES

GIGLI SAW BLADES



KM46612

For cutting hard bone in difficult areas or situations.

CATALOG #	DESCRIPTION
KM46612	9" (23 cm)
KM46613	12" (30.5 cm)
KM46609	16" (40.5 cm)
KM46614	20" (51 cm)
KM46615	30" (76 cm)
KM46616	Loop-style, 3-1/2" (9 cm) wide, one pair
KM46610	Loop-style with snap lock, 3-3/8" (8.5 cm) wide, one pair
KM46617	T-style, 2-1/2" wide, one pair



KM46616



KM46610



KM46617



BONE SAWS AND KNIVES

RANEY GIGLI SAW GUIDE

CATALOG #	DESCRIPTION
KM46620	Curved tip, straight shaft

CHARRIERE BONE SAWS



KM46683

Stainless steel frame, chrome blades.

CATALOG #	DESCRIPTION
KM46645	10-1/2" (26.5 cm) complete
KM46646	Chrome blade only for KM46645
KM46683	14" (35.5 cm) complete
KM46684	12 mm chrome blade only for KM46683
KM46685	14 mm chrome blade only for KM46683

JOSEPH BONE SAWS



KM58096

7" (19 cm).

CATALOG #	DESCRIPTION
KM58096	Straight
KM58097	Bayonet left
KM58098	Bayonet right

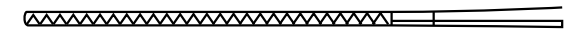

KM58097

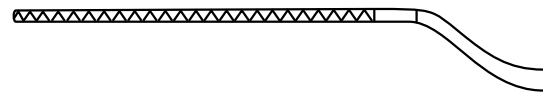

KM58098

LANGENBECK METACARPAL SAW



KM46601

CATALOG #	DESCRIPTION
KM46601	9" (23 cm)

BONE SAWS AND KNIVES

LISTON AMPUTATING KNIVES



KM46598

CATALOG #	DESCRIPTION
KM46598	6-3/4" (17 cm) blade
KM46600	8" (20.5 cm) blade

SATTERLEE BONE SAW



KM46643

CATALOG #	DESCRIPTION
KM46643	Complete with ring handle, 11-1/2" (29 cm)

SATTERLEE SAW BLADES ONLY



KM46642

CATALOG #	DESCRIPTION
KM46642	Blade only for KM46643, 8-3/8" (21.5 cm)
KM46644	Blade only for KM46643



KM46644

PERCY AMPUTATION SHIELD



KM46602

CATALOG #	DESCRIPTION
KM46602	12" (30.5 cm)



PLASTER CAST INSTRUMENTS

BRUNS SHEARS



For heavier plaster.

CATALOG #	DESCRIPTION
KM46090	One blade serrated, 9-3/8" (24 cm)

STILLE PLASTER SHEARS



For cast removal.

CATALOG #	DESCRIPTION
KM46156	15" (38 cm)

PEDIATRIC CAST BREAKER



CATALOG #	DESCRIPTION
KM46188	7" (18 cm)

PLASTER CAST INSTRUMENTS

WOLFF (BOEHLER) CAST BREAKERS

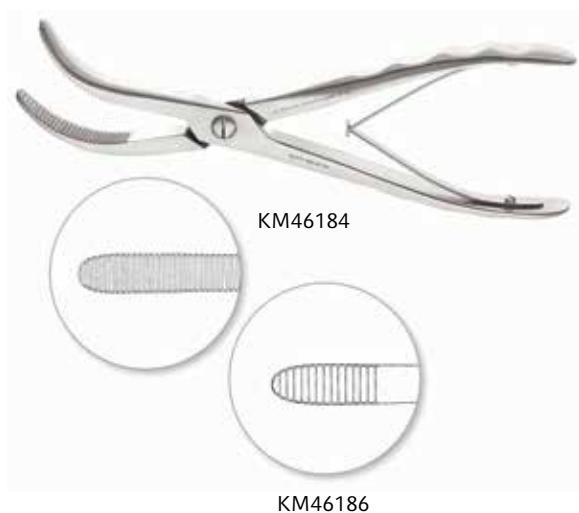

CATALOG #	DESCRIPTION
KM46186	Small, 7" (18 cm)
KM46184	9-7/8" (25 cm)

HENNIG PLASTER SPREADER



To relieve cast pressure or for cast removal.
One-handed operation.

CATALOG #	DESCRIPTION
KM46138	10-5/8" (27 cm)

REINER PLASTER KNIFE



Stainless handle.

CATALOG #	DESCRIPTION
KM46058	7" (18 cm)

PLASTER CAST INSTRUMENTS

KMEDIC® CAST SPREADER



KM46134

To relieve cast pressure or for cast removal.
One-handed operation.

CATALOG #	DESCRIPTION
KM46134	8-7/8" (22.5 cm)

WALTON CAST SPREADER



KM46133

To relieve cast pressure or for cast removal.
One-handed operation.

CATALOG #	DESCRIPTION
KM46133	8-5/8" (22 cm)

ENGEL PLASTER SAW



KM46056

Chrome handle and stainless blade.

CATALOG #	DESCRIPTION
KM46056	6" (15 cm)



MEASURING DEVICES

Rulers

FLEXIBLE RULERS



Inch and millimeter graduated.

KM39694

CATALOG #	DESCRIPTION
KM39692	6" (152 mm)
KM39694	8" (203 mm)
KM39698	12" (305 mm)
KM39700	20" (508 mm)

KUNTSCHER X-RAY SCALE



Ruler for X-rays.

KM48299

CATALOG #	DESCRIPTION
KM48299	Graduated in mm, 19-5/8" (50 cm)

MEASURING DEVICES

Calipers

CASTOVIEJO CALIPER



KM53042

CATALOG #	DESCRIPTION
KM53042	Graduated in mm up to 40 mm, 6-1/2" (16.5 cm)

TOWNLEY FEMUR CALIPER



KM48314

Takes inside and outside measurements up to 4" (10 cm).

CATALOG #	DESCRIPTION
KM48314	4-1/2" (11.5 cm)

NEURO CALIPER



KM48315

Inside measuring faces extra long (60 mm) for neurosurgery. Inside and outside measuring faces and depth bar, stainless steel.

CATALOG #	DESCRIPTION
KM48315	Graduated in inch/mm to 5-3/4" (145 mm), 9" (23 cm)

MEASURING DEVICES

Specialty

BONE COMPASS



KM48302

CATALOG #	DESCRIPTION
KM48302	8" (20.5 cm)

POLK FINGER GONIOMETER



KM48310

CATALOG #	DESCRIPTION
KM48310	Graduated in inch and cm, 6" (15 cm)



SMARTRACKS

CLEANPUNCH® CLEANING SYSTEM



KM59200

- Holds six CleanPunches® in open position for maximum exposure during cleaning.
- Lightweight anodized aluminum construction.
- Minimize footprint – compact design has removable lid that fits under rack.
- When open, instrument handles are exposed for quick identification and easy access in the OR.
- Silicone-coated brackets prevent metal to metal contact.
- Protects sharp cutting edge during cleaning.
- Fits inside a standard container or can be wrapped separately.

CATALOG #	DESCRIPTION
KM59200	Approximately 13-1/2" x 7" x 6"

SMARTRACKS FOR OSTEOTOMES



HOKE SMARTRACK

KM98150

8-1/4" x 5" x 2-1/4"

(21 cm x 12.5 cm x 5.5 cm)

Holds eight 5-1/4" (13.5 cm)

LIGHTWEIGHT RACKS FOR STERILIZATION AND STORAGE

- Nylon coated brackets help avoid metal-to-metal contact.
- Plastic plate on underside of top bracket helps protect sharp tips from being damaged.
- Side arm stays locked to help prevent instruments from falling out, even when turned upside down.
- Deep brackets hold instruments in place.
- Custom designed base keeps instruments upright during loading and unloading
- Reinforced, sturdier frames are made from corrosion-resistant anodized aluminum.
- Fully autoclavable to 270°F/132°C.
- Quick reference chart easily identifies the type and size instrument rack holds.
- Manufactured only by Teleflex®.

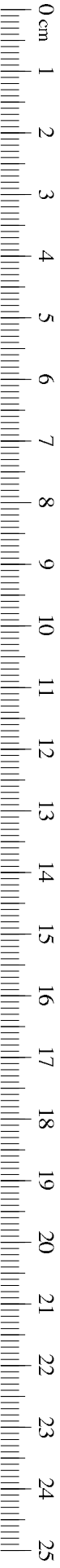

SMARTRACKS

BRUN SMARTRACK FOR 7" CURETTES



KM98160

Aluminum and stainless steel, nylon coated brackets.

CATALOG #	DESCRIPTION
KM98160	Holds 12 7" KMedic® Brun Currettes

COBB SMARTRACK FOR 11" INSTRUMENTS



KM98170

Aluminum and stainless steel, nylon coated brackets.

CATALOG #	DESCRIPTION
KM98170	Holds nine 11" KMedic® Cobb Currettes, Elevators or Gouges

SMARTRACKS

HIBBS AND BRUN SMARTRACK FOR 9" INSTRUMENTS



KM98180

Aluminum and stainless steel, nylon coated brackets.

CATALOG #	DESCRIPTION
KM98180	Holds 12 9" KMedic® Brun Currettes, or Hibbs Chisels, Gouges or Osteotomes

SMARTRACK LAMBOTTE FOR 9" OSTEOTOMES



KM98190

CATALOG #	DESCRIPTION
KM98190	Holds 12 9" (23 cm) KMedic® Lambotte Osteotomes, 11-3/4" x 5-1/2" x 3-3/8" (30 x 8.5 x 14 cm), nylon coated brackets



SMARTRACKS

SMITH PETERSON SMARTRACK



KM98195

Holds 14 8" KMedic® Smith Peterson osteotomes or gouges, nylon coated brackets.

CATALOG #	DESCRIPTION
KM98195	Approximately 11" x 10" x 4" (28 x 25.5 x 10 cm)

MISCELLANEOUS ORTHOPEDIC

Lead Hands

LEAD HANDS



KM49090

Oxidation of lead surfaces is a normal process. To prolong the life of lead hands, autoclave temperatures should not exceed 248° F (120° C). Avoid using chemical sterilization as it can cause severe corrosion.

CATALOG #	DESCRIPTION
KM49090	Adult, 14-1/2" (37 cm)
KM49092	Child, 9-1/2" (24 cm)

LEAD HANDS

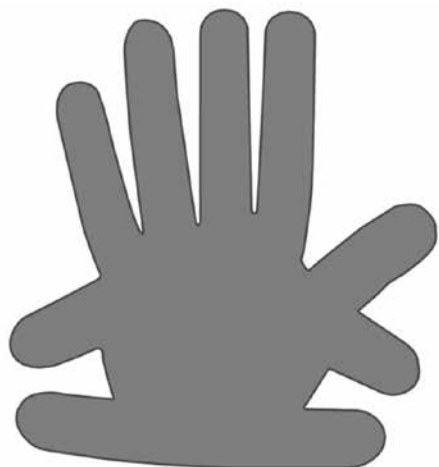

KM49093

Thinner and more flexible model. Longer fingers wrap on ends, eliminating side tabs.

CATALOG #	DESCRIPTION
KM49093	Adult, 2 mm thick, 9-1/2" (24 cm)

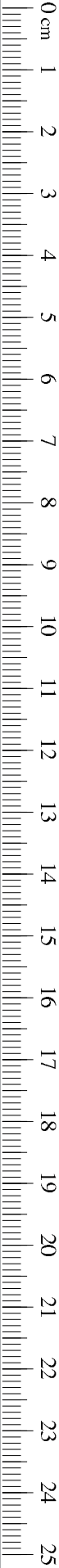

MISCELLANEOUS ORTHOPEDIC

Ring Cutters

FINGER RING CUTTER



KM29430



KM29434

CATALOG #	DESCRIPTION
KM29430	Chrome, with saw blade, 6-1/4" (16 cm)
KM29434	Saw blade only

Diagnostic Instruments

BUCK NEURO HAMMER STAINLESS



KM28492

Stainless steel with brush and needle.

CATALOG #	DESCRIPTION
KM28492	7-3/4" (19.5 cm)

MISCELLANEOUS ORTHOPEDIC

Diagnostic Instruments

TAYLOR PERCUSSION HAMMER



KM28468

CATALOG #	DESCRIPTION
KM28468	8" (20.5 cm)

WARTENBERG NEUROLOGICAL PIN WHEEL



KM28514

CATALOG #	DESCRIPTION
KM28514	7" (18 cm)

Specialty Hand Instruments

JOHNSON-TUCKER HOOK AND FORK



KM69790

CATALOG #	DESCRIPTION
KM69790	Double-ended, delicate, 6-1/2" (16.5 cm)



MISCELLANEOUS ORTHOPEDIC

Specialty Hand Instruments

EXCAVATOR AND PACKER



KM69502

CATALOG #	DESCRIPTION
KM69502	Double-ended

PROBE AND PACKER



KM69495

CATALOG #	DESCRIPTION
KM69495	Double-ended, 1 mm and 2 mm ends, 6" (15 cm)

SPATULA AND PACKER



KM69498

CATALOG #	DESCRIPTION
KM69498	Double-ended, 5-3/4" (14.5 cm)

VERUCCA CURETTE EXCAVATOR



KM69457

With McGlamry Bullneck. Will resist bending

CATALOG #	DESCRIPTION
KM69457	Single-ended, straight, 4 mm without hole, 5" (12.5 cm)

MISCELLANEOUS ORTHOPEDIC

Specialty Hand Instruments

CURETTE EXCAVATORS



KM69488

CATALOG #	DESCRIPTION
KM69488	Double-ended, 1.5 mm and 2.0 mm ends, 5-1/2" (14 cm)
KM69492	Double-ended, 1.5 mm and 2.5 mm ends, 5-1/2" (14 cm)

CURETTE EXCAVATORS



KM69480

Single-ended, with hole, 5" (12.5 cm).

CATALOG #	DESCRIPTION
KM69468	#58, 1.0 mm
KM69478	#58, 1.5 mm
KM69480	#58, 2.0 mm
KM69484	#58, 2.5 mm

CURETTE EXCAVATORS



KM69463

Single-ended, without hole, 5" (12.5 cm).

CATALOG #	DESCRIPTION
KM69459	#57, 1.0 mm
KM69461	#57, 1.5 mm
KM69463	#57, 2.0 mm
KM69465	#57, 2.5 mm



MISCELLANEOUS ORTHOPEDIC

Specialty Hand Instruments

LOCKE ELEVATORS



KM69579

With McGlamry Bullneck. Will resist bending

CATALOG #	DESCRIPTION
KM69579	Narrow blade, single-ended, 4-1/2" (11.5 cm)
KM69590	Wide blade, single-ended, 5" (12.5 cm)

CORN KNIVES



KM69623

Single-ended.



KM69625

CATALOG #	DESCRIPTION
KM69622	Soft Corn Knife, #45, straight, round blade
KM69623	Soft Corn Spoon Knife, slightly curved, oval blade
KM69625	Corn Knife, curved



KM69622

GOLF STICK KNIVES



KM69620

CATALOG #	DESCRIPTION
KM69618	#41
KM69620	#43

MISCELLANEOUS ORTHOPEDIC

Specialty Hand Instruments

CHISELS



CATALOG #	DESCRIPTION
KM69640	Curved, medium
KM69645	Curved, extra-large
KM69650	Curved, spade pattern

WRIST TENDON APPROXIMATOR

CATALOG #
KM52450

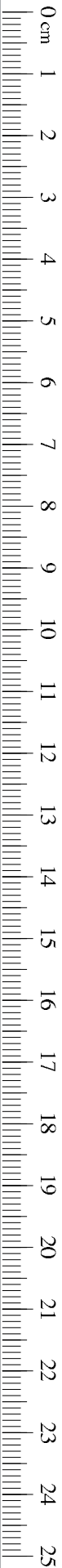

MISCELLANEOUS ORTHOPEDIC

PELVIC BALL SPIKE



KM47906

CATALOG #	DESCRIPTION
KM47906	Straight, 11-3/4" (30 cm)
KM47921	Spiked disk only



KM47921

BONE MILL

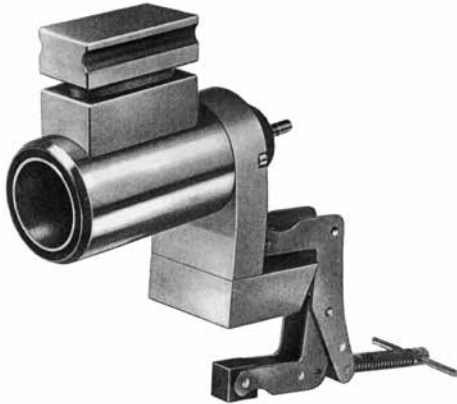

KM98200

CATALOG #	DESCRIPTION
KM98200	With crank and table clamp



MISCELLANEOUS ORTHOPEDIC

KUNTSCHER EXTRACTORS

CATALOG #	DESCRIPTION
KM48288	Femoral, 19-1/8" (48.5 cm)

KUNTSCHER REAMER

CATALOG #	DESCRIPTION
KM48301	Cannulated, 15" (38 cm)

KUNTSCHER SKIN PROTECTOR

CATALOG #	DESCRIPTION
KM48297	6-1/8" (15.5 cm)





OPHTHALMIC INSTRUMENTS

CHAPTER OVERVIEW

Pilling® Ophthalmic Instruments represent a high quality line that offers the precision you require, the quality you demand and the pattern assortments that meet your needs.

Our categories of Ophthalmic instruments include:

- Dressing, Tissue, Jeweler's and Cilia Forceps
- Spring Handle and Ring Handle Scissors
- Barraquer and Castroviejo Needle Holders
- Hooks, Curettes, Probes and Dilators
- Additional patterns are available

Contact your local representative for more information.



FORCEPS

Dressing Forceps

BISHOP-HARMON DRESSING FORCEPS



427392



KM53428

3-3/8" (8.5 cm).

CATALOG #	DESCRIPTION
425350	Extra delicate, serrated, 0.4 mm tip
KM53426	Extra delicate, serrated, 0.7 mm tip
427392	Delicate, cross-serrated, 0.9 mm tip
KM53428	Delicate, serrated, 1 mm tip

DRESSING FORCEPS



427400



427410

Delicate, serrated, 3-7/8" (10 cm).

CATALOG #	DESCRIPTION
427400	Straight tip
427410	Lightly curved tip



FORCEPS

Dressing Forceps

GRAEFE EYE DRESSING FORCEPS



KM53420

CATALOG #	DESCRIPTION
KM53404	Straight, serrated, 0.9 mm tip, 2-7/8" (7 cm)
KM53408	Curved, serrated, 1.2 mm tip, 2-1/2" (6.5 cm)
KM53420	Straight, 1 x 2 teeth, 0.9 mm tip, 2-7/8" (7 cm)
KM53422	Curved, 1 x 2 teeth, 1 mm tip, 2-1/2" (6.5 cm)

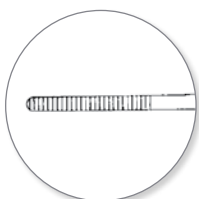

KM53404

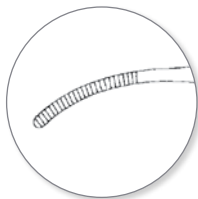

KM53408

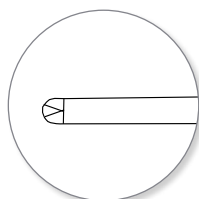

KM53420

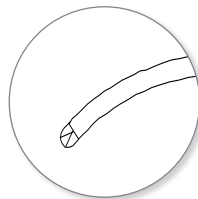

KM53422

FORCEPS

Tissue Forceps

BISHOP-HARMON TISSUE FORCEPS



427390

1 x 2 teeth, 3-3/8" (8.5 cm).

CATALOG #	DESCRIPTION
425360	0.4 mm tip
427390	0.7 mm tip
KM53440	1.0 mm tip

BONN IRIS TISSUE FORCEPS



425390

CATALOG #	DESCRIPTION
425380	Long model, 0.12 mm tip, 2-3/4" (7 cm)
425390	Tying platform, 1 x 2 teeth, 3-3/4" (10 cm)

CASTROVIEJO-COLIBRI TISSUE FORCEPS



425312

CATALOG #	DESCRIPTION
425312	Curved tip, 1 x 2 teeth, 0.12 mm tip, 4-3/8" (11 cm)

COLIBRI CORNEAL TISSUE FORCEPS



425590

CATALOG #	DESCRIPTION
425590	1 x 2 teeth, 0.12 mm tip, 3" (8 cm)



FORCEPS

Tissue Forceps

MCPHERSON TISSUE FORCEPS



425560

CATALOG #	DESCRIPTION
425560	1 x 2 teeth, 3-1/2" (9 cm)

TISSUE FORCEPS



427420

CATALOG #	DESCRIPTION
427420	Straight, delicate, 1 x 2 teeth, 3-7/8" (10 cm)

TROUTMAN-BARRAQUER TISSUE FORCEPS



KM53460

CATALOG #	DESCRIPTION
KM53460	Tying platform, 1 x 2 teeth, 0.3 mm tip, 2-7/8" (7.5 cm)

FORCEPS

Tying Forceps

CASTROVIEJO SUTURE FORCEPS



427370

With tying platform, 1 x 2 teeth, straight, 3-7/8" (10 cm).

CATALOG #	DESCRIPTION
427384	0.12 mm
427370	0.3 mm tip
427382	0.5 mm tip

KELMAN-MCPHERSON FORCEPS



425605

With tying platform, angled.

CATALOG #	DESCRIPTION
425605	3-1/4" (8.5 cm)

MCPHERSON TYING FORCEPS



425200

With tying platform, smooth, 3-1/4" (8.5 cm).

CATALOG #	DESCRIPTION
425200	Straight
425210	Angled



425210

MICRO-TYING FORCEPS



KM44012

With tying platform.

CATALOG #	DESCRIPTION
KM44012	Straight, 0.3 mm tip, 4-3/8" (11 cm)

FORCEPS

Tying Forceps

PLATFORM TYING FORCEPS



With tying platform.

CATALOG #	DESCRIPTION
KM44014	0.7 mm tip, 5-1/2" (14 cm)



KM44014

TENNANT TYING FORCEPS



425190

With tying platform, smooth, round handle, 4" (10 cm).

CATALOG #	DESCRIPTION
425190	Straight
425191	Curved



425191

TEW TYING FORCEPS



With tying platform, straight jaw with longitudinal serrations, 7-1/8" (18 cm).

CATALOG #	DESCRIPTION
394430	0.5 mm tip
394431	1 mm tip



394430





FORCEPS

Jeweler's Forceps

JEWELER'S FORCEPS



425700



425710



425720



425730

CATALOG #	DESCRIPTION
425700	#1, 4-3/4" (12 cm)
425710	#3, 4-3/4" (12 cm)
425720	#3-C, 4-3/8" (11 cm)
425730	#4, 4-1/4" (10.8 cm)
425740	#5, 4-1/4" (10.8 cm)
425750	#7, 4-5/8" (11.5 cm)



425740



425750

FORCEPS

Cilia Forceps

BARRAQUER CILIA AND SUTURE FORCEPS



CATALOG #	DESCRIPTION
KM53580	Smooth platform, 4-1/2" (11.5 cm)



KM53580

BERGH CILIA FORCEPS



CATALOG #	DESCRIPTION
KM53568	Finely serrated, 3-1/2" (9 cm)



KM53568

DOUGLAS CILIA FORCEPS



CATALOG #	DESCRIPTION
KM53560	Finely serrated, 3-1/2" (9 cm)



KM53560

FORCEPS

Cilia Forceps

LITTAUER CILIA FORCEPS



KM53564

CATALOG #	DESCRIPTION
KM53564	Finely serrated, 3-1/2" (9 cm)

ZIEGLER CILIA FORCEPS



KM53574

CATALOG #	DESCRIPTION
KM53574	Smooth, 3-1/2" (9 cm)

Chalazion Forceps

DESMARRES CHALAZION FORCEPS



KM53688

3-1/2" (9 cm).

CATALOG #	DESCRIPTION
KM53686	20 mm wide tip
KM53688	24 mm wide tip
KM53690	30 mm wide tip

FORCEPS

Columella Forceps

COTTLE COLUMELLA FORCEPS



CATALOG #	DESCRIPTION
443480	1/2" (12 mm) tip, 4-3/8" (11 cm)



443480

Fixation Forceps

GRAEFE FIXATION FORCEPS



5 x 6 teeth, 4-1/4" (10.5 cm).

CATALOG #	DESCRIPTION
KM53480	Without catch
KM53484	With catch



KM53480



KM53484

Scleral Forceps

CASTROVIEJO CORNEO-SCLERAL FORCEPS



Tying platform, 1 x 2 teeth, 4-3/8" (11 cm).

CATALOG #	DESCRIPTION
425510	0.12 mm tip
425520	0.3 mm tip
425530	0.5 mm tip

425520

SCISSORS

Spring Handle

CASTROVIEJO KERATOPLASTY SCISSORS



423330

Flat handle, angled 45 degrees, 3-7/8" (10 cm).

CATALOG #	DESCRIPTION
423330	Very delicate, 1.4 mm tip
423340	Blunt tip

CASTROVIEJO KERATOPLASTY MICRO-SCISSORS



423320

Flat handle, angled 45 degrees, 3-7/8" (10 cm).

CATALOG #	DESCRIPTION
423320	Very delicate

CASTROVIEJO SCISSORS



352145

Spring handle for maximum control. Angled 45 degrees.

CATALOG #	DESCRIPTION
352145	9 mm blades, 4-1/8" (10.5 cm)

SCISSORS

Spring Handle

MCCLURE IRIS SCISSORS



Angled on flat for increased control and visibility.

CATALOG #	DESCRIPTION
144295	4-3/4" (12 cm)
352144	12 mm blades, 4-1/2" (11.5 cm)



144295

MICRO-REILL SCISSORS



Flat handle.

CATALOG #	DESCRIPTION
KM44022	Serrated, curved, 5-1/2" (14 cm)



KM44022

MICRO-SPRING SCISSORS



Flat handle, 6" (15 cm).

CATALOG #	DESCRIPTION
KM44253	Straight, 9 mm blades
KM44251	Curved, 9 mm blades
KM44252	Straight, 14 mm blades
KM44250	Curved, 14 mm blades



KM44250

SCISSORS

Spring Handle

FINE STITCH SCISSORS



CATALOG #	DESCRIPTION
423422	4-5/8" (11.5 cm)

VANNAS SCISSORS



Very delicate, flat handle, 3-3/8" (8.5 cm).

CATALOG #	DESCRIPTION
KM44263	Straight
KM44262	Curved
KM44261	Angled
KM44260	Angled on flat



VANNAS CAPSULOTOMY SCISSORS



3-3/8" (8.5 cm).

CATALOG #	DESCRIPTION
423450	Straight
423460	Curved

SCISSORS

Spring Handle

WESTCOTT MICRO-TENOTOMY SCISSORS

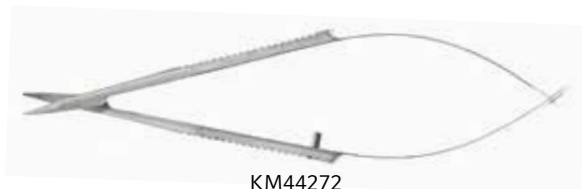

KM44272

Flat handle, 10 mm blade, 4" (10 cm).

CATALOG #	DESCRIPTION
KM44270	Curved, blunt
KM44271	Curved, sharp
KM44272	Straight, blunt
KM44273	Straight, sharp

WESTCOTT STITCH SCISSORS



423410

CATALOG #	DESCRIPTION
423410	4-3/4" (12 cm)

WESTCOTT TENOTOMY SCISSORS



KM44275

Flat handle.

CATALOG #	DESCRIPTION
KM44274	Curved, blunt, 4-3/4" (12 cm)
KM44275	Curved, sharp, 4-3/4" (12 cm)
KM44276	Straight, blunt, 4-3/4" (12 cm)
KM44277	Straight, sharp, 4-3/4" (12 cm)
423480	Curved right, 4-1/2" (11.5 cm)
423490	Curved left, 4-3/4" (12 cm)



423480



SCISSORS

Spring Handle

HEPP-SCHEIDEL DISSECTING SCISSORS



Round handle.

CATALOG #	DESCRIPTION
KM44024	Curved, 5-1/2" (14 cm)



KM44024

DIGITATE-HEIFETZ SCISSORS



066100

CATALOG #	DESCRIPTION
066100	Straight, 5-3/4" (14.5 cm)
066102	Curved, 5-3/4" (14.5 cm)
066104	Straight, 4-3/4" (12 cm)



066102

IRIS SCISSORS WITH BARRAQUER HANDLE



Round handle.

CATALOG #	DESCRIPTION
055502	Curved, 18 mm blades, 5-3/4" (14.5 cm)



055502

SCISSORS

Spring Handle

MICRO-SPRING SCISSORS



KM44018

CATALOG #	DESCRIPTION
KM44018	Straight, 11 mm blade, 5-1/2" (14 cm)
KM44020	Curved, 11 mm blade, 5-1/2" (14 cm)
KM44257	Straight, 9 mm blade, 6" (15 cm)
KM44255	Curved, 9 mm blade, 6" (15 cm)
KM44256	Straight, 14 mm blade, 6" (15 cm)
KM44254	Curved, 14 mm blade, 6" (15 cm)



KM44018



KM44020



KM44255



KM44254

SCISSORS

Ring Handle

MINIATURE EYE SCISSORS



423430

3-1/2" (9 cm).

CATALOG #	DESCRIPTION
423428	Straight
423430	Curved

EYE SCISSORS



423432

Delicate, 4" (10 cm).

CATALOG #	DESCRIPTION
423432	Straight
423434	Curved

EYE SCISSORS



423438

Standard, large rings.

CATALOG #	DESCRIPTION
423438	Curved, 4-1/2" (11.5 cm)



SCISSORS

Ring Handle

GRADLE SCISSORS



Slightly curved, Sharp/Sharp.

CATALOG #	DESCRIPTION
KM53316	3-3/4" (9.5 cm)
KM53318	Ribbon type, 4" (10 cm)

IRIS MINIATURE SCISSORS



Round handle, 15 mm blades, 3-1/2" (9 cm).

CATALOG #	DESCRIPTION
055100	Straight
055102	Curved

SCISSORS

Ring Handle

IRIS RIBBON SCISSORS



KM53267

Slightly curved, Sharp/Sharp.

CATALOG #	DESCRIPTION
KM53265	3-3/4" (9.5 cm)
KM53267	4" (10 cm)

LITTLER DISSECTING SCISSORS



423425

Round handle.

CATALOG #	DESCRIPTION
423425	Curved, 1 mm dia. hole, 4-5/8" (12 cm)

STITCH SCISSORS



423440

Slightly curved, needle points.

CATALOG #	DESCRIPTION
423440	Slightly curved, needle points, 3-3/4" (9.5 cm)

NEEDLE HOLDERS

BARRAQUER NEEDLE HOLDERS



424180

Delicate, 5-1/4" (13 cm).

CATALOG #	DESCRIPTION
424170	Straight, without lock
424180	Curved, with lock
424190	Curved, without lock

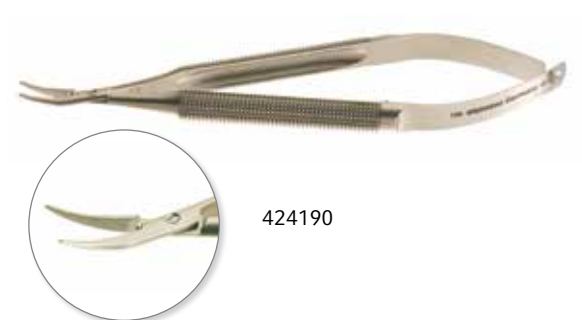

424190

CASTROVIEJO NEEDLE HOLDERS

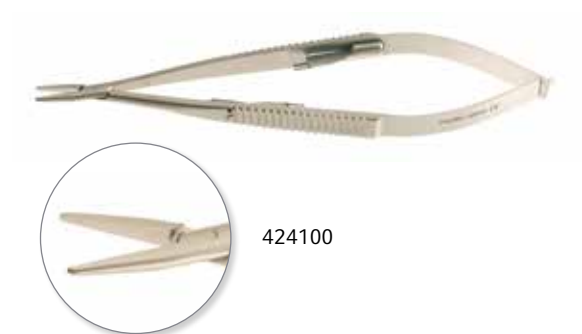

424100

Delicate.

CATALOG #	DESCRIPTION
424100	Straight, with lock, 5-3/4" (14.5 cm)
424102	Straight, without lock, 5-1/4" (13 cm)
424110	Curved, with lock, 5-1/4" (13 cm)

DIGITATE-HEIFETZ NEEDLE HOLDERS



066200

Round handle, 5-7/8" (15 cm).

CATALOG #	DESCRIPTION
066200	Straight, without lock, 0.4 mm
066204	Curved, without lock, 0.6 mm



066204

HOOKS

Strabismus Hooks

GRAEFE STRABISMUS HOOKS

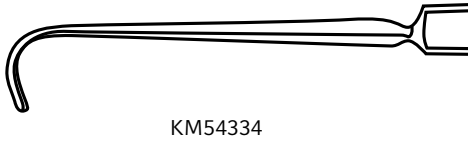
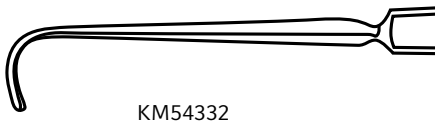
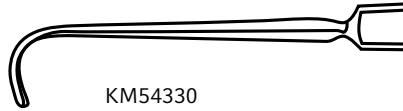
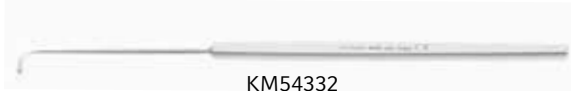

CATALOG #	DESCRIPTION
KM54330	Small, 5-1/8" (13 cm)
KM54332	Medium, 5-1/2" (14 cm)
KM54334	Large, 5-1/2" (14 cm)



HOOKS

Muscle Hooks

JAMESON MUSCLE HOOK



421200

CATALOG #	DESCRIPTION
421200	5-1/4" (13.5 cm)

O'CONNOR HOOK



422250

CATALOG #	DESCRIPTION
422250	4-7/8" (12.5 cm)

VON GRAEFE STRABISMUS HOOKS



422190

CATALOG #	DESCRIPTION
422180	Size 1, 8.5 mm hooks, 5-1/8" (13 cm)
422190	Size 2, 10.5 mm hooks, 5-3/8" (13.5 cm)
422200	Size 3, 12.5 mm hooks, 5-1/2" (14 cm)

CURETTES

MEYHOEFFER CURETTES



KM54309

5" (12.5 cm).

CATALOG #	DESCRIPTION
KM54307	Size 00, 1.0 mm
KM54309	Size 0, 1.5 mm
KM54311	Size 1, 1.7 mm
KM54313	Size 2, 2.0 mm



KM54307



KM54309



KM54311



KM54313

KNIVES

NUCLEUS KNIFE



KM69524

CATALOG #	DESCRIPTION
KM69524	#71, small, 5-1/4" (13.5 cm)

SPECULA

BARRAQUER WIRE SPECULUMS



421512

CATALOG #	DESCRIPTION
421510	Blades 4 mm wide, 1-1/8" (3 cm)
421512	Blades 6 mm wide, 1-5/8" (4 cm)
KM54108	Blades 10 mm wide, 1-3/4" (4.5 cm)

GRAEFE EYE SPECULUM

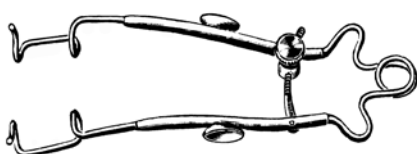

KM54080

CATALOG #	DESCRIPTION
KM54080	3-1/2" (9 cm)

LACRIMAL PROBES/DILATORS

BOWMAN LACRIMAL PROBES



426096

Sterling Silver, 4-7/8" (12.5 cm).

CATALOG #	DESCRIPTION
426090	Size 0000-000
426092	Size 00-0
426094	Size 1-2
426096	Size 3-4
426098	Size 5-6
427002	Size 7-8

WILLIAMS LACRIMAL PROBES



166490

5-1/8" (13 cm).

CATALOG #	DESCRIPTION
166480	Size 1-2
166485	Size 3-4
166490	Size 5-6
166495	Size 7-8

LACRIMAL PROBE

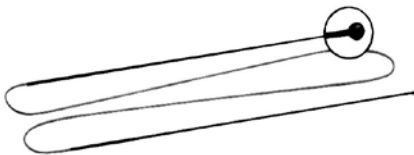

426010

Disposable.

CATALOG #	DESCRIPTION
426010	4-5/8" (11.5 cm)

LACRIMAL PROBES/DILATORS

CASTROVIEJO LACRIMAL DILATOR



426080

CATALOG #	DESCRIPTION
426080	Double-ended, one medium taper and one needle point, 5-1/2" (14 cm)

WILDER LACRIMAL DILATORS



426040

4-3/8" (11 cm).



426050

CATALOG #	DESCRIPTION
426040	Long taper, fine tip
426050	Medium taper, medium tip

EYE SPUDS/NEEDLES

DIX SPUD AND NEEDLE



KM54272

CATALOG #	DESCRIPTION
KM54272	Spud and needle (not pictured) in reversible screw handle

FOREIGN BODY NEEDLES AND SPUDS



KM54280

CATALOG #	DESCRIPTION
KM54280	Needle, 2 x 5 mm blade, 5" (12.5 mm)
KM54282	Davis, 0.8 mm blade, 4-3/4" (12 cm)
KM54284	Ellis, 1.2 mm blade, 4-1/2" (11.5 cm)



KM54284

IRRIGATION CANNULA

LACRIMAL CANNULA



429526



429527

CATALOG #	DESCRIPTION
429526	23 gauge, curved, 1-7/8" (4.8 cm)
429527	23 gauge, straight, 2" (5 cm)

AIR INJECTION CANNULA



429548

5 mm tip angled 45 degrees, 3/4" (2 cm).

CATALOG #	DESCRIPTION
429546	27 Ga.
429548	30 Ga.

HEALON INJECTION CANNULA



429566

CATALOG #	DESCRIPTION
429566	21 Ga., 5 mm tip angled 50 degrees, 1-1/8" (2.9 cm)

SHEPPARD INCISION IRRIGATION CANNULA



428650

Tip angled 45 degrees, 1-3/8" (3.5 cm).

CATALOG #	DESCRIPTION
428655	27 Ga.
428650	30 Ga.

IRRIGATION CANNULA

TROUTMAN ALPHA-CHYMOTRYPSIN CANNULA



429512

CATALOG #	DESCRIPTION
429512	25 Ga., curved tip, 1-3/4" (4.5 cm)

BISHOP HARMON ANTERIOR CHAMBER IRRIGATION CANNULA



429520

CATALOG #	DESCRIPTION
429520	19 Ga., with squeeze bulb and adapter
429534	Silicone squeeze bulb only, 2-1/4" (5.5 cm)
429524	Cannula only, 19 Ga., angled 7 mm, flattened tip
429532	Adapter only, 1-1/8" (3 cm)



CALIPERS

CASTROVIEJO CALIPER



CATALOG #	DESCRIPTION
428630	0-20 mm scale, 3-3/8" (8.5 cm)

CUTTING BLOCK

CUTTING BLOCK



CATALOG #	DESCRIPTION
411331	Made of POM (polyoxymethylene), 3" x 1-1/2" x 3/8" (7.5 x 4 x 1 cm)

EYE SHIELDS

EYE SHIELDS



429340

CATALOG #	DESCRIPTION
429340	Clear, protective, no UV Shielding, 6" (15 cm), 1 dozen

FOX EYE SHIELD WITH GOFFMAN EYE GARTERS



429317

CATALOG #	DESCRIPTION
429317	Fox eye shield and 50 eye garters in assorted colors, 3" (7.5 cm)
KM54668	Eye shield only, 3" x 2-3/8" (7.5 x 6 cm)

UNIVERSAL EYE SHIELD



429318

CATALOG #	DESCRIPTION
429318	20 per pack, 3-1/8" x 2-1/2" (8 x 6.5 cm)





LAPAROSCOPIC INSTRUMENTS

CHAPTER OVERVIEW

Pilling® Laparoscopic Instruments are a high quality line that offer the precision you require, the quality you demand and the pattern assortments that meet your needs.

Our laparoscopic instruments are perfectly suited for a variety of minimally invasive procedures. Optional extended lengths on select patterns provide the access you need for cases where additional reach is required. Teleflex® is now proud to offer six variations of 5 mm Slide Lock Grasper.

PRODUCTS

Pilling® Laparoscopic Quality Instruments for superior access.

Our full line offering of laparoscopic instruments includes the following:

- 100 percent high quality German instruments
- Extensive pattern selection in a variety of sizes and lengths
- Radel insulation
- Large-channel flush ports for thorough cleaning
- Fully rotating instruments have smooth action, great tactile feel and one-finger rotation
- One-piece design



LAPAROSCOPIC INSTRUMENTS

Handle Types

INLINE RATCHETED HANDLE



INSULATED NON-ROTATING HANDLE



INSULATED ROTATING HANDLE



NON-INSULATED NON-ROTATING HANDLE



NON-INSULATED ROTATING HANDLE



RATCHETED NON-ROTATING HANDLE



RATCHETED ROTATING HANDLE



RONGEUR, ERGO GRIP HANDLE



SLIDE-LOCK HANDLE



SPRING-LOADED NON-ROTATING HANDLE



SQUEEZE HANDLE



U-HANDLE



728200 Flush Port Replacement Cap. Fits all handles.

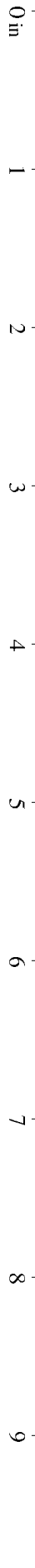

LAPAROSCOPIC INSTRUMENTS

5 MM Dissectors, Grasping Forceps

CLAW GRASPER



728077

Spring-Loaded, Non-Rotating Handle.

CATALOG #	DESCRIPTION
728077	2x3 teeth, 5 mm, 35 cm
728096	2x3 teeth, 10 mm, 35 cm

MARYLAND DISSECTORS



728014

Insulated Handle.

CATALOG #	DESCRIPTION
728012	Non-Rotating, Monopolar, 5 mm, 35 cm
728013	Non-Rotating, Monopolar, 5 mm, 45 cm
728014	Rotating, Monopolar, 5 mm, 35 cm
728015	Rotating, Monopolar, 5 mm, 45 cm
728081	Non-Rotating, Monopolar, 10 mm, 35 cm

TAPERED MARYLAND DISSECTORS



728016

Insulated, Rotating Handle.

CATALOG #	DESCRIPTION
728016	Monopolar, 5 mm, 35 cm

MIXTER DISSECTOR

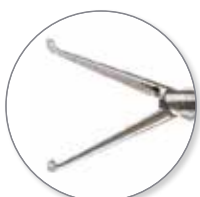

728017

Insulated, Rotating Handle.

CATALOG #	DESCRIPTION
728017	Monopolar, 5 mm, 35 cm

LAPAROSCOPIC INSTRUMENTS

5 MM Dissectors, Grasping Forceps

TAPERED (DOLPHIN NOSE) DISSECTION FORCEPS



728021

Insulated Handle.

CATALOG #	DESCRIPTION
728020	Non-Rotating, Monopolar, 5 mm, 35 cm
728021	Rotating, Monopolar, 5 mm, 35 cm
728022	Rotating, Monopolar, 5 mm, 45 cm

BULLET NOSE DISSECTOR



728023

Insulated, Rotating Handle.

CATALOG #	DESCRIPTION
728023	Monopolar, 5 mm, 35 cm

BLUNT NOSE GRASPER



728026

Insulated Handle.

CATALOG #	DESCRIPTION
728024	Non-Rotating, Monopolar, 5 mm, 35 cm
728025	Non-Rotating, Monopolar, 5 mm, 45 cm
728026	Rotating, Monopolar, 5 mm, 35 cm
728027	Rotating, Monopolar, 5 mm, 45 cm

MICRO DISSECTORS



728029

Insulated Handle.

CATALOG #	DESCRIPTION
728028	Non-Rotating, Monopolar, 5 mm, 35 cm
728029	Rotating, Monopolar, 5 mm, 35 cm

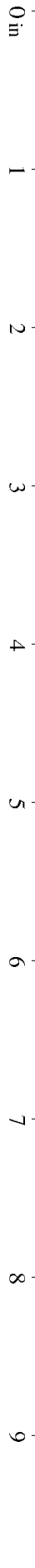

LAPAROSCOPIC INSTRUMENTS

5 MM Dissectors, Grasping Forceps

STRONG GRASPING FORCEPS



728030

Insulated, Non-Rotating Handle.

CATALOG #	DESCRIPTION
728030	Monopolar, 5 mm, 35 cm
728031	Monopolar, 5 mm, 45 cm

BOWEL GRASPER-HUNTER



728032

Non-Insulated, Rotating Handle.

CATALOG #	DESCRIPTION
728032	5 mm, 35 cm
728033	5 mm, 45 cm

LAPAROSCOPIC INSTRUMENTS

10 MM Dissectors

MARYLAND DISSECTORS



728082

Insulated, Rotating Handle.

CATALOG #	DESCRIPTION
728082	Monopolar, 10 mm, 35 cm

MIXTER DISSECTORS



728091

CATALOG #	DESCRIPTION
728090	Insulated, Rotating Handle, Monopolar, 10 mm, 35 cm
728091	Rongeur Ergo Grip Handle, Monopolar, 10 mm, 35 cm

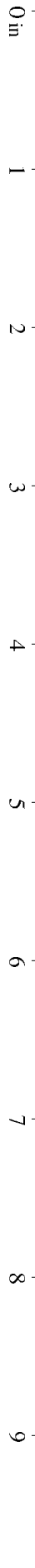

LAPAROSCOPIC INSTRUMENTS

5-10 MM Biopsy Forceps

BIOPSY GRASPERS



728079

Spring-Loaded, Non-Rotating Handle.

CATALOG #	DESCRIPTION
728079	1 x 1 teeth, 5 mm, 35 cm
728080	1 x 1 teeth, 5 mm, 45 cm

SPOON GRASPER



728097

Spring-Loaded, Non-Rotating Handle.

CATALOG #	DESCRIPTION
728097	10 mm, 35 cm

BIOPSY FORCEPS



728034

Insulated, Non-Rotating Handle.

CATALOG #	DESCRIPTION
728034	Oval, Monopolar, 5 mm, 35 cm
728035	Oval, Monopolar, 5 mm, 45 cm

BIOPSY PUNCH FORCEPS



728036

Insulated, Non-Rotating Handle.

CATALOG #	DESCRIPTION
728036	Single Tooth, Monopolar, 5 mm, 35 cm
728037	Single Tooth, Monopolar, 5 mm, 45 cm

LAPAROSCOPIC INSTRUMENTS

5-10 MM Biopsy Forceps

HOOK BIOPSY PUNCH



728038

Insulated, Non-Rotating Handle.

CATALOG #	DESCRIPTION
728038	Monopolar, 5 mm, 35 cm
728039	Monopolar, 5 mm, 45 cm

BIOPSY PUNCH



728040

Insulated, Non-Rotating Handle.

CATALOG #	DESCRIPTION
728040	Monopolar, 5 mm, 35 cm
728041	Monopolar, 5 mm, 45 cm

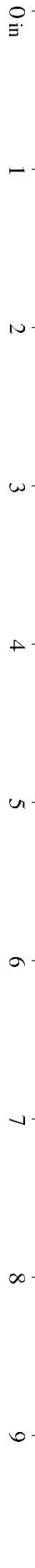

LAPAROSCOPIC INSTRUMENTS

5 MM Bipolar Forceps

MICRO TIP



728098

U-Handle.

CATALOG #	DESCRIPTION
728098	5 mm, 35 cm
728099	5 mm, 45 cm

STANDARD TIP



728100

U-Handle.

CATALOG #	DESCRIPTION
728100	5 mm, 32 cm
728101	5 mm, 45 cm

GRASPING

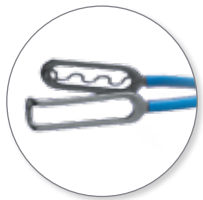

728102

U-Handle.

CATALOG #	DESCRIPTION
728102	5 mm, 32 cm
728103	5 mm, 45 cm

LAPAROSCOPIC INSTRUMENTS

5 MM Ratcheted Graspers

LONG GRASPERS, SINGLE-ACTION

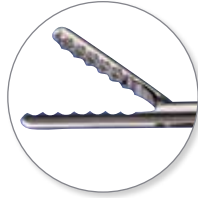

P15128

Slide Lock Handle.

CATALOG #	DESCRIPTION
P15128	Non-Rotating, 5 mm, 36 cm
P30186	Non-Rotating, 5 mm, 45 cm
P35235	Rotating, 5 mm, 36 cm

LONG GRASPERS, DOUBLE-ACTION

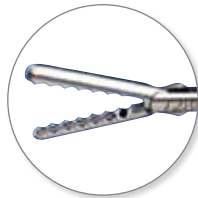

P29862

Slide Lock, Rotating Handle.

CATALOG #	DESCRIPTION
P29862	5 mm, 36 cm

RETRACTION GRASPERS



P29863

Slide Lock Handle.

CATALOG #	DESCRIPTION
P29863	Rotating, Double-Action, 5 mm, 36 cm
P29864	Non-Rotating, Single-Action, 5 mm, 36 cm
P35236	Rotating, Single-Action, 5 mm, 36 cm

RATCHETED GRASPERS

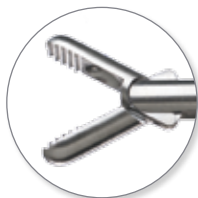

728043

Ratcheted Handle.

CATALOG #	DESCRIPTION
728042	Non-Rotating, Blunt Nose, 5 mm, 35 cm
728043	Rotating, Blunt Nose, Insulated Shaft, 5 mm, 35 cm
728058	Rotating, Heavy-Aggressive, Tungsten Carbide, Monopolar, 5 mm, 35 cm



LAPAROSCOPIC INSTRUMENTS

5 MM Ratcheted Graspers

DUAL CUP GRASPERS

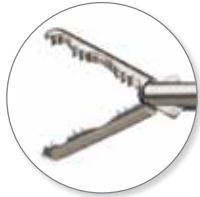

728046

Ratcheted Handle.

CATALOG #	DESCRIPTION
728044	Non-Rotating, 5 mm, 35 cm
728045	Non-Rotating, 5 mm, 45 cm
728046	Rotating, 5 mm, 35 cm
728047	Rotating, 5 mm, 45 cm

GRABBER FENESTRATED FORCEPS



728054

Ratcheted, Rotating Handle.

CATALOG #	DESCRIPTION
728054	5 mm, 37 cm
728057	Long Grasping, Fenestrated, Tungsten Carbide, 5 mm, 35 cm

LONG, DOUBLE-ACTION GRASPERS



728052

Ratcheted, Rotating Handle.

CATALOG #	DESCRIPTION
728052	5 mm, 37 cm
728053	5 mm, 45 cm

LONG, SINGLE-ACTION GRASPERS



728050

Ratcheted, Rotating Handle.

CATALOG #	DESCRIPTION
728050	5 mm, 37 cm
728051	5 mm, 45 cm

LAPAROSCOPIC INSTRUMENTS

5 MM Ratcheted Graspers

RETRACTION GRASPERS



728056

Ratcheted, Rotating Handle.

CATALOG #	DESCRIPTION
728055	Single-Action, 5 mm, 37 cm
728056	Double-Action, 5 mm, 37 cm

SNAKE TOOTH GRASPERS



728059

Ratcheted Handle.

CATALOG #	DESCRIPTION
728059	Non-Rotating, Double-Action, 5 mm, 35 cm
728060	Rotating, Double-Action, 5 mm, 35 cm

STRONG GRASPERS



728061

Ratcheted, Rotating Handle.

CATALOG #	DESCRIPTION
728061	Atraumatic, Fenestrated, 5 mm, 35 cm

ALLIS GRASPERS



728064

Ratcheted Handle.

CATALOG #	DESCRIPTION
728062	Non-Rotating, Insulated Shaft, 5 mm, 35 cm
728063	Non-Rotating, Insulated Shaft, 5 mm, 45 cm
728064	Rotating, Insulated Shaft, 5 mm, 35 cm

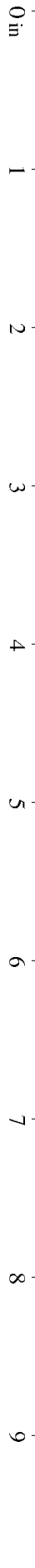

LAPAROSCOPIC INSTRUMENTS

5-10 MM Ratcheted Graspers

ATRAUMATIC ALLIS GRASPERS



728067

Ratcheted Handle.

CATALOG #	DESCRIPTION
728065	Non-Rotating, Insulated Shaft, 5 mm, 35 cm
728066	Non-Rotating, Insulated Shaft, 5 mm, 45 cm
728067	Rotating, Insulated Shaft, 5 mm, 35 cm
728068	Rotating, Insulated Shaft, 5 mm, 37 cm

BABCOCK GRASPERS



728069

Ratcheted Handle.

CATALOG #	DESCRIPTION
728069	Non-Rotating, 5 mm, 35 cm
728070	Non-Rotating, Insulated, 5 mm, 45 cm
728071	Rotating, 5 mm, 35 cm
728072	Rotating, 5 mm, 35 cm
728092	Non-Rotating, 10 mm, 37 cm
728093	Rotating, 10 mm, 37 cm

PADDLE BABCOCK GRASPERS



728073

Ratcheted, Rotating Handle.

CATALOG #	DESCRIPTION
728073	5 mm, 37 cm
728094	10 mm, 37 cm

DEBAKEY GRASPERS



728075

Ratcheted Handle.

CATALOG #	DESCRIPTION
728074	Non-Rotating, Insulated Shaft, 5 mm, 35 cm
728075	Rotating, Insulated Shaft, 5 mm, 35 cm
728076	Rotating, Insulated Shaft, 5 mm, 45 cm

LAPAROSCOPIC INSTRUMENTS

5 MM RATCHETED GRASPERS

TENACULUM GRASPERS

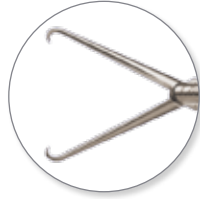

728078

Ratcheted, Non-Rotating Handle.

CATALOG #	DESCRIPTION
728078	5 mm, 35 cm
728095	10 mm, 35 cm

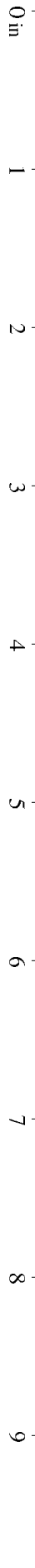

LAPAROSCOPIC INSTRUMENTS

5 MM Needle Holders

TUNGSTEN CARBIDE



728105

Squeeze Handle.

CATALOG #	DESCRIPTION
728104	Straight, 5 mm, 35 cm
728105	Curved, 5 mm, 35 cm
728106	Curved, 5 mm, 45 cm

TUNGSTEN CARBIDE, RATCHETED



728107

Inline Ratcheted Handle.

CATALOG #	DESCRIPTION
728107	Curved Left, 5 mm, 35 cm
728108	Curved Right, 5 mm, 35 cm
728109	Straight, 5 mm, 35 cm

LAPAROSCOPIC INSTRUMENTS

5 MM Scissors

HOOK SCISSORS



728002

Insulated Handle.

CATALOG #	DESCRIPTION
728000	Non-Rotating, Monopolar, 5 mm, 35 cm
728001	Non-Rotating, Monopolar, 5 mm, 45 cm
728002	Rotating, Monopolar, 5 mm, 35 cm
728003	Rotating, Monopolar, 5 mm, 45 cm

SUPERCUT SCISSORS, METZENBAUM



728008

Insulated Handle.

CATALOG #	DESCRIPTION
728006	Non-Rotating, Double-Action, Monopolar, 5 mm, 35 cm
728007	Non-Rotating, Double-Action, Monopolar, 5 mm, 45 cm
728008	Rotating, Double-Action, Monopolar, 5 mm, 35 cm
728009	Rotating, Double-Action, Monopolar, 5 mm, 45 cm

MICRO SCISSORS



728011

Non-Insulated, Non-Rotating Handle.

CATALOG #	DESCRIPTION
728010	Straight, 5 mm, 35 cm
728011	Curved Left, 5 mm, 35 cm

SUPERCUT SCISSORS, PERITONEAL



728004

Non-Insulated, Non-Rotating Handle.

CATALOG #	DESCRIPTION
728004	Single-Action, 5 mm, 35 cm
728005	Single-Action, 5 mm, 45 cm

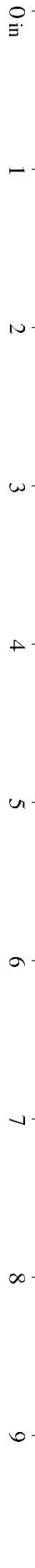

LAPAROSCOPIC INSTRUMENTS

Trays



720000

CATALOG #	DESCRIPTION
720000	Ext. size: 9-7/8" W x 20-3/4" L (25 x 52.5 cm) with silicone mat
720000M	Silicone mat for 720000



720001

CATALOG #	DESCRIPTION
720001	For 45 cm laparoscopic instruments. Ext. size: 26" L (66 cm), with silicone mat
720001M	Silicone mat for 720001

LAPAROSCOPIC INSTRUMENTS

Electrodes, Coagulators

ELECTRODE HANDLE



ELECTRODE

728161 33 cm
728162 45 cm



SUCTION COAGULATOR

728171 33 cm
728172 45 cm



**IRRIGATION/SUCTION
COAGULATOR**

728181 33 cm
728182 45 cm



BLUNT NEEDLE

728163 33 cm
728164 45 cm



**RIGHT ANGLE
(L-HOOK)**

728163 33 cm
728164 45 cm

728173 33 cm
728174 45 cm

728183 33 cm
728184 45 cm



J-HOOK

728165 33 cm
728166 45 cm

728175 33 cm
728176 45 cm

728185 33 cm
728186 45 cm



SPATULA

728167 33 cm
728168 45 cm

728177 33 cm
728178 45 cm

728187 33 cm
728190 45 cm



BLUNT NOSE

728169 33 cm
728170 45 cm

728179 33 cm
728180 45 cm

728191 33 cm
728192 45 cm

ELECTRODE TIPS

LAPAROSCOPIC INSTRUMENTS

Verres Needles, Cannulas, Probes, Knot Pushers, Telescopes

VERRES NEEDLES



Verres Needle

Reusable.

CATALOG #	DESCRIPTION
140875	10 cm
140877	12 cm
140878	15 cm
728113	18 cm

Weck® Vista® Disposable.

CATALOG #	DESCRIPTION
35120	14 Ga., 12 cm
35150	14 Ga., 15 cm

Irrigating/Aspirating Tubes.

CATALOG #	DESCRIPTION
728114	15 Ga., 33 cm
728115	15 Ga., 45 cm
728116	19 Ga., 33 cm
728117	19 Ga., 45 cm
728118	22 Ga., 33 cm
728119	22 Ga., 45 cm

Modular Reusable.

CATALOG #	DESCRIPTION
140879	Modular Verres body and obturator, 120 mm, 12 cm
140880	Modular Verres body and obturator, 150 mm, 15 cm
140881	Sterile disposable needle tip for 140879, 10/box
140882	Sterile disposable needle tip for 140880, 10/box

CANNULAS

Suction/Irrigation,
Dual (Trumpet) Valve.

CATALOG #	DESCRIPTION
728142	5 mm, 28 cm
728143	5 mm, 45 cm
728144	5 mm, 34 cm
728145	10 mm, 35 cm

Hasson.

CATALOG #	DESCRIPTION
728152	10/11 mm
728155	Auto Valve, 10/11 mm
728156	Thoracic Cannula Threaded, 12 mm

Reducer Sleeves.

CATALOG #	DESCRIPTION
728157	10/11 mm to 5 mm
728158	12 mm to 5 mm
728159	12 mm to 10 mm
728160	5 mm to 3 mm

Caps.

CATALOG #	DESCRIPTION
728153	White, 11 mm x 15 mm
728154	Blue, 8 mm x 18 mm

PROBES, KNOT PUSHERS



728140

Palpation Probes.

CATALOG #	DESCRIPTION
728140	32 cm
728141	45 cm

Knot Pushers.

CATALOG #	DESCRIPTION
728195	Appel Type Knot Pusher, 5 mm, 40 cm, closed
728197	Appel Type Knot Pusher, 10 mm, 40 cm, closed
728199	Knot Pusher, 4 mm, 30 cm, open

LAPAROSCOPIC INSTRUMENTS

Verres Needles, Cannulas, Probes, Knot Pushers, Telescopes

TELESCOPES



728126

Fully Autoclavable.

CATALOG #	DESCRIPTION
728120	5 mm, 30 cm, 0°
728121	5 mm, 30 cm, 30°
728122	5 mm, 30 cm, 45°
728125	10 mm, 33 cm, 0°
728126	10 mm, 33 cm, 30°
728130	10 mm, 33 cm, 45°
728131	10 mm, 45 cm, 0°
728132	10 mm, 45 cm, 30°
728133	10 mm, 45 cm, 45°
728134	Pediatric, 2.7 mm, 18 cm, 0°
728135	Pediatric, 2.7 mm, 18 cm, 30°

Retractors

FIVE FINGER FAN



728149

With flush port.

CATALOG #	DESCRIPTION
728148	Rigid, 10 mm
728149	Articulating, 10 mm
P35776	Articulating, 5 mm

THREE FINGER FAN



728147

With flush port.

CATALOG #	DESCRIPTION
728147	Rigid, 5 mm

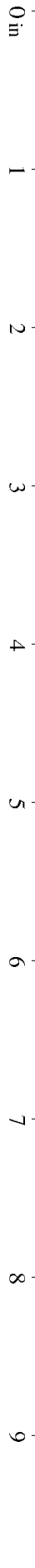

LAPAROSCOPIC INSTRUMENTS

Retractors

LAZY "S"



728146

CATALOG #	DESCRIPTION
728146	10 mm wide, 7-1/4" (18 cm) long, Set of two

HASSON "S"



728150

CATALOG #	DESCRIPTION
728150	10 mm wide, 7-1/4" (18 cm) long, Set of two
728151	13 mm wide, 7-1/4" (18 cm) long, Set of two
306010A	15 mm wide, 6-1/2" (16.5 cm) long, Set of two

O'REILLY ESOPHAGEAL



381801A

CATALOG #	DESCRIPTION
381801A	9 mm wide, 54 cm

CORDS AND CABLES



602101B



601001A

CATALOG #	DESCRIPTION
602101B	Bipolar Cord, 2-prong style (Valley Lab)
602102B	Bipolar Cord, 1-prong style (Wolf)
601001A	Monopolar Bovie High Frequency Cable, 1/4" plug
601002A	Monopolar Banana High Frequency Cable, 1/4" plug





ELECTROSURGERY INSTRUMENTS

CHAPTER OVERVIEW

Our Weck® Electrosurgery Instruments represent a high quality line that offers the precision you require, the quality you demand and the pattern assortments that meet your needs. Our categories of Electrosurgical instruments include:

- Biceps Non-stick Bipolar Forceps and Cords
- Bipolar Forceps and Cords
- Disposable Electrodes
- Coagulation Suction Tubes



ELECTROSURGERY

Biceps Non-stick Bipolar Forceps and Cords

WECK® BICEPS JEWELERS FORCEPS



394250

Straight, non-stick bipolar forceps, non-sterile.

CATALOG #	DESCRIPTION
394250	#5, 0.5 mm tips, without stops, 4-3/4" (12.5 cm)

WECK® BICEPS BAYONET FORCEPS



394267

Straight, non-stick bipolar forceps, non-sterile.

CATALOG #	DESCRIPTION
394807	0.5 mm tips, without stops, 7-1/2" (19 cm)
394267	0.5 mm tips, with stops, 8" (20.5 cm)
394258	1.0 mm tips, with stops, 8" (20.5 cm)

WECK® BICEPS CERULLO BAYONET FORCEPS



394811

Straight, non-stick bipolar forceps, non-sterile.

CATALOG #	DESCRIPTION
394811	0.5 mm tips, without stops, 10" (25.5 cm)

WECK® BICEPS FORCEPS CORDS



394246

Fits all Biceps® Forceps.

CATALOG #	DESCRIPTION
394246	Disposable, sterile, 12' (3.6 m), 10 per box
394247	Non-sterile, 12' (3.6 m)



394247

ELECTROSURGERY

Biceps Forceps and Cords

WECK® BIPOLAR ADSON FORCEPS



392028

Straight, bipolar forceps, non-sterile.

CATALOG #	DESCRIPTION
392026	1.0 mm tips, non-insulated, 5" (12.5 cm)
392028	1.0 mm tips, insulated, 5" (12.5 cm)

WECK® BIPOLAR CUSHING FORCEPS



191023

Straight, bipolar forceps, non-sterile.

CATALOG #	DESCRIPTION
191023	1.5 mm tips, insulated, 7" (18 cm)

WECK® BIPOLAR CUSHING BAYONET FORCEPS



392036

Straight, bipolar forceps, insulated, non-sterile.

CATALOG #	DESCRIPTION
392034	0.7 mm tips, 7-1/2" (19 cm)
392036	1.0 mm tips, 7-1/2" (19 cm)
392204	1.5 mm tips, 7-3/4" (19.5 cm)
191025	2.0 mm tips, 7-1/2" (19 cm)

WECK® BIPOLAR SCOVILLE-GREENWOOD BAYONET FORCEPS



392014

Straight, bipolar forceps, non-sterile.

CATALOG #	DESCRIPTION
392012	1.5 mm tips, non-insulated, 7-3/4" (19.5 cm)
392014	1.5 mm tips, insulated, 7-3/4" (19.5 cm)

ELECTROSURGERY

Biceps Forceps and Cords

WECK® BIPOLAR IRIS FORCEPS



392043

Straight, bipolar forceps, non-sterile.

CATALOG #	DESCRIPTION
392043	0.4 mm tips, serrated handle, 3-1/2" (9 cm)

WECK® BIPOLAR JEWELER'S FORCEPS



392018

Straight, bipolar forceps, non-sterile.

CATALOG #	DESCRIPTION
392018	0.4 mm tips, smooth handle, 4" (10 cm)

WECK® BIPOLAR SEMKIN FORCEPS



392040

Straight, bipolar forceps, non-sterile.

CATALOG #	DESCRIPTION
392040	0.7 mm tips, with stops, 5-1/2" (14 cm)

WECK® BIPOLAR FORCEPS CORDS



394237

Fits all standard bipolar forceps.

CATALOG #	DESCRIPTION
394236	Disposable, sterile, 12' (3.6 m), 10 per box
394237	Rubber, non-sterile, 12' (3.6 m)
394238	Silicone, non-sterile, 12' (3.6 m)



394238

ELECTROSURGERY

Disposable Electrodes

WECK® DISPOSABLE ELECTRODES

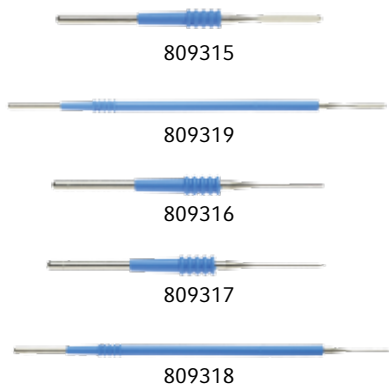

Sterile, 24 per box.

CATALOG #	DESCRIPTION
809315	Blade electrode, 3/4" (19 mm) blade, 2-3/4" (7 cm)
809319	Blade electrode, 3/4" (19 mm) blade, 6" (15 cm) extended length
809316	Needle electrode, 3/4" (19 mm) blunt needle, 1/32" (0.7 mm) dia., 2-3/4" (7 cm)
809317	Needle electrode, 3/4" (19 mm) needle, 1/32" (0.7 mm) dia., 2-3/4" (7 cm)
809318	Needle electrode, 3/4" (19 mm) needle, 1/32" (0.7 mm) dia., 6" (15 cm) extended length

WECK® DISPOSABLE IMA/ENT ELECTRODES

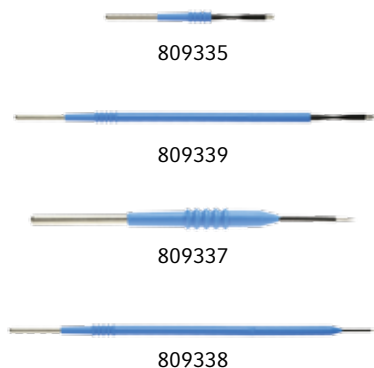

Sterile, 24 per box.

CATALOG #	DESCRIPTION
809335	Blade electrode, 3/4" (2 cm) blade, extended insulation, 2-3/4" (7 cm)
809339	Blade electrode, 3/4" (2 cm) blade, extended insulation, 6" (15 cm) extended length
809337	Needle electrode, 3/4" (2 cm) needle, 1/32" dia., extended insulation, 2-3/4" (7 cm)
809338	Needle electrode, 3/4" (2 cm) needle, 1/32" dia., extended insulation, 6" (15 cm) extended length

ELECTROSURGERY

Monopolar Handswitching Forceps

WECK® MONOPOLAR HANDSWITCHING FORCEPS



809267

Non-sterile.

CATALOG #	DESCRIPTION
809267	Curved inward, 2.0 mm tips, insulated, 8" (20.5 cm), 10' (3 m) cord

ELECTROSURGERY

Coagulation Suction Tubes

COAGULATION SUCTION TUBES



809600

Disposable foot control coagulation suction tubes, sterile, 10 per box.

CATALOG #	DESCRIPTION
809600	11 French, with stylet, 6" (15 cm)
809610	11 French, with stylet, 8" (20.5 cm)





ADDITIONAL SURGICAL PRODUCTS



DEKNATEL® SUTURE

Security that builds confidence

DEKLENE® MAXX™ POLYPROPYLENE SUTURE

Polypropylene for cardiovascular anastomosis with superior handling characteristics providing optimal elongation and reduced memory.

TEVDEK®/POLYDEK® BRAIDED POLYESTER SUTURE

Unrivaled knot security and easy tie-down.

NEXSTITCH® VALVE SUTURE

Simplifies precise placement of adjacent sutures while reducing needle trauma to the annulus.

GABBAY FRATER SUTURE ORGANIZER



GFS-10A 4 pieces of 3
GFS-1A 4 pieces of 1

For additional information please contact your Teleflex® surgical representative, call customer service or visit our website at Teleflexurgicalcatalog.com

Teleflex, Deklene, Deknatel, Maxx, NextStitch, Polydek and Tevdek are trademarks or registered trademarks of Teleflex Incorporated or its affiliates.



TAUT® CHOLANGIOGRAPHY CATHETERS

Visualize Anatomy with Confidence

Teleflex® leads the industry with a variety of Taut® Cholangiogram Catheters. Taut® Catheter memory allows surgeons to easily shape the catheter to the optimum angle for cystic duct insertion.

Our cholangiogram catheter selection includes a variety of tip designs, lengths and Intraducer® Peritoneal Catheter options to fit surgeon preference.

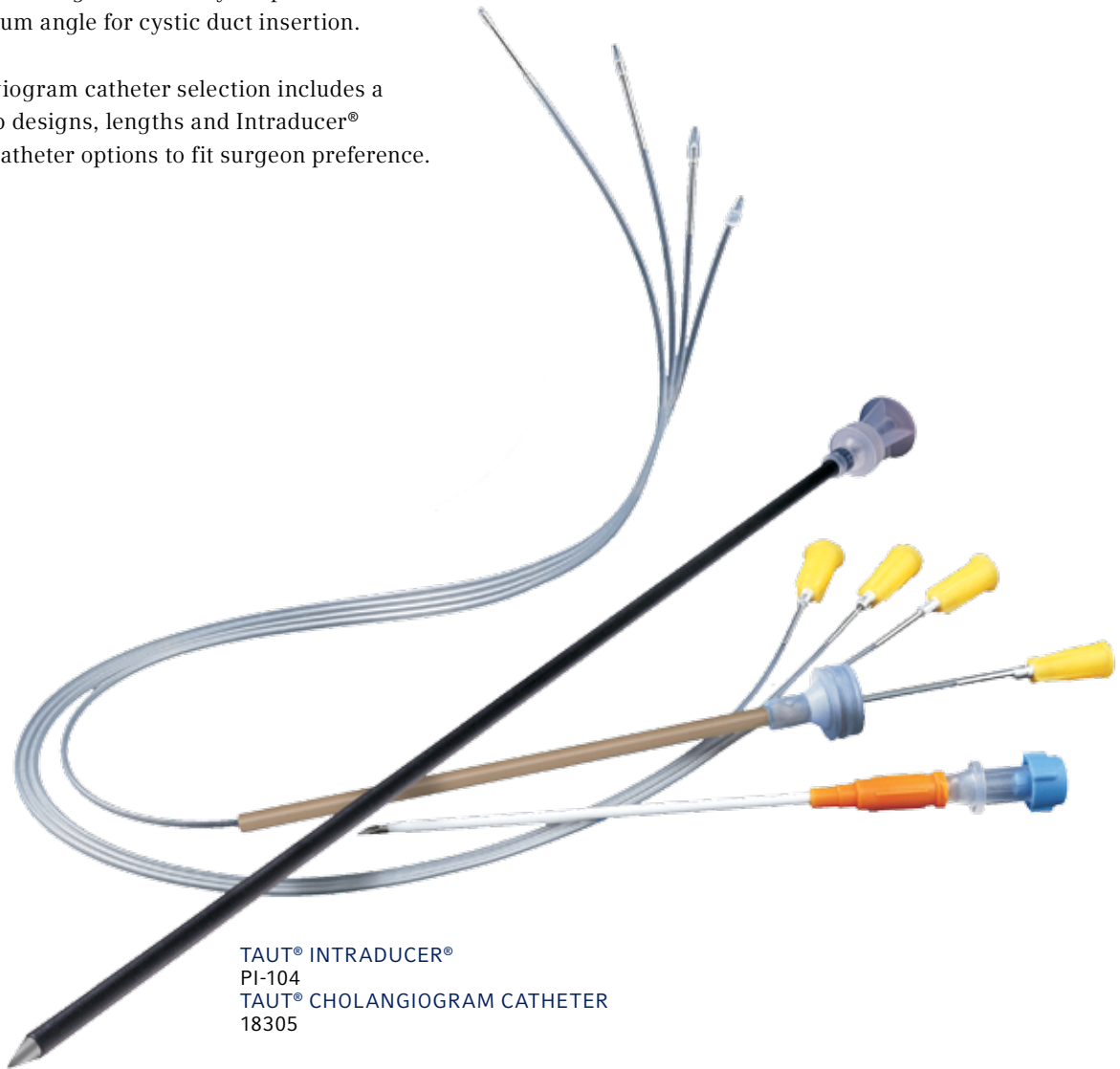

TAUT® INTRADUCER®
PI-104
TAUT® CHOLANGIOGRAM CATHETER
18305

For additional information please contact your Teleflex® surgical representative, call customer service or visit our website at Teleflexurgicalcatalog.com

Teleflex, Intraducer, System One and Taut are trademarks or registered trademarks of Teleflex Incorporated or its affiliates.



TAUT® SYSTEM ONE™ COMMON BILE DUCT EXPLORATION KIT

Remove Biliary Stones with Confidence

The Taut® System One™ Kit is an integrated combination of products designed specifically for transcystic laparoscopic common bile duct exploration. The tools needed for several methods to clear common bile duct stones are provided in one convenient kit.

This multifunctional, restockable kit contains:

- Balloon Catheter (50640)
- Titanium Retrieval Basket (50024)
- Flexible Guidewire (50035)
- High-Pressure Syringe (K05-01251)
- Intraducer® Peritoneal Catheter (PI-128)



50000

For additional information please contact your Teleflex® surgical representative, call customer service or visit our website at Teleflexsurgicalcatalog.com

Teleflex, Intraducer, System One and Taut are trademarks or registered trademarks of Teleflex Incorporated or its affiliates.



WECK VISTA® BLADELESS LAPAROSCOPIC ACCESS PORTS

Confidence. Clarity. Control

The Weck Vista® Line of Bladeless Laparoscopic Access Ports meets the needs of surgeons performing minimally invasive procedures by providing the broadest line of primary entry points: balloon and cone open access ports, optical ports and standard ports.

The unique reusable obturators from Teleflex® offer the best of both worlds: performance for surgeons and cost effectiveness for the facility.

Beyond our own line of ports seen here, our patented asymmetrical dilating tip is widely used in robotic procedures with the da Vinci® Obturator.

OPTICAL ACCESS PORT

- Clear visualization of tissue layers
- Securely grasps laparoscopes

BALLOON AND CONE OPEN ACCESS PORTS

- Designed to maintain pneumoperitoneum
- Easy one-hand stabilizer mechanism

BLADELESS ACCESS PORTS

- Asymmetrical dilating tip for minimal defect
- Ridged or smooth cannulas

REUSABLE OBTURATORS

- Bladeless tip compatible with cannula-only offerings
- Cost effective and environmentally friendly solution



WECK Vista®
Optical
Ridged
10 mm x 100 mm
405910R

WECK Vista®
Bladeless
Smooth
12 mm x 100 mm
405912

WECK Vista®
Cone Open
Access Port
Smooth
12 mm x 100 mm
405933L

WECK Vista®
Open Balloon
Stability
Smooth
12 mm x 100 mm
412944L

WECK Vista®
Bladeless Reusable
Obturator
Stainless Steel
5 mm x 100 mm
405188

Additional sizes available

For additional information please contact your Teleflex® surgical representative, call customer service or visit our website at Teleflexurgicalcatalog.com



WECK EFX[®] ENDO FASCIAL CLOSURE SYSTEM

A True Unassisted Approach to Port Site Closure

The WECK EFX[®] Endo Fascial Closure System facilitates an effective endo fascial port site closure of fascial defects resulting from the use of 10 mm – 15 mm diameter trocars. Its unique approach allows the surgeon confidence in a predictable and uniform closure across varying patient anatomies.

WECK EFX[®] ENDO FASCIAL CLOSURE SYSTEM FEATURES:

- Consistent and uniform 1 cm fascial purchase across varying patient anatomy
- Universal tapered body design accommodates varying port site diameters
- Depth control for safety

da Vinci is a trademark or registered trademark of Intuitive Surgical, Inc. Teleflex, Weck EFX and Weck Vista are trademarks or registered trademarks of Teleflex Incorporated or its affiliates.



EFX-001

For additional information please contact your Teleflex[®] surgical representative, call customer service or visit our website at Teleflexurgicalcatalog.com

WECK® SKIN STAPLERS

WECK® VISISTAT® FIXED HEAD SKIN STAPLERS

The Visistat® Staplers are pre-loaded with medical-grade stainless steel staples that provide numerous benefits to the patient:

- Sharper staples result in less trauma to the tissue
- Taller staples lead to easier removal
- Ergonomic design allows the OR staff to place staples with a high hand position to avoid contact with the incision



VISISTAT® SKIN STAPLER
Wide
528235



VISISTAT® SKIN STAPLER
Regular
528135

SKIN STAPLE EXTRACTORS

Weck® Skin Staple Extractors are disposable devices used for the removal of skin staples.

For additional information please contact your Teleflex® surgical representative, call customer service or visit our website at Teleflexurgicalcatalog.com

Teleflex, Visistat and Weck are trademarks or registered trademarks of Teleflex Incorporated or its affiliates.

INDEX

Alphabetical

#

1 mm Fine Perforated Cases	324
10 mm Dissectors	1132
5 mm Bipolar Forceps	1135
5 mm Dissectors, Grasping Forceps	1129
5 mm Needle Holders	1141
5 mm Ratcheted Graspers	1136
5 mm Scissors	1142
5-10 mm Biopsy Forceps	1133
5" Jacob's Chuck Drill Bits	855

A

Abdominal Vascular Retractor Set with Split Wishbone - Components	243
Ablaza-Blanco Cardiac Valve Retractor	757
Abraham Laryngeal Syringe Cannula	437
Abramson-Dedo Micro-Laryngoscope	399
Abrams Pleural Biopsy Needle	769
Accessory Boxes	336
ACMI Illuminator End Adapter for Type II Cables	468
Adair-Allis Intestinal Tissue Forceps	89
Adair Tenaculum	280
Adams Tissue Forceps	55
Adapter (Power Drill)	854
Additional Accessories	373
Adenotome Blades	523
Adson-Brown Laser Tissue Forceps	47
Adson-Brown Titanium Tissue Forceps	688
Adson-DeBakey® Tissue Forceps	46
Adson Dissector Hooks	878
Adson Dressing Forceps	36
Adson Hemostatic Forceps	58
Adson Laser Tissue Forceps	38
Adson Periosteal Elevators	956
Adson Rat Tooth Rongeur	1027
Adson Retractor	222, 903
Adson Rongeurs	1027
Adson Suction Tubes	245
Adson Suction Tubes, Curved	245
Adson Tissue Forceps	45
Adson Titanium Dressing Forceps	688
Adson Titanium Tissue Forceps	688
Air Injection Cannula	1122
Air-Lon® Trachea Tube Inhalation Sets	486
Air-Lon® Trachea Tubes	486
Alexander Chisels	998
Alexander Gouges	1001
Alexander Periosteal Rasp	974
Alexander Periosteotome	718
Allen Intestinal Clamps	89
Allerdyce Elevator and Dissector	506, 953
Alligator Applying Forceps and Ligating Clips	781
Alligator Forceps	496
Alligator Nasal Forceps	507

Allis Delicate Tissue Forceps	90
Allis Graspers	1138
Allison Lung Retractors	217, 746
Allis Tissue Forceps	90, 253
Alm Retractors	219
Aluminum Utility Cases	324
Amato Neonatal Sternal Retractors	730
Amato Pediatric Dilators Set	770
Anderson Adson Retractor	223
Anderson-Nievert Osteotomes	510
Andrews Infant Suction Tube	248, 767
Andrews Pynchon Suction Tube	248, 767
Andrews Tongue Depressor	530
Angled Bone Holding Forceps	925
Angled Laser Retractors	432
Angled Pelvic Bone Reduction Forceps	932
Aortic Punches	764
Diamond Edge Design	764
Reusable Punches	765
Approximation Clamp	321
Army Pattern Chisels	998
Asch Septum Forceps	509
Aspirating Needle	777
Aspirating Tubes	433
Asymmetric Pelvic Reduction Forceps	932
Atraumatic Allis Graspers	1139
Aufranc Cobra Retractors	885
Aufricht-Glabella Rasp	512, 970
Aufricht Nasal Retractor	522
Aufricht Rasp	511, 970
Auvarud Weighted Vaginal Specula	287

B

Babcock Graspers	1139
Babcock Tissue Forceps	92, 253, 557
Baby Metzenbaum Scissors	124
Backbiter Forceps	516
Backhaus Towel Clamps	32
Backhaus Towel Forceps	32
Bacon Rongeur	1024
Bahnon Aorta Clamp	631
Bailey Aorta Clamps	631
Bailey Aortic Valve Rongeurs	759
Bailey Cardiac Technique® Needle Holder	171, 676
Bailey-Gibbon Rib Approximator Retractor	718
Bailey Rib Approximator Retractors	718
Bainbridge Forceps	93
Bakes Common Duct Dilators Set	311
Bakst Cardiac Scissors	669
Balfour Center Blades	235
Balfour Fourth Blade Attachments	236
Balfour Retractors	232
Balfour Retractors Permanent Side Blade Model	233
Ballenger Knives	510
Ballenger Sponge Forceps	27

Bane Rongeur	1022	Beyer Rongeurs	1030
Bantam Wire Cutting Scissors	112	Billeau Ear Loops	495
Bariatric Blades, Malleable, for Circuttract	241	Biopsy Forceps	1133
Bariatric Components, for Circuttract	241	Biopsy Graspers	1133
Bariatric Crossbar, for Wishbone	243	Biopsy Punch	1134
Bariatric Side Arm, for Wishbone	243	Biopsy Punch Forceps	1133
Bariatric Harrington Blade, for Circuttract	241	Bishop Bone Clamp	935
Bariatric Kelly Blade, for Circuttract	241	Bishop-Harmon Anterior Chamber Irrigation Cannula	1123
Bariatric, Extended Length/Open	251	Bishop-Harmon Dressing Forceps	1096
Forceps and Clamps	251	Bishop-Harmon Tissue Forceps	1098
Knife Handles/Suction Tubes	251	Blade Retractors	882
Needle Holders	261	Blair (Rollet) Retractor	195
Retractors	263	Blake Gallstone Grasping Forceps	95
Scissors	258	Blakesley Nasal Forceps	507
Bariatric Segmented Ring, for Circuttract	241	Blanco Valve Instruments	757
Bariatric Vertical Post, for Circuttract	241	Bland Cervical Traction Forceps	266
Barnhill Adenoid Curettes	524	Blepharoplasty Scissors	135
Baron Suction Tubes	247	Blount Double Prong Retractor	889
Barraquer Cilia and Suture Forceps	1103	Blount Knee Retractor	889
Barraquer Delicate Needle Holders	183	Blount Single Prong Retractor	889
Barraquer Micro Needle Holders	177, 182	Blunt Nose Grasper	1130
Barraquer Needle Holders	1115	Bodenhammer Rectal Speculum	304
Barraquer Wire Speculums	218, 1119	Boettcher Tonsil Scissors	532
Barraya Titanium Tissue Forceps	689	Boies Nasal Elevator	505
Barr Crypt Hook	307	Bonchek-Carpentier Sternal/Atrial Valve Retractor	739
Barrett Tenaculum	280	Bone Awl	939
Barron Hemorrhoidal Alligator Seizing Forceps	300	Bone Chip Packers	1005
Baumgarten Wire Twister	184, 686	Bone Compass	312, 1079
Baumgartner Bulldog® Needle Holder	152	Bone File	969
Baumgartner Needle Holder	152	Bone File #10	966
Bayonet Nerve Retractor	880	Bone File #12	966
Beall Circumflex Artery Scissors	658	Bone File #12A	966
Beall Micro Coronary Scissors	659	Bone File #12CA	967
Beasley-Babcock Tissue Forceps	48	Bone File #33	967
Becker Septum Scissors	514	Bone File #45	967
Beckman-Adson Laminectomy Retractors	224, 904	Bone File #92A	968
Beckman Retractors	224, 903	Bone File #92B	968
Beckman-Adson Retractors	225, 903	Bone File and Rasps	966
Beckman-Eaton Retractors	225, 904	Bone Files	966
Beckman-Weitlaner Retractors	223, 904	Bone Rasps	970
Beck Miniature Pediatric Aortic Clamp	591	Bone Holding Instruments	914
Beck-Type Aorta Clamps	632	Bone Clamps	935
Beck-Type Vessel Clamps	592	Bone Holding Forceps	914
Bellina Laser Rulers	290	Bone Reduction Forceps	928
Bellucci Alligator Scissors	500	Bone Hooks and Awls	938
Bending Irons	877	Awls	939
Bending Pliers	845	Bone Hooks	938
Bengolea Forceps	59	Bone Holding Forceps	915
Bennett Bone Elevator and Retractors	885	Bone Hooks	938
Berci Suture Passer	316	Bone Impactor	1005
Bergh Cilia Forceps	1103	Bone Mill	1092
Bergman Mallets	1011	Bone Rasp	970
Bernay Finger Rake Tracheal Retractors	194, 493	Bone Rasp #64	968
Berry Angio Access Tunneler	798	Bone Reduction Forceps	928
Berry Sternal "Big Ugly" Technique® Needle Holder	686	Bone Saws and Knives	1071
Berry Sternal Technique® Needle Holder	185	Bone Tamps and Impactors	1005
Best Colon Clamp	94	Bone Impactors	1005
Betha Sheet Holders	293	Bone Tamps	1005
Bethune Rib Cutter	720	Bone Tamps	1005
Beyer Bone Biting Rongeur	1025	Bonney Tissue Forceps	48

Bonnier Catheter Adapter	437, 768	Bunnell Drill	850
Bonn Iris Tissue Forceps.....	1098	Bunnell Tendon Strippers	948
Boston University Suspension System	413	Bunt Forceps Holder	343
Boston University System Laryngoscope Handle	414	Burford Adult Retractor	739
Boston University System Pivoting Extension		Burford Aluminum Adult Retractor	739
Arm Assembly	414	Burford-Finochietto Infant-Child Retractor	731
Boucheron Ear Speculum.....	501	Busch Umbilical Scissors	273
Bougies/Dilators	469		
Esophageal Bougies	469	C	
Laryngeal Dilators	472	Callison-Adson Tissue Forceps.....	46
Bougie Tray.....	470	Calman Carotid Bulldog® Clamps	606
Bovie Cord for Suction Tube	777	Calman Clamp.....	609
Bovie Pencil Handle.....	778	Camera and Light Cord Cases.....	332
Bowel Grasper-Hunter.....	1131	Cannula Cleaners.....	345
Bowman Lacrimal Probes	309, 1120	Cannulas	1145
Boxes with Entries = Endoscope Sizes Available	446	Cannulated Pin Cutter	827
Bozeman Uterine Dressing Forceps	264	Caplan Nasal Scissors	514
Brachial Large Vessel Approximators	320	Capsule Retractor	887
Brachial Large Vessel Clips.....	320, 569	Cardiac Valve Forceps.....	551
Brand Tendon Pulling Forceps.....	946	Cardiac Valve Hook, Calibrated	760
Braun Episiotomy Scissors.....	273	Carlens Mediastinoscopes	776
Braun Tenaculum.....	280	Carmalt Forceps	60, 253
Brewster Phrenic Retractors.....	204	Carmalt Splinter Forceps	34
Brewster Retractors	198	Carroll Tendon Retriever	945
Bridge Hemostatic Forceps	59	Cartilage and Tendon Instruments	942
Bridge X-Action Forceps.....	253	Cartilage Knives	946
Brigham Dressing Forceps.....	43	Cartilage Scissors.....	947
Brinkerhoff Rectal Specula	304	Clamps and Forceps	942
Bristow/Bankart Humeral Retractor.....	888	Tendon Strippers	948
Bristow/Bankart Soft Tissue Retractor.....	887	Caspar IVD Rongeurs.....	1058
Bronchial and Esophageal Instrumentation.....	453	Castaneda Pediatric Clamps	577
Bronchoscopes	439	Castaneda Titanium Vascular Clamping Forceps.....	695
Bronchoscope Accessories	443	Castroviejo Calipers	312, 1078, 1124
Cleaning Brushes.....	447	Castroviejo-Colibri Tissue Forceps.....	1098
Holinger Design.....	440	Castroviejo Corneo-Scleral Forceps	1105
Holinger Pediatric Design.....	441	Castroviejo Keratoplasty Micro-Scissors	1106
Laser Bronchoscopes	442	Castroviejo Keratoplasty Scissors	1106
Bronchoscope Adapter.....	443	Castroviejo Lacrimal Dilator	1121
Bronchoscope Window Plug Replacement Lens.....	443	Castroviejo Micro Needle Holders.....	178, 180, 683
Bronchus Clamp	557	Castroviejo Needle Holders	178, 180, 683, 1115
Brown-Adson Tissue Forceps	46	Castroviejo Scissors	675, 1106
Brown Needle Holder.....	153	Castroviejo Suture Forceps.....	1100
Brown Tissue Forceps.....	48	Castroviejo Technique® Needle Holders	180, 682
Bruening Bayonet Nasal Snare	519	Catheters	299
Brun Curettes	977	Catheter Guides.....	299
Brun Smartrack for 7" Curettes.....	987, 1082	Cholangiography	1159
Brun (Spratt) Curettes.....	975	Coronary Perfusion Catheters	763
Brun Shears	1074	Centimeter Subtraction Ruler	311, 437
Brushes	447	Cervical Kerrison Thin Footplate Rongeurs.....	1046
Bronchoscope.....	447	Cervical Laser Hooks.....	290
Tracheostomy Tubes	494	Cervical Retractor Set	902
Buck Ear Curettes.....	495	Chandler Elevators	965
Buck Neuro Hammer Stainless	1086	Charriere Bone Saws.....	1072
Buie Pile Clamp.....	300	Chaux Deep Blade Assembly	724
Buie Suction Tubes.....	308	Chaux-Lemole Bi-Angle T-Frame.....	756
Bulldog® and Micro Vessel Clamps	562	Chaux Multipurpose Sternal Ima Retractor.....	722
Bulldog® Clamps.....	562	Chaux Sternal Ima-Mitral Valve Retractor.....	723
Micro Vessel Clamps	569	Cheanvechai-Favaloro Swivel Rake Assembly.....	727
Bulldog® Clamp Applying Forceps.....	569	Cheanvechai Rake Assembly.....	727
Bullet Nose Dissector.....	1130		

Cherry Supraceliac Clamp.....	632	Cobb Curettes, Stainless Steel Handle	979
Chest Drain Pulling Clamp	561	Cobb Osteotome	995
Chichirelli (Blumenthal) Rongeur	1023	Cobb Smartrack for 11" Instruments.....	987, 1082
Children's Hospital Retractor.....	204	Cobb Spinal Elevators, Aluminum Handle.....	962
Chisels and Gouges	998	Cobb Spinal Elevators, Hex Handle.....	961
Chisels.....	998	Cobb Spinal Elevators, Stainless Steel Handle.....	963
Gouges	1001	Cobb-Type Spinal Gouges	1004
Chisel and Gouge Set	996	Colibri Corneal Tissue Forceps.....	1098
Interchangeable Osteotome, Chisel and Gouge Set.....	996	Collier Forceps.....	61
Church Scissors.....	120	Collier Anderson Clamps.....	254
Circuitract Set - Components.....	241	Collier Hemostatic Forceps.....	62
Clamps	28	Collin Lung Tissue Forceps.....	557
Aortic Aneurysm Clamps	650	Collin Mallet.....	1009
Aortic Compressor	657	Collins Tongue Seizing Forceps.....	525
Aortic Vascular Clamps	630	Colver Coakley Tonsil Forceps	525
Bariatric	257	Combination Mallet Caps	1011
Bone Clamps.....	935	Combination Mallets	1011
Bronchus and Lung Clamps	557	Combination Wrench.....	847
Bulldog® Clamps.....	562	Cone Ring Curettes	983
Carotid Clamps	606	Conn Aortic Compressor.....	657
Carotid Clamps, 1 mm Jaw.....	609	Container Systems	370
Carotid Clamps, 1.5 mm Jaw.....	611	Accessories.....	372
Cartilage and Tendon Instruments	942	Pilling® Container Systems	370
Chest Drain Pulling Clamp	561	Containers and Trays.....	324
Circumcision Clamps.....	271	Converse Needle Holder	153
Cooley Vascular Clamps	624	Converse Rasp	512, 971
CVT	561	Converse Skin Hooks.....	187
Femoral-Popliteal Clamps	614	Cooley Anastomosis Clamps	598
Gastrointestinal Forceps and Clamps.....	89	Cooley Aorta Clamp.....	650
General.....	28	Cooley Carotid, Subclavian and Renal Clamp.....	624
Hemostatic Forceps and Clamps	58	Cooley Clamps	599
Micro Vessel Clamps	569	Cooley Clamps for Pediatric and Infant Cardiovascular Surgery	599
OB/GYN	264	Cooley Clamps for Pediatric Cardiovascular Surgery	597
Pediatric Clamps, 1 mm Jaw	577	Cooley Coarctation Clamps.....	625
Pediatric Clamps, 1.5 mm Jaw	579	Cooley Dilators	770
Pediatric Clamps, 2 mm Jaw	592	Cooley Iliac Clamps	625
Pediatric Clamps, Cooley-Type Jaw	597	Cooley Jaw Multipurpose Clamps	626
Pediatric Vascular Clamps.....	697	Cooley Jaw Vascular Tissue Forceps	549
Peripheral Vascular Clamps	615	Cooley-Mayo Curved Scissors	120
Rectal	300	Cooley Mitral Valve Retractors	753
Renal Clamps	612	Cooley Partial-Occlusion Clamps.....	627
Right Angle Clamps.....	86	Cooley Patent-Ductus Clamps.....	628
Ring Handled Bulldog® Clamps	604	Cooley Pediatric Cardiovascular Clamps.....	600
Towel Clamps.....	31	Cooley Pediatric Derra Clamps	601
Tubing Clamps.....	28	Cooley Pediatric Modified Anastomosis Clamp	602
Vascular Clamps	575, 698	Cooley Pediatric Multipurpose Clamps	602
Clark Artery Forceps	253	Cooley Pediatric Patent Ductus Clamps	603
Clark Hysterectomy Clamps.....	256	Cooley Peripheral Vascular Clamps.....	629
Claw Grasper	1129	Cooley Scissors.....	258
Cleanpunch® Cleaning System.....	1045, 1080	Cooley Sternum Retractors	735
Clerf-Arrowsmith Safety Pin Closing Forceps.....	457	Cooley Sump Suction Tube	249, 767
Cleveland Bone Cutting Forceps.....	1015	Cooley Titanium Pediatric Clamp	697
Cleveland Clinic Renal Clamps.....	612	Cooley Vena Cava Clamps	629
Clips and Appliers	781	Cords and Cables.....	1147
Mediastinoscopy.....	781	Corn Knives.....	1090
Micro Clips and Appliers.....	317	Coronary Ultra-Fine Tissue Forceps.....	56, 549
Cloward-Style Mallets	1012	Coryllos-Bethune Rib Shears	720
Coagulation Suction Tubes	465, 1157	Cottle Alar Retractor	198
Coarctation Hook.....	760	Cottle Columella Forceps	509, 1105
Cobb Curettes, Aluminum Handle	978		

Cottle Double-Ended Elevator	505, 955	Tissue Forceps.....	546
Cottle Knife Guide and Retractor.....	510	CVT Needle Holders	676
Cottle Nasal Knife.....	510	Castro-Type Micro Needle Holders	683
Cottle Osteotomes	510	Pilling® Technique® Design	676
Cottle Rasp.....	512, 971	Wire Twisters.....	686
Cottle Septum Speculum.....	521	CVT Retractors	722
Cottle Skin Hooks	187	Epicardial.....	722
Couëtil Ima Sternal Retractor	725	Hand-Held.....	746
Cox Metatarsal Spreader.....	897	Henly-Type Retractors.....	750
Cradles and Holders	372	IMA	722
Crafoord Coarctation Vascular Clamps	633	Sternal Retractors/Rib Spreaders.....	729
Crafoord Tissue Forceps	56	Pilling® Sternal Retractor and Rib Spreader Dimensions	743
Crafoord Titanium Clamping Forceps	698	Sternal Closure	745
Crawford Aortic Retractors.....	753	C.W. Mayo Tissue Forceps.....	57
Crawford-Coolley Graft Tunneler.....	798	Cylindrical Sponges.....	359
Crawford Suture Ring.....	758	Cystic Duct Catheter Clamps	95
Crawford Thoraco-Abdominal Aneurysm Clamps	650		
Crego Periosteal Elevator.....	958		
Crile Forceps.....	62		
Crile Hemostats	62	D	
Crile Murray Bulldog® Needle Holders.....	164	Dale Femoral-Popliteal Anastomosis Clamp	614
Crile Retractor	205	Dale Femoral-Popliteal Clamps.....	614
Crile Titanium Hemostatic Forceps	694	Dale First Rib Rongeur	716
Crile Wood Bulldog® Needle Holders	164	Dandy Hemostatic Forceps.....	63
Crile Wood Needle Holders.....	163, 261	Dandy Kolodny Forceps	63
Crouch Clamp	78	Dandy Nerve Hook	192
Cruciform Screwdriver	870	Darling Tape Passing Clamp “Aorta Go Around”	555
Crutchfield Tongs	913	Darrach Elevators.....	964
Curettes	975	Davidson Scapula Retractors	217, 748
Brun Curettes	977	Davis Brain Spatulas.....	216
Cobb Curettes.....	978	Davis-Finochietto Infant Retractor	729
Ear Curettes.....	495	Davis & McIvor Left Tongue Blades.....	526
Endoscopic Curettes	985	Davis & McIvor Right Tongue Blades.....	527
OB/GYN Curettes	277	Davis Mouth Gag Blade, Size 2	527
Ophthalmic	1118	Davis Mouth Gags.....	528
Specialty Bone Curettes.....	980	Davis Retractors	205
Curette Excavators	1089	Davis Tissue Forceps.....	57
Curved Masher Grasping Forceps	783	Day Ear Hook.....	495
Cushing Bayonet Dressing Forceps.....	39	Dean (Blumenthal) Rongeurs.....	1025
Cushing Bayonet Tissue Forceps.....	49	Dean Rongeur.....	1023
Cushing Blunt Elevator.....	719	Dean Scissors	123
Cushing Decompression Retractor.....	198, 747	Dean Tonsil Scissors.....	532
Cushing Dressing Forceps	38	Deaver Retractors.....	209
Cushing Gutsch Bayonet Dressing Forceps	39	DeBakey® Acutely Curved Clamps.....	593
Cushing Gutsch Dressing Forceps.....	38	DeBakey®-Adson Coronary Suction Tubes.....	250, 768
Cushing Gutsch Tissue Forceps.....	49	DeBakey® Angled Peripheral Vascular Clamp.....	616
Cushing IVD Rongeurs.....	1057	DeBakey® Aorta Clamp.....	651
Cushing Little Joker Elevator	957	DeBakey® Aortic Aneurysm Clamps	652
Cushing Nerve and Vein Retractor	199, 747	DeBakey® Aortic Exclusion Clamp.....	616
Cushing Periosteal Elevators	957	DeBakey® Bainbridge Clamps.....	94
Cushing Tissue Forceps	49	DeBakey® Bainbridge Vascular Clamps.....	617
Cushing Titanium Dressing Forceps.....	689	DeBakey® Carbide Forceps	51, 547
Cushing Titanium Tissue Forceps	689	DeBakey® Chest Retractors.....	736
Cushing Vein Retractors.....	263	DeBakey® Child Retractor	731
Cutting Block.....	522, 1124	DeBakey® Coarctation Clamps.....	579, 618
CVT Forceps and Clamps	546	DeBakey®-Coolley Retractor	212
Bronchus and Lung Clamps	557	DeBakey® Cross Action Bulldog® Clamps.....	562
Chest Drain Pulling Clamp	561	DeBakey® Curved Clamps	653
Ligature Carriers	555	DeBakey® Curved Peripheral Vascular Clamp.....	618
Micro Forceps.....	552	DeBakey® Diethrich Delicate Vascular Tissue Forceps	50, 548
		DeBakey® Diethrich Diama-Grip Tissue Forceps.....	548

DeBakey® Endarterectomy Scissors.....	669
DeBakey® Femoral Bypass Tunneler.....	799
DeBakey® Fiberoptic Illuminated Suction Tube.....	249
DeBakey® Full Curved Aortic Aneurysm Clamps.....	654
DeBakey® Gelpi Retractor, Short Model.....	226
DeBakey® Graspers.....	1139
DeBakey® Hysterectomy Clamp.....	267
DeBakey® Lung Grasping Forceps.....	558
DeBakey®-Metzenbaum Dissecting Scissors.....	129, 670
DeBakey® Miniature Anastomosis Clamp.....	593
DeBakey® Modified Semb Ligature Carrier.....	555
DeBakey® Multipurpose Angled Clamps.....	634
DeBakey® Multipurpose Vascular Clamps.....	582
DeBakey® Multipurpose Vascular Clamps Long.....	583
DeBakey® Partial Occlusion Clamps.....	580
DeBakey® Patent Ductus Clamps.....	586, 619
DeBakey® Pediatric and Adult Vascular Clamps.....	584
DeBakey® Pediatric Multipurpose Clamps.....	594
DeBakey® Potts Scissors.....	660
DeBakey® Renal Artery Clamp.....	613
DeBakey® Right Angle Forceps.....	78
DeBakey® Ring Handle Bulldog® Clamps.....	604
DeBakey® Scissors.....	129, 669
DeBakey® Spoon Clamps.....	581
DeBakey® "S" Shaped Peripheral Vascular Clamp.....	615
DeBakey® Suction Tubes.....	249, 768
DeBakey® Tangential Occlusion Clamps.....	635
DeBakey® Technique® Needle Holders.....	172, 676
DeBakey® Thoracic Dissecting Forceps.....	96
DeBakey® Thoracic Tissue Forceps.....	49, 546
DeBakey® Tissue Forceps.....	252
DeBakey® Titanium Bulldog® Clamps.....	705
DeBakey® Titanium Needle Holder.....	711
DeBakey® Titanium Pediatric Clamps.....	697
DeBakey® Titanium Ring Handle Needle Holders.....	711
DeBakey® Titanium Tissue Forceps.....	52, 690
DeBakey® Titanium Vascular Clamps.....	699
DeBakey® Ultralight Forceps.....	50, 547
DeBakey® Valve Hook.....	760
DeBakey® Valve Scissors.....	670
DeBakey® Vascular Dilators.....	771
DeBakey® Vascular Scissors.....	661
DeBakey® Vascular Tissue Forceps.....	50, 546
Deborah-Castaneda Partial Occlusion Clamps.....	587
Deborah-Castaneda Peripheral Vascular Clamps.....	588
Decannulation Stoppers.....	490
Decker IVD Rongeur.....	1056
Dedo Laser Micro-Laryngoscope.....	402
Dedo-Pilling® Laser Laryngoscope Extra-Long.....	403
Dedo-Pilling® Micro-Laryngoscope.....	398
Dedo Table-Mounted Mayo Tray.....	414
Deep Deaver Retractors.....	211
Deep Rake Retractors.....	196, 882
Deklene® Maxx™ Polypropylene Suture.....	1158
De Lee Cervical Grasping Forceps.....	264
De Lee Obstetrical Forceps.....	272
De Lee Universal Retractor.....	288
Delicate Operating Scissors.....	114
Delicate Wire Cutter.....	823
Demartel Acutely Angled Scissors.....	129
Demartel Scissors.....	130
Demel Wire Guides.....	848
Demos Tibial Artery Clamp.....	615
Denhardt Mouth Gag.....	530
Denis Micro Ring Forceps.....	555
Denis Titanium Micro Forceps.....	692
Denis Anastomosis Clamp.....	97
Derf Needle Holders.....	153
Derf Needle Holder Standard – Stainless Steel Jaw.....	154
Derf Titanium Ring Handle Needle Holder.....	712
Derra Miniature Anastomosis Clamps.....	620
Derra Partial Occlusion Clamps.....	589
Derra Titanium Anastomosis Clamps.....	698
D'errico-Adson Retractor.....	900
Deschamps Ligature Carriers.....	316
Desjardin Gallstone Grasping Forceps.....	97
Desmarres Chalazion Forceps.....	1104
Desmarres Lid Retractors.....	199
Desmarres Valve Retractors.....	754
Devine-Millard-Aufrecht Nasal Retractor Fiberoptic Lighting.....	217
Diamond Pin Cutter.....	828
Diethrich Bulldog® Clamps.....	563
Diethrich Caval Occlusion Clamp.....	621
Diethrich Coronary Artery Clamp.....	621
Diethrich Delicate Angled Coronary Scissors.....	664
Diethrich-Potts Vascular Scissors.....	664
Diethrich Right Angle Clamps.....	79
Digitate-Heifetz Needle Holders.....	686, 1115
Digitate-Heifetz Scissors.....	134, 1110
Dilator Instrument Trays.....	325
Dilators.....	
Amato Design, Vascular.....	770
Cooley Design, Vascular.....	770
DeBakey® Design, Vascular.....	771
Dilators, Sounds and Needles.....	297
Esophageal Bougies.....	471
Garrett Design, Vascular.....	772
Hiebert Design, Vascular.....	773
Laryngeal Dilators.....	472
OB/GYN.....	274
Ophthalmic.....	1120
Tracheal Dilators.....	491
Valve Dilators.....	762
Dingman Forceps.....	943
Dingman Mouth Gag.....	528
Dingman Zygoma Hook.....	194
Dissectors and Elevators.....	949
Cobb Elevators.....	961
Double-Ended Elevators.....	953
Endarterectomy Dissectors.....	795
Endoscopic Elevators.....	963
Laparoscopic Dissector.....	1129
Metatarsal Elevators.....	954
Penfield Elevators/Dissectors.....	952
Periosteal Elevators.....	955
Specialty Elevators.....	964
Dittel Urethral Sounds.....	297
Dix Spud and Needle.....	1121
Doering Carotid End Point Micro Rongeur Forceps.....	609

Feder-Ossoff Micro-Laryngeal Grasping Forceps	422
Feder-Ossoff Micro-Laryngeal Scissors.....	424
Feder-Ossoff Phonosurgery Instrument Tray.....	426
Feilchenfeld Splinter Forceps	34
Female Catheter Silvers	299
Ferguson-Frazier Suction Tubes.....	245
Ferguson Long Dissecting Scissors.....	130, 670
Ferguson Bone Holding Forceps	921
Ferris-Smith Endoscopic IVD Rongeurs.....	1061
Ferris-Smith Endoscopic Kerrison Rongeurs.....	1054
Ferris-Smith IVD Rongeurs.....	1061
Ferris-Smith Kerrison Punches.....	1053
Ferris-Smith Kerrison Rongeurs.....	1052
Ferris-Smith Tissue Forceps.....	52
Fess Sinoscopy Forceps	516
Fiber Optic Instrument Cable End Adapters	468
Fibula Bone Holding Forceps.....	921
Filters.....	373
Fine Stitch Scissors	1108
Finger Ring Cutter.....	1086
Finochietto Needle Holder.....	172
Finochietto Retractors	733
Finochietto Rib Retractor.....	729
Finochietto Thoracic Forceps	79
Finochietto Titanium Sternal Retractor.....	715
Fisher Tonsil Knife and Dissector	535
"Fish Hook" Neuro Elastic Retractors.....	369
Fitch Obturators	796
Five Finger Fan.....	1146
Flash Trays.....	326
Flat Nose K-Wire Pliers	840
Flat Nose Pliers.....	837
Flexible Rake Retractor Skin Hooks	187
Flexible Rulers.....	1077
Floor Grade Instruments	351
Forceps	351
Needle Holders.....	355
Scissors.....	356
Flush Wire Cutter	826
Fluvog Slide Attachment for Pilling® Bronchoscopes.....	443
Foerster Sponge Forceps.....	27, 252
Foman Nasal Scissors	514
Foman Rasp	971
Fomon Lower Lateral Scissors	515
Fomon Retractor.....	187
Foraminotomy Punches.....	1055
Forbes Esophageal Specula	452
Forceps	
Bariatric	251
Biopsy Cup Forceps.....	1133
Bipolar.....	1150
Bone Cutting Forceps.....	1015
Bone Holding Forceps.....	914
Bone Reduction Forceps.....	928
Chalazion Forceps	1104
Cilia Forceps	1103
Columella Forceps.....	1105
CVT	546
Delivery Forceps.....	264
Dressing Forceps.....	36, 1096
Ear Forceps.....	496
Electrosurgical.....	1154
Extended Length/Open Bariatric Forceps	251
Extra Delicate Hemostatic Forceps	75
Fixation Forceps.....	1105
Floor Grade Forceps	351
Gastrointestinal Forceps	89
General.....	23
Grasping Forceps	456, 1129
Hemostatic Forceps	58
Jeweler's Forceps	1102
Laparoscopic	1129
Laryngoscope Forceps.....	418
Laser Scope Forceps	434
Micro Forceps.....	427, 552
Micro Tying Forceps.....	553
Mosquito Forceps.....	64
Nail Forceps.....	1068
Nasal Forceps.....	507
OB/GYN	292, 264
Ophthalmic	1096
Pediatric Scope Forceps.....	462
Rectal Forceps	300
Scleral Forceps	1105
Screw Holding Forceps	873
Screw Removal Forceps	835
Splinter Forceps	34
Sponge Forceps.....	27
Tissue Forceps.....	43, 546, 1098
Tying Forceps	1100
Urology Forceps	294
Wire Cutting Forceps	823
Forceps Cases.....	332
Forceps, Titanium	688
Hemostatic Forceps	694
Micro Forceps.....	692
Tissue and Dressing Forceps.....	52, 688
Foreign Body Needles and Spuds.....	1121
Fox Curettes	313
Fox Eye Shield with Goffman Eye Garters	1125
Frazier Dura Hooks	879
Frazier Hooks.....	878
Frazier Laminectomy Retractor	912
Frazier Suction Tubes.....	245
Freeman Face Lift Retractor	197
Freer D Model Septum Knife	510
Freer Double-End Elevator.....	505, 719, 795, 953
Freer Retractor	188
Freer Skin Hook.....	188
Friedman Rongeur.....	1021
Frontal Sinus Curettes.....	518
Frontal Sinus Forceps.....	518
Frontal Sinus Thru-Cut Forceps	517
Front and Side Wire Cutter	826
Fukuda Style Shoulder Retractors	887
Fukushima Suction Tubes	248
Fully Insulated Suction Tube.....	464

G

Gabbay Frater Suture Organizer.....	1158
Garrett Dilator Holders.....	773
Garrett Vascular Dilators.....	772
Garrigue Weighted Vaginal Speculum.....	287
Gauze Flat Sponges.....	360
Gelpi Retractors.....	226
Gelpi-Seletz Retractor.....	227, 902
Gelpi Standard Retractor.....	226
Gemini Forceps.....	80
Gerald DeBakey® Tissue Forceps.....	53, 550
Gerald Diama-Grip Dressing Forceps.....	551
Gerald Dressing Forceps.....	39, 252, 549
Gerald Tissue Forceps.....	52, 550
Gerald Titanium Dressing Forceps.....	691
Gerald Titanium Tissue Forceps.....	691
Gerbode-Burford Adult Retractor.....	740
Gerbode-Burford Child Retractor.....	731
Gerbode Patent Ductus Clamp.....	636
Gerbode Sternal Retractors.....	741
Gerbode Technique® Needle Holder.....	173, 677
Gerbode Valve Dilator.....	762
Gerzog Bone Mallet.....	1010
Giannini Technique® Needle Holder.....	181, 681
Gigli Saw Blades.....	1071
Gillies Titanium Tissue Forceps.....	691
Gillies Converse Skin Hooks.....	188
Gillies Hooks.....	878
Gillies Needle Holder Scissors.....	155
Gillies Zygoma Elevator.....	506
Glenoid Perforating Forceps.....	914
Glover Atrial Appendage Clamp.....	636
Glover Coarctation Clamps.....	637
Glover Curved Clamps.....	638
Glover Curved Miniature Pediatric Clamp.....	595
Glover Patent Ductus Clamps.....	638
Glover Right Angle Curved Clamps.....	639
Glover Spoon Shaped Clamps.....	639
Glover Style Bulldog® Clamps.....	564
Glover Titanium Auricular Clamp.....	701
Glover Titanium Coarctation Vascular Clamps.....	701
Goelet Retractor.....	206
Goldman-Fox Scissors.....	145
Goldman Septum Displacer.....	505
Golf Stick Knives.....	1090
Gomco® Circumcision Clamps.....	271
Gomez/Poly-Tract Rail Clamps.....	244
Gordon Bead Grasping Forceps.....	457
Gorney Rhytidectomy Scissors.....	123
Goulian Depth Gauge and Guards.....	26
Goulian Skin Graft Knife Set.....	25
Grabber Fenestrated Forceps.....	1137
Gradle Scissors.....	136, 1113
Graefe Eye Dressing Forceps.....	1097
Graefe Eye Speculum.....	1119
Graefe Fixation Forceps.....	1105
Graefe Strabismus Hooks.....	1116
Graefe Tissue Forceps.....	53
Grant Abdominal Aortic Aneurysm Clamps, “Texas Twister”.....	655
Graves Vaginal Specula.....	285
Gray Cystic Duct Forceps.....	80
Green Retractor.....	199
Greg Comdone Extractor.....	314
Gregory Carotid Angled Bulldog® Clamp.....	606
Gregory Internal Carotid “Soft” Bulldog® Clamp.....	606
Gregory Miniature Vascular Clamps.....	605
Gregory Profunda Clamps.....	622
Gregory Technique® Suture “Stay” Clamps.....	186, 681
Grieshaber Wire Retractors.....	218
Grooved Director and Tongue Ties.....	309
Grooved Directors.....	309
Gross Spoon and Hook.....	504
Gruber Ear Speculum.....	503
Gruenwald Bayonet Forceps.....	40
Grunwald Suture Guide Holder.....	758
Guidewire w/Drillpoint.....	864
Guilmet Titanium Dressing Forceps.....	692
Gunnar Roller Clamps.....	28
Guthrie Skin Hook.....	188
Guyon Catheter Guide.....	299

H

Haight Baby Retractor.....	732
Haight Retractors.....	216, 748
Haimovici Scissors.....	671
Hallman Tunneling Forceps.....	799
Halsey Needle Holders.....	155
Halsey Titanium Ring Handle Needle Holder.....	712
Halsted Mosquito Forceps.....	64
Halsted Mosquito Forceps with Teeth.....	64
Halsted Titanium Hemostatic Forceps.....	694
Hamburger-Brennan-Mahorner Retractor.....	239
Hand-Held Rod Cutter.....	833
Hank Uterine Dilators.....	275
Harken Clamps.....	640
Harrington Clamps.....	80
Harrington Extra Deep Retractors.....	212
Harrington Retractors.....	212
Harrington Spinal Elevator.....	965
Harrington Splanchnic Retractors.....	213
Hartmann Mosquito Forceps.....	65
Hartmann Alligator Forceps.....	497
Hartmann Ear Dressing Forceps.....	497
Hartmann Ear Speculum.....	502
Hartmann-Herzfeld Cup Forceps.....	499
Hartmann Rongeur.....	1026
Hasson “S”.....	1147
Hatfield Bone Curettes.....	981
Haverfield-Scoville Hemilaminectomy Retractor Body.....	909
Hayes Anterior Resection Clamps.....	98
Hayes Hand Retractors.....	891
Healon Injection Cannula.....	1122
Healy-Jako Pediatric Subglottiscope.....	408
Heaney-Ballantine Hysterectomy Clamps.....	268
Heaney-Ballentine Clamps.....	257
Heaney Biopsy Curette.....	277
Heaney Bulldog® Needle Holder.....	168

Heaney Hysterectomy Forceps.....	267	Holinger Infant (Newborn) Slide Laryngoscope.....	392
Heaney Needle Holders.....	168, 261	Holinger Knife Handle.....	436, 535
Heaney-Simon Vaginal Retractor.....	288	Holinger Laryngeal Dissector.....	436
Heath Mallet.....	1013	Holinger Laryngeal Knife Handle.....	26
Heath Suture and Wire Cutting Scissors.....	113	Holinger Laryngectomy Tubes.....	487
Heavy Duty Locking Pliers.....	843	Holinger "Slotted" Anterior Commissure Laryngoscope.....	396
Hegar Baumgartner Needle Holders.....	165	Holinger Tracheostomy Tube.....	484
Hegar Uterine Dilators.....	276	Holinger Ventilating Fiberoptic Bronchoscope.....	440
Heiss Retractors.....	219	Holman Scope Brushes.....	447
Heiss Titanium Clamping Forceps.....	701	Holman Scope Brushes - for Bronchoscopes and	
Heitmiller Mini Thoracotomy Retractor.....	742, 782	Esophagoscopes.....	494
Hemoclip® Ligating Clip Accessories.....	386	Holman Trachea Tube Brushes.....	494
Hemoclip® Plus Titanium Ligating Clips.....	387	Holsher Nerve Retractors.....	880
Hemoclip® Plus Titanium Ligating Clip Applicators.....	387	Hook Biopsy Punch.....	1134
Hemoclip® Traditional Ligating Clip Applicators.....	386	Hook Scissors.....	1142
Hemoclip® Traditional Ligating Clip Precision Applicators.....	386	Hooks.....	
Hemoclip® Traditional-Stainless Steel Ligating Clips.....	386	Bone Hooks.....	938
Hemoclip® Traditional-Tantalum Ligating Clips.....	386	Muscle Hooks.....	1117
Hemoclip® Traditional-Titanium Ligating Clips.....	386	Ophthalmic.....	1116
Henly Popliteal Retractor.....	229	Strabismus Hooks.....	1116
Henly Subclavian Artery Clamp.....	623	Valve Hooks.....	760
Hennig Plaster Spreader.....	1075	Horizontal Retractor.....	904
Henrotin Vulsellum.....	283	House Alligator Forceps.....	497
Henrotin Weighted Vaginal Speculum.....	287	House Bellucci Mini Alligator Scissors.....	501
Heparin Cannula with Luer-Lok.....	766	House Curettes.....	496
Hepp-Scheidel Dissecting Scissors.....	1110	House Retractor.....	496
Hercules Plaster Scissors.....	103	House Strut Forceps.....	498
Herrick Kidney Clamp.....	294	Howard-DeBakey® Aortic Aneurysm Clamps.....	655
Hess Angular Mosquito Tip Serrefine.....	565	Howell Coronary Technique® Needle Holder.....	173, 677
Hexagonal Screwdrivers.....	866	Howell Valve Technique® Needle Holder.....	173, 677
Hexagonal Screwdriver Shaft.....	868	Hudson Drill and Burrs.....	853
Hexagonal Screwdriver Shaft (Pelvic).....	866	Hudson Drill Bits.....	852
Hex-Handle Osteotomes.....	511	Hudson Tissue Forceps.....	47
Hibbs and Brun Smartrack for 9" Instruments.....	987, 1083	Hufnagel Aorta Clamps.....	641
Hibbs Blades.....	910	Hufnagel Titanium Vascular Clamp.....	702
Hibbs Chisels.....	999	Hulka Tenaculum and Probe.....	281
Hibbs Endoscopic Gouge.....	1004	Humeral Head Retractor.....	888
Hibbs Endoscopic Osteotome.....	994	Hurd Dissector and Pillar Retractors.....	531
Hibbs Gouges.....	1003	Hurst Tungsten-Filled Esophageal Bougies.....	469
Hibbs Osteotomes.....	994	Hysterectomy Scissors.....	259
Hibbs Retractors.....	884		
Hiebert Double-Ended Vascular Dilators.....	773	I	
High Mayo Perforated Trays.....	328	IMA Retractor.....	722
Hi-Level Bandage Scissors.....	104	Impactor/Bone.....	1005
Hill Ferguson Rectal Retractors.....	303	Improved Balfour Retractors Interchangeable	
Hill Stitch Scissors.....	108	Side Blade Model.....	233
Hirschman Anoscopes.....	307	Improved Henly Retractors.....	229, 751
Hoen Alligator Forceps.....	944	Improved Henly Retractor Side Blades.....	230, 751
Hoen Hooks.....	879	Improved Tucker Mediastinoscope.....	776
Hohmann Retractors.....	892	In-Ex Adson Dressing Forceps.....	351
Hoke Chisels.....	999	In-Ex Adson Tissue Forceps.....	351
Hoke Osteotomes.....	991	In-Ex Allis Tissue Forceps.....	354
Hoke Smartrack.....	1081	In-Ex Backhaus Towel Clamps.....	352
Holinger Anterior Commissure Laryngoscopes.....	395	In-Ex Baumgartner Needle Holder.....	355
Holinger Aspiring Tubes.....	463	In-Ex Bozeman Uterine Dressing Forceps.....	355
Holinger Cup Biting Specimen Forceps.....	454	In-Ex Crile Forceps.....	353
Holinger Fiberoptic Esophagoscopes.....	450	In-Ex Edna Towel Clamp.....	352
Holinger "Hour Glass" Anterior Commissure		In-Ex Halsted Mosquito Forceps.....	353
Laryngoscopes.....	396	In-Ex Hoff Towel Clamp.....	352
Holinger Infant Esophageal Speculum.....	452		

In-Ex Iris Scissors.....	357
In-Ex Kelly Forceps	354
In-Ex Lister Bandage Scissors.....	356
In-Ex Littauer Suture Scissors.....	356
In-Ex Mayo Hegar Needle Holders.....	356
In-Ex Mayo Scissors.....	358
In-Ex Operating Scissors	357
In-Ex Rochester-Pean Forceps.....	354
In-Ex Sponge Forceps.....	353
In-Ex Thumb Forceps.....	351
In-Ex Webster Needle Holder.....	355
In-Ex Wire Scissors.....	357
Infant Retractor	206
Inge Retractor.....	906
Ingrown Nail Forceps.....	1068
Ingrown Nail Instrument #81.....	1069
Ingrown Nail Splitting Scissors	1070
Initial Incision (Charnley) Retractor.....	908
Inline Ratcheted Handle.....	1128
Insert Drill Sleeve.....	863
<i>In Situ</i> Rod Benders.....	874
<i>In Situ</i> Venous Valvulotome.....	775
<i>In Situ</i> Venous Valvulotome Sterilizing Case.....	774
Instrument Accessories.....	
Bowls.....	340
Brushes.....	346, 447, 494
Case and Tray Solutions.....	331
Cleaners and Lubricants	345
Containers and Trays.....	324
Instrument Holders and Stringers.....	341
Miscellaneous.....	350
Pilling® Case and Tray Solutions.....	330
Instrumentation for Bronchoscopes and	
Esophagoscopes.....	453
Biopsy Cup Forceps.....	453
Forceps for Pediatric and Laser scopes	462
Grasping Forceps.....	456
Suction Tubes.....	463
Telescopes and Accessories.....	445
Instrumentation for Laryngoscopes.....	418
Forceps.....	418
Laryngeal Mirrors	438
Laser Instrumentation.....	432
Micro-Laryngeal/Feder-Ossoff.....	422
Micro-Laryngeal/Jako	429
Micro-Laryngeal/Jako-Kleinsasser.....	427
Miscellaneous.....	436
Suction Tubes.....	421
Instrument Cleaning Brushes	346
Instrument Holders	343
Instrument Rack	344
Instrument Stringers.....	342
Instrument Tray.....	328
Insulated Cautery Suction Tube.....	421
Insulated Non-Rotating Handle	1128
Insulated Rotating Handle.....	1128
Insulated Suction Cautery Tube.....	777
Interchangeable Osteotome, Chisel and Gouge Set.....	996
Interchangeable Screwdriver Set.....	872
Intracardiac Titanium Ring Handle Needle Holders.....	713
Intraducer® Peritoneal Catheter	1160
Iodine Cup.....	340
Iowa Trumpet Needle Guide	293
Iris Dressing Forceps	40
Iris Miniature Scissors.....	136, 1113
Iris Ribbon Scissors.....	137, 151, 1114
Iris Scissors.....	137, 151
Iris Scissors with Barraquer Handle.....	135, 1110
Iris Tissue Forceps	54
Israel Rake Retractors	883
Israel Retractor.....	197
J	
Jackson Alligator Grasping Forceps.....	778
Jackson Alligator Grasping Forceps - Double-Action.....	456
Jackson Alligator Grasping Forceps - Extra Delicate.....	456
Jackson Alligator Grasping Forceps - Light Construction.....	456
Jackson Alligator Grasping Forceps - Standard.....	456
Jackson Cross Action Forceps	418
Jackson Cup Forceps - Extra Lightweight.....	779
Jackson Cup Forceps - Standard, Medium Lightweight.....	778
Jackson Direct or Anterior Commissure Laryngoscopes.....	394
Jackson Double Prong Grasping Forceps.....	458
Jackson Dull-Pointed Ring Rotation Forceps	458
Jackson Esophageal Dilators.....	471
Jackson Extra-Long Tracheostomy Tubes	
with Rotating Lock	476
Jackson Fenestrated Meat Grasping Forceps	458
Jackson Fenestrated Peanut Grasping Forceps	458
Jackson Fiber Optic Oval Esophagoscopes	451
Jackson Forceps Parts Kit.....	459
Jackson Forward Grasping Cup Forceps.....	459
Jackson Improved Style Trachea Tubes	
for use with Shikani Speaking Valve.....	479
Jackson Improved Tracheostomy Tubes	
made in Sterling Silver	478
Jackson Improved Tracheostomy Tubes - Regular Length	475
Jackson Improved Tracheostomy Tubes - Short Length.....	477
Jackson Improved Tracheostomy Tubes	
with 15 mm Adapter - Regular Length	477
Jackson Improved Tracheostomy Tubes	
with 15 mm Adapter - Short Length.....	478
Jackson Laryngeal Cup Forceps - Extra Lightweight	
2 mm Cups.....	419
Jackson Laryngeal Cup Forceps - Standard Lightweight	
4 and 6 mm Cups.....	418
Jackson Laryngeal Dilators	472
Jackson Laryngeal Scissors	429
Jackson Laryngectomy Tubes.....	487
Jackson Open End Aspirating Tube.....	421, 464
Jackson Original Tracheostomy Tubes - Regular Length.....	481
Jackson Original Tracheostomy Tubes - Short Length	481
Jackson Original Tracheostomy Tubes	
with 15 mm Adapter - Regular Length	482
Jackson Original Tracheostomy Tubes	
with 15 mm Adapter - Short Length	482
Jackson Rotation Forceps	457
Jackson Square Punch Specimen Forceps	454
Jackson Standard Fiber Optic Slide Laryngoscopes.....	393

Jackson Standard Sponge Carrier	436
Jackson Tracheal Hemostat.....	81
Jackson Tracheal Retractor, Double-Ended	193, 492
Jackson Tracheal Tenaculum.....	192, 492
Jackson Trachea Retractor	194, 493
Jackson Triangular Punch Specimen and Tissue Forceps	419
Jackson-Trousseau Tracheal Dilators.....	491
Jackson Vaginal Retractors.....	289
Jackson "Velvet-Eye" Aspirating Tubes.....	421, 463
Jacobson Bulldog® Clamps.....	565
Jacobson Hemostatic Forceps	75
Jacobson Micro Needle Holder.....	181, 684
Jacobson Micro-Surgical Needle Holders	182, 685
Jacobson Micro Titanium Needle Holders	709
Jacobson Titanium Castroviejo Needle Holders	709
Jacobson Vascular Scissors.....	674
Jacob's Vulsellum Forceps	283
Jako-Cherry Micro-Laryngoscope Type II (Newborn)	398
Jako Coagulation Probe.....	429
Jako Fine Ball Tip Hook.....	429
Jako Fine Sponge Carrier.....	436
Jako Fine Suction Tubes.....	430
Jako-Kleinsasser Micro-Laryngeal Cup Forceps.....	427
Jako-Kleinsasser Micro-Laryngeal Grasping Forceps	428
Jako-Kleinsasser Micro-Laryngeal Scissors.....	428
Jako Micro-Laryngoscope Type III.....	397
Jako Mirror.....	430
Jako Rigid Stem Instruments	431
Jako Sickle Knife	430
Jameson Muscle Hook.....	1117
Jamison-Metzenbaum Tenotomy Scissors	132, 671
Jamison Technique® Needle Holder	174, 678
Jansen Bayonet Dressing Forceps	41
Jansen Curette	981
Jansen-Middleton Nasal Rongeurs	509
Jansen Retractors	220
Jarcho Tenaculum.....	281
Javid Carotid Shunt Clamps	607
Jehle Sterile Coronary Catheters	763
Jennings Mouth Gag.....	529
Jesberg Fenestrated Grasping Forceps.....	459
Jesberg Oval Esophagoscopes.....	449
Jeweler's Forceps	1102
Johns Hopkins (Blalock) Bulldog® Clamps	566
Johnson Bulldog® Needle Holder.....	156
Johnson Needle Holder	156
Johnson Neuroma Retractor	228
Johnson Skin Hook	189
Johnson-Tucker Hook and Fork.....	1087
Jones Cross-Action Towel Forceps	33
Jones Hemostat	67
Jorgenson Scissors.....	122, 259
Joseph Bone Saws	1072
Joseph Periosteal Elevator	506
Joseph Rasp	512, 971
Joseph Scissors.....	138
Joseph Skin Hooks.....	189
Judd-Allis Intestinal Forceps.....	91
Julian Needle Holder	174
K	
Kahler Grasping Forceps.....	460
Kaiser-Pilling® Andrews Suction.....	793
Kaiser-Pilling® Angle Sickle Knife.....	792
Kaiser-Pilling® Biopsy Forceps	792
Kaiser-Pilling® Blunt Hook	792
Kaiser-Pilling® DeBakey®-Type Allis Ring Forceps	791
Kaiser-Pilling® DeBakey®-Type Ring Forceps.....	791
Kaiser-Pilling® Hook	793
Kaiser-Pilling® Long Jaw Ring Forceps.....	789
Kaiser-Pilling® Short Jaw Ring Forceps.....	788
Kaiser-Pilling® Spatula	793
Kaiser-Pilling® Suction with Thumb Valve	794
Kaiser-Pilling® Thoracoscopic Forceps	790
Kaiser-Pilling® Tray.....	794
Kantrowitz Forceps	81
Kantrowitz Right Angle Forceps.....	254
Kartchner Internal Carotid Clamp	610
Kay Aortic Anastomosis Clamp.....	643
Kaye Scissors.....	138
Kay-Lambert Aortic Anastomosis Clamp	642
Kay Titanium Vascular Clamp	702
"K" Dissector Sponges.....	361
Kelly Fistula Scissors.....	139
Kelly Forceps	67
Kelly Placenta Clamp.....	264
Kelly Retractors	213
Kelly Vulsellum	283
Kelman-Mcpherson Forceps.....	1100
Kern Bone Holding Forceps.....	922
Kerrison Cleanpunch® 2 Laminectomy Rongeurs.....	1045
Kerrison Multi-Bite Punches.....	1055
Kerrison Rongeur	1054
Kerrison Thru-Cut Rongeurs.....	517
Kevorkian-Younger Cervical Biopsy Forceps.....	269
Kevorkian-Younger Biopsy Curette	278
Kevorkian-Younger Curettes.....	278
Keyes Dermal Skin Punches.....	314
Keyhole Brackets.....	338
Key Periosteal Elevator	956
Key Periosteal Elevators.....	956
Killian Nasal Speculums.....	520
Kirklin Sternal Awls	746
Kirk Mallet	1013
Kirmission Periosteal Rasp	974
Kirschner Bows	848
Kirschner Wires.....	808
Kirschner Wires, Steinmann Pin, Vickers K-Wire Dispensers	811
Kleinert-Kutz Bone Rasp.....	972
Kleinert-Kutz Double Action Rongeur.....	1030
Kleinert-Kutz Elevator and Dissector	506, 953
Kleinert-Kutz Micro Clip Applying Forceps	321, 570
Kleinert-Kutz Micro Vessel Clips.....	317, 569
Kleinert-Kutz Rasp	513, 972
Kleinert-Kutz Skin Hooks	189
Kleinert-Kutz Synovectomy Rongeur	1022, 1028
Kleinert-Kutz Tendon Retrievers	945
Kleinert-Ragnell Retractor	204
Kleinert-Kutz Hook.....	190

Klintmalm™ Liver Transplant Clamps.....	98
KMedic® Cable Cutter	832
KMedic® Cast Spreader	1076
KMedic® Cleanpunch® Rongeurs	1043
KMedic® Comdone Extractor (Walton)	314
KMedic® Corwin Wire Twister	819
KMedic® End Cutter.....	827
KMedic® Gratloch™ Wire Bender.....	815
KMedic® Jet Wire Twister	821
KMedic® Large Pin Cutter.....	830
KMedic® P.I. Wire Twister and Tightner.....	820
KMedic® Side Cutter	824
KMedic® Skin Hook	190
KMedic® Spinal Rongeurs and Punches.....	1041
KMedic® Table Top Rod Cutter	834
KMedic® Utility Shears.....	104
KMedic® Wire and Pin Implants	810
KMedic® Wire and Pin Cutters.....	822
KMedic® Wire Cutter with Safety Inserts.....	825
Knapp Iris Scissors.....	139
Knife Handles	23
Extended Length/Open Bariatric.....	251
General.....	25
Specialty	23, 25
Knives	
Cartilage Knives	446
Nasal Knives	510
Nucleus Knife	1119
Ophthalmic	1119
Knight Nasal Scissors.....	515
Knives and Knife Handle	425
Knowles Bandage Scissors	104
Kocher Intestinal Clamps	99
Kocker X-Action Forceps.....	255
Kogan Endocervical Speculum	286
Kolbel Soft Tissue Retractor	899
Krause Nasal Snares.....	519
Kuntscher Diamond Pointed Awl.....	939
Kuntscher Extractors	1093
Kuntscher Reamer.....	1093
Kuntscher Skin Protector.....	1093
Kuntscher X-Ray Scale.....	311, 1077
Kuyper-Murphy Sternal Retractors.....	737
K-Wire and Plate Bender.....	812
K-Wire Bender	812
K-Wire End Cutter	827
K-Wire Extraction Pliers	839
K-Wire Side Cutter.....	824
L	
Laborde Tracheal Dilator.....	491
Lacrimal Cannula.....	1122
Lacrimal Probe	1120
La Force Adenotomes.....	523
La Grange Scissors.....	140
Lahey (Baby Metz) Scissors.....	124
Lahey Dissecting Forceps	82
Lahey Finger Retractors.....	194
Lahey Gall Duct Forceps, Slender Blades	82
Lahey Retractor	200
Lahey Traction Forceps.....	68
Lambert-Kay Aortic Anastomosis Clamp	642
Lambert-Lowman Bone Clamps.....	935
Lambotte Bone Holding Forceps	922
Lambotte Osteotomes, Curved 9".....	990
Lambotte Osteotomes, Straight 7"	989
Lambotte Osteotomes, Straight 9"	990
Lambotte-Style Osteotomes.....	511, 988
Lambotte Smartrack.....	970
Lamina Spreaders.....	907
Laminectomy Wedge Sponges.....	362
Landreneau Thoracoscopy Tray.....	786
Landreneau Thoracoscopy Set	786
Lane Bone Holding Forceps.....	923
Lane Periosteal Elevator	958
Langenbeck Bone Holding Forceps.....	920
Langenbeck Metacarpal Saw.....	1072
Langenbeck Periosteal Elevator	958
Langenbeck Retractors	200, 882
Lap Chole Instrument Inserts	333
Laparoscopic Instruments	1126
10 mm Dissectors	1132
5 mm Bipolar Forceps	1135
5 mm Dissectors, Grasping Forceps.....	1129
5 mm Needle Holders.....	1141
5 mm Ratcheted Graspers.....	1136
5 mm Scissors.....	1142
5-10 mm Biopsy Forceps.....	1133
Cords and Cables.....	467
Electrodes, Coagulators	1144
Handle Types	1128
Retractors	1146
Telescopes	1145
Trays.....	1143
Large Countersink.....	859
Large Hexagonal Screwdriver	867
Large Hexagonal Screwdriver (Pelvic)	867
Large Hex Screwdriver with Universal Joint.....	867
Large Hex Screwdriver w/T-Handle	871
Larry Probe and Groove Director	308
Laryngeal Micro Atomizer	438
Laryngeal Mirrors.....	438, 526
Laryngoscope and Laser Laryngoscope	390
Laryngoscope Holders	413
Laryngoscopes/Monocular View	391
Laser Micro-Laryngoscopes	402
Micro-Laryngoscopes/Binocular View.....	397
Teeth Guards.....	391
Venturi Anesthesia Devices	416
Video Laryngoscopes.....	411
Laryngoscope and Instrumentation	418
Laser Instrumentation.....	432
Micro-Laryngeal/Feder-Ossoff	422
Micro-Laryngeal/Jako	429
Micro-Laryngeal/Jako-Kleinsasser	427
Miscellaneous	436
Ossoff Double-Action Posterior Commissure	
Laryngoscope	407
Pilling® Laser Laryngoscopes	401

Mayo Hegar Broad Bulldog® Needle Holders	167	Micro Clamp Applicator	321
Mayo Hegar Needle Holders	165	Micro Clip Tray	323, 574
Mayo Hegar Titanium Ring Handle Needle Holders.....	713	Micro Diama-Grip Ring Forceps	554
Mayo Masson Needle Holder	262	Micro Dissectors.....	1130
Mayo Noble Scissors	119	Micro Friedman Rongeurs	1020
Mayo-Pean Forceps.....	69	Micro Grasping Forceps.....	552
Mayo-Robson Intestinal Clamps	100	Micro Instrument Trays.....	325
Mayo Round Surface Blade Scissors	117	Micro-Laryngeal Forceps.....	427
Mayo Scissors.....	259	Micro-Laryngeal Probes - Ebonized	435
Mayo-Stille Scissors	119	Microminiature Alligator Forceps.....	497
Mayo Trays.....	328	Micro Mosquito Forceps	76
Mayo Vessel Clamp.....	295	Micro-Reill Scissors.....	1107
McAllister Bulldog® Needle Holder	169	Micro Ring Tip Forceps.....	554
McBurney Retractor	201	Micro Scissors	1142
McClure Iris Scissors.....	134, 675, 1107	Micro-Spring Scissors.....	1107, 1111
McDougal™ Prostatectomy Clamps	295	Micro Subglottic Instruments	410, 434
McGivney Forceps.....	301	Micro Surgery Needle Holders	178, 685
McGlamery® Metatarsal Elevator	954	Micro Surgery Technique® Needle Holders	181, 682
McIndoe Bone Cutting Forceps.....	1015	Micro Surgical Cases.....	334
McIndoe Titanium Tissue Forceps	692	Micro Tip.....	1135
McIvor Mouth Gag.....	529	Micro Titanium Castroviejo Needle Holders.....	709
McKenty Elevator	506, 955	Micro Titanium Diama-Grip Tying Forceps.....	693
McLean-Tucker-Luikart Obstetrical Forceps	272	Micro Titanium Scissors	706
McPherson Tissue Forceps.....	1099	Micro Tying Forceps.....	553, 1100
McPherson Tying Forceps.....	1100	Micro Vascular Anastomosis Scissors	674
Mead Mallet.....	1010	Micro Vascular Nerve Hook	761
Mead Rongeur	1026	Micro Vascular Round Handle Needle Holders.....	177, 685
Measuring Devices	1077	Micro Vascular Scissors	665
Calipers.....	1078	Micro Vascular Titanium Ring Handle Needle Holders	714
Rulers.....	311, 1077	Milan-London Vacuum Tube.....	291
Specialty	1079	Miller-Senn Retractors	209
Measuring Guidelines and Common Jaw Patterns of Surgical Instruments.....	18	Mills Valvulotome	774
Mediastinal Blunt-Tipped Dissecting Forceps	779	Mini-Aneurysm Bulldog® Clips and Appliers	574
Mediastinoscopy	776	Miniature Eye Scissors.....	1112
Clips and Appliers.....	781	Miniature Satinsky Reynolds Clamps	595
Instrumentation.....	777	Mini Countersink	858
Mediastinoscopes.....	776	Mini Cruciform Screwdriver Bit.....	870
Scope Holders	780	Mini Freidman Fongeurs.....	1021
Medicine Cup.....	340	Mini Hexagonal Screwdriver.....	868
Medium Pin Cutter	829	Mini Hohmann Retractors.....	891
Meeker Dissecting Forceps.....	785	Mini-Lambotte Osteotomes, Straight 5".....	988
Meeker Hemostatic Dissecting Forceps.....	83	Mini Mallet.....	1007
Meltzer Adenoid Punch.....	535	Mini Osteotomes.....	511, 991
Meniscus Clamps.....	943	Mini Plate Bending Iron	876
Metal Clip Removers	383	Mini Plate Bending Pliers.....	845
Metal Labels	372	Mini Quick Coupling Handle	854
Metzenbaum Scissors	125, 128, 260	Mini Weck® Micro Vessel Approximator.....	318
Metzenbaum Scissors, Curved	785	Mirrors	526
Metzenbaum Scissors, Delicate.....	124	Laryngeal Mirrors	526
Meyering Blades.....	909	Miscellaneous CVT	795
Meyering Finger Retractors.....	202	Endarterectomy Dissectors.....	795
Meyering Laminectomy Retractors	883, 901	Marking Rings	796
Meyhoeffer Curettes	1118	Obturers.....	796
M.G.H. Vulsellum.....	284	Tourniquet Stylets	797
Michel Clip Applying Forceps.....	322	Tunnelers	798
Michel Clip Forceps.....	322	Miscellaneous General	309
Michele Trepphine.....	865	Dermal Instruments	314
Michel Skin Clips	322	Ligature Carriers and Wire Passers.....	316
Micro-Aneurysm Bulldog® Clips and Appliers	573	Measuring Devices.....	311
		Probes, Cannulae and Dilators.....	309

Miscellaneous Orthopedic	1085	Forceps	507
Diagnostic Instruments.....	1086	Knives	510
Lead Hands.....	1085	Miscellaneous	522
Ring Cutters.....	1086	Osteotomes.....	511
Specialty Hand Instruments.....	1087	Raspatories.....	511
Mitchell-Adam Multipurpose Clamp.....	624	Scissors.....	514
Mitchell Aortotomy Clamp	644	Sinus Instruments	516
Mixer Clamps	84	Snares	519
Mixer Dissecting Forceps	84	Specula.....	520
Mixer Dissector.....	1129, 1132	Nasal Snare Wires	519
Mixer Forceps	85, 99	Needle Holders	
Mixer Gall Duct Forceps	85	Bariatric	261
Mixer "Pedi" Gall Duct Forceps	86	Berry Sternal Technique® Needle Holder.....	185
Mixer Right Angle Forceps.....	254	Castro-Type Micro Needle Holders	177, 683
Mixer Thoracic Forceps.....	84	CVT-Type Needle Holders.....	171
Moisture Barrier for CO ₂ Coupler-Manipulator	442	Extended Length/Open Bariatric.....	261
Moleskin Scissors.....	106	Floor Grade Needle Holders	355
Moore Drill and Bit Set.....	850	General Needle Holders	152
Mooreland Rongeur.....	1055	Intracardiac Technique® Needle Holders.....	715
Morris Ascending Aorta Clamps.....	645	Laparoscopic	1145
Morse-Andrews Suction Tube	250, 767	Micro Needle Holders	178, 685
Morse Sternal Retractors with Double Blades	734	Ophthalmic	1121
Morse Towel Clip Tubing Holders.....	28	Pilling® Extra-Light Technique® Needle Holders.....	174
Morse Valve Retractor.....	754	Suture Tags.....	186
Mosquito Forceps.....	65	Wire Twisters.....	184
Mosquito Forceps Serrated.....	66	Needle Holders, Titanium	709
Mouth and Throat Instruments	523	Flat Handle Micro Needle Holders	710
Adenotomes/Tonsillectomes.....	523	Ring Handle Needle Holders.....	711
Curettes	524	Round Handle Micro Needle Holders.....	709
Forceps	525	Needle Nose Locking Pliers.....	843
Laryngeal Mirrors	526	Needle Nose Pliers	835
Miscellaneous	535	Neivert-Eve Tonsil Snare.....	533
Mouth Gags	526	Neivert Needle Holder	157
Retractors	530	Nelson Lobectomy Scissors.....	131
Scissors.....	532	Nelson Metzenbaum Scissors.....	260
Snares	533	Nelson Metzenbaum Super-Cut Scissors	260
Mueller Capsule Scissors.....	947	Nelson Scissors	131
Mueller Rake Retractor	196	Nelson Tissue Forceps	55, 551
Multipurpose Stainless Steel Trays.....	327	Nerve Root Retractor	880
Murphy Bone Skid	886	Neuro Caliper.....	1078
Murphy Rake Retractors	195	Neurofeel Micro Scissors.....	674
Mycotic Nail Nippers.....	1064	Neuro Sponges	362
Myringotomy Knife.....	504	Nevins Forceps	42
		News Trachea Retractor.....	192, 492
		Nextstitch® Valve Suture.....	1158
		Nicholas-Jehle Sterile Multi-Headed Perfusion Catheter	763
		Nichols Tubing Holder.....	29
		Nolan Needle Holders	263
		Non-Insulated Non-Rotating Handle.....	1128
		Non-Insulated Rotating Handle	1128
		Non-Perforated Container Bottom	370
		Norris Sponge Holding Forceps	420, 780
		Norris Tracheostomy Buttons.....	489
		Northbent Stitch Scissors	109
		Noyes Ear Forceps.....	498
		Noyes Nasal Alligator Forceps.....	507
		Nucleus Knife	1119
		Nylon Head Mallet Faces	1009
		Nylon Head Mallets	1009

N

N-Compass™ Instrument Management System.....	14
Nail Instruments	1064
Forceps	1068
Nippers	1064
Scissors.....	1069
Splitters.....	1066
Nail Nippers.....	1065
Nail Rasp #93.....	968
Nail Scissors	1070
Nail Splitters.....	1066
Narrow Nose Wire Pulling Forceps	835
Narrow Tip Mallet.....	1007
Nasal Instruments	505
Elevators	505

O

OB/GYN	264
Biopsy Punches.....	268
Circumcision Clamps.....	271
Currettes.....	277
Delivery Forceps.....	272
Forceps and Clamps.....	264
Laser Instruments.....	290
Miscellaneous.....	293
Probes, Sounds and Dilators.....	274
Retractors.....	288
Scissors.....	273
Specula.....	285
Tenaculums and Vulsellums.....	280
Obturator.....	796
Ochsner-Favaloro Improved Retractor Set	
with Rail Clamps.....	725
Ochsner-Favaloro Retractor Parts.....	726
Ochsner-Favaloro Retractor Set.....	726
Ochsner Forceps (Kocher).....	71
Ochsner Ribbon Retractors.....	216
O'Conner Skin Hook.....	190
O'Connor Hook.....	1117
Offset Metzenbaum Scissors.....	672
Oldberg IVD Rongeur.....	1060
Olivekrona Double-End Dissectors.....	795
Ollier Rake Retractor.....	197, 883
Olsen-Hegar Needle Holder and Scissors.....	160
Olsen-Hegar Needle Holders.....	161
One-Handed Rod Bender.....	874
O'Neill Double Curved Clamp.....	646
Open Surgical Appliers.....	383
Operating Scissors	115
Operating Scissors, B/B.....	115
Operating Scissors, S/B.....	115
Operating Scissors, S/S.....	115
Operating Scissors, TC.....	116
O'Reilly Esophageal.....	1147
Original Henly Popliteal Retractor.....	228, 752
Orthopedic Mallets.....	1012
Orthopedic Retractors	878
Hand-Held Orthopedic Retractors.....	878
Hohmann Retractors.....	891
Self-Retaining Orthopedic Retractors.....	896
Shoulder and Knee Retractors.....	887
O'Shaughnessy Titanium Clamping Forceps.....	703
Ossoff Adult Subglottiscopes.....	409
Ossoff-Karlan-Dedo Laser Micro-Laryngoscopes.....	404
Ossoff-Karlan Grasping Forceps - Ebonized.....	435
Ossoff-Karlan-Jako Laser Micro-Laryngoscope.....	405
Ossoff-Karlan Micro Suction Tube - Ebonized.....	435
Ossoff-Karlan Posterior Commissure Micro-Laryngoscope.....	406
Ossoff-Karlan Vocal Cord Roller - Ebonized.....	436
Ossoff Micro Suction Tube Ebonized.....	291
Ossoff-Pilling® Micro-Laryngoscope.....	400
Ossoff-Pilling® Micro-Laryngoscope (Laser Finish).....	405
Osteotome Case.....	334
Osteotomes	988
Cobb.....	995
Hibbs.....	994
Hoke.....	991
Interchangeable Osteotome, Chisel and Gouge Set.....	996
Lambotte.....	988
Nasal.....	511
Sheehan.....	992
Silver.....	992
Smartrack.....	997, 1083
Smith-Peterson.....	995
Specialty.....	991
Stille.....	993
U.S. Army.....	993
Osteotome Smartrack.....	1083
O'Sullivan-O'Connor Abdominal Retractors.....	236
Oval Rings, for Circuttract.....	241
Oval Spoon Forceps.....	499
P	
Paddle Babcock Graspers.....	1139
Parallel Drill Guide and Drill Sleeve.....	862
Parallel Pliers.....	841
Parallel Pliers with Cutter.....	842
Parham-Martin Bone Clamp.....	918
Parker-Mott Retractors.....	207
Parker Retractors.....	207
Par Needle Holders.....	157
Par Scissors.....	140
Parsonnet Epicardial Retractor.....	722
Pass Thru Brackets.....	338
Patella Bone Holding Forceps.....	919
Pate Tray Posts.....	329
Patient Size Listing.....	390
Patterson Elongated Cup Biting Forceps.....	420, 779
Patterson Trocar and Cannula.....	310
Pean Clamps.....	69
Peanut Sponges.....	364
Peapod IVD Rongeur.....	1056
Peck-Joseph Skin Hook.....	190
Peck Mallet.....	1010
Peck-Vienna Nasal Speculum.....	521
Pederson Vaginal Specula.....	286
Pediatric Bronchoscopic Instruments.....	462
Pediatric Cast Breaker.....	1074
Pediatric Mixer Dissecting Forceps.....	85
Pediatric Poole Suction Tube.....	246
Pediatric Titanium Sternal Spreader.....	715
Pediatric Universal Clamps.....	753
Peers Towel Forceps.....	33
Pelvic Ball Spike.....	1092
Pelvic Reduction Forceps.....	933
Pelvic Retractor.....	886
Penfield Elevators.....	952
Pennington Forceps.....	101
Pennington Grasping Forceps.....	783
Percy Amputation Shield.....	1073
Perforated Container Lid.....	370
Perforated Mayo Trays.....	329
Perforated Silicone Mat.....	371
Perforated Tray with Feet.....	371

Periosteal Elevator.....	960
Perpendicular Nerve Retractor.....	881
Perthes Bone Awl	940
Phaneuf Uterine Artery Forceps.....	266
Phenolic Handle Mallets.....	1014
Piffard Curettes	315
Pilling® Blue Fiber Optic Cables	467
Pilling® Bougies/Dilators.....	469
Pilling® Bronchoscope System.....	442
Pilling® Coronary Potts Scissors.....	663
Pilling® Dedo Double-Action Anterior Commissure Laryngoscopes	406
Pilling® Delicate Center-Action Bronchoscopic Forceps	461
Pilling® Extra-Light Technique® Needle Holders.....	174, 678
Pilling® Feder-Ossoff Phonosurgery Set	423
Pilling® Flexible Endoscopic Forceps	462
Pilling® Gut and Colon Clamps.....	101
Pilling® IMA Retractor.....	725
Pilling® Improved Holinger Ventilating Fiberoptic Bronchoscopes	441
Pilling® Intracardiac Technique® Needle Holders.....	175, 679
Pilling® Laryngeal Instrumentation for Laryngoscopes and Micro-Laryngoscopes	418
Pilling® Laser Specula	292
Pilling® Long 1 mm Pediatric Clamps.....	577
Pilling® Micro Vascular Set	800
Pilling® Miniature Pediatric Clamps.....	596
Pilling® Multipurpose Retractors.....	231, 750
Pilling® Ossoff Double-Action Posterior Commissure Laryngoscope	407
Pilling® Ratchet Lock.....	657
Pilling® Rotating Endfitting Replacement Tip	468
Pilling® Ruskin Rongeur	716, 1032
Pilling® Short 1 mm Pediatric Clamps	578
Pilling® Stainless Steel Wire Cutting Forceps	823
Pilling® Sternal Retractor and Rib Spreader Dimensions	744
Pilling® Stille-Luer Duckbill Rongeur	717
Pilling® Surgical Lighting Systems	466
Pilling® Table Clamp.....	415
Pilling® Telescopes with Fiberoptic Illumination	445
Pilling® Thin Vascular and Coronary Technique® Needle Holders.....	175, 679
Pilling® Thoracic Artery Forceps	58
Pilling® Vascular Access Set	802
Pilling® Vascular Clamps	575
Pilling® Wire Cutters	823
Pilling®-Wolvek Sternal Approximation and Fixation System	745
Pillsbury-Jesberg Esophagoscopes	449
Pin Mats.....	339
Pin Pulling Pliers	838
P.I. Plug Cutter.....	865
Plain Splinter Forceps	34
Plaster Cast Instruments.....	1074
Plastic Scissors.....	141
Plasti Stats® Adson Forceps.....	76
Plasti Stats® Collier Forceps	76
Plasti Stats® Crile Hemostats.....	77
Plasti Stats® Kocher Forceps	77
Plasti Stats® Mosquito Forceps.....	77
Plate and Bone Holding Forceps.....	918
Plate Bending Iron.....	877
Plate Bending Pliers	845
Plate Bending Press	846
Plate Cutting Forceps.....	831
Plate Holding Clips	877
Platform Tying Forceps.....	1101
Platypus Nail Removing Forceps.....	1069
Pliers	835
Locking Pliers.....	843
Plate Bending Pliers	845
Socket Wrenches	847
Plug Cutter.....	865
Pointed Drill Guide	864
Polk Finger Goniometer	312, 1079
Polk Placenta Forceps	265
Polokoff Bone Rasps.....	973
Polysulfone Trays.....	326
Poole Abdominal Suction Tubes	246
Poole Suction Tubes	251
Port Site Closure.....	1162
Potts Micro Titanium Scissors.....	708
Potts Scissors	665
Potts-Smith Dissecting Scissors	672
Potts-Smith Dressing Forceps	42
Potts Smith Forceps	251
Potts Smith Scissors.....	666
Potts-Smith Technique® Dressing Forceps	42
Potts-Smith Tissue Forceps	56
Potts-Smith Vascular Scissors	667
Potts Tenotomy Scissors	132, 260, 672
Pratt Crypt Hook.....	308
Pratt Rectal Specula	306
Pratt "T" Forceps	301
Pratt Uterine Dilators	277
Preemie Retractor	729
Premium Diamond-Edge Aortic Punch, Full Length.....	764
Premium Diamond-Edge Aortic Punch, Mid-Length.....	764
Presbyterian Hospital Tubing Clamp	29
Preston Ligamentum Flavum Forceps (Meniscus).....	944
Probe and Packer.....	1088
Probe/Elevators.....	425
Probes, Cannulae and Dilators	309
OB/GYN Probes, Sounds and Dilators.....	274
Probes, Knot Pushers.....	1145
Probes with Proximal Eye	310
Providence Hospital Forceps	72
Providence Hospital Hemostats.....	73
Pryor-Pean Retractor.....	289
Punches	268
Aortic Punches	764
Biopsy Punch.....	268
Reusable Punches	765
Spinal Rongeur and Punch.....	1041
Putti Bone Rasp.....	969
Q	
Quick Coupling Handle.....	854
Quick Coupling T-Handle	854

R

Ragnell-Linde Retractor	881
Ragnell Retractor.....	207
Ragnell Scissors	142
Ragnell Scissors, Delicate	142
Rail Clamps	341, 727
Ralks Drill.....	851
Randall Kidney Stone Grasping Forceps	294
Randall Suction Biopsy Curette	279
Raney Clip Applying Forceps	369
Raney Gigli Saw Guide	1072
Raney Nylon Clips.....	369
Rankin Forceps	73
Rankin-Kelly Hemostat Forceps	73
Rasps	966
Bone Rasp	969
Bone Rasp #64.....	968
Ratchet Lock	657
Ratchet, Non-Tilting, for Circuitract	241
Ratcheted Graspers.....	1136
Ratcheted Non-Rotating Handle.....	1128
Ratcheted Rotating Handle	1128
Ray Pituitary Curettes	984
Rectal	300
Forceps and Clamps	300
Miscellaneous.....	307
Retractors and Specula	303
Rectal Biopsy Forceps.....	301
Rectal Blades, for Circuitract	239
Refurbishing/Repair Service.....	11, 13
Reill Bone Reduction Forceps.....	928
Reiner Plaster Knife.....	1075
Renal Artery Titanium Vascular Clamp	704
Renal Perfusion Clamps	572
Replacement Clips	417
Replacement Guide Silicone Caps	445
Replacement Luer-Lok® Hub Adapter.....	417
Replacement Stylet for Rumel Tourniquet.....	797
Replacement Telescope Guide Silicone Caps.....	444
Replacement Tray Handle	327
Replogle Pediatric Aorta Cross Clamp	591
Replogle Infant Sternal Retractor	732
Repercussion Free Mallet.....	1014
Repercussion Free Mallet Cap	1014
Retraction Graspers	1136
Retractor Fiber Optic “Light Beam”	244
Retractor Ring, Vaginal, for Circuitract.....	241
Retractors	
Bariatric	263
Epicardial	722
Extended Length/Open Bariatric.....	263
Hand-Held.....	746
Henly-Type Retractors.....	750
IMA	722
Laparoscopic	1146
Mouth and Throat Retractors	530
OB/GYN Retractors	288
Pilling® Sternal Retractor and Rib Spreader Dimensions	743
Rectal Retractors and Specula.....	303
Sternal Closure	745
Sternal Retractors/Rib Spreaders.....	729
Titanium Instruments.....	715
Urology Retractors	299
Valve Retractors	753
Retractors, Hand-Held	187
Abdominal-Type Retractors	209
Double-Ended Retractors.....	203
Hook and Rake Retractors.....	192
Ribbon-Type Malleable Retractors	216
Single-Ended Retractors	198
Skin Hooks.....	187
Specialty Retractors	217
Retractors, Orthopedic	878
Hand-Held Orthopedic Retractors.....	878
Hohmann Retractors	891
Self-Retaining Orthopedic Retractors	896
Shoulder and Knee Retractors.....	887
Vickers Finger.....	895
Retractors, Self-Retaining	218
Abdominal/Balfour-Type Retractors	232
Thyroid Retractors	239
Weitlaner, Gelpi and Henly-Type Retractors	220
Wire and Alm-Type Retractors.....	218
Retractors, Table-Mounted	240
Circuitract Retractor System	241
Miscellaneous Retractors.....	244
Wishbone Retractor System.....	242
Return Goods Policy	11
Revuelta-Garcia Allis Curved Clamps	559
Revuelta-Garcia Valve Leaflet Retractor.....	754
Revuelta-Garcia Valve Mirror.....	761
Revuelta-Garcia Valve Scissors.....	673
Rhinoplasty Flat Tip Scissors	515
Rhoton Ball-Tipped Dissectors	949
Rhoton Elevators	949
Rhoton Micro Curettes	950
Rhoton Micro Dissection Hooks	950
Rhoton Needle Sharp	950
Rhoton Round Dissectors.....	951
Rhoton Spatula Dissectors.....	951
Rib Instruments	716
Approximators.....	718
Raspatories and Periosteal Elevators	718
Rib Shears / Sternum Cutters	720
Rongeurs.....	716
Ribbon Retractors	216
Richardson Appendectomy Retractor	213
Richardson-Eastman Retractors.....	214
Richardson Retractors.....	214
Richter Heath Clip Forceps	322
Rienhoff Retractors	738
Rienhoff Swan-Neck Clamp	86
Right Angle Clamp.....	255
Right Angle X-Action Forceps.....	255
Rigid Rake Retractor Skin Hooks.....	190
Ring Curettes.....	984
Rizzuti Angled Micro Clip Applying Forceps	321, 571
Rochester-Ochsner Forceps.....	256
Rochester-Ochsner Forceps (Kocher).....	72

Rochester-Pean Forceps	70, 256
Rochester-Pean Forceps, 12"	71
Rochester-Pean Hemostatic Forceps.....	256
Rod Holder.....	875
Roeder Towel Forceps.....	33
Rogers Hysterectomy Forceps.....	257
Rogers Wire Cutting Scissors	113
Rollet Retractor.....	191
Rongeur #4.....	1019
Rongeur #4A.....	1019
Rongeur, Ergo Grip Handle.....	1128
Rongeurs	1019
Aortic Valve Rongeurs.....	759
Double Action Design.....	1028
Kerrison Rongeurs — Cleanpunch® 2.....	1045
Kerrison Rongeurs — Thin Footplate Design	1046
Kerrison Rongeurs — Standard Design.....	1047
IVD Rongeurs	1056
Rib Shears / Sternum Cutters	720
Single Action Design	1019
Spinal Rongeur and Punch.....	1041
Roos Brachial Plexus Root Retractor.....	749
Roos First Rib Shear.....	720
Roos Scaleneotomy Forceps	86
Rosebud/Cherry Sponges	365
Rosenbloom Sesamoid Clamp.....	936
Rosen Suction Tubes.....	247
Rotating Rectal Biopsy Forceps.....	302
Round Cup Forceps	499
Round Shaft Beaver Blade Handles	25
Roux Retractors.....	208
Rubin Septal Morselizer	508
Rubio Technique® Wire Twister	184, 687
Rulers	311
Rumel Thoracic Forceps	87
Rush Awl and Reamers.....	940
Ruskin-Liston Bone Cutting Forceps.....	1017
Ruskin Rongeurs.....	1031
Russian Tissue Forceps.....	57, 252
Ryder Bulldog® Needle Holders.....	162
Ryder Extra-Fine Technique® Needle Holders.....	162, 680
Ryder French Eye Needle Holders.....	161
Ryder Needle Holders	162
Ryder Titanium Ring Handle Needle Holders	714
S	
Saalfeld Comdone Extractor	315
Sachs Nerve Elevator	965
Safety Handle.....	326
Sage Tonsil Snare	534
Sam Roberts Cup Biopsy Forceps	455
Santulli Angular Model Bulldog® Clamp.....	566
Sarot Bronchus Clamps.....	560
Sarot Intra-Thoracic Artery Forceps.....	74
Sarot Needle Holders	170
Satinsky Clamps	647
Satinsky Scissors.....	673
Satinsky Titanium Vascular Clamps.....	704
Satterlee Bone Saw	1073
Satterlee Saw Blades Only	1073
Sauerbruch Retractors	203
Sauerbruch Rongeurs	717
Sawtell Hemostatic Forceps	87
Sawyer Rectal Retractors.....	303
Saxena Bone Grafting Retractor.....	906
Sayre Periosteal Elevator	959
Scalp Contour Retractors.....	222, 899
Schamberg Comdone Extractors.....	315
Schlesinger Cervical Laminectomy Rongeurs.....	1052
Schlesinger IVD Rongeurs	1059
Schnidt Forceps (Tonsil)	74
Schnitman Sharp Skin Hook with Eye	191
Schroeder Tenaculum.....	281, 292
Schroeder Vulsellum	284
Schubert Biopsy Punches	269
Schumaker Angular Aorta Clamps.....	648
Schwartz Clamp Holding Forceps	571
Schwartz Micro-Bulldog® Clamps	571
Scissors	
Bandage Scissors and Shears.....	103
Bariatric	258
Cartilage Scissors.....	947
CVT	669
Delicate and Iris-Type Scissors	134
Ear Scissors	500
Extended Length/Open Bariatric.....	258
Floor Grade Scissors	356
General.....	103
Laparoscopic	1142
Mayo-Type Scissors.....	116
Metzenbaum-Type Scissors	125, 260
Micro Scissors	1142
Mouth and Throat Scissors.....	532
Nail Scissors	1069
Nasal Scissors.....	514
OB/GYN Scissors.....	273
Operating Scissors	115
Ophthalmic	1106
Plastic.....	141
Potts-Style Scissors.....	658, 672
Ring Handle, Ophthalmic	1112
Spring Handle, Ophthalmic.....	1106
Stitch and Suture Removal Scissors	108
Super-Cut and Ultimate-Cut Scissors.....	146
Titanium Micro Scissors	706
Titanium Scissors	706
Vascular and Cardiac Scissors	669
Venous Valve	675
Wire Cutting Scissors.....	112
You-Potts Scissors.....	668
Scope and Light Carriers Identification Index	536
Scope Case.....	331
Scopes.....	536
Scoville Blades.....	910
Scoville Curettes.....	980
Scoville-Haverfield Retractor Blade	909
Scoville Hemilaminectomy Retractor Body.....	908
Scoville Nerve Root Retractors.....	881
Screw Depth Gauges.....	871

Screw Drivers	866	Sistrunk Fine Scissors.....	122
Cruciform Head.....	870	Sistrunk Heavy Scissors.....	122
Depth Gauge.....	871	Skillman Mosquito Forceps.....	66
Hex Head.....	866	Skin Self-Retaining Retractors.....	219
Screw Driver Sets.....	872	Slender Pederson Speculum.....	286
Screw Holding Forceps.....	873	Slide-Lock Handle.....	1128
Screwdriver Sleeves.....	867	Slip Joint Pliers.....	840
Screw Removal Forceps.....	838	Slotted "U" Brackets.....	337
T-Handle.....	871	Sluder-Jansen Mouth Gag.....	530
Scrub Files.....	346	Small Countersinks.....	858
Sedillot Periosteal Elevator.....	959	Small Pin Cutter.....	829
Self-Retaining Screw Holding Forceps.....	873	Small Plate Bending Irons.....	876
Self-Retaining Screw Holding Forceps.....	873	Small Plate Bending Pliers.....	846
Selman Tissue Forceps.....	57	Smartrack Lambotte for 9" Osteotomes.....	1083
Selverstone IVD Rongeur.....	1056	Smillie Knee Retractors.....	890
Semb Bone Holding Forceps.....	919	Smillie Knives.....	946
Semb Dissecting Forceps.....	556	Smith-Petersen Laminectomy Rongeur.....	1033
Semb Ligature Forceps.....	556	Smith-Peterson Gouges.....	1002
Semb Retractor.....	203	Smith-Peterson Laminectomy Rongeurs.....	1034
Semken Dressing Forceps.....	43	Smith-Peterson Osteotome.....	995
Semken Tissue Forceps.....	54	Smith-Peterson Smartrack.....	1084
Senning Featherweight Bulldog® Clamps.....	567	Smith Rectal Retractor.....	303
Senn-Kanavel Delicate Retractor.....	208	Smithwick Dissector and Hook.....	879
Senn Retractors.....	208	Smithwick Hook and Dissector.....	949
Serrefines Cross-Action Clamps.....	75	Snake Tooth Graspers.....	1138
Shambaugh Adenoid Curettes.....	524	Snares	
Shambaugh Reverse Curve Adenotomes.....	523	Mouth and Throat Snares.....	533
Sharp Hook.....	938	Nasal Snares.....	519
Shea Vein Graft Scissors.....	142	Snitman Endaural Retractor.....	898
Shears	720	Snook Hook.....	879
Rib Shears/Sternum Cutters.....	720	Socket Wrench.....	847
Sheehan Osteotomes.....	992	Solid Copper Head Mallet.....	1007
Sheppard Incision Irrigation Cannula.....	1122	Solvay Spay Hook.....	193
Shikani-French Speaking Valve and Inner Tube		Somer Uterine Elevating Forceps.....	265
Combination.....	480	Sonnenschein Child Nasal Speculum.....	520
Shikani-French Tracheostomy Speaking Valve.....	480	Spatula and Packer.....	1088
Shortbent Stitch Scissors.....	110	Specialty Open Surgical Ligating Appliers.....	383
Short Jaw Nail Splitters.....	1068	Special Orders.....	11
Shoulder Penetrating Awl.....	940	Specialty Sponges.....	359
Shoulder Penetrating Gouge.....	1002	Specula	
Shoulder Percussion Awls.....	941	Ear Specula.....	501
Side Biter Forceps.....	517	Esophagoscope Specula.....	452
Side Cutter.....	824	Nasal Specula.....	520
Side Pin Cutter.....	829	OB/GYN Specula.....	285
Silicone Mats.....	329	Ophthalmic.....	1119
Silver Osteotomes.....	992	Rectal.....	303
Simpson-Luikart Obstetrical Forceps.....	272	Spencer Coronary Technique® Needle Holder.....	181, 682
Simpson Obstetrical Forceps.....	272	Spencer Scissors.....	110
Simpson Uterine Sound.....	274	Spencer Stitch Scissors.....	111
Sims Rectal Speculum.....	306	Splinter Forceps.....	34
Sims Scissors.....	121	Sponge Bowls.....	340
Sims Uterine Curettes.....	279	Spoon Grasper.....	1133
Sims Uterine Sounds.....	274	Spring-Loaded Non-Rotating Handle.....	1128
Sims Vaginal Retractors.....	289	Spurling IVD Rongeurs.....	1058
Single One-Piece Fiber Optic Light Carriers/Cables.....	403	Spurling-Kerrison Punches.....	1050
Single Slot Screwdriver.....	869	Squeeze Handle.....	1128
Singley Dressing Forceps.....	252	"S" Retractor.....	203
Singley Tissue Forceps.....	55, 552	SS Riser Bracket.....	337
Sinus Seekers.....	518	Stagbeetle Bone Reduction Forceps.....	927
Sisson Nerve Hook.....	192, 761	Stamey Needles.....	298

Standard Plate Bending Iron.....	876
Standard Tip.....	1135
Staude-Moore Tenaculum.....	282
Staude Tenaculum.....	282
Steinman Pins	809
Calibrated.....	810
Chuck.....	814
Dispensers.....	811
Fully Threaded.....	809
Smooth.....	809
Stevens Tenotomy.....	143
Stevens Tenotomy, Delicate.....	143
Stewart Rectal Hook.....	308
Stille-Horsley Bone Cutting Forceps.....	1018
Stille-Leur Rongeurs.....	1039
Stille-Liston Bone Cutting Forceps.....	1017
Stille-Luer Echlin Duckbill Rongeurs.....	1038
Stille Osteotomes.....	993
Stille Pattern Rib Shears.....	721
Stille Plaster Shears.....	1074
Stille-Sherman Drill.....	851
Stille-Type Chisels.....	1000
Stille-Type Gouges.....	1002
Stitch Scissors.....	1114
Stone Intestinal Clamps.....	102
Stoney Deep Aorta Clamps.....	648
Stoney Spleno-Renal Shunt Clamp.....	613
Storage Trays.....	412
Storey Hemostatic Forceps.....	88
Strabismus Scissors.....	144
Straight DeBakey® Grasping Forceps.....	784
Straight Masher Grasping Forceps.....	783
Straight Single Action Needle Holder.....	785
Stratte Needle Holders.....	171
Strelinger Right Angle Clamp.....	102
Strong Aorta Clamps.....	644
Strong Graspers.....	1138
Strong Grasping Forceps.....	1131
Strong Suction Irrigator.....	421
Strong T-Bar Retractor System.....	728
Strong T-Bar Unilateral System Components.....	728
Strully Probed Tip Scissors.....	133, 673
Stylet for Rumel Tourniquet, Child Size.....	797
Stylet for Weck®-Style Rumel Tourniquet.....	797
Subglottoscopes	408
Laser Subglottoscopes.....	408
Suction Tubes	
Bronchoscopes and Esophagoscopes.....	463
General.....	245
Specialty.....	247
Suctions.....	426
Super-Cut (Baby) Metzenbaum Scissors.....	148
Super-Cut Hi-Level Bandage Scissors.....	146
Super-Cut Iris Scissors.....	149
Super-Cut Jamison Scissors.....	148
Super-Cut Lister Bandage Scissors.....	146
Super-Cut Lister Bandage Scissors with Large Finger Ring.....	146
Super-Cut Mayo Scissors.....	147
Super-Cut Metzenbaum Scissors.....	148
Super-Cut Operating Scissors.....	147
Super-Cut Scissors, Metzenbaum.....	1142
Super-Cut Scissors, Peritoneal.....	1142
Super-Cut Stevens Scissors.....	149
Surg-I-Band® Tape.....	350
Surgical Cases and Trays.....	335
Surgical Utility Cases.....	335
Suture Passers	849
Berci Suture Passer.....	316
Suture Removal Scissors.....	112
Swan Neck Gouge.....	1003
Sweet Modified Sternal Punch.....	746
Synovectomy Rongeurs.....	1019
Sypert Rongeurs.....	1040
T	
Takahashi Forceps.....	508
Tapered (Dolphin Nose) Dissection Forceps.....	1130
Tapered Maryland Dissectors.....	1129
Tap Sleeves.....	863
Taut® Cholangiogram Catheter.....	1159
Taut® Intraducer.....	1159
Taut® System One™ Common Bile Duct Exploration Kit.....	1160
Taylor Laminectomy Blade.....	910
Taylor Percussion Hammer.....	1087
Taylor Retractors.....	884
Taylor Spinal Blades.....	911
Taylor Spinal Retractors.....	884
Teale Uterine Vulsellum.....	284
Teeth Guards.....	391
Telescope Guides.....	444
Telescope Locking Device.....	445
Telescopes.....	1146
Temporary Occlusion Clips.....	317, 570
Tenaculum Graspers.....	1140
Tennant Tying Forceps.....	1101
Tevdek®/Polydek® Braided Polyester Suture.....	1158
Tew Tying Forceps.....	553, 1101
The Bush™ Retrograde Valvulotome.....	775
The Pilling® Vascular Access Set.....	802
Thomas-Gaylor Biopsy Punch.....	270
Thomas-Gaylor Cervical Biopsy Forceps.....	270
Thompson Carotid Closure Clamp.....	611
Thompson Clamp.....	610
Thompson Thoracic Instrument Holder.....	341
Thoms-Allis Tissue and Traction Forceps.....	91
Thoms-Allis Vulsellum Forceps.....	292
Thoracolumbar Spinal Implant Removal Set.....	1062
Thoracoscopy	782
Kaiser-Pilling™ Thoracoscopic Forceps.....	790
Landreneau Design.....	782
Video Assisted.....	782
Thorek Scissors.....	123
Three Finger Fan.....	1146
Three-Fluted Drill Bits.....	857
Throat Snare Wires.....	534
Thru-Cut Forceps.....	516
Thumb Bayonet Dressing Forceps.....	41
Thumb Dressing Forceps.....	36

Thumb Forceps.....	36	Tungsten Carbide, Ratcheted.....	1141
Thumb Tissue Forceps.....	43, 251	Turnbull Nail Nippers.....	1064
Tieck Infant Nasal Speculum.....	520	Tuttle Thoracic Tissue Forceps.....	55, 552
Tischler Biopsy Punches.....	270	Two-Level Lap Chole Cases.....	333
Tissue Forceps.....	44, 546, 1099	Tyding Tonsil Snare.....	534
Tissue Nippers.....	1066	Tygon Tubing with Luer-Lok® Connector.....	416
Tissue Retractor.....	898	Tyrell Hooks.....	191
Titanium Instruments: Forceps and Clamps.....	688		
Bulldog® Clamps.....	705		
Hemostatic Forceps.....	694		
Micro Forceps.....	692		
Pediatric Vascular Clamps.....	695		
Tissue and Dressing Forceps.....	688		
Vascular Clamps.....	698		
Titanium Instruments: Needle Holders.....	709		
Flat Handle Micro Needle Holders.....	710		
Ring Handle Needle Holders.....	711		
Round Handle Micro Needle Holders.....	709		
Titanium Instruments: Retractors.....	715		
Titanium Instruments: Scissors.....	706		
Micro Scissors.....	706		
Titanium Ligating Clips.....	382		
Titanium Retrieval Basket.....	1160		
TL Spinal Implant Removal System.....	1062		
Tobey Ear Forceps.....	498		
Tobey Laryngoscope Holder.....	415, 780		
Tonsil Clamp.....	255		
Tonsil Forceps.....	255		
Tonsil Sponges.....	367		
Townley Femur Caliper.....	313, 1078		
Trachea Hook.....	193		
Tracheostomy Tubes.....	473		
Air-Lon® Design.....	486		
Cleaning Brushes.....	494		
Decannulation Stoppers.....	490		
Holinger Design.....	484		
Jackson Improved Design.....	475		
Jackson Improved Design – Shikani Valve Compatible.....	479		
Jackson Original Design.....	481		
Laryngectomy Style Tubes.....	487		
Luer Design.....	485		
Mayo Design.....	484		
Miscellaneous.....	492		
Trach Buttons.....	489		
Tracheal Dilators.....	491		
Tracheostomy Tubes.....	473		
Tucker Design.....	483		
Trademarks.....	12		
Transplant Donor Sternal Retractors.....	742		
Transplant Recovery Balfour Retractors.....	234		
Trays.....	327		
Troutman Alpha-Chymotrypsin Cannula.....	1123		
Troutman-Barraquer Tissue Forceps.....	1099		
Tubbs Valve Dilator.....	762		
Tucker Bead Grasping Forceps.....	460		
Tucker Lumen Finders.....	471		
Tucker Mid-Lighted Side Slide Laryngoscopes.....	391		
Tucker Trachea Tubes and Valves.....	483		
Tuffier Retractor.....	738		
Tungsten Carbide.....	1141		
		U	
		U-Handle.....	1128
		Ulnar Radial Approximator.....	319
		Ulrich Self-Retaining Bone Holding Forceps.....	924
		Ultimate-Cut Cooley Scissors.....	147
		Ultimate-Cut Mayo Scissors.....	150
		Ultimate-Cut Metzenbaum Scissors.....	150
		Ultimate-Cut Potts Scissors.....	150
		Ultimate-Cut Stevens Tenotomy Scissors.....	151
		Umbilical Scissors.....	273
		Universal Brackets.....	337
		Universal Chuck with T-Handle.....	814
		Universal Drill.....	852
		Universal Drill Guide.....	861
		Universal Eye Shield.....	1125
		Universal Joint for Wexler Retractors.....	237
		Universal Rod Bender.....	874
		Universal Shears.....	107
		Unna Comdone Extractor.....	315
		Upright with Disc Clamp, for Wishbone.....	243
		Urology.....	294
		Catheter Guides.....	299
		Dilators, Sounds and Needles.....	297
		Forceps and Clamps.....	294
		Retractors.....	299
		Urschel First Rib Rongeur.....	717
		Urschel-Leksell Rongeur.....	716
		U.S. Army (Army-Navy) Retractors.....	209
		U.S. Army Pattern Gouges.....	1001
		U.S. Army Pattern Osteotomes.....	993
		V	
		Vaginal Blade, for Circuttract.....	241
		Vaginal Blade, Posterior, for Circuttract.....	241
		Vaginal Deaver Blade, for Circuttract.....	241
		Vaginal Retractor Ring, for Circuttract.....	241
		Valve Instruments.....	753
		Aortic Valve Rongeurs.....	759
		Coronary Perfusion Catheters.....	763
		Suture Rings.....	758
		Valve Dilators.....	762
		Valve Hooks.....	760
		Valve Retractors.....	753
		Valve Sternal Blade Assembly.....	724
		Valvulotomes.....	774
		Antegrade Cut.....	774
		Bush.....	775
		<i>In Situ</i>	774
		Mills-Type.....	774
		Valve Sternal Blade Assembly.....	724

Valvulotome Antegrade Cut	774	Volkman Bone Hooks	938
Van Beek Nerve Approximators.....	320	Volkman Curettes	982
Van Buren Catheter Guide	299	Volkman Pocket Retractors.....	195
Van Buren Sequestrum Forceps	920	Volkman Rake Retractors.....	196
Van Buren Urethral Dilators.....	298	Volkman Retractors.....	196
Vanderbilt Vessel Forceps.....	75	Von Graefe Strabismus Hooks	1117
Vanguard Splinter Liberator	35	Vorse Tubing Occluding Clamps	30
Vannas Capsulotomy Scissors	1108	Vorse Tubing Occluding Clamps with Safety Guard	30
Vannas Scissors.....	1108	V-Silicone Retainers	339
Vascular Access Set.....	802	Vulsellums and Tenaculums.....	280
Vascular Clamps	575		
Aortic Aneurysm Clamps	650		
Aortic Compressor	657		
Aortic Vascular Clamps	630		
Carotid Clamps	606		
Carotid Clamps, 1 mm Jaw.....	609		
Carotid Clamps, 1.5 mm Jaw.....	611		
Cooley Vascular Clamps	624		
Femoral-Popliteal Clamps.....	614		
Pediatric Clamps, 1 mm Jaw	577		
Pediatric Clamps, 1.5 mm Jaw	579		
Pediatric Clamps, 2 mm Jaw	591		
Pediatric Clamps, Cooley-Type Jaw	597		
Peripheral Vascular Clamps	615		
Renal Clamps	612		
Ring Handled Bulldog® Clamps	604		
Vascular DeBakey® Bayonet Tissue Forceps.....	51, 548		
Vascular Dilators	770		
Amato Design	770		
Cooley Design	770		
DeBakey® Design.....	771		
Garrett Design	772		
Hiebert Design.....	773		
Vasectomy Clamp	296		
Vasectomy Forceps	296		
Vasovasostomy Approximator	320		
Verbrugge Self-Centering Bone Holding Forceps.....	926		
Venous Valve Scissors.....	675		
Venturi Adapters for Bronchoscopes			
and Laryngoscopes	416		
Venturi Ventilating Needles	417		
Verbrugge Bone Holding Forceps	926		
Vernon Wire Scissors	114		
Verres Needles	1145		
Vertebral Body Distractors	905		
Vertebra Spreader (Cloward).....	905		
Verucca Curette Excavator	1088		
Vickers Easidriver.....	813		
Vickers Finger Retractor.....	895		
Vickers Low Profile Hand Retractor	896		
Vickers Low Profile Small Wound Retractor	896		
Vickers Universal Retractor	896		
Video Assisted Thoracoscopy	782		
Kaiser-Pilling™ Design	788		
Landreneau Design	783		
Retractors	782		
Video Laryngoscope Systems.....	411		
Vienna Nasal Speculums.....	521		
Virtus Splinter Forceps	35		
Vogen Sesamoid Clamp.....	937		
		W	
		Wachenfeldt Clip Applying and Removing Forceps.....	323
		Wallace Caesarean Forceps	265
		Walton Cartilage Clamp	942
		Walton Cast Spreader	1076
		Wangensteen Needle Holder	176
		Warranty/Guarantee, Instrument	9
		Wartenberg Neurological Pin Wheel.....	1087
		Webster Bulldog® Needle Holder	159
		Webster Needle Holders	158
		Webster Skin Graft Knife Handle.....	25
		Weck® Biceps Bayonet Forceps	1152
		Weck® Biceps Cerullo Bayonet Forceps	1152
		Weck® Biceps Forceps Cords.....	1152
		Weck® Biceps Jewelers Forceps	1152
		Weck® Bipolar Adson Forceps	1153
		Weck® Bipolar Cushing Bayonet Forceps.....	1153
		Weck® Bipolar Cushing Forceps	1153
		Weck® Bipolar Forceps Cords.....	1154
		Weck® Bipolar Iris Forceps	1154
		Weck® Bipolar Jeweler's Forceps	1154
		Weck® Bipolar Scoville-Greenwood Bayonet Forceps.....	1153
		Weck® Bipolar Semkin Forceps	1154
		Weck® Daniels Blades.....	523
		Weck® Daniels Tonsillectome.....	524
		Weck® Disposable Electrodes.....	1155
		Weck® Disposable IMA/ENT Electrodes.....	1155
		Weck® EFx® Endo Fascial Closure System	1162
		Weck® Hemoclip® Traditional and Plus Metal.....	384
		Weck® Hem-o-Lok® Polymer Locking Ligation System.....	379
		Weck® Horizon™ Metal Ligation System.....	380
		Weck® Instrument Cleaner.....	346
		Wec-Kleen™	349
		Weck® Ligation Solutions	375
		Weck® Hem-o-Lok® Polymer Locking Ligation System.....	376
		Weck® Hemoclip® Traditional and Plus Metal.....	384
		Weck® Horizon™ Metal Ligation System.....	380
		Weck® Ligation Solutions.....	379
		Weck® Liquid Detergent.....	347
		Weck-Lube™	347
		Weck® Micro Vessel Approximators.....	319
		Weck® Monopolar Handswitching Forceps.....	1156
		Weck®-Rack Retainer Clips	344
		Weck®-Racks.....	344
		Weck®-Rack Security Rods	345
		Weck®-Rack Separator Clips.....	345
		Wec-Kreem™	349
		Weck® Skin Staplers	1163

Weck® Specialty Products	
Accessories.....	369
Pin Cutters.....	827
Rod Cutters.....	837
Wire and Pin Drivers and Benders.....	814
Wire Guides and Traction Bows.....	848
Wire Twisters and Wire/Pin/Rod Cutters.....	823
Weck Vista® Bladeless Laparoscopic Access Ports.....	1161
Weck® Wipe.....	348
Wecprep Blades.....	26
Wec-Wash™.....	348
Weitlaner Retractors.....	220
Wertheim-Cullen Pedicle Clamp.....	268
Westcott Micro-Tenotomy Scissors.....	1109
Westcott Stitch Scissors.....	1109
Westcott Tenotomy Scissors.....	1109
Westphal Dissecting Forceps.....	88
Wexler Bantam Retractor.....	236
Wexler Deaver Blade.....	237
Wexler Deep Spreader.....	238
Wexler Expandable Blade.....	238
Wexler Standard Octagon Frame.....	237
Wheeler Technique® Plaque and Vessel Forceps.....	56, 551
White Tonsil Forceps.....	526
Wieder Tongue Depressors.....	531
Wiener Antrum Rasp.....	513
Wiener Skin Hooks.....	191
Wilcox Pediatric Cardiac Retractor.....	730
Wilde (Blakesley) Nasal Forceps.....	508
Wilde Ear Forceps.....	500
Wilde IVD Rongeurs.....	1057
Wilder Lacrimal Dilators.....	1121
Willauer-Allis Tissue Forceps.....	92, 560
Willauer-Deaver Retractors.....	211
Willauer Forceps.....	89
Williams Lacrimal Probes.....	309, 1120
Williams Splinter Forceps.....	35
Williger Bone Curette.....	982
Wiltse-Gelpi Retractor.....	228, 903
Window Plug.....	443
Wire and Pin Bender.....	816
Wire and Pin Tractor (Boehler).....	848
Wire Bending Pliers.....	839
Wire Cutting Scissors.....	114
Wire Forceps.....	185
Wire Passers (Cannulated).....	849
Wire Pulling Forceps.....	818
Wire Scissors.....	113
Wire Twisters	184
Needle Holder/Wire Twisters.....	184
Wire Twisting Forceps.....	687, 817
Wirthlin Spleno-Renal Shunt Clamp.....	613
Wishbone Lechner-Harrington Liver Blade.....	244
Wittner Biopsy Forceps.....	271
W.M. Lemmon Extra-Deep Deaver Retractors.....	211
W.M. Lemmon Technique® Needle Holders.....	176, 680
Wolff (Boehler) Cast Breakers.....	1075
Wood Bulldog® Clamps.....	568
Woodson Dural Separator and Packer.....	949
Woodson Elevator and Spatula.....	949
Wrench.....	847
Wrist Tendon Approximator.....	1091
Wullstein-Weitlaner Retractors.....	221
Wutzler Scissors.....	145
Wylie Abdominal Aorta Clamp.....	656
Wylie Calcified Arterial Punch.....	765
Wylie Carotid Closure Clamp.....	607
Wylie Carotid Dissecting Clamp.....	607
Wylie External Carotid Clamp.....	608
Wylie Hypogastric Clamp.....	608
Wylie Internal Carotid Clamp.....	608
Wylie "J" Aortic Clamps.....	649
Wylie Lumbar Bulldog® Clamp.....	568
Wylie Renal Vein Retractors.....	215, 749
Wylie Splanchnic Retractor.....	215
Wylie Uterine Tenaculum.....	282
X	
XenaLight XLT Lightsource.....	466
Xenon 300W Lightsource.....	466
Y	
Yankauer Suction Tubes.....	246, 251
Yankauer Suction Tube with Switch Valve.....	247
Yankauer Tonsil Scissors.....	532
Yasargil Vascular Scissors.....	668
You-Potts Vascular Scissors.....	668
Yu Holtgreve Malleable Blade.....	235
Z	
Zanger Abdominal Aorta Clamps.....	656
Zaufal-Jansen Rongeur.....	1033
Zenker Forceps.....	256
Z-Hysterectomy Forceps.....	258
Ziegler Cilia Forceps.....	1104
Zipser Penis Clamp.....	297

INDEX

Item Number

0

005200.....	382	35150.....	1145	053135.....	505, 955	065151.....	320
001200.....	382	036100.....	510	054015.....	191	065152.....	320
001204.....	382	036110.....	510	054016.....	191	065155.....	321, 570
001201.....	382	036111.....	510	054100.....	189	065165.....	319
001205.....	382	036500.....	505	054102.....	189	065166.....	318
002200.....	382	036501.....	505	054105.....	189	065170.....	319
002204.....	382	037101.....	513	054107.....	189	065172.....	318, 570
003200.....	382	037500.....	519	054110.....	189	065173.....	318, 570
003204.....	382	037510.....	519	054120.....	187	065175.....	321, 571
004200.....	382	037512.....	519	054125.....	189	065181.....	320
004204.....	382	050120.....	510	054126.....	188	065190.....	319
020100.....	497	050190.....	510	054128.....	188	065195.....	320
020120.....	496	050200.....	25	054130.....	188	065196.....	320
020121.....	496	050201.....	26	054135.....	187	065199.....	323, 574
020130.....	498	050202.....	26	054140.....	189	065202.....	1022
020155.....	499	050203.....	26	054142.....	189	065212.....	1030
020165.....	499	050204.....	26	054144.....	189	065300.....	953
020204.....	501	050205.....	26	054165.....	193	065325.....	945
020210.....	500	050206.....	26	054500.....	187	066100.....	134, 1110
020211.....	500	050207.....	26	054590.....	208	066102.....	134, 1110
020300.....	496	050208.....	26	054600.....	207	066104.....	134, 1110
020302.....	496	050209.....	26	054620.....	203, 522	066200.....	686, 1115
020571.....	497	050211.....	26	055100.....	136, 1113	066204.....	686, 1115
025100.....	501	050212.....	26	055102.....	1113	070100.....	531
025101.....	501	050213.....	26	055135.....	153	070101.....	531
025102.....	501	050230.....	25	055200.....	153	070107.....	530
025103.....	501	051082.....	511, 988	055502.....	135, 1110	070114.....	192, 492
025104.....	501	051084.....	511, 988	056110.....	144	070116.....	194, 493
025160.....	502	051086.....	511, 988	056120.....	112	070140.....	531
025162.....	502	051088.....	511, 988	056200.....	141	070202.....	529
025163.....	502	051090.....	511, 988	056201.....	141	070222.....	530
025164.....	502	051092.....	511, 988	056302.....	515	070232.....	530
025165.....	502	051095.....	511, 988	056310.....	124	070300.....	528
025166.....	502	051102.....	511, 991	056360.....	515	070301.....	528
025167.....	502	051103.....	511, 991	056400.....	514	070302.....	528
025168.....	502	051104.....	511, 991	056650.....	508	070303.....	528
025169.....	502	051105.....	511, 991	057150.....	507	070305.....	528
026275.....	194	051106.....	511, 991	057200.....	37	070312.....	527
026510.....	504	051107.....	511, 991	057202.....	37	070330.....	527
027100.....	41	051109.....	511	057205.....	37	070332.....	527
028120.....	1025	051110.....	511, 991	057207.....	45	070334.....	527
029350.....	496	051150.....	510	057210.....	45	070340.....	526
029480.....	503	051152.....	510	057212.....	45	070342.....	526
029550.....	221	051155.....	510	057214.....	45	070344.....	526
029555.....	221	051158.....	510	057215.....	47	070450.....	528
030100.....	520	051190.....	510	057220.....	46	070501.....	523
030180.....	520	051191.....	510	057230.....	45	070502.....	523
030301.....	520	051195.....	510	057250.....	46	070503.....	523
030302.....	520	051510.....	1007	057302.....	48	070511.....	523
030303.....	520	051520.....	1009	060100.....	219	070512.....	523
030304.....	520	051521.....	1009	060101.....	219	070521.....	523
031100.....	41	051525.....	1009	060105.....	219	070522.....	523
031430.....	507	051526.....	1009	060120.....	192, 761	070523.....	523
031500.....	509	052100.....	513, 973	065100.....	317, 569	070600.....	524
031502.....	509	052130.....	512, 971	065105.....	317, 569	070604.....	523
031505.....	509	052162.....	511, 970	065108.....	317, 570	070605.....	523
031750.....	514	052165.....	512, 970	065109.....	317, 570	070635.....	534
031800.....	515	052180.....	512, 971	065110.....	320, 569	070640.....	534
35120.....	1145	053102.....	506	065111.....	320, 569	070651.....	533
		053115.....	505	065125.....	317, 569	070652.....	533
		053120.....	506	065145.....	317, 569	070660.....	533

070665.....	533	101130.....	356	141332.....	117	152796.....	170
070701.....	519, 534	101131.....	356	141395.....	121	152798.....	154
070702.....	519, 534	101140.....	357	141448.....	124	152800.....	156
070704.....	519, 534	101141.....	357	141450.....	124	152802.....	156
070705.....	519, 534	101142.....	356	141452.....	124	152805.....	157
070706.....	519, 534	101143.....	356	141460.....	125	152808.....	158
072120.....	524	101144.....	357	141462.....	125	152818.....	178, 683, 804
072122.....	524	101145.....	357	141467.....	125	152819.....	178, 683
072124.....	524	101146.....	356	141469.....	125	152825.....	178, 685
073370.....	535	101147.....	351	142220.....	118	152827.....	178, 685
073500.....	531	101148.....	351	142235.....	118	152837.....	169
073502.....	531	101149.....	351	142237.....	118	152842.....	172
074115.....	532	101150.....	351	142312.....	110	152850.....	176
074120.....	532	101151.....	353	142325.....	108	152855.....	171
074140.....	532	101152.....	353	142415.....	105	162210.....	246
075116.....	74	114527.....	387	142420.....	105	162212.....	246
075118.....	65	121380.....	350	142422.....	105	162300.....	246
075120.....	74	121381.....	350	142425.....	103	162301.....	246
075122.....	74	121382.....	350	142452.....	107	162310.....	248, 767
087396.....	329	121383.....	350	142515.....	113	162345.....	247
087403.....	329	121384.....	350	142518.....	113	162410.....	245
087405.....	329	121385.....	350	142519.....	823	162411.....	245
087419.....	329	121386.....	350	142520.....	823	162412.....	245
087420.....	329	121387.....	350	142521.....	184, 686	162413.....	245
087531.....	342	121388.....	350	142550.....	745, 823	162414.....	245
087532.....	342	121389.....	350	144295.....	134, 1107	162415.....	245
087533.....	342	121390.....	350	144300.....	137	162416.....	245
087550.....	342	121391.....	350	144310.....	137	162421.....	245
087552.....	342	121410.....	27	144315.....	137	163000.....	243
087559.....	342	121412.....	27	144317.....	137	163100.....	243, 413
087561.....	342	121415.....	27	144319.....	144	163102.....	243
087702.....	324	121417.....	27	144321.....	144	163103.....	243
087747.....	324	121422.....	27	144330.....	144	163104.....	243
087748.....	324	121427.....	27	144332.....	144	163108.....	243
087749.....	324	121600.....	32	144338.....	139	163109.....	243
087750.....	324	121605.....	32	144340.....	139	163111.....	243
		121610.....	33	144350.....	143	163117.....	243
		121640.....	33	144352.....	143	163200.....	243
		121650.....	33	151210.....	322	163201.....	243
		121655.....	31	151228.....	322	163203.....	243
		121656.....	31	151240.....	322	163211.....	243
		131114A.....	783	151350.....	350	163212.....	243
		137061.....	383	151351.....	350	163213.....	243
		137062.....	383	152255.....	316	163400.....	243
		137081.....	383	152256.....	316	163401.....	243
		137082.....	383	152402.....	165	163406.....	243
		137085.....	383	152406.....	165	163420.....	243
		137086.....	383	152448.....	159	163422.....	243
		137111.....	383	152496.....	155	163424.....	243
		137112.....	383	152710.....	152	163436.....	244
		137117.....	381, 383	152720.....	165	163701.....	244
		137118.....	383	152722.....	165	164110.....	210
		140875.....	1145	152724.....	165	164112.....	210
		140877.....	1145	152760.....	161	164115.....	210
		140878.....	1145	152762.....	161	164118.....	210
		140879.....	1145	152764.....	161	164120.....	210
		140880.....	1145	152771.....	163	164122.....	210
		140881.....	1145	152772.....	165	164125.....	210
		140882.....	1145	152780.....	163	164130.....	210
		141106.....	116	152781.....	163	164132.....	210
		141146.....	116	152782.....	163	164134.....	210
		141310.....	116	152784.....	163	164164.....	216
		141312.....	116	152786.....	163	164166.....	216
		141315.....	116	152790.....	163	164168.....	216
		141317.....	116	152792.....	163	164170.....	216

1

101010.....	353						
101011.....	353						
101012.....	354						
101013.....	354						
101014.....	354						
101015.....	354						
101016.....	353						
101017.....	353						
101022.....	352						
101023.....	352						
101024.....	352						
101027.....	354						
101028.....	352						
101031.....	355						
101032.....	355						
101033.....	355						
101034.....	355						
101035.....	358						
101036.....	358						
101037.....	358						
101038.....	358						
101039.....	357						
101050.....	327						
101054.....	327						
101061.....	327						
101075.....	328						

164172.....	216	165143.....	235	166632.....	309	168247.....	241
164174.....	216	165145.....	235	166633.....	309	168248.....	241
164374.....	195	165146.....	235	166851.....	343	168249.....	241
164376.....	195	165147.....	235	166853.....	343	168250.....	241
164384.....	195	165149.....	235	166855.....	343	168251.....	241
164402.....	196	165150.....	235	166857.....	343	168252.....	241
164403.....	196	165160.....	235	166859.....	343	168253.....	241
164404.....	196	165170.....	236	166861.....	343	168254.....	241
164406.....	196	165171.....	236	166868.....	342, 787	168255.....	241
164412.....	196	165200.....	232	166870.....	342	168256.....	241
164413.....	196	165203.....	232	166872.....	342	168257.....	241
164414.....	196	165240.....	232	166874.....	342	168258.....	241
164416.....	196	165300.....	236	166876.....	342	168259.....	241
164443.....	195	165348.....	220	167050.....	241	168260.....	241
164444.....	195	165350.....	220	167051.....	241	168261.....	241
164446.....	195	165352.....	220	168000.....	241	168262.....	241
164453.....	195	165354.....	220	168101.....	241	168263.....	241
164454.....	195	165356.....	220	168102.....	241	171117.....	93
164456.....	195	165358.....	220	168103.....	241	171120.....	93
164520.....	212	165360.....	220	168104.....	241	171122.....	93
164521.....	212	165362.....	220	168105.....	241	171155.....	68
164522.....	212	165364.....	220	168110.....	241	172495.....	86
164525.....	213	165366.....	220	168111.....	241	172500.....	85
164526.....	213	165370.....	223	168156.....	241	172503.....	85
164527.....	213	165372.....	223	168196.....	241	172506.....	85
164528.....	213	165374.....	223	168197.....	241	172525.....	83
164540.....	213	165380.....	223	168198.....	241	172530.....	82
164542.....	214	165382.....	223	168199.....	241	172531.....	82
164543.....	214	165384.....	223	168200.....	241	172532.....	82
164544.....	214	165400.....	225	168201.....	241	172550.....	80
164550.....	214	165402.....	225	168202.....	241	172560.....	100
164630.....	200	165439.....	226, 804	168203.....	241	172570.....	95
164631.....	200	165440.....	226	168204.....	241	172571.....	95
164632.....	200	165510.....	219	168205.....	241	172616.....	95
164635.....	203	165550.....	220	168206.....	241	172625.....	97
164636.....	203	165552.....	220	168207.....	241	172650.....	294
164637.....	203	165590.....	218	168208.....	241	172655.....	294
164650.....	198	165591.....	218	168209.....	241	172660.....	294
164652.....	198	165592.....	218	168210.....	241	172665.....	294
164656.....	198	165595.....	218	168211.....	241	172700.....	311
164658.....	198	165596.....	218	168212.....	241	175000.....	253
164698.....	207	165597.....	218	168213.....	241	175001.....	253
164700.....	205	166002.....	244, 728	168214.....	241	175002.....	253
164702.....	205	166480.....	309, 1120	168215.....	241	175003.....	253
164710.....	206	166485.....	309, 1120	168216.....	241	175004.....	253
164715.....	209	166490.....	309, 1120	168217.....	241	175005.....	253
164750.....	208	166495.....	309, 1120	168218.....	241	175006.....	253
164752.....	208	166500.....	310	168220.....	241	175007.....	253
164754.....	204	166501.....	310	168221.....	241	175008.....	253
164786.....	190	166502.....	310	168222.....	241	175009.....	253
164790.....	202	166503.....	310	168223.....	241	175010P.....	253
164865.....	199	166504.....	310	168225.....	241	175011.....	253
164865.....	747	166505.....	310	168226.....	241	175012.....	253
165085.....	219	166507.....	310	168227.....	241	175013.....	253
165086.....	219	166520.....	310	168228.....	241	175014.....	256
165100.....	233	166521.....	310	168229.....	241	175015P.....	256
165105.....	233	166522.....	310	168230.....	241	175016.....	254
165107.....	234	166523.....	310	168232.....	241	175017.....	254
165130.....	233	166527.....	310	168233.....	241	175018.....	254
165133.....	233	166571.....	309	168235.....	241	175019.....	254
165135.....	233	166573.....	309	168236.....	241	175020P.....	258
165137.....	233	166610.....	309	168243.....	241	175021.....	261
165138.....	233	166611.....	309	168244.....	241	175022.....	261
165141.....	235	166612.....	309	168245.....	241	175023.....	263
165142.....	235	166613.....	309	168246.....	241	175024.....	263

175025P.....	263	175095.....	255	181610.....	54	182910.....	91
175026.....	252	175096.....	256	181614.....	54	182915.....	89
175027.....	252	175097.....	256	181800.....	77	182920.....	91
175028.....	252	175098.....	256	181802.....	77	183010.....	92, 557
175029.....	252	175099.....	256	181804.....	76	183020.....	92, 557
175030P.....	252	175100.....	256	181806.....	77	18305.....	1159
175031.....	252	175101.....	256	181808.....	77	183400.....	101
175032.....	252	175102.....	257	181810.....	77	183410.....	101
175033.....	252	175103.....	257	181812.....	77	183975.....	98
175034.....	252	175104.....	252	181814.....	77	183977.....	98
175035.....	252	175105.....	252	181816.....	77	184001.....	98
175036.....	252	175106.....	252	181818.....	77	184002.....	98
175037.....	252	175107.....	252	181820.....	77	184003.....	98
175038.....	257	175108.....	252	181822.....	63	185005.....	89
175039.....	257	175109.....	251	181824.....	76	185006.....	89
175040P.....	261	175110.....	251	181830.....	70	185010.....	89
175041.....	261	175111.....	255	181832.....	77	185030.....	97
175042.....	259	175112.....	255	182050.....	62	185060.....	69
175043.....	259	175113.....	256	182060.....	62	185065.....	69
175045.....	259	175114.....	251	182070.....	62	185066.....	69
175046.....	259	175115.....	251	182080.....	62	185067.....	69
175048.....	259	175116.....	251	182085.....	62	185202.....	97
175049.....	259	175117.....	251	182086.....	62	185204.....	97
175052.....	259	175118.....	258	182090.....	62	185210.....	99
175053.....	254	175119.....	258	182095.....	62	185212.....	99
175054.....	254	175120.....	258	182097.....	62	185214.....	99
175055.....	251	175121.....	258	182098.....	62	185220.....	100
175056.....	251	175122.....	258	182100.....	67	185222.....	100
175057.....	255	175123.....	258	182110.....	67	185331.....	94
175058.....	261	175124.....	258	182120.....	73	185402.....	102
175059.....	257	175125.....	258	182130.....	73	185404.....	102
175060.....	257	181102.....	36	182140.....	73	185714.....	192
175061.....	259	181104.....	36	182150.....	73	188030.....	1064
175062.....	262	181106.....	36	182160.....	67	188032.....	1064
175063.....	262	181108.....	36	182200.....	75	191023.....	1151
175065.....	262	181127.....	43	182205.....	75	191025.....	1151
175066.....	262	181129.....	43	182210.....	75		
175067.....	259	181131.....	43	182300.....	64		
175068.....	259	181133.....	43	182310.....	64		
175069.....	260	181139.....	43	182350.....	64	200100.....	362
175070.....	260	181155.....	43	182355.....	64	200101.....	362
175071.....	260	181166.....	43	182390.....	74	200102.....	362
175072.....	260	181220.....	36	182400.....	70	200103.....	362
175073.....	254	181223.....	45	182405.....	70	200104.....	363
175074.....	254	181225.....	45	182415.....	70	200105.....	363
175075.....	260	181228.....	45	182420.....	70	200106.....	363
175076.....	260	181235.....	46	182440.....	70	200108.....	363
175077.....	260	181237.....	37	182445.....	70	200110.....	363
175078.....	263	181240.....	47	182455.....	70	200112.....	363
175079.....	263	181250.....	53	182460.....	70	200120.....	363
175080.....	263	181255.....	48	182600.....	72	200121.....	363
175081.....	263	181270.....	43	182605.....	72	200123.....	363
175082.....	263	181272.....	54	182615.....	72	200131.....	363
175083.....	251	181310.....	44	182620.....	72	200161.....	362
175084.....	251	181327.....	48	182655.....	72	200200.....	361
175085.....	251	181360.....	57	182665.....	72	200201.....	361
175086.....	251	181365.....	57	182670.....	72	200202.....	361
175087.....	251	181370.....	57	182795.....	90	200203.....	361
175088.....	251	181410.....	38	182850.....	90	200211.....	361
175089.....	260	181556.....	34	182860.....	90	200212.....	361
175090.....	260	181557.....	34	182870.....	90	200214.....	364
175091.....	260	181559.....	34	182875.....	90	200215.....	364
175092.....	255	181600.....	40	182880.....	90	200217.....	364
175093.....	254	181602.....	40	182900.....	91	200218.....	365
175094.....	254	181604.....	54	182905.....	91	200220.....	360

2

200230.....	365	212226.....	289	213155.....	283	337111.....	383
200231.....	365	212227.....	289	213157.....	283	337115.....	383
200232.....	365	212228.....	289	213160.....	283	337117.....	383
200233.....	366	212229.....	289	213175.....	284	337141.....	383
200234.....	366	212241.....	290	213180.....	284	337145.....	383
200235.....	366	212242.....	290	213230.....	265	338110.....	381, 383
200236.....	366	212263.....	289	214081.....	273	338110T.....	383
200240.....	360	212264.....	289	214090.....	273	338170.....	383
200250.....	360	212265.....	289	214161.....	266	341100.....	728
200322.....	367	212271.....	288	214170.....	267	341112.....	728
200326.....	367	212275.....	288	214172.....	267	341113.....	728
200327.....	367	212295.....	289	214175.....	267	341114.....	244
200328.....	367	212305.....	288	214180.....	268	341114.....	728
200333.....	368	212350.....	288	214182.....	268	341120.....	725
200334.....	368	212500.....	264	214215.....	267	341123.....	726
200335.....	368	212505.....	264	214230.....	268	341124.....	726
200340.....	368	212600.....	274	214550.....	272	341126.....	726
200400.....	359	212605.....	274	214555.....	272	341127.....	726
200401.....	359	212610.....	274	214570.....	272	341128.....	726
200402.....	359	212612.....	274	214595.....	272	341129.....	726
200403.....	359	212647.....	277	214605.....	272	341131.....	727
200550.....	348	212659.....	275	214687.....	298	341133.....	727
202030.....	300	212661.....	275	214688.....	298	341136.....	725
202060.....	306	212662.....	275	214689.....	298	341139.....	725
202062.....	306	212663.....	275	214691.....	298	341147.....	723
202067.....	306	212664.....	275	214770.....	293	341148.....	724
202095.....	307	212665.....	275	215558A.....	785	341149.....	724
202096.....	307	212666.....	275	237061.....	383	341150.....	722, 744
202097.....	307	212667.....	275	237081.....	383	341154.....	724
202105.....	305	212668.....	275	237085.....	383	341155.....	723, 744
202140.....	303	212669.....	275	237111.....	383	341156.....	724
202150.....	303	212670.....	275	237115.....	383	341158.....	734, 743
202151.....	303	212671.....	275	237117.....	383	341160.....	734, 743
202600.....	308	212673.....	276	237141.....	383	341162.....	734, 744
202623.....	307	212675.....	276	237145.....	383	341163.....	735, 744
202630.....	308	212676.....	276	238110.....	383	341164.....	735, 744
202635.....	308	212677.....	276	238110T.....	383	341170.....	740, 744
202792.....	308	212678.....	276	238170.....	383	341175.....	736, 744
202970.....	300	212679.....	276	238200.....	381, 383	341177.....	736, 743
203142.....	301	212680.....	276	241108.....	298	341178.....	736, 743
204004.....	302	212681.....	276	241110.....	298	341180.....	741, 744
204016.....	302	212682.....	276	241112.....	298	341181.....	741, 744
204018.....	302	212749.....	279	241114.....	298	341194.....	735, 744
211116A.....	783	212750.....	279	241116.....	298	341195.....	735, 744
211117A.....	783	212751.....	279	241118.....	298	341198.....	739, 744
211118A.....	784	212752.....	279	241120.....	298	341200.....	731, 743
211245A.....	784	212753.....	279	241122.....	298	341205.....	732, 743
211290A.....	785	212754.....	279	241124.....	298	341224.....	740, 744
211325A.....	785	212755.....	279	241126.....	298	341225.....	739, 744
211500.....	786	212905.....	277	241128.....	298	341227.....	739, 744
211600.....	786	212910.....	278	241130.....	298	341250.....	731, 743
211603A.....	784	213011.....	270	241132.....	298	341290.....	729, 743
212000.....	285	213036.....	269	242005.....	295	341296.....	732, 743
212001.....	285	213050.....	264	242006.....	295	341302.....	729, 743
212002.....	285	213055.....	264	243110.....	295	341303.....	730, 743
212005.....	285	213065.....	281	243200.....	299	341304.....	730, 743
212010.....	286	213080.....	281	243201.....	299	341305.....	730, 743
212011.....	286	213085.....	281	244000.....	296	341310.....	742, 782
212012.....	286	213090.....	282	244001.....	296	341312.....	729, 743
212185.....	287	213095.....	282			341315.....	730, 743
212187.....	287	213100.....	280			341317.....	731, 743
212195.....	287	213110.....	280			341326.....	733, 743
212196.....	287	213120.....	280			341328.....	733, 743
212197.....	287	213140.....	266			341330.....	733, 744
212225.....	289	213150.....	283			341332.....	733, 744
				3			
				306010A.....	1147		
				337081.....	383		
				337085.....	383		

341362	738, 743	342025	722	342603	84	351355	28
341366	738, 743	342040	746	342605	99	351358	29
341387	742	342043	746	342606	99	351370	29
341389	742, 744	342044	746	342611	83	351373	30
341390	738, 743	342102	717	342615	79	351374	30
341397	737, 743	342105P	717	342625	86	351375	30
341398	737, 743	342107	717	342632	80	351376	30
341448	718	342141	717	342633	80	351377	30
341450	718	342142	716	342655	558	351378	30
341460	718	342143	716	342660	557	351390	28
341501	723, 755	342160	129, 669	342662	557	351470	763
341502	755	342162	129, 699	342664	557	351472	763
341503	755	342166	129, 669	342670	558	351474	763
341506	755	342167	129, 669	342672	558	351476	763
341511	755	342168	129, 669	342675	559	351490	763
341512	755	342169	129, 669	342710	556	351500	249, 768
341513	755	342200	129, 670	342711	556	351501	249, 768
341514	756	342201	129, 670	342720	92, 560	351502	250, 768
341515	757	342202	129, 670	342721	92, 560	351504	250, 768
341520	723, 755	342203	129, 670	342725	92, 557	351505	250, 767
341522	723, 755	342204	129, 670	342726	92, 557	351506	250, 768
341523	723, 755	342206	129, 670	342800	559	351508	249
341524	723, 755	342220	132, 671	342802	559	351547	249
341525	723, 755	342221	132, 671	342804	557	351547	767
341531	753	342222	132, 671	342822	560	351560	766
341635	204	342223	132, 671	342823	560	351573	766
341640	203	342242	131	342910	57	351574	766
341650	217, 748	342243	131	342915	57	351575	766, 805
341651	217, 748	342245	131	342933	55, 552	351576	766
341678	217, 746	342270	123	342935	55, 552	351577	766
341679	217, 746	342272	123	342950	55, 551	351578	766
341690	216, 748	342273	122	342965	48	351586	766
341692	216, 748	342275	130, 670	342967	48	351587	766
341694	216, 748	342501	87	342980	49, 546	351593	766
341696	216, 748	342504	87	342981	49, 546	351594	766
341698	216, 748	342511	87	342982	49, 546	351645	629
341720	211	342513	87	342984	49, 546	351646	629
341722	211	342514	87	342986	49, 546	351650	629
341730	211	342533	87	343000	173, 677	351651	629
341732	211	342557	81	343027	171	351652	629
341740	212	342558	81	343030	185, 686, 745	351653	629
341770	213	342559	81	343145	718	351654	629
341773	213	342560	96	343148	719	351661	230, 752
341780	215	342561	96	343149	719	351664	230, 752
341790	212	342562	96	343152	719	351666	231, 750
341791	212	342563	96	343153	719	351667	231, 750
341795	215	342565	96	343295	769	351668	231, 750
341795	749	342566	78	343393	341, 727	351669	231, 750
341797	215	342567	78	343395	341	351670	231, 750
341797	749	342568	78	343500	977	351671	231, 750
341803	717	342569	78	343501	977	351672	231, 750
341836	716, 1032	342571	74	343502	977	351673	231, 750
341950	720	342572	74	343503	977	351675	231, 750
341960	720	342575	86	343504	977	351676	230, 751
341961	720	342580	89	343505	977	351677	230, 751
341980	721	342583	87	343506	977	351678	230, 751
341985	720	342585	58	343590	561	351679	229, 751
341992	749	342587	59	351316	796	351680	229, 751
342000	745	342590	75	351318	796	351685	218
342002	745	342594	59	351348	185, 687	351715	657
342004	745	342596	80	351349	184, 687	351737	761
342006	745	342597	80	351351	28	351743	559
342008	745	342598	80	351352	28	351744	559
342015	758	342600	84	351353	28	351745	673
342020	721	342601	84	351354	28	351747	754

351748.....	551	351864.....	42	352197.....	661	353066.....	562
351749.....	760	351865.....	42	352199.....	670	353070.....	566
351750.....	757	351870.....	56	352210.....	129	353075.....	568
351752.....	757	351872.....	56	352232.....	669	353077.....	606
351754.....	757	351874.....	56	352235.....	124	353078.....	606
351755.....	757	351876.....	56	352237.....	124	353080.....	606
351763.....	757	351898.....	56	352240.....	120	353085.....	606
351767.....	754	351900.....	39, 549	352250.....	120	353086.....	607
351768.....	754	351901.....	53, 550	352295.....	673	353087.....	607
351769.....	754	351901DG.....	551	352297.....	671	353100.....	564
351770.....	754	351902.....	39, 549	352298.....	671, 758	353102.....	564
351771.....	754	351905.....	52, 550	352598.....	758	353105.....	564
351772.....	754	351907.....	52, 550	352605.....	774	353110.....	564
351773.....	753	351908.....	53, 550	352606.....	675	353112.....	564
351774.....	753	351909.....	53, 550	352607.....	675	353115.....	564
351779.....	228, 752	351910.....	53, 550	352610.....	774	353120.....	564
351780.....	754	351970.....	778	352611.....	774	353123.....	568
351783.....	756	352090.....	120	352612.....	775	353124.....	568
351784.....	231, 750	352100.....	130	352613.....	775	353125.....	568
351785.....	760	352103P.....	130	352614.....	775	353126.....	568
351788.....	753	352106.....	130	352615.....	762	353127.....	568
351789.....	753	352109.....	130	352630.....	762	353128.....	568
351790.....	753	352120.....	130	352680.....	775	353131.....	565
351791.....	753	352123.....	130	352681.....	775	353132.....	565
351800.....	50, 546	352126.....	130	352682.....	775	353135.....	567
351801.....	50, 548	352129.....	130	352683.....	775	353136.....	567
351802.....	50, 546	352132P.....	659	352690.....	775	353137.....	567
351803.....	50, 548	352133.....	659	352691.....	775	353138.....	567
351803DG.....	548	352134.....	659	352692.....	775	353140.....	572
351804.....	50, 546	352135.....	659	352693.....	775	353142.....	572
351806.....	50, 548	352136.....	659	352705.....	770	353150.....	563
351808.....	50, 546	352140.....	665	352800.....	759	353151.....	563
351810.....	50, 546	352144.....	675, 1107	352802.....	759	353152.....	563
351812.....	50, 546	352145.....	675, 805, 1106	352804.....	759	353153.....	563
351814.....	50, 546	352146.....	664	352806.....	759	353154.....	563
351815.....	51, 547	352147.....	664	352808.....	759	353155.....	563
351817.....	51, 547	352148.....	664	352810.....	759	353182.....	604
351818.....	51, 547	352149.....	664	352825.....	765	353183.....	605
351819.....	51, 547	352150.....	666	352950.....	24	353186.....	604
351820.....	50, 547	352151.....	662	352951.....	24	353187.....	605
351821.....	50, 547	352152.....	666	352952.....	24	353187.....	804
351824.....	51, 547	352153.....	662	352953.....	24	353189.....	604
351825.....	56, 551, 805	352154.....	666	352954.....	24	353190.....	605, 804
351827.....	56, 551, 805	352155.....	662	352957.....	24	353192.....	604
351829.....	56, 551	352162.....	664	352959.....	24	353195.....	604
351830.....	186, 681, 805	352164.....	663	353001.....	566	353203.....	797
351831.....	186, 681	352165.....	663	353002.....	566	353206.....	797
351835.....	55	352166.....	663	353003.....	566	353207.....	797
351837.....	56, 549	352167.....	663	353011.....	566, 805	353490.....	99, 623
351838.....	56, 549	352168.....	663	353012.....	566	353491.....	99, 623
351839.....	56, 549	352169.....	658	353014.....	566	353492.....	99, 623
351840.....	57	352170.....	666	353016.....	566	353494.....	622
351841.....	57	352171.....	666	353025.....	565	353495.....	622
351842.....	57	352173.....	661	353035.....	569	353496.....	622
351843.....	51, 548	352174.....	661	353040.....	571	353500.....	618
351845.....	51, 548	352177.....	661	353041.....	571	353503.....	618
351850.....	42	352178.....	663	353042.....	571	353510.....	619
351852.....	42	352180.....	669	353043.....	571	353513.....	619
351854.....	42	352181.....	669	353050.....	562	353515.....	613
351856.....	42	352183.....	669	353052.....	562	353522.....	613
351858.....	42	352184.....	669	353054.....	562	353524.....	613
351860.....	38	352185.....	661	353056.....	562	353528.....	614
351861.....	39	352187.....	660	353060.....	562	353531.....	612
351862.....	42	352191.....	661	353062.....	562	353532.....	612
351863.....	42	352196.....	661	353064.....	562	353533.....	612

353534.....	612	353660.....	635	354414.....	586	354826.....	599
353535.....	616	353662.....	635	354416.....	586	354827.....	599
353536.....	621	353664.....	635	354420.....	581	354830.....	599
353538.....	623	353666.....	635	354422.....	581	354835.....	600
353539.....	632	353668.....	635	354424.....	581	354836.....	600
353540.....	615	353670.....	635	354427.....	591	354839.....	624
353541.....	614	353672.....	648	354428.....	579	354845.....	598
353542.....	614	353674.....	648	354430.....	579	354847.....	602
353543.....	614	353680.....	634	354432.....	579	354900.....	172, 676
353545.....	616	353682.....	634	354434.....	582	354902.....	172, 676
353546.....	635	353684.....	634	354435.....	593	354904.....	172, 676
353550.....	618	353686.....	634	354436.....	582	354906.....	172, 676
353560.....	94, 617	353690.....	634	354438.....	582	354908.....	172, 676
353562.....	94, 617	353692.....	634	354442.....	583	354915.....	176, 680
353565.....	94, 617	353694.....	634	354444.....	583	354916.....	176, 680
353567.....	617	353696.....	634	354446.....	583	354917.....	176, 680
353568.....	615	353700.....	621	354448.....	586	354920.....	173, 677
353569.....	607	353800.....	638	354450.....	588	354928.....	173, 677
353570.....	608	353802.....	638	354452.....	588	354931.....	171, 676
353571.....	608	353806.....	636	354454.....	588	354941.....	174, 678
353580.....	643	353810.....	637	354456.....	587	354958.....	175, 679
353581.....	644	353812.....	637	354458.....	587	354959.....	175, 679
353582.....	643	353815.....	637	354460.....	587	354960.....	175, 679
353583.....	644	353817.....	637	354462.....	587	354961.....	175, 679
353584.....	643	353825.....	638	354464.....	589	354962.....	175, 679
353585.....	642	353827.....	638	354466.....	589	354964.....	180, 672, 804
353586.....	642	353835.....	639	354468.....	589	354964DG.....	180, 683
353588.....	644	353837.....	639	354470.....	589	354965.....	180, 682
353595.....	656	353840.....	639	354472.....	589	354965DG.....	180, 683
353596.....	656	353842.....	639	354474.....	590	354966.....	181, 682
353597.....	656	353860.....	648	354476.....	590	354967.....	181, 682
353600.....	652, 805	353862.....	648	354482.....	590	354969.....	181, 682
353602.....	652	353865.....	648	354484.....	590	354971.....	181, 681
353605.....	652	353872.....	102	354486.....	590	354972.....	683
353607.....	652	354000.....	647	354488.....	580	354973.....	683
353609.....	655	354002.....	647	354490.....	580	354974.....	683
353610.....	655	354004.....	647	354494.....	580	354975.....	683
353617.....	645	354005.....	647	354496.....	580	354981.....	174, 678
353618.....	645	354010.....	647	354500.....	633	354982.....	174, 678
353619.....	645	354031.....	640	354501.....	633	354985.....	175, 679
353620.....	641	354032.....	640	354720.....	596	354986.....	175, 679
353622.....	641	354033.....	640	354721.....	596	354987.....	175, 679
353623.....	631	354034.....	640	354722.....	596	354988.....	175, 679
353625.....	654	354084.....	631	354723.....	596	354990.....	162, 680
353626.....	654	354087.....	631	354724.....	596	354992.....	162, 680
353627.....	654	354100.....	632	354729.....	593	354994.....	162, 680
353630.....	653	354102.....	632	354730.....	593	354996.....	162, 680
353631.....	653	354125.....	598	354735.....	594	354998.....	162, 680
353632.....	653	354135.....	620	354737.....	594	355055.....	78
353635.....	653	354136.....	620	354739.....	594	355080.....	772
353639.....	624	354137.....	620	354750.....	591	355081.....	772
353640.....	555	354165.....	646	354755.....	595	355082.....	772
353641.....	650	354170.....	636	354800.....	603	355083.....	772
353642.....	650	354180.....	595	354801.....	603	355084.....	772
353643.....	650	354185.....	595	354802.....	603	355085.....	772
353645.....	556	354190.....	592	354803.....	603	355086.....	772
353646.....	556	354191.....	592	354804.....	603	355087.....	772
353647.....	555	354320.....	657	354805.....	602	355088.....	772
353650.....	651	354400.....	584	354806.....	602	355089.....	772
353651.....	655	354402.....	584	354807.....	602	355090.....	772
353653.....	655	354404.....	584	354808.....	603	355091.....	772
353655.....	649	354406.....	584	354810.....	598	355092.....	772
353656.....	649	354408.....	585	354815.....	601	355093.....	772
353657.....	608	354410.....	585	354816.....	601	355094.....	772
353658.....	656	354412.....	585	354817.....	601	355095.....	772

355096.....	772	356000.....	549	357651.....	674, 800	359069.....	709
355097.....	772	356002.....	549	357652.....	674, 800	359071.....	709
355098.....	772	356003.....	549	357653.....	668, 800	359073.....	709
355099.....	772	356025.....	629	357654.....	177, 685, 800	359074.....	709
355100.....	773	356027.....	625	357655.....	177, 685, 800	359075.....	709
355101.....	773	356028.....	625	357656.....	177, 685, 800	359080.....	713
355175.....	760	356031.....	629	357656DG.....	180, 683	359082.....	713
355180.....	795	356040.....	628	357657.....	177, 685, 800	359083.....	712
355182.....	795	356041.....	628	357658.....	553, 800	359085.....	712
355184.....	795	356045.....	625	357659.....	553, 800	359092.....	714
355186.....	795	356046.....	625	357660.....	553, 800	359093.....	714
355191.....	795	356051.....	627	357661.....	553, 800	359097.....	714
355192.....	795	356052.....	627	357667.....	177, 685	359099.....	711
355194.....	505, 719	356053.....	627	357672.....	177, 685	359102.....	711
355194.....	795, 953	356060.....	650	357674.....	177, 685	359103P.....	711
355196.....	607	356070.....	626	357675.....	177, 685	359104.....	711
355198.....	609	356071.....	626	357676.....	177, 685	359105.....	711
355275.....	773, 804	356072.....	626	357676DG.....	180, 683	359110.....	713
355276.....	773, 804	357100.....	578	357677.....	177, 685	359111.....	713
355277.....	773, 804	357102.....	578	357677DG.....	180, 683	359112.....	713
355278.....	773, 804	357106.....	578	357681.....	552	359113P.....	713
355285.....	771	357110.....	578	357690.....	665	359118.....	714
355286.....	325, 771	357180.....	609	357691.....	665	359119.....	714
355287.....	771	357185.....	609	358001.....	182, 684	359122.....	705
355288.....	771	357191.....	577	358002.....	182, 684	359123.....	705
355290.....	771	357192.....	577	358003.....	182, 684	359124.....	705
355291.....	325	357194.....	610	358007.....	555	359127.....	705
355291.....	771	357195.....	611	358344.....	719	359128.....	705
355292.....	771	357197.....	610	358350.....	957	359131.....	705
355295.....	771	357198.....	611	359003.....	706	359138.....	701
355296.....	771	357200.....	577	359006.....	706	359139.....	701
355297.....	771	357202.....	577	359016.....	708	359152.....	702
355298.....	771	357262.....	577	359017.....	708	359159.....	700
355299.....	771	357270.....	577	359018.....	708	359160.....	702
355300.....	771	357302.....	597	359019.....	708	359161.....	699
355301.....	771	357304.....	597	359020.....	708	359162.....	699
355302.....	771	357306.....	597	359021.....	52, 690	359163.....	699
355303.....	771	357308.....	597	359022.....	52, 690	359169.....	703
355304.....	771	357310.....	597	359024.....	52, 690	359170.....	703
355305.....	771	357532.....	761	359025.....	52, 690	359171.....	703
355306.....	771	357580.....	573	359027.....	52, 690	359173.....	700
355309.....	770	357581.....	573	359028.....	52, 690	359181.....	700
355310.....	770	357582.....	573	359029.....	52, 690	359183.....	700
355311.....	770	357583.....	573	359030.....	52, 690	359184.....	700
355312.....	770	357586.....	573	359031.....	52, 690	359185.....	699
355313.....	770	357590.....	574	359032.....	52, 690	359186.....	699
355314.....	770	357591.....	574	359033.....	693	359187.....	699
355315.....	770	357592.....	574	359034.....	693	359188.....	699
355493.....	799	357593.....	574	359036.....	693	359191.....	704
355495.....	799	357594.....	668	359037.....	693	359193.....	704
355497.....	798	357595.....	668	359042.....	693	359194.....	701
355500.....	798	357601.....	182, 685	359043.....	688	359195.....	700
355558DG.....	179, 683	357603.....	182, 685	359048.....	691	359201.....	695
355559DG.....	179, 683	357603DG.....	181, 684	359049.....	691	359206.....	695
355560DG.....	179, 683	357622.....	668	359050.....	692	359208.....	695
355798.....	79	357623.....	674	359051.....	691	359209.....	696
355799.....	79	357642.....	668	359052.....	689	359210.....	696
355800.....	79	357643.....	668	359053.....	689	359211.....	696
355801.....	79	357645.....	554	359054.....	692	359212.....	696
355810.....	795	357645DG.....	554	359055.....	710	359213.....	696
355819.....	563	357647.....	554	359058.....	710	359214.....	696
355830.....	796	357647DG.....	554	359059.....	710	359215.....	696
355832.....	796	357648.....	554	359061.....	710	359221.....	697
355834.....	796	357648DG.....	554	359062.....	710	359236.....	698
355838.....	796	357650.....	800	359063.....	710	359237.....	698

359238.....	704	359407.....	692	411625.....	1054	426050.....	1121
359250.....	706	380200.....	216	411700.....	247	426080.....	1121
359253.....	706	380202.....	216	411702.....	247	426090.....	309, 1120
359259.....	707	380204.....	216	411704.....	247	426092.....	309, 1120
359260.....	707	380206.....	216	411724.....	247	426094.....	309, 1120
359261.....	707	380208.....	216	411726.....	247	426096.....	309, 1120
359262.....	707	380210.....	216	411727.....	247	426098.....	309, 1120
359263.....	707	381801A.....	1147	411728.....	247	427002.....	309, 1120
359264.....	707	382710.....	223	412944L.....	1161	427370.....	1100
359265.....	707	382722.....	222	421200.....	1117	427382.....	1100
359266.....	707	382800.....	369	421510.....	218, 1119	427384.....	1100
359267.....	707	382805.....	369	421512.....	218, 1119	427390.....	1098
359268.....	707	386152.....	1033	421610.....	199	427392.....	1096
359269.....	707	392012.....	1151	421620.....	199	427400.....	1096
359270.....	707	392014.....	1151	421630.....	199	427410.....	1096
359271.....	707	392018.....	1152	421640.....	199	427420.....	1099
359272.....	707	392026.....	1151	422180.....	1117	428630.....	312, 1124
359273.....	707	392028.....	1151	422190.....	1117	428650.....	1122
359274.....	707	392034.....	1151	422200.....	1117	428655.....	1122
359275.....	707	392036.....	1151	422250.....	1117	429317.....	1125
359276.....	707	392040.....	1152	423320.....	1106	429318.....	1125
359277.....	707	392043.....	1152	423330.....	1106	429340.....	1125
359278.....	707	392204.....	1151	423340.....	1106	429512.....	1123
359279.....	707	394236.....	1152	423410.....	1109	429520.....	1123
359280.....	707	394237.....	1152	423422.....	1108	429524.....	1123
359281.....	707	394238.....	1152	423425.....	1114	429526.....	1122
359282.....	707	394246.....	1150	423428.....	1112	429527.....	1122
359283.....	693	394247.....	1150	423430.....	1112	429532.....	1123
359284.....	693	394250.....	1150	423432.....	1112	429534.....	1123
359296.....	694	394258.....	1150	423434.....	1112	429546.....	1122
359299.....	694	394267.....	1150	423438.....	1112	429548.....	1122
359307.....	694	394430.....	553, 1101	423440.....	1114	429566.....	1122
359313.....	703	394431.....	553, 1101	423450.....	1108	429594.....	325, 800
359314.....	701	394807.....	1150	423460.....	1108	429601.....	325
359321.....	703	394811.....	1150	423480.....	1109	431110.....	521
359325.....	698	395115.....	674	423490.....	1109	431111.....	521
359328.....	710	395118.....	41	424100.....	1115	431112.....	521
359329.....	710	395128.....	674	424102.....	1115	431120.....	521
359335.....	710			424110.....	1115	431130.....	521
359339.....	710			424170.....	1115	431325.....	507
359340.....	709			424180.....	1115	431360.....	508
359342.....	709	405188.....	1161	424190.....	1115	431362.....	508
359343.....	709	405910R.....	1161	425190.....	1101	431366.....	508
359344.....	710	405912.....	1161	425191.....	1101	431425.....	514
359345.....	710	405933L.....	1161	425200.....	1100	431433.....	516
359346.....	710	411140.....	502	425210.....	1100	431437.....	516
359347.....	710	411140.....	502	425312.....	1098	431440.....	516
359349.....	710	411145.....	502	425350.....	1096	431445.....	517
359350.....	710	411165.....	503	425360.....	1098	431446.....	517
359352.....	710	411166.....	503	425380.....	1098	431451.....	517
359353.....	715	411200.....	495	425390.....	1098	431452.....	517
359354.....	697	411201.....	495	425510.....	1105	431461.....	517
359355.....	697	411202.....	495	425520.....	1105	431462.....	517
359356.....	697	411203.....	495	425530.....	1105	431463.....	517
359357.....	697	411204.....	495	425560.....	1099	431480.....	517
359358.....	697	411230.....	495	425590.....	1098	431481.....	518
359359.....	688	411231.....	495	425605.....	1100	431710.....	518
359360.....	689	411232.....	495	425700.....	1102	431711.....	518
359361.....	688	411241.....	495	425710.....	1102	431728.....	518
359381.....	711	411331.....	522, 1124	425720.....	1102	431729.....	518
359382.....	714	411515.....	498	425730.....	1102	431732.....	518
359383.....	715	411520.....	497	425740.....	1102	431733.....	518
359401.....	709	411525.....	498	425750.....	1102	437081.....	383
359402.....	709	411535.....	499	426010.....	1120	437085.....	383
359403.....	709	411540.....	499	426040.....	1121	437111.....	383

4

437115.....	383	460140.....	115	462550.....	145	465155.....	36
437117.....	383	460165.....	115	462600.....	137	465160.....	36
437141.....	383	460170.....	115	462605.....	137	465165.....	36
437145.....	383	460175.....	115	462632.....	138	465170.....	36
438110.....	383	460177.....	115	462633.....	138	466150.....	41
438170.....	383	460179.....	115	462640.....	137	466151.....	40
441207.....	511, 991	460180.....	114	462641.....	137	466160.....	42
441208.....	511, 991	460219.....	115	462680.....	144	466170.....	43
441420.....	1010	460220.....	115	462681.....	144	466200.....	38
441530.....	512, 971	460245.....	115	462690.....	144	466210.....	38
441555.....	513, 972	460400.....	117	462691.....	144	466211.....	38
441730.....	505	460410.....	117	463810.....	105	466220.....	39
441740.....	506	460420.....	117	463820.....	107	466225.....	39
442100.....	189	460430.....	117	463830.....	105	466225.....	549
442102.....	189	460460.....	117	463840.....	106	467100.....	44
442104.....	189	460461.....	117	463885.....	103	467105.....	44
442106.....	189	460600.....	119	463900.....	150	467110.....	44
442108.....	189	460601.....	119	463901.....	150	467115.....	44
442110.....	190	460620.....	117	463903.....	150	467120.....	44
442145.....	187	460630.....	117	463910.....	150	467125.....	44
442147.....	187	460720.....	121	463911.....	150	468190.....	52
442210.....	198	460820.....	126	463912.....	150	468220.....	49
442245.....	205	460821.....	126	463913.....	150	468230.....	49
442260.....	204	460830.....	125	463915.....	150	468240.....	49
442288.....	216	460840.....	126	463920.....	151	471100.....	340
442295.....	197	460841.....	126	463921.....	151	471105.....	340
442502.....	141	460870.....	126	463930.....	151	471115.....	340
442510.....	138	460871.....	126	463932.....	151	471120.....	340
442512.....	138	460873.....	133	463941.....	150	471125.....	340
442515.....	143	460880.....	126	463950.....	147	471130.....	340
442525.....	142	460881.....	126	464220.....	138	471135.....	340
442560.....	123	460883.....	133	464500.....	116	471140.....	340
442576.....	142	460884.....	126	464502.....	116	471175.....	328
443100.....	153	460885.....	126	464600.....	118	471185.....	328
443120.....	154	460889.....	126	464605.....	118	471210.....	328
443480.....	509, 1105	461125.....	529	464610.....	118	471215.....	328
443500.....	75	461126.....	529	464615.....	118	475080.....	65
443502.....	75	461128.....	529	464700.....	128	475082.....	65
443505.....	75	461310.....	133	464701.....	128	475084.....	64
443507.....	75	461311.....	133	464705.....	128	475086.....	64
443508.....	75	461350.....	524	464706.....	128	475100.....	64
443510.....	75	461351.....	524	464707.....	127	475101.....	64
443512.....	75	461352.....	524	464710.....	128	475102.....	64
443610.....	509	461353.....	524	464711.....	128	475130.....	66
447025.....	38	461354.....	524	464712.....	127	475131.....	66
447030.....	47	461430.....	139	464715.....	128	475200.....	72
447050.....	32	461431.....	139	464716.....	128	475201.....	72
450205.....	26	461600.....	525	464718.....	127	475210.....	67
452510.....	525	461605.....	525	464720.....	128	475211.....	67
452550.....	525	461610.....	526	464721.....	128	475250.....	101
452551.....	525	461615.....	526	464722.....	127	475305.....	61
454100.....	27	461660.....	535	464725.....	128	475306.....	61
454300.....	32	461661.....	535	464726.....	128	475307.....	61
454305.....	32	462105.....	126	464727.....	127	475308.....	62
454320.....	31	462110.....	126	464800.....	131	475309.....	62
454322.....	31	462120.....	119	464801.....	131	475310.....	63
456002.....	25	462121.....	119	464810.....	140	475311.....	63
456005.....	25	462148.....	131	465100.....	36	475312.....	63
456006.....	25	462149.....	131	465105.....	36	475313.....	63
456007.....	25	462150.....	131	465110.....	36	476105.....	69
460100.....	115	462151.....	131	465115.....	36	476106.....	69
460105.....	115	462201.....	133	465120.....	36	476110.....	69
460110.....	115	462530.....	133, 673	465125.....	36	476115.....	69
460115.....	115	462540.....	145	465130.....	36	476120.....	69
460135.....	115	462541.....	145	465150.....	36	476125.....	69

503625	538	505342	419	506476	428	507014	464
503627	538	505400	456, 778	506477	428	507015	464
503629	538	505402	456	506478	428	507020	464
503631	538	505403	456	506479	428	507023	464
503633	538	505404	456	506485	421	507027	464
503635	538	505406	456	506663	431	507028	464
503650	538	505414	456	506664	431	507030	421
503652	538	505415	456	506665	431	507031	463
503654	538	505420	456, 778	506666	431	507032	463
503656	538	505422	456	506667	431	507033	463
503658	538	505432	456	506668	431	507034	463
503660P	538	505433	456	506669	431	507035	463
503675	538	505450	457	506672	429	507040	463
503676	538	505455	457	506673	431	507041	463
503677	538	505456	457	506679	429	507045	421, 777
504075	311, 437	505462	457	506680	430	507046	421, 464, 777
504171	68	505463	457	506705	26	507048	464
504180	59	505515	460	506705	436, 535	507050	463
504181	59	505605	429	506707	436, 781	507051	463
504190	83	505650	462	506742	781	507052	463
505005	461	505654	462	506743	781	507055	463
505010	461	505662	462	506744	781	507057	463
505014	461	505670	462	506746	781	507060	463
505016	461	505674	462	506747	420, 780	507065	463
505018	461	505680	462	506748	779	507120	430
505020	461	505682	462	506749	781	507121	430
505022	461	505686	462	506750	436	507122	430
505028	461	505690	462	506751	436	507267S	438
505030	461	506000	459	506752	436	507335	437, 768
505032	461	506003	459	506800	423	507336	437, 769
505046	461	506004	459	506802	424	507375	418
505048	461	506008	459	506804	424	507434	437
505050	461	506016	459	506806	424	507453	777
505056	461	506017	459	506808	424	507454	777
505100	418, 778	506053	459	506810	424	507485S	438
505102	418	506060	458	506812	424	507498S	438
505104	418, 778	506063	458	506814	424	507500	472
505106	418	506070	458	506816	424	507501	472
505110	419, 779	506075	458	506818	424	507502	472
505112	419, 779	506076	458	506820	424	507503	472
505113	455	50613AC	468	506822	424	507504	472
505114	419, 779	50614AC	468	506824	424	507505	472
505116	419, 779	50615AC	468	506830	425	507506	472
505123	455	506150	457	506832	425	507507	472
505130	455	506152	457	506842	425	507508	472
505132	455	506155	460	506844	425	507509	472
505134	455	506157	460	506856	422	507510	472
505136	455	50616AC	468	506858	422	507511	472
505138	455	506220	458	506860	422	507512	472
505140	455	506232	458	506862	422	507513	472
505142	455	506251	458	506864	422	507514	472
505144	455	506252	458	506870	426	507515	472
505146	455	506330	457	506872	426	507516	472
505148	455	506331	457	506874	426	507517	472
505150	455	50640	1160	506880	425	507595	469
505152	455	506455	427	506882	425	507596	469
505160	453	506460	427	506884	425	507597	469
505162	453	506461	427	506888	425	507598	469
505166	453	506462	427	506890	423, 426	507599	469
505168	453	506463	427	506950	427	507600	469
505195	420	506465	427	506952	427	507601	469
505196	420	506470	428	507010	421	507602	469
505230	420, 779	506471	428	507011	464	507603	469
505313	454	506472	428	507012	464	507604	469
505334	454	506475	428	507013	464	507605	469

507606	469	508208	438, 526	510311	156	514412	206
507607	469	508209	438, 526	510312	156	514412	492
507608	469	508230	430, 447, 494	510321	159	514413	192
507609	469	508541	447, 494	510325	158	514413	492
507610	469	508542	447, 494	510335	157	514414	193
507611	469	508543	447, 494	510395	157	514414	492
507612	469	508544	447, 494	510400	163	514430	194, 493
507613	469	508545	494	510405	163	514431	194, 493
507614	469	508546	494	510410	163	514433	194, 493
507615	469	508547	494	510415	163	514435	194, 493
507807	471	508548	494	510420	163	514436	194, 493
507808	471	508590	459	510430	163	514437	194, 493
507809	471	508600	290	510440	160	514438	194, 493
507810	471	508601	290	510441	160	514480	81
507812	471	508602	291	510445	160	515105	486
507814	471	508605	290	510467	170	515106	486
507816	471	508606	290	510469	170	515110	486
507818	471	508610	292	511101	167	515115	486
507820	471	508612	292	511102	167	515116	486
507822	471	508614	292	511110	168	515120	486
507824	471	508694	292	511112	168	515121	486
507826	471	508696	292	511115	162	515125	486
507828	471	509004	432	511125	478	515126	486
507830	471	509005	432	511130	162	516270	487
507832	471	509006	432	511130P	478	516275	487
507834	471	509007	432	511131	162	516280	487
507836	471	509008	432	511132	162	516285	487
507838	471	509009	432	511133	162	516390	488
507840	471	509010	432	511134	162	516400	488
507842	471	509012	433	511134P	478	516430	488
507875	471	509013	433	511135	162	518010	475
507876	471	509014	433	511135P	478	518015	475
507877	471	509201	435	511138	162	518020	475
507920	470	509202	435	511139	162	518025	475, 480
507922	470	509203	435	511139P	478	518025A	479
507924	470	509204	291, 435	511140	478	518029*	475
507926	470	509205	435	511144	478	518029A*	479
507928	470	509206	435	511145P	478	518030	475, 480
507930	470	509207	436	511149	478	518030A	479
507932	470	509209	291	511250	168	518034*	475
507934	470	509214	432	511251	168	518034A*	479
507936	470	509215	432	511252	169	518035	475, 480
507938	470	509216	432	511635	485	518035A	479
507940	470	509301	410, 434	511725	483	518039*	475
507942	470	509302	410, 434	511729	483	518039A*	479
507944	470	509304	410, 434	511730	483	518040	475, 480
507946	470	509305	410, 434	511734	483	518040A	479
507948	470	510100	166	511735	483	518044*	475
507950	470	510101	166	511739	483	518045	475
507952	470	510110	166	511740	483	518049*	475
507954	470	510111	166	511744	483	518050	475
507956	470	510120	166	511745	483	518055	475
507958	470	510121	166	511749	483	518085	480
507960	470	510130	166	511930	484	518100	481
508000	470	510131	166	511940	484	518115	481
508002	326, 412	510140	166	511945	484	518120	481
508004	326, 412	510151	167	511955	484	518125	481
508200	438, 526	510161	167	512205	484	518129*	481
508201	438, 526	510181	152	512780	489	518130	481
508202	438, 526	510201	164	512782	489	518134*	481
508203	438, 526	510211	164	512784	489	518135	481
508204	438, 526	510221	169	514375	491	518139*	481
508205	438, 526	510241	164	514376	491	518140	481
508206	438, 526	510250	174	514377	491	518144*	481
508207	438, 526	510251	164	514380	491	518145	481

518149*	481	521554	390, 393, 539	522261	540	522585	440, 542
518150	481	521556	390, 393, 539	522261	540	522586	440, 542
518155	481	521558	390, 393, 539	522262	540	522587	440, 542
518215	477	521820	390, 394, 539	522263	540	522590	443
518220	477	521824	390, 394, 539	522264	540	522595	443
518225	477	522000	539	522265	540	522596	443
518230	477	522001	539	522266	540	522600	542
518235	477	522002	395	522267	540	522602	542
518240	477	522002	390, 539	522268	540	522604	542
518245	477	522004	390, 395, 539	522269	541	522606	542
518250	477	522010	390, 395, 539	522270	541	522608	542
518315	481	522012	390, 395, 539	522271	541	523100	386
518320	481	522020	539	522272	541	523100P	542
518325	481	522022	539	522273	541	523101P	542
518330	481	522030	390, 396, 539	522274	541	523101P	542
518335	481	522032	390, 396, 539	522275	541	523105	386
518340	481	522034	539	522276	541	523106	386
518426	477	522035	539	522280	541	523109	386
518431	477	522040	390, 395, 539	522290	390, 406, 541	523110	386
518436	477	522045	390, 395, 396, 538	522291	390, 407, 541	523110P	542
518441	477	522190	405, 539	522292	406, 541	523111	386
518446	477	522191	405, 539	522293	541	523111P	542
518456	477	522193	390, 539	522294	541	523120	383, 386
518521	482	522194	390, 411, 539	522295	541	523120P	442, 542
518526	482	522195	411	522296	541	523121	383, 386
518531	482	522200P	539	522297	541	523130	386
518536	482	522202	539	522300P	541, 776	523130P	442, 542
518541	482	522204	539	522301	541, 776	523131	542
518546	482	522205	539	522302	541, 776	523135	386
518556	482	522206	390, 397, 539	522305P	541	523140	386
518620	478	522207	539	522306	541, 776	523140P	442, 542
518625	478	522208	539	522310P	541	523150	386
518630	478	522209	390, 397, 539	522311	541, 776	523150P	442, 542
518635	478	522210	539	522401	541	523151	386
518640	478	522215	539	522402	541	523160	386
518720	482	522215	539	522403	541	523160P	442, 542
518730	482	522216	390, 397, 539	522404	541	523165	386
518900	476	522220	398, 539	522408	541	523166	386
518902	476	522222	390, 398, 540	522412	541	523167	386
518904	476	522224	390, 398, 540	522500	541	523168	386
518906	476	522225P	390, 398, 540	522502	541	523170	386, 542
518908	476	522226	411, 540	522504	541	523172	542
519000	487	522227	540	522506	541	523174	542
519005	487	522228	390, 402, 540	522508	541	523175	386
519010	487	522229	390, 399, 540	522510	541	523176	542
519015	487	522230	540	522512	541	523177	386
519020	487	522231	390, 540	522514	541	523178	386
519025	487	522232	405	522516	541	523178P	542
519030	487	522232	540	522525	541	523180	386
520120	113	522232	390, 540	522527	541	523180P	542
520130	113	522233	390, 406, 540	522550	441, 541	523182	542
520135	111	522234	540	522552	441, 542	523210P	442
520140	111	522235	540	522554	441, 542	523300	386
520150	112	522236	540	522556	441, 542	523335	386
520152	112	522237	390, 540	522558	542	523360	386
521185	326	522238	390, 540	522575	440, 542	523370	386
521186	326	522240	417	522576	440, 542	523400	386
521187	326	522241	399, 417	522577	440, 542	523435	386
521450	390, 391, 538	522242	390, 408, 540	522578	440, 542	523460	386
521455	390, 391, 538	522243	390, 540	522579	440, 542	523470	386
521460	390, 391, 539	522244	390, 540	522580	440, 542	523500P	542
521465	390, 391, 539	522245	390, 540	522581	440, 542	523502	542
521500	390, 392, 539	522250	540	522582	440, 542	523505	448, 452
521550	390, 393, 539	522255	540	522583	440, 542	523525	542
521552	393, 539	522260	540	522584	440, 542	523527	542

523529	542	523800	386	526220	536	527550	543
523533	542	523835	386	526222	536	527555	542
523535	542	523860	386	526226	536, 538, 541	527560	542
523537	542	523870	386	526230	536, 538, 541	527565	543
523539	542	524010	445	526238	538, 542	527575	542
523540	386	524012	445	526260	538, 543	527580	542
523541	542	524022	445	526262	538, 543	527583	543
523550	386, 542	524036	444	526264	538, 543	527585	543
523551	386	524037	444	526266	538, 543	527586	540
523552	542	524038	444	526268	538, 543	527587	540
523554	542	524039	444	526270	538, 543	527664	543
523556	542	524040	444	526272	538, 543	527800	539
523558	543	524041	444	526274	538, 543	527800 (L)	403, 540
523560	543	524042	445	526276	538, 543	527805	539
523562	543	524044	445	526278	538, 543	527805 (R)	403, 540
523564	543	524045	445	526280	538, 543	527810	539
523570	448, 450, 543	524050	445	526282	538, 543	527810 (L)	540
523571	448, 450, 543	524060	411	526284	538, 543	527815	539
523572	448, 450, 543	524230	191	526292	537	527815 (R)	540
523573	448, 450, 543	525150	217	526294	537	527820	539
523574	448, 450, 543	525215	217	526350	536, 541	527820 (L)	403, 540
523575	448, 450, 543	526000	536, 539	526351	536, 541	527825	539
523576	543	526002	536	526352	536, 541	527825 (R)	403, 540
523577	448, 450, 543	526004	536	526360 (L)	541	527830 (R)	403, 540
523578	543	526006	536, 539	526361 (R)	541	527835 (L)	403, 540
523579	448, 450, 543	526007	536	526362 (L)	541	527850	403, 540
523580	543	526008	536, 539	526363 (R)	541	527853	403, 540
523581	448, 450, 543	526010	536	526365	539	527855	540
523582	448, 450, 543	526012	536	526365 (R)	540	527860	403, 540
523600	386	526014	536	526366	539	527862	403, 540
523600P	448, 451, 543	526018	536, 539	526366 (L)	540	527863	403, 540
523602	448, 451, 543	526020	538, 543	526370	539	527864	539
523604	448, 451, 543	526022	536	526370 (R)	540	527865	539
523606	451, 543	526024	536	526371	539	527866	539
523608	448, 451, 543	526026	536, 539	526371 (L)	540	527867	411, 539
523610P	448, 451, 543	526028	536, 539	526375	539	528135	1163
523612	448, 451, 543	526030	536	526375 (R)	540	528235	1163
523614	448, 451, 543	526032	536	526376	539	528300P	466
523625	543	526038	536, 539	526376 (L)	540	528302P	466
523627	543	526042	538, 543	526500	539	528303P	466
523629	543	526044	536	526505	539	528304P	466
523631	543	526046	538, 543	526510	538	528305XLTP	466
523633	543	526048	537, 542	526512	538	528308P	466
523635	386, 543	526054	537, 541	526515	539	528309P	466
523640	448, 543	526060	537, 541	526516	539	528310P	466
523642	448, 543	526068	537, 542	526520	540	528339P	466
523644	448, 543	526070	538, 542	526524	540	528340P	466
523646	448, 543	526150	537	526525	540	528341P	466
523648	448, 543	526152	537	526526	539	528342P	466
523649	448, 543	526158	537	526527	539	528343P	466
523650P	448, 543	526159	537	526528	539	528344P	466
523652	448, 543	526160	537	526529	540	528351P	466
523654	448, 543	526164	537	526640	543	528352P	466
523656	448, 543	526166	537	526642	543	528353P	466
523658	448, 543	526200	536	526644	543	528354P	466
523660	386	526201	539	526646	543	528355P	466
523660P	448, 543	526202	536	526648	543	528700	543
523670	386	526203	539	526649	543	528701	543
523675	448, 543	526204	536, 539	527500	541	528702	543
523676	543	526206	536, 539	527505	542	533105	387
523677	448, 452, 543	526208	536	527510	542	533106	387
523700	386	526210	536, 539, 541	527515	542	533108	387
523735	386	526212	536, 539	527520	542	533109	387
523760	386	526214	536, 539	527521	541	533110	387
523770	386	526218	536, 538, 541	527525	542	533111	387

1037827	490
1037828	490
1037829	490
1037830	490
1037831	490
1037832	490
1037833	490
1037834	490
1037835	490
1037836	490
1037837	490
1037838	490
1037839	490

A

A358AFA	467
A358PRA	467

DP

DP-28K	764
DP-36K	764
DP-40K	764
DP-44K	764
DP-48K	764
DP-52K	764
DP-56K	764
DP-60K	764

E

EFX-001	1162
---------	------

G

GFS-1A	1158
GFS-10A	1158

KM1-2

K05-01251	1160
KM11202	107
KM28468	1087
KM28492	1086
KM28514	1087
KM29430	1086
KM29434	1086
KM29495	313
KM29496	313
KM29497	313
KM29498	313
KM29499	313
KM29500	313
KM29503	315
KM29505	315
KM29507	315
KM29511	314
KM29512	314
KM29513	314
KM29514	314
KM29515	314

KM29517	314
KM29566	315
KM29580	315
KM29582	315
KM29584	315
KM29592	315
KM29604	314
KM29606	314
KM29620	982
KM29630	982
KM29632	981
KM31680	105

KM3

KM31792	104
KM31804	104
KM31834	103
KM31836	104
KM34306	119
KM34308	119
KM34310	119
KM34312	119
KM34334	120
KM34336	120
KM34348	122
KM34354	122
KM34356	122
KM34458	127
KM34462	127
KM34472	127
KM34474	127
KM34560	142
KM34562	142
KM34602	139
KM34607	139
KM34612	139
KM34621	140
KM34642	123
KM34648	145
KM35068	111
KM35078	109
KM35080	110
KM35084	108
KM35092	111
KM35104	109
KM35120	108
KM35200	114
KM35202	146
KM35210	146
KM35212	146
KM35214	146
KM35220	147
KM35250	147
KM35280	147
KM35286	147
KM35292	147
KM35298	147
KM35316	147
KM35322	147
KM35340	147
KM35364	148
KM35370	148
KM35380	148

KM35382	148
KM35392	148
KM35394	148
KM35396	148
KM35406	148
KM35418	148
KM35430	148
KM35450	149
KM35452	149
KM35454	149
KM35460	149
KM35484	149
KM35490	149
KM35494	149
KM35496	148
KM35510	135
KM36078	66
KM36164	76
KM36165	76
KM36196	73
KM36198	73
KM36360	71
KM36362	71
KM36566	85
KM38082	40
KM38304	44
KM39050	46
KM39052	37
KM39054	46
KM39056	46
KM39057	46
KM39058	37
KM39059	37
KM39060	37
KM39062	37
KM39064	46
KM39086	43
KM39088	54
KM39364	34
KM39366	34
KM39386	34
KM39390	34
KM39410	34
KM39412	34
KM39478	35
KM39509	35
KM39511	35
KM39513	35
KM39534	35
KM39536	35
KM39670	343
KM39682	346
KM39684	346
KM39692	311, 1077
KM39694	311, 1077
KM39698	311, 1077
KM39700	311, 1077

KM4

KM41064	155
KM41066	155
KM41068	160
KM41162	165

KM41164	165
KM41270	167
KM41272	167
KM41278	167
KM41284	167
KM41286	167
KM41300	167
KM41424	161
KM41428	161
KM41440	161
KM41452	161
KM42254	322
KM42256	323
KM42258	323
KM42618	310
KM42823	245
KM42824	245
KM42825	245
KM42825P	245
KM42826	245
KM42830	245
KM42863	246
KM42864	246
KM42866	246
KM42873	246
KM42874	246
KM42876	246
KM42880	248
KM42881	248
KM42882	248
KM42883	248
KM42884	248
KM42885	248
KM42890	248
KM42891	248
KM42892	248
KM42893	248
KM42894	248
KM42895	248
KM42901	248
KM42902	248
KM42903	248
KM42904	248
KM42905	248
KM42906	248
KM44012	1100
KM44014	1101
KM44018	1111
KM44020	1111
KM44022	1107
KM44024	1110
KM44028	321
KM44030	321
KM44121	183
KM44122	183
KM44123	183
KM44124	183
KM44125	183
KM44126	183
KM44127	183
KM44128	183
KM44129	183
KM44130	183
KM44131	183
KM44132	183

KM44133	183	KM44257	1111	KM46266	956	KM46381	994
KM44134	183	KM44260	1108	KM46268	992	KM46382	994
KM44135	183	KM44261	1108	KM46270	992	KM46383	994
KM44136	183	KM44262	1108	KM46272	992	KM46384	994
KM44137	183	KM44263	1108	KM46274	992	KM46387	1003
KM44138	183	KM44270	1109	KM46276	992	KM46388	1003
KM44139	183	KM44271	1109	KM46278	992	KM46389	1003
KM44150	183	KM44272	1109	KM46280	992	KM46390	1003
KM44151	183	KM44273	1109	KM46284	993	KM46391	1003
KM44152	183	KM44274	1109	KM46286	993	KM46392	1003
KM44153	183	KM44275	1109	KM46288	993	KM46393	1003
KM44154	183	KM44276	1109	KM46289	998	KM46394	1003
KM44155	177	KM44277	1109	KM46290	998	KM46395	1003
KM44156	177	KM45002	854	KM46291	998	KM46401	1003
KM44157	177	KM45004	870	KM46292	1001	KM46402	1003
KM44158	177	KM45208	873	KM46293	1001	KM46403	1003
KM44159	182	KM45210	873	KM46294	1001	KM46404	1003
KM44160	182	KM45300	929	KM46304	990	KM46405	1003
KM44161	182	KM45302	915	KM46306	990	KM46407	1003
KM44162	182	KM45304	915	KM46310	990	KM46408	1003
KM44163	177	KM45305	916	KM46314	990	KM46409	1003
KM44164	177	KM45306	916	KM46318	990	KM46410	1003
KM44165	177	KM45307	916	KM46322	990	KM46411	1003
KM44166	177	KM45310	932	KM46328	990	KM46412	1003
KM44167	177	KM45312	932	KM46329	990	KM46413	962
KM44168	177	KM45314	932	KM46330	990	KM46413S	963
KM44169	177	KM45410	847	KM46331	990	KM46414	962
KM44170	177	KM45412	847	KM46332	990	KM46414S	963
KM44171	182	KM45501	877	KM46333	990	KM46416	962
KM44172	182	KM45502	877	KM46335	988	KM46416S	963
KM44173	182	KM46056	1076	KM46336	988	KM46418	962
KM44174	182	KM46058	1075	KM46338	988	KM46418S	963
KM44175	182	KM46090	1074	KM46340	988	KM46420	962
KM44176	182	KM46133	1076	KM46342	988	KM46420S	963
KM44177	182	KM46134	1076	KM46343	988	KM46422	978
KM44178	182	KM46138	1075	KM46344	988	KM46422S	979
KM44200	178	KM46156	1074	KM46345	988	KM46423	978
KM44201	178	KM46184	1075	KM46346	988	KM46423S	979
KM44202	178	KM46186	1075	KM46347	988	KM46424	978
KM44203	178	KM46188	1074	KM46348	989	KM46424S	979
KM44204	178	KM46206	960	KM46349	989	KM46425	978
KM44205	178	KM46207	960	KM46350	989	KM46425S	979
KM44207	178	KM46208	958	KM46351	989	KM46426	978
KM44208	178	KM46210	958	KM46352	989	KM46426S	979
KM44210	179	KM46211	960	KM46353	989	KM46427	978
KM44211	179	KM46212	960	KM46354	989	KM46427S	979
KM44212	179	KM46213	960	KM46355	989	KM46428	978
KM44213	179	KM46214	960	KM46356	989	KM46428S	979
KM44214	178	KM46215	961	KM46358	989	KM46429	978
KM44215	178	KM46216	961	KM46359	994	KM46429S	979
KM44216	179	KM46217	961	KM46360	994	KM46430	978
KM44217	179	KM46222	958	KM46361	994	KM46430S	979
KM44218	179	KM46224	958	KM46362	994	KM46433	978
KM44219	179	KM46244	958	KM46363	994	KM46433S	979
KM44220	179	KM46245	958	KM46364	994	KM46434	978
KM44221	179	KM46246	958	KM46365	994	KM46434S	979
KM44222	179	KM46248	958	KM46366	994	KM46435	978
KM44223	179	KM46250	965	KM46367	994	KM46435S	979
KM44250	1107	KM46252	965	KM46368	994	KM46436	978
KM44251	1107	KM46254	965	KM46373	994	KM46436S	979
KM44252	1107	KM46256	965	KM46376	994	KM46437	978
KM44253	1107	KM46258	956	KM46377	994	KM46437S	979
KM44254	1111	KM46260	956	KM46378	994	KM46438	978
KM44255	1111	KM46262	956	KM46379	994	KM46438S	979
KM44256	1111	KM46264	956	KM46380	994	KM46439	978

KM46439S.....	979	KM46554.....	977	KM46660.....	1008	KM46852.....	894
KM46440.....	978	KM46555.....	977	KM46661.....	1010	KM46854.....	894
KM46440S.....	979	KM46556.....	977	KM46662.....	1008	KM46858.....	892
KM46441.....	978	KM46557.....	977	KM46662P.....	1008	KM46860.....	888
KM46441S.....	979	KM46558.....	977	KM46663.....	1013	KM46870.....	888
KM46444.....	995	KM46559.....	977	KM46664.....	874	KM46872.....	887
KM46449.....	995	KM46560.....	983	KM46666.....	1012	KM46880.....	885
KM46450.....	995	KM46561.....	983	KM46667.....	1013	KM46884.....	885
KM46451.....	995	KM46562.....	983	KM46683.....	1072	KM46892.....	886
KM46452.....	995	KM46563.....	975	KM46684.....	1072	KM46893.....	1005
KM46453.....	995	KM46564.....	975	KM46685.....	1072	KM46894.....	1005
KM46454.....	995	KM46565.....	975	KM46686.....	1011	KM46895.....	1005
KM46457.....	995	KM46566.....	975	KM46686P.....	1011	KM46896.....	1005
KM46458.....	995	KM46567.....	975	KM46687.....	1011	KM46897.....	1005
KM46459.....	995	KM46568.....	975	KM46687P.....	1011	KM46898.....	1005
KM46460.....	995	KM46569.....	975	KM46688.....	1014	KM46899.....	1005
KM46461.....	995	KM46570.....	975	KM46689.....	1014	KM46902.....	964
KM46462.....	995	KM46571.....	975	KM46690.....	1014	KM46903.....	964
KM46463.....	995	KM46572.....	841	KM46690P.....	1014	KM46904.....	964
KM46466.....	1002	KM46573.....	841	KM46700.....	991	KM46906.....	887
KM46467.....	1002	KM46574.....	841	KM46701.....	991	KM46907.....	887
KM46468.....	1002	KM46578.....	838	KM46702.....	991	KM46908.....	887
KM46476.....	1002	KM46582.....	819	KM46703.....	991	KM46911.....	914
KM46477.....	1002	KM46598.....	1073	KM46704.....	991	KM46912.....	914
KM46478.....	1002	KM46600.....	1073	KM46705.....	969	KM46913.....	941
KM46479.....	1002	KM46601.....	1072	KM46706.....	991	KM46914.....	941
KM46487.....	1002	KM46602.....	1073	KM46708.....	991	KM46915.....	941
KM46488.....	1002	KM46609.....	1071	KM46709.....	991	KM46916.....	940
KM46489.....	1002	KM46610.....	1071	KM46730.....	948	KM46917.....	849
KM46490.....	1002	KM46612.....	1071	KM46731.....	948	KM46918.....	849
KM46491.....	1002	KM46613.....	1071	KM46732.....	948	KM46919.....	1002
KM46493.....	1002	KM46614.....	1071	KM46733.....	948	KM46922.....	899
KM46495.....	1002	KM46615.....	1071	KM46734.....	948	KM46930.....	881
KM46497.....	991	KM46616.....	1071	KM46735.....	945	KM46932.....	880
KM46498.....	991	KM46617.....	1071	KM46736.....	946	KM46934.....	884
KM46499.....	991	KM46619.....	817	KM46737.....	946	KM46936.....	884
KM46500.....	991	KM46620.....	1072	KM46738.....	946	KM47010.....	917
KM46501.....	991	KM46621.....	824	KM46739.....	945	KM47012.....	919
KM46502.....	991	KM46622.....	823	KM46744.....	944	KM47054.....	922
KM46503.....	991	KM46623.....	825	KM46746.....	944	KM47056.....	922
KM46504.....	991	KM46624.....	825	KM46748.....	944	KM47062.....	922
KM46505.....	999	KM46625.....	826	KM46750.....	943	KM47064.....	922
KM46506.....	999	KM46626.....	830	KM46762.....	946	KM47068.....	923
KM46507.....	999	KM46629.....	829	KM46766.....	946	KM47070.....	923
KM46508.....	999	KM46631.....	826	KM46770.....	946	KM47072.....	920
KM46509.....	999	KM46632.....	829	KM46772.....	946	KM47074.....	919
KM46511.....	975	KM46633.....	829	KM46802.....	942	KM47076.....	919
KM46512.....	975	KM46635.....	833	KM46804.....	943	KM47078.....	923
KM46513.....	975	KM46637.....	818	KM46814.....	942	KM47080.....	923
KM46515.....	975	KM46642.....	1073	KM46818.....	942	KM47082.....	923
KM46517.....	975	KM46643.....	1073	KM46821.....	947	KM47084.....	923
KM46519.....	975	KM46644.....	1073	KM46823.....	891	KM47090.....	926
KM46521.....	975	KM46645.....	1072	KM46826.....	893	KM47092.....	926
KM46523.....	975	KM46646.....	1072	KM46827.....	894	KM47094.....	926
KM46525.....	975	KM46647.....	827	KM46828.....	947	KM47096.....	926
KM46529.....	975	KM46649.....	828	KM46829.....	891	KM47098.....	926
KM46531.....	975	KM46650.....	969	KM46830.....	891	KM47100.....	933
KM46538.....	811	KM46651.....	828	KM46832.....	891	KM47101.....	933
KM46539.....	811	KM46652.....	969	KM46836.....	892	KM47102.....	934
KM46540.....	813	KM46653.....	972	KM46838.....	892	KM47103.....	934
KM46542.....	811	KM46654.....	969	KM46841.....	893	KM47105.....	931
KM46550.....	982	KM46655.....	971	KM46842.....	893	KM47107.....	931
KM46551.....	977	KM46656.....	1008	KM46848.....	892	KM47108.....	924
KM46552.....	977	KM46657.....	1010	KM46849.....	894	KM47109.....	924
KM46553.....	977	KM46658.....	1013	KM46850.....	893	KM47110.....	924

KM47112.....	924	KM47286.....	1023	KM47557.....	1017	KM47857.....	1051
KM47114.....	924	KM47302.....	1027	KM47558.....	1029	KM47858.....	1061
KM47116.....	924	KM47304.....	1027	KM47560.....	1029	KM47860.....	1061
KM47118.....	925	KM47306.....	1027	KM47562.....	1029	KM47862.....	1061
KM47119.....	927	KM47308.....	1024	KM47610.....	1052	KM47864.....	1061
KM47120.....	926	KM47310.....	1022	KM47612.....	1052	KM47866.....	1061
KM47122.....	927	KM47366.....	1017	KM47614.....	1052	KM47868.....	1061
KM47124.....	927	KM47370.....	1017	KM47616.....	1052	KM47870.....	1061
KM47126.....	927	KM47374.....	1018	KM47620.....	1049	KM47872.....	1061
KM47128.....	931	KM47380.....	1040	KM47621.....	1049	KM47873.....	1061
KM47129.....	917	KM47382.....	1040	KM47622.....	1049	KM47874.....	1061
KM47130.....	914	KM47384.....	1040	KM47623.....	1049	KM47875.....	1061
KM47132.....	928	KM47386.....	1040	KM47624.....	1049	KM47878.....	1061
KM47133.....	930	KM47398.....	1016	KM47644.....	1048, 1050	KM47879.....	1051
KM47134.....	929	KM47400.....	1016	KM47645.....	1048, 1050	KM47880.....	938
KM47135.....	930	KM47402.....	1016	KM47646.....	1048, 1050	KM47901.....	814
KM47136.....	928	KM47404.....	1016	KM47648.....	1048, 1050	KM47902.....	854
KM47137.....	928	KM47406.....	1016	KM47649.....	1048, 1050	KM47903.....	814
KM47138.....	918	KM47408.....	1016	KM47650.....	1048, 1050	KM47904.....	854
KM47139.....	919	KM47410.....	1016	KM47652.....	1050	KM47906.....	1092
KM47140.....	935	KM47412.....	1016	KM47654.....	1050	KM47908.....	854
KM47154.....	935	KM47458.....	1039	KM47656.....	1050	KM47912.....	847
KM47156.....	935	KM47460.....	1039	KM47657.....	1050	KM47914.....	847
KM47160.....	936	KM47461.....	1039	KM47658.....	1050	KM47915.....	876
KM47164.....	936	KM47462.....	1039	KM47670.....	1047	KM47916.....	876
KM47166.....	936	KM47464.....	1039	KM47671.....	1047	KM47917.....	876
KM47167.....	935	KM47472.....	1038	KM47674.....	1047	KM47918.....	876
KM47168.....	935	KM47473.....	1038	KM47676.....	1047	KM47919.....	877
KM47170.....	921	KM47474.....	1034	KM47678.....	1047	KM47920.....	858
KM47172.....	918	KM47476.....	1034	KM47680.....	1047	KM47921.....	1092
KM47173.....	918	KM47478.....	1034	KM47682.....	1047	KM47922.....	858
KM47190.....	921	KM47480.....	1037	KM47685.....	1051	KM47923.....	858
KM47192.....	921	KM47482.....	1037	KM47686.....	1051	KM47924.....	858
KM47194.....	920	KM47484.....	1037	KM47687.....	1051	KM47925.....	846
KM47196.....	920	KM47486.....	1035	KM47688.....	1051	KM47926.....	859
KM47198.....	921	KM47487.....	1035	KM47689.....	1047	KM47927.....	845
KM47200.....	920	KM47488.....	1035	KM47700.....	1059	KM47929.....	846
KM47202.....	935	KM47489.....	1035	KM47702.....	1059	KM47930.....	873
KM47204.....	922	KM47490.....	1035	KM47703.....	1059	KM47931.....	845
KM47206.....	922	KM47492.....	1035	KM47704.....	1059	KM47932.....	831
KM47208.....	922	KM47494.....	1036	KM47707.....	1057	KM47934.....	871
KM47212.....	925	KM47495.....	1036	KM47708.....	1057	KM47935.....	871
KM47240.....	1020	KM47496.....	1036	KM47709.....	1057	KM47936.....	871
KM47242.....	1020	KM47497.....	1036	KM47710.....	1057	KM47940.....	871
KM47244.....	1020	KM47498.....	1036	KM47712.....	1057	KM47950.....	868
KM47252.....	1019	KM47499.....	1036	KM47714.....	1057	KM47950B.....	868
KM47253.....	1019	KM47520.....	1030	KM47730.....	1057	KM47951.....	866
KM47254.....	1024	KM47522.....	1030	KM47732.....	1057	KM47952.....	866
KM47256.....	1024	KM47523.....	1031	KM47734.....	1057	KM47953.....	866
KM47258.....	1024	KM47524.....	1033	KM47760.....	1057	KM47954.....	867
KM47260.....	1024	KM47525.....	1032	KM47762.....	1057	KM47955.....	866
KM47262.....	1021	KM47526.....	1031	KM47764.....	1057	KM47956.....	866
KM47263.....	1021	KM47528.....	1031	KM47780.....	1057	KM47957.....	870
KM47264.....	1021	KM47531.....	1031	KM47782.....	1057	KM47958.....	870
KM47266.....	1025	KM47532.....	1031	KM47784.....	1057	KM47959.....	868, 870
KM47267.....	1023	KM47533.....	1031	KM47800.....	1058	KM47960.....	854
KM47268.....	1025	KM47534.....	1031	KM47802.....	1058	KM47961.....	866
KM47270.....	1015	KM47538.....	1018	KM47804.....	1058	KM47962.....	877
KM47272.....	1015	KM47540.....	1017	KM47840.....	1058	KM47963.....	877
KM47274.....	1019	KM47541.....	1017	KM47842.....	1058	KM47964.....	877
KM47275.....	1019	KM47542.....	1018	KM47844.....	1058	KM47965.....	862
KM47276.....	1026	KM47546.....	1015	KM47850.....	1055	KM47966.....	862
KM47278.....	1028	KM47550.....	1018	KM47853.....	1050	KM47967.....	862
KM47284.....	1028	KM47553.....	1028	KM47855.....	1051	KM47968.....	862
KM47285.....	1026	KM47555.....	1017	KM47856.....	1051	KM47969.....	864

KM47970	862	KM48072	856	KM48243	837	KM48382	848
KM47971	863	KM48073	856	KM48244	845	KM48384	848
KM47972	862	KM48076	856	KM48245	836	KM48386	849
KM47973	863	KM48077	856	KM48246	838	KM48388	849
KM47974	863	KM48079	856	KM48248	837	KM48390	851
KM47975	864	KM48080	856	KM48249	913	KM48390P	851
KM47976	862	KM48081	856	KM48250	836	KM48392	850
KM47977	861	KM48082	856	KM48252	865	KM48392P	850
KM47978	861	KM48085	856	KM48253	835	KM48394	852
KM47979	857	KM48086	856	KM48254	840	KM48395	871
KM47980	861	KM48091	857	KM48256	840	KM48396	867
KM47981	857	KM48092	857	KM48257	839	KM48415	850
KM47982	862	KM48093	857	KM48258	839	KM48420	850
KM47983	866	KM48094	857	KM48259	840	KM48421	850
KM47985	861	KM48095	857	KM48262	840	KM48422	850
KM47986	857	KM48100	855	KM48269	839	KM48423	850
KM47987	1053	KM48102	859	KM48270	848	KM48454	853
KM47988	1051	KM48104	859	KM48272	848	KM48455	853
KM47989	1051	KM48106	860	KM48274	848	KM48456	853
KM47990	1051	KM48108	860	KM48282	864	KM48457	853
KM47991	1051	KM48110	860	KM48284	864	KM48458	853
KM47992	1051	KM48112	860	KM48288	1093	KM48459	853
KM47993	1051	KM48114	860	KM48297	1093	KM48460	852
KM47994	1051	KM48116	859	KM48299	311, 1077	KM48461	852
KM47995	1051	KM48118	859	KM48301	1093	KM48462	852
KM47996	1051	KM48120	859	KM48302	312, 1079	KM48463	852
KM47997	1051	KM48122	859	KM48303	939	KM48465	851
KM47998	1051	KM48129	855	KM48310	312, 1079	KM48466	851
KM47999	1051	KM48130	855	KM48314	313, 1078	KM48467	851
KM48002	862	KM48132	855	KM48315	1078	KM48468	851
KM48003	861	KM48134	855	KM48320	817	KM48469	851
KM48004	861	KM48136	855	KM48322	817	KM48473	872
KM48010	1053	KM48137	855	KM48324	817	KM48474	872
KM48016	1051	KM48138	855	KM48326	848	KM48475	872
KM48017	1051	KM48140	855	KM48328	848	KM48476	872
KM48018	1051	KM48142	855	KM48330	848	KM48477	872
KM48019	1051	KM48143	855	KM48331	938	KM48478	872
KM48020	1051	KM48144	855	KM48332	939	KM48478P	872
KM48021	1051	KM48158	878	KM48333	938	KM48479	872
KM48022	1051	KM48161	878	KM48334	938	KM48480	872
KM48023	1051	KM48192	890	KM48335	938	KM48600	843
KM48024	1051	KM48194	890	KM48336	939	KM48602	843
KM48025	1051	KM48196	890	KM48337	940	KM48604	841
KM48026	1051	KM48198	890	KM48338	940	KM48605	842
KM48027	1051	KM48200	890	KM48339	940	KM48606	843
KM48028	1051	KM48201	886	KM48340	940	KM48608	843
KM48029	1051	KM48202	889	KM48341	940	KM48610	843
KM48030	1055	KM48204	889	KM48342	938	KM48614	844
KM48032	1055	KM48206	889	KM48343	938	KM48616	844
KM48033	1055	KM48208	885	KM48344	938	KM48620	844
KM48041	1052	KM48210	885	KM48348	868	KM48622	844
KM48050	856	KM48212	885	KM48349	866	KM48670	869
KM48051	856	KM48214	885	KM48350	869	KM49002	993
KM48052	856	KM48217	906	KM48352	869	KM49004	993
KM48054	856	KM48218	906	KM48353	867	KM49006	993
KM48057	856	KM48220	906	KM48354	869	KM49008	993
KM48058	856	KM48226	907	KM48355	869	KM49010	1000
KM48060	856	KM48228	907	KM48356	869	KM49012	1000
KM48061	856	KM48230	906	KM48358	869	KM49014	1000
KM48063	856	KM48234	880	KM48364	867	KM49016	1000
KM48067	856	KM48237	880	KM48365	866, 868	KM49018	1002
KM48068	856	KM48239	865	KM48370	808, 815	KM49020	1002
KM48069	856	KM48240	865	KM48372	816	KM49022	1002
KM48070	856	KM48241	865	KM48374	814	KM49024	1002
KM48071	856	KM48242	835	KM48380	848	KM49030	1004

KM52484	224, 904	KM54282	1121	KM55440	901	KM55680	984
KM52486	224, 904	KM54284	1121	KM55441	901	KM55681	984
KM52488	224, 904	KM54307	1118	KM55445	908	KM55682	984
KM52490	224, 904	KM54309	1118	KM55446	909	KM55684	984
KM52492	221	KM54311	1118	KM55447	912	KM55685	984
KM52494	221	KM54313	1118	KM55448	912	KM55686	984
KM52498	221	KM54330	1116	KM55449	912	KM55690	1060
KM52542	225, 904	KM54332	1116	KM55450	912	KM55691	1060
KM52544	225, 904	KM54334	1116	KM55451	910	KM55693	1060
KM52546	222, 899	KM54338	191	KM55452	910	KM55694	1060
KM52548	222, 899	KM54342	191	KM55453	910	KM55762	1061
KM52602	904	KM54346	191	KM55454	910	KM55763	1061
KM52702	912	KM54348	191	KM55455	909	KM55767	1061
KM52704	908	KM54366	195	KM55456	911	KM55777	1061
KM52704F	908	KM54368	195	KM55457	911	KM55782	1054
KM52704L	908	KM54372	195	KM55458	909	KM55788	1054
KM52704S	908	KM54668	1125	KM55459	909	KM55790	1054
KM52705L	908	KM55100	41	KM55460	909	KM55798	965
KM52705S	908	KM55164	497	KM55461	910	KM55813	1053
KM52706L	908	KM55170	944	KM55462	910	KM55815	1053
KM52706S	908	KM55188	497	KM55463	910	KM55823	1053
KM52707L	908	KM55300	949	KM55464	910	KM55825	1053
KM52707S	908	KM55302	949	KM55465	910	KM55842	1056
KM52708L	908	KM55330	951	KM55466	910	KM55856	1060
KM52708S	908	KM55331	951	KM55467	910	KM55858	1056
KM52709L	908	KM55332	951	KM55468	910	KM55860	1056
KM52709S	908	KM55333	949	KM55469	910	KM55870	1050
KM52711L	908	KM55334	949	KM55471	911	KM55871	1050
KM52711S	908	KM55335	951	KM55472	911	KM55872	1050
KM52765	227, 902	KM55336	951	KM55473	910	KM55891	1046
KM52768	227	KM55337	951	KM55474	911	KM55892	1046
KM52769	227	KM55338	950	KM55475	911	KM55895	1046
KM52771	228, 903	KM55339	950	KM55476	911	KM55898	1046
KM52776	227	KM55340	950	KM55481	902	KM55901	1046
KM52778	227	KM55341	950	KM55482	902	KM55904	1046
KM52782	228	KM55342	950	KM55483	902	KM55905	1046
KM53042	312, 1078	KM55343	950	KM55484	902	KM55906	1046
KM53174	143	KM55344	949	KM55485	902	KM55908	1046
KM53176	143	KM55345	949	KM55486	902	KM55909	1046
KM53265	137, 1114	KM55346	949	KM55487	902	KM55910	1046
KM53267	137, 1114	KM55347	949	KM55488	902	KM55911	1046
KM53316	136, 1113	KM55348	949	KM55490	905	KM55912	1046
KM53318	136, 1113	KM55370	1006	KM55495	905	KM55913	1046
KM53404	1097	KM55371	1006	KM55496	905	KM55914	1046
KM53408	1097	KM55372	1006	KM55497	898	KM55915	1046
KM53420	1097	KM55373	1006	KM55498	900	KM55916	1046
KM53422	1097	KM55374	1006	KM55510	986	KM55917	1046
KM53426	1096	KM55375	1006	KM55523	985	KM55918	1046
KM53428	1096	KM55376	1006	KM55532	985	KM55919	1046
KM53440	1098	KM55377	1006	KM55533	985	KM55925	1046
KM53460	1099	KM55378	1006	KM55543	985	KM55926	1046
KM53480	1105	KM55400	1012	KM55556	985	KM55927	1046
KM53484	1105	KM55401	1012	KM55566	986	KM55928	1046
KM53560	1103	KM55410	905	KM55573	986	KM55929	1046
KM53564	1104	KM55412	905	KM55586	986	KM55935	1058
KM53568	1103	KM55420	882	KM55593	986	KM55936	1058
KM53574	1104	KM55421	882	KM55610	963	KM55937	1058
KM53580	1103	KM55422	882	KM55612	963	KM55938	1058
KM53686	1104	KM55424	880	KM55614	963	KM55940	1059
KM53688	1104	KM55426	881	KM55620	963	KM55941	1059
KM53690	1104	KM55428	881	KM55630	1004	KM55942	1059
KM54080	1119	KM55430	901	KM55640	964	KM55946	1059
KM54108	1119	KM55431	901	KM55642	994	KM55947	1059
KM54272	1121	KM55432	901	KM55644	964	KM55948	1059
KM54280	1121	KM55438	898	KM55676	1006	KM55949	1059

KM55952	1059	KM59322	1045	KM69440	1065	KM69930	1068
KM55953	1059			KM69441	1065	KM69932	1068
KM55954	1059			KM69445	1064	KM69940	989
KM55960	1058			KM69446	1064	KM69946	989
KM55961	1058			KM69448	1067	KM69950	989
KM55962	1058			KM69457	1088	KM69970	989
KM55963	1058			KM69459	1089	KM69975	989
KM55964	1058			KM69461	1089	KM69980	1005
KM55966	1058			KM69463	1089	KM69982	881
KM55967	1058			KM69465	1089	KM69990	897
KM55972	1058			KM69468	1089		
KM55973	1058			KM69478	1089		
KM55974	1058			KM69480	1089		
KM55980	1055			KM69484	1089		
KM55981	1055			KM69488	1089		
KM56104	504			KM69492	1089		
KM56168	503			KM69495	1088		
KM56170	503			KM69498	1088		
KM56172	503			KM69502	1088		
KM56174	503			KM69524	1119		
KM57176	500			KM69530	968		
KM57614	506, 953			KM69534	968		
KM57615	506, 953			KM69538	968		
KM57616	506, 953			KM69540	973		
KM57618	965			KM69541	973		
KM57620	955			KM69542	966		
KM57622	955			KM69543	966		
KM57624	952			KM69544	966		
KM57626	952			KM69545	967		
KM57628	952			KM69546	967		
KM57630	952			KM69547	970		
KM58050	970			KM69549	967		
KM58052	970			KM69557	1066		
KM58062	973			KM69579	1090		
KM58070	968			KM69590	1090		
KM58072	972			KM69595	1069		
KM58073	972			KM69618	1090		
KM58075	959			KM69620	1090		
KM58076	959			KM69622	1090		
KM58077	878			KM69623	1090		
KM58083	878			KM69625	1090		
KM58085	959			KM69640	1091		
KM58096	1072			KM69645	1091		
KM58097	1072			KM69650	1091		
KM58098	1072			KM69758	954		
KM58100	992			KM69760	954		
KM58102	992			KM69762	954		
KM58104	992			KM69764	954		
KM58106	974			KM69766	954		
KM58108	974			KM69787	916		
KM58110	974			KM69790	1087		
KM58112	974			KM69792	1069		
KM58240	897			KM69793	1069		
KM58242	897			KM69795	936		
KM59200	1045, 1080			KM69805	1070		
KM59300	1045			KM69820	106		
KM59303	1045			KM69824	106		
KM59306	1045			KM69827	937		
KM59309	1045			KM69830	865		
KM59312	1045			KM69832	865		
KM59313	1045			KM69834	865		
KM59315	1045			KM69836	865		
KM59316	1045			KM69838	865		
KM59321	1045			KM69840	865		
				KM69846	820		

KM6

KM7

OS100291	1062
OS100292	1062
OS100293	1062
OS100294	1062
OS100295	1063
OS100296	1063
OS100297	1063
OS200102	1062
OS200182	1062

P

P356PRA	467
P358PRA	467
P15128	1136
P29862	1136
P29863	1136
P29864	1136
P30186	1136
P35235	1136
P35236	1136
P35776	1146
P37304	335
P37305	336
P37306	337
P37308	332
P37309	332
P37310	331
P37311	331
P37312	331
P37313	331
P37314	331
P37315	335
P37316	333
P37317	333
P37318	331
P37319	331
P37320	334
P37321	334
P37322	334
P37323	334
P37324	334
P37325	334
P37326	334
P37327	332
P37328	332
P37329	333
P37330	333
P37331	335
P37332	335
P37333	335
P37334	335
P37335	334
P37336	335
P37337	335
P37338	335
P37339	337
P37341	337
P37342	337
P37343	337
P37344	337
P37345	337
P37346	337
P37347	337
P37348	337
P37349	337
P37350	337
P37351	338
P37352	338
P37353	338
P37354	338
P37355	338
P37356	338
P37357	338
P37358	337
P37361	339
P37372	338
P37373	338
P37374	338
P37375	338
P37376	338
P37377	338
P37378	338
P37379	338
P37380	338
P37381	338
P37382	338
P37383	338
P37384	338
P37385	338
P37387	338
P37388	338
P37389	338
P37390	338
P37391	339
P37392	339
P37393	339
P37394	339
P37395	339
P37396	339
P37397	339
P37398	339
P37399	339
P37400	339
P37401	339
P37402	339
P37403	339
P37404	339
P37419	335
P37420	337
P37421	337
P37422	337
P37423	337
P37424	337
P37425	337
P37426	337
P37427	338
P37428	338
P37429	338
P37430	338
P37431	338
P37432	338
P37433	338
P37435	339
P37436	339
P37437	339
P37447	339
P37448	339
P37449	339
P37450	339
P37451	339
P37452	339
P37453	339
P37454	339
P37455	339
P37456	339
P37457	339
P37458	339
P37485	338
P37486	338
P37487	338
P37544	337
P37545	336
P37564	337
P37593	336
P37872	333
P47482	316
PI-104	1159
PI-128	1160

S

S358PRA	467
---------------	-----

W

W356PXA	467
W358LWP	466
W358PRA	467
W358PXA	467
W358XLGP	466
W3510LWP	466
W3510XLGP	466