

INTEGRA™
LIMIT UNCERTAINTY



Integra™ Jarit®
Surgical Instruments

Introduction

Table of Contents

Guarantee/Warranty..... III

Trademarks III

Returned Goods Policy..... III

General Operating Instruments 1

Orthopedic Instruments and General Surgical Instruments..... 197

Microsurgery Instruments and General Surgical Instruments..... 263

Neurosurgical and Spinal Instruments and General Surgical Instruments 287

Thoracic and Cardiovascular Instruments and General Surgical Instruments 345

Cardiovascular Clamps I, Abdominal and Thoracic Instruments..... 433

Cardiovascular Clamps II, Pediatric and Peripheral Vascular Instruments 455

Titanium Instruments 487

Ophthalmic Instruments and General Surgical Instruments 507

Ear and Nose Instruments and General Surgical Instruments 563

Plastic and Reconstructive Instruments and General Surgical Instruments..... 627

Post Nasal and Sinus Endoscopy Instruments and General Surgical Instruments..... 697

Post Nasal Instruments 698

Sinus Endoscopy Instrumentation 703

Throat and Laryngeal Instruments and General Surgical Instruments..... 713

Dental and Oral Instruments..... 731

Rectal and Genito-Urinary Instruments and General Surgical Instruments 745

Obstetrical and Gynecological Instruments and General Surgical Instruments 761

Bariatric Instruments and General Surgical Instruments 793

Containers, Trays and Accessories..... 801

Needle Holder Suture Guide 823

Conversion Tables..... 830

Numerical Index..... 835

Alphabetical Index..... 869

Surgical Instrument Product Lines 901



Guarantee/Warranty

Integra™ Jarit® Instruments are guaranteed against defects in material and workmanship. Integra will, at its option and without charge, either repair or replace any instrument which Integra determines to be defective in material or workmanship when used for its intended surgical purpose.

All Jarit instruments sold by Integra are warranted only to the original purchaser and only against defects in workmanship or materials which under the intended use render such instruments inoperable.

All Jarit® Carb-Bite™ and Jarit Carb-Edge™ instruments are further warranted for a period of three (3) years under normal use. Should any adjustment become necessary during this warranty period, Carb-Edge Scissors will be sharpened, and Carb-Bite Needle Holder jaw inserts will be replaced, without charge.

All Jarit Supercut™ Scissors are further warranted for a period of one year under normal use. Should any sharpening become necessary during this warranty period, Jarit will provide this service without charge. A nominal charge will be made for sharpening after expiration of this warranty.

This Guarantee/Warranty shall be void in the event any JARIT® instrument is used for purposes other than as originally intended, is not maintained or cleaned properly, is damaged as a result of misuse or accident, or is repaired or altered by unauthorized persons.

The above is a limited warranty, and it is the only warranty made by Integra for Jarit® Instruments. Integra makes no other warranty, express or implied, including any warranty of merchantability and fitness for a particular purpose, as well as any express or implied warranty to patients. Integra shall have no liability for consequential, exemplary or incidental damages even if it is aware of the possibility of such damages. No warranty or guarantee may be created by any act or statement nor may this warranty be modified in any way, except as a result of a writing signed by an officer of Integra. These limitations on the creation or modification of this warranty may not be waived or modified orally or by any conduct. The stated express warranty is in lieu of all liabilities or obligations of Integra arising out of, or in connection with, the delivery, use or performance of any Integra instrument. Integra neither assumes nor authorizes any representative or other person to assume for it any other liability in connection with Jarit Instruments.

Ordering Procedure

A written purchase order on customer's form may be requested for purchase of Integra products.

Acceptance of Order

Orders are accepted upon approval by Integra.

Returned Goods Policy

Products must be returned in unopened packages with manufacturer's seals intact to be accepted for replacement or credit unless returned due to a complaint of product defect. Determination of a product defect will be made by Integra. Products will not be accepted for replacement if they have been in the possession of the customer for more than 90 days.

Repairs and Maintenance

Should your instruments require repair or maintenance, contact Integra for return authorization and address. Instruments returned to Integra for repair must have a statement testifying that each instrument has been thoroughly cleaned and sterilized. Failure to supply evidence of cleaning and disinfection will result in a cleaning charge and delayed processing of your instrument repair.

Product Information Disclosure

Integra and its subsidiaries ("Integra") and manufacturer exclude all warranties, except Integra's applicable standard warranty whether expressed or implied, including but not limited to, any implied warranties of merchantability or fitness for a particular purpose. Neither Integra nor manufacturer shall be liable for any incidental or consequential loss, damage, or expense, directly or indirectly arising from use of these products. Neither Integra nor manufacturer assume nor authorize any person to assume for them any other or additional liability or responsibility in connection with these products.

Registered Trademarks

The following are registered trademarks of Integra LifeSciences Corporation or its subsidiaries:

Jarit®	Jarit Stardust®
Jarit Detach®	Petit-Point®

The following are trademarks of Integra LifeSciences Corporation or its subsidiaries:

Carb-Bite™	Jarit Supercut™
Carb-Edge™	P.e.e.r.™
Cardio-Grip™	Roto-Cam™
Jarit Articulator™	Roto-Lok™
Jarit Rotator™	Tip-It™

Care and Handling/IFU

For Care and Handling information and Instructions for Use, please visit www.integralife.com/jarit



Integra York PA, Inc.
589 Davies Dr.
York, PA 17402 USA
integralife.com/jarit



Miltex GmbH
Muehlstrasse 6
78604 Rietheim-Weilheim, Germany

©2011 Integra LifeSciences Corporation.
All Rights Reserved.

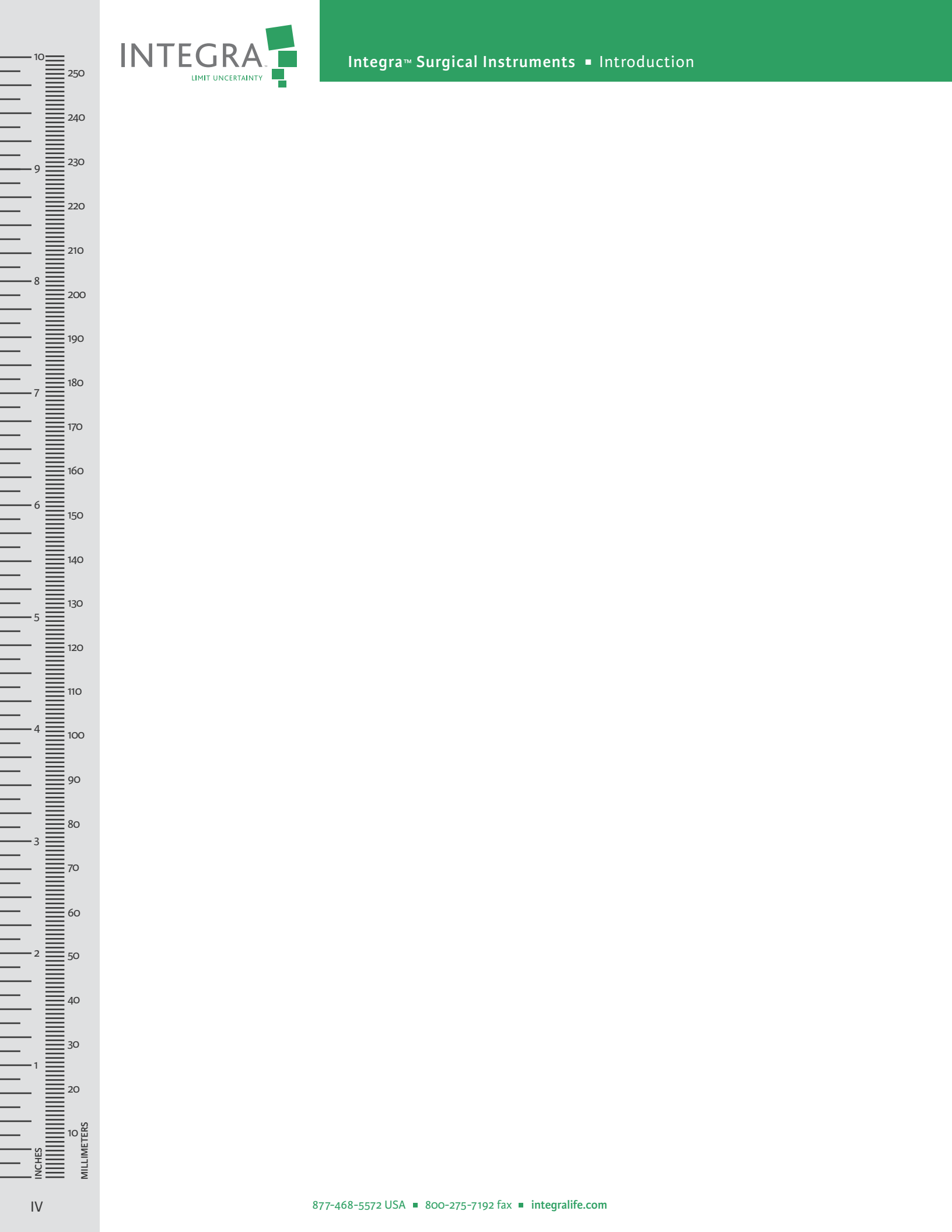



Integra™ General Operating Instruments

Operating Scissors

straight, sharp-sharp, (Mirror Finish)

Manufactured from high grade German surgical stainless steel which is ground and polished to a mirror finish

Catalog#	Description
100-105	4 ³ / ₄ " (120mm)
100-109	5 ¹ / ₄ " (132mm)
100-110	5 ⁷ / ₈ " (149mm)
100-111	6 ¹ / ₂ " (165mm)

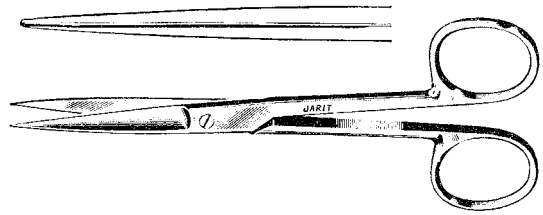

Operating Scissors

straight, sharp-sharp, (Matte Finish)

Manufactured from high grade German surgical stainless steel which is glass beaded to a matte finish

Catalog#	Description
099-110	5 ⁷ / ₈ " (149mm)

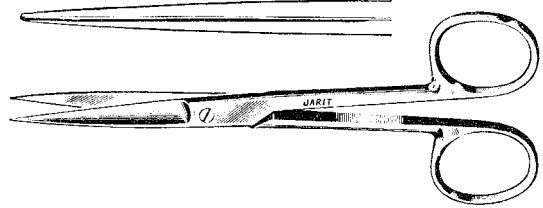

Operating Scissors

curved, sharp-sharp, (Mirror Finish)

Catalog#	Description
100-115	4 ³ / ₄ " (120mm)
100-117	5 ¹ / ₄ " (132mm)
100-120	5 ⁷ / ₈ " (149mm)
100-122	6 ¹ / ₂ " (165mm)

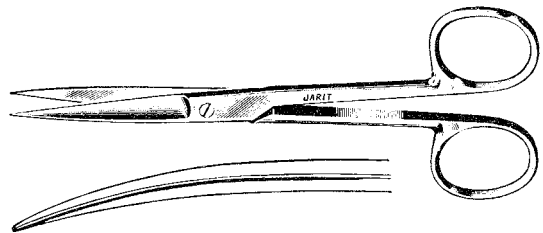

Operating Scissors

straight, sharp-blunt, (Mirror Finish)
Manufactured from high grade German surgical stainless steel which is ground and polished to a mirror finish

Catalog#	Description
100-125	4¾" (120mm)
100-127	5¼" (132mm)
100-130	5⅞" (149mm)
100-132	6½" (165mm)

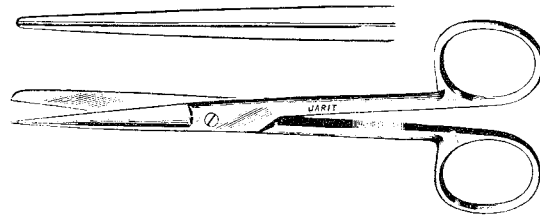

Operating Scissors

straight, sharp-blunt, (Matte Finish)
Manufactured from high grade German surgical stainless steel which is glass beaded to a matte finish

Catalog#	Description
099-130	5⅞" (143mm)

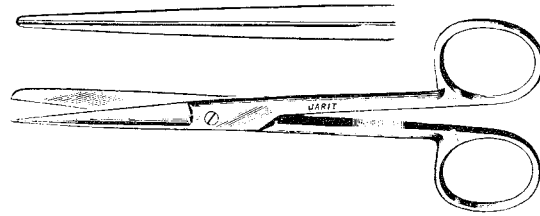

Operating Scissors

curved, sharp-blunt, (Mirror Finish)

Catalog#	Description
100-116	4¾" (120mm)
100-134	5¼" (132mm)
100-135	5⅞" (144mm)
100-137	6½" (165mm)

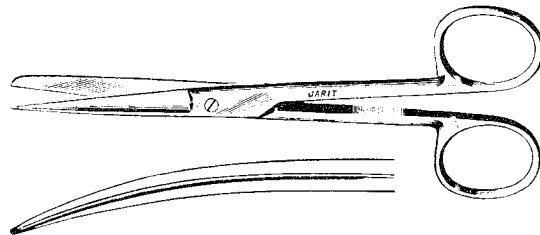

Operating Scissors

straight, blunt-blunt, (Mirror Finish)

Catalog#	Description
100-126	4¾" (120mm)
100-129	5¼" (132mm)
100-131	5⅞" (149mm)
100-138	6½" (165mm)

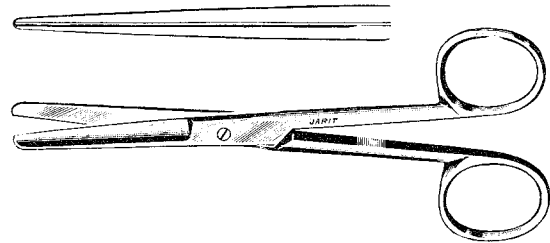

Operating Scissors

curved, blunt-blunt, (Mirror Finish)

Catalog#	Description
100-128	4¾" (120mm)
100-133	5¼" (132mm)
100-136	5⅞" (142mm)
100-139	6½" (165mm)

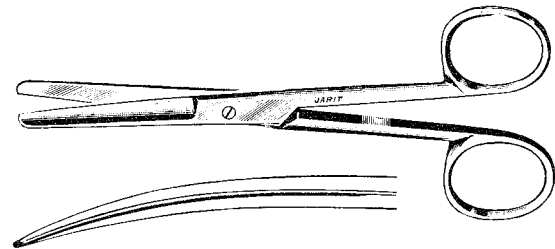

Operating Scissors

straight, sharp-blunt, (Mirror Finish)
one blade serrated

Catalog#	Description
100-140	5⅞" (149mm)

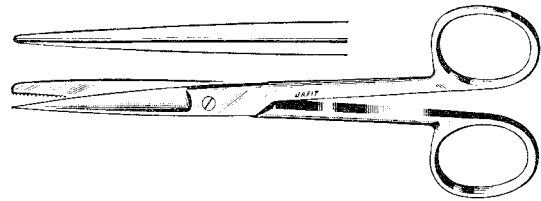

Deaver Scissors

sharp-sharp

Catalog#	Description
100-175	5⅞" (143mm), straight
100-180	5⅞" (143mm), curved

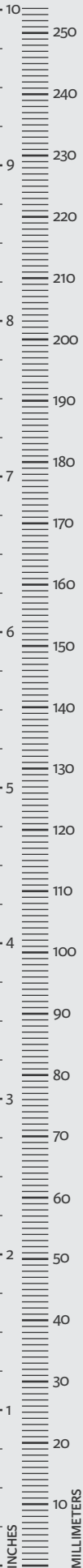
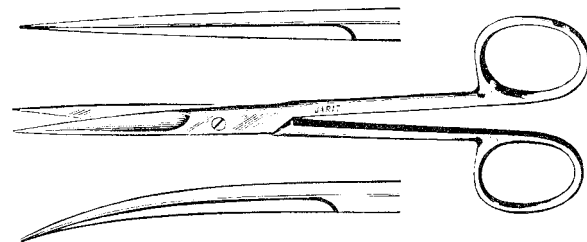

Deaver Scissors

sharp-blunt

Catalog #	Description
100-185	5 7/8" (143mm), straight
100-190	5 7/8" (143mm), curved

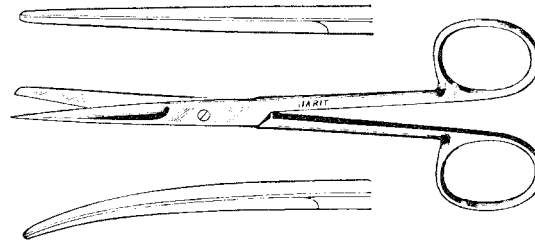

Sistrunk Scissors

Catalog #	Description
100-195	5 1/4" (133mm), slightly curved

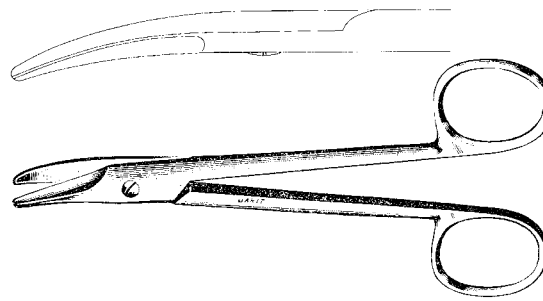

Mayo Scissors

beveled blades, (Mirror Finish)

Manufactured from high grade German surgical stainless steel which is ground and polished to a mirror finish

Catalog#	Description
100-200	5 3/4" (146mm), straight
100-202	5 3/4" (146mm), curved
100-210	6 3/4" (174mm), straight
100-212	6 3/4" (174mm), curved

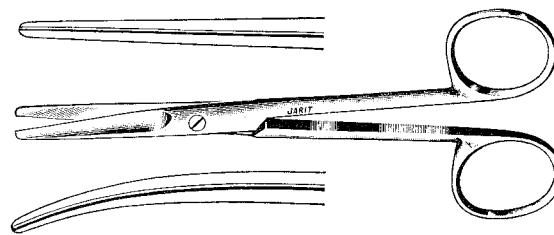

Mayo Scissors

beveled blades, (Matte Finish)

Manufactured from high grade German surgical stainless steel which is glass beaded to a matte finish

Catalog#	Description
099-200	5 3/4" (146mm), straight
099-202	5 3/4" (146mm), curved
099-210	6 3/4" (174mm), straight
099-212	6 3/4" (174mm), curved

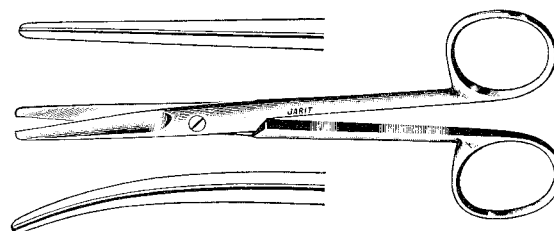

Mayo Scissors

round blades, (Mirror Finish)

Catalog #	Description
100-215	5 ⁷ / ₈ " (149mm), straight
100-217	5 ⁷ / ₈ " (149mm), curved
100-220	6 ³ / ₄ " (169mm), straight
100-222	6 ³ / ₄ " (169mm), curved

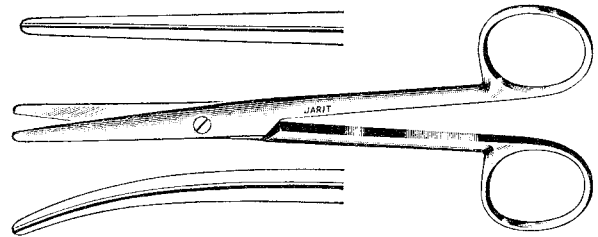

Mayo-Noble Dissecting Scissors

beveled blades

Catalog #	Description
100-224	6 ¹ / ₂ " (164mm), straight
100-225	6 ¹ / ₂ " (164mm), curved

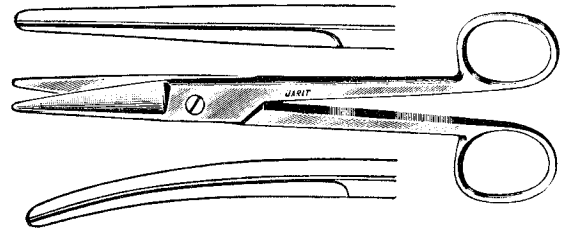

Mayo-Noble Dissecting Scissors

round blades

Catalog #	Description
100-226	6 ¹ / ₂ " (162mm), straight
100-227	6 ¹ / ₂ " (162mm), curved

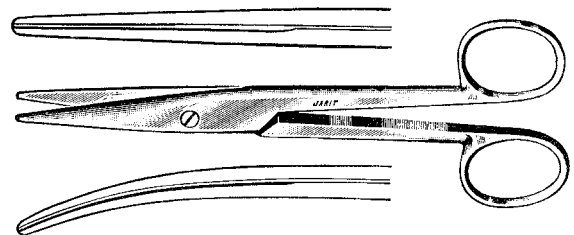

Doyen Abdominal Scissors

Catalog #	Description
100-230	7 ¹ / ₄ " (184mm), straight
100-231	7 ¹ / ₄ " (184mm), curved

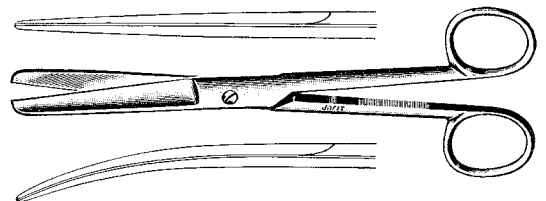

Ferguson Abdominal Scissors

Catalog #	Description
100-233	7¼" (184mm), angled on flat

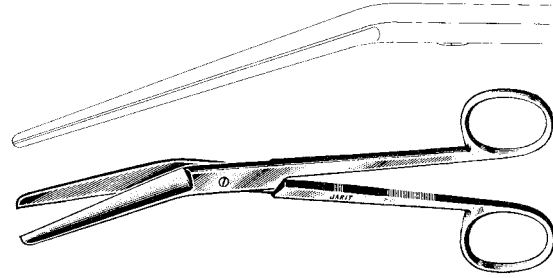

Lillehei-Potts Scissors

Catalog #	Description
100-240	7" (180mm), straight blades, blunt tips
100-241	7" (180mm), curved blades, blunt tips
100-242	7" (180mm), straight blades, sharp tips
100-243	7" (180mm), curved blades, sharp tips
100-244	7" (180mm), straight blades, tenotomy tips
100-245	7" (180mm), curved blades, tenotomy tips

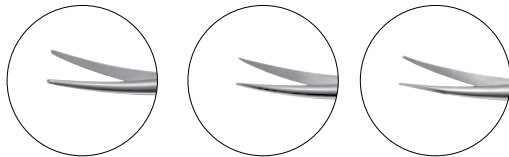

Metzenbaum-Lahey Scissors, (Mirror Finish)

Manufactured from high grade German surgical stainless steel which is ground and polished to a mirror finish

Catalog #	Description
100-250	5⅞" (149mm), straight
100-251	5⅞" (149mm), curved

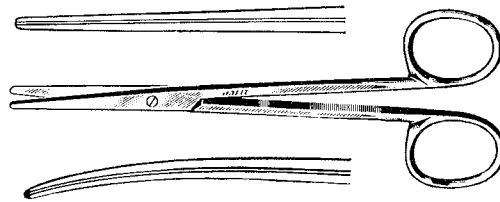

Metzenbaum-Lahey Scissors, (Matte Finish)

Manufactured from high grade German surgical stainless steel which is glass beaded to a matte finish

Catalog #	Description
099-250	5⅞" (149mm), straight
099-251	5⅞" (149mm), curved

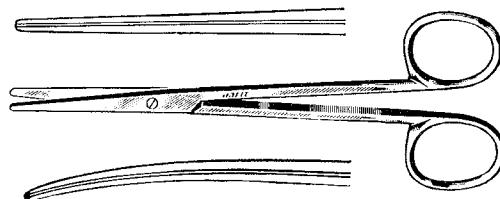

Metzenbaum Scissors

straight, (Mirror Finish)

Catalog #	Description
100-260	7" (180mm)
100-265	8" (206mm)

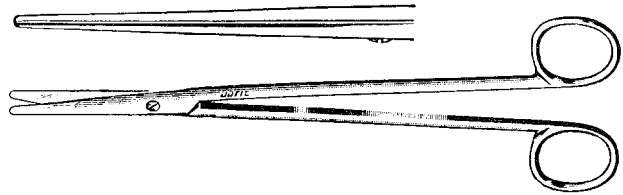

Metzenbaum Scissors

curved, (Mirror Finish)

Manufactured from high grade German surgical stainless steel which is ground and polished to a mirror finish

Catalog #	Description
100-261	7" (178mm), slender, delicate
100-262	7" (178mm)
100-266	8" (206mm)

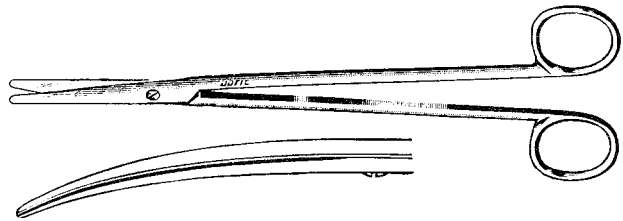

Metzenbaum Scissors

curved, (Matte Finish)

Manufactured from high grade German surgical stainless steel which is glass beaded to a matte finish

Catalog #	Description
099-262	7" (176mm)

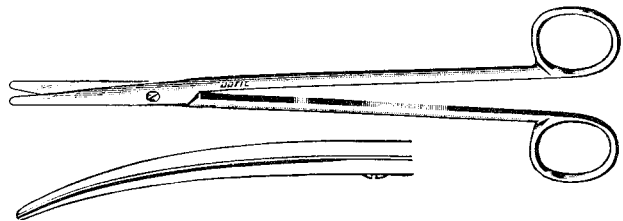

Metzenbaum-Baby Scissors

delicate, dissecting tips, (Mirror Finish)

Catalog #	Description
100-269	5 1/4" (135mm), straight
100-270	5 1/4" (135mm), curved

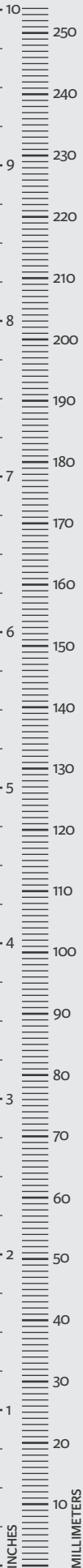
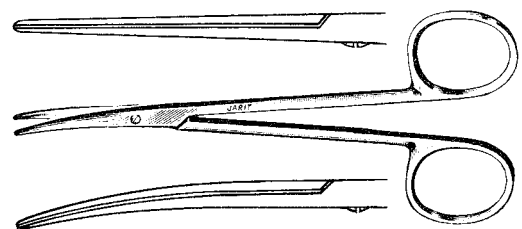

Metzenbaum-Lahey Scissors

curved, delicate, (Mirror Finish)

Catalog #	Description
100-272	5 ⁵ / ₈ " (143mm)

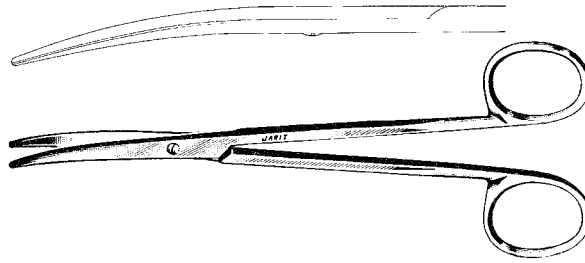

Joseph Scissors

Catalog #	Description
100-278	5 ⁵ / ₈ " (143mm), straight
100-279	5 ⁵ / ₈ " (143mm), curved

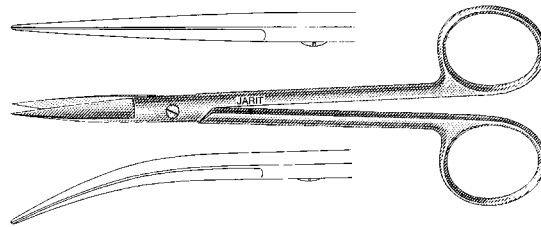

Kelly Fistula Scissors

Catalog #	Description
100-280	6 ¹ / ₄ " (158mm), straight
100-281	6 ¹ / ₄ " (158mm), curved

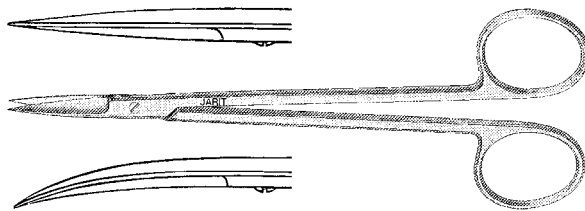

Flat Tip Scissors

curved

Catalog #	Description
100-290	5 ³ / ₈ " (137mm)
100-291	7" (178mm)
100-292	9 ¹ / ₄ " (232mm)

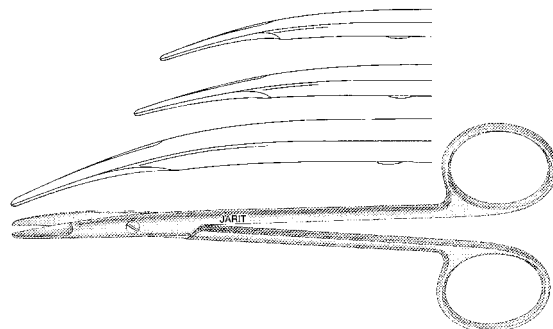

Reynolds Scissors

narrow tip, curved

Catalog #	Description
100-295	5 ⁵ / ₈ " (143mm), plain edge
100-296	5 ⁵ / ₈ " (143mm), serrated edge
100-297	7" (178mm), plain edge
100-298	7" (178mm), serrated edge

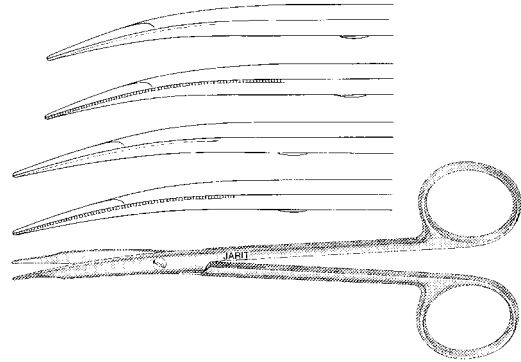

Jamison-Metzenbaum Scissors

narrow tip, curved

Catalog #	Description
100-300	6" (155mm)
100-302	7" (180mm)
100-304	8" (205mm)
100-306	9" (230mm)

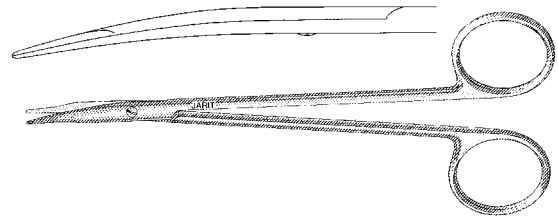

Plastic Surgery Scissors

sharp-blunt

Catalog #	Description
100-320	4 ⁷ / ₈ " (124mm), straight
100-322	4 ⁷ / ₈ " (124mm), curved

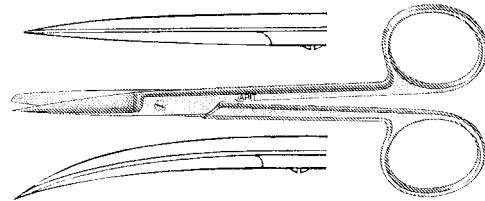

Plastic Surgery Scissors

sharp-sharp

Catalog #	Description
100-325	4 ⁷ / ₈ " (124mm), straight
100-327	4 ⁷ / ₈ " (124mm), curved

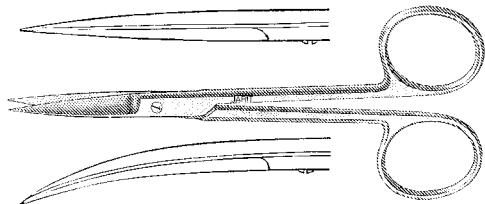

Plastic Surgery Scissors

blunt-blunt

Catalog #	Description
100-330	4 ⁷ / ₈ " (124mm), straight
100-332	4 ⁷ / ₈ " (124mm), curved

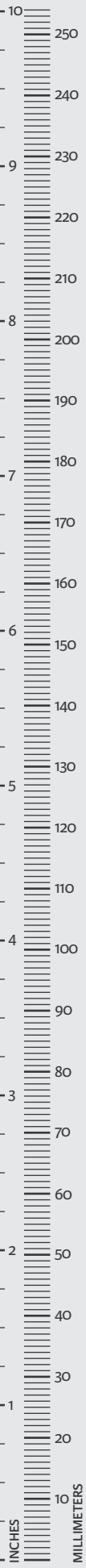
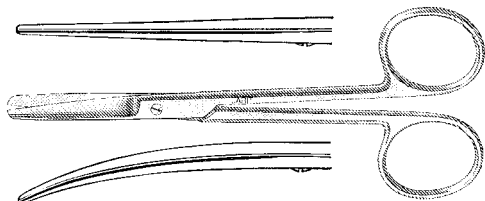

Lister Bandage Scissors, (Mirror Finish)

Manufactured from high grade German surgical stainless steel which is ground and polished to a mirror finish

Catalog #	Description
100-502	3 ³ / ₈ " (86mm)
100-512	4 ³ / ₄ " (120mm)
100-522	5 ³ / ₄ " (145mm)
100-526	7 ¹ / ₄ " (184mm)
100-528	8" (206mm)

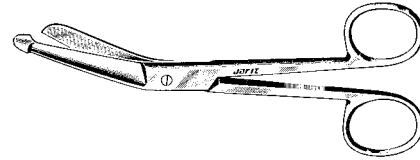

Lister Bandage Scissors, (Matte Finish)

Manufactured from high grade German surgical stainless steel which is glass beaded to a matte finish

Catalog #	Description
099-522	5 ³ / ₄ " (145mm)
099-526	7 ¹ / ₄ " (184mm)
099-528	8" (206mm)

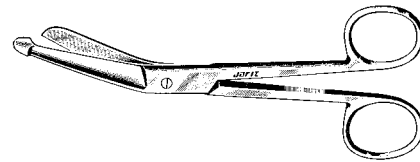

Lister Bandage Scissors

one large ring, (Mirror Finish)

Catalog #	Description
100-527	8" (203mm)



Knowles Finger Bandage Scissors

Catalog #	Description
100-530	5 ³ / ₄ " (145mm)

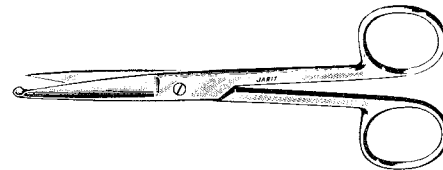

Knowles Finger Bandage Scissors

Catalog #	Description
100-531	5 ¹ / ₂ " (140mm), side curved
100-532	5 ¹ / ₂ " (140mm), one blade serrated

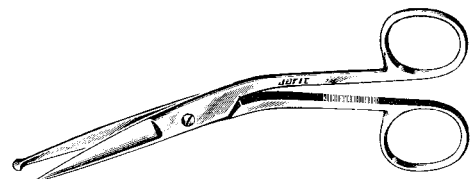

Universal Bandage Scissors

one serrated blade, stainless steel with autoclavable plastic finger rings

Catalog #	Description
100-539	5¾" (145mm), black

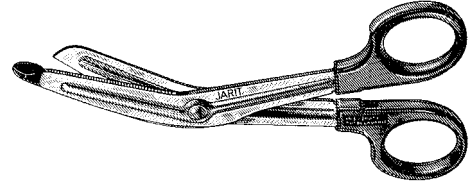

Universal Bandage Scissors

one serrated blade, stainless steel with autoclavable plastic finger rings

Catalog #	Description
100-540	7½" (190mm), black
100-541	7½" (190mm), red
100-542	7½" (190mm), orange
100-543	7½" (190mm), blue
100-544	7½" (190mm), purple
100-545	7½" (190mm), green
100-546	7½" (190mm), yellow



New's Suture Scissors

Catalog #	Description
125-165	5⅝" (142mm), angled on flat

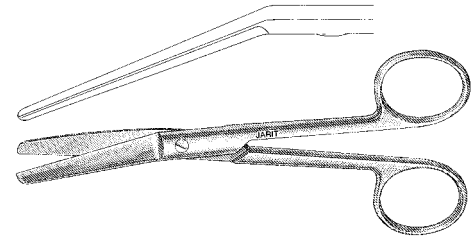

Universal Wire Suture Scissors

Catalog #	Description
125-170	4¾" (122mm), angled, one serrated blade

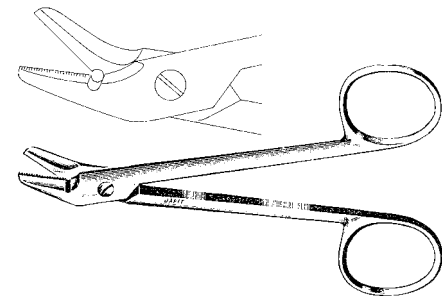

Universal Wire Suture Scissors, Carb-Edge
for cutting suture and wire (26 gauge and smaller)

Catalog #	Description
101-350	4⅞" (124mm), angled, for cutting suture and wire (26 gauge and smaller)

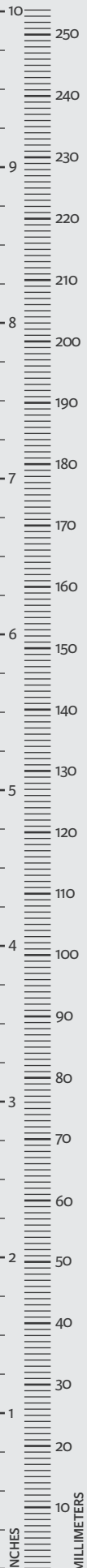
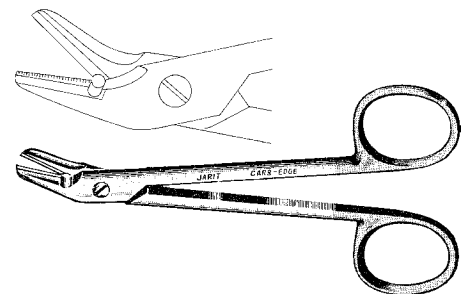

Heath Suture Scissors

Catalog #	Description
125-175	6" (155mm), serrated

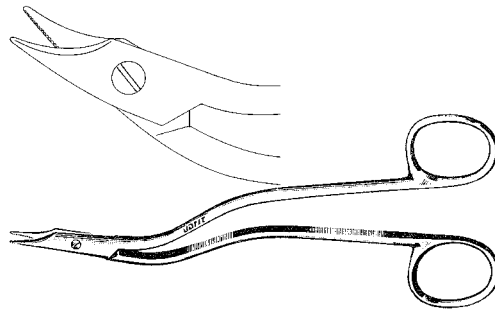

Spencer Suture Scissors

Catalog #	Description
125-180	3½" (90mm)
125-182	5" (127mm)

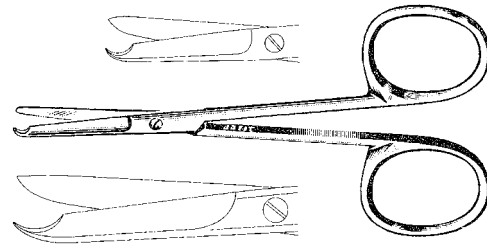

Spencer Suture Scissors curved sideways

Catalog #	Description
125-184	3½" (90mm)
125-185	4¾" (121mm)

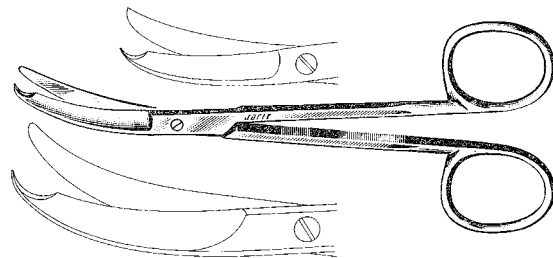

Littauer Stitch Scissors

Catalog #	Description
125-190	5½" (140mm)

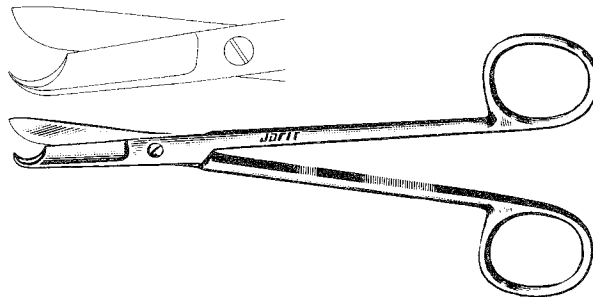

Suture Wire Scissors

serrated

Catalog #	Description
125-192	4 1/8" (104mm), straight
125-193	4 1/8" (104mm), curved

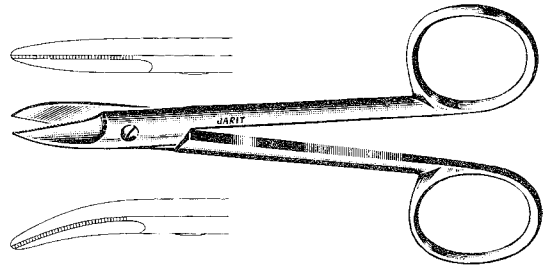

Smith Wire Scissors

Catalog #	Description
125-194	6 3/4" (171mm)

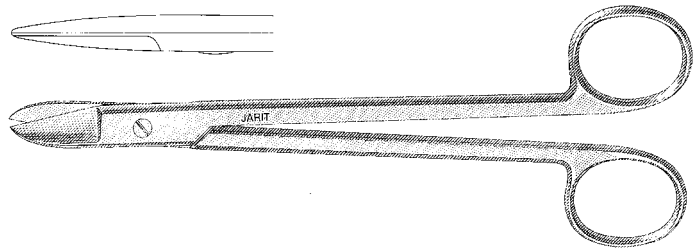

O'Brien Suture Scissors

Catalog #	Description
125-195	3 7/8" (100mm), angled

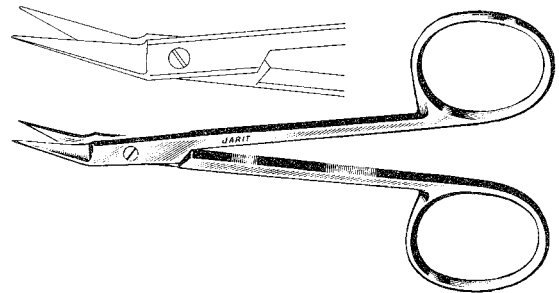

Thorek Gall Bladder Scissors

Catalog #	Description
140-320	7 1/4" (185mm), full curve
140-322	9" (230mm), full curve

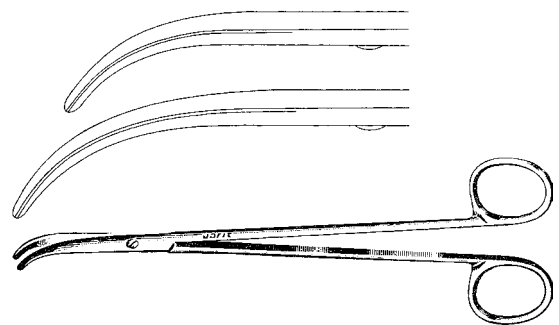

Martin Cartilage Scissors

Catalog #	Description
270-150	7 3/4" (200mm), curved, 50mm serrated blade

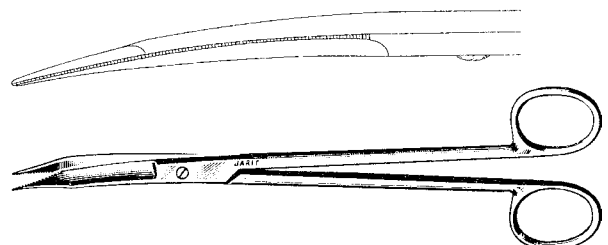

Frazier (Schmeden) Dura Scissors

Catalog #	Description
295-200	6½" (165mm)

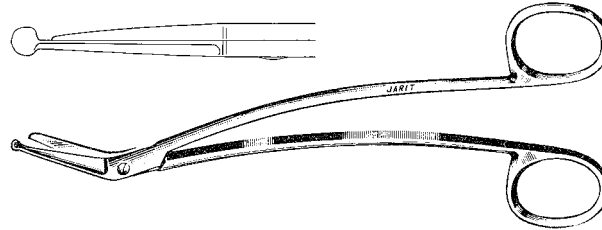

Taylor Dura Scissors

delicate

Catalog #	Description
295-205	5½" (140mm)

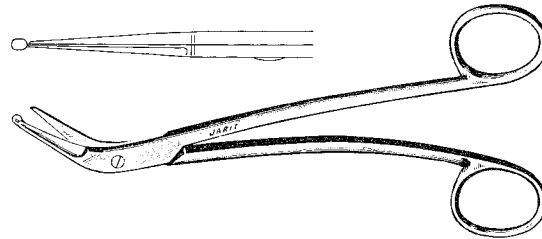

Dandy Trigeminal Scissors

Catalog #	Description
295-210	6¾" (172mm)
295-211	7¾" (197mm)

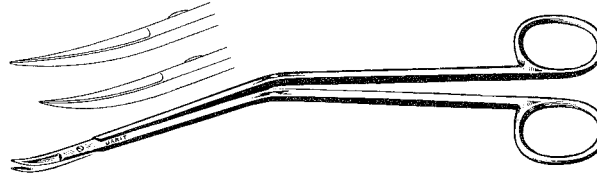

Strully Scissors

Catalog #	Description
295-215	7¾" (200mm)

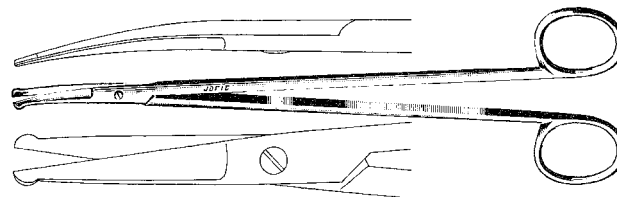

Adson Ganglion Scissors

6¼" (158mm)

Catalog #	Description
295-220	Straight
295-221	Curved

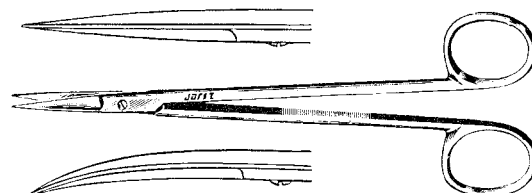

Metzenbaum-Nelson Scissors

Catalog #	Description
305-100	9¼" (235mm), straight
305-101	9¼" (235mm), curved
305-105	11¼" (286mm), straight
305-106	11¼" (286mm), curved
305-110	14½" (367mm), curved

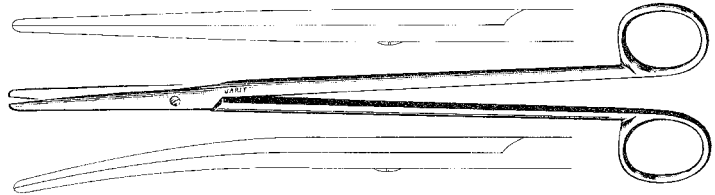

Jorgenson Scissors

Catalog #	Description
305-120	8¾" (222mm), curved

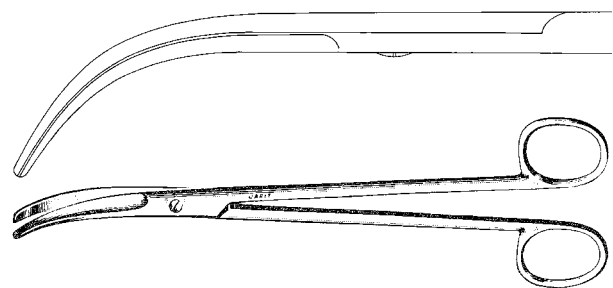

Cooley Scissors

Catalog #	Description
305-125	7½" (191mm), curved

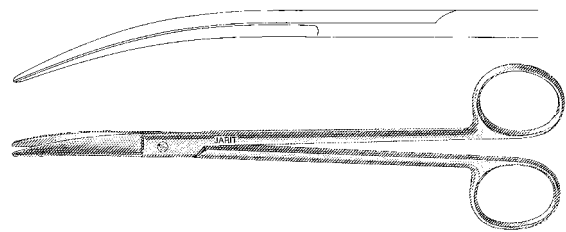

Willauer Scissors

Catalog #	Description
305-130	10¼" (260mm), straight
305-131	10¼" (260mm), curved
305-135	12" (305mm), straight
305-136	12" (303mm), curved



Mayo-Harrington Scissors

Catalog #	Description
305-140	9" (230mm), straight
305-141	9" (230mm), curved
305-145	11" (280mm), straight
305-146	11" (280mm), curved

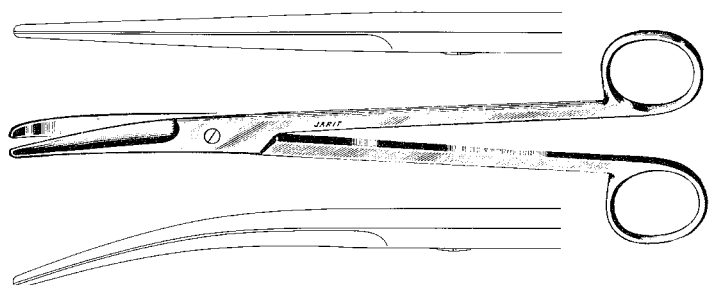

Potts-Smith Dissecting Scissors, Curved

Catalog #	Description
310-290	5¾" (145mm)
310-291	7¼" (184mm)
310-292	9¼" (232mm)

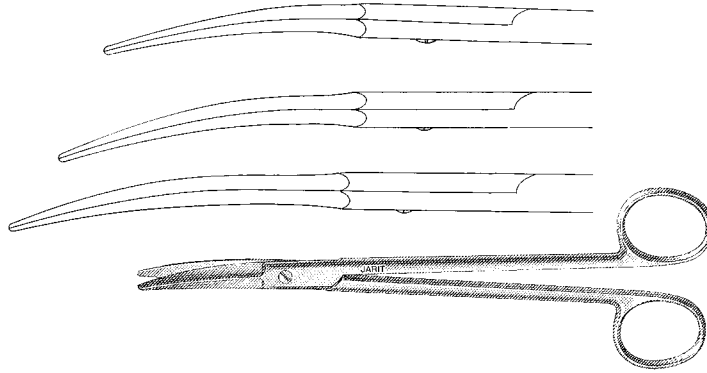

Satinsky Vascular Scissors

Catalog #	Description
310-300	9½" (243mm), curved shanks, acutely curved tips

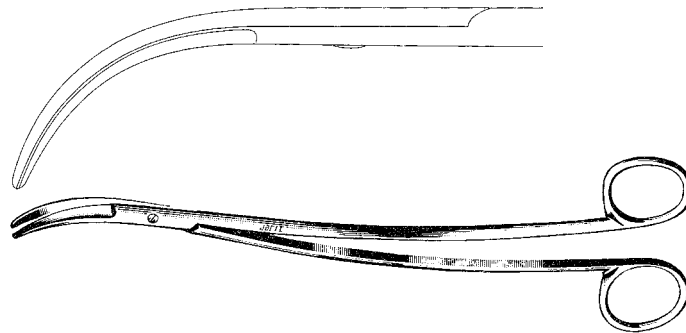

DeMartel Vascular Scissors, Curved

Catalog #	Description
310-302	6¾" (174mm), blunt tips
310-303	6¾" (174mm), sharp tips

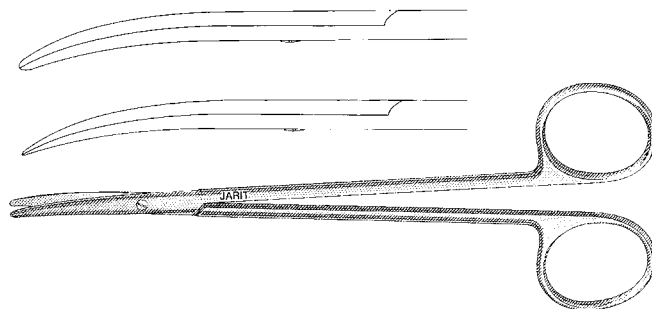

Endarterectomy Vascular Scissors

Catalog #	Description
310-330	6¾" (172mm), curved

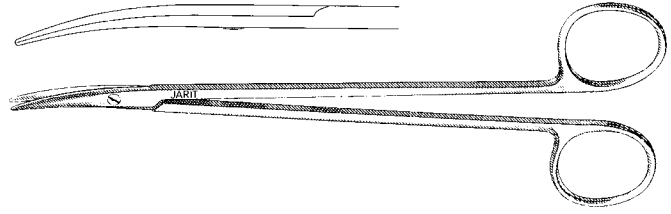

DeBakey Endarterectomy Scissors

Catalog #	Description
310-349	7" (178mm), full curve

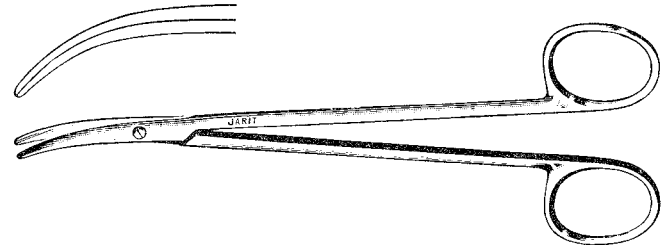

Lincoln Vascular Scissors

Catalog #	Description
310-367	10" (255mm), straight
310-368	10" (254mm), curved
310-369	6¾" (174mm), straight
310-370	6¾" (173mm), curved

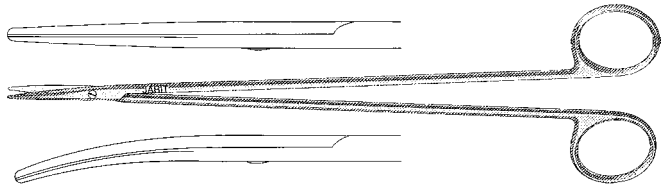

Church Vascular Scissors

Catalog #	Description
310-375	7" (175mm), straight
310-376	7" (175mm), curved

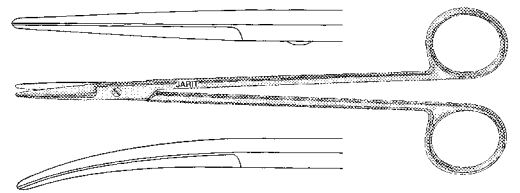

Mattox-Potts Scissors

Catalog #	Description
310-304	5⅜" (137mm), 45° angle, 22mm blades

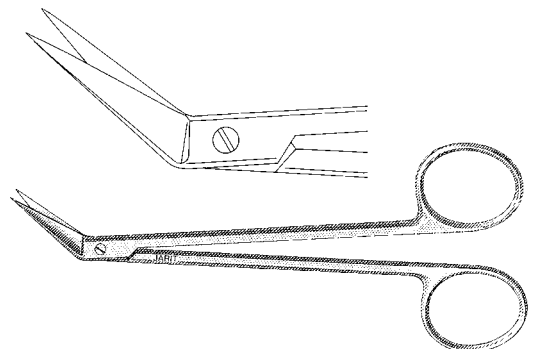

Potts-Smith Vascular Scissors

Catalog #	Description
310-310	7½" (189mm), 25° angle, 22mm blades
310-315	7¼" (185mm), 45° angle, 22mm blades
310-320	7" (180mm), 60° angle, 19mm blades

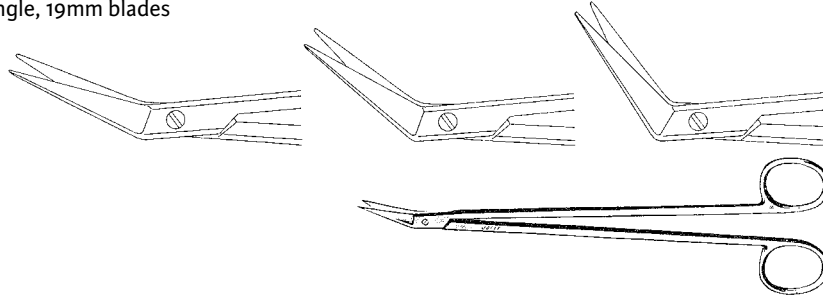

DeBakey-Potts Vascular Scissors

23mm blades

Catalog #	Description
310-332	6½" (168mm), 25° angle
310-333	6½" (163mm), 45° angle
310-334	6¼" (158mm), 60° angle

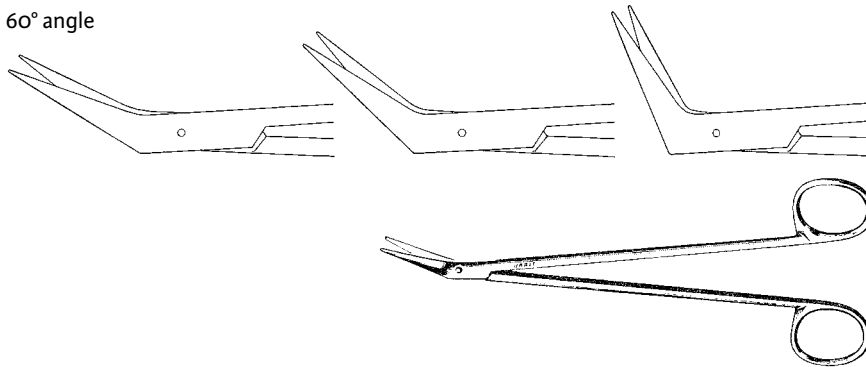

DeBakey Vascular Scissors

23mm blades

Catalog #	Description
310-340	6½" (168mm), 25° angle
310-341	6½" (163mm), 45° angle
310-342	6¼" (158mm), 60° angle
310-343	9" (230mm), 25° angle
310-344	9" (227mm), 45° angle
310-345	8¾" (221mm), 60° angle

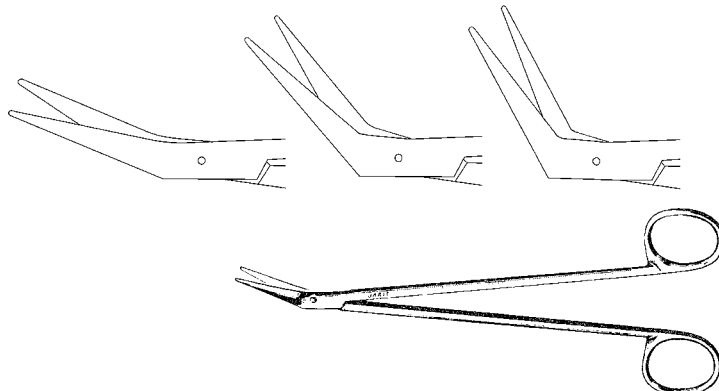

Diethrich Coronary Artery Scissors

Catalog #	Description
310-350	7" (182mm), 12mm blades, 25° angle
310-351	7" (180mm), 13mm blades, 45° angle
310-352	7" (177mm), 13mm blades, 60° angle
310-353	7" (172mm), 13.5mm blades, 90° angle
310-354	7" (172mm), 12.5mm blades, 120° angle

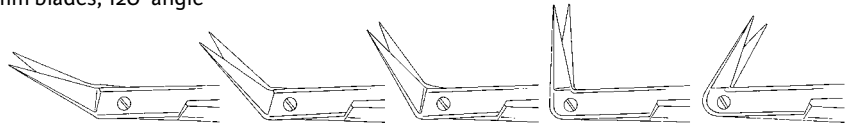

Diethrich Coronary Artery Scissors

extra delicate blade

Catalog #	Description
311-350	7" (182mm), 14mm blades, 25° angle
311-351	7" (179mm), 14mm blades, 45° angle
311-352	7" (176mm), 14mm blades, 60° angle
311-353	7" (176mm), 14mm blades, 90° angle
311-354	7" (176mm), 14mm blades, 120° angle

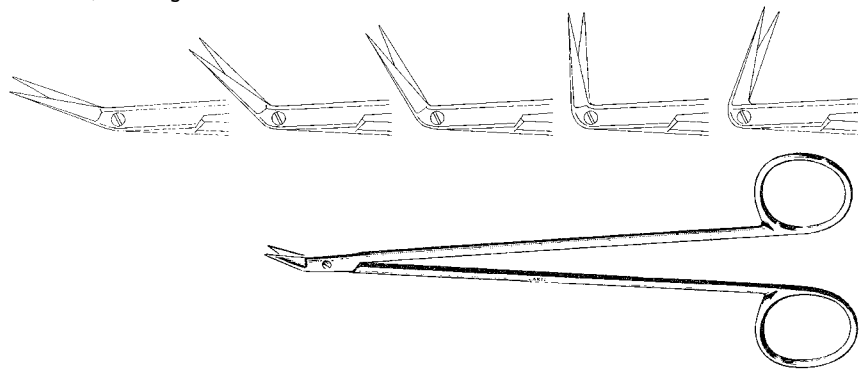

Diethrich Circumflex Artery Scissors

with stabilizing bar

Catalog #	Description
310-360	6¾" (172mm), 130° angle, 13mm blades

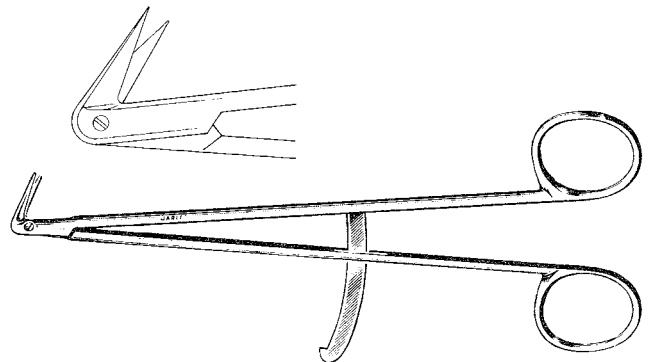

Diethrich-Potts Peripheral Vascular Scissors

Catalog #	Description
310-355	5 ³ / ₈ " (138mm), 25° angle, 12mm blades
310-356	5 ³ / ₈ " (135mm), 45° angle, 13mm blades
310-357	5 ¹ / ₄ " (133mm), 60° angle, 13mm blades
310-358	5" (126mm), 90° angle, 13.5mm blades

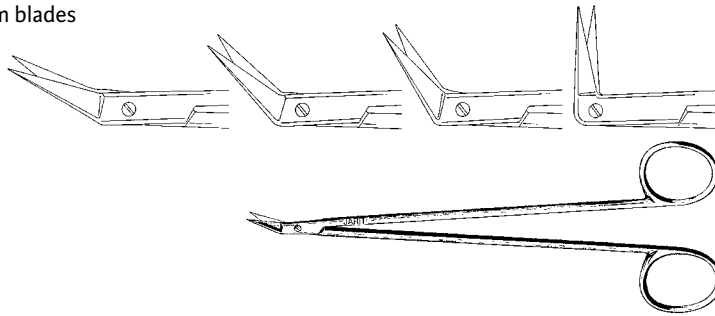

Favaloro Coronary Artery Scissors

Catalog #	Description
310-374	6 ³ / ₄ " (170mm), 130° angle, 9.5mm blades

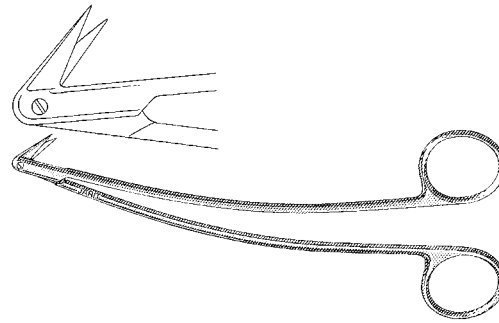

Karmody In-Situ Valve Scissors

Catalog #	Description
310-535	6" (152mm), working shaft, serrated blades, blunt tips

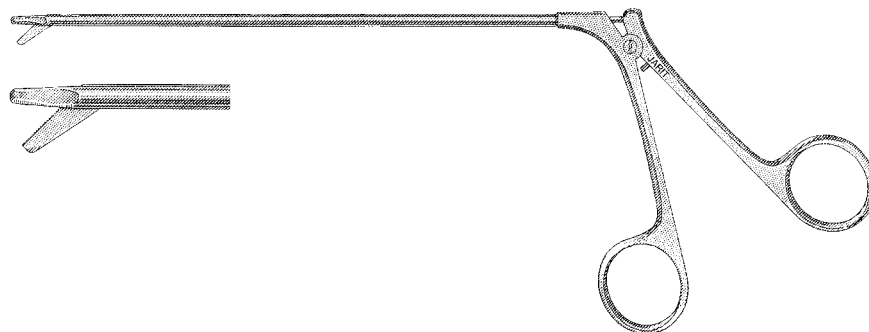

Knapp Iris Scissors, Sharp-Sharp

4" (103mm), 25mm blades

Catalog #	Description
360-090	Straight
360-093	Curved

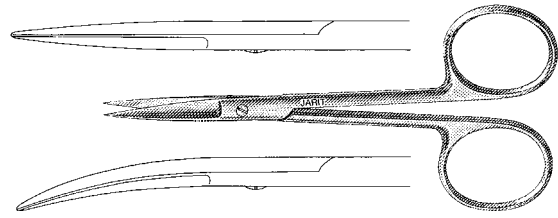

Knapp Iris Scissors, Sharp-Blunt

4" (103mm), 25mm blades

Catalog #	Description
360-091	Straight
360-094	Curved

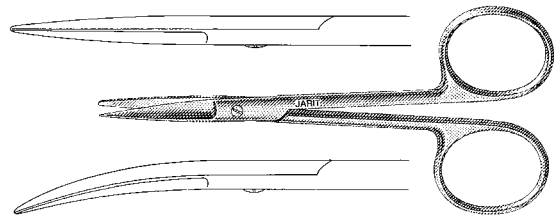

Knapp Iris Scissors, Blunt-Blunt

4" (103mm), 25mm blades

Catalog #	Description
360-092	Straight
360-095	Curved

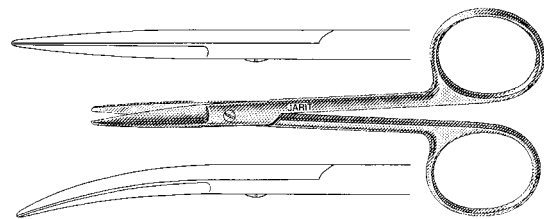

Iris Scissors, Sharp-Sharp, (Mirror Finish)

4⁵/₈" (116mm), 25mm blades

Manufactured from high grade German surgical stainless steel which is ground and polished to a mirror finish

Catalog #	Description
360-100	4 ⁵ / ₈ " (116mm), 25mm blades, straight
360-101	4 ⁵ / ₈ " (116mm), 25mm blades, curved

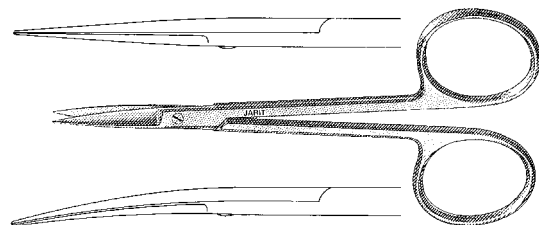

Iris Scissors, Sharp-Sharp, (Matte Finish)

4⁵/₈" (116mm), 25mm blades

Manufactured from high grade German surgical stainless steel which is glass beaded to a matte finish

Catalog #	Description
359-100	4 ⁵ / ₈ " (116mm), 25mm blades, straight
359-101	4 ⁵ / ₈ " (116mm), 25mm blades, curved

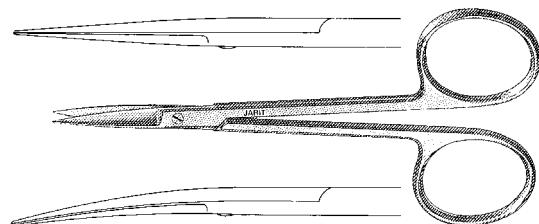

Iris Scissors, Angled on the Side

(Mirror Finish)

Catalog #	Description
360-102	4½" (115mm), 27mm blades

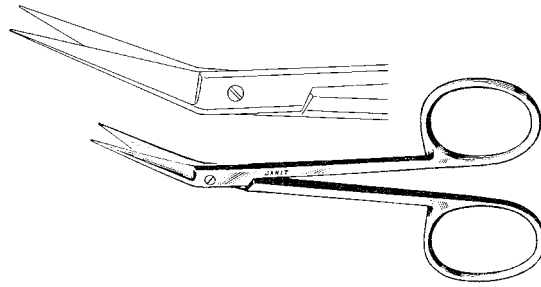

Iris Scissors, Angled on the Side, Probe Point

(Mirror Finish)

Catalog #	Description
360-103	4½" (115mm), 27mm blades

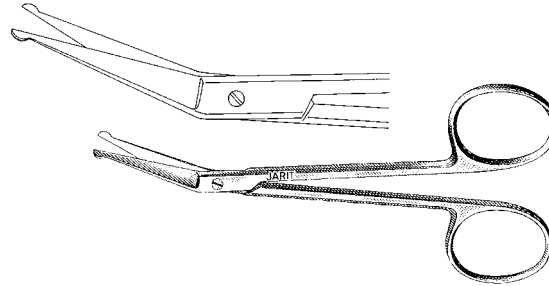

Iris Scissors, Sharp-Sharp

(Mirror Finish)

Catalog #	Description
360-104	3¾" (94mm), straight, 22mm blades
360-105	3¾" (94mm), curved, 22mm blades
360-110	4⅛" (105mm), straight, extra delicate, 22mm blades
360-111	4⅛" (105mm), curved, extra delicate, 22mm blades

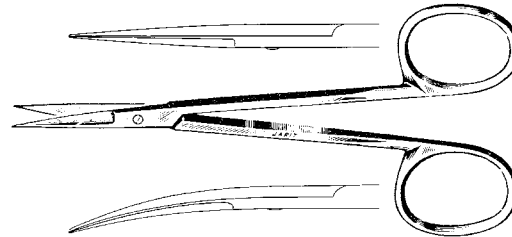

Wilmer Conjunctival Scissors, Angled on the Flat

Catalog #	Description
360-115	4⅛" (104mm), delicate, 15mm blades

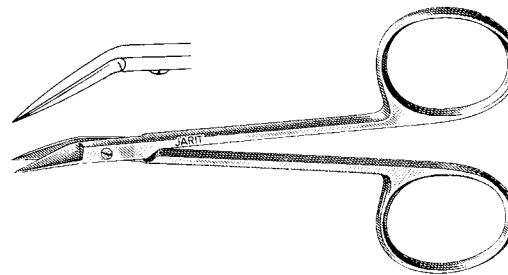

Iris Scissors, Large Finger Rings

3⅞" (98mm), 22mm blades, (Satin Finish)

Catalog #	Description
360-117	Straight
360-118	Curved

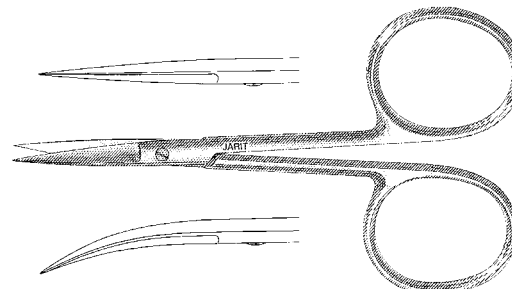

Iris Scissors, Sharp-Sharp

4" (103mm), delicate 26mm blades, (Mirror Finish)

Catalog #	Description
360-120	Straight
360-121	Curved

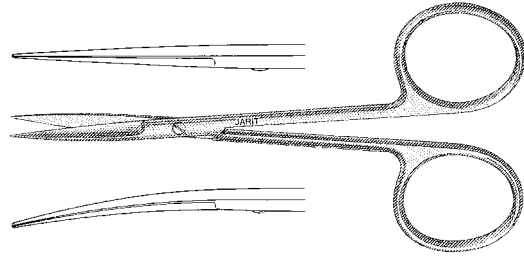

Iris Scissors, Flat Shanks, Sharp-Sharp

4 1/8" (104mm), 22mm blades, (Mirror Finish)

Catalog #	Description
360-122	Straight
360-123	Curved

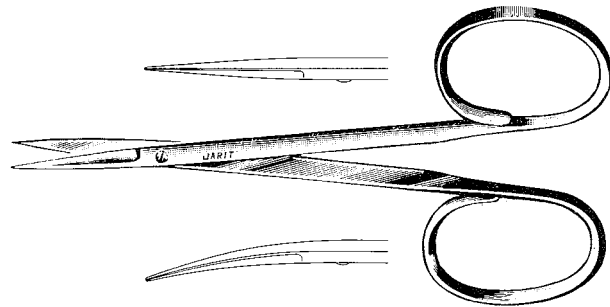

Iris Scissors, Flat Shanks, Sharp-Sharp

3 3/4" (96mm), delicate 13.5mm blades, (Mirror Finish)

Catalog #	Description
360-125	Straight
360-126	Curved

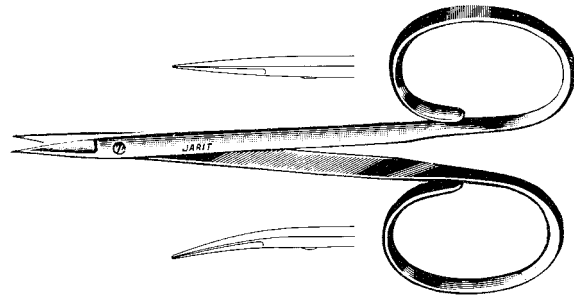

Eye Utility Scissors, Flat Shanks, Blunt-Blunt

3 7/8" (97mm), 16mm blades

Catalog #	Description
360-127	Straight
360-128	Curved

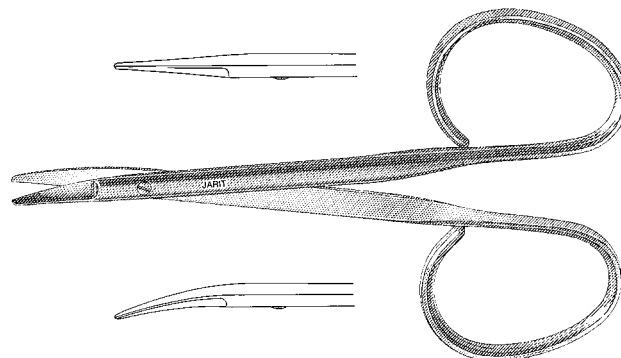

Strabismus Scissors

4½" (115mm), 30mm blades

Catalog #	Description
360-130	Straight
360-131	Curved

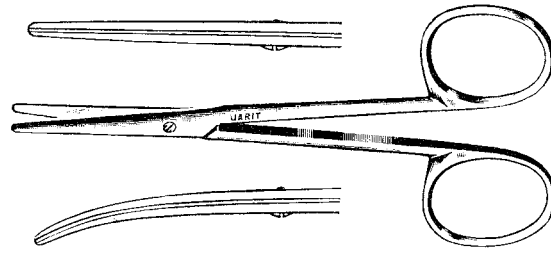

Strabismus Scissors, Flat Shanks

4⅞" (106mm), 25mm blades

Catalog #	Description
360-134	Straight
360-135	Curved

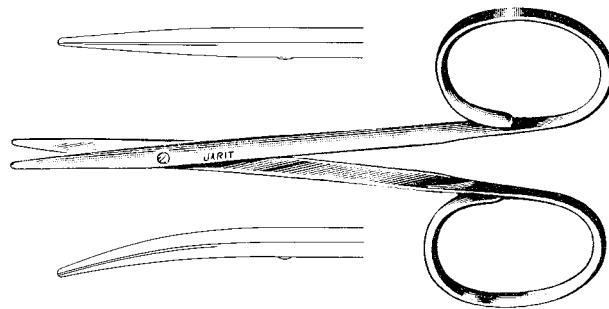

Stevens Tenotomy Scissors, Blunt-Blunt

4½" (115mm), slender pattern, 13mm blades

Catalog #	Description
360-138	Straight
360-139	Curved

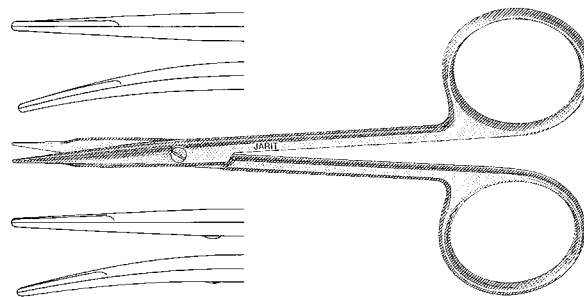

Stevens Tenotomy Scissors, Blunt-Blunt

4⅞" (105mm), standard pattern, 12mm blades

Catalog #	Description
360-140	Straight
360-141	Curved

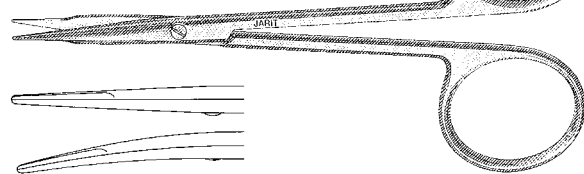

Stevens Tenotomy Scissors, Blunt-Blunt

3⅞" (98mm), flat shanks, 13mm blades

Catalog #	Description
360-142	Straight
360-143	Curved

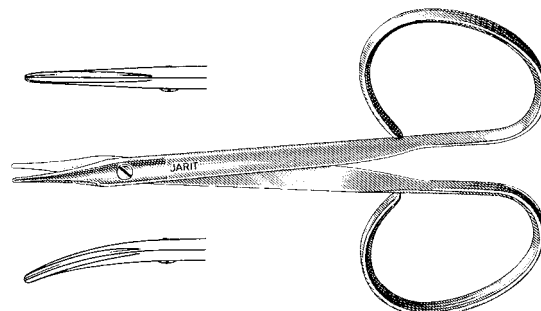

Stevens Stitch Scissors, Curved Sharp Tips

Catalog #	Description
360-148	4 1/8" (105mm), 14mm blades

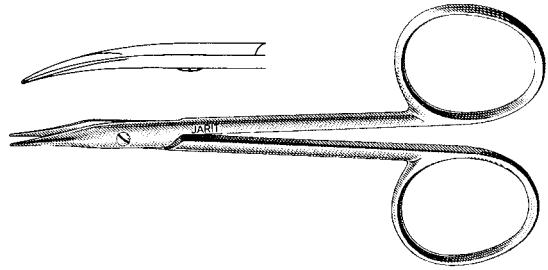

Stevens Stitch Scissors, Flat Shanks, Curved, Sharp Tips

Catalog #	Description
360-149	3 7/8" (98mm), 12mm blades

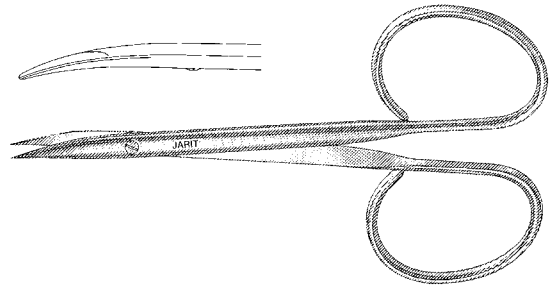

Stevens Removal Scissors, Flat Shanks, Curved, Fine Sharp Tips

Catalog #	Description
360-151	4 3/8" (111mm), 12mm blades

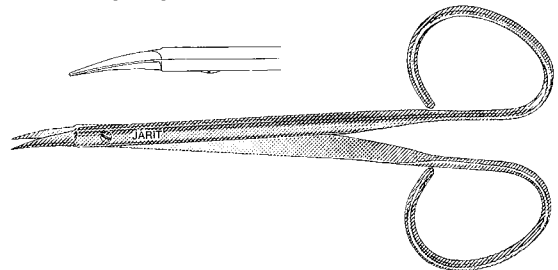

Enucleation Scissors, Strong Curve

Catalog #	Description
360-153	5 1/8" (130mm), 32mm blades

Enucleation Scissors, Light Curve

Catalog #	Description
360-157	5 1/8" (129mm), 27mm blades

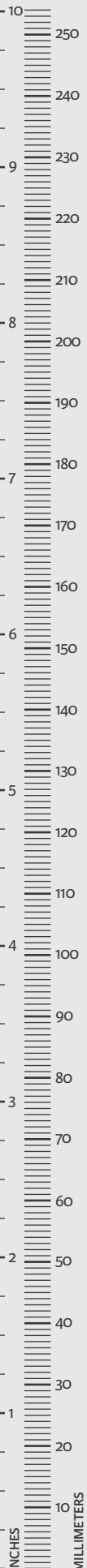
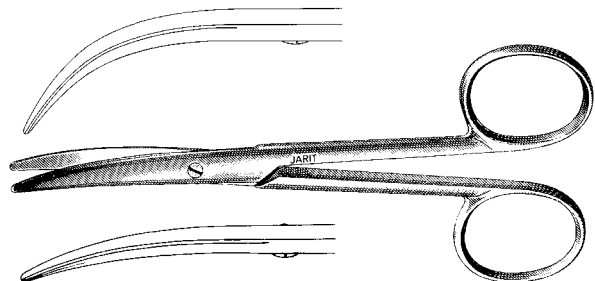

Stitch Scissors, Semi-Sharp Tips

3 7/8" (100mm), 16.5mm blades

Catalog #	Description
360-154	Straight
360-155	Curved

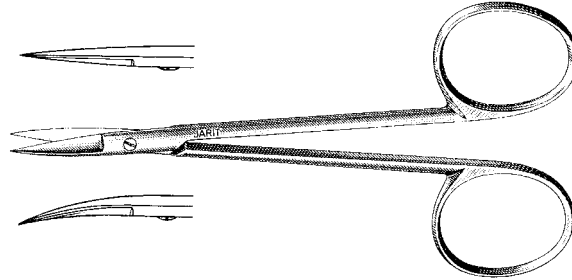

Gradle Stitch Scissors, Blunt Tips

Catalog #	Description
360-156	3 3/4" (95mm), 13mm blades

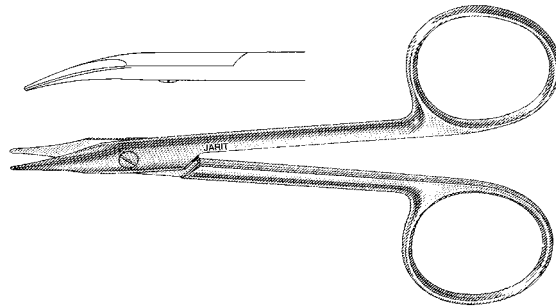

O'Brien Suture Scissors

Catalog #	Description
360-195	3 7/8" (100mm), angled

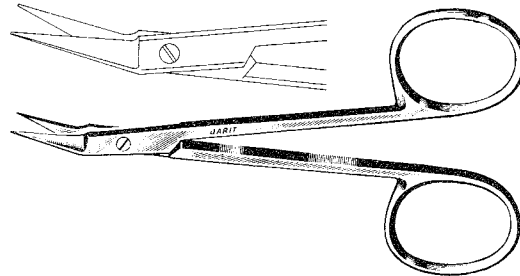

Seiler Turbinate Scissors

Catalog #	Description
400-177	6½" (163mm), 72mm blades

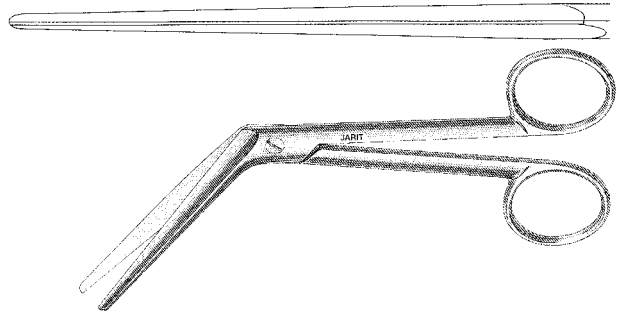

Knight Nasal Scissors

Catalog #	Description
400-180	6¼" (161mm), 33mm blades

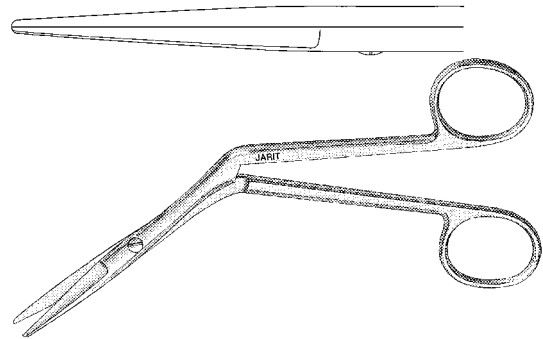

Ragnell Undermining Scissors

5¼" (133mm), 17mm flat tip blades

Catalog #	Description
415-100	Straight
415-101	Half-curve
415-102	Full curve

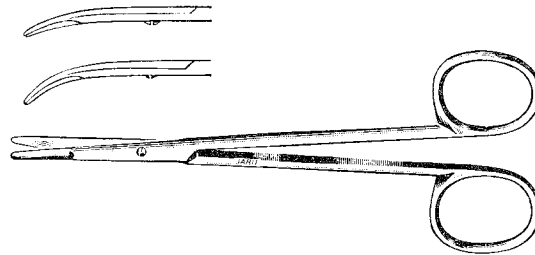

Cinelli Lower Lateral Scissors, Full Curve

Catalog #	Description
415-105	4⅝" (116mm)

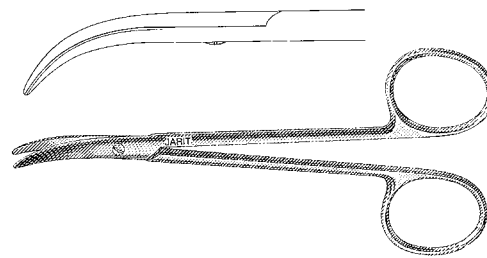

Fomon Lower Lateral Scissors, Full Curve

Catalog #	Description
415-110	4½" (114mm), 24mm blades

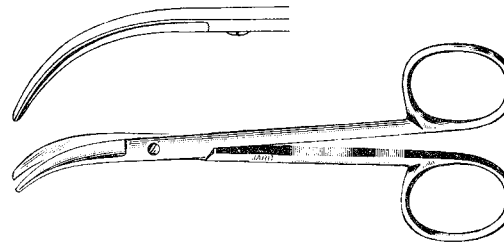

Lower Lateral Scissors, Full Curve

Catalog #	Description
415-112	6½" (168mm), 19mm blades

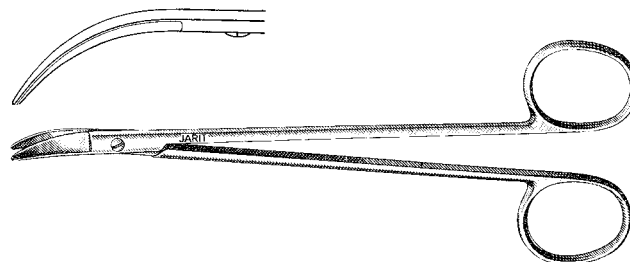

Dorsal Scissors, Blunt-Blunt

Catalog #	Description
415-114	4⅝" (119mm), straight, 30mm blades

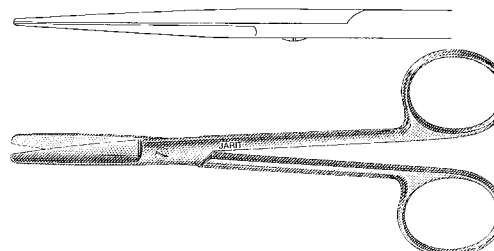

Fomon Dorsal Scissors, Angled Handles

Catalog #	Description
415-115	5 ³ / ₄ " (146mm), 35mm blades

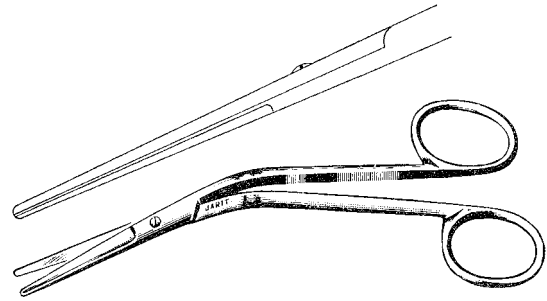

Goldman Dorsal or Septum Scissors, Angled Handles

Catalog #	Description
415-116	5 ³ / ₄ " (146mm), 40mm serrated blades

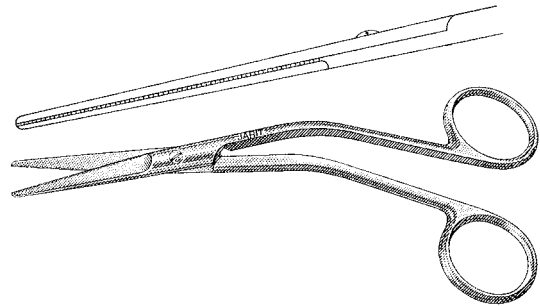

Cottle Dorsal Scissors, Heavy, Angled Handles

Catalog #	Description
415-117	5 ³ / ₄ " (145mm), 55mm blades

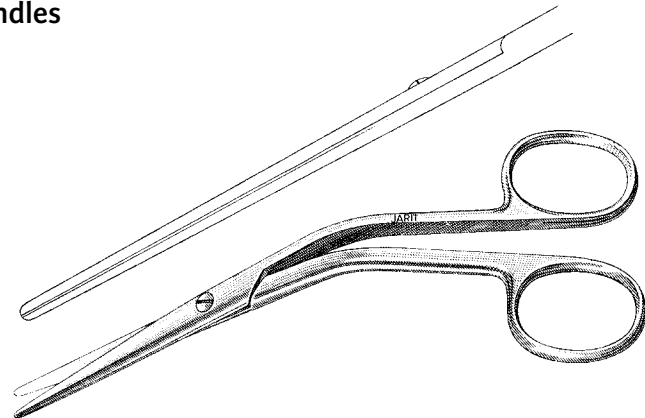

Caplan Nasal Bone Scissors, Double Action

Catalog #	Description
415-118	8" (203mm), 22mm serrated blades

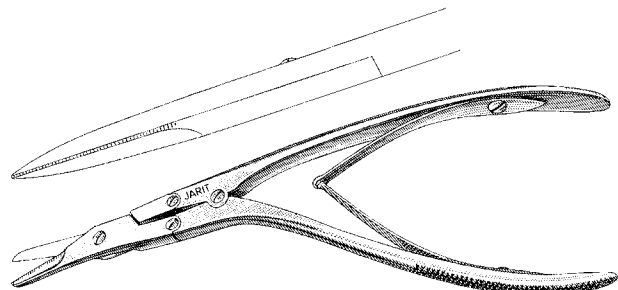

Cottle Septum Scissors, Angled Handles

Catalog #	Description
415-119	7¼" (187mm), 44mm serrated blades

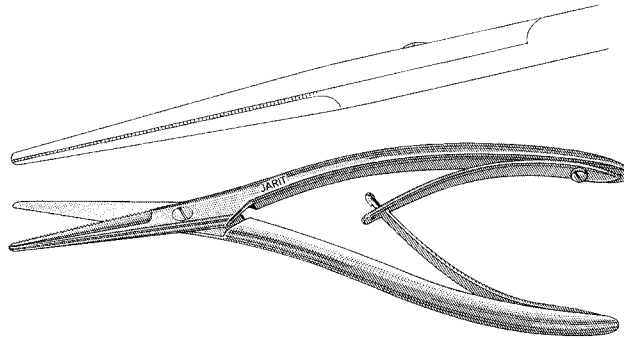

Miller Dissecting Scissors

Catalog #	Description
415-120	5" (128mm), 32mm semi-sharp outer edge blades

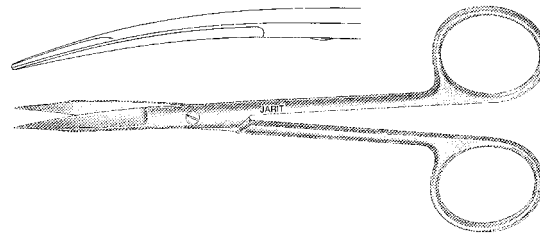

Kaye Dissecting Scissors, Curved

Catalog #	Description
415-121	4⅛" (106mm), 22mm serrated blades

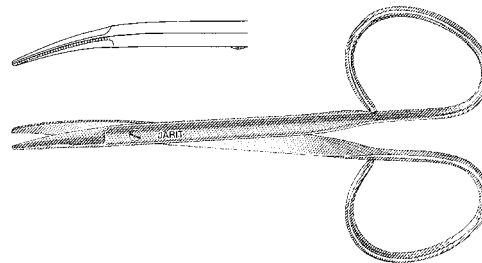

Fomon Saber Back Scissors, Curved

Catalog #	Description
415-123	5⅜" (136mm), 29mm semi-sharp outer edge blades

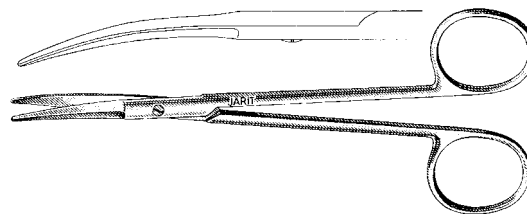

Goldman Nasal Scissors, Curved

Catalog #	Description
415-124	5⅜" (143mm), 29mm semi-sharp outer edge blades

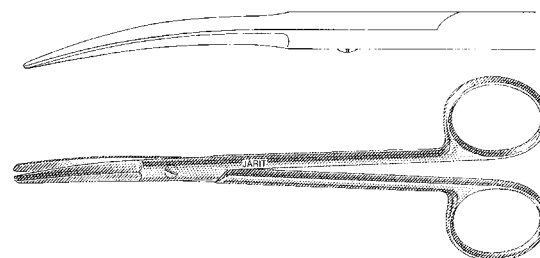

Aufricht Nasal Scissors, Curved

Catalog #	Description
415-125	5 ³ / ₄ " (146mm), 43mm semi-sharp outer edge blades

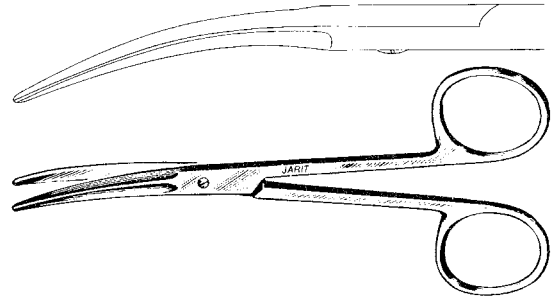

Jackson Nasal Bone Scissors, Angled, Heavy Pattern

Catalog #	Description
415-127	7 ³ / ₄ " (200mm), 40mm blades

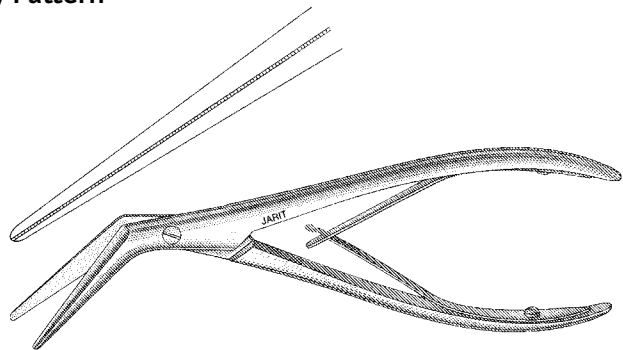

Becker Septum Scissors, Angled

Catalog #	Description
415-130	7 ¹ / ₄ " (183mm), 22mm serrated blades

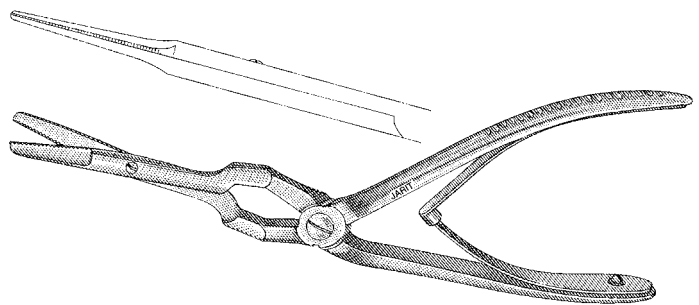

Gorney Turbinate Scissors, Double Action

Catalog #	Description
415-133	8 ¹ / ₄ " (210mm), 40mm serrated blades

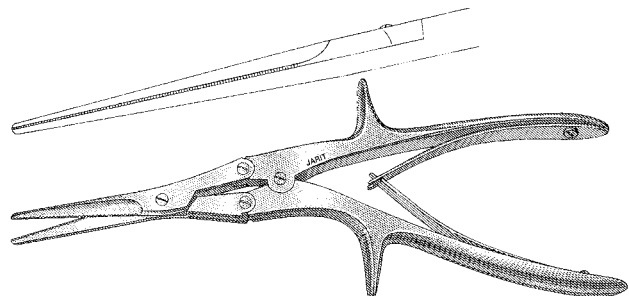

Brophy Gum and Suture Scissors, Sharp

5¾" (146mm), 35mm sharp blades

Catalog #	Description
415-140	Straight
415-141	Curved

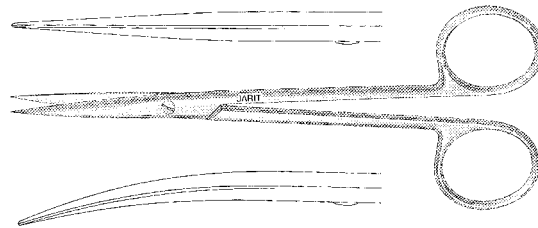

Little Suture Carrying Scissors, Curved

Catalog #	Description
415-145	4¾" (120mm), 22mm blades

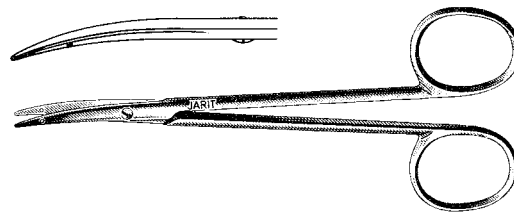

Brown Dissecting Scissors, Heavy Handles

5¾" (146mm), 42.5mm narrow blades

Catalog #	Description
415-150	Straight
415-152	Curved

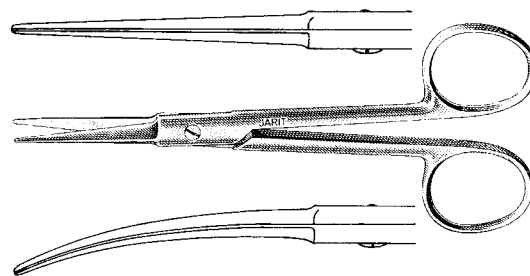

Brown Dissecting Scissors

5½" (139mm), 35mm blades

Catalog #	Description
415-170	Straight
415-172	Curved

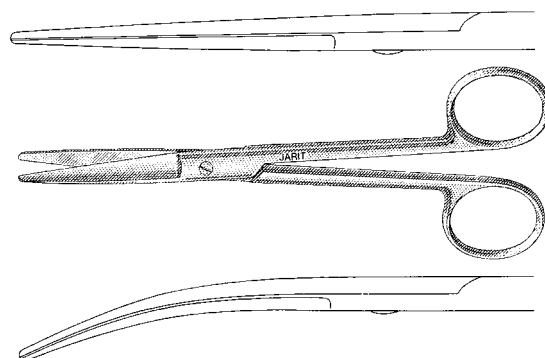

Dean Tonsil Scissors, Angled

Catalog #	Description
450-450	7" (175mm), 20mm blades, bottom blade serrated

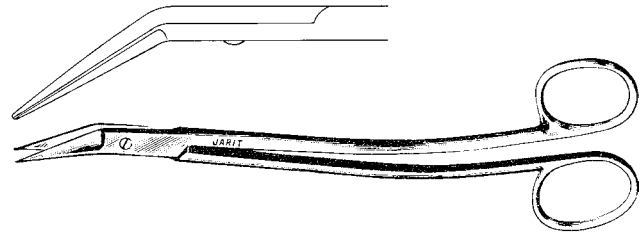

Boettcher Tonsil Scissors, Curved

Catalog #	Description
450-455	7 1/4" (184mm), 37mm blades, sharp outer edges

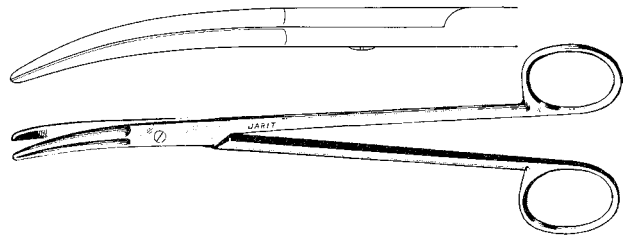

Lillie Tonsil Scissors, Curved

Catalog #	Description
450-457	8" (205mm), 40mm blades

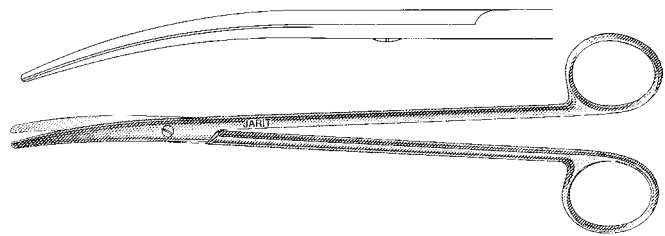

Boyd Tonsil Scissors, Double Curved

Catalog #	Description
450-460	7" (177mm), 30mm blades

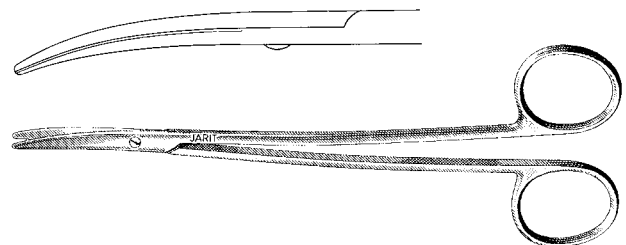

Sims Uterine Scissors, Straight

8" (203mm)

Catalog #	Description
505-400	Sharp-sharp, 50mm blades
505-401	Sharp-blunt, 52mm blades
505-402	Blunt-blunt, 50mm blades

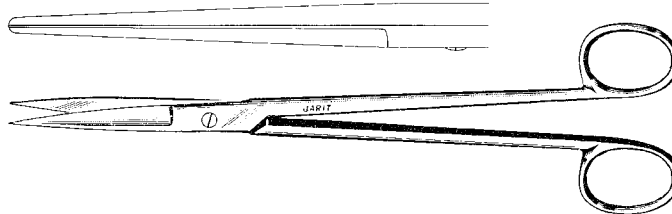

Sims Uterine Scissors, Curved

7¾" (200mm)

Catalog #	Description
505-405	Sharp-sharp, 50mm blades
505-406	Sharp-blunt, 51mm blades
505-407	Blunt-blunt, 50mm blades

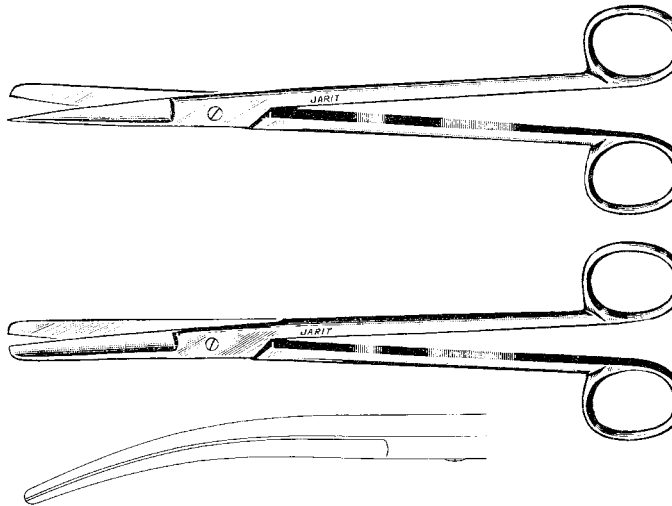

Braun Episiotomy Scissors

Catalog #	Description
505-435	5¾" (146mm), 42.5mm blades
505-436	8¾" (222mm), 53.5mm blades

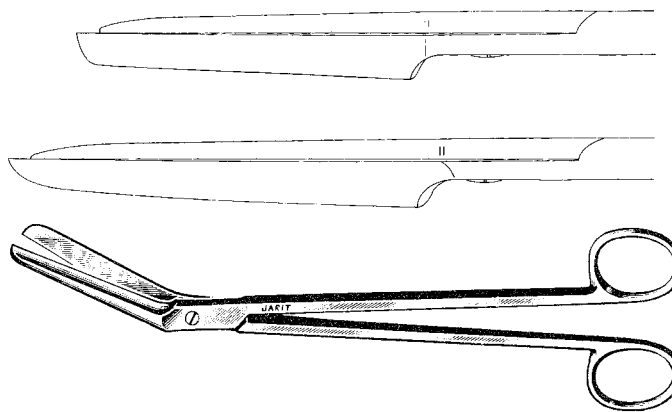

Carb-Edge™ Scissors

These superbly crafted instruments have a hard tough alloy permanently welded to the scissors and are vacuum hardened. This alloy, composed principally of tungsten, cobalt, chromium and carbon, is harder than stainless steel. Cutting edges of Carb-Edge Scissors are manufactured to ensure instrument durability and longer-lasting blade edge sharpness.

Carb-Edge Scissors are warranted to stay sharp for at least three years of normal usage. If sharpening should be required during the warranty period, it will be done without charge. Finger rings are gold plated for easy identification.



Operating Scissors, Carb-Edge

Catalog #	Description
101-110	5¾" (145mm), straight, sharp-sharp
101-112	5¾" (145mm), curved, sharp-sharp
101-130	5¾" (145mm), straight, sharp-blunt
101-132	5¾" (145mm), curved, sharp-blunt

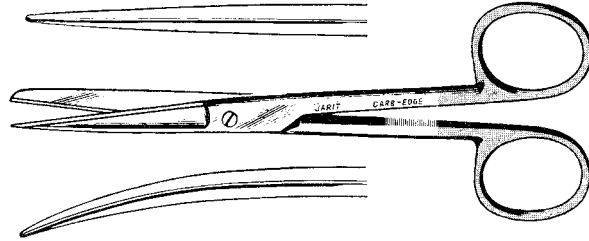

Mayo Scissors, Round Blades, Carb-Edge, (Satin Finish)

Manufactured from high grade German surgical stainless steel which is ground and polished to a satin finish

Catalog #	Description
101-215	5⅞" (150mm), straight
101-217	5⅞" (150mm), curved
101-218	6¼" (160mm), straight, slender, fine tip
101-219	6¼" (160mm), curved, slender, fine tip
101-220	6¾" (171mm), straight
101-222	6¾" (171mm), curved
101-230	14¼" (361mm), straight
101-232	14¼" (361mm), curved

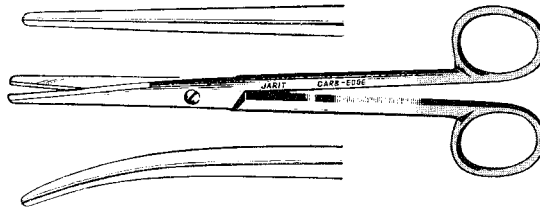

Mayo Scissors, Round Blades, Carb-Edge (Matte Finish)

Manufactured from high grade German surgical stainless steel which is glass beaded to a matte finish

Catalog #	Description
103-220	6¾" (171mm), straight
103-222	6¾" (171mm), curved

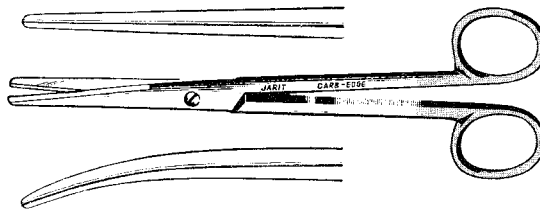

Mayo-Harrington Scissors, Beveled Blades, Carb-Edge

Catalog #	Description
101-225	9" (230mm), straight
101-226	9" (230mm), curved

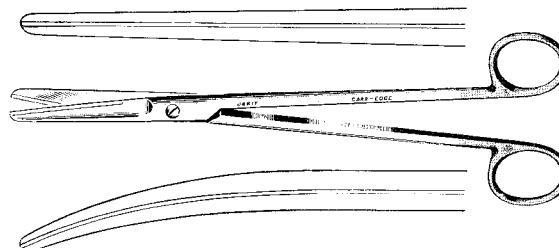

Metzenbaum-Lahey Scissors, Carb-Edge, (Satin Finish)

Manufactured from high grade German surgical stainless steel which is ground and polished to a satin finish

Catalog #	Description
101-250	5¾" (145mm), straight
101-251	5¾" (145mm), curved

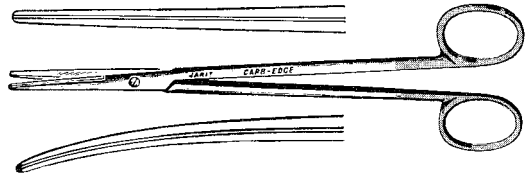

Metzenbaum-Lahey Scissors, Carb-Edge, (Matte Finish)

Manufactured from high grade German surgical stainless steel which is glass beaded to a matte finish

Catalog #	Description
103-250	5¾" (145mm), straight
103-251	5¾" (145mm), curved

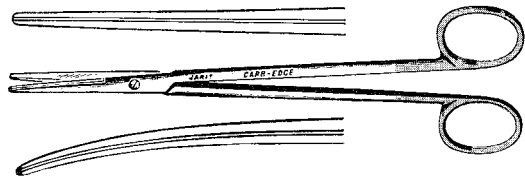

Metzenbaum-Lahey Scissors, Carb-Edge

delicate, sharp-sharp

Catalog #	Description
101-252	5¾" (145mm), straight
101-253	5¾" (145mm), curved

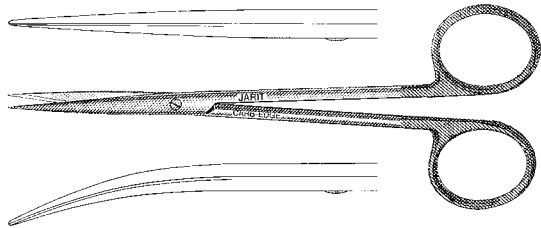

Petit-Point® Reynolds Scissors, Carb-Edge

Catalog #	Description
101-255	5⅛" (130mm), curved, one blade serrated

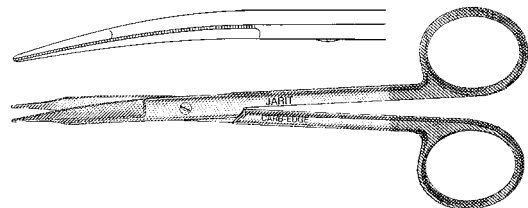

Metzenbaum Scissors, Carb-Edge, (Satin Finish)

Manufactured from high grade German surgical stainless steel which is ground and polished to a satin finish

Catalog #	Description
101-258	7" (179mm), curved
101-260	7" (179mm), delicate, straight
101-261	7" (179mm), delicate, curved
101-265	8" (206mm), curved

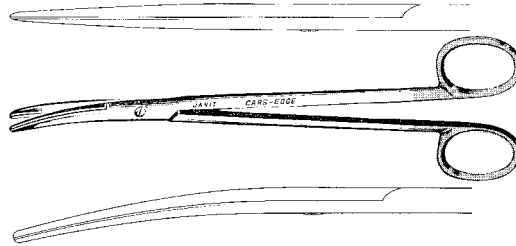

Metzenbaum Scissors, Carb-Edge, (Matte Finish)

Manufactured from high grade German surgical stainless steel which is glass beaded to a matte finish

Catalog #	Description
103-258	7" (179mm), curved
103-261	7" (179mm), delicate, curved

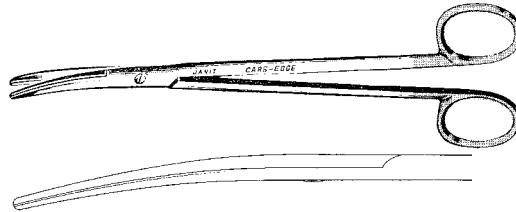

Metzenbaum-Nelson Scissors, Carb-Edge

Catalog #	Description
101-266	9 1/4" (233mm), straight
101-267	9 1/4" (233mm), curved
101-275	9 1/4" (233mm), straight, delicate
101-276	9 1/4" (233mm), curved, delicate
101-269	10 1/4" (260mm), curved
101-270	11 1/4" (285mm), curved
101-272	12 1/4" (310mm), curved
101-256	14 1/4" (364mm), curved

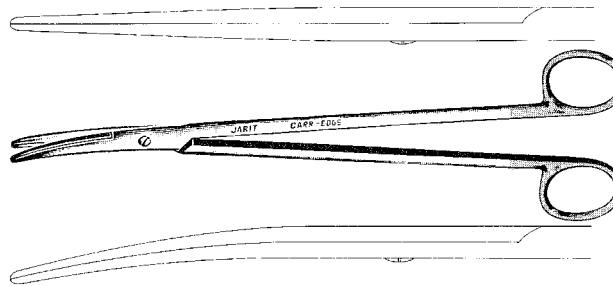

Metzenbaum Scissors, Carb-Edge

sharp-sharp

Catalog #	Description
101-257	7" (179mm), straight
101-259	7" (179mm), delicate, curved
101-278	9 1/4" (233mm), straight
101-279	9 1/4" (233mm), curved

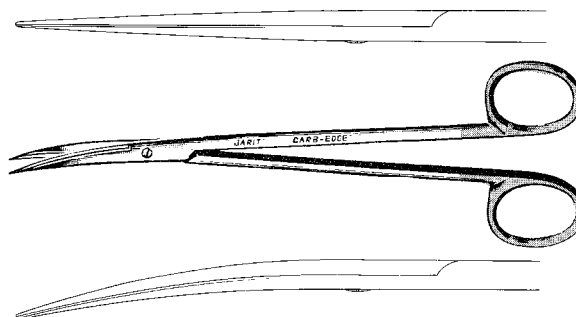

Iris Scissors, Carb-Edge

Catalog #	Description
101-300	4½" (114mm), straight
101-301	4½" (114mm), curved

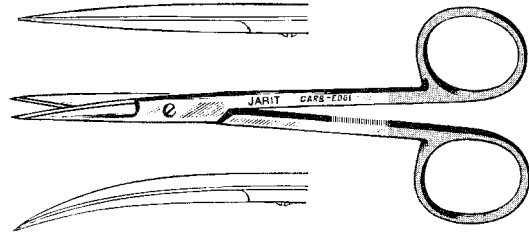

Strabismus Scissors, Carb-Edge

Catalog #	Description
101-310	4½" (114mm), straight
101-311	4½" (114mm), curved

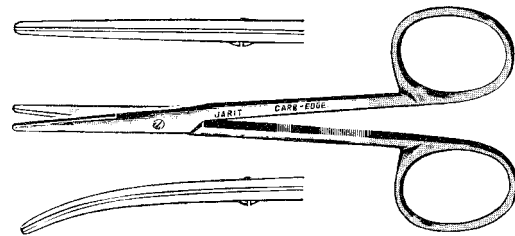

Universal Wire Suture Scissors, Carb-Edge

Catalog #	Description
101-350	4⅞" (124mm), angled, for cutting suture and wire (26 gauge and smaller)

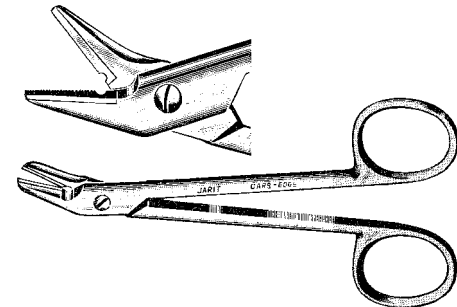

Parametrium Scissors, Carb-Edge

Catalog #	Description
505-265	9" (226mm), slight curve, 75mm blades
505-266	8¾" (224mm), curved, 72mm blades
505-267	8½" (219mm), full curved, 70mm blades
505-268	10½" (267mm), slight curve, 75mm blades
505-269	10¼" (260mm), curved, 72mm blades
505-270	10" (255mm), full curve, 70mm blades
505-271	12" (305mm), slight curve, 75mm blades
505-272	11¾" (300mm), curved, 72mm blades
505-273	11½" (295mm), full curve, 70mm blades

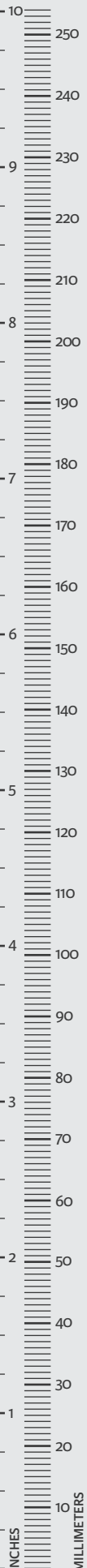
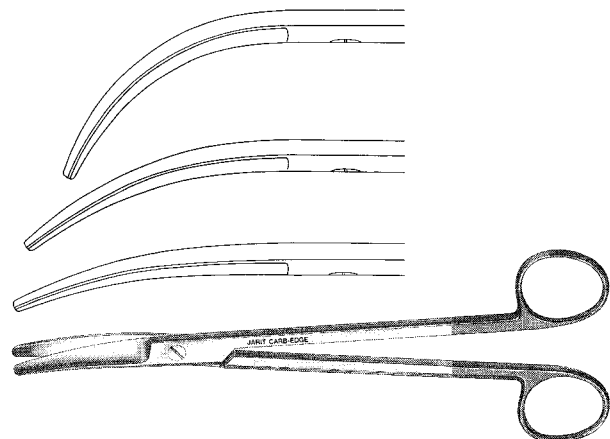

Developed by utilizing unique and innovative methods of grinding, sharpening and heat treating, Jarit Supercut™ scissors have a degree of sharpness greater than on conventional surgical scissors. Finger rings are black plated for easy identification.

All Jarit Supercut Scissors are further warranted for a period of one year under normal usage. Jarit Supercut Scissors will be date stamped for control.

The Jarit Supercut blade is razor sharp and glides effortlessly through tissue with a clean cut. The finely serrated lower blade helps prevent slippage.

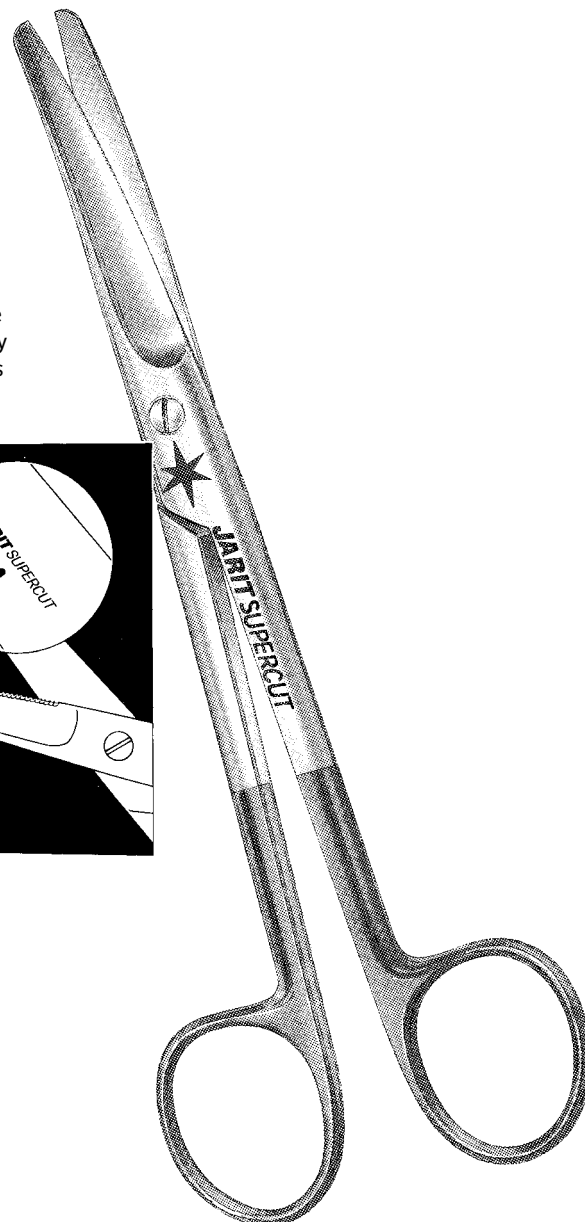
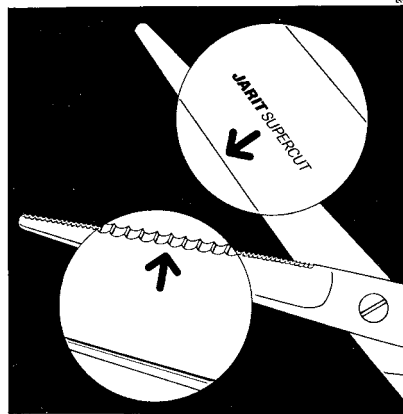

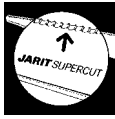

Mayo Scissors, Supercut

Catalog #	Description
102-100	5¾" (145mm), straight
102-102	5¾" (145mm), curved
102-110	6¾" (173mm), straight
102-112	6¾" (173mm), curved
102-115	9" (230mm), straight
102-116	9" (230mm), curved
102-113	10" (256mm), straight
102-118	11" (280mm), curved
102-114	12" (305mm), straight

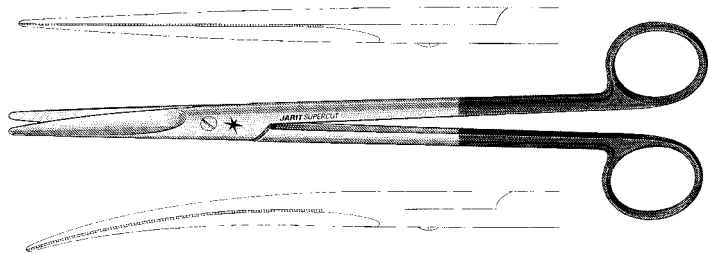
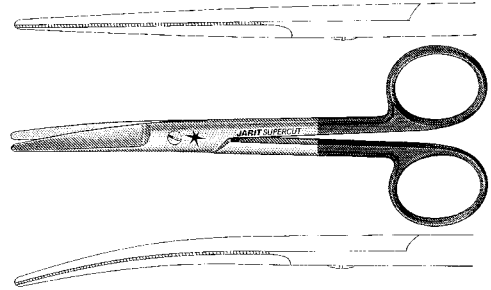

Metzenbaum-Lahey Scissors, Supercut

Catalog #	Description
102-119	5⅝" (143mm), straight
102-120	5⅝" (143mm), curved

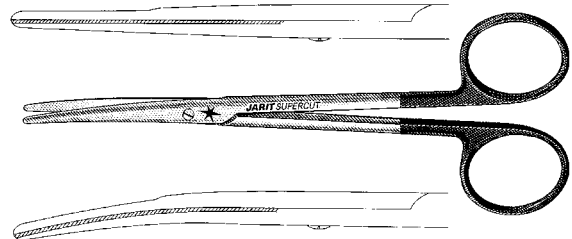

Metzenbaum Scissors, Supercut

Catalog #	Description
102-122	7" (180mm), curved
102-125	9¼" (232mm), curved
102-128	11¼" (285mm), curved
102-127	14" (356mm), curved
102-126	10¼" (260mm), curved
102-129	12" (302mm), curved

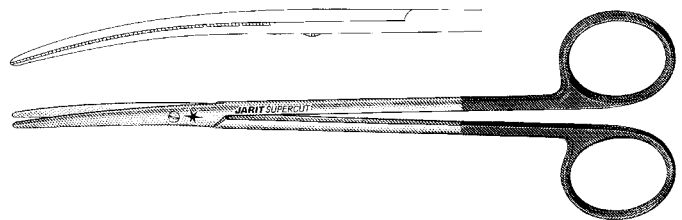

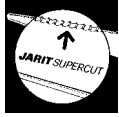

Iris Scissors, Supercut

Catalog #	Description
102-130	4 ⁵ / ₈ " (116mm), straight
102-131	4 ⁵ / ₈ " (116mm), curved

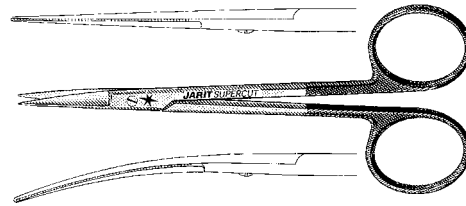

Knight Nasal Scissors, Supercut

Catalog #	Description
102-180	6 ¹ / ₄ " (157mm), angled on the side

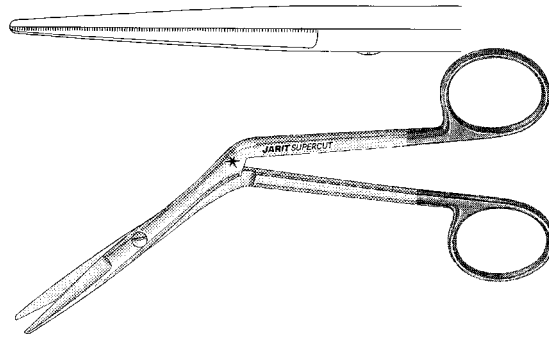

Plastic Surgery Scissors, Supercut

Catalog #	Description
102-200	4 ³ / ₄ " (121mm), straight
102-202	4 ³ / ₄ " (121mm), curved

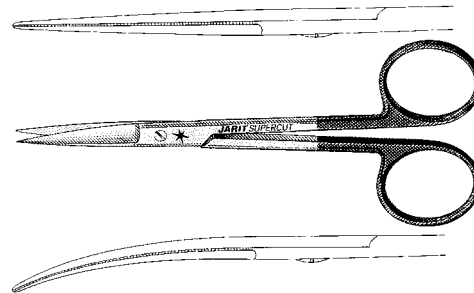

Stevens Tenotomy Scissors, Supercut

blunt tips

Catalog #	Description
102-138	4 ³ / ₈ " (112mm), 13mm blades, straight, slender pattern
102-139	4 ³ / ₈ " (112mm), 13mm blades, curved, slender pattern
102-140	4 ¹ / ₄ " (107mm), 12mm blades, straight, standard pattern
102-141	4 ¹ / ₄ " (107mm), 12mm blades, curved, standard pattern

Standard shown below. Supercut available.

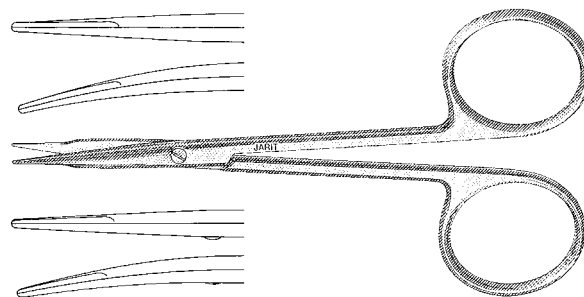

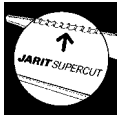

Castanares Face Lift Scissors, Supercut

Catalog #	Description
102-205	6 1/4" (157mm), straight

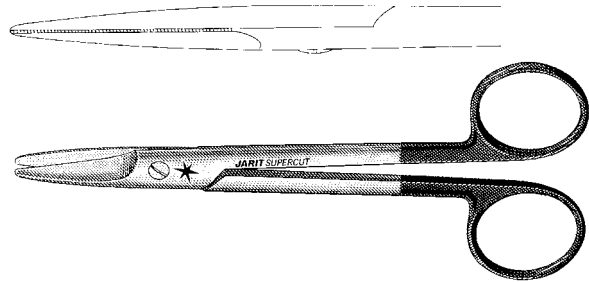

Gorney Plastic Surgery Scissors, Supercut

Catalog #	Description
102-210	7 1/4" (185mm), straight
102-211	7 1/4" (185mm), curved

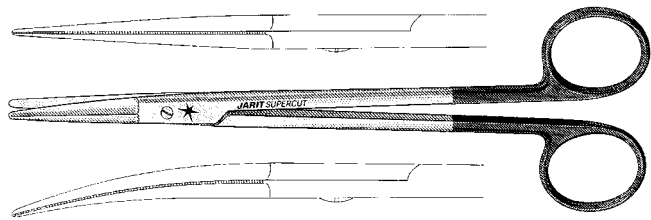

Kaye Face Lift Scissors, Supercut
beveled blades, semi-sharp outer edges

Catalog #	Description
102-215	5 5/8" (142mm), curved
102-216	7 3/4" (194mm), curved

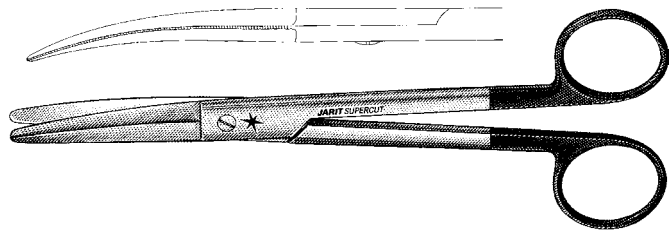

Freeman-Gorney Face Lift Scissors, Supercut
beveled blades, semi-sharp outer edges and flat, tapered tips; flared shanks

Catalog #	Description
102-220	7 1/4" (184mm), straight
102-221	7 1/4" (184mm), curved

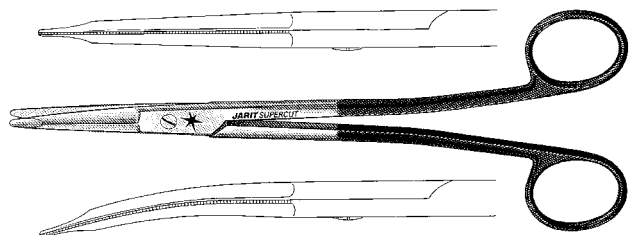

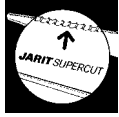

Freeman-Kaye Face Lift Scissors, Supercut

beveled blades, semi-sharp outer edges and flat, tapered tips; flared shanks

Catalog #	Description
102-225	7¼" (184mm), straight
102-226	7¼" (184mm), curved

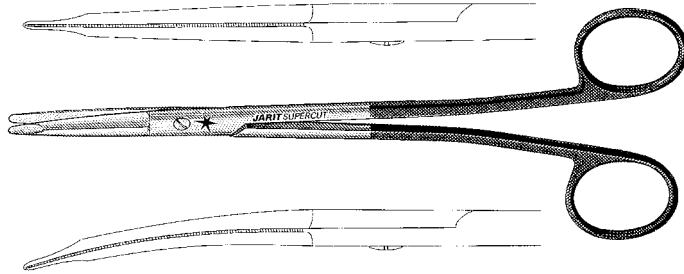

Freeman Rhytidectomy Scissors, Supercut

curved flat tips; flared shanks

Catalog #	Description
102-229	7" (178mm)

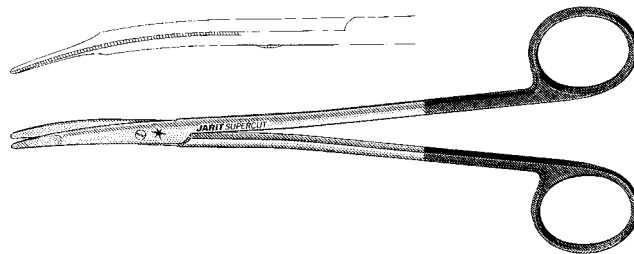

Gorney Platysma Scissors, Supercut

beveled blades, semi-sharp outer edges and flat, tapered tips; flared shanks

Catalog #	Description
102-230	9¼" (232mm), straight
102-231	9¼" (232mm), curved

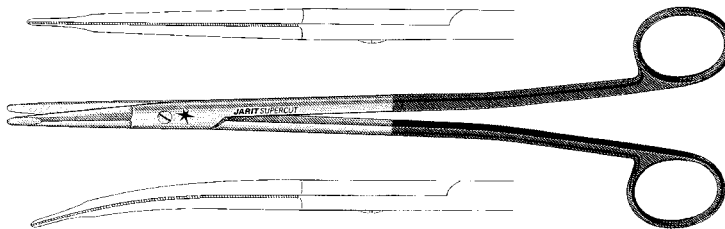

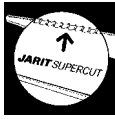

Fomon Lateral Scissors, Supercut

Catalog #	Description
102-235	4½" (115mm), full curved

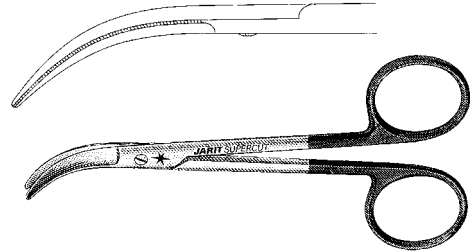

Fomon Dorsal Scissors, Supercut

Catalog #	Description
102-236	5¼" (133mm), angled on the flat

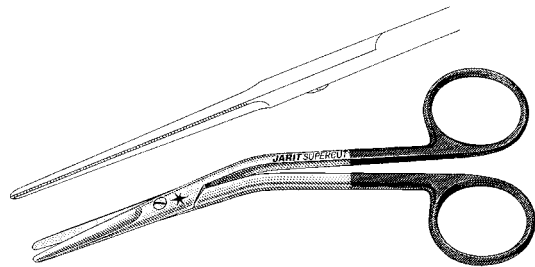

Cottle Dorsal Scissors, Supercut

Catalog #	Description
102-238	6" (155mm), angled on flat

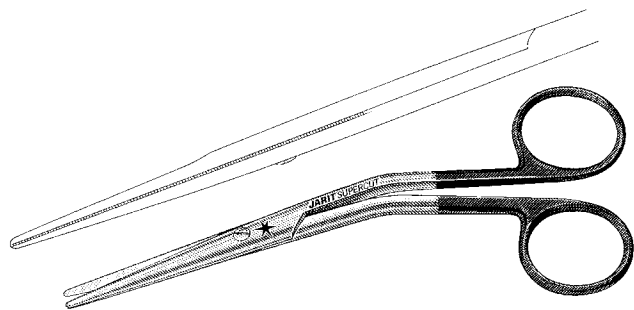

Par Style Plastic and Recon Scissors, Supercut

Catalog #	Description
102-240	4½" (113mm), curved
102-242	5⅝" (144mm), curved

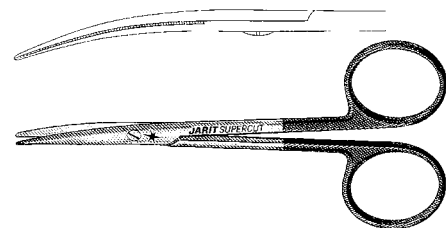

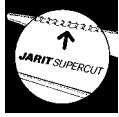

Reynolds Petit-Point Scissors, Supercut

Catalog #	Description
102-245	5 1/8" (129mm), curved

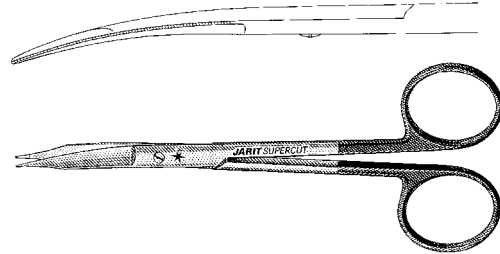

Jamison Scissors, Supercut

Catalog #	Description
102-300	5 5/8" (143mm), curved
102-302	7" (180mm), curved

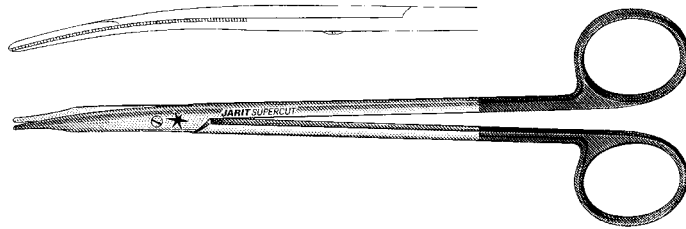

Lillehei-Potts Scissors, Supercut
9" (230mm), 34mm blades

Catalog #	Description
102-305	Curved blades, sharp tips
102-306	Curved blades, blunt tips
102-307	Curved blades, tenotomy tips



Metzenbaum Scissors, Supercut
curved, delicate

Catalog #	Description
102-310	7" (178mm), 33.5mm blades
102-311	7 3/4" (200mm), 32mm blades

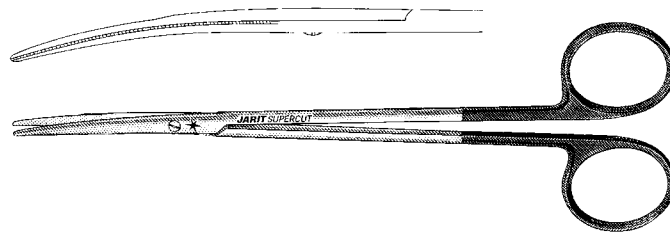

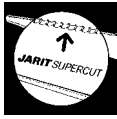

Stevens Tenotomy Scissors, Supercut

Catalog #	Description
102-313	7" (178mm), curved, 33mm dissecting tips



Endarterectomy Scissors, Supercut

Catalog #	Description
102-315	6¾" (173mm), curved

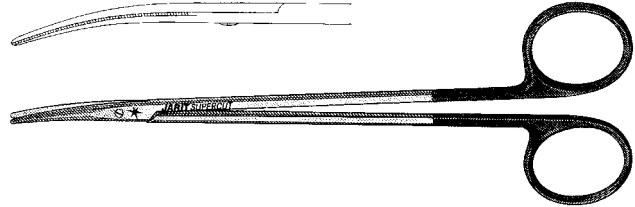

Potts-Smith Scissors, Supercut

Catalog #	Description
102-320	25°, 7½" (189mm), 22mm blades
102-321	45°, 7¼" (185mm), 20mm blades
102-322	60°, 7" (180mm), 19mm blades

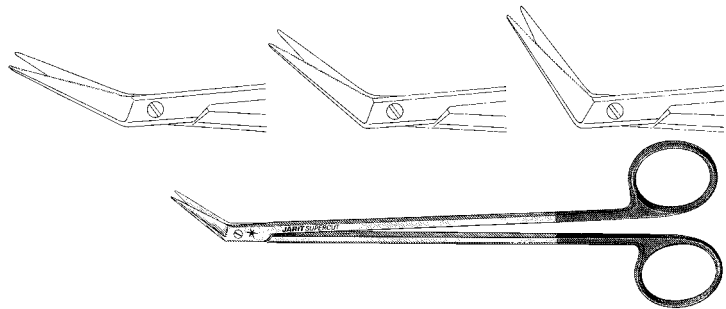

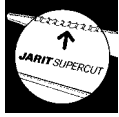

Diethrich Coronary Artery Scissors, Supercut

Catalog #	Description
102-350	25°, 7" (182mm), 12mm blades
102-351	45°, 7" (180mm), 13mm blades
102-352	60°, 7" (177mm), 13mm blades
102-353	90°, 7" (170mm), 13.5mm blades
102-354	125°, 7" (172mm), 11mm blades

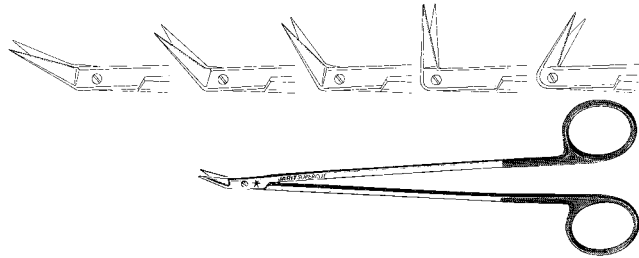

Diethrich Coronary Artery Scissors, Supercut

Catalog #	Description
102-360	6¾" (172mm), 130°, 13mm blades shanks are stabilized to keep blades in alignment

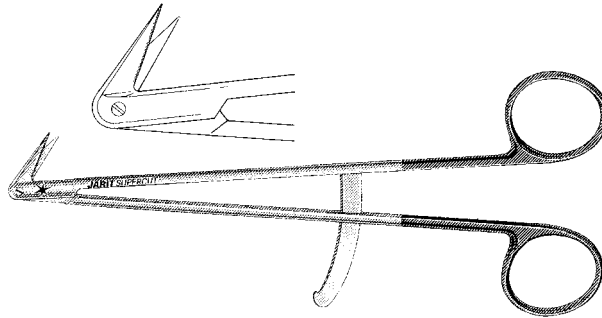

Favaloro Coronary Artery Scissors, Supercut

Catalog #	Description
102-374	6¼" (158mm), 125°, 9.5mm blades



Jarit Petit-Point® instruments feature a matched and balanced set of fine, delicate hemostats, soft-tension intestinal clamps, delicate scissors, and needle holders, for pediatric and other delicate procedures.

Petit-Point Jacobson Mosquito Forceps

Catalog #	Description
105-088	4 ⁷ / ₈ " (124mm), straight
105-089	4 ⁷ / ₈ " (124mm), curved

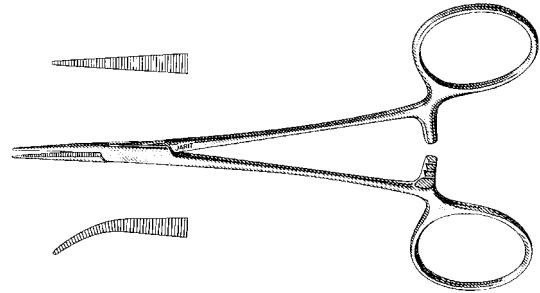

Petit-Point Jacobson Mosquito Forceps

Catalog #	Description
105-092	7 ¹ / ₄ " (185mm), slightly curved
105-093	7 ¹ / ₄ " (185mm), fully curved



Petit-Point Mosquito Forceps

Catalog #	Description
105-090	3 ⁷ / ₈ " (100mm), straight
105-091	3 ⁷ / ₈ " (100mm), curved
105-095	4 ³ / ₄ " (120mm), straight
105-096	4 ³ / ₄ " (120mm), curved

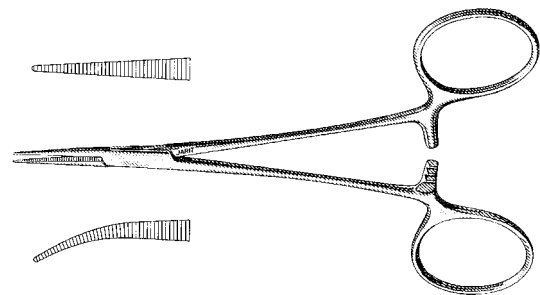

Petit-Point Mosquito Forceps

Catalog #	Description
105-098	6" (152mm), straight
105-099	6" (152mm), curved

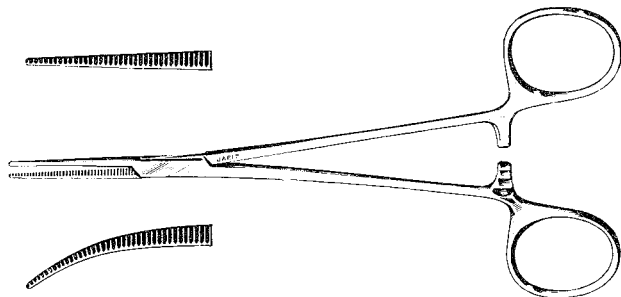

Petit-Point Mosquito Forceps

Catalog #	Description
285-107	7¼" (184mm), straight
285-108	7¼" (184mm), curved

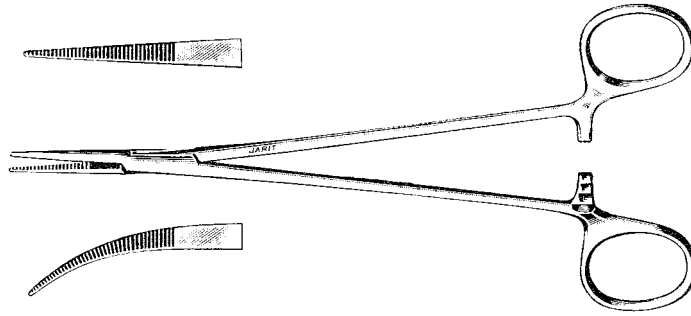

Petit-Point Crile Forceps

Catalog #	Description
105-118	5⅝" (143mm), straight
105-119	5⅝" (143mm), curved

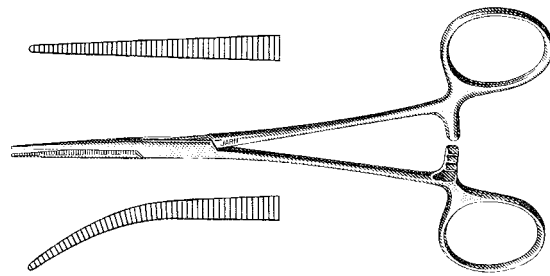

Petit-Point Pean Forceps

Catalog #	Description
105-163	5½" (140mm), straight
105-164	5½" (140mm), curved

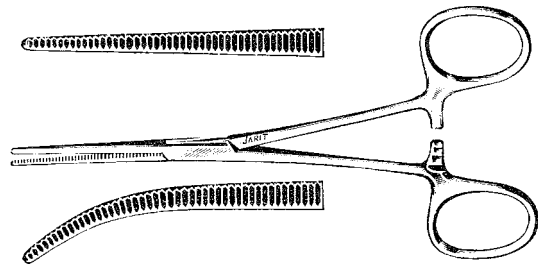

Petit-Point Ochsner Forceps

Catalog #	Description
105-233	5½" (140mm), straight
105-234	5½" (140mm), curved

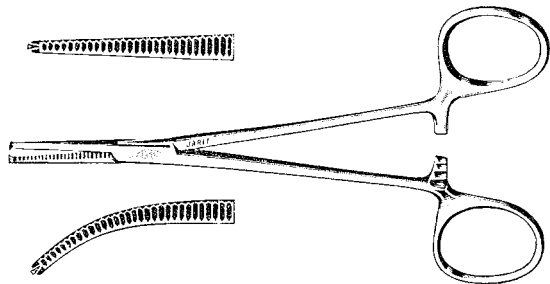

Petit-Point Reynolds Scissors, Carb-Edge

Catalog #	Description
101-255	5 1/8" (130mm), curved blades, one blade serrated

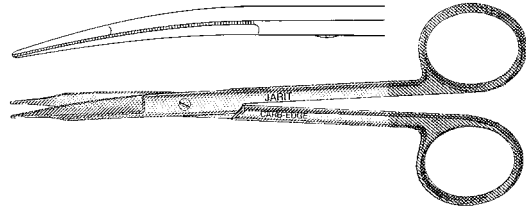

Petit-Point Olsen-Hegar Needle Holder/Scissors delicate

Catalog #	Description
120-148	4 3/4" (120mm), serrated
120-149	4 3/4" (120mm), smooth

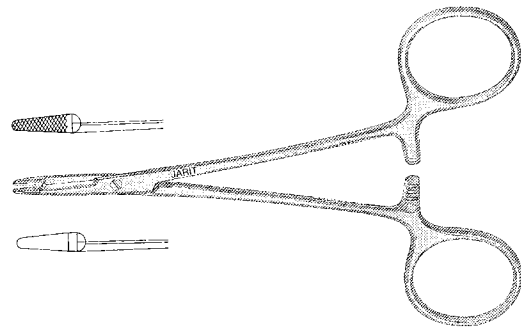

Petit-Point Olsen-Hegar Needle Holder/Scissors, Carb-Bite
7000 teeth per square inch, for use with 6.0, 7.0 and 8.0 suture

Catalog #	Description
121-148	4 3/4" (120mm), delicate, serrated
121-149	4 3/4" (120mm), delicate, smooth

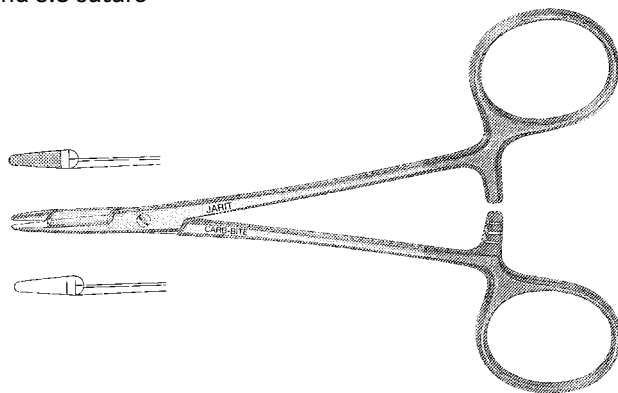

Petit-Point Ryder Needle Holders, Carb-Bite

7000 teeth per square inch, for use with 4.0, 5.0 and 6.0 suture serrated jaws

Catalog #	Description
121-170	4 ⁷ / ₈ " (124mm)
121-172	6 ¹ / ₄ " (156mm)
121-174	7" (176mm)
121-176	7 ³ / ₄ " (200mm)
121-177	9" (228mm)

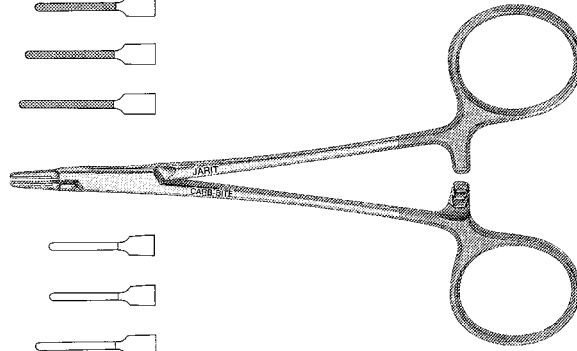
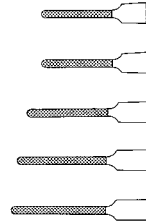

Petit-Point Ryder Needle Holders, Carb-Bite

smooth jaws, for use with 4.0, 5.0 and 6.0 suture

Catalog #	Description
121-171	4 ⁷ / ₈ " (124mm)
121-173	6 ¹ / ₄ " (156mm)
121-175	7" (176mm)
121-179	7 ³ / ₄ " (200mm)
121-178	9" (228mm)

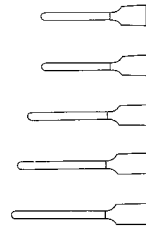

Petit-Point Sarot Needle Holders, Carb-Bite

4000 teeth per square inch, for use with 5.0 and 6.0 suture

Catalog #	Description
121-197	5 ⁷ / ₈ " (150mm), delicate
121-198	6 ³ / ₄ " (169mm), delicate

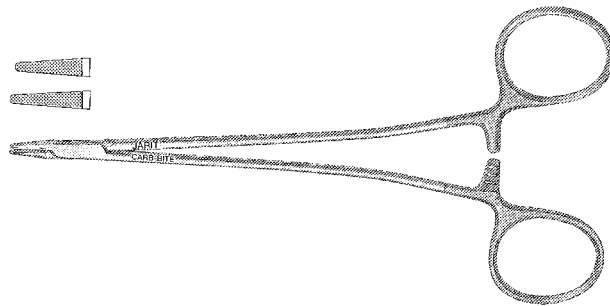

Petit-Point Allis Tissue Forceps

Catalog #	Description
135-095	5 1/8" (130mm), 4 x 5 teeth, 3mm wide jaws

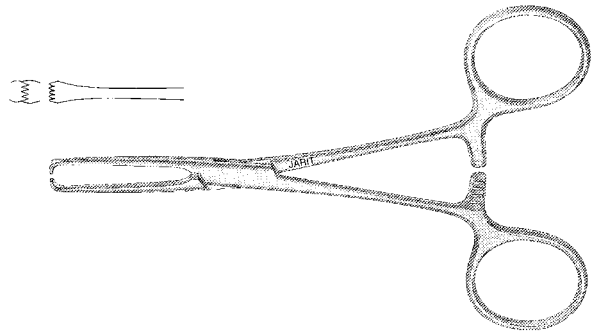

Petit-Point Babcock Forceps

Catalog #	Description
135-179	5 7/8" (148mm), jaw width 5.6mm
135-180	6" (155mm), jaw width 7.5mm

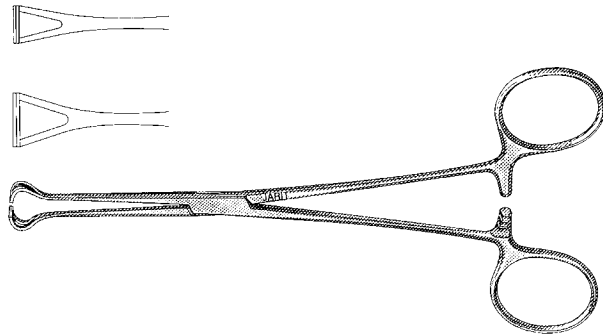

Petit-Point Mixer Forceps

Catalog #	Description
140-218	5 3/8" (137mm)

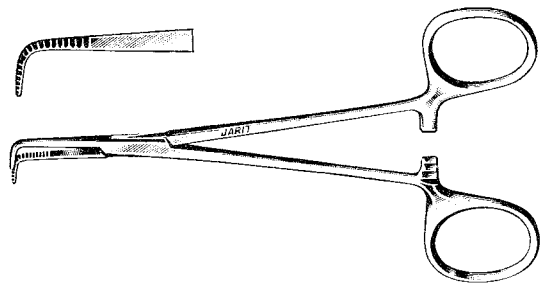

Petit-Point Mixer Forceps

Catalog #	Description
140-223	7 1/4" (185mm)

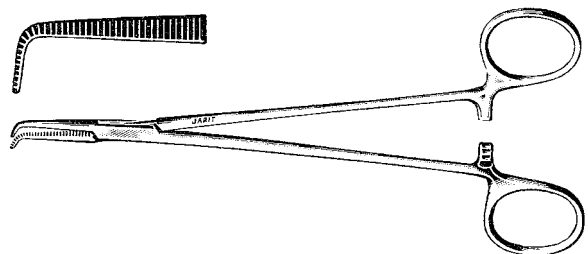

Halstead Mosquito Forceps, (Mirror Finish)

Manufactured from high grade German surgical stainless steel which is ground and polished to a mirror finish

Catalog #	Description
105-100	5" (127mm), straight
105-102	5" (127mm), curved

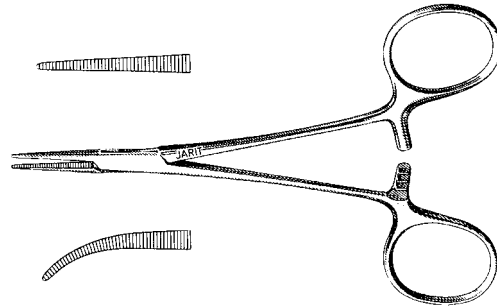

Halstead Mosquito Forceps, (Satin Finish)

Manufactured from high grade German surgical stainless steel which is ground and polished to a satin finish

Catalog #	Description
106-100	5" (127mm), straight
106-102	5" (127mm), curved

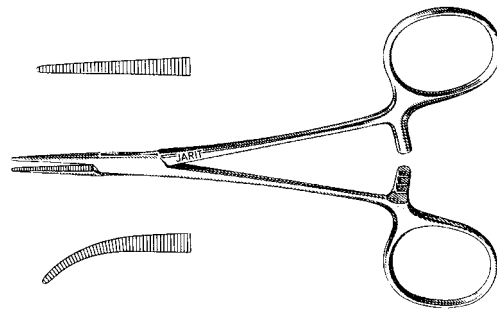

Halstead Mosquito Forceps, (Matte Finish)

Manufactured from high grade German surgical stainless steel which is glass beaded to a matte finish

Catalog #	Description
107-100	5" (127mm), straight
107-102	5" (127mm), curved

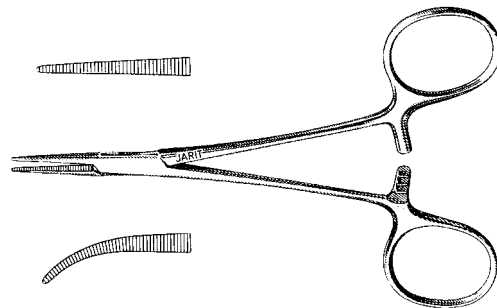

Halstead Mosquito Forceps

Catalog #	Description
105-105	4¾" (121mm), angled

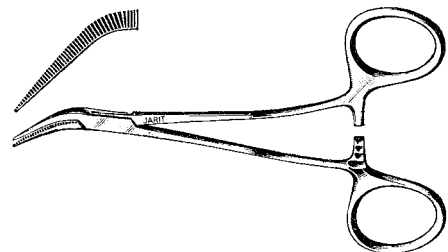

Halstead Mosquito Forceps

1 x 2 teeth

Catalog #	Description
105-110	4 ⁷ / ₈ " (124mm), straight
105-112	4 ⁷ / ₈ " (124mm), curved

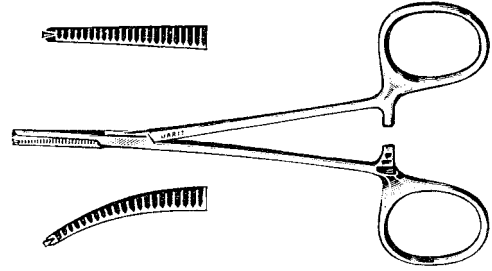

Hartman Mosquito Forceps, (Mirror Finish)

Manufactured from high grade German surgical stainless steel which is ground and polished to a mirror finish

Catalog #	Description
105-114	3 ⁷ / ₈ " (100mm), straight
105-115	3 ⁷ / ₈ " (100mm), curved

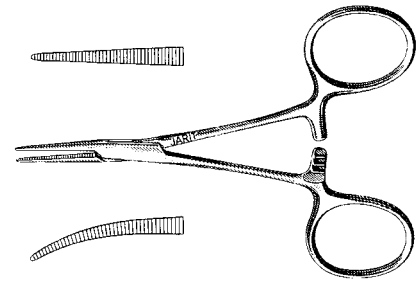

Hartman Mosquito Forceps, (Matte Finish)

Manufactured from high grade German surgical stainless steel which is glass beaded to a matte finish

Catalog #	Description
107-114	3 ⁷ / ₈ " (100mm), straight
107-115	3 ⁷ / ₈ " (100mm), curved

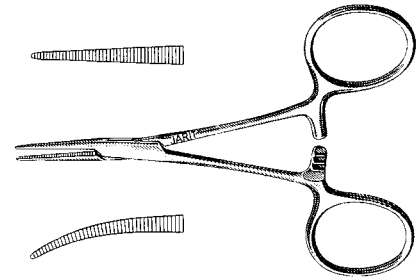

Crile Artery Forceps, (Mirror Finish)

Manufactured from high grade German surgical stainless steel which is ground and polished to a mirror finish

Catalog #	Description
105-120	5½" (140mm), straight
105-121	5½" (140mm), curved
105-140	6¼" (159mm), straight
105-141	6¼" (159mm), curved

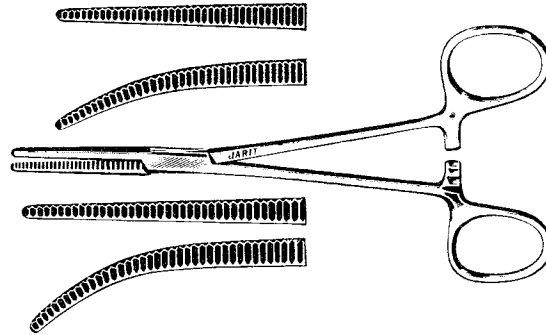

Crile Artery Forceps, (Satin Finish)

Manufactured from high grade German surgical stainless steel which is ground and polished to a satin finish

Catalog #	Description
106-120	5½" (140mm), straight
106-121	5½" (140mm), curved
106-140	6¼" (159mm), straight
106-141	6¼" (159mm), curved

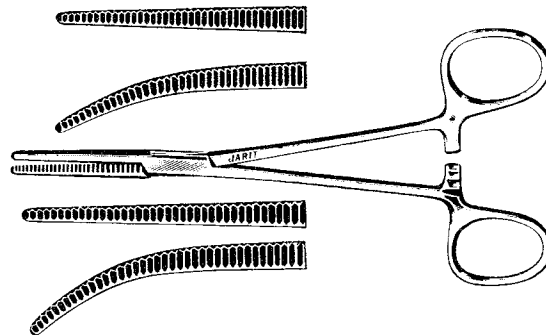

Crile Artery Forceps, (Matte Finish)

Manufactured from high grade German surgical stainless steel which is glass beaded to a matte finish

Catalog #	Description
107-120	5½" (140mm), straight
107-121	5½" (140mm), curved
107-140	6¼" (159mm), straight
107-141	6¼" (159mm), curved

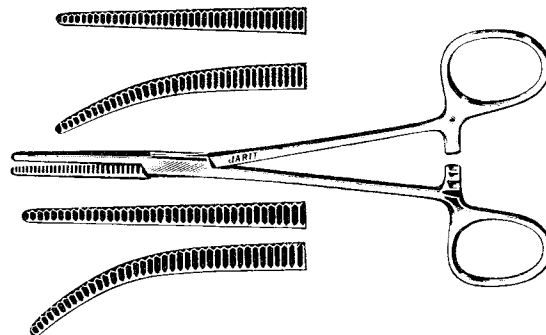

Kelly Artery Forceps, (Mirror Finish)

Manufactured from high grade German surgical stainless steel which is ground and polished to a mirror finish

Catalog #	Description
105-130	5½" (140mm), straight
105-131	5½" (140mm), curved

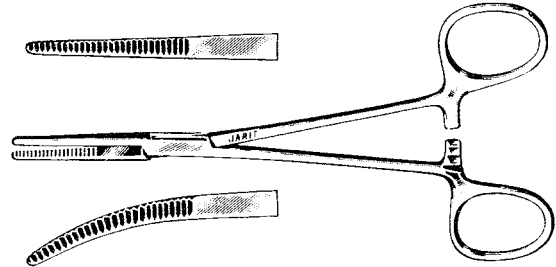

Kelly Artery Forceps, (Satin Finish)

Manufactured from high grade German surgical stainless steel which is ground and polished to a satin finish

Catalog #	Description
106-130	5½" (140mm), straight
106-131	5½" (140mm), curved

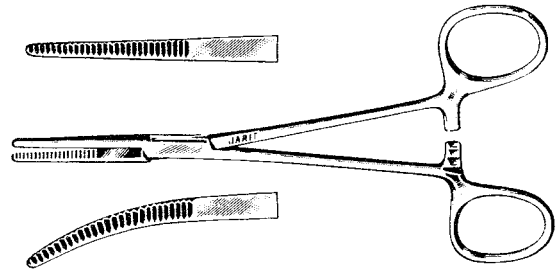

Kelly Artery Forceps, (Matte Finish)

Manufactured from high grade German surgical stainless steel which is glass beaded to a matte finish

Catalog #	Description
107-130	5½" (140mm), straight
107-131	5½" (140mm), curved

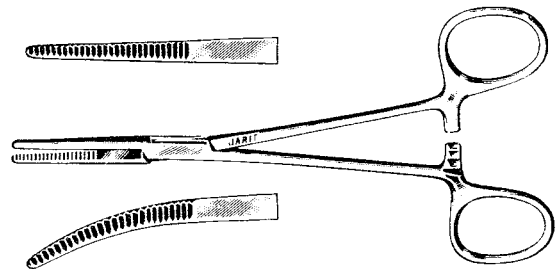

Coller-Crile Forceps

fine tapered tips, mirror finish

Catalog #	Description
105-142	5⅝" (143mm), straight
105-143	6¼" (160mm), straight
105-144	5⅝" (143mm), curved
105-145	6¼" (160mm), curved

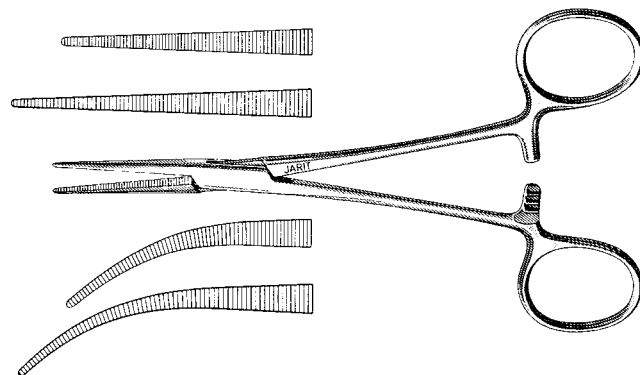

Rankin Artery Forceps, (Mirror Finish)

Manufactured from high grade German surgical stainless steel which is ground and polished to a mirror finish

Catalog #	Description
105-150	6¼" (159mm), straight
105-151	6¼" (159mm), curved

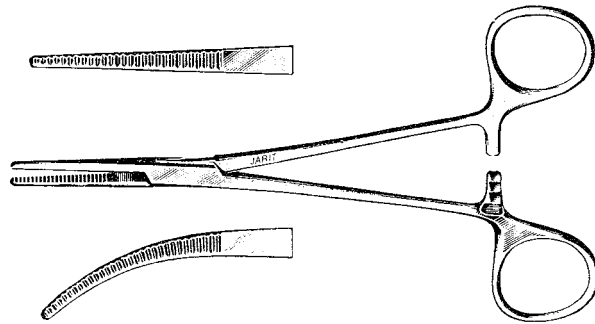

Rankin Artery Forceps, (Satin Finish)

Manufactured from high grade German surgical stainless steel which is ground and polished to a satin finish

Catalog #	Description
106-150	6¼" (159mm), straight
106-151	6¼" (159mm), curved

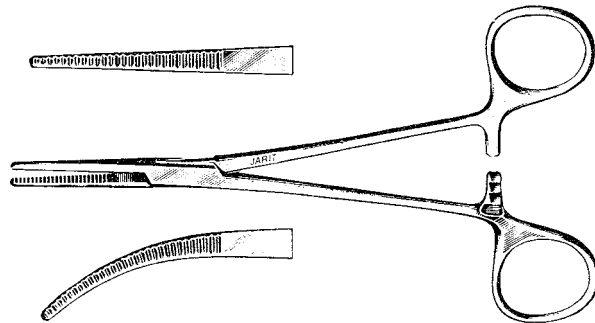

Providence Hospital Forceps

Catalog #	Description
105-160	5⅝" (144mm), straight
105-161	5⅝" (144mm), curved

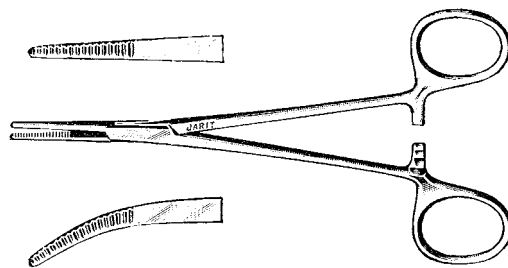

Rochester-Pean Artery Forceps, (Mirror Finish)

Manufactured from high grade German surgical stainless steel which is ground and polished to a mirror finish

Catalog #	Description
105-168	5½" (140mm), straight
105-169	5½" (140mm), curved
105-170	6½" (165mm), straight
105-171	6½" (165mm), curved
105-180	7¼" (184mm), straight
105-181	7¼" (184mm), curved
105-190	8" (203mm), straight
105-191	8" (203mm), curved
105-195	8¾" (221mm), straight
105-196	8¾" (221mm), curved
105-197	10" (254mm), straight
105-198	11" (279mm), straight
105-199	12" (305mm), straight

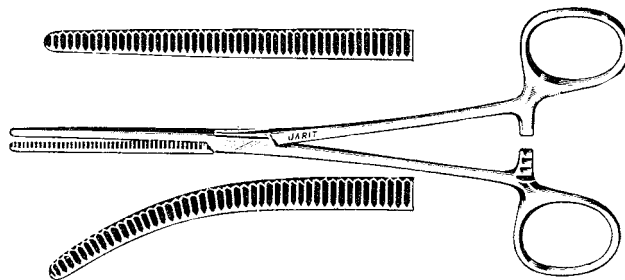

Rochester-Pean Artery Forceps, (Satin Finish)

Manufactured from high grade German surgical stainless steel which is ground and polished to a satin finish

Catalog #	Description
106-168	5½" (140mm), straight
106-169	5½" (140mm), curved
106-170	6½" (165mm), straight
106-171	6½" (165mm), curved
106-180	7¼" (184mm), straight
106-181	7¼" (184mm), curved
106-190	8" (203mm), straight
106-191	8" (203mm), curved
106-195	8¾" (221mm), straight
106-196	8¾" (221mm), curved

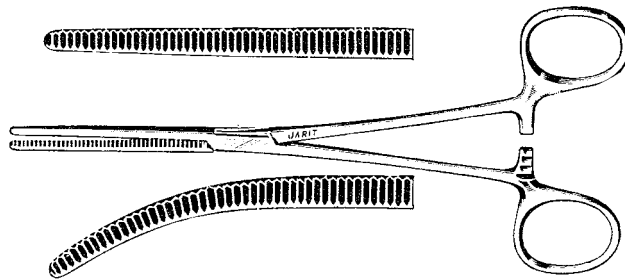

Rochester-Pean Artery Forceps, (Matte Finish)

Manufactured from high grade German surgical stainless steel which is glass beaded to a matte finish

Catalog #	Description
107-170	6½" (165mm), straight
107-171	6½" (165mm), curved
107-180	7¼" (184mm), straight
107-181	7¼" (184mm), curved
107-190	8" (203mm), straight
107-191	8" (203mm), curved

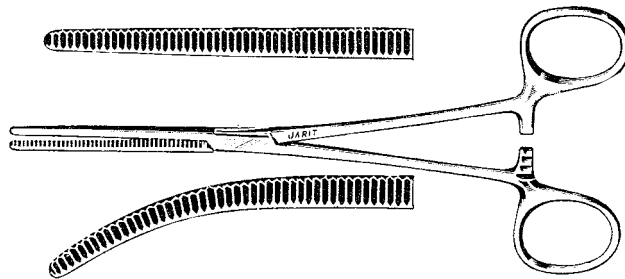

Rochester-Ochsner Artery Forceps, (Mirror Finish)

Manufactured from high grade German surgical stainless steel which is ground and polished to a mirror finish

Catalog #	Description
105-200	6¼" (159mm), straight
105-202	6¼" (159mm), curved
105-210	7¼" (184mm), straight
105-212	7¼" (184mm), curved
105-220	7¾" (200mm), straight
105-222	7¾" (200mm), curved
105-223	8¾" (225mm), straight
105-224	8¾" (225mm), curved
105-225	10½" (265mm), straight
105-226	10½" (265mm), curved
105-227	11" (279mm), straight
105-229	12" (305mm), straight
105-228	14" (356mm), straight

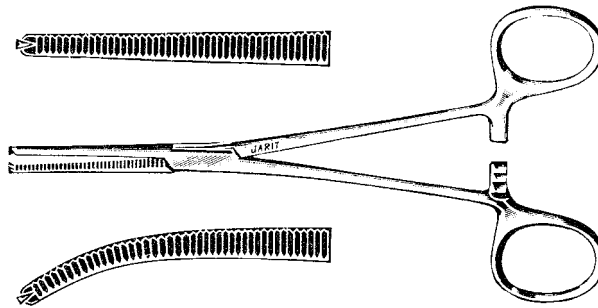

Rochester-Ochsner Artery Forceps, (Satin Finish)

Manufactured from high grade German surgical stainless steel which is ground and polished to a satin finish

Catalog #	Description
106-200	6¼" (159mm), straight
106-202	6¼" (159mm), curved
106-210	7¼" (184mm), straight
106-212	7¼" (184mm), curved
106-220	7¾" (200mm), straight
106-222	7¾" (200mm), curved

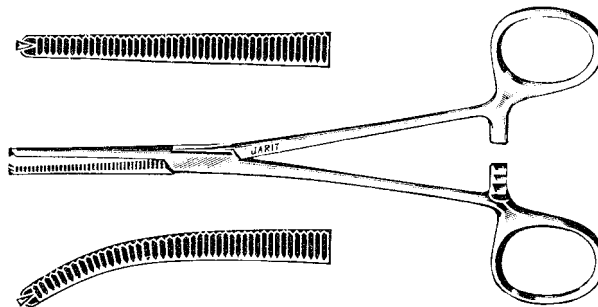

Rochester-Ochsner Artery Forceps, (Matte Finish)

Manufactured from high grade German surgical stainless steel which is glass beaded to a matte finish

Catalog #	Description
107-200	6¼" (159mm), straight
107-210	7¼" (184mm), straight
107-220	7¾" (200mm), straight

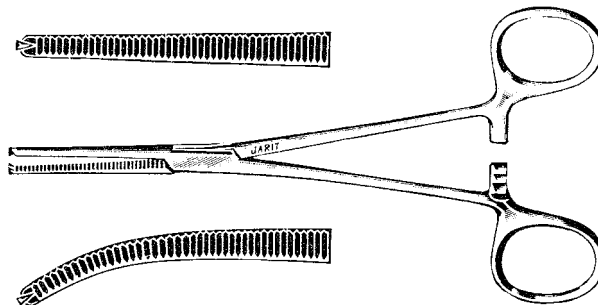

Kocher Artery Forceps, (Mirror Finish)

Manufactured from high grade German surgical stainless steel which is ground and polished to a mirror finish

Catalog #	Description
105-230	5½" (140mm), straight
105-232	5½" (140mm), curved

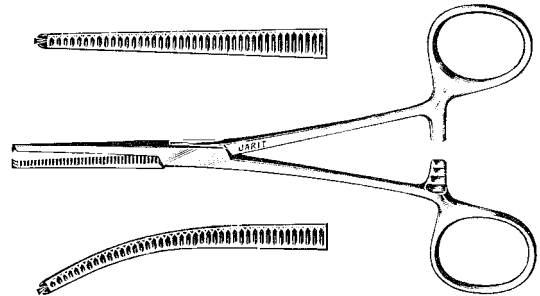

Kocher Artery Forceps, (Satin Finish)

Manufactured from high grade German surgical stainless steel which is ground and polished to a satin finish

Catalog #	Description
106-230	5½" (140mm), straight
106-232	5½" (140mm), curved

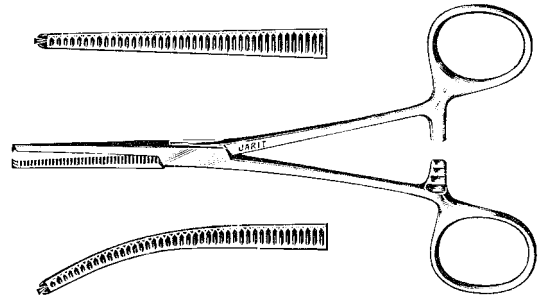

Rochester-Carmalt Forceps

Catalog #	Description
105-240	6½" (165mm), straight
105-242	6½" (165mm), curved
105-243	8" (205mm), straight
105-245	8" (205mm), curved

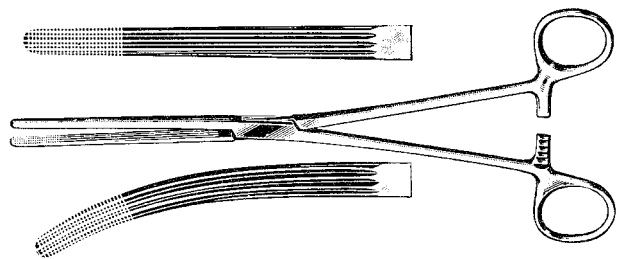

Jones Forceps

Catalog #	Description
105-250	5⅞" (131mm), straight
105-251	5⅞" (131mm), curved

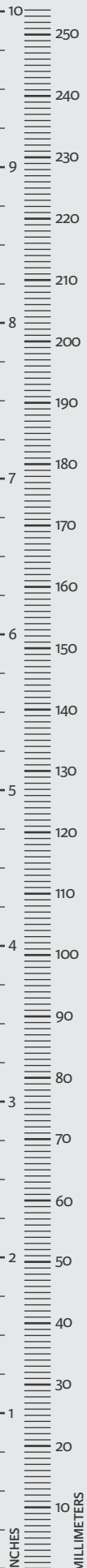
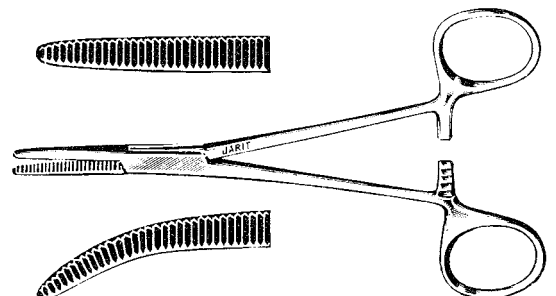

Pratt-Smith T-Clamp

Catalog #	Description
105-255	5 ⁷ / ₈ " (150mm)

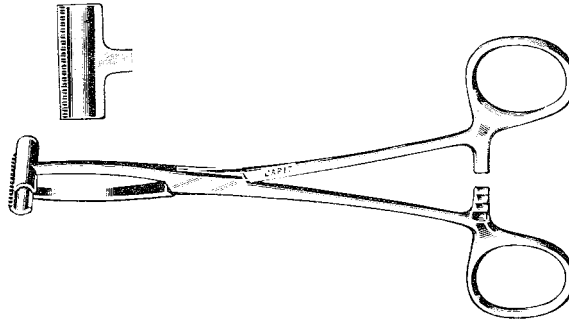

Diffenbach Serrefines Forceps

Catalog #	Description
105-260	1 ¹ / ₂ " (37mm), straight
105-261	1 ¹ / ₂ " (37mm), curved
105-262	2 ³ / ₈ " (59mm), straight
105-263	2 ³ / ₈ " (59mm), curved

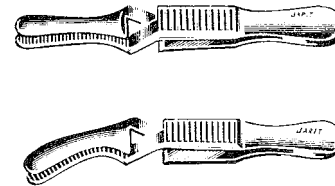

Ferguson Angiotribes

Catalog #	Description
105-270	6 ¹ / ₂ " (163mm), straight
105-271	6 ¹ / ₂ " (163mm), curved

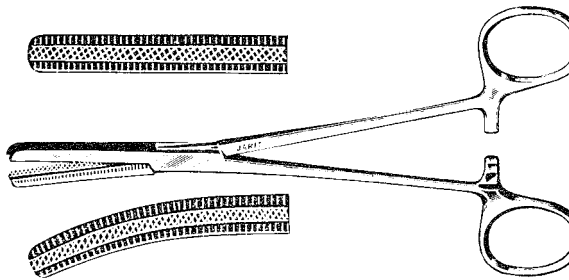

Bainbridge Forceps, Longitudinal Serrations

Catalog #	Description
105-300	5 ⁷ / ₈ " (150mm), straight, 40mm jaws
105-302	5 ⁷ / ₈ " (150mm), curved, 40mm jaws
105-304	7 ¹ / ₄ " (185mm), straight, 60mm jaws
105-306	7 ¹ / ₄ " (185mm), curved, 60mm jaws

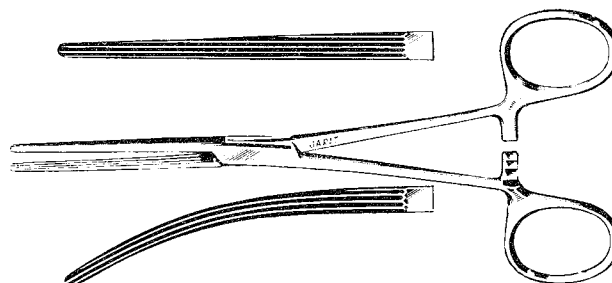

Bainbridge Forceps

DeBakey serrations

Catalog #	Description
320-228	8" (203mm), straight, delicate, 63mm jaws
320-229	8" (203mm), curved, delicate, 61mm jaws



Pennington Forceps

Catalog #	Description
105-320	6 1/4" (156mm), 11mm triangular jaws

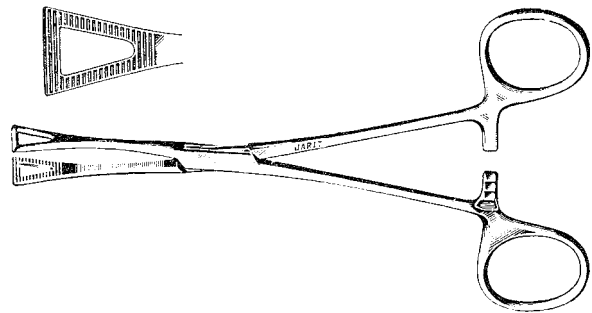

Coller Artery Forceps, Full Horizontal Serrations

Catalog #	Description
105-330	Curved, 9 1/4" (238mm)
105-331	Strong curve, 9 1/4" (234mm)
105-332	Right angle, 8 3/4" (225mm)



Storey Artery Forceps, Cross Serrations

Catalog #	Description
105-340	Slight curve, 8 3/4" (222mm)
105-341	Strong curve, 8 3/4" (222mm)
105-342	Right angle, 8 1/2" (214mm)



Backhaus Towel Forceps, (Mirror Finish)

Manufactured from high grade German surgical stainless steel which is ground and polished to a mirror finish

Catalog #	Description
110-100	3½" (89mm)
110-102	5¼" (133mm)

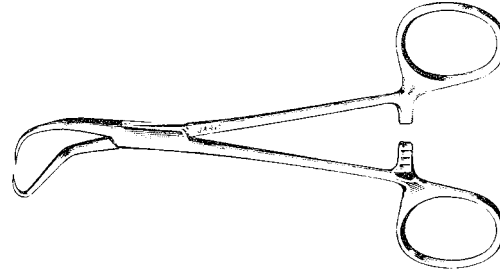

Backhaus Towel Forceps, (Satin Finish)

Manufactured from high grade German surgical stainless steel which is ground and polished to a satin finish

Catalog #	Description
111-100	3½" (89mm)
111-102	5¼" (133mm)

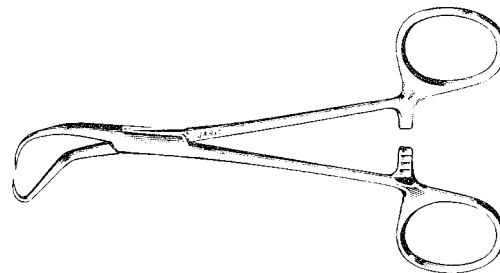

Backhaus Towel Forceps, (Matte Finish)

Manufactured from high grade German surgical stainless steel which is glass beaded to a matte finish

Catalog #	Description
109-100	3½" (89mm)
109-102	5¼" (133mm)

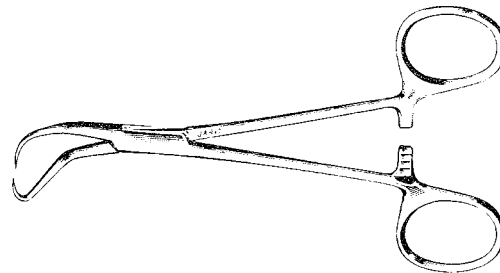

Roeder Towel Forceps

Catalog #	Description
110-105	5¾" (135mm)

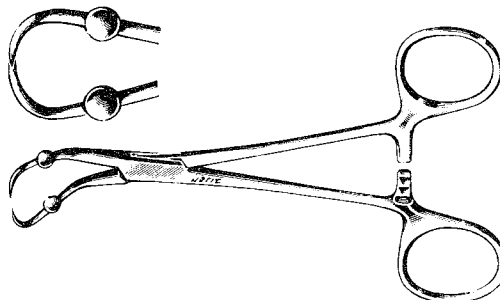

Jones Towel Forceps

cross-action

Catalog #	Description
110-110	3 ³ / ₈ " (86mm)
110-111	2 ¹ / ₄ " (56mm)

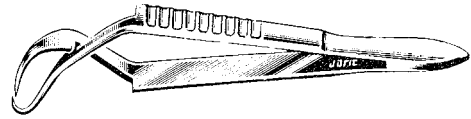

Non-Perforating Towel Forceps

Catalog #	Description
110-117	4" (102mm)
110-118	5 ¹ / ₄ " (132mm)

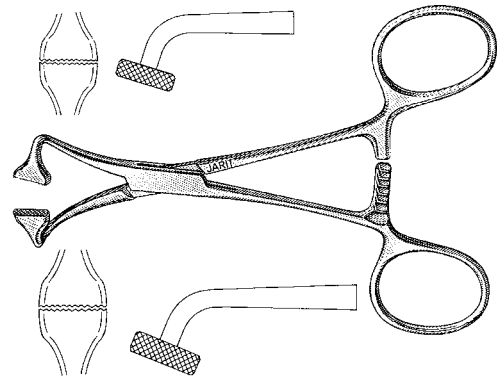

Edna Towel Forceps, (Mirror Finish)

Manufactured from high grade German surgical stainless steel which is ground and polished to a mirror finish

Catalog #	Description
110-119	3¾" (96mm)
110-120	5¼" (133mm)

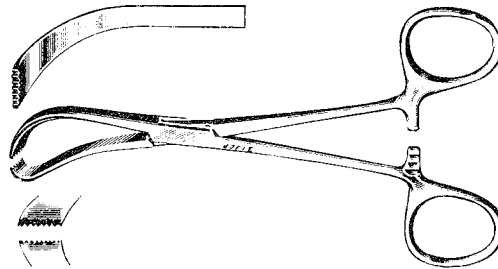

Edna Towel Forceps, (Matte Finish)

Manufactured from high grade German surgical stainless steel which is glass beaded to a matte finish

Catalog #	Description
109-119	3¾" (96mm)
109-120	5¼" (133mm)

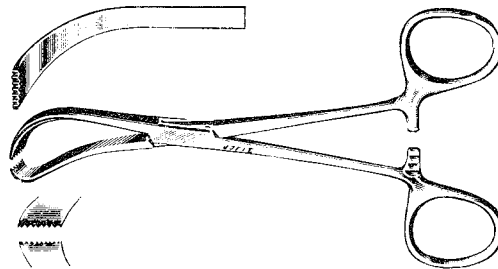

Peers Towel Forceps

Catalog #	Description
110-121	5⅝" (144mm)

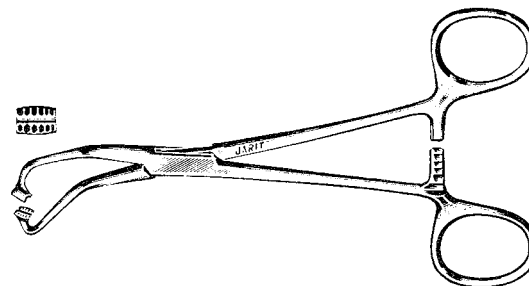

Presbyterian Hospital Tube Occluding Forceps

Catalog #	Description
110-150	6½" (165mm)

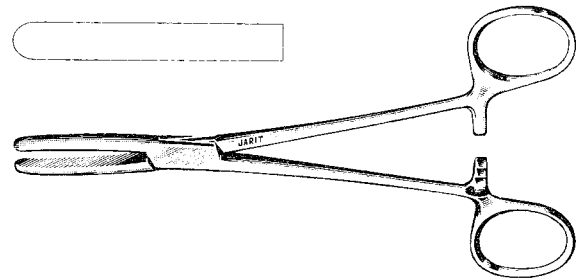

Tube Occluding Forceps

delicate jaws with smooth inner surfaces, beveled edges

Catalog #	Description
110-154	5¾" (145mm)

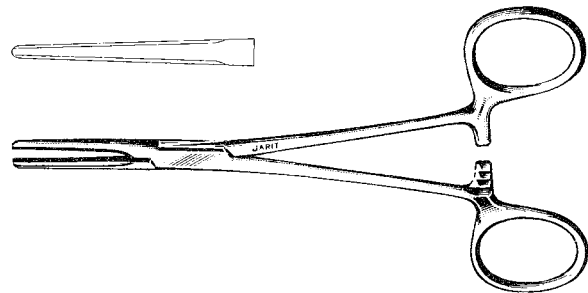

Vorse Tube Occluding Forceps

Catalog #	Description
110-155	6" (154mm)
110-157	7½" (189mm)
110-159	8" (204mm), heavy jaw

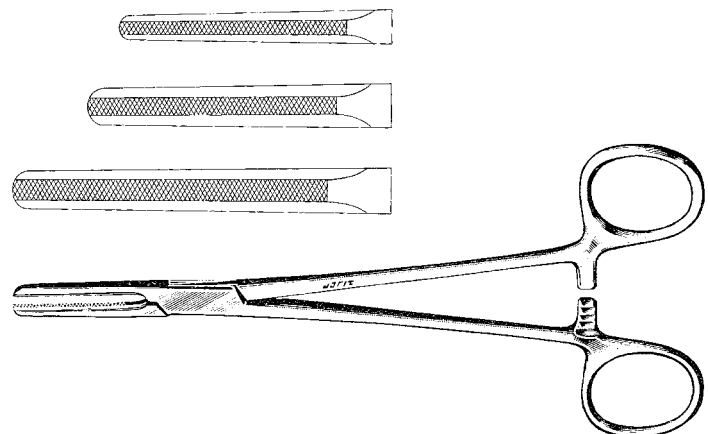

Tube Occluding Forceps w/U-Shaped Guard

Catalog #	Description
110-160	6" (154mm)
110-161	7½" (189mm)
110-162	8" (204mm), heavy jaw

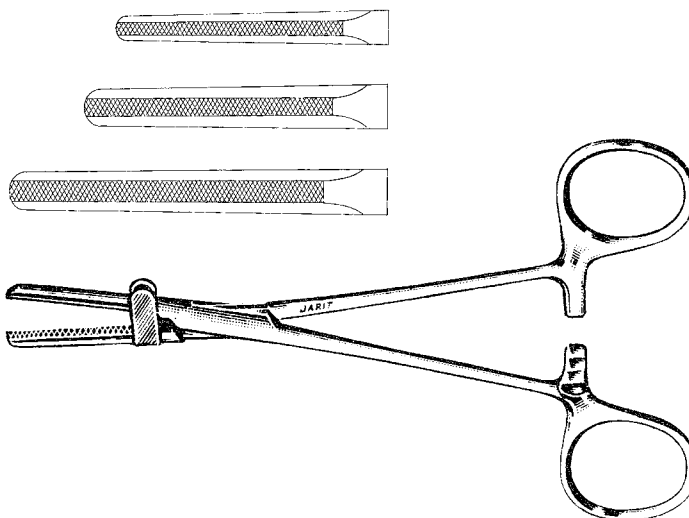

Safety Blade Remover

Catalog #	Description
110-164	Safety Blade Remover



Knife Handle #3, with MM and CM Scale, (Satin Finish)

holds blades 10, 11, 12, 15

Manufactured from high grade German surgical stainless steel which is ground and polished to a satin finish

Catalog #	Description
110-165	4 ⁷ / ₈ " (125mm)



Knife Handle #3, with MM and CM Scale, (Matte Finish)

holds blades 10, 11, 12, 15

Manufactured from high grade German surgical stainless steel which is glass beaded to a matte finish

Catalog #	Description
110-175	4 ⁷ / ₈ " (125mm)

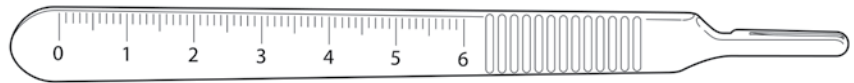

Knife Handle #4, with MM and CM Scale, (Satin Finish)

holds blades 20 thru 25

Manufactured from high grade German surgical stainless steel which is ground and polished to a satin finish

Catalog #	Description
110-167	5 ³ / ₈ " (135mm)

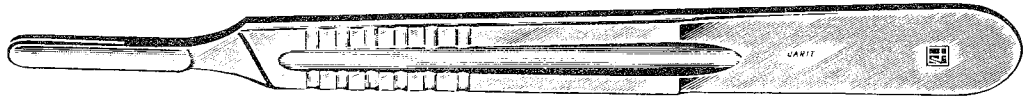

Knife Handle #4, with MM and CM Scale, (Matte Finish)

holds blades 20 thru 25

Manufactured from high grade German surgical stainless steel which is glass beaded to a matte finish

Catalog #	Description
110-176	5 ³ / ₈ " (135mm)



Supplied with mm and cm scale

Knife Handle #7, (Satin Finish)

holds blades 10, 11, 12, 15

Manufactured from high grade German surgical stainless steel which is ground and polished to a satin finish

Catalog #	Description
110-169	6½" (162mm)



Knife Handle #7, (Matte Finish)

holds blades 10, 11, 12, 15

Manufactured from high grade German surgical stainless steel which is glass beaded to a matte finish

Catalog #	Description
110-177	6½" (162mm)



Knife Handle #3L, (Satin Finish)

for deep surgery

holds blades 10, 11, 10, 15

Manufactured from high grade German surgical stainless steel which is ground and polished to a satin finish

Catalog #	Description
110-170	8¼" (212mm)



Knife Handle #3L, (Matte Finish)

for deep surgery

holds blades 10, 11, 12, 15

Manufactured from high grade German surgical stainless steel which is glass beaded to a matte finish

Catalog #	Description
110-178	8¼" (212mm)



Knife Handle #3LA

angled, for deep surgery
holds blades 10, 11, 12, 15

Catalog #	Description
110-171	8¼" (212mm), satin



Knife Handle #4L

for deep surgery
holds blades 20 thru 25

Catalog #	Description
110-173	8¼" (212mm)



Knife Handle #9 (7K)

holds blades 10, 11, 12, 15

Catalog #	Description
110-174	4¾" (120mm)



Barron Knife Handle

octagonal handle
holds blades 10, 11, 12, 15

Catalog #	Description
110-180	5½" (140mm)



Corwin Knife Handle

round knurled handle
holds blades 10, 11, 12, 15

Catalog #	Description
110-182	6" (152mm)

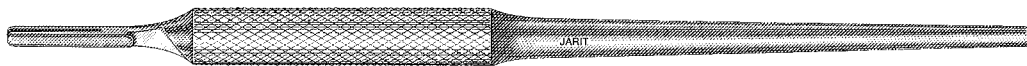

Knife Handle

round knurled handle
holds miniature blades (e.g. series 50, 60, 70)

Catalog #	Description
110-190	#3KS, 3 ⁵ / ₈ " (93mm)
110-191	#3KL, 5 ⁷ / ₈ " (150mm)
110-198	#3K/H replacement collet



Knife Handle

hexagonal handle
holds miniature blades (e.g. series 50, 60, 70)

Catalog #	Description
110-194	#3HS, 4 ¹ / ₈ " (106mm)
110-195	#3HL, 6 ¹ / ₄ " (157mm)
110-198	#3K/H replacement collet

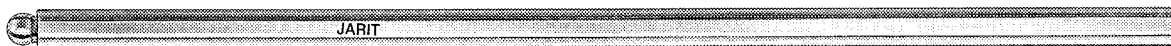

Foerster Sponge Holding Forceps, (Mirror Finish)

Manufactured from high grade German surgical stainless steel which is ground and polished to a mirror finish

Catalog #	Description
115-100	7" (178mm), straight, smooth
115-102	7" (178mm), straight, serrated
115-105	9½" (241mm), straight, smooth
115-107	9½" (241mm), straight, serrated
115-110	7" (178mm), curved, smooth
115-112	7" (178mm), curved, serrated
115-115	9½" (241mm), curved, smooth
115-117	9½" (241mm), curved, serrated

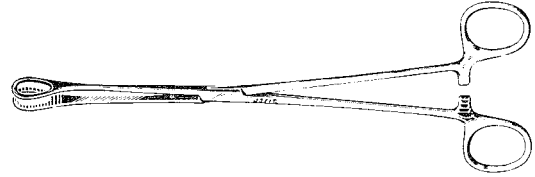

Foerster Sponge Holding Forceps, (Satin Finish)

Manufactured from high grade German surgical stainless steel which is ground and polished to a satin finish

Catalog #	Description
116-100	7" (178mm), straight, smooth
116-102	7" (178mm), straight, serrated
116-105	9½" (241mm), straight, smooth
116-107	9½" (241mm), straight, serrated
116-110	7" (178mm), curved, smooth
116-112	7" (178mm), curved, serrated
116-115	9½" (241mm), curved, smooth
116-117	9½" (241mm), curved, serrated

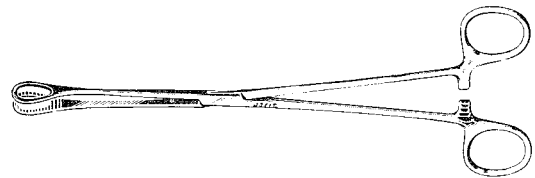

Foerster Sponge Holding Forceps, (Matte Finish)

Manufactured from high grade German surgical stainless steel which is glass beaded to a matte finish

Catalog #	Description
114-102	7" (178mm), straight, serrated
114-107	9½" (241mm), straight, serrated
114-124	14" (357mm), straight, serrated

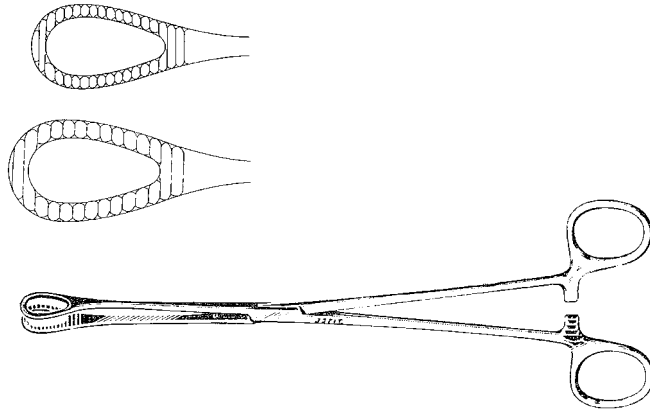

Fletcher Sponge Forceps

Catalog #	Description
115-119	9¾" (245mm), straight
115-120	9¾" (245mm), curved

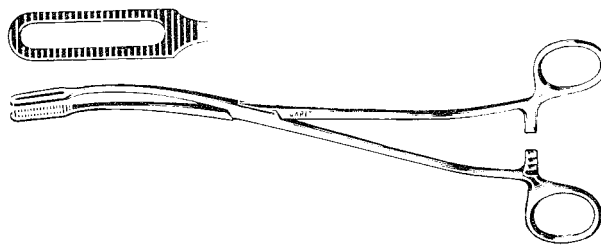

Converse Needle Holder

Catalog #	Description
120-090	4 ³ / ₈ " (112mm), large finger rings

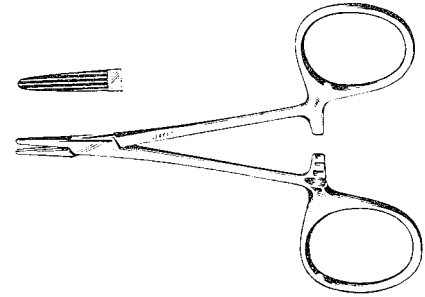

Brown Needle Holder

Catalog #	Description
120-095	5 ¹ / ₄ " (133mm), rounded jaws

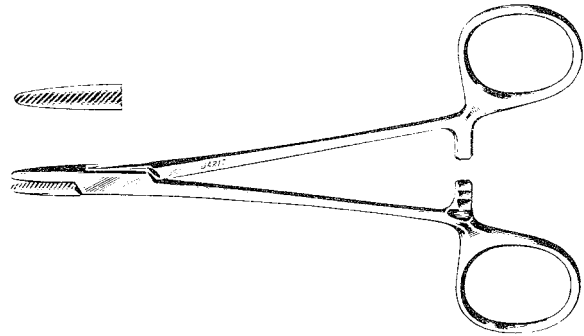

Neivert Needle Holder

Catalog #	Description
120-097	4 ⁷ / ₈ " (123mm), thumb ring turned up

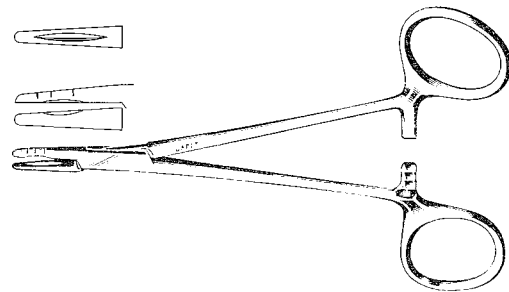

Derf Needle Holder

Catalog #	Description
120-100	4 ³ / ₄ " (120mm), grooved jaws

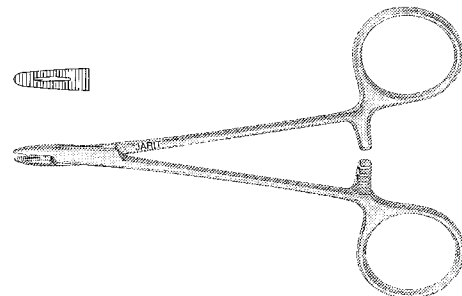

Baumgartner Needle Holder

Catalog #	Description
120-105	5¼" (133mm), solid jaws

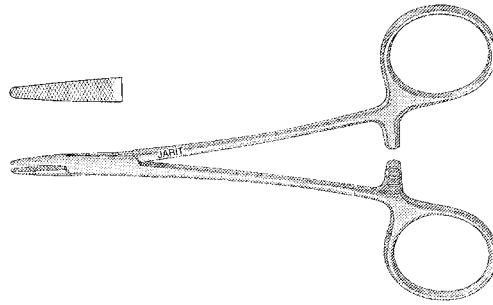

Baumgartner Needle Holder

Catalog #	Description
120-110	5¼" (133mm), grooved jaws

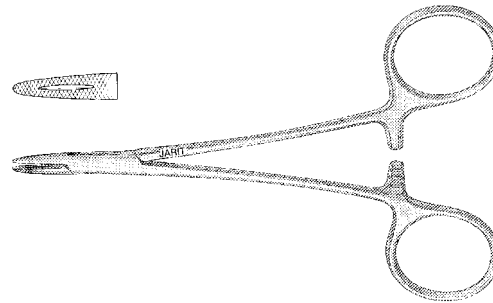

Hegar-Baumgartner Needle Holder

Catalog #	Description
120-112	5¾" (146mm), grooved jaws

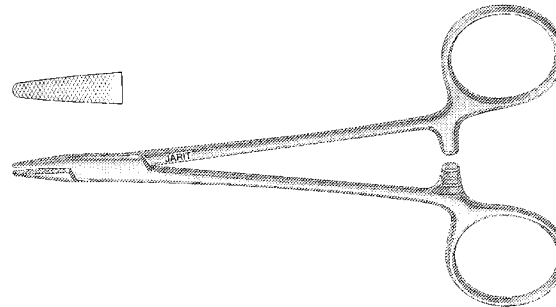

Collier Needle Holder

Catalog #	Description
120-115	5¾" (135mm), grooved jaws

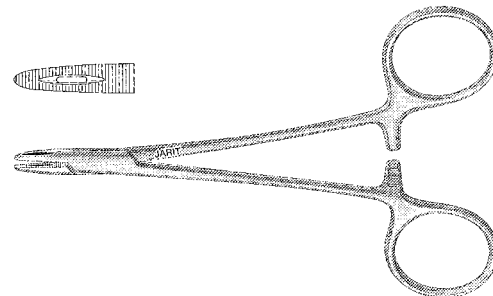

Webster Needle Holder

Catalog #	Description
120-118	4½" (115mm), smooth jaws

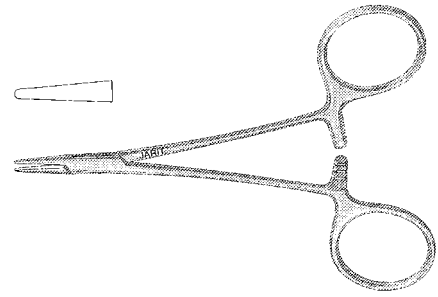

Halsey Needle Holder

Catalog #	Description
120-120	5¾" (135mm), smooth jaws

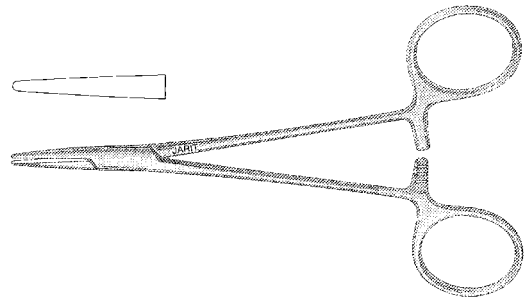

New Orleans Needle Holder, Grooved Jaw

Catalog #	Description
120-125	7" (180mm), grooved jaws

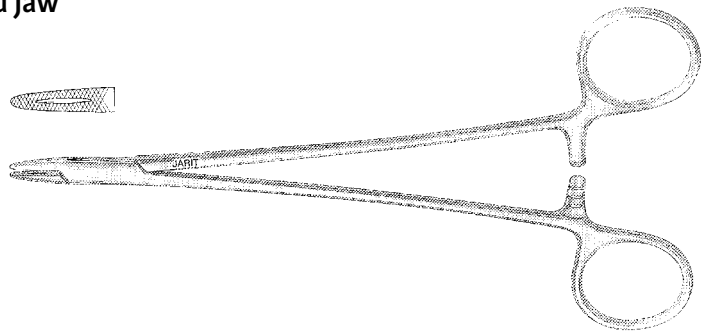

Crile-Wood Needle Holders, Grooved Jaw

Catalog #	Description
120-130	6" (152mm)
120-131	7¼" (183mm)
120-132	8" (206mm)

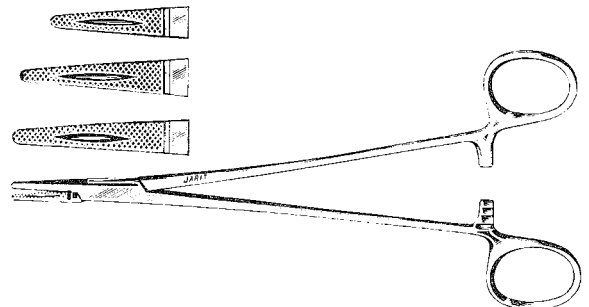

Mayo-Hegar Needle Holders, Grooved Jaw

Catalog #	Description
120-135	6¼" (160mm)
120-140	7½" (190mm)
120-145	8" (203mm)
120-147	12" (305mm)

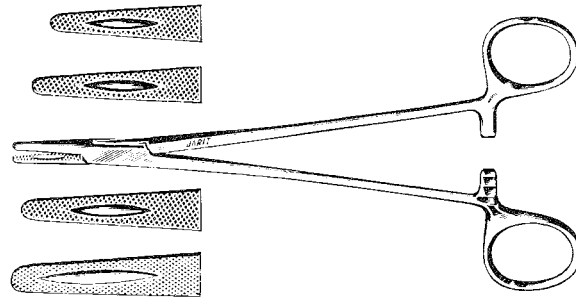

Petit-Point Olsen-Hegar Needle Holder/Scissors

Catalog #	Description
120-148	4¾" (120mm), delicate, serrated jaw
120-149	4¾" (120mm), delicate, smooth jaw

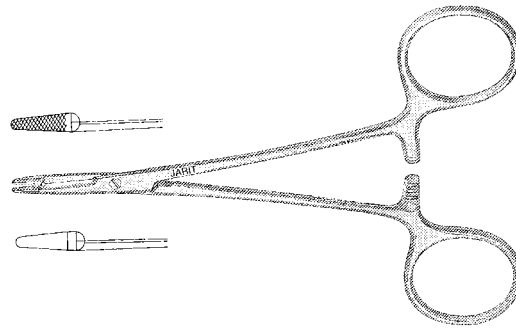

Olsen-Hegar Needle Holder/Scissors
grooved jaw

Catalog #	Description
120-150	5⅜" (138mm)
120-155	6¾" (170mm)

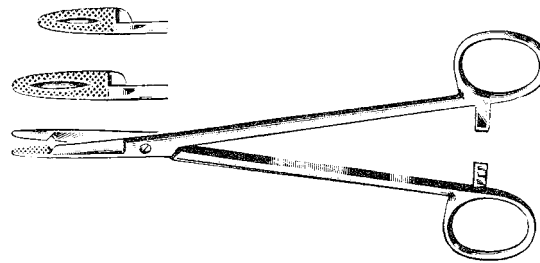

Masson Needle Holder

Catalog #	Description
120-180	10½" (268mm), solid jaws

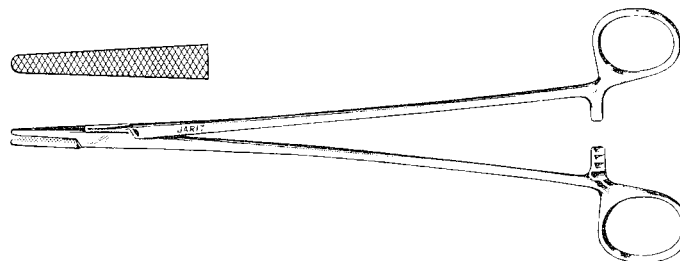

Sarot Needle Holder, Grooved Jaw

Catalog #	Description
120-200	7" (180mm), delicate, grooved jaws

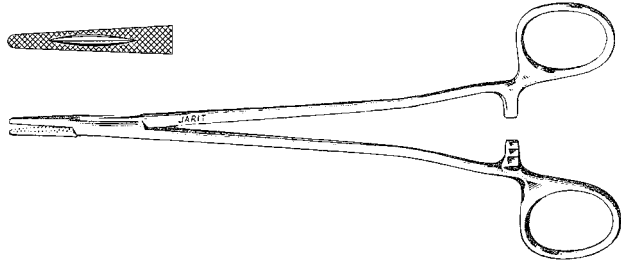

Heaney Needle Holder

Catalog #	Description
120-210	8" (205mm), curved, solid jaws

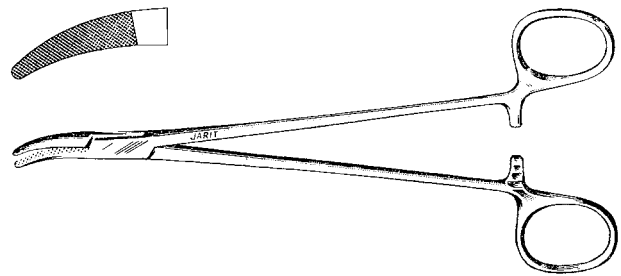

Bayonet Needle Holder

Catalog #	Description
120-215	6½" (168mm), rounded fine tapered jaws

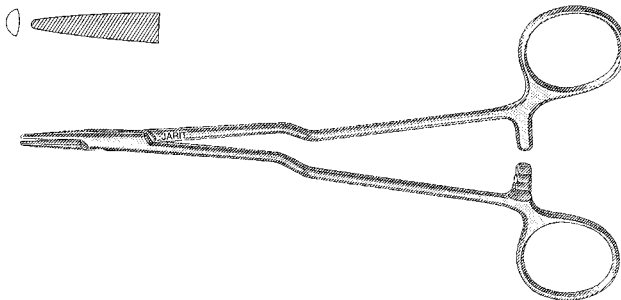

Carb-Bite™ Needle Holders

Jarit Carb-Bite Needle Holders feature jaw inserts of solid tungsten carbide. Sharply defined serrations have been milled into these inserts to provide a secure hold on the suture needle.

Because tungsten carbide is harder than stainless steel, the useful life of Carb-Bite Needle Holders exceeds that of ordinary needle holders. Jarit Carb-Bite Needle Holders are warranted for a minimum of three years of normal usage. If jaw serrations should wear smooth while under warranty, new Carb-Bite inserts will be installed without charge. Finger rings are gold plated for easy identification.



Neivert Needle Holder, Carb-Bite

4000 teeth per square inch, for use with 4.0 and 5.0 suture

Catalog #	Description
121-097	5" (126mm), thumb ring turned up

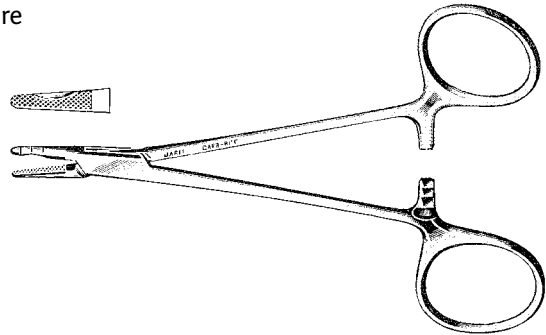

Derf Needle Holder, Carb-Bite

4000 teeth per square inch, for use with 4.0, 5.0, 6.0 suture

Catalog #	Description
121-100	4 3/4" (120mm)

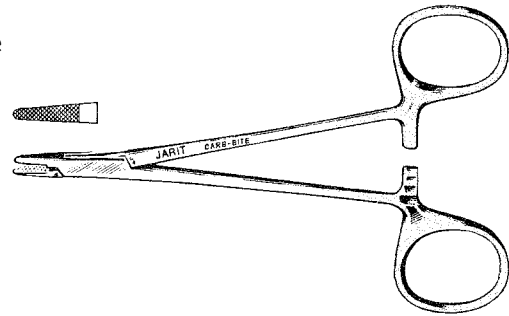

Baumgartner Needle Holder, Carb-Bite, (Satin Finish)

4000 teeth per square inch, for use with 2.0, 3.0, 4.0 suture

Manufactured from high grade German surgical stainless steel which is ground and polished to a satin finish

Catalog #	Description
121-105	5 1/4" (132mm)

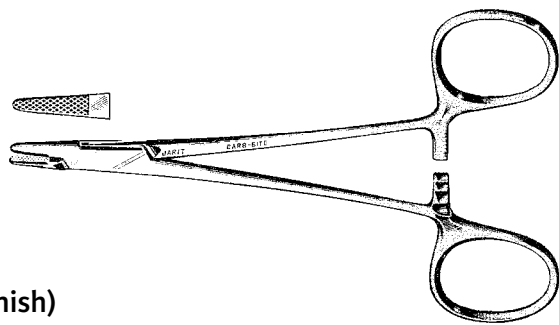

Baumgartner Needle Holder, Carb-Bite, (Matte Finish)

4000 teeth per square inch, for use with 2.0, 3.0, 4.0 suture

Manufactured from high grade German surgical stainless steel which is glass beaded to a matte finish

Catalog #	Description
123-105	5 1/4" (132mm)

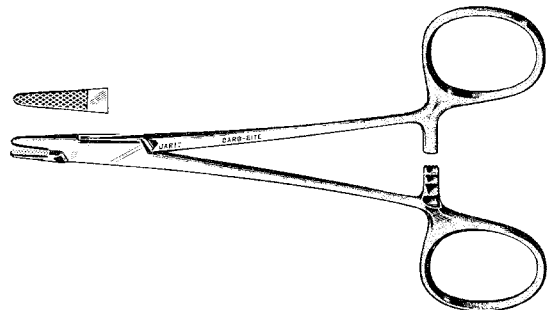

Hegar-Baumgartnere Needle Holder, Carb-Bite, (Satin Finish)

2500 teeth per square inch, for use with 2.0, 3.0, 4.0 suture
 Manufactured from high grade German surgical stainless steel which is ground and polished to a satin finish

Catalog #	Description
121-106	5¾" (147mm)

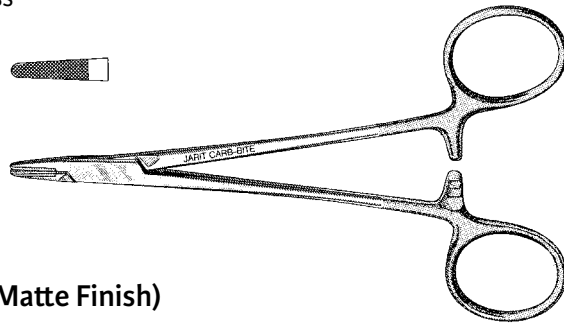

Hegar-Baumgartner Needle Holder, Carb-Bite, (Matte Finish)

2500 teeth per square inch, for use with 2.0, 3.0, 4.0 suture
 Manufactured from high grade German surgical stainless steel which is glass beaded to a matte finish

Catalog #	Description
123-106	5¾" (147mm)

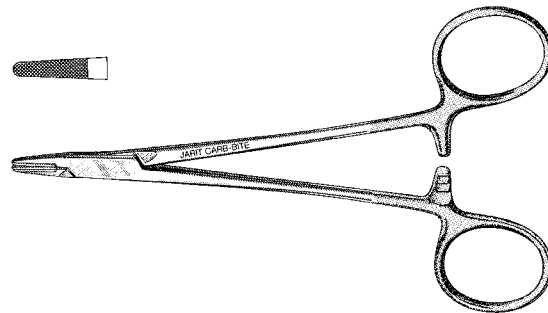

Par Style Plastic and Recon Needle Holders, Carb-Bite

7000 teeth per square inch, for use with 6.0, 7.0, 8.0 suture

Catalog #	Description
121-115	4⅝" (117mm), serrated
121-116	4⅝" (117mm), smooth

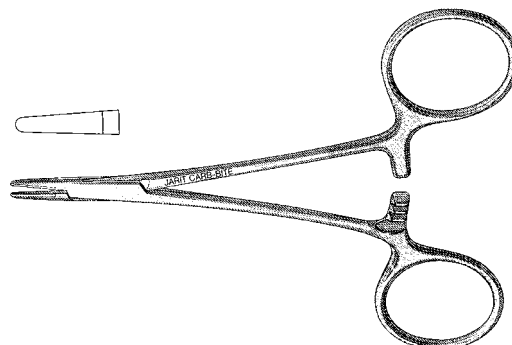
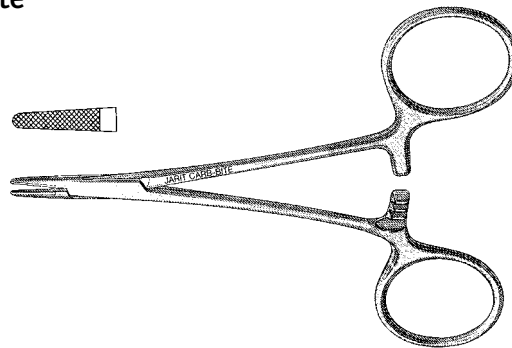

Webster Needle Holders, Carb-Bite

3600 teeth per square inch, for use with 5.0 and 6.0 suture

Catalog #	Description
121-119	4 ⁵ / ₈ " (118mm), serrated jaws
121-118	4 ⁵ / ₈ " (118mm), smooth jaws

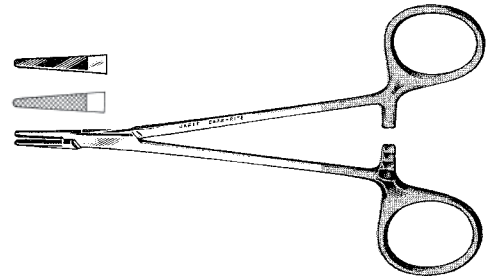

Halsey Needle Holder, Carb-Bite

for use with 4.0 and 5.0 suture

Catalog #	Description
121-120	5 ¹ / ₄ " (133mm), smooth

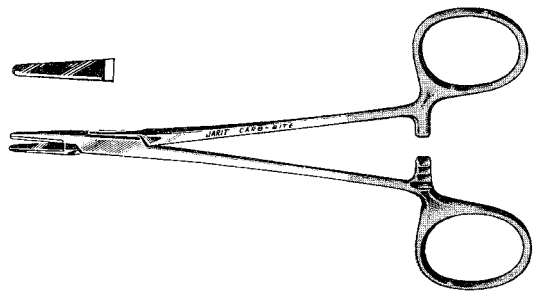

Halsey Needle Holders, Carb-Bite

4000 teeth per square inch, for use with 4.0 and 5.0 suture

Catalog #	Description
121-121	5 ¹ / ₄ " (133mm), serrated

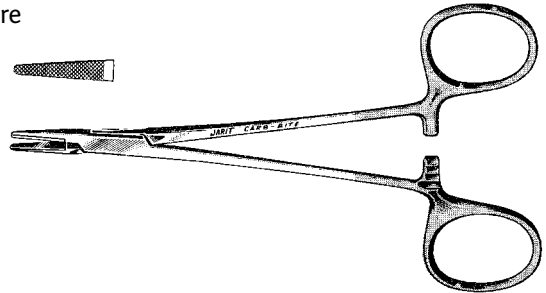

New Orleans Needle Holders, Carb-Bite

4000 teeth per square inch, for use with 2.0, 3.0, and 4.0 suture

Catalog #	Description
121-125	7" (180mm)

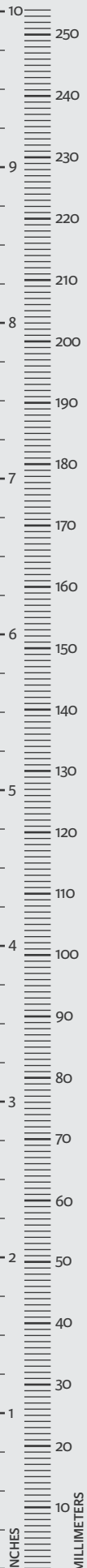
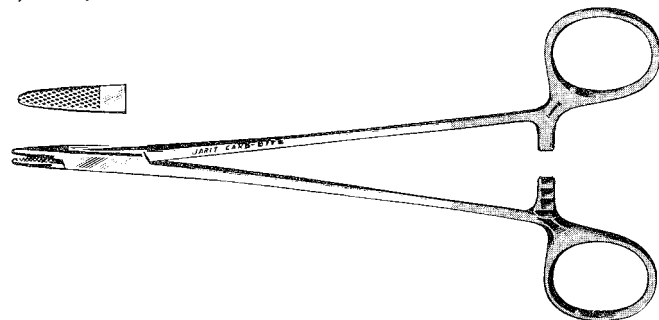

Crile-Wood Needle Holders, Carb-Bite

4000 teeth per square inch, for use with 4.0, 5.0 and 6.0 suture curved jaw

Catalog #	Description
121-126	7½" (188mm)
121-127	9¼" (232mm)

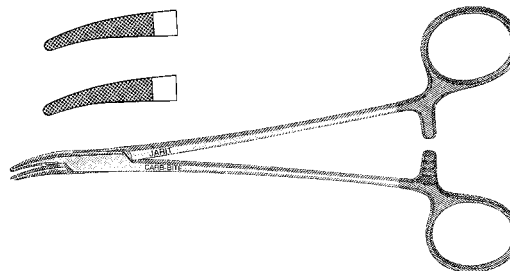

Crile-Wood Needle Holders, Carb-Bite, (Satin Finish)

4000 teeth per square inch, for use with 4.0, 5.0 and 6.0 suture
Manufactured from high grade German surgical stainless steel which is ground and polished to a satin finish

Catalog #	Description
121-130	6" (152mm)
121-131	7" (180mm)
121-132	8" (205mm)
121-133	9" (231mm)
121-134	10½" (267mm)
121-129	12¼" (311mm)
121-128	14" (356mm)

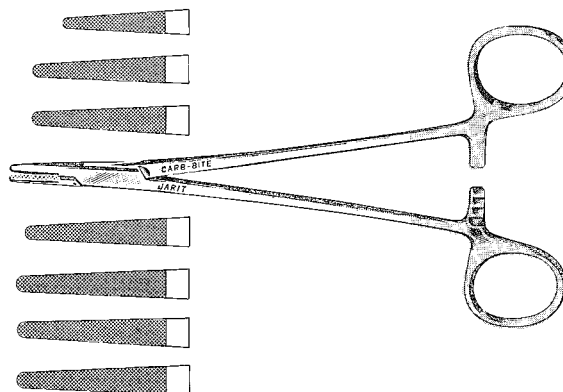

Crile-Wood Needle Holders, Carb-Bite, (Matte Finish)

4000 teeth per square inch, for use with 4.0, 5.0 and 6.0 suture
Manufactured from high grade German surgical stainless steel which is glass beaded to a matte finish

Catalog #	Description
123-130	6" (152mm)
123-131	7" (180mm)
123-132	8" (205mm)

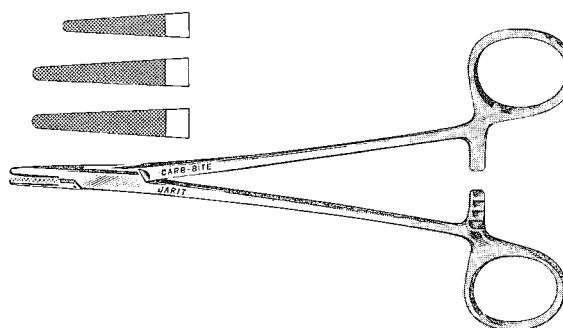

Mayo-Hegar Needle Holder, Carb-Bite, (Satin Finish)

2500 teeth per square inch, for use with 1.0, 2.0, 3.0 and 4.0 suture

Manufactured from high grade German surgical stainless steel which is ground and polished to a satin finish

Catalog #	Description
121-135	6 1/4" (160mm)
121-140	7 1/4" (187mm)
121-145	8" (206mm)
121-146	9 1/2" (240mm)
121-142	10 3/8" (263mm)
121-143	11" (280mm)
121-147	11 3/4" (300mm)
121-144	13 3/4" (350mm)

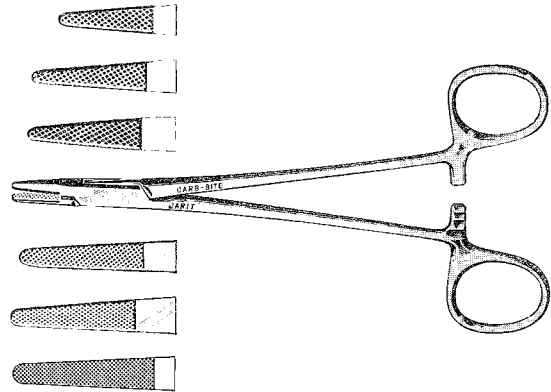

Mayo-Hegar Needle Holder, Carb-Bite, (Matte Finish)

2500 teeth per square inch, for use with 1.0, 2.0, 3.0 and 4.0 suture

Manufactured from high grade German surgical stainless steel which is ground and polished to a matte finish

Catalog #	Description
123-135	6 1/4" (160mm)
123-140	7 1/4" (187mm)
123-145	8" (206mm)

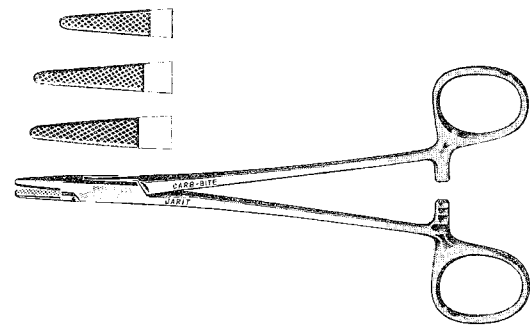

Fell Needle Holders, Carb-Bite

4000 teeth per square inch, for use with 2.0, 3.0 and 4.0 suture

2mm tips x 15mm long

Catalog #	Description
121-270	5 1/4" (132mm)
121-271	6 1/4" (159mm)
121-272	7" (178mm)
121-173	8" (203mm)
121-174	9" (227mm)



Petit-Point Olsen-Hegar Needle Holder/Scissors, Carb-Bite

7000 teeth per square inch, for use with 6.0, 7.0, 8.0 suture

Catalog #	Description
121-148	4¾" (120mm), delicate, serrated
121-149	4¾" (120mm), delicate, smooth

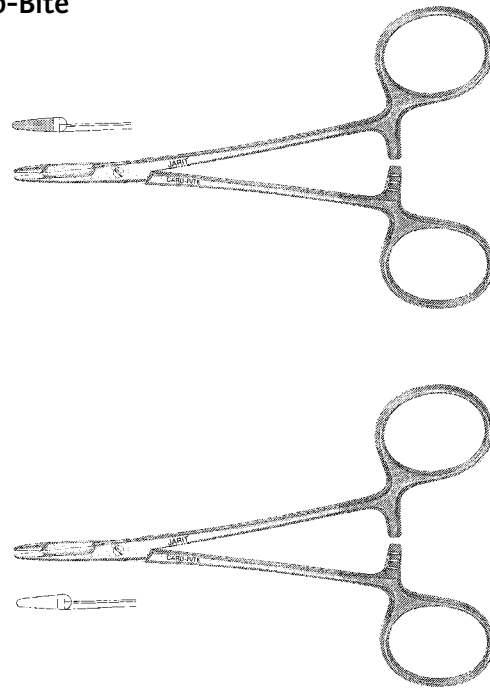

Olsen-Hegar Needle Holder/Scissors, Carb-Bite

4000 teeth per square inch, for use with 4.0, 5.0, 6.0 suture

Catalog #	Description
121-150	5¾" (147mm), delicate, serrated
121-155	6¼" (161mm), delicate, serrated

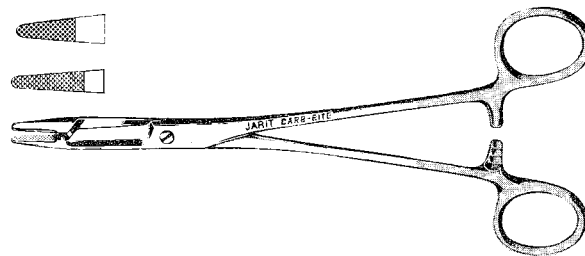

Ryder Needle Holders, Carb-Bite

4000 teeth per square inch, for use with 4.0, 5.0 and 6.0 suture

Catalog #	Description
121-160	5" (126mm), jaws 1.6mm x 10mm
121-161	5⅞" (149mm), jaws 1.6mm x 10mm
121-162	7¼" (184mm), jaws 1.6mm x 12mm
121-163	8" (202mm), jaws 1.6mm x 12mm
121-164	9" (230mm), jaws 1.6mm x 15mm
121-165	10¼" (262mm), jaws 1.6mm x 15mm

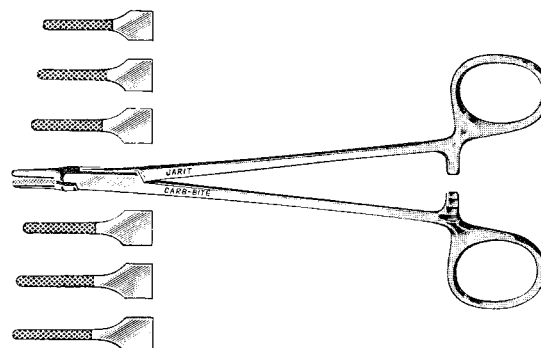

Hufnagel-Ryder Needle Holder, Carb-Bite

4000 teeth per square inch, for use with 4.0, 5.0 and 6.0 suture

Catalog #	Description
121-166	8¾" (225mm)

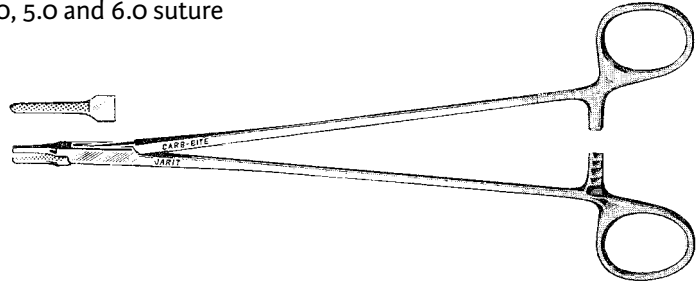

Petit-Point Ryder Needle Holders, Carb-Bite

7000 teeth per square inch, for use with 4.0, 5.0 and 6.0 suture
serrated jaws

Catalog #	Description
121-170	4⅞" (124mm), serrated, jaws 1mm x 9mm
121-172	6¼" (156mm), serrated, jaws 1mm x 9mm
121-174	7" (176mm), serrated, jaws 1mm x 10mm
121-176	7¾" (200mm), serrated, jaws 1mm x 12mm
121-177	9" (228mm), serrated, jaws 1mm x 12mm

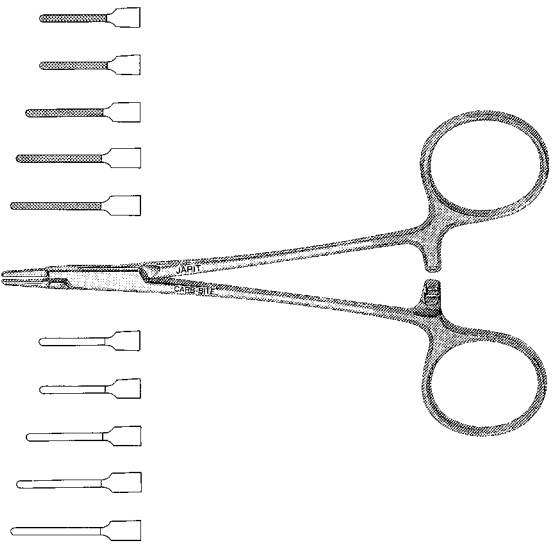

Petit-Point Ryder Needle Holders, Carb-Bite

smooth jaws, for use with 4.0, 5.0 and 6.0 suture

Catalog #	Description
121-171	4⅞" (124mm), smooth, jaws 1mm x 9mm
121-173	6¼" (156mm), smooth, jaws 1mm x 9mm
121-175	7" (176mm), smooth, jaws 1mm x 10mm
121-179	8" (203mm), smooth, jaws 1mm x 12mm
121-178	9" (228mm), smooth, jaws 1mm x 12mm

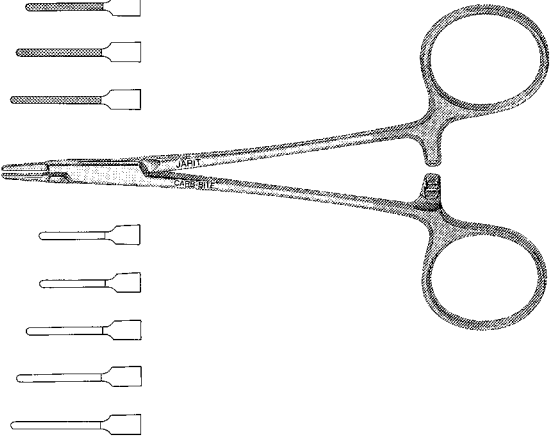

Masson Needle Holder, Carb-Bite

2500 teeth per square inch, for use with 1.0, 2.0, 3.0 and 4.0 suture

Catalog #	Description
121-180	10½" (268mm)

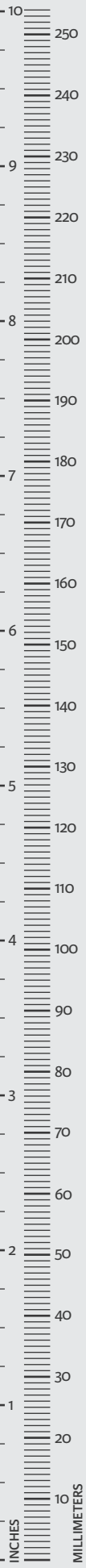
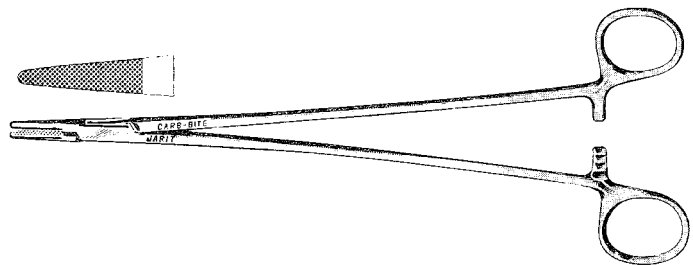

Diethrich Microvascular Needle Holders, Carb-Bite

7000 teeth per square inch, for use with 6.0 and 7.0 suture

Catalog #	Description
121-181	7" (180mm)
121-182	7¾" (200mm)
121-183	9" (230mm)

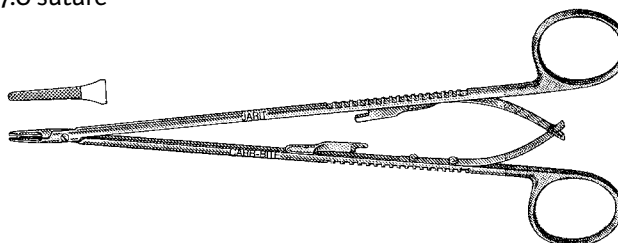

DeBakey Vascular Needle Holders, Carb-Bite

7000 teeth per square inch, for use with 5.0, 6.0 and 7.0 suture

Catalog #	Description
121-184	5⅞" (150mm)
121-185	7" (178mm)
121-186	8" (205mm)
121-187	9" (230mm)
121-188	10¼" (260mm)
121-189	12¼" (311mm)

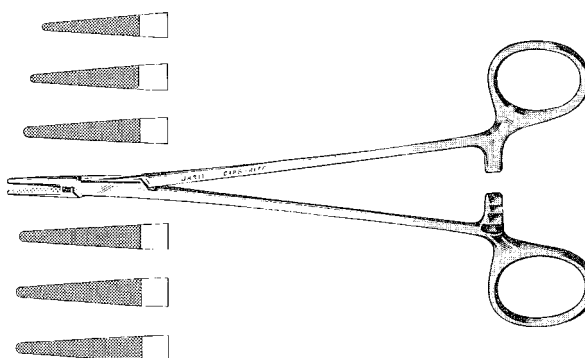

Finochietto Needle Holder, Carb-Bite

2500 teeth per square inch, for use with 2.0, 3.0 and 4.0 suture

Catalog #	Description
121-192	10¼" (262mm)

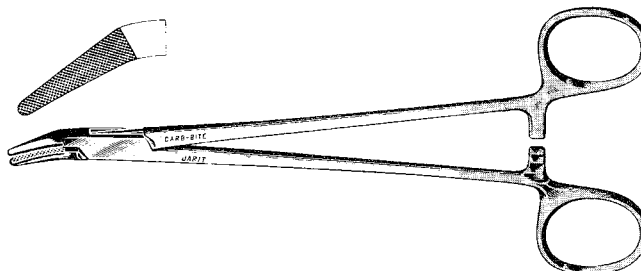

DeBakey Vascular Needle Holder, Carb-Bite

4000 teeth per square inch, for use with 4.0, 5.0 and 6.0 suture

Catalog #	Description
121-193	9" (230mm), curved

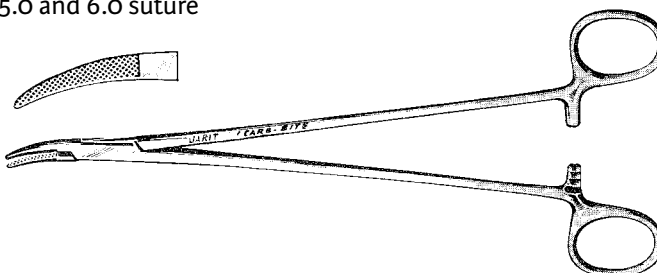

Stratte Valve Needle Holders, Carb-Bite

2500 teeth per square inch, for use with 2.0, 3.0 and 4.0 suture

Catalog #	Description
121-195	9" (227mm), double curved
121-196	9¾" (250mm), double curved, delicate

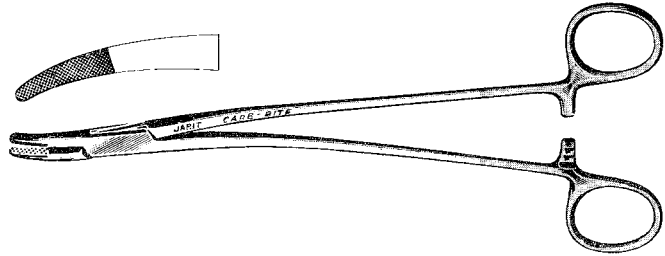

Petit-Point Sarot Needle Holders, Carb-Bite

4000 teeth per square inch, for use with 5.0 and 6.0 suture

Catalog #	Description
121-197	5⅞" (150mm), delicate
121-198	6¾" (169mm), delicate

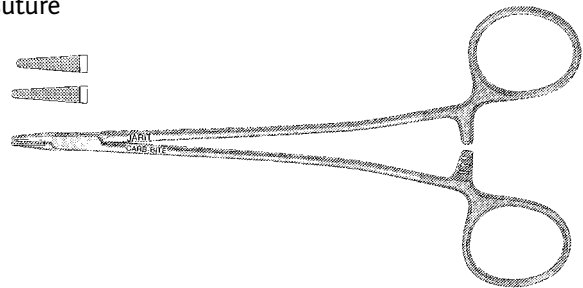

Sarot Needle Holders, Carb-Bite

2500 teeth per square inch, for use with 4.0, 5.0 and 6.0 suture

Catalog #	Description
121-200	7¼" (182mm)
121-205	10¼" (258mm)

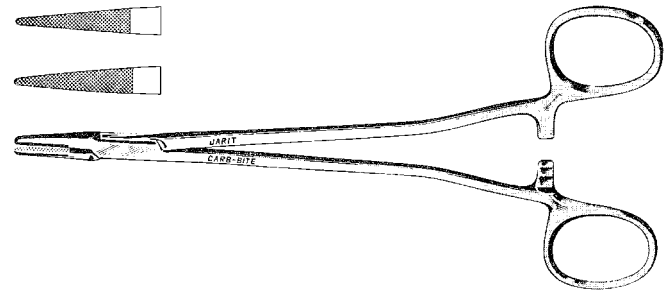

Julian Needle Holders, Carb-Bite

4000 teeth per square inch, for use with 4.0, 5.0 and 6.0 suture

Catalog #	Description
121-206	8¼" (210mm), straight
121-207	8¼" (210mm), curved

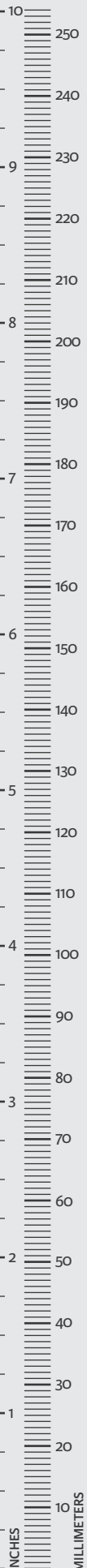
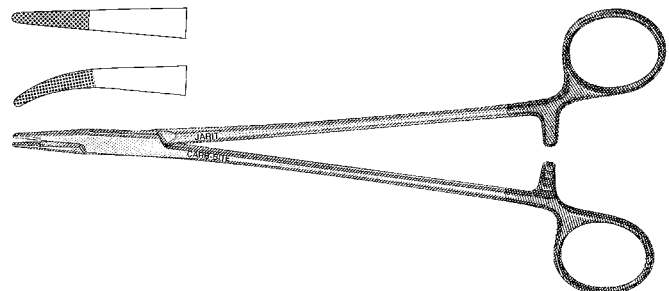

Heaney Needle Holders, Carb-Bite

2500 teeth per square inch, for use with 2.0, 3.0, 4.0 suture

Catalog #	Description
121-210	8" (206mm), curved
121-209	10½" (267mm), curved
121-204	11¾" (300mm), curved

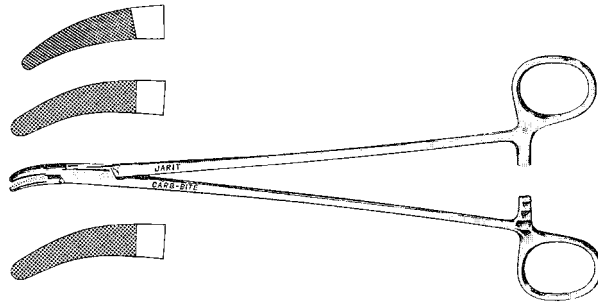

Microvascular Needle Holders, Carb-Bite

4000 teeth per square inch, for use with 4.0, 5.0, and 6.0 suture, light weight model, slender jaws

Catalog #	Description
121-211	6" (152mm)
121-212	7¼" (184mm)
121-213	8" (203mm)
121-214	9" (228mm)
121-215	10½" (267mm)

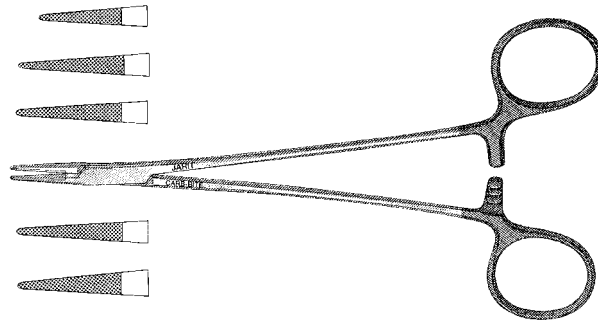

Cooley Intracardiac Needle Holders, Carb-Bite

4000 teeth per square inch, for use with 2.0, 3.0 and 4.0 suture

Catalog #	Description
121-216	7" (179mm)
121-217	8" (202mm)
121-218	9" (229mm)
121-219	10¼" (261mm)

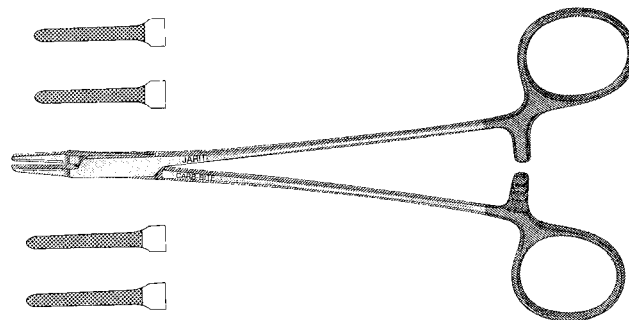

Mathieu Needle Holders, Carb-Bite

2500 teeth per square inch, for use with 2.0, 3.0, and 4.0 suture

Catalog #	Description
121-220	8" (203mm)

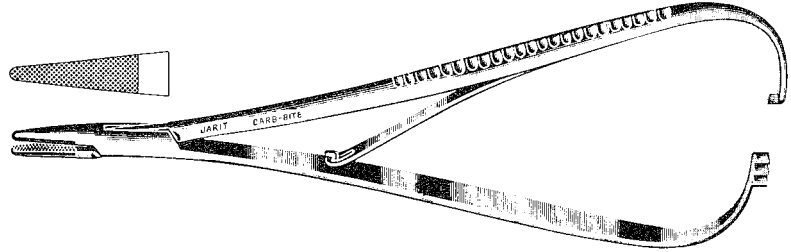

Castroviejo Style Microsurgical Needle Holders, Carb-Bite

7000 teeth per square inch, 1mm tips, for use with 5.0, 6.0 and 7.0 suture
serrated jaws

Catalog #	Description
121-229	7" (178mm)
121-229NL	7" (178mm) (Non Locking)
121-231	8 1/2" (216mm)
121-231NL	8 1/2" (216mm) (Non Locking)

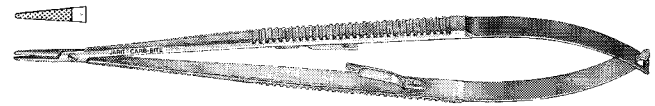

Castroviejo Style Microsurgical Needle Holders, Carb-Bite

7000 teeth per square inch, 1mm tips, for use with 5.0, 6.0 and 7.0 suture
smooth jaws

Catalog #	Description
121-228	7" (178mm)
121-228NL	7" (178mm) (Non Locking)
121-230	8 1/2" (216mm)
121-230NL	8 1/2" (216mm) (Non Locking)



Rubio Sternal Needle Holder and Wire Twister, Carb-Bite

4000 teeth per square inch, for use with 1.0 and 2.0 suture

Catalog #	Description
121-250	5 1/4" (132mm)

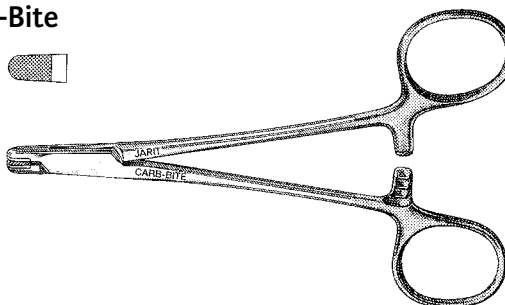

Sternal Needle Holder and Wire Twister, Carb-Bite

4000 teeth per square inch, for use with 1.0 and 2.0 suture

Catalog #	Description
121-255	7" (176mm)

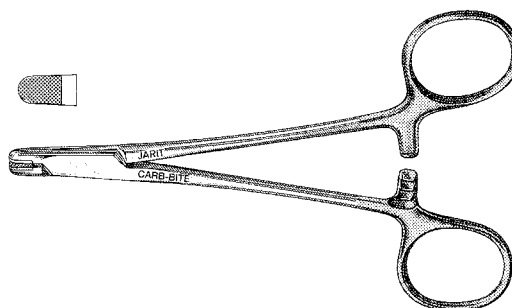

Wire Twister, Carb-Bite

2500 teeth per square inch, for use with 1.0 and 2.0 suture

Catalog #	Description
121-257	6" (155mm), short delicate jaws
121-258	6" (155mm), short blunt jaws

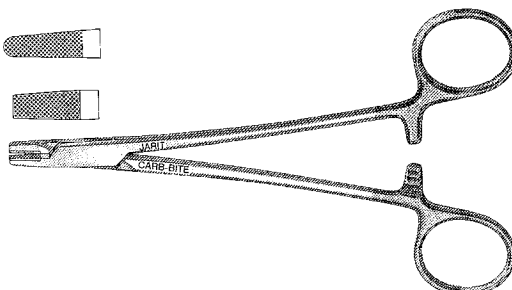

Berry Sternal Needle Holder and Wire Twister, Carb-Bite

1800 teeth per square inch, for use with 1.0 and 2.0 suture

Catalog #	Description
121-260	7 1/4" (186mm), heavy duty, 5mm x 17mm jaws

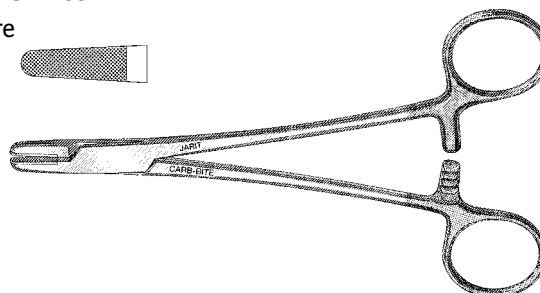

Cooley-Baumgarten Sternal Wire Twister, Carb-Bite

2500 teeth per square inch, for use with 1.0 and 2.0 suture

Catalog #	Description
121-265	8" (205mm), heavy duty, blunt jaws, textured tip



Carb-Bite™ Tissue and Needle Pulling Forceps

These versatile forceps feature tips with solid tungsten carbide inserts. Fine, sharply defined serrations have been ground into these inserts to provide non-slip surfaces for grasping tissue and suture needles. Handles are gold plated for easy identification.

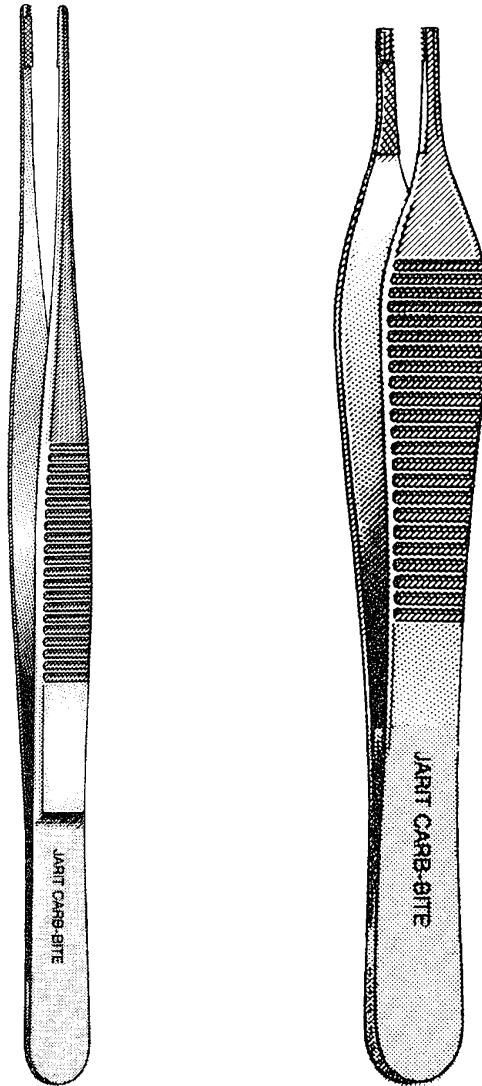

Adson Needle and Tissue Pulling Forceps, Carb-Bite

1 x 2 teeth

Catalog #	Description
122-500	4 ⁷ / ₈ " (123mm)
122-501	4 ⁵ / ₈ " (119mm), delicate
122-502	5 ⁷ / ₈ " (150mm)
122-503	5 ⁷ / ₈ " (150mm), delicate

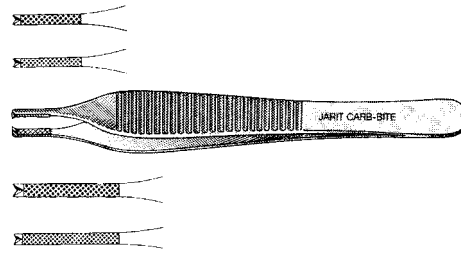

Brown-Adson Needle and Tissue Pulling Forceps, Carb-Bite

3 x 4 teeth

Catalog #	Description
122-510	4 ⁷ / ₈ " (124mm)

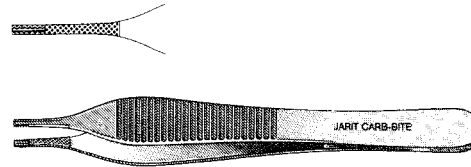

Bonney Needle and Tissue Pulling Forceps, Carb-Bite

1 x 2 teeth, 3.4mm x 22.5mm tips

Catalog #	Description
122-520	6 ³ / ₄ " (173mm)

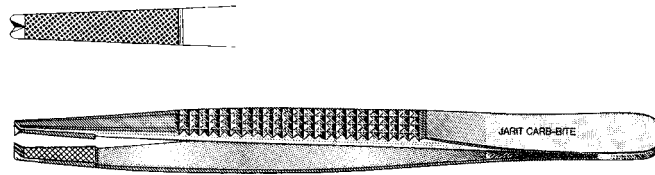

Cushing Needle and Tissue Pulling Forceps, Carb-Bite

Gutsch handle, scraper end

Catalog #	Description
122-530	7" (176mm), 1.8mm wide x 12mm length
122-535	7" (176mm), delicate, 1.6mm wide x 8mm length

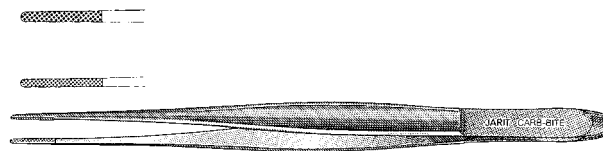

DeBakey Needle and Tissue Pulling Forceps, Carb-Bite

3 x 6 teeth, 2.0mm x 8mm tips

Catalog #	Description
122-540	5 ⁷ / ₈ " (150mm)
122-542	7 ³ / ₄ " (197mm)
122-544	9 ¹ / ₂ " (240mm)

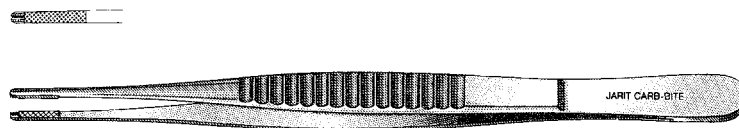

DeBakey Needle and Tissue Pulling Forceps, Carb-Bite

3 x 6 teeth, 1.5mm x 8mm tips

Catalog #	Description
122-541	6" (151mm)
122-543	7 ³ / ₄ " (197mm)
122-545	9 ¹ / ₂ " (240mm)

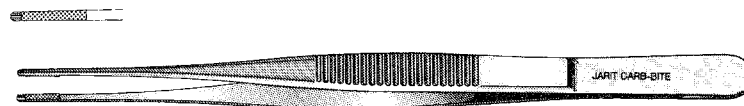

Ferris-Smith Needle and Tissue Pulling Forceps, Carb-Bite

1 x 2 teeth, 3mm x 12.5mm tips

Catalog #	Description
122-550	6¾" (174mm)

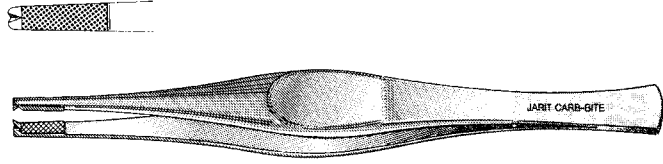

General Needle and Tissue Pulling Forceps, Carb-Bite

1 x 2 teeth, 3mm x 12mm tips

Catalog #	Description
122-560	6" (155mm)

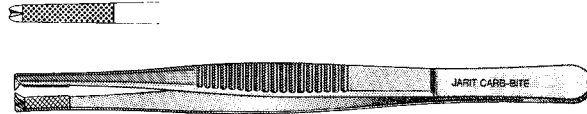

Gerald Needle and Tissue Pulling Forceps, Carb-Bite

1 x 2 teeth, 1.2mm x 12mm tips

Catalog #	Description
122-570	7" (176mm), delicate

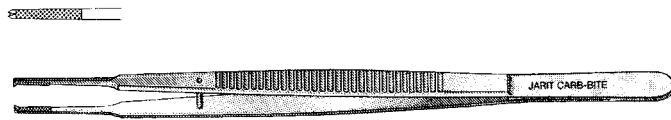

Semken Needle and Tissue Pulling Forceps, Carb-Bite

1 x 2 teeth

Catalog #	Description
122-590	6" (153mm), 1.7mm x 12mm tips
122-591	6" (153mm), 1mm x 12mm tips, delicate

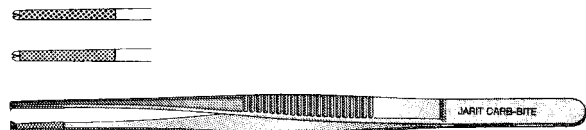

Skinner Needle and Tissue Pulling Forceps, Carb-Bite

1 x 2 teeth

Catalog #	Description
122-600	9¼" (232mm), 4.5mm x 8mm tips
122-601	9¼" (232mm), 2.6mm x 8mm tips, delicate
122-602	9¼" (232mm), 2mm x 8mm tips, micro

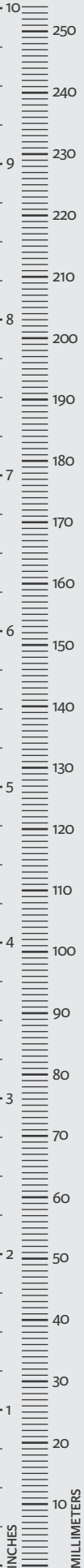
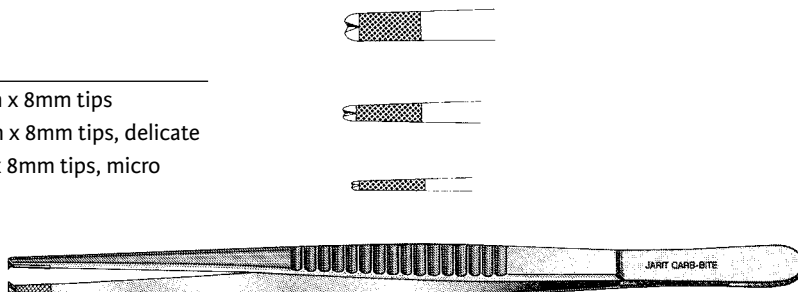

Hegenbarth Clip Applying Forceps

Catalog #	Description
125-100	5" (127mm)

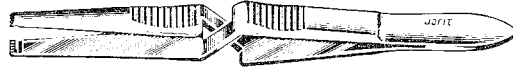

Michel Clip Applying/Removing Forceps

Catalog #	Description
125-110	4 ⁷ / ₈ " (124mm), double ended

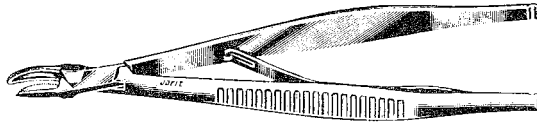

Michel Skin Clips, package of 1000

Catalog #	Description
125-114	7.5mm
125-115	11mm
125-117	14mm
125-120	16mm
125-122	18mm

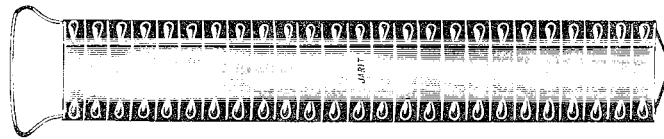

Richter-Heath Clip Forceps

Catalog #	Description
125-125	5 ¹ / ₄ " (134mm), double ended

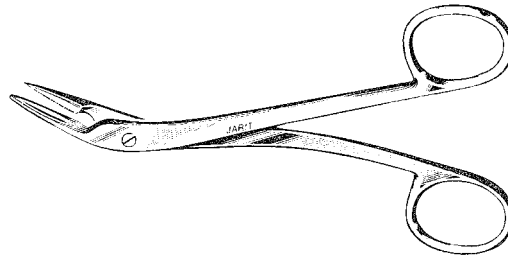

Wachtenfeld Clip Forceps

Catalog #	Description
125-130	5" (127mm)



Wachtenfeld Clip Forceps

Catalog #	Description
125-132	4 ³ / ₄ " (121mm), cross-action

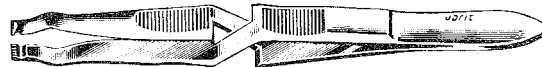

Deschamps Ligature Carriers

Catalog #	Description
125-150	8" (203mm), sharp, left
125-152	8" (203mm), sharp, right
125-154	8" (203mm), blunt, left
125-155	8" (203mm), blunt, right

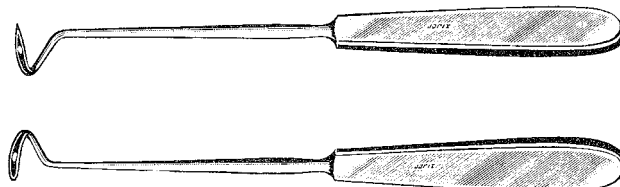

New's Suture Scissors

Catalog #	Description
125-165	5 ⁵ / ₈ " (142mm), angled on flat

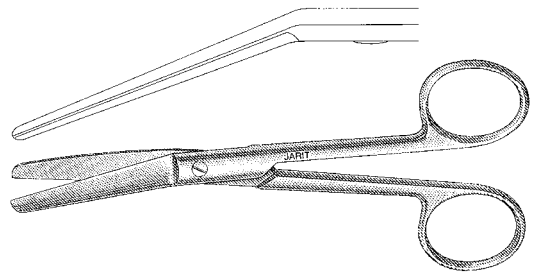

Universal Wire Suture Scissors

Catalog #	Description
125-170	4 ³ / ₄ " (122mm), angled, one serrated blade

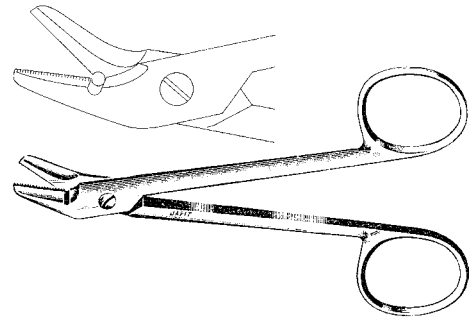

Universal Wire Suture Scissors, Carb-Bite
for cutting suture and wire (26 gauge and smaller)

Catalog #	Description
101-350	4 ⁷ / ₈ " (124mm), angled, for cutting suture and wire (26 gauge and smaller)

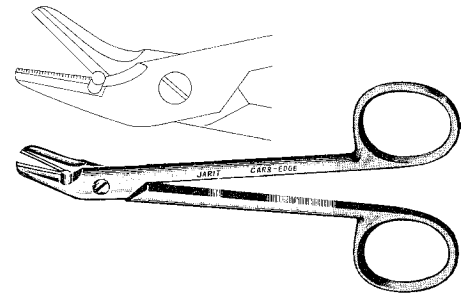

Heath Suture Scissors

Catalog #	Description
125-175	6" (155mm), serrated

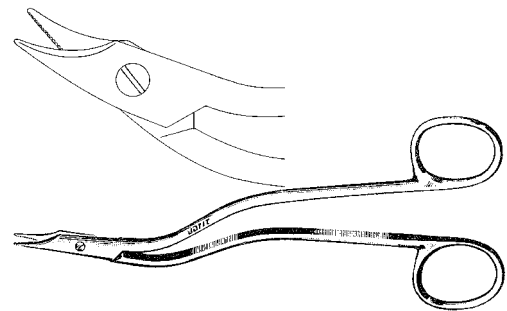

Spencer Suture Scissors

Catalog #	Description
125-180	3 ¹ / ₂ " (90mm)
125-182	5" (127mm)

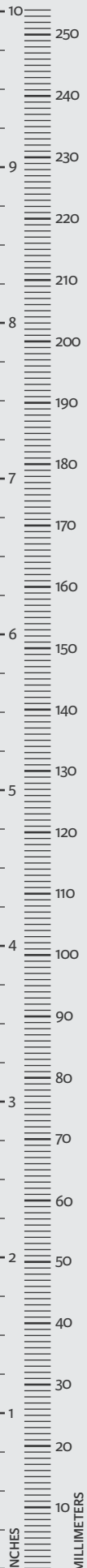
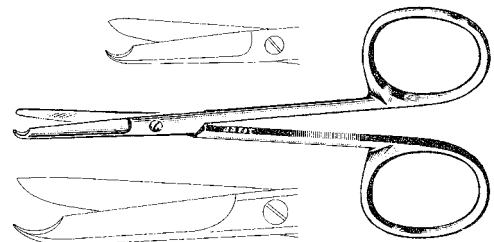

Spencer Suture Scissors

curved sideways

Catalog #	Description
125-184	3½" (90mm)
125-185	4¾" (121mm)

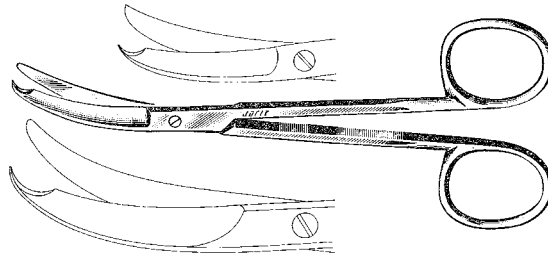

Littauer Stitch Scissors

Catalog #	Description
125-190	5½" (140mm)

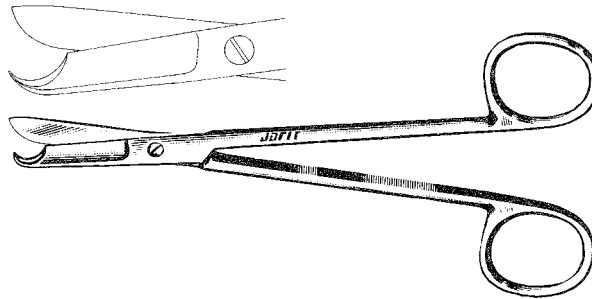

Suture Wire Scissors

serrated

Catalog #	Description
125-192	4⅛" (104mm), Straight
125-193	4⅛" (104mm), Curved

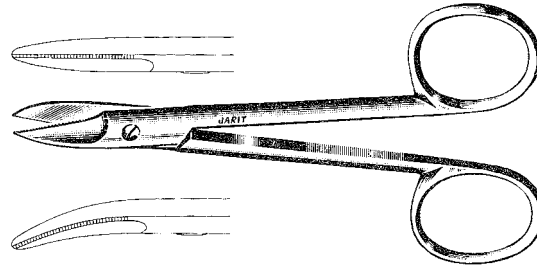

Smith Wire Scissors

Catalog #	Description
125-194	6¾" (171mm)

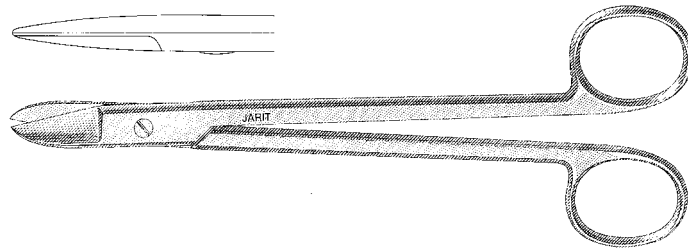

O'Brien Suture Scissors

Catalog #	Description
125-195	3⅞" (100mm), angled

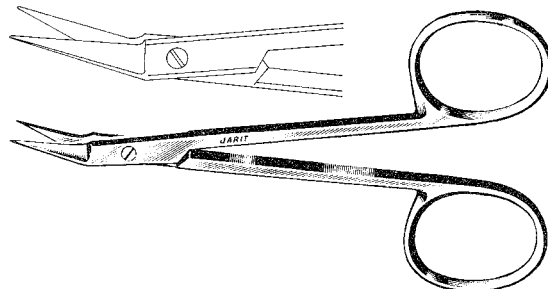

Dressing Forceps, Serrated, (Matte Finish)

Manufactured from high grade German surgical stainless steel which is glass beaded to a matte finish

Catalog #	Description
130-099	4 1/8" (105mm)
130-100	4 5/8" (118mm)
130-101	4 5/8" (118mm), fluted handles
130-105	5 1/8" (130mm)
130-110	5 5/8" (142mm)
130-111	5 5/8" (142mm), fluted handles
130-115	6" (154mm)
130-116	6" (154mm), fluted handles
130-117	7 1/4" (184mm)
130-120	7 3/4" (200mm)
130-125	10" (252mm)
130-130	11 3/4" (300mm)
130-132	14" (355mm)

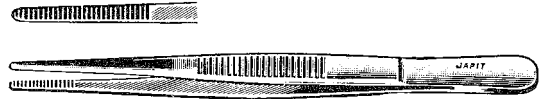

Dressing Forceps, Serrated, (Mirror Finish)

Manufactured from high grade German surgical stainless steel which is ground and polished to a mirror finish

Catalog #	Description
129-110	5 5/8" (142mm)
129-115	6" (154mm)



Tissue Forceps, Carb-Bite

Catalog #	Description
130-145	6" (152mm)

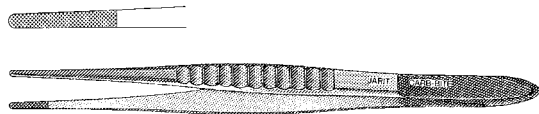

Tissue Forceps

1 x 2 teeth, cross serrated

Catalog #	Description
130-185	6" (154mm)

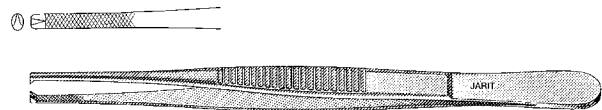

Tissue Forceps, 1 x 2 teeth, (Matte Finish)

Manufactured from high grade German surgical stainless steel which is glass beaded to a matte finish

Catalog #	Description
130-150	4 ⁵ / ₈ " (118mm)
130-151	4 ⁵ / ₈ " (118mm), fluted handles
130-155	5 ¹ / ₈ " (130mm)
130-160	5 ⁵ / ₈ " (144mm)
130-161	5 ⁵ / ₈ " (142mm), fluted handles
130-165	6" (154mm)
130-166	6" (154mm), fluted handles
130-167	7" (180mm)
130-170	8" (204mm)
130-175	9 ³ / ₄ " (248mm)
130-180	12" (303mm)
130-182	14" (355mm)



Tissue Forceps, 1 x 2 teeth, (Mirror Finish)

Manufactured from high grade German surgical stainless steel which is ground and polished to a mirror finish

Catalog #	Description
129-160	5 ⁵ / ₈ " (142mm)
129-165	6" (154mm)



Tissue Forceps

Catalog #	Description
130-200	5 ⁵ / ₈ " (144mm), 2 x 3 teeth
130-201	6" (154mm), 2 x 3 teeth
130-210	5 ⁵ / ₈ " (144mm), 3 x 4 teeth
130-211	6" (154mm), 3 x 4 teeth
130-216	5 ¹ / ₂ " (140mm), 4 x 5 teeth
130-217	6 ¹ / ₄ " (158mm), 4 x 5 teeth

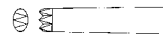

Von Graefe Tissue Forceps

Catalog #	Description
130-220	4 ³ / ₈ " (112mm)



College Pliers #317

Catalog #	Description
130-225	5 ⁷ / ₈ " (150mm), serrated

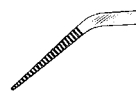

DeBakey-Diethrich Vascular Tissue Forceps

straight, extra delicate, 1mm tips

Catalog #	Description
320-050	6" (152mm), 20mm length serrated tips
320-051	7¾" (197mm), 20mm length serrated tips
320-052	9½" (241mm), 20mm length serrated tips



DeBakey -Diethrich Vascular Tissue Forceps

straight, delicate, 1.5mm tips

Catalog #	Description
320-113	5⅞" (150mm), 24mm length serrated tips
320-114	7¾" (195mm), 24mm length serrated tips
320-115	9½" (240mm), 24mm length serrated tips
320-099	11¾" (300mm), 24mm length serrated tips

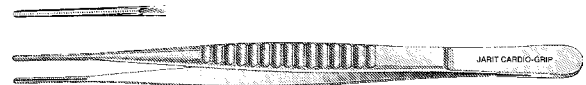

DeBakey Vascular Tissue Forceps

straight, standard, 2mm tips

Catalog #	Description
320-110	5⅞" (150mm), 24mm length serrated tips
320-111	7¾" (195mm), 24mm length serrated tips
320-112	9½" (240mm), 24mm length serrated tips
320-109	11¾" (300mm), 24mm length serrated tips
320-108	14¼" (360mm), 24mm length serrated tips

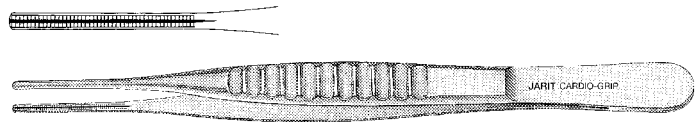

DeBakey Vascular Tissue Forceps

angled, standard, 2mm tips

Catalog #	Description
320-105	5⅞" (148mm), 21.5mm length serrated tips
320-106	7½" (192mm), 21.5mm length serrated tips
320-107	9¼" (237mm), 21.5mm length serrated tips

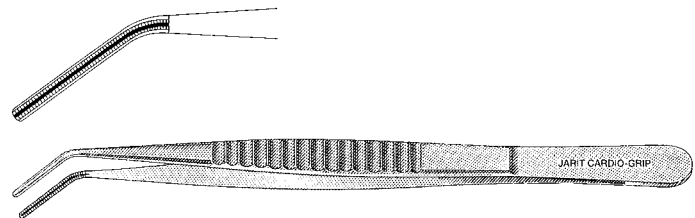

DeBakey Thoracic Tissue Forceps

straight, heavy, 2.8mm tips

Catalog #	Description
320-100	5 ⁷ / ₈ " (150mm), 24mm length serrated tips
320-101	7 ³ / ₄ " (195mm), 24mm length serrated tips
320-102	9 ¹ / ₂ " (240mm), 24mm length serrated tips
320-103	11 ³ / ₄ " (300mm), 24mm length serrated tips
320-104	14 ¹ / ₄ " (360mm), 24mm length serrated tips

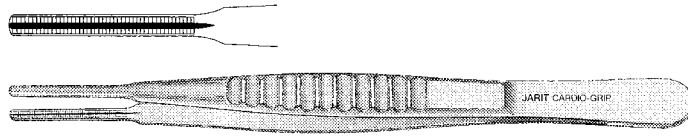

DeBakey Thoracic Tissue Forceps

straight, extra heavy, 3.5mm tips

Catalog #	Description
320-070	5 ⁷ / ₈ " (150mm), 24mm length serrated tips
320-071	7 ³ / ₄ " (195mm), 24mm length serrated tips
320-072	9 ¹ / ₂ " (240mm), 24mm length serrated tips
320-073	11 ³ / ₄ " (300mm), 24mm length serrated tips
320-074	14 ¹ / ₄ " (360mm), 24mm length serrated tips

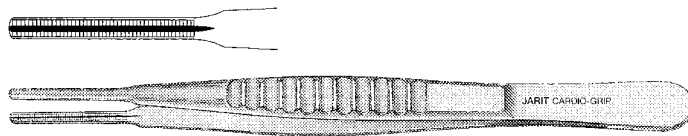

Cooley Vascular Tissue Forceps

straight, standard, 2mm tips

Catalog #	Description
320-116	5 ⁷ / ₈ " (150mm), 24mm length serrated tips
320-117	7 ³ / ₄ " (195mm), 24mm length serrated tips
320-118	9 ¹ / ₂ " (240mm), 24mm length serrated tips

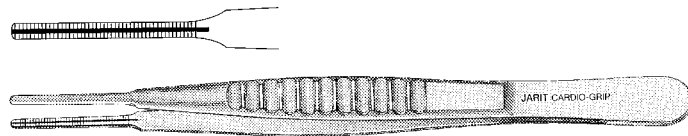

Cooley Vascular Tissue Forceps

straight, delicate, 1.2mm cross-serrated tips

Catalog #	Description
320-119	7 ⁷ / ₈ " (200mm), 1.2mm wide x 18mm length serrated tips

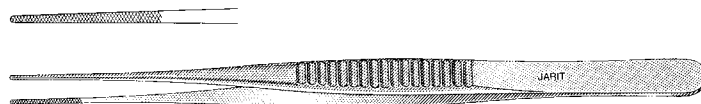

Adson Dressing Forceps, Serrated, (Matte Finish)

Manufactured from high grade German surgical stainless steel which is glass beaded to a matte finish

Catalog #	Description
130-230	4¾" (120mm)
130-231	4¾" (120mm), extra delicate, 0.8mm wide tip

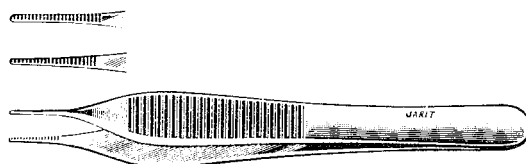

Adson Dressing Forceps, Serrated, (Mirror Finish)

Manufactured from high grade German surgical stainless steel which is ground and polished to a mirror finish

Catalog #	Description
129-230	4¾" (120mm)

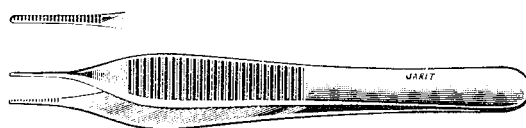

Adson Dressing Forceps, (Satin Finish)

Catalog #	Description
130-232	4¾" (120mm), cross serrated

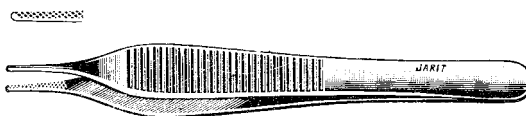

Adson Tissue Forceps, 1 x 2 teeth, (Mirror Finish)

Manufactured from high grade German surgical stainless steel which is ground and polished to a mirror finish

Catalog #	Description
130-234	4¾" (120mm)
130-235	4¾" (120mm), extra delicate, 0.8mm wide tip
130-237	4⅝" (117mm), angled jaw
130-238	4¾" (120mm), with tying platform

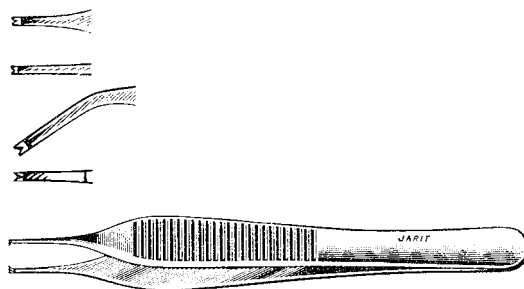

Adson Tissue Forceps, 1 x 2 teeth, (Satin Finish)

Manufactured from high grade German surgical stainless steel which is ground and polished to a satin finish

Catalog #	Description
129-234	4¾" (120mm)

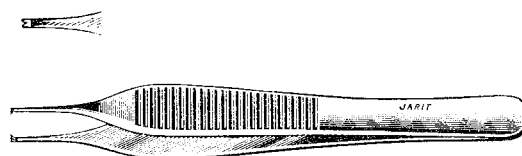

Adson Tissue Forceps, Carb-Bite, (Mirror Finish)

Catalog #	Description
130-236	4¾" (120mm)

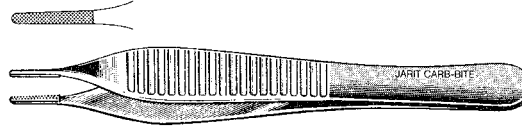

Adson Tissue Forceps, (Satin Finish)

Catalog #	Description
130-240	4¾" (120mm), 2 x 3 teeth

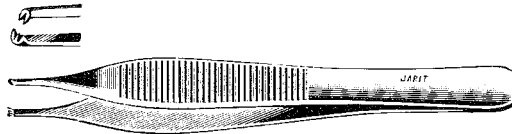

Adson Dressing Forceps, (Satin Finish)

Catalog #	Description
130-243	4¾" (120mm), serrated, cross serrated handle

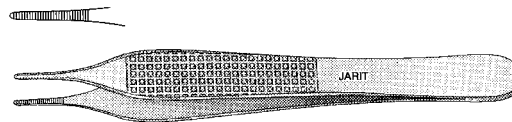

Adson Tissue Forceps, (Satin Finish)

Catalog #	Description
130-244	4¾" (120mm), 1 x 2 teeth, cross serrated handle

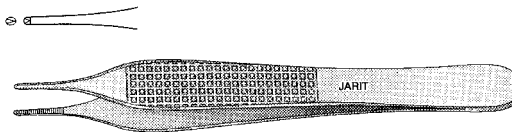

Adson Tissue Forceps, (Matte Finish)

Manufactured from high grade German surgical stainless steel which is glass beaded to a matte finish

Catalog #	Description
130-245	4¾" (120mm), 1 x 2 teeth, serrated

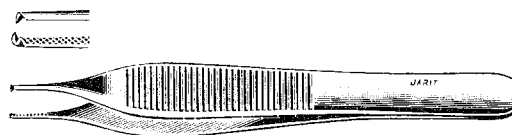

Adson Tissue Forceps, (Satin Finish)

delicate

Catalog #	Description
130-241	7" (180mm), 2 x 3 teeth, 3mm wide tip

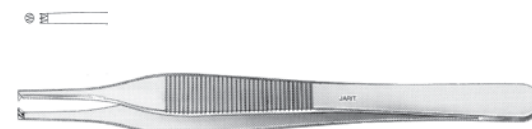

Broli-Adson Forceps

6" (152mm), 1.2mm tips

Catalog #	Description
130-246	Straight, serrated tips
130-247	Curved, serrated tips
130-248	Straight, Stardust tips
130-249	Straight, 1 x 2 teeth



Ewald (Hudson) Dressing Forceps

Catalog #	Description
130-250	4 7/8" (124mm), serrated

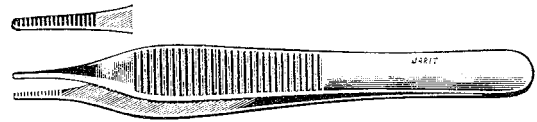

Ewald (Hudson) Dressing Forceps

Catalog #	Description
130-255	4 7/8" (124mm), 1 x 2 teeth

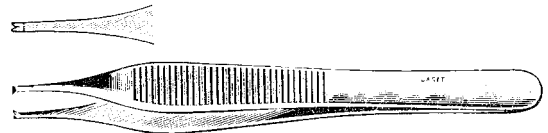

Brown-Adson Tissue Forceps, 9 x 9 teeth, (Satin Finish)

Manufactured from high grade German surgical stainless steel which is ground and polished to a satin finish

Catalog #	Description
130-260	4 7/8" (124mm)

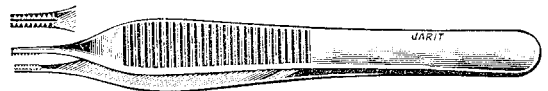

Brown-Adson Tissue Forceps, 9 x 9 teeth, (Mirror Finish)

Manufactured from high grade German surgical stainless steel which is ground and polished to a mirror finish

Catalog #	Description
129-260	4 7/8" (124mm)

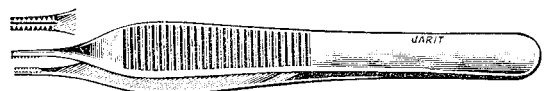

Brown-Adson Tissue Forceps, (Satin Finish)

9 x 9 teeth, angled

Catalog #	Description
130-270	4 7/8" (124mm)

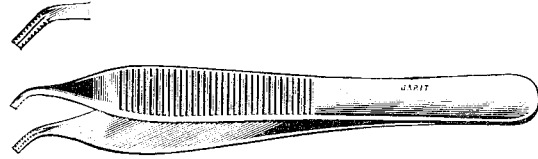

Beasley-Babcock Tissue Forceps

6 x 7 teeth

Catalog #	Description
130-262	4 7/8" (124mm)

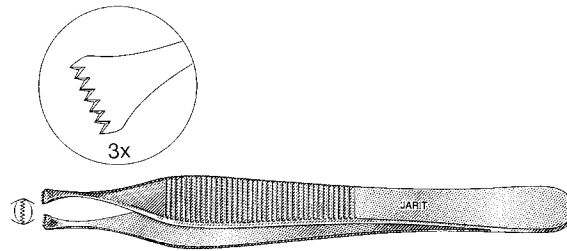

Brown Tissue Forceps

8 x 8 teeth

Catalog #	Description
130-265	6" (151mm)
130-266	8" (202mm)
130-267	10" (251mm)



Semken Dressing Forceps

Catalog #	Description
130-275	5" (126mm)
130-276	6" (152mm)



Semken Tissue Forceps

Catalog #	Description
130-280	5" (126mm), 1 x 2 teeth
130-281	6" (154mm), 1 x 2 teeth
130-282	5" (126mm), 2 x 3 teeth

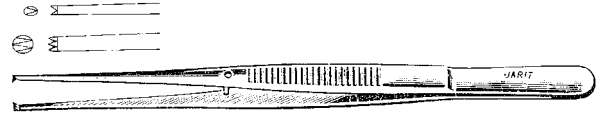

McIndoe Dressing Forceps

Catalog #	Description
130-284	6" (153mm), serrated jaws, 1.4mm wide x 14mm length

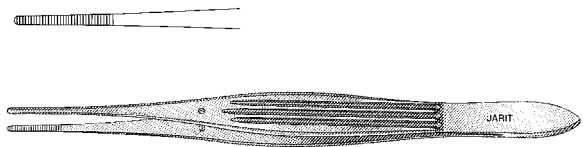

Gillies Tissue Forceps

Catalog #	Description
130-286	6" (152mm), 1 x 2 cross serrated jaws, 1.6mm wide x 17.5mm length

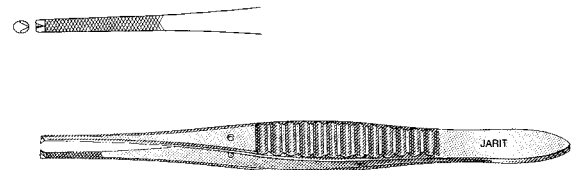

Brigham Tissue Forceps

Catalog #	Description
130-287	5 5/8" (144mm), 1 x 2 teeth, dissecting end, tip width 2.2mm

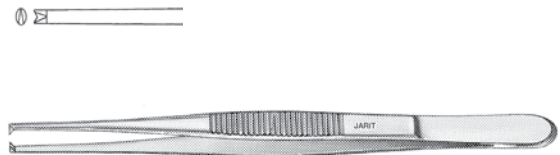

Ferris-Smith Tissue Forceps

Catalog #	Description
130-289	6 3/4" (174mm), 1 x 2 teeth, 3.9mm wide x 14mm length tips
130-290	6 3/4" (174mm), 2 x 3 teeth, 3.9mm wide x 14mm length tips

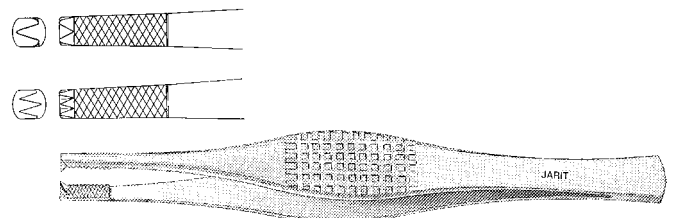

Bonney Tissue Forceps

3.4mm wide x 26mm length serrated jaws

Catalog #	Description
130-293	6¾" (173mm), 1 x 2 teeth
130-294	6¾" (173mm), 2 x 3 teeth

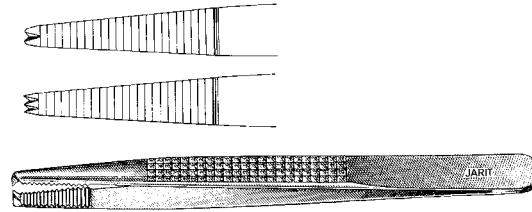

Wheeler-Type Plaque and Vessel Forceps, Cardio-Grip

1.6mm wide x 6mm length, serrated jaws

Catalog #	Description
130-296	5⅝" (144mm)
130-297	7¼" (182mm)
130-298	9" (226mm)

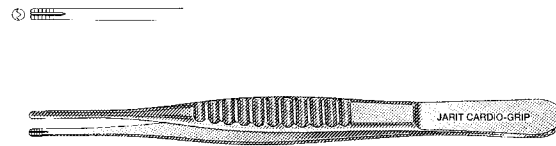

Alderkreutz Tissue Forceps

4.6mm x 12mm length jaws

Catalog #	Description
130-300	5¾" (145mm)

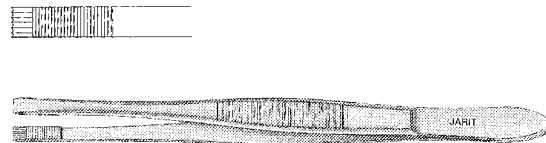

Potts-Smith Dressing Forceps

serrated

Catalog #	Description
130-350	7" (180mm)
130-355	8¼" (209mm)
130-360	9¾" (249mm)
130-367	10¼" (260mm)
130-365	11¾" (300mm)

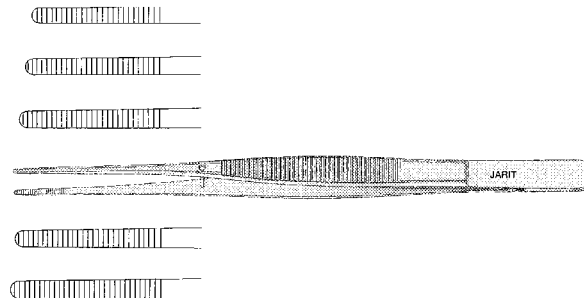

Potts-Smith Tissue Forceps

1 x 2 teeth, serrated

Catalog #	Description
130-352	7¼" (184mm)
130-357	8¼" (210mm)
130-362	9¾" (249mm)
130-368	10¼" (260mm)
130-366	12" (305mm)

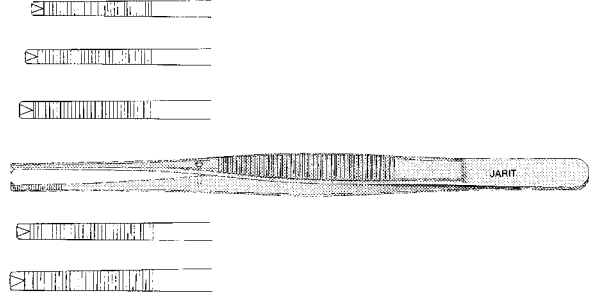

Potts-Smith Tissue Forceps, Carb-Bite

Catalog #	Description
130-353	7¼" (184mm)
130-358	8" (202mm)
130-363	9½" (241mm)
130-369	10¼" (261mm)

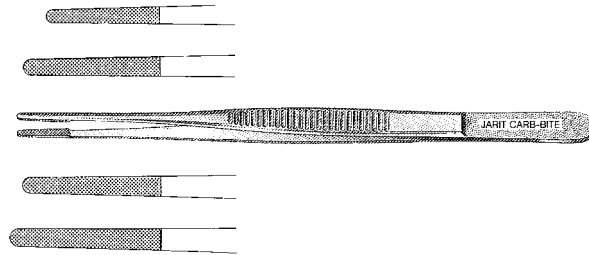

Nelson Tissue Forceps

6 x 7 teeth

Catalog #	Description
130-370	6" (152mm)
130-375	7" (178mm)
130-380	9" (228mm)

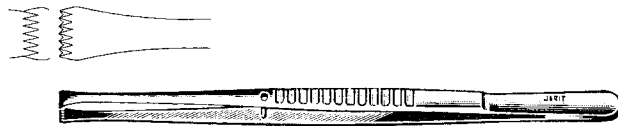

Evans Tissue Forceps, Carb-Bite

Catalog #	Description
130-383	9¾" (250mm), straight, 1.9mm wide x 16mm length serrated tips

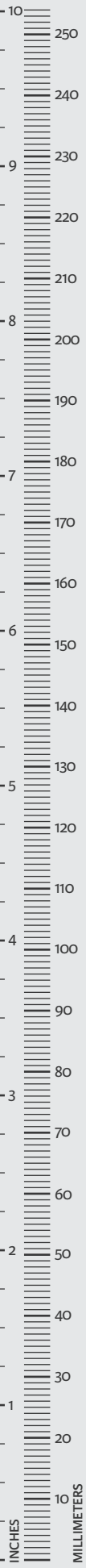
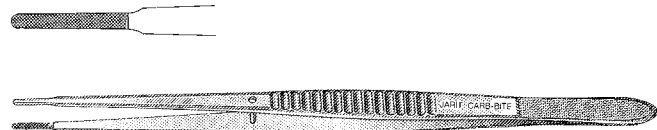

Russian Tissue Forceps, (Mirror Finish)

Manufactured from high grade German surgical stainless steel which is ground and polished to a mirror finish

Catalog #	Description
130-390	5 ⁷ / ₈ " (150mm)
130-392	7 ³ / ₄ " (200mm)
130-395	10 ¹ / ₄ " (258mm)
130-394	12" (305mm)
130-396	14" (355mm)

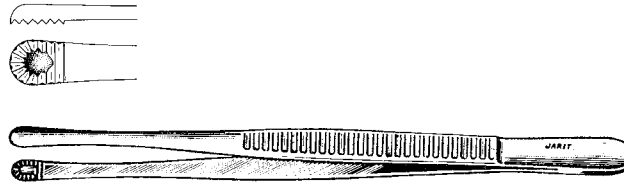

Russian Tissue Forceps, (Matte Finish)

Manufactured from high grade German surgical stainless steel which is glass beaded to a matte finish

Catalog #	Description
129-390	5 ⁷ / ₈ " (150mm)
129-392	7 ³ / ₄ " (200mm)
129-395	10 ¹ / ₄ " (258mm)

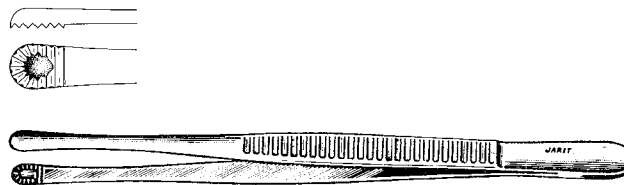

Mayo-Russian Tissue Forceps

Catalog #	Description
130-397	9" (228mm)

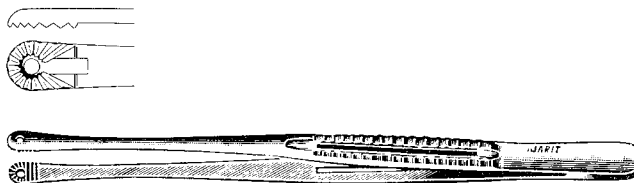

Cushing Dressing Forceps

straight, serrated, scraper end

Catalog #	Description
130-400	6 ³ / ₄ " (170mm), 1.5mm tip
130-445	7 ³ / ₄ " (200mm), 2mm tip

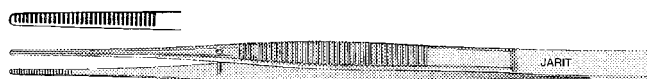

Cushing Tissue Forceps

straight, 1 x 2 teeth, scraper end

Catalog #	Description
130-405	6 3/4" (171mm), 1.5mm tip
130-446	7 3/4" (200mm), cross serrated, 2mm tip

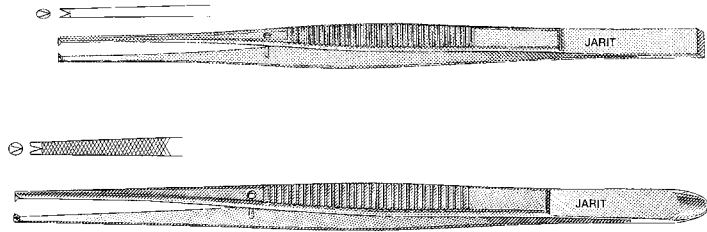

Cushing Dressing Forceps

bayonet, serrated, scraper end

Catalog #	Description
130-410	7 1/4" (183mm)
130-420	7 3/4" (200mm)

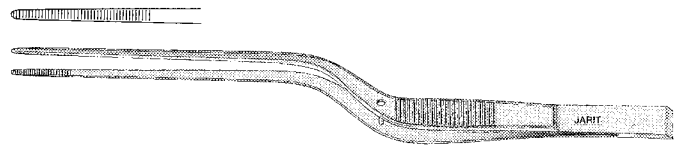

Cushing Tissue Forceps

bayonet, 1 x 2 teeth, scraper end

Catalog #	Description
130-415	7 1/4" (181mm)
130-421	7 3/4" (200mm)

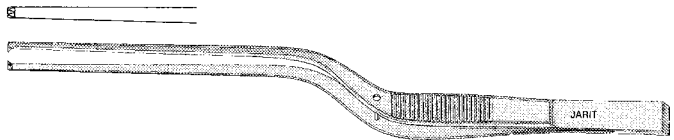

Cushing Tissue Forceps

Gutsch handle, straight, scraper end

Catalog #	Description
130-425	7" (178mm), serrated
130-430	7" (178mm), 1 x 2 teeth
130-435	7" (178mm), 1 x 2 teeth, serrated



Cushing Needle and Tissue Pulling Forceps, Carb-Bite

straight, Gutsch handle, scraper end

Catalog #	Description
122-530	7" (176mm), Gutsch handle, scraper end, 1.8mm wide x 12mm length tips
122-535	7" (176mm), delicate, 1.6mm wide x 8mm length tips

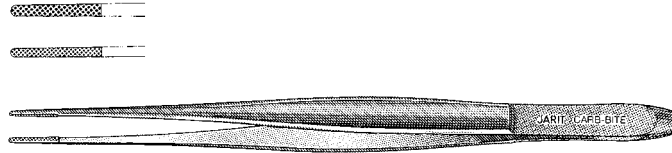

Cushing Tissue Forceps, Carb-Bite

angled, Gutsch handle, scraper end

Catalog #	Description
130-417	7" (176mm), 1.8mm wide x 12mm length tips

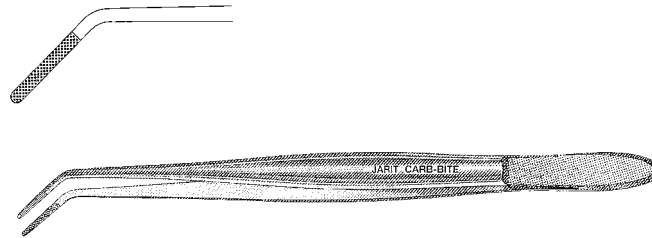

Cushing Tissue Forceps, Carb-Bite

bayonet, scraper end

Catalog #	Description
130-418	7½" (191mm), 1.8mm wide x 14mm length tips

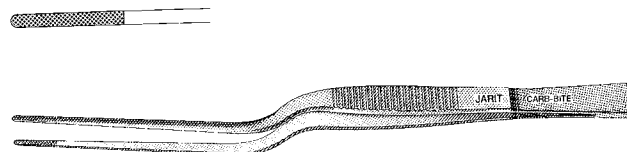

Reul Coronary Tissue Forceps, Carb-Bite
delicate

Catalog #	Description
130-437	8" (206mm), 1.6mm wide x 12mm length tips

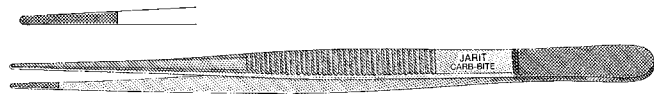

Cushing-Brown Tissue Forceps
straight, double row of 9 x 9 delicate teeth, scraper end

Catalog #	Description
130-440	6¾" (174mm)

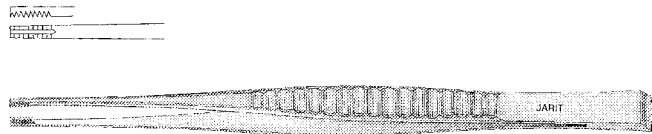

Cushing-Brown Tissue Forceps
bayonet, double row of 9 x 9 delicate teeth, scraper end

Catalog #	Description
130-442	7" (180mm)

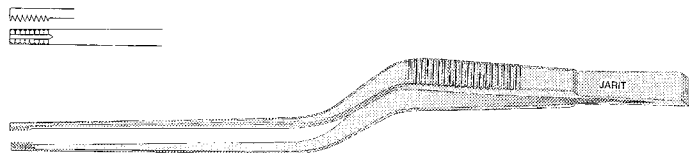

Singley Tissue Forceps

Catalog #	Description
135-250	9" (229mm)
135-248	14" (356mm)

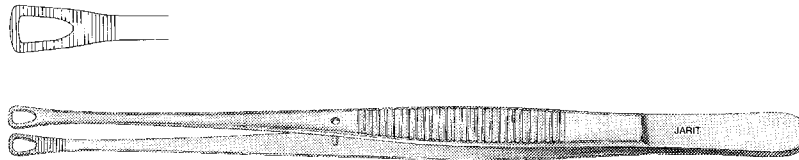

Selman Tissue Forceps

3.8mm round cup with teeth

Catalog #	Description
135-252	6" (155mm)
135-253	8" (205mm)
135-254	9¾" (250mm)

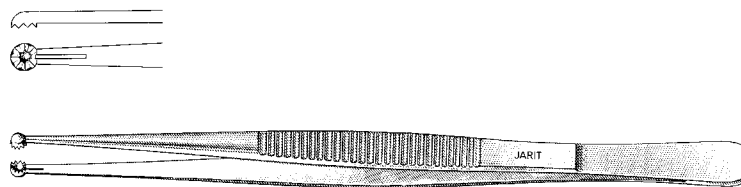

Wangensteen Tissue Forceps, Carb-Bite

Catalog #	Description
135-256	6" (151mm), 4.8mm wide x 15.7mm length tips
135-257	9" (230mm), 5mm wide x 18mm length tips
135-258	10" (257mm), 6mm wide x 18mm length tips

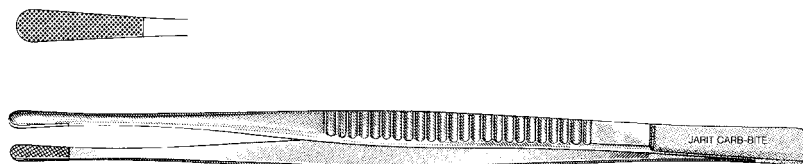

Jacobson Forceps, Bayonet Handle

6¼" (160mm)

Catalog #	Description
277-159	Sharp tips

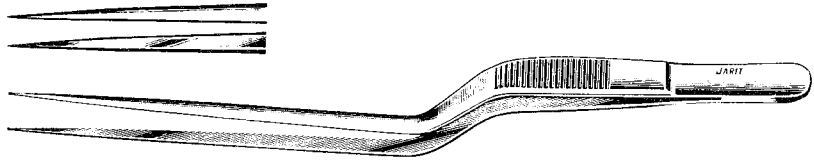

Jacobson Forceps, Bayonet Handle

7¼" (185mm)

Catalog #	Description
277-160	Blunt tips (0.8mm)
277-161	Sharp tips (0.3mm)
277-162	Angled blunt tips (0.8mm)

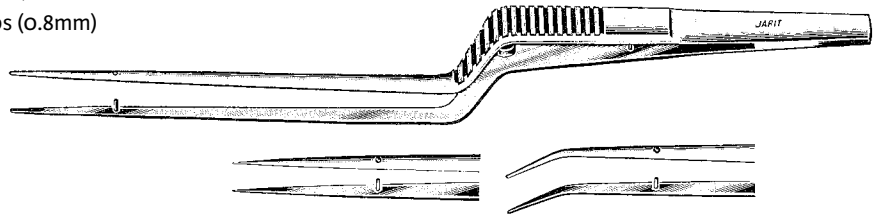

Hoen Dressing and Tissue Forceps, Bayonet Handle

7¾" (200mm)

Catalog #	Description
285-116	Serrated, 19mm length tips
285-117	1 x 2 teeth

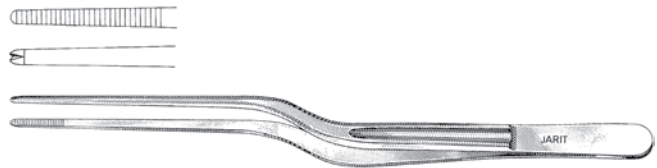

Brain Dressing and Tissue Forceps

7" (176mm)

Catalog #	Description
285-118	Serrated
285-119	1 x 2 teeth

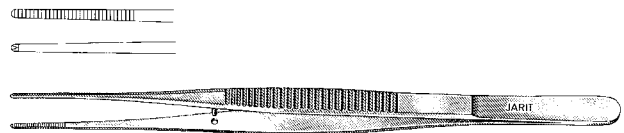

Gerald Dressing Forceps

narrow tips, serrated

Catalog #	Description
285-120	7" (175mm), straight, 1.3mm tips
285-121	7" (175mm), curved, 1.3mm tips
285-122	7½" (192mm), bayonet, 1.2mm tips
285-128	9¼" (233mm), straight, 1.1mm tips

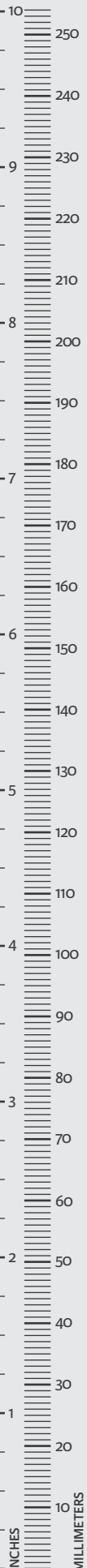
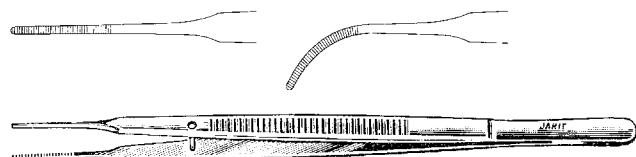

Gerald Tissue Forceps

narrow tips, 1 x 2 teeth

Catalog #	Description
285-125	7" (176mm), straight, 1.3mm tips
285-127	7½" (192mm), bayonet, 1.4mm tips
285-129	9¼" (233mm), straight, 1.4mm tips

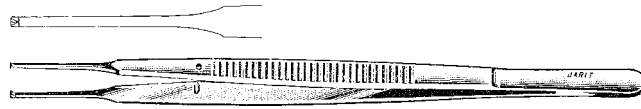

Gerald Dressing Forceps, Cardio-Grip

narrow tips, serrated

Catalog #	Description
285-126	7" (180mm)
285-130	9½" (240mm), 24mm length serrated tips

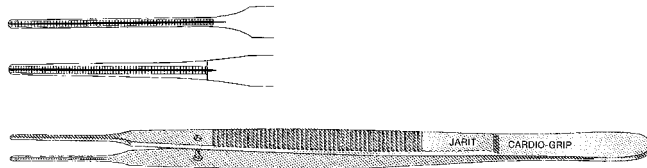

Adson Dressing Forceps, Bayonet

Catalog #	Description
285-140	7¾" (196mm), 2.4mm wide x 20mm length tips

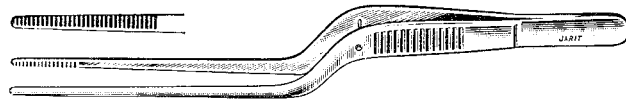

D'Errico Dressing and Tissue Forceps, Bayonet Handle

8¾" (222mm)

Catalog #	Description
285-147	Serrated, 3mm wide x 18mm length tips
285-148	1 x 2 teeth, 2.5mm wide tips

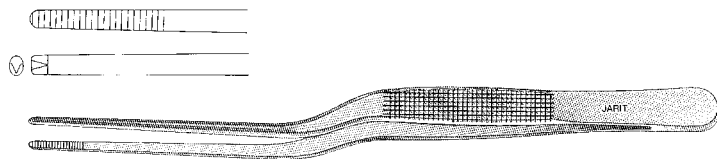

Adson Hypophyseal Forceps

bayonet shape

Catalog #	Description
285-170	9" (229mm), straight, 6mm round cup
285-171	8¾" (225mm), curved up, 6mm round cup
285-172	8¾" (225mm), curved down, 6mm round cup

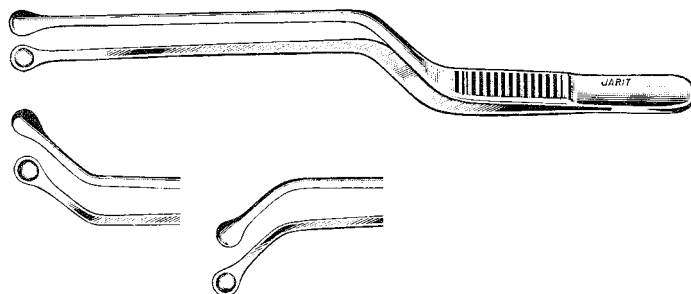

Eye Dressing Forceps, Delicate Pattern

3 7/8" (99mm), 0.5mm wide tip

Catalog #	Description
355-090	Straight
355-091	Half curved
355-092	Full curved

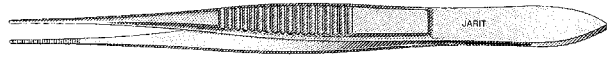

Eye Dressing Forceps, Standard Pattern

3 7/8" (99mm), 0.8mm wide tip

Catalog #	Description
355-100	Straight
355-101	Half curved
355-102	Full curved

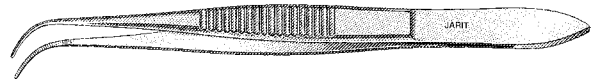
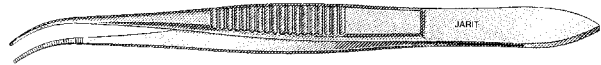

Iris Tissue Forceps, Delicate Pattern

3 7/8" (99mm), 0.6mm wide at tip, 1 x 2 teeth

Catalog #	Description
355-095	Straight
355-096	Half curved
355-097	Full curved

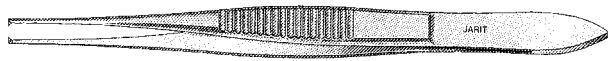

Iris Tissue Forceps, Standard Pattern

3 7/8" (99mm), 0.8mm wide tip, 1 x 2 teeth

Catalog #	Description
355-110	Straight
355-111	Half curved
355-112	Full curved

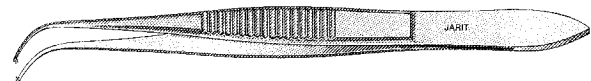
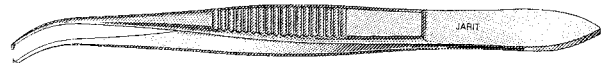

Lucae Ear Dressing Forceps

Catalog #	Description
380-100	5½" (140mm), 1.8mm wide x 16mm length serrations

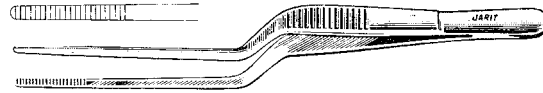

Jansen Ear Dressing Forceps

Catalog #	Description
380-105	6¼" (161mm), 2mm wide x 17mm length serrations

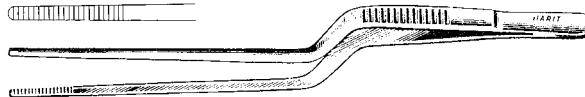

Wilde Ear Dressing Forceps

Catalog #	Description
380-110	4¾" (117mm), 2mm wide x 14.5mm length serrations

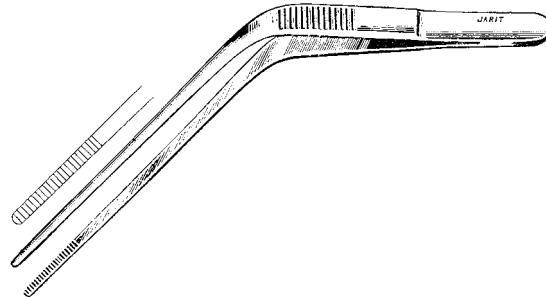

Jansen Nasal Dressing Forceps

Catalog #	Description
400-150	7¾" (195mm), 2.5mm wide x 18mm length serrations

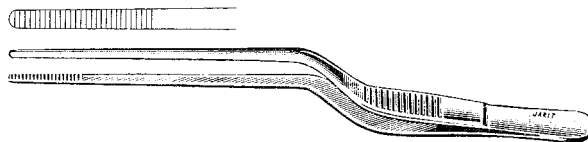

Gruenwald Nasal Dressing Forceps

Catalog #	Description
400-152	8½" (214mm), 2.2mm wide x 20mm length serrations

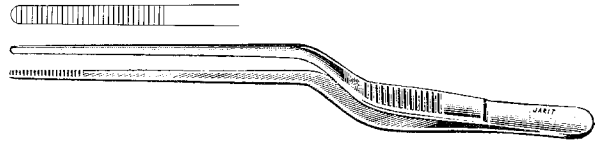

Wilde Nasal Dressing Forceps

Catalog #	Description
400-155	6¼" (158mm), 1.7mm wide x 15.5mm length serrations

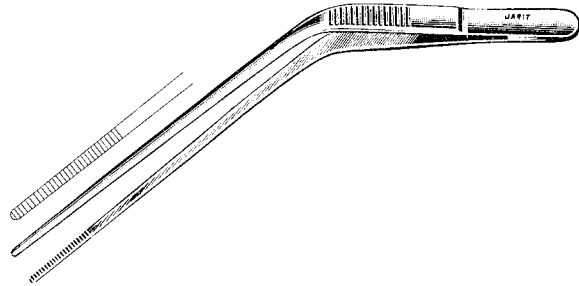

Jewelers Disposable Bipolar Forcep (insulated)

Catalog #	Description
286-100	4½" (114mm), straight, 0.4mm tip with 12' cord, 10/per



Jewelers Disposable Bipolar Forcep (non-insulated)

Catalog #	Description
286-101	4½" (114mm), straight, 0.4mm tip with 12' cord, 10/per



Adson Disposable Bipolar Forceps (insulated)

Catalog #	Description
286-102	4¾" (121mm), smooth, 1.0mm tip with 12' cord, 10/per



Adson Disposable Bipolar Forceps (non-insulated)

Catalog #	Description
286-103	4¾" (121mm), smooth, 1.0mm tip with 12' cord, 10/per



Cushing Disposable Bayonet Bipolar Forcep (insulated)

Catalog #	Description
286-104	7½" (190mm), smooth, 3½" (90mm) working length, 0.7mm tip with 12' cord, 10/per



Cushing Disposable Bayonet Bipolar Forcep (non-insulated)

Catalog #	Description
286-105	7½" (190mm), smooth, 3½" (90mm) working length, 0.7mm tip with 12' cord, 10/per



Scoville Disposable Bayonet Bipolar Forcep (insulated)

Catalog #	Description
286-106	7¾" (197mm), smooth, 2¾" (70mm) working length, 1.5mm tip with 12' cord, 10/per



Scoville Disposable Bayonet Bipolar Forcep (non-insulated)

Catalog #	Description
286-107	7¾" (197mm), smooth, 2¾" (70mm) working length, 1.5mm tip with 12' cord, 10/per



Hardy Disposable Bayonet Bipolar Forcep (insulated)

Catalog #	Description
286-108	8½" (215mm), smooth, 4½" (115mm) working length, 1.5mm tip with 12' cord, 10/per



Hardy Disposable Bayonet Bipolar Forcep (non-insulated)

Catalog #	Description
286-109	8½" (215mm), smooth, 4½" (115mm) working length, 1.5mm tip with 12' cord, 10/per



Hardy Disposable Bayonet Bipolar Forcep (insulated)

Catalog #	Description
286-110	8½" (215mm), smooth, 4½" (115mm) working length, 0.5mm tip with 12' cord, 10/per



Hardy Disposable Bayonet Bipolar Forcep (non-insulated)

Catalog #	Description
286-111	8½" (215mm), smooth, 4½" (115mm) working length, 0.5mm tip with 12' cord, 10/per



Disposable 12' Bipolar Cord with Banana Pin Connector

Catalog #	Description
286-112	10/per

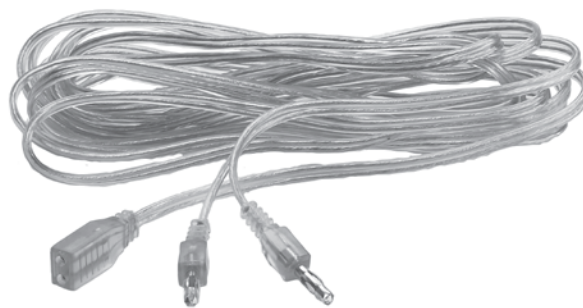

Plain Splinter Forceps

Catalog #	Description
130-500	3 ³ / ₈ " (87 mm)
130-505	4 ⁵ / ₈ " (118mm)

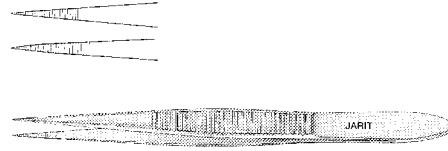

Feilchenfeld Splinter Forceps

Catalog #	Description
130-510	3 ¹ / ₈ " (79 mm)
130-515	4 ¹ / ₂ " (115mm)

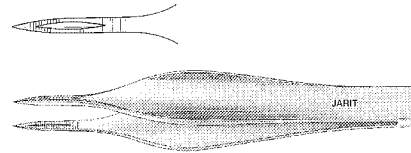

Carmalt Splinter Forceps

Catalog #	Description
130-520	4 ¹ / ₈ " (106mm), straight
130-525	4 ¹ / ₈ " (106mm), angled

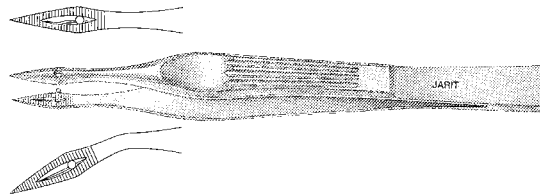

Virtus Splinter Forceps

Catalog #	Description
130-530	5 ⁷ / ₈ " (150mm), straight

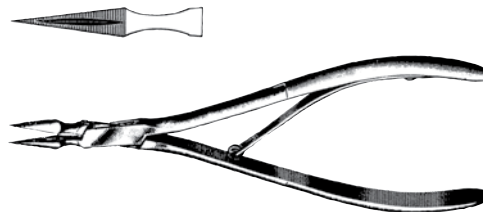

Williams Splinter Forceps

Catalog #	Description
130-535	5 ³ / ₈ " (135 mm), angled

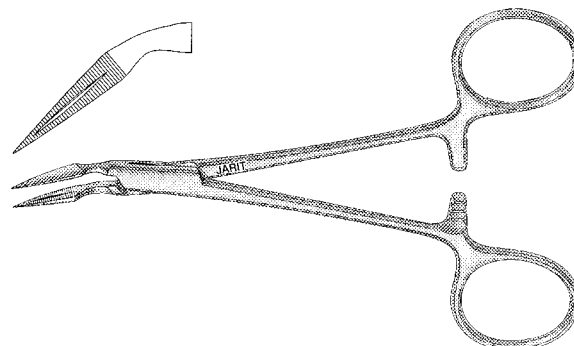

Petit-Point Allis Tissue Forceps

Catalog #	Description
135-095	5" (130mm), 4 x 5 teeth, 3mm wide jaws

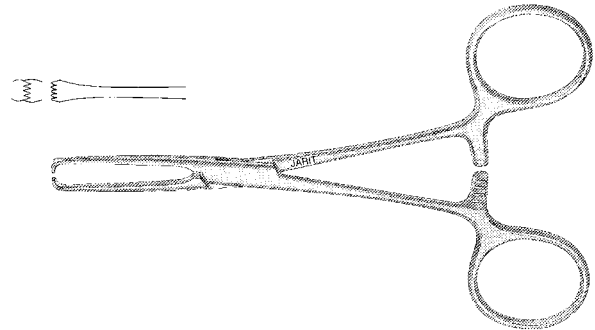

Allis Tissue Forceps, (Mirror Finish)

Manufactured from high grade German surgical stainless steel which is ground and polished to a mirror finish

Catalog #	Description
135-100	6¼" (156mm), 4 x 5 teeth, 5.75mm wide jaws
135-105	6¼" (156mm), 5 x 6 teeth, 7mm wide jaws

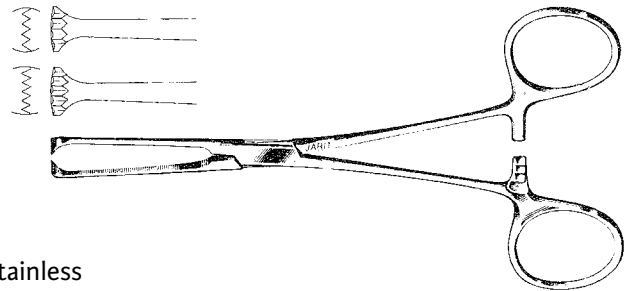

Allis Tissue Forceps, (Matte Finish)

Manufactured from high grade German surgical stainless steel which is glass beaded to a matte finish

Catalog #	Description
136-100	6¼" (156mm), 4 x 5 teeth, 5.75mm wide jaws
136-105	6¼" (156mm), 5 x 6 teeth, 7mm wide jaws

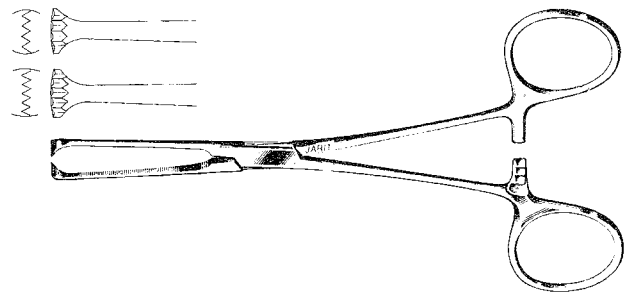

Allis Tissue Forceps

Catalog #	Description
135-109	7" (180mm), 90 deg angle, 5 x 6 teeth, 6mm wide jaws

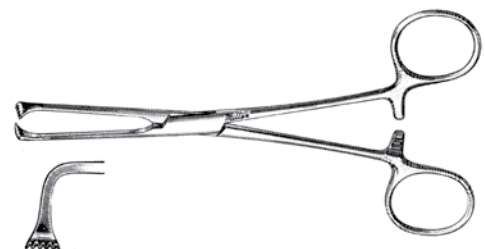

Allis Tissue Forceps, (Mirror Finish)

Manufactured from high grade German surgical stainless steel which is ground and polished to a mirror finish

Catalog #	Description
135-110	7½" (190mm), 5 x 6 teeth, 7.2mm wide jaws
135-111	7¾" (197mm), 5 x 6 teeth, delicate, 5.4mm wide jaws

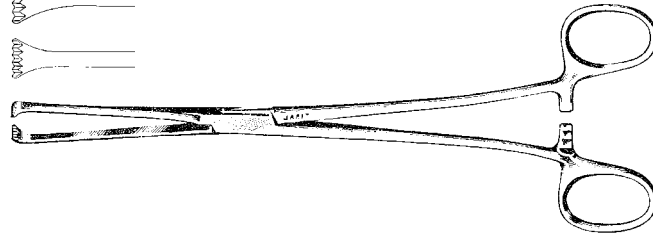
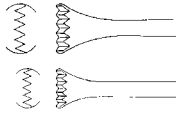

Allis Tissue Forceps, (Matte Finish)

Manufactured from high grade German surgical stainless steel which is glass beaded to a matte finish

Catalog #	Description
136-110	7½" (190mm), 5 x 6 teeth, 7.2mm wide jaws

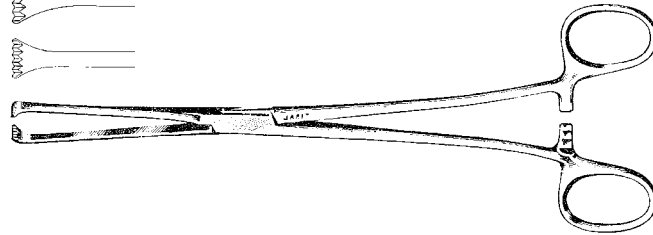
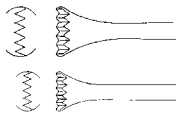

Allis Atraumatic Tissue Forceps

2 rows of fine, non-traumatic teeth

Catalog #	Description
135-107	6" (154mm), 7.3mm wide jaws

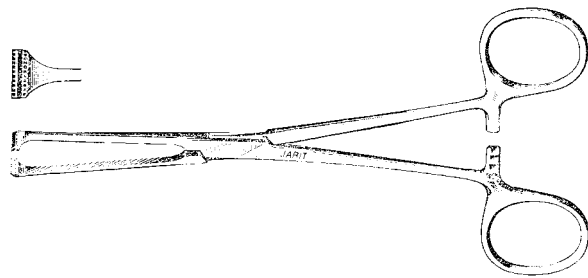

Judd-Allis Tissue Forceps

3 x 4 teeth

Catalog #	Description
135-115	6¼" (156mm), 4mm wide jaws
135-120	7½" (192mm), 4.3mm wide jaws

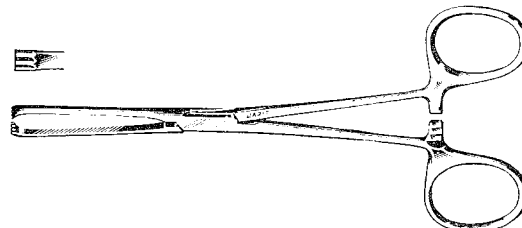

Thoms-Allis Tissue Forceps

6 x 7 teeth

Catalog #	Description
135-125	8" (203mm), 7.25mm wide jaws

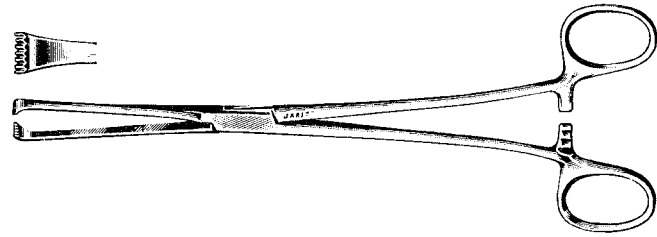

Boys-Allis Tissue Forceps

5 x 6 teeth

Catalog #	Description
135-127	6" (154mm), 5.2mm wide jaws

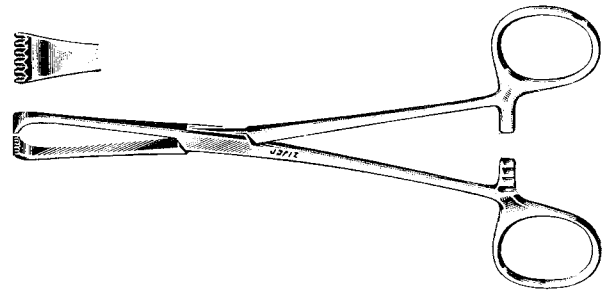

Allis-Adair Tissue Forceps

9 x 10 teeth

Catalog #	Description
135-130	6 1/4" (162mm), 10mm wide jaws

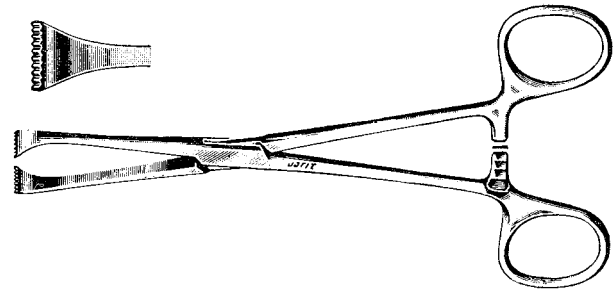

Lockwood-Allis Tissue Forceps

Catalog #	Description
135-135	6 1/4" (159mm), 6mm wide jaws

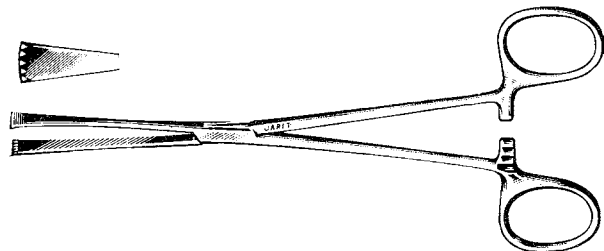

Collins Tissue Forceps

Catalog #	Description
135-150	8" (203mm), 5/8" (16mm) wide jaws
135-155	8" (203mm), 1" (26mm) wide jaws

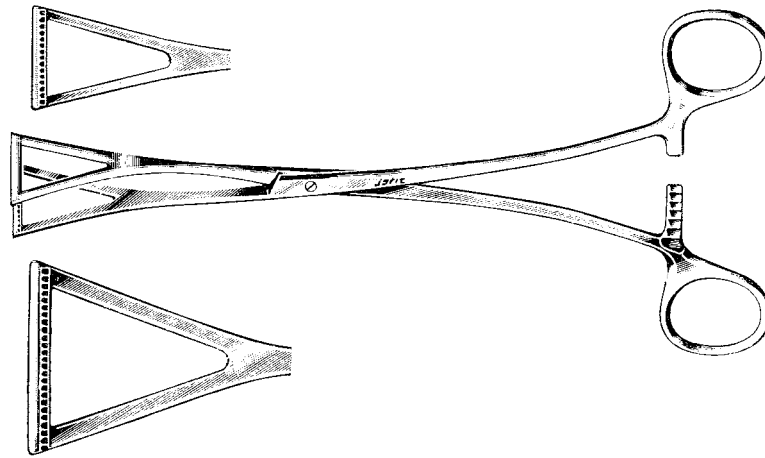

Williams Tissue Forceps

Catalog #	Description
135-175	6 1/2" (165mm)

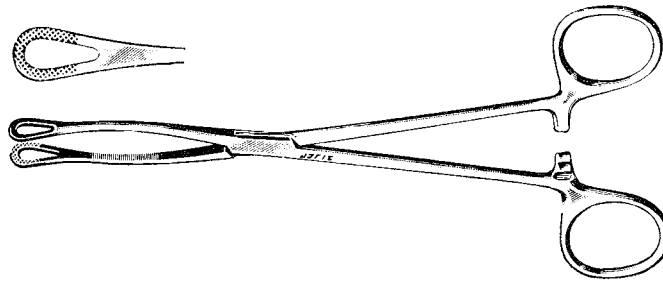

Petit-Point Babcock Tissue Forceps

Catalog #	Description
135-179	5 7/8" (148mm), 5.6mm wide jaws
135-180	6" (155mm), 7.5mm wide jaws

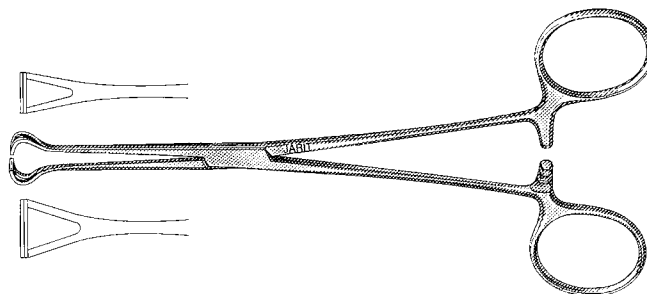

Babcock Tissue Forceps, (Mirror Finish)

Manufactured from high grade German surgical stainless steel which is ground and polished to a mirror finish

Catalog #	Description
135-181	6" (155mm), 8mm wide jaws
135-185	7¼" (185mm), 10.5mm wide jaws
135-190	8" (203mm), 11mm wide jaws
135-195	9½" (242mm), 11.75mm wide jaws
135-196	11¾" (300mm), 11.3mm wide jaws
135-194	13¾" (350mm), 12mm wide jaws

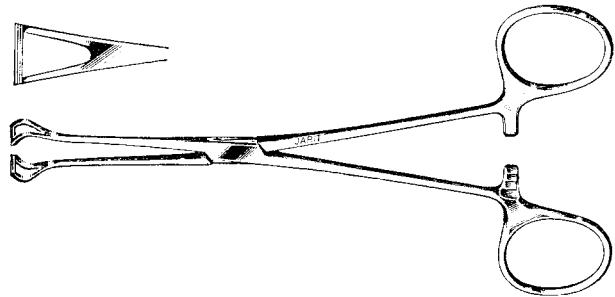

Babcock Tissue Forceps, (Matte Finish)

Manufactured from high grade German surgical stainless steel which is glass beaded to a matte finish

Catalog #	Description
136-181	6" (155mm), 8mm wide jaws
136-190	8" (203mm), 11mm wide jaws

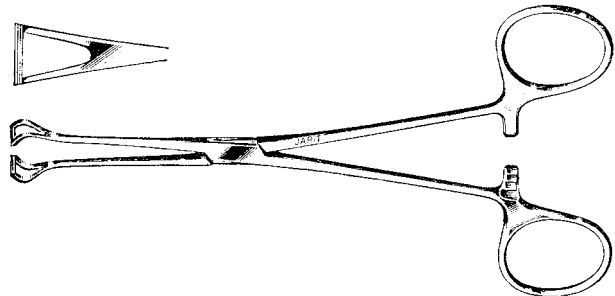

Babcock Tissue Forceps, Carb-Bite

Catalog #	Description
135-182	6½" (164mm), 8.5mm wide jaws
135-191	8¼" (210mm), 10.5mm wide jaws

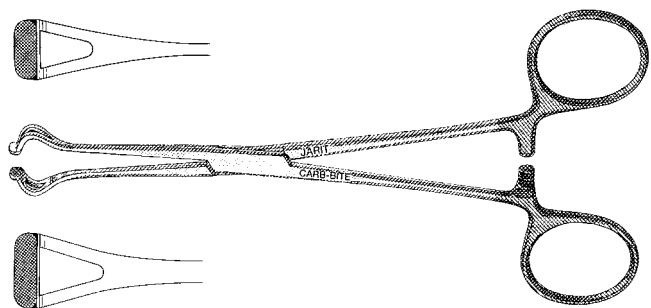

Benson Pylorus Spreader

Catalog #	Description
135-615	6¼" (160mm)

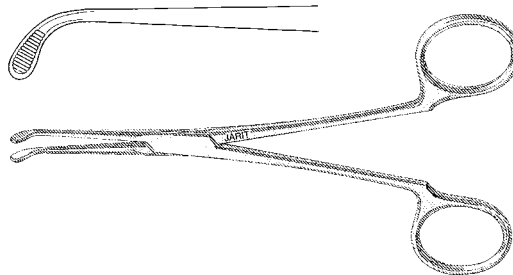

Adair Breast Clamp

Catalog #	Description
135-197	7¼" (182mm)

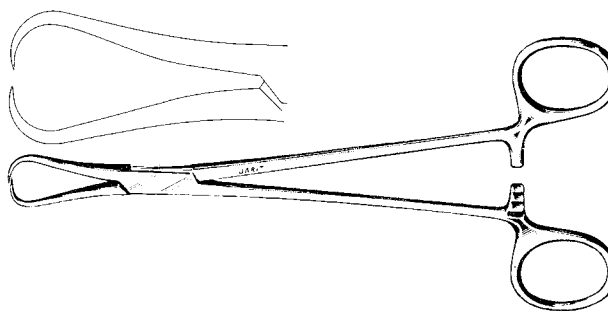

Pean Forceps

horizontal serrations

Catalog #	Description
135-260	10" (256mm), straight, jaw length 3½" (87.5mm)
135-261	10" (256mm), curved, jaw length 3½" (87.5mm)
135-262	11" (280mm), straight, jaw length 3½" (87.5mm)
135-265	11" (280mm), curved, jaw length 3½" (87.5mm)
135-263	12" (305mm), straight, jaw length 3½" (87.5mm)
135-266	12" (305mm), curved, jaw length 3½" (87.5mm)
135-264	14" (356mm), straight, jaw length 3½" (87.5mm)
135-267	14" (356mm), curved, jaw length 3½" (87.5mm)

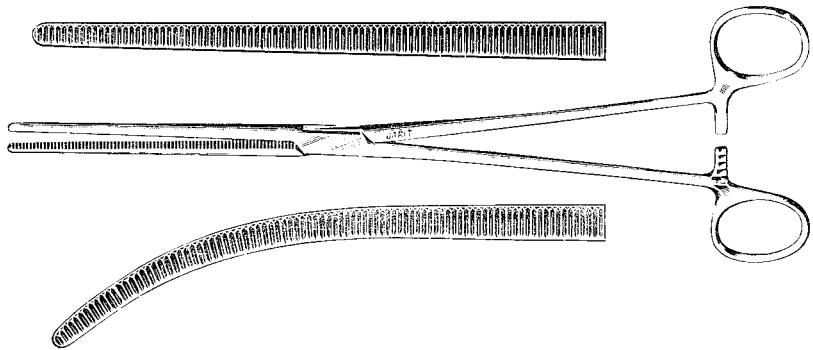

Pean Forceps

longitudinal serrations

Catalog #	Description
135-270	8" (205mm), straight, jaw length 2½" (63mm)
135-271	8" (205mm), curved, jaw length 2½" (63mm)
135-275	8¾" (225mm), straight, jaw length 3" (75mm)
135-276	8¾" (225mm), curved, jaw length 3" (75mm)
135-280	10" (255mm), straight, jaw length 3¾" (86mm)
135-281	10" (255mm), curved, jaw length 3¾" (86mm)

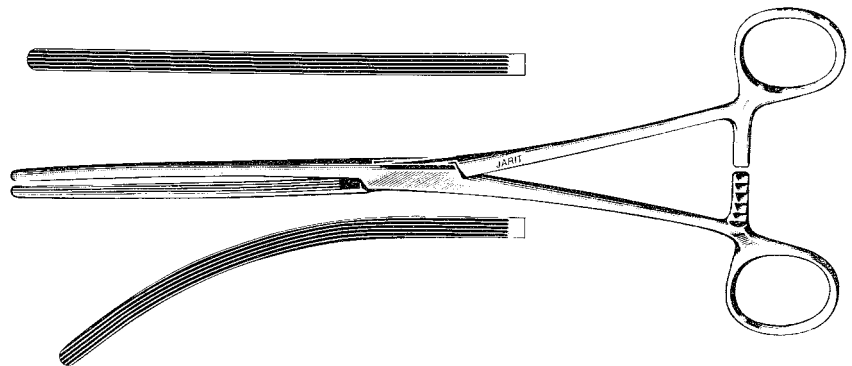

Allen Intestinal Clamps

longitudinal serrations, 1 x 2 teeth

Catalog #	Description
135-300	8" (205mm), jaw length 2 ³ / ₈ " (60mm)
135-301	6 ¹ / ₄ " (160mm), jaw length 2 ¹ / ₈ " (54mm), pediatric

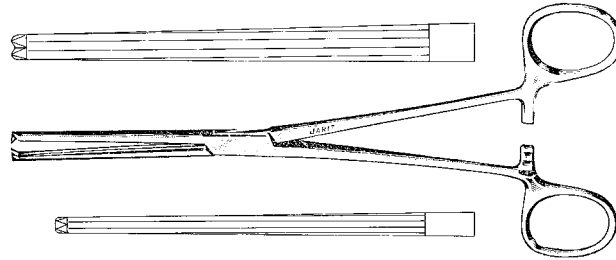

Dennis Anastomosis Clamp

Catalog #	Description
135-305	9 ¹ / ₄ " (234mm), jaw length 2 ¹ / ₈ " (54mm)

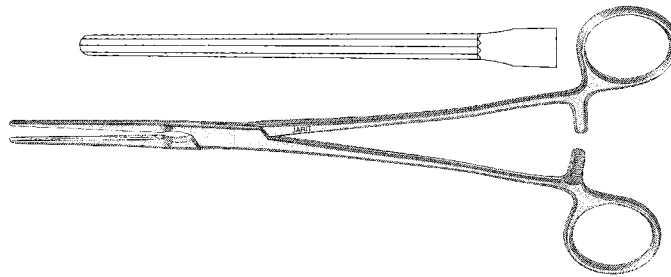

Baby Doyen Intestinal Clamps

diagonal serrations

Catalog #	Description
135-340	7" (175mm), straight, 61mm jaws
135-345	6 ³ / ₄ " (171mm), curved, 61mm jaws

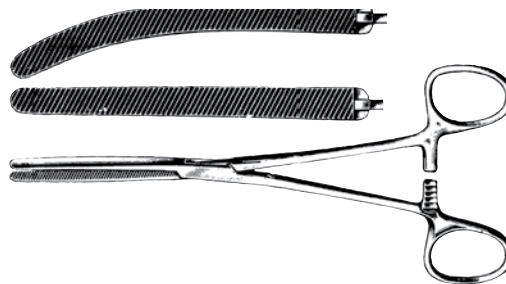

Doyen Intestinal Clamps

diagonal serrations

Catalog #	Description
135-350	9 ¹ / ₄ " (233mm), jaw length 4 ¹ / ₈ " (105mm), straight
135-355	9" (228mm), jaw length 3 ⁷ / ₈ " (95mm), curved

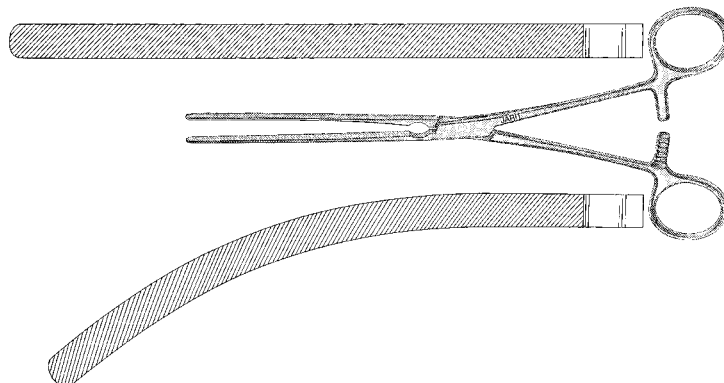

Doyen Intestinal Clamps, Cardio-Grip

Catalog #	Description
325-150	9½" (240mm), jaw length 3⅞" (98mm), straight
325-151	9½" (240mm), jaw length 3⅞" (98mm), curved

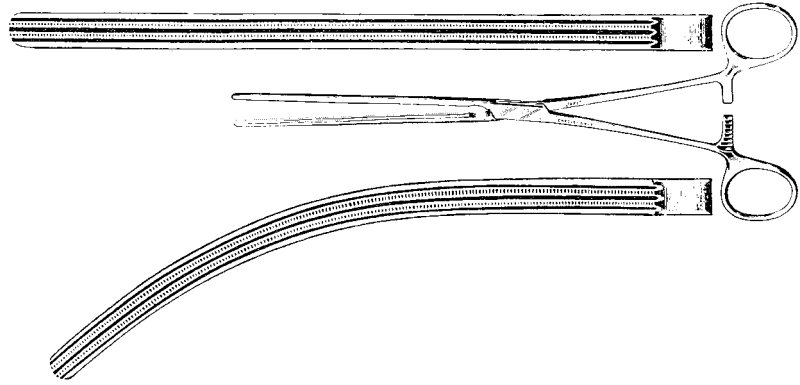

Mayo-Robson Intestinal Clamp
longitudinal serrations

Catalog #	Description
135-370	10" (252mm), jaw length 4½" (114mm), straight
135-375	9¾" (245mm), jaw length 4¼" (107mm), curved

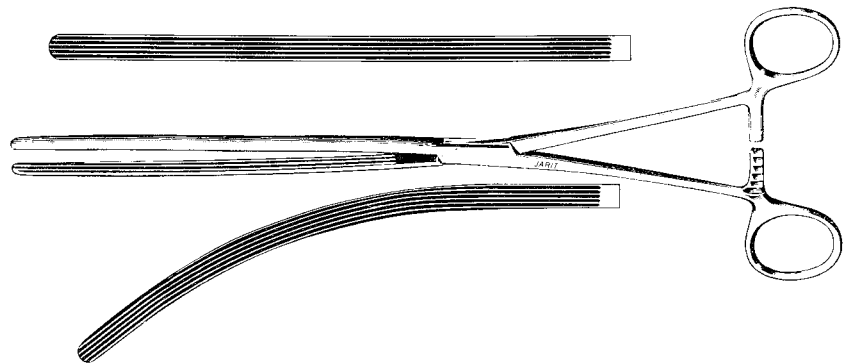

Fehland Intestinal Clamp

Catalog #	Description
135-400	10" (257mm), jaw length 3½" (89mm)

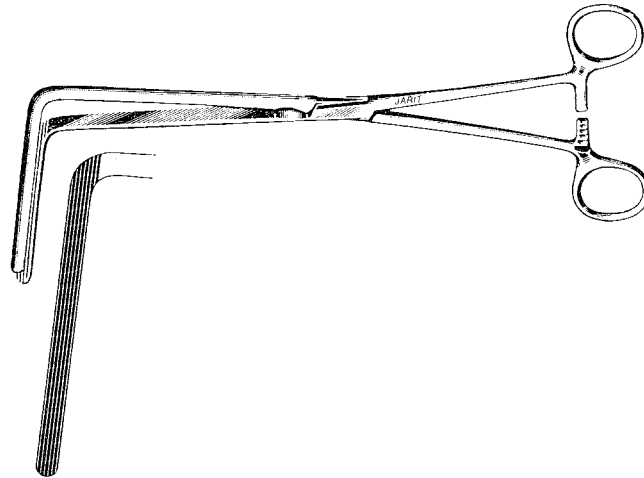

Stone Intestinal Clamp with locking device

Catalog #	Description
135-430	3¾" (85mm)
135-435	4¾" (110mm)



Stone Clamp Locking Device

Catalog #
135-440



Stone Clamp Applying Forceps

Catalog #	Description
135-445	6¼" (156mm)

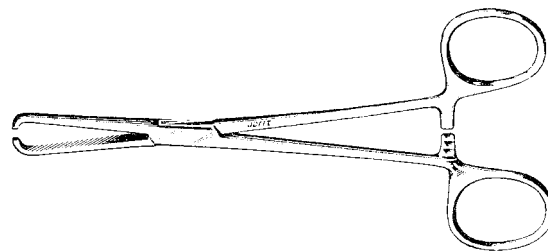

Stone Intestinal Clamp Set

includes: 2 applying forceps, 2 intestinal clamps, 2 locking devices

Catalog #	Description
135-450	3 ³ / ₈ " (85mm)
135-451	4 ³ / ₈ " (110mm)

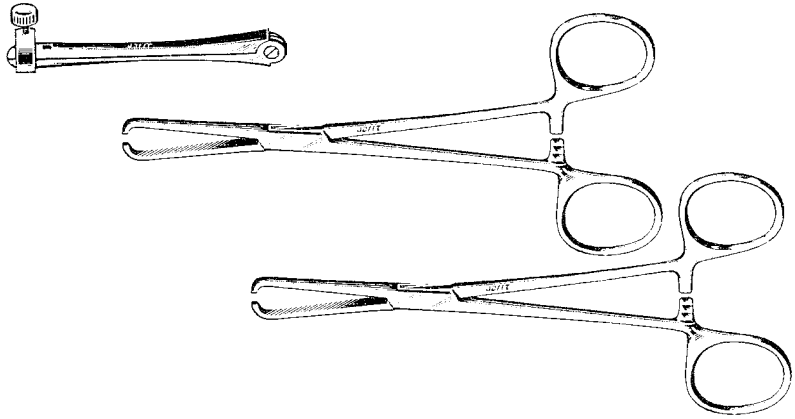

Demartel-Wolfson Closing Forceps

Catalog #	Description
135-500	9 ³ / ₄ " (249mm)

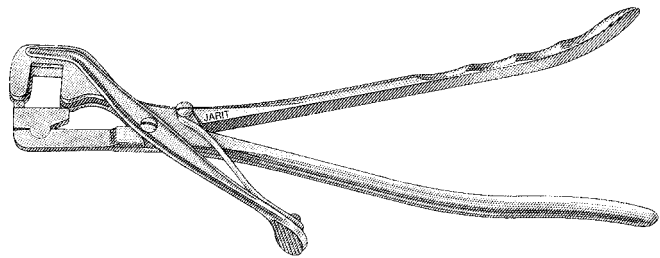

Demartel-Wolfson Clamp Holder

Catalog #	Description
135-502	2 ¹ / ₂ " (64mm)

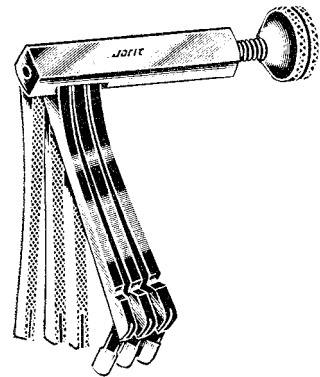

Demartel-Wolfson Clamp Holder

Catalog #	Description
135-504	7 ³ / ₄ " (200mm)

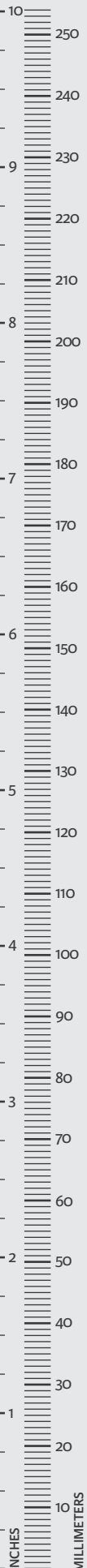

Demartel-Wolfson Clamps

set of 3

Catalog #	Description
135-505	27/8" (74mm)
135-506	31/2" (89mm)
135-507	45/8" (118mm)

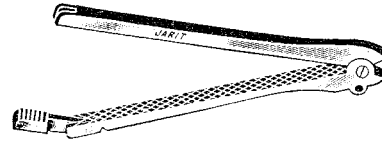

Payr Pylorus Clamp, Pediatric

Catalog #	Description
135-598	61/4" (159mm), jaw length 21/4" (57mm)

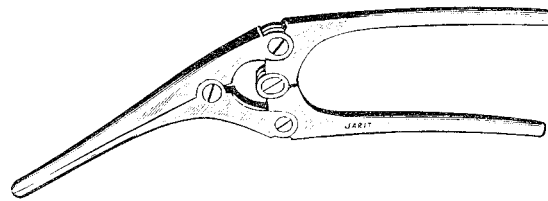

Payr Pylorus Clamps

Catalog #	Description
135-600	8" (202mm), jaw length 21/2" (63mm)
135-605	103/4" (273mm), jaw length 4" (102mm)

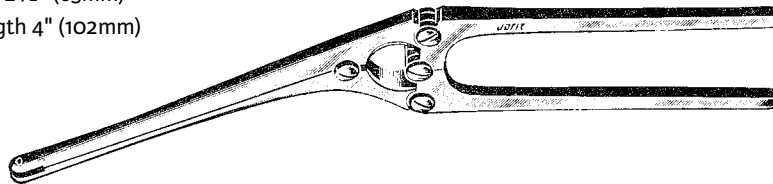

Glassman Intestinal Clamps, Cardio-Grip

Catalog #	Description
325-140	91/4" (235mm), straight, jaw length 3" (75mm)
325-141	91/4" (233mm), angled 25°, jaw length 23/4" (70mm)

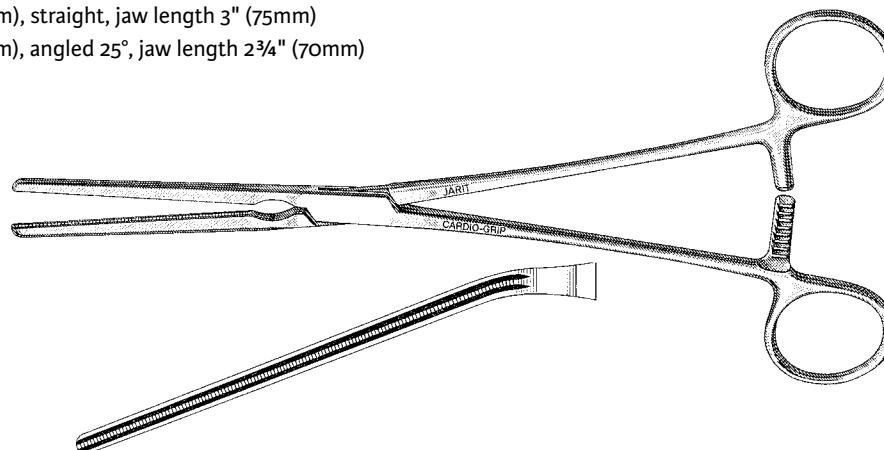

Glassman Anterior Resection Clamps, Cardio-Grip

Catalog #	Description
325-142	9 3/4" (250mm), jaw length 1" (25mm)
325-143	9 3/4" (250mm), jaw length 2" (52mm)
325-144	9 3/4" (250mm), jaw length 3" (75mm)

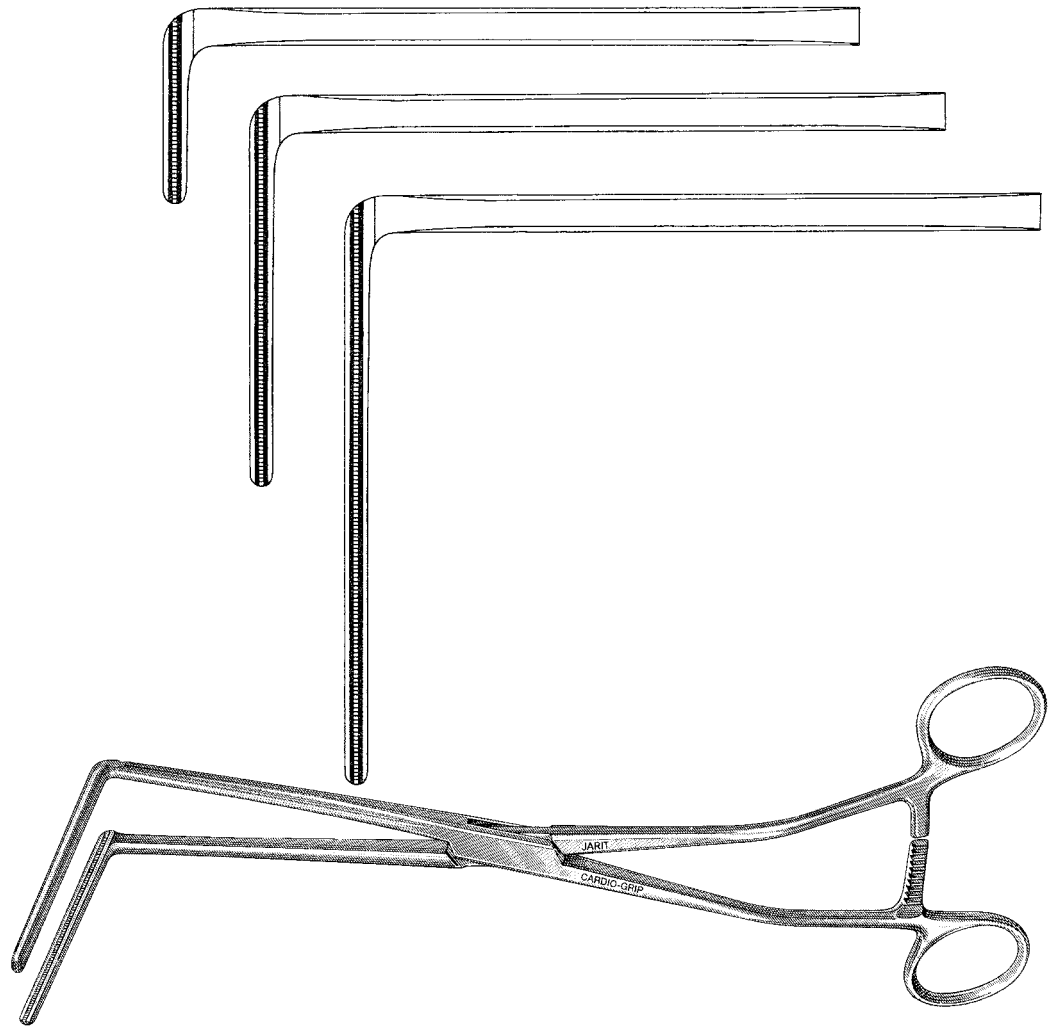

Hausmann Clamps, Straight Shanks

Catalog #	Description
320-340	7½" (192mm), jaw size 7⁄8" x 5⁄16" (22 mm wide x 8mm deep)
320-341	7¾" (195mm), jaw size 1⅛" x 5⁄16" (30 mm wide x 8mm deep)
320-342	8" (203mm), jaw size 1¼" x 5⁄16" (33 mm wide x 8mm deep)
320-343	8" (203mm), jaw size 1½" x 5⁄16" (38 mm wide x 8mm deep)

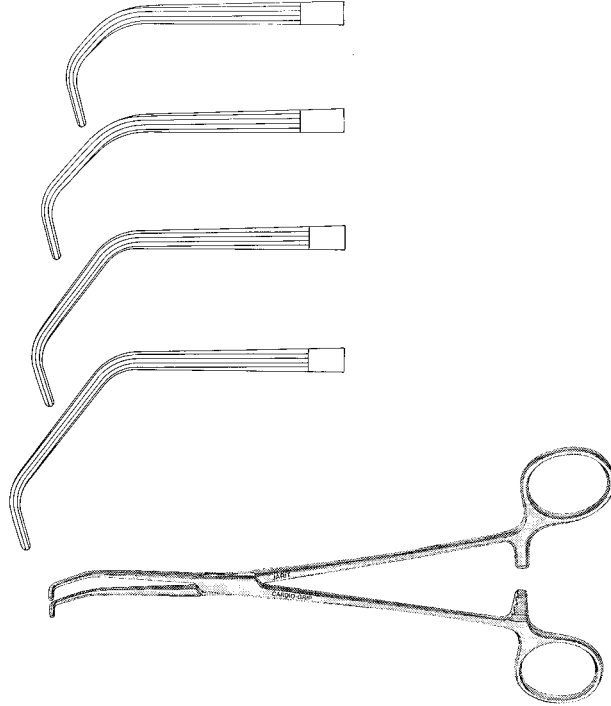

Hausmann Clamps, Angled Shanks

Catalog #	Description
320-344	7½" (192mm), jaw size 7⁄8" x 5⁄16" (22 mm wide x 8mm deep)
320-345	7¾" (195mm), jaw size 1⅛" x 5⁄16" (30 mm wide x 8mm deep)
320-346	8" (203mm), jaw size 1¼" x 5⁄16" (33 mm wide x 8mm deep)
320-347	8" (203mm), jaw size 1½" x 5⁄16" (38 mm wide x 8mm deep)

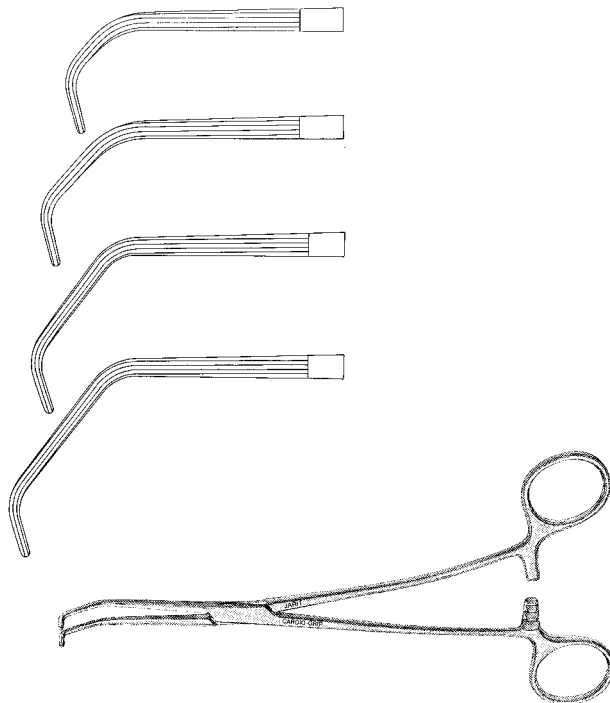

Hausmann Clamps, Straight Shanks

Catalog #	Description
320-350	8½" (215mm), straight jaws 1.9mm wide tip x 65mm length
320-351	8½" (215mm), curved jaws, 1.9mm wide tip x 65mm length
320-352	8½" (215mm), spoon jaws, 1.9mm wide tip x 65mm length

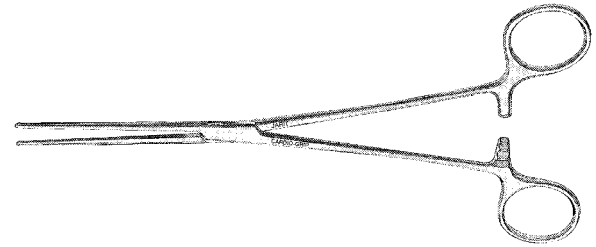
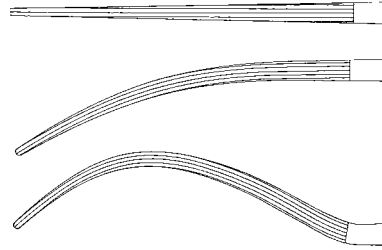

Hausmann Clamps, Angled Shanks

Catalog #	Description
320-353	8" (203mm), straight jaws, 1.9mm wide tip x 65mm length
320-354	8½" (215mm), curved jaws, 1.9mm wide tip x 65mm length
320-355	8½" (215mm), spoon jaws, 1.9mm wide tip x 65mm length

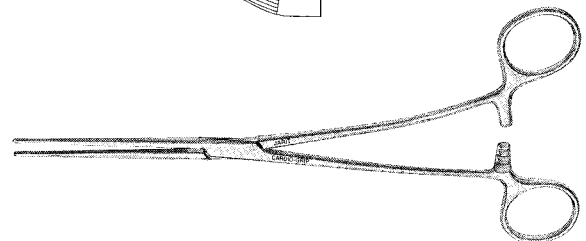
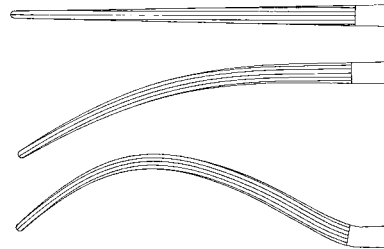

Bakes Common Duct Dilators

Catalog #	Description
140-100	8½" (215mm), set of 9
140-101	8½" (215mm), 3mm
140-102	8½" (215mm), 4mm
140-103	8½" (215mm), 5mm
140-104	8½" (215mm), 6mm
140-105	8½" (215mm), 7mm
140-106	8½" (215mm), 8mm
140-107	8½" (215mm), 9mm
140-108	8½" (215mm), 10mm
140-109	8½" (215mm), 11mm



Ferguson Gall Stone Scoops

double-ended

Catalog #	Description
140-154	9½" (239mm), small
140-155	9½" (239mm), medium
140-156	9½" (239mm), large

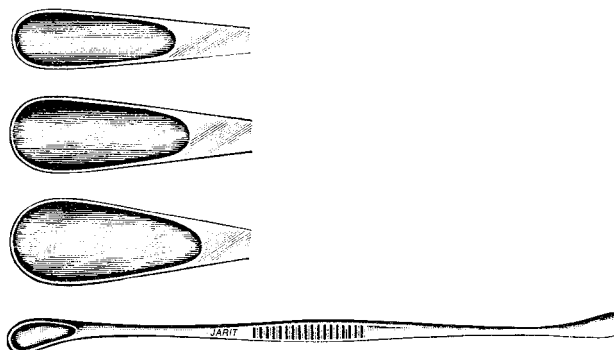

Desjardin Gall Stone Forceps

Catalog #	Description
140-175	9¼" (235mm)

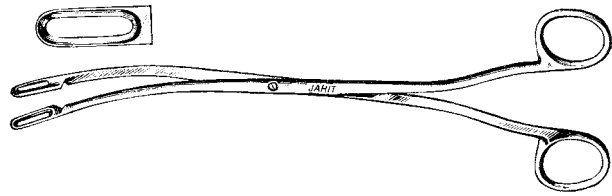

Blake Gall Stone Forceps

Catalog #	Description
140-190	8¼" (211mm), straight
140-192	8¼" (211mm), curved

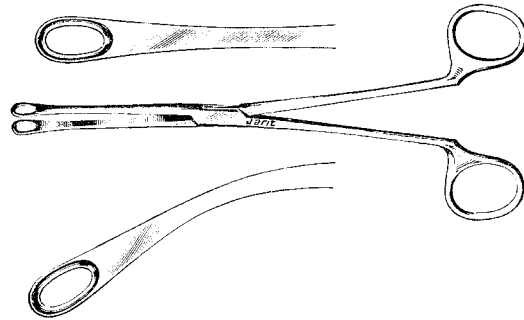

Lahey Gall Duct Forceps

Catalog #	Description
140-205	7½" (191mm), curved
140-206	7¾" (195mm), curved, delicate

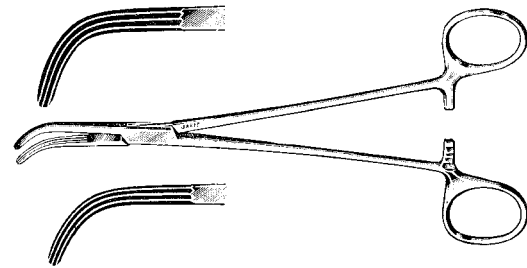

Lahey Gall Duct Forceps

Catalog #	Description
140-228	7½" (190mm), cross-serrated tips



Lower Gall Duct Forceps

Catalog #	Description
140-210	7¼" (185mm)

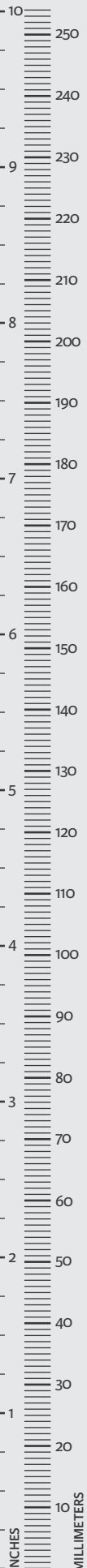
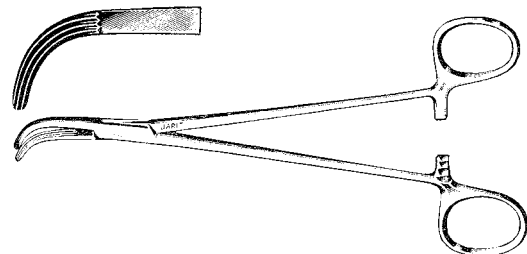

Mixer Forceps, Pediatric

Catalog #	Description
140-216	5 ³ / ₈ " (138mm), curved
140-217	5" (127mm), right angle



Petit-Point Mixer Forceps

right angle

Catalog #	Description
140-218	5 ³ / ₈ " (137mm)

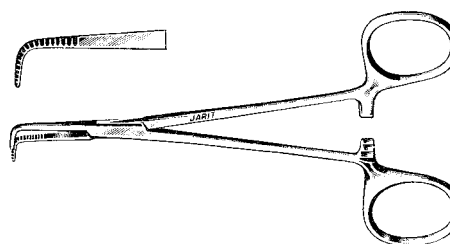

Petit-Point Mixer Forceps

right angle

Catalog #	Description
140-223	7 ¹ / ₄ " (185mm)

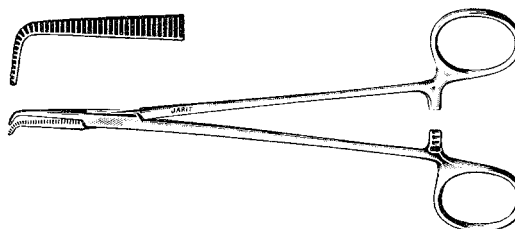

Mixer Forceps, Full Horizontal Serrations

Catalog #	Description
140-224	6 ¹ / ₄ " (160mm)
140-225	7" (175mm)

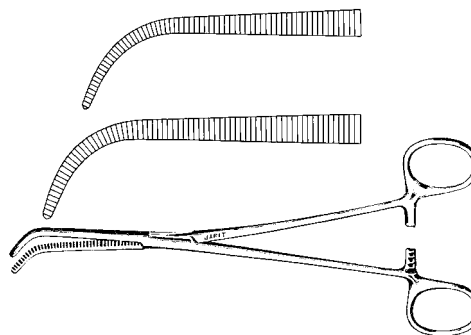

Mixer Forceps, Partial Horizontal Serrations

Catalog #	Description
140-226	8 ³ / ₄ " (224mm)
140-230	9 ¹ / ₄ " (232mm)

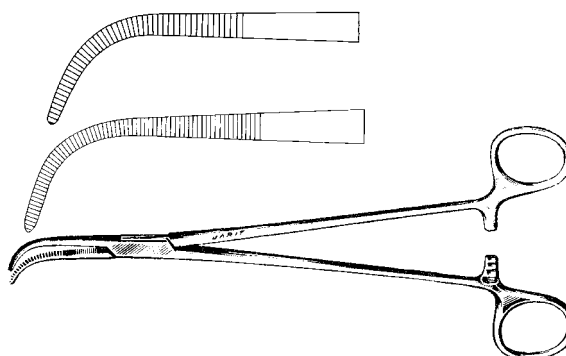

Meeker Clamp

Catalog #	Description
140-231	7¼" (181mm), right angle

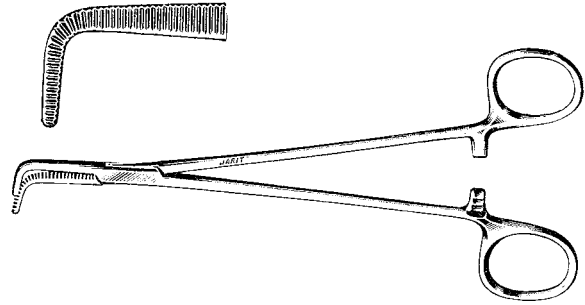

Diethrich Right Angle Clamps

Catalog #	Description
140-232	4⅞" (124mm)
140-233	5⅜" (138mm)
140-234	7" (180mm)

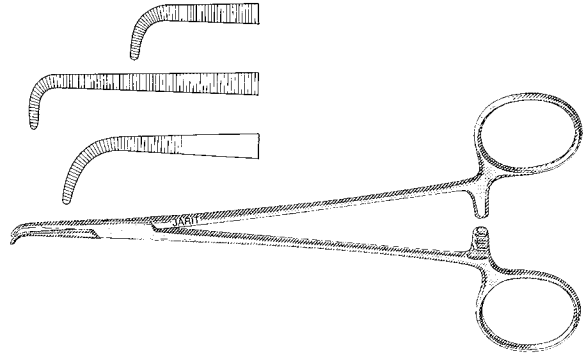

Varco Gallbladder Forceps

Catalog #	Description
140-240	7½" (192mm), slight curve
140-245	7¾" (197mm), full curve

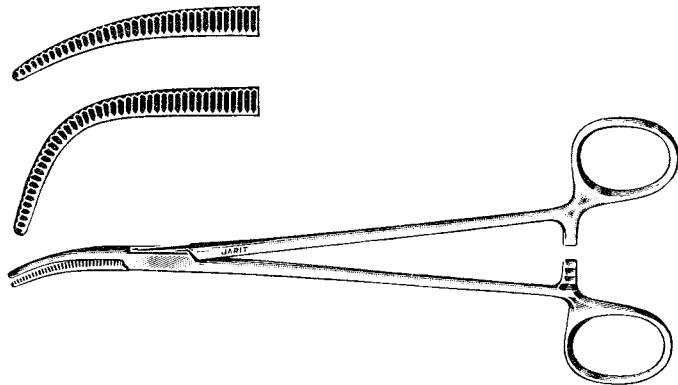

Thorek Gall Bladder Scissors

Catalog #	Description
140-320	7¼" (185mm), full curve
140-322	9" (230mm), full curve

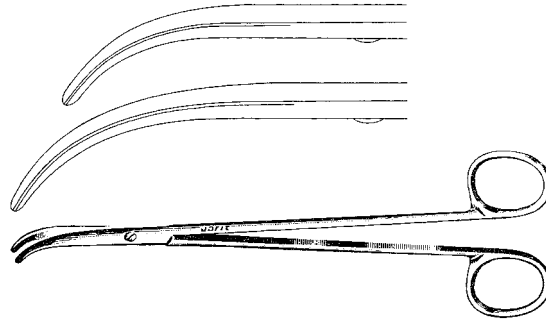

Gemini Artery Clamps

Catalog #	Description
140-329	5¾" (138mm)
140-330	7½" (190mm)
140-331	8¼" (205mm)
140-332	9" (230mm)
140-333	11" (280mm)
140-335	14¼" (360mm)

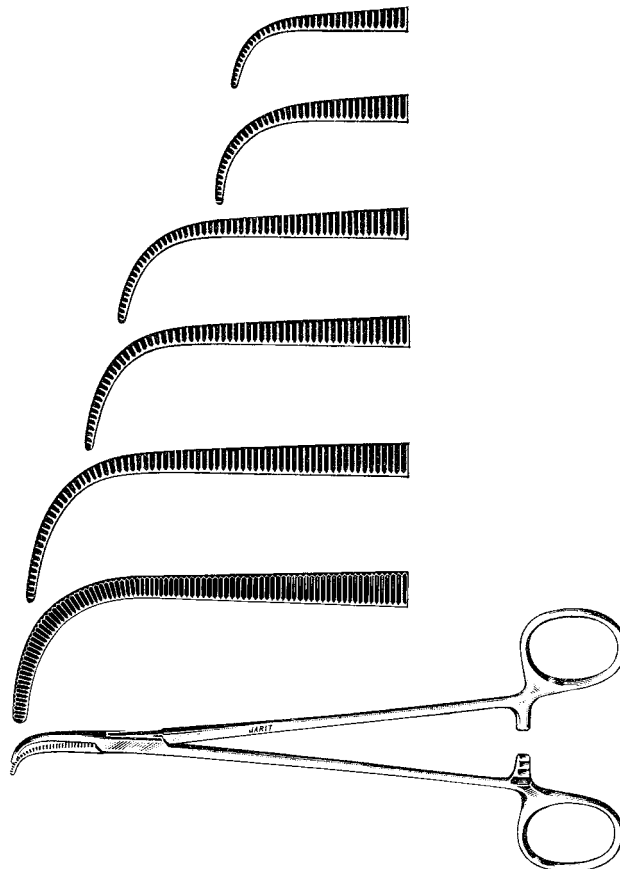

Lahey Traction Forceps

Catalog #	Description
150-160	6 1/4" (158mm), 9mm wide, 3 x 3 teeth
150-165	8" (203mm), 9.3mm wide, 3 x 3 teeth

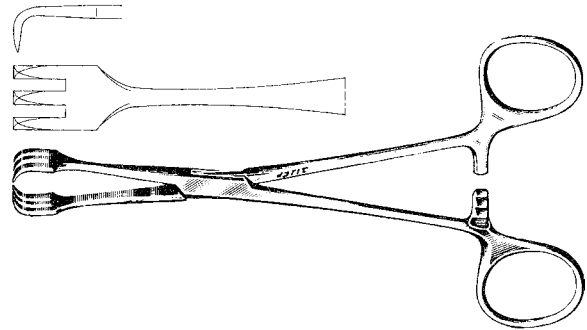

Lahey Hemostats

Catalog #	Description
150-175	6" (151mm), straight
150-180	6" (151mm), curved

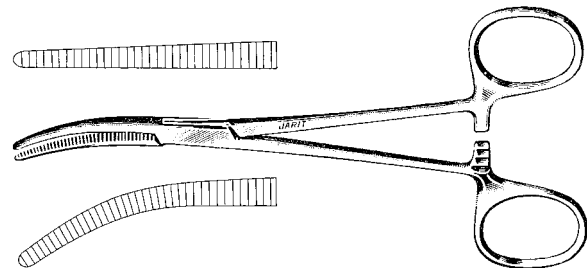

Mastin Muscle Clamp

curved shanks

Catalog #	Description
150-190	6 3/4" (167mm), 40mm jaw

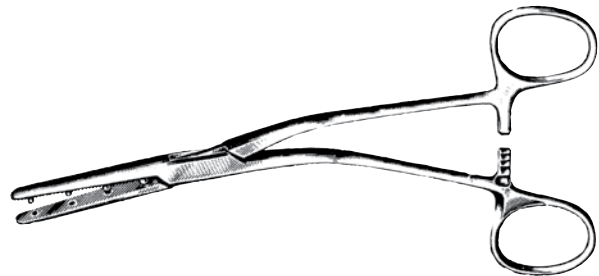

Nabatoff Vein Stripper

Catalog #	Description
160-120	Complete set in stainless steel sterilizing case

Replacement Parts

Catalog #	Description
160-HDL-120	T-handle
160-CBL-120	Cable 35"
160-OLV-120-3	3mm olive
160-OLV-120-6	6mm olive
160-OLV-120-9	9mm olive
160-OLV-120-12	12mm olive
160-TIP-120	Tip for suction tube pkg/12ea

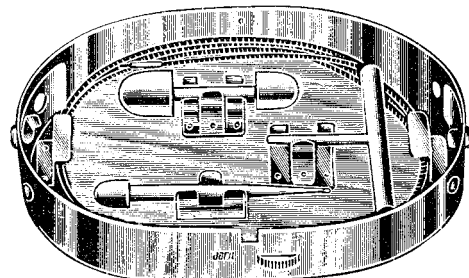
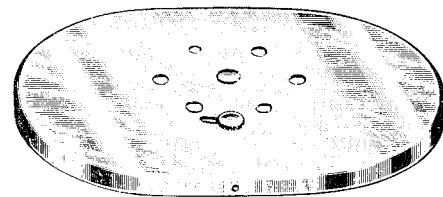

Poole Suction Tube

Catalog #	Description
170-100	9¾" (248mm), angular, 26 French

Poole Suction Tube Parts

Catalog #	Description
170-ITB-100	Inner tube
170-OTB-100	Outer tube



Poole Suction Tube

Catalog #	Description
170-101	7¾" (196mm), pediatric, angular, 17 French, stainless steel

Poole Suction Tube Parts

Catalog #	Description
170-ITB-101	Inner tube
170-OTB-101	Outer tube



Poole Suction Tubes

straight, 32 French

Catalog #	Description
170-102	9¾" (238mm)
170-103	12" (305mm)
170-104	15" (378mm)



Poole Suction Tube Parts

Catalog #	Description
170-ITB-102	Inner tube
170-OTB-102	Outer tube
170-ITB-103	Inner tube

Poole Abdominal Suction w/Control Valve

Catalog #	Description
170-105	10½" (269mm), stainless steel



Andrews-Pynchon Suction Tube

Catalog #	Description
170-115	9¼" (234mm)

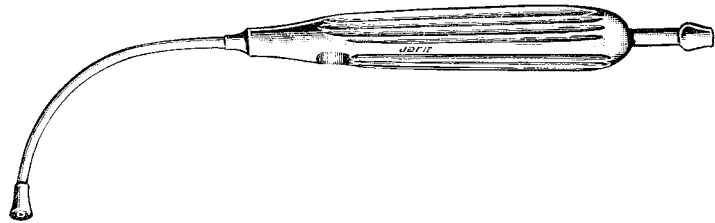

Yankauer Suction Tube

Catalog #	Description
170-118	8¼" (208mm), pediatric

Yankauer Suction Tube Parts

Catalog #	Description
170-119	Tip for pediatric suction tube pkg/12ea

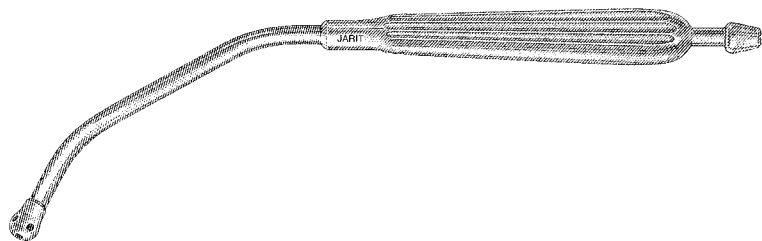

Yankauer Suction Tube

Catalog #	Description
170-120	11¼" (284mm)
170-117	15" (378mm)

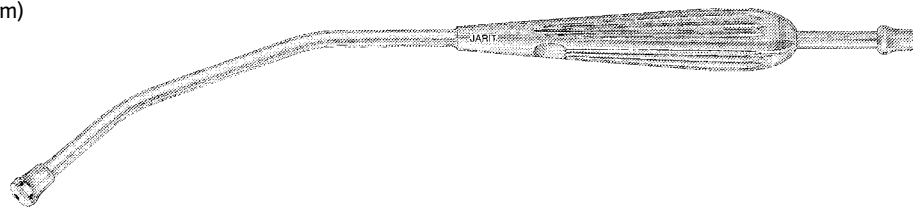

Yankauer Suction Tube w/Control Valve

Catalog #	Description
170-122	13" (330mm), stainless steel

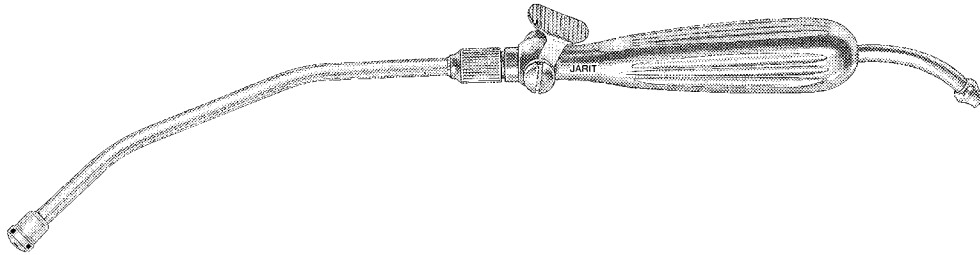

Coupland Suction Tube

Catalog #	Description
170-125	10" (254mm)

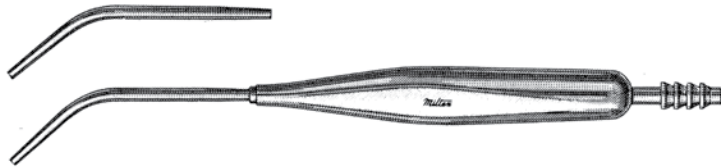

Catheter Guide (Wire Mandrin)

Catalog #	Description
170-175	18" (460mm), 4 French



Collins Tongue Seizing Forceps

Catalog #	Description
175-100	6¾" (170mm), small
175-105	7¼" (185mm), large

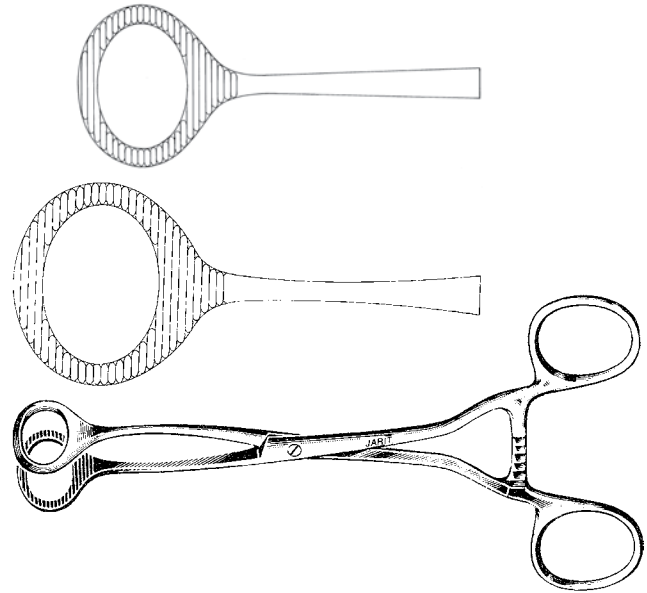

Young Tongue Seizing Forceps

Catalog #	Description
175-110	5⅞" (150mm)
175-111	Rubber (latex free) jaws only, set of 2

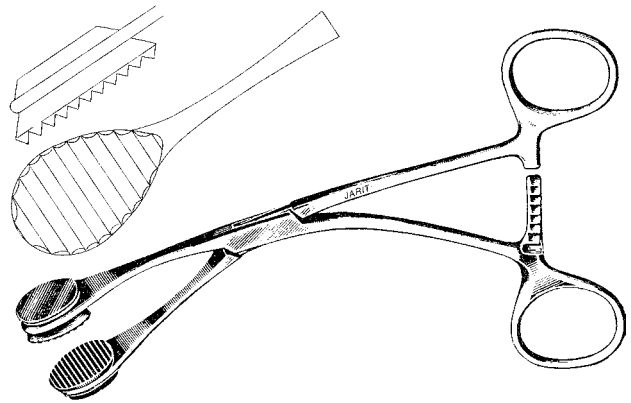

Magill Catheter Forceps

Catalog #	Description
175-120	9¾" (248mm), adult size
175-121	7¼" (184mm), pediatric size

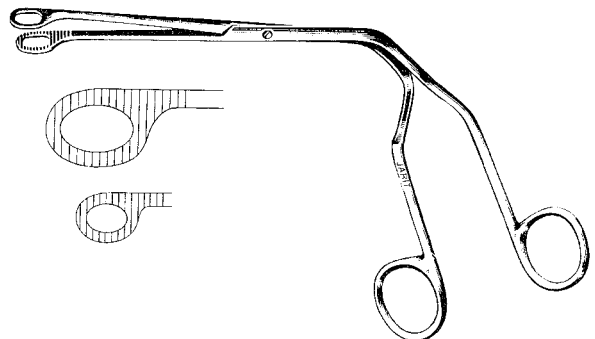

Taylor Percussion Hammers

solid handle

Catalog #	Description
180-100	7" (180mm), small
180-105	7¾" (196mm), large

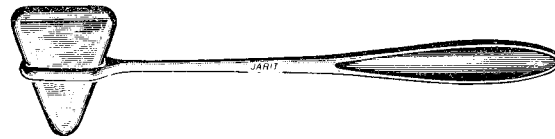

*Rubber inserts are Latex Free

Rabiner Neurological Hammer

Catalog #	Description
180-110	9¼" (235mm), rubber roller is latex free

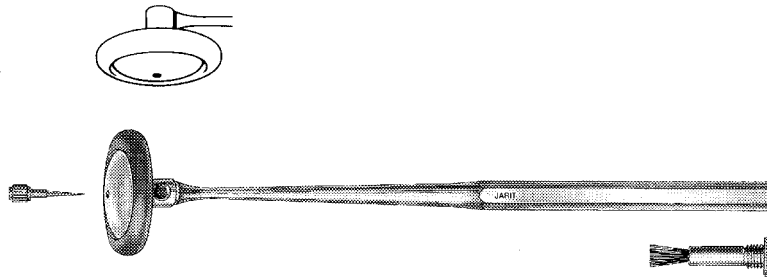

Buck Neurological Hammer

Catalog #	Description
180-115	7½" (190mm), small, rubber heads are latex free

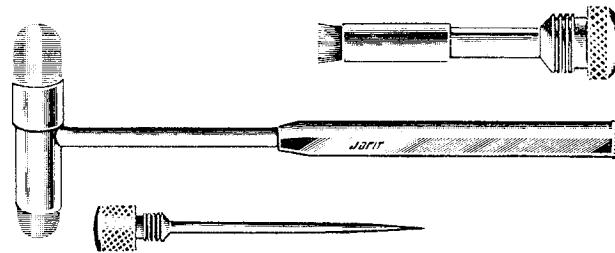

Wartenberg Pin Wheel

hollow handle

Catalog #	Description
180-130	7¾" (196mm)

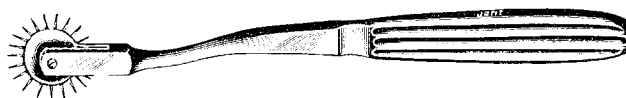

University of Illinois Bone Marrow Biopsy Needles

Catalog #	Description
180-175	3¾" (95mm), 1" (25mm) cannula, 18 gauge
180-176	3¾" (95mm), 1" (25mm) cannula, 15 gauge

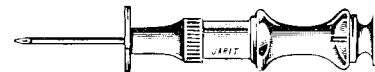

Laparotomy Rings

Catalog #	Description
180-180	1" (25mm)
180-182	1½" (38mm)
180-184	2" (51mm)
180-188	3" (76mm)

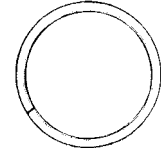

Probes with Eye, Stainless

Catalog #	Description
180-200	4½" (114mm)
180-201	5" (127mm)
180-202	5½" (140mm)
180-203	6" (152mm)
180-204	7" (178mm)
180-205	8" (203mm)
180-207	10" (254mm)



Probes, Double Ended, Stainless

Catalog #	Description
180-222	4½" (114mm)
180-223	5" (127mm)
180-224	5½" (140mm)
180-225	6" (152mm)
180-226	7" (178mm)
180-227	8" (203mm)
180-228	10" (254mm)



Probes with Eye, Silver

Catalog #	Description
180-231	4½" (114mm)
180-232	5" (127mm)
180-233	5½" (140mm)
180-234	6" (152mm)
180-235	7" (178mm)
180-236	8" (203mm)
180-238	10" (254mm)

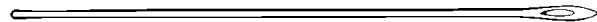

Grooved Directors

tongue tie, plain point, stainless

Catalog #	Description
180-250	4½" (114mm)
180-251	5" (127mm)
180-252	5½" (140mm)
180-253	6" (152mm)
180-255	8" (203mm)



Grooved Directors

tongue tie, probe point, stainless

Catalog #	Description
180-260	4½" (114mm)
180-261	5" (127mm)
180-262	5½" (140mm)
180-263	6" (152mm)
180-265	8" (203mm)



Saalfeld Comedone Extractor

Catalog #	Description
185-100	4¼" (108mm)

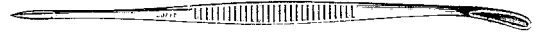

Saalfeld Comedone Extractor

Catalog #	Description
185-105	5⅞" (150mm)



Schamberg Comedone Extractor

Catalog #	Description
185-110	3¾" (96mm)



Unna Comedone Extractor

Catalog #	Description
185-115	5¾" (146mm)

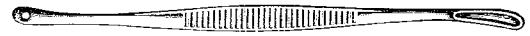

Comedone Extractor

Catalog #	Description
185-120	6¼" (157mm)



Finger Ring Cutter

Catalog #	Description
185-135	6¼" (160mm)
185-136	Replacement blade only
185-WSR-135	Replacement washer set

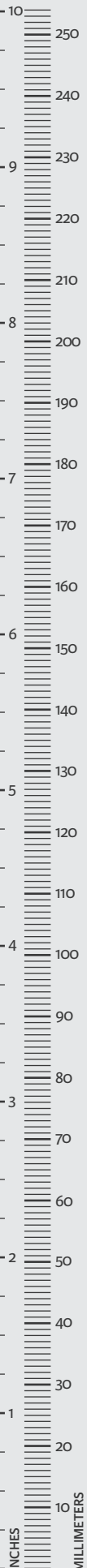
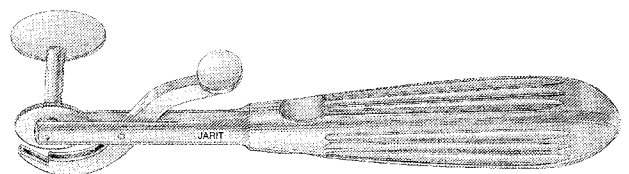

Keys Dermal Punch Set

Catalog #	Description
185-150	Set includes: 6 tips, 1 handle on instrument holder
185-152	2mm replacement head
185-153	3mm replacement head
185-154	4mm replacement head
185-155	5mm replacement head
185-156	6mm replacement head
185-157	7mm replacement head
185-HDL-150	Handle only

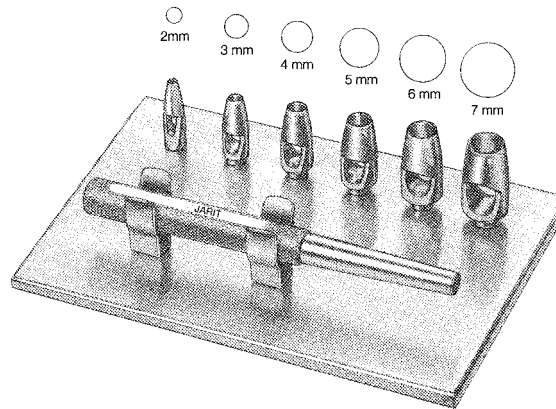

Keys Dermal Punches

Catalog #	Description
185-170	3 ⁷ / ₈ " (100mm), 2mm
185-171	3 ⁷ / ₈ " (100mm), 3mm
185-172	3 ⁷ / ₈ " (100mm), 4mm
185-176	3 ⁷ / ₈ " (100mm), 5mm
185-173	3 ⁷ / ₈ " (100mm), 6mm
185-174	3 ⁷ / ₈ " (100mm), 8mm
185-175	3 ⁷ / ₈ " (100mm), 10mm



Fox Dermal Currettes

Catalog #	Description
185-179	5 ⁵ / ₈ " (142mm), 2mm
185-180	5 ⁵ / ₈ " (142mm), 3mm
185-181	5 ⁵ / ₈ " (142mm), 4mm
185-182	5 ⁵ / ₈ " (142mm), 5mm
185-183	5 ⁵ / ₈ " (142mm), 6mm



Piffard Dermal Currettes

Catalog #	Description
185-185	6 ¹ / ₄ " (160mm), 4mm
185-186	6 ¹ / ₄ " (160mm), 5mm
185-187	6 ¹ / ₄ " (160mm), 6mm

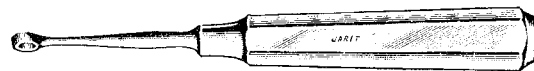

Nail Nippers

Catalog #	Description
185-191	4 ¹ / ₂ " (114mm), concave, stainless steel
185-193	5 ¹ / ₂ " (130mm), concave, stainless steel

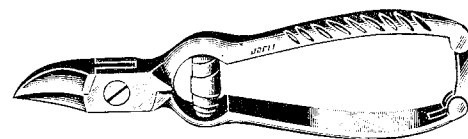

Nail Nippers

5" (127mm), straight

Catalog #	Description
185-196	Stainless steel

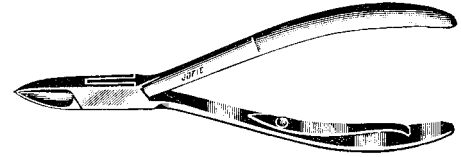

Nail Nippers

5½" (140mm), concave

Catalog #	Description
185-201	Stainless steel

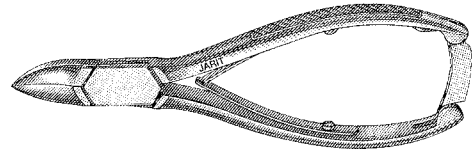

Nail Nippers

5½" (140mm), angled concave

Catalog #	Description
185-206	Stainless steel

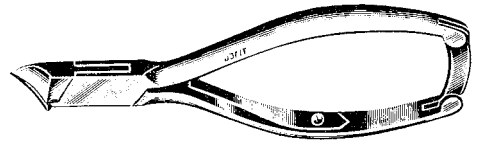

Nail Splitter, English Anvill Pattern

Catalog #	Description
185-210	5" (127mm), double spring (stainless)

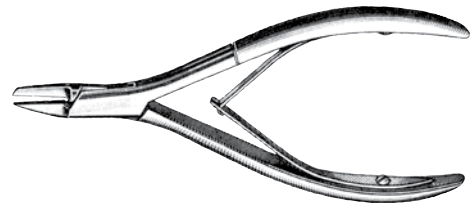

Cuticle Nippers

3¾" (100mm), convex

Catalog #	Description
185-231	Stainless steel

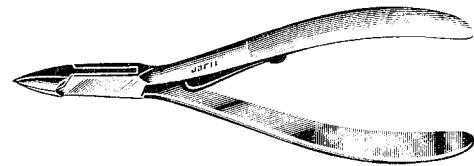

Cuticle Scissors

Catalog #	Description
185-250	3½" (88mm), curved

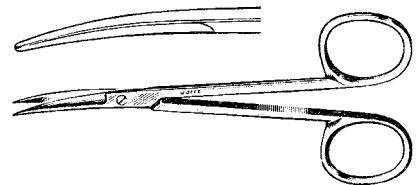

Nail Scissors

Catalog #	Description
185-260	3¾" (95mm), heavy

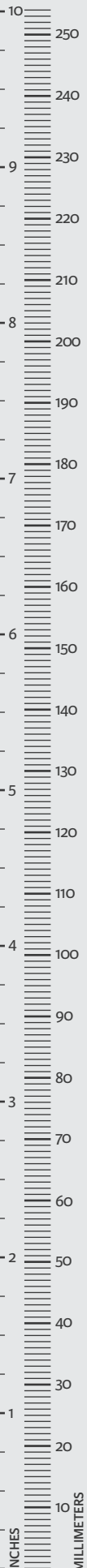
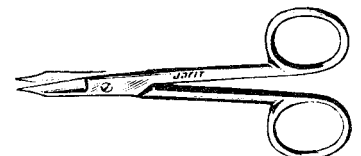

Flexible Shaft Retractors

5 7/8" (150mm)

Catalog #	Description
190-100	1 prong, sharp
190-101	2 prong, sharp, 4.2mm wide
190-102	3 prong, sharp, 8mm wide
190-103	1 prong, blunt
190-104	2 prongs, blunt, 4.2mm wide
190-105	3 prongs, blunt, 8mm wide

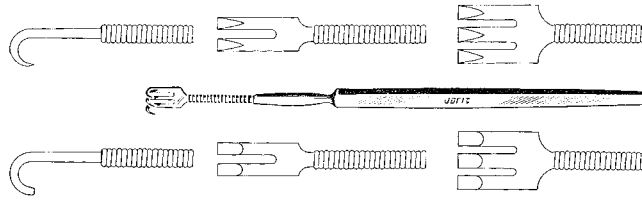

Senn Retractors, (Satin Finish)

double-ended, 8mm wide, solid blade 3/4" x 1/4" (19mm x 6.3mm)

Manufactured from high grade German surgical stainless steel which is ground and polished to a satin finish

Catalog #	Description
190-110	6 1/4" (160mm), 3-prong, sharp
190-112	6 1/4" (160mm), 3-prong, blunt

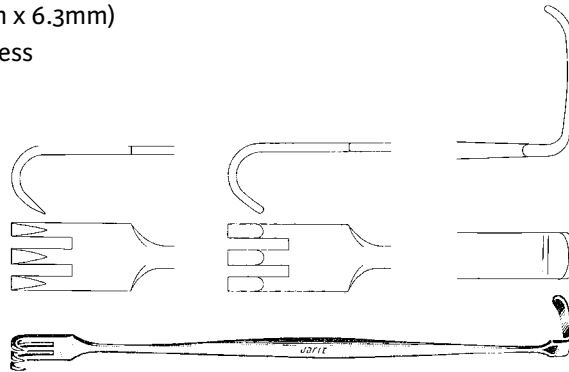

Senn Retractors, (Matte Finish)

double-ended, 8mm wide, solid blade 3/4" x 1/4" (19mm x 6.3mm)

Manufactured from high grade German surgical stainless steel which is glass beaded to a matte finish

Catalog #	Description
189-110	6 1/4" (160mm), 3-prong, sharp
189-112	6 1/4" (160mm), 3-prong, blunt

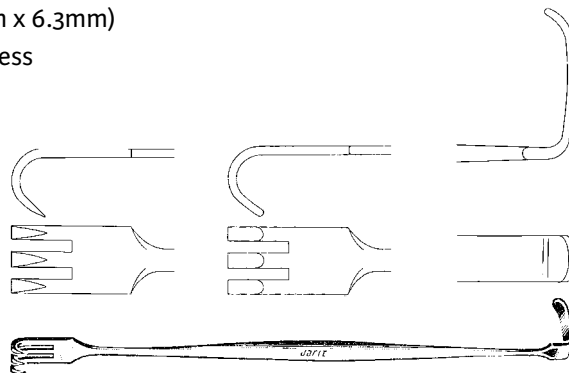

Mathieu Retractors

double-ended, 8mm wide, solid blade 3/4" x 1/4" (19mm x 6.3mm)

Catalog #	Description
190-115	6 1/4" (160mm), 3 sharp prongs
190-116	6 1/4" (160mm), 3 blunt prongs

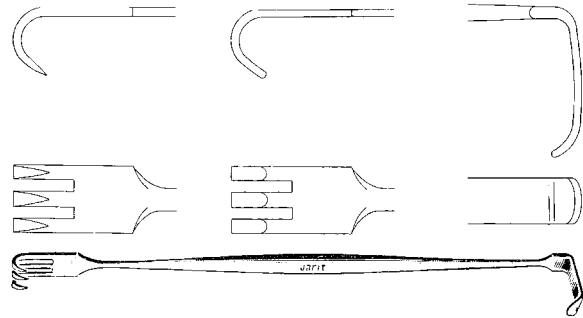

Rollet Retractor

Catalog #	Description
190-118	5 1/4" (132mm), 4 sharp prongs, 6mm wide

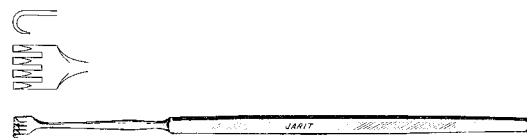

Knapp Retractor

Catalog #	Description
190-120	5 1/4" (132mm), 4 blunt prongs, 6mm wide

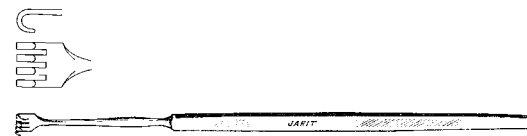

Miller Retractor

5 1/4" (133mm), 9-prong, 16mm wide

Catalog #	Description
410-225	Blunt
410-226	Sharp

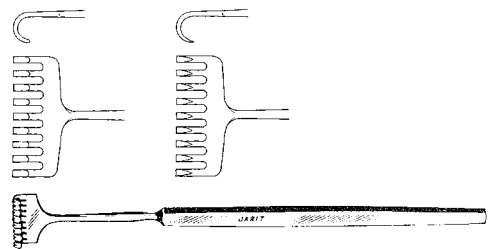

Meyerding Skin Hook and Retractor

Catalog #	Description
190-129	6" (155mm), solid blade 5/8" x 3/16" wide (16mm x 5mm)

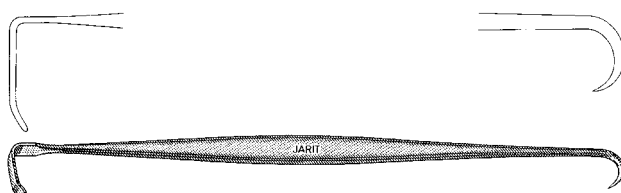

House Hand Retractor

Catalog #	Description
385-270	6" (152mm), double-ended, 6.5mm x 20mm and 9mm x 25mm blades

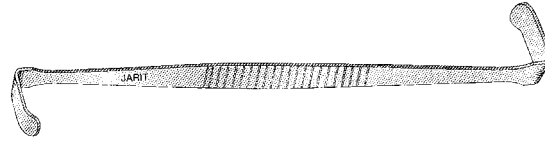

Ragnell Retractor

Catalog #	Description
410-220	6" (152mm), double-ended Small blade 2.85mm x 8.2mm Large blade 5.6mm x 14.5mm

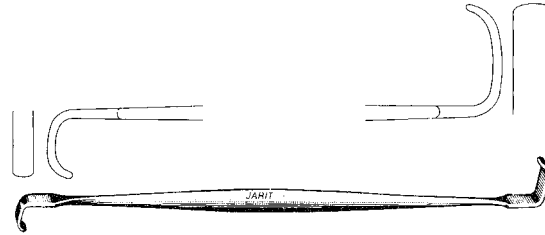

Davis Retractor

Catalog #	Description
410-230	5¾" (145mm), double-ended Small blade 5.8mm x 20mm Large blade 8.25mm x 25mm

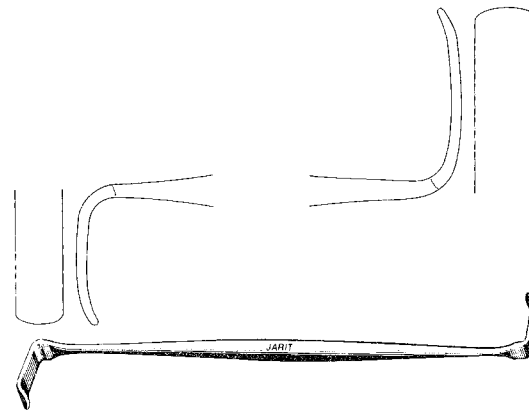

Meyerding Finger Retractors

7" (175mm)

Catalog #	Description
190-130	Style 1, 13/16" x 9/32" wide (21mm x 7.1mm)
190-131	Style 2, 5/8" x 3/16" wide (16mm x 5mm)
190-132	Style 3, 1/4" x 5/32" wide (6.3mm x 4mm)
190-133	Style 4, 3/8" x 1/8" wide (10mm x 3.2mm)
190-134	Style 5, 5/16" x 5/32" wide (8mm x 4mm)
190-135	Style 6, 1/4" x 5/16" wide (6.3mm x 8mm)

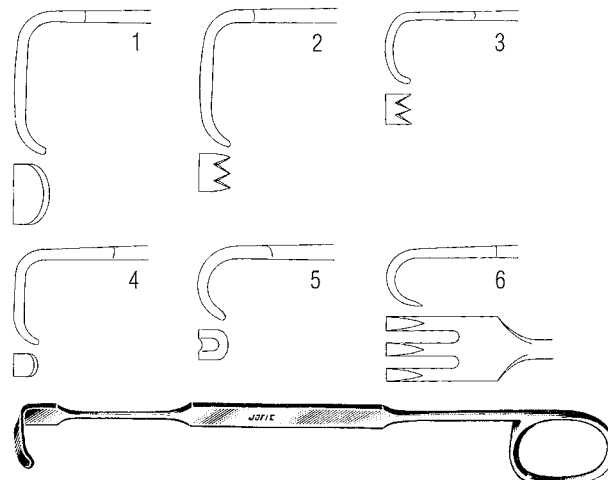

Finger Rake Retractors

6½" (165mm)

Catalog #	Description
190-150	1 prong, sharp
190-151	2 prongs, sharp, 5mm wide
190-152	3 prongs, sharp, 9mm wide
190-153	4 prongs, sharp, 12mm wide
190-154	1 prong, blunt
190-155	2 prongs, blunt, 5mm wide
190-156	3 prongs, blunt, 9mm wide
190-157	4 prongs, blunt, 12mm wide

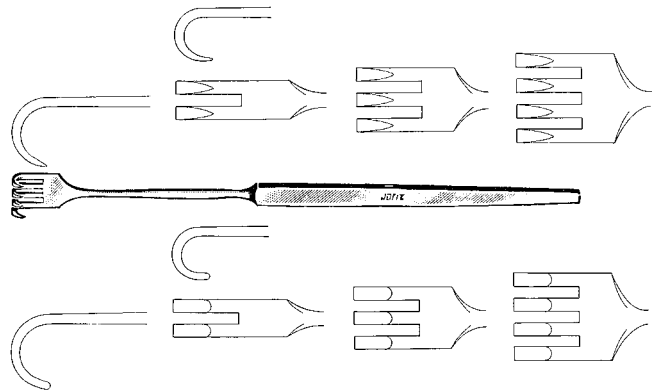

Volkman Retractors

4⅝" (118mm)

Catalog #	Description
190-170	2 prongs, sharp, 7.6mm wide
190-171	3 prongs, sharp, 9.15mm wide
190-172	4 prongs, sharp, 12.15mm wide
190-173	6 prongs, sharp, 19mm wide
190-175	2 prongs, blunt, 7.6mm wide
190-176	3 prongs, blunt, 9.15mm wide
190-177	4 prongs, blunt, 12.15mm wide
190-178	6 prongs, blunt, 19mm wide

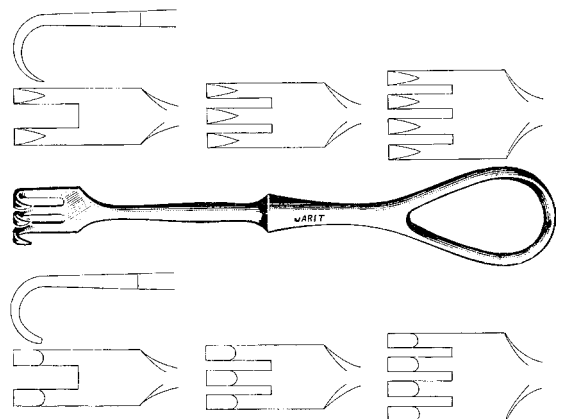

Mayo-Collins Retractor

Catalog #	Description
200-100	6" (152mm), double-ended, set of 2, blades $\frac{3}{4}$ " x $1\frac{1}{4}$ " deep and $\frac{3}{4}$ " x $1\frac{3}{8}$ " deep (18mm x 32mm and 19mm x 35mm)

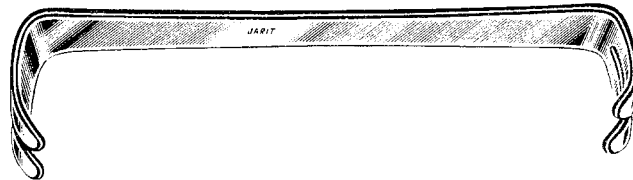

U.S. Army Retractor, (Satin Finish)

8 $\frac{1}{4}$ " (210mm), double-ended, blades $\frac{5}{8}$ " (15mm) wide, set of 2
Manufactured from high grade German surgical stainless steel which is ground and polished to a satin finish

Catalog #	Description
200-105	small blade: $1\frac{1}{8}$ " x $1\frac{3}{4}$ " (28mm x 44mm) large blade: $1\frac{3}{16}$ " x $1\frac{7}{8}$ " (30mm x 47mm)



U.S. Army Retractor, (Matte Finish)

8 $\frac{1}{4}$ " (210mm), double-ended, blades $\frac{5}{8}$ " (15mm) wide, set of 2
Manufactured from high grade German surgical stainless steel which is glass beaded to a matte finish

Catalog #	Description
199-105	small blade: $1\frac{1}{8}$ " x $1\frac{3}{4}$ " (28mm x 44mm) large blade: $1\frac{3}{16}$ " x $1\frac{7}{8}$ " (30mm x 47mm)



Roux Retractors

double-ended

Catalog #	Description
200-106	Set of 3
200-107	5 $\frac{1}{2}$ " (140mm), small: $\frac{7}{8}$ " x $1\frac{1}{8}$ " (21mm x 30mm) blades
200-108	6" (155mm), medium: 1" x $1\frac{1}{2}$ " (26mm x 37mm) blades
200-109	6 $\frac{1}{2}$ " (165mm), large: $1\frac{1}{8}$ " x $1\frac{5}{8}$ " (29mm x 42mm) blades

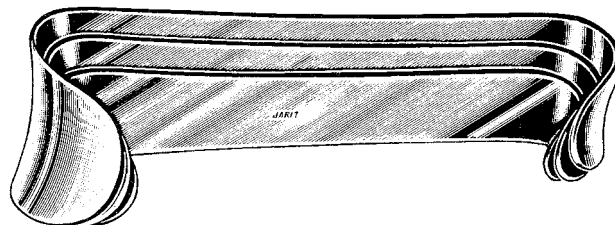

Farabeuf Retractor

Catalog #	Description
200-110	4¾" (121mm), double-ended, set of 2: small blade ¾" x 1⅛" (10mm x 27mm) deep, large blade ½" x 1⅜" (13mm x 35mm) deep

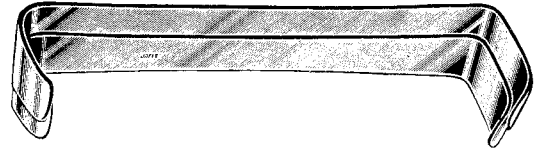

Farabeuf Retractor

Catalog #	Description
200-115	5⅞" (149mm), double-ended, set of 2: small blade ⅝" x 1" (16mm x 25mm) deep, large blade ⅝" x ¼" (16mm x 32mm) deep

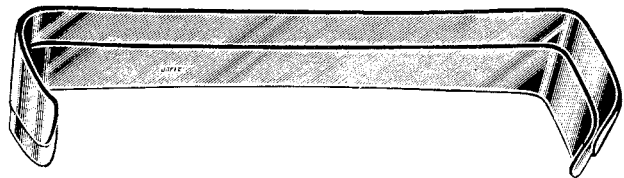

Sistrunk Retractor

Catalog #	Description
200-119	6" (153mm), double-ended, blade ⅜" x 1" (10mm x 25mm) deep



Parker Retractor

Catalog #	Description
200-120	5½" (140mm), double-ended, set of 2, blades ⅝" x 1" (16mm x 25mm) deep

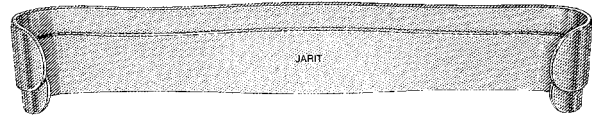

Parker Retractor

Catalog #	Description
200-122	7" (180mm), double-ended, set of 2, blades 1" x 1¼" (25mm x 31.5mm) deep

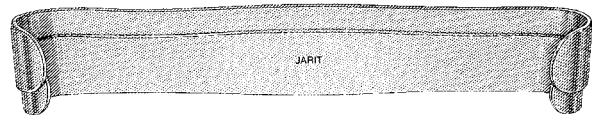

Parker-Mott Retractor

Catalog #	Description
200-125	5¾" (145mm), double-ended, set of 2, blades 1" x 2½" (25mm x 62mm) deep

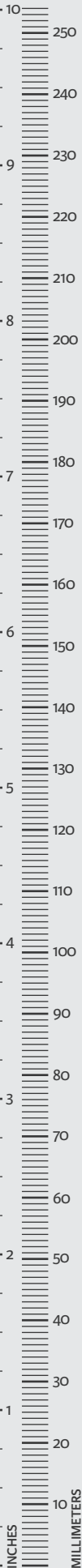
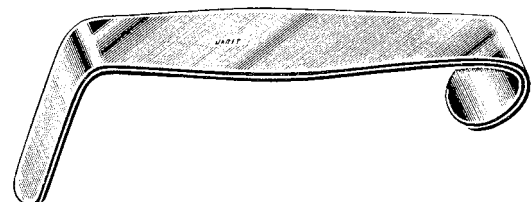

Langenbeck Retractor

Catalog #	Description
200-126	8½" (216mm), Small blade: ¾" x 1¾" (10mm x 46mm) deep
200-127	8½" (216mm), Medium blade: ½" x 1¾" (13mm x 46mm) deep
200-128	8½" (216mm), Large blade: ⅝" x 1¾" (16mm x 46mm) deep



Goelet Retractor

Catalog #	Description
200-130	7½" (190mm), double-ended, Blades: small end 1¼" and 1⅝" wide (31mm x 40mm), large end 1½" x 1⅝" (37mm x 40mm)

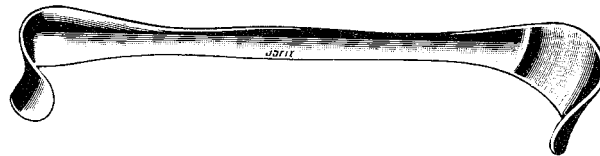

McBurney Thyroid Retractor

Catalog #	Description
200-131	7½" (190mm), blade ⅝" x ⅜" wide (16mm x 10mm)



Green Thyroid Retractor

Catalog #	Description
200-132	8¾" (223mm), blade 1" x ¾" wide (25mm x 17.5mm)



Little Retractor

Catalog #	Description
200-133	7½" (190mm), blade ⅝" x ½" wide (16mm x 12mm)

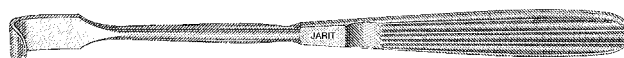

Lahey Thyroid Retractor

Catalog #	Description
200-134	7 ³ / ₄ " (200mm), blade 1 ¹ / ₈ " x 1 ¹ / ₄ " wide (29mm x 7mm)

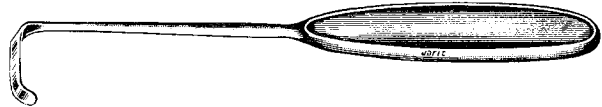

Cushing Vein Retractor, (Satin Finish)

blade 1/2" x 7/16" (13mm x 11.4mm)

Manufactured from high grade German surgical stainless steel which is ground and polished to a satin finish

Catalog #	Description
200-135	9" (230mm)
200-136	11" (279mm)
200-137	14" (356mm)



Cushing Vein Retractor, (Matte Finish)

blade 1/2" x 7/16" (13mm x 11.4mm)

Manufactured from high grade German surgical stainless steel which is glass beaded to a matte finish

Catalog #	Description
199-135	9" (230mm)



Crile Retractor

Catalog #	Description
200-138	4 ¹ / ₄ " (109mm), double-ended, Small blade: 1/2" x 3/16" (14mm x 4.5mm) Large blade: 7/8" x 1/4" (21.8mm x 6.8mm)



Sauerbruch Retractors

Catalog #	Description
200-140	8¾" (225mm), blade 2⅛" x ⅝" (53mm x 17mm)
200-142	8¾" (225mm), blade 2¾" x ⅞" (70mm x 23mm)
200-143	8¾" (225mm), blade 3" x ¾" (77mm x 20mm)

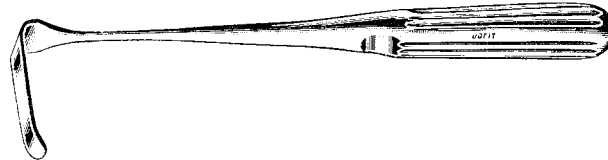

Doyen Retractors

Catalog #	Description
200-145	8⅞" (225mm), blade 1¾" x 2½" (45mm x 65mm)
200-147	8⅞" (225mm), blade 2⅛" x 3" (55mm x 75mm)
200-149	8⅞" (225mm), blade 2¼" x 3½" (55mm x 90mm)

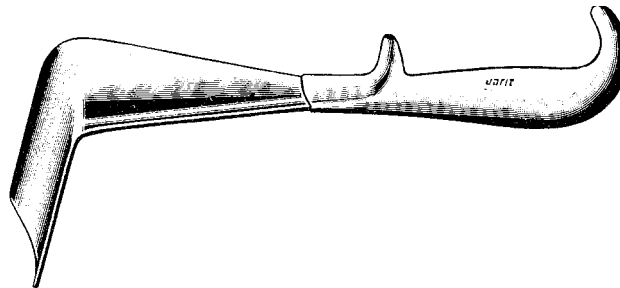

Richardson-Eastman Retractors

double-ended

Catalog #	Description
200-150	Set of 2
200-151	10" (252mm), small blade ⅞" x 1⅛" (22mm x 29mm), large blade 1⅛" x 1⅜" (30mm x 35mm)
200-152	10⅝" (270mm), small blade 1½" x 1¾" (37mm x 46mm), large blade 1¾" x 2¾" (43mm x 71mm)

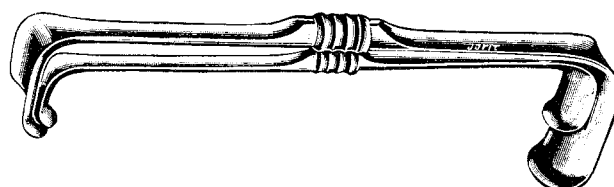

Richardson Retractors

lamb handle

Catalog #	Description
200-155	10 ³ / ₄ " (270mm), blade 7 ⁷ / ₈ " x 7 ⁷ / ₈ " (22mm x 23mm)
200-156	10 ³ / ₄ " (270mm), blade 1" wide x 1 ¹ / ₄ " deep (25mm x 32mm)
200-157	10 ³ / ₄ " (270mm), blade 1 ¹ / ₂ " wide x 1 ¹ / ₂ " deep (38mm x 38mm)

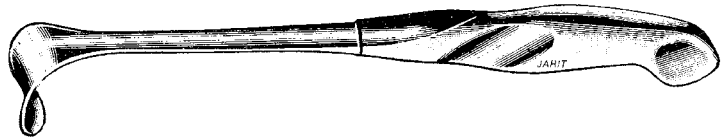

Richardson Retractors

hollow grip handle

Catalog #	Description
201-155	9 ³ / ₄ " (245mm), blade 3 ³ / ₄ " x 1 ¹ / ₈ " (20mm x 28mm)
201-156	9 ³ / ₄ " (245mm), blade 1 ¹ / ₈ " x 1 ³ / ₈ " (27mm x 34mm)
201-157	9 ³ / ₄ " (245mm), blade 1 ¹ / ₂ " x 1 ⁵ / ₈ " (37mm x 40mm)

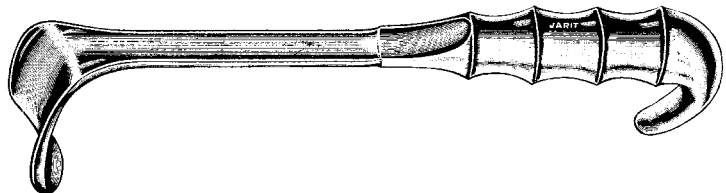

Richardson Retractors

loop handle

Catalog #	Description
202-155	9 ¹ / ₂ " (241mm), blade 7 ⁷ / ₈ " x 1 ¹ / ₈ " (22mm x 27mm)
202-156	9 ¹ / ₂ " (241mm), blade 1 ¹ / ₈ " x 1 ³ / ₈ " (30mm x 35mm)
202-157	9 ¹ / ₂ " (241mm), blade 1 ¹ / ₂ " x 1 ⁵ / ₈ " (38mm x 42mm)

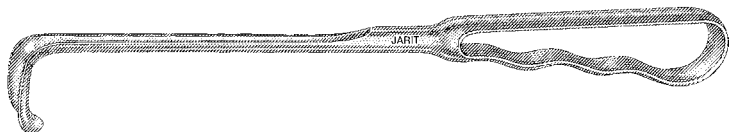

Richardson Appendectomy Retractor

lamb handle

Catalog #	Description
200-160	10 ³ / ₄ " (270mm), blade ³ / ₄ " wide x 2" deep (19mm x 51mm)

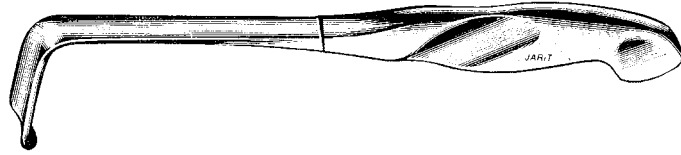

Richardson Appendectomy Retractor

hollow grip handle

Catalog #	Description
201-160	9 ³ / ₄ " (245mm), blade ³ / ₄ " wide x 2" deep (22mm x 52mm)

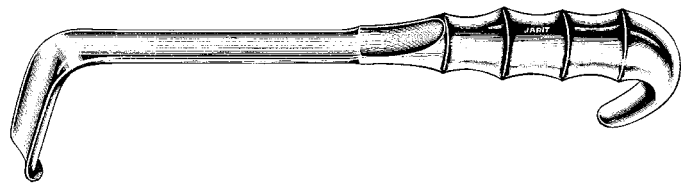

Richardson Appendectomy Retractor

loop handle

Catalog #	Description
202-160	9 ¹ / ₂ " (240mm), blade ³ / ₄ " wide x 2" deep (22mm x 52mm)

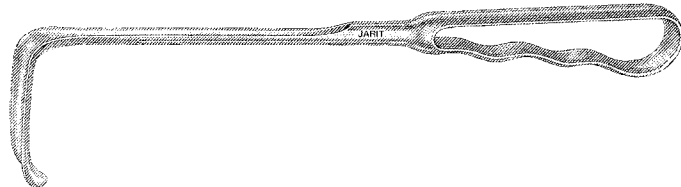

Murphy Gall Bladder Retractor

Catalog #	Description
475-429	10" (254mm), blade 2" wide (50mm)

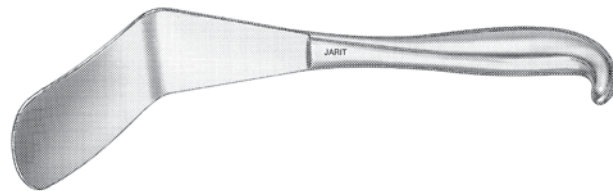

Semb Retractor

Catalog #	Description
200-261	9 ³ / ₄ " (248mm), small blade ³ / ₄ " x 1 ³ / ₄ " (18mm x 43mm)



Kelly Retractors

lamb handle

Catalog #	Description
200-165	10 ³ / ₄ " (270mm), blade 1 ¹ / ₂ " x 2" deep (38mm x 51mm)
200-166	11" (280mm), blade 2" x 2 ¹ / ₂ " deep (51mm x 64mm)
200-167	11" (280mm), blade 2 ¹ / ₂ " x 3" deep (64mm x 76mm)
200-168	11 ¹ / ₂ " (290mm), blade 3" x 3 ¹ / ₂ " deep (76mm x 89mm)

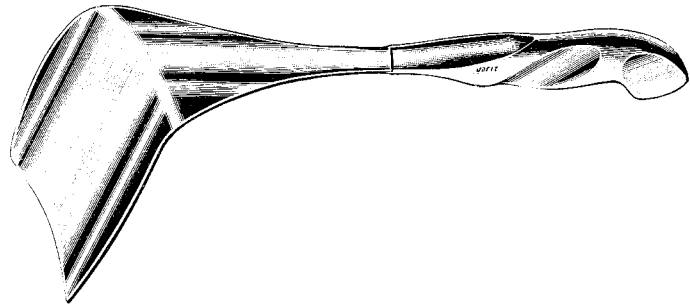

Kelly Retractors

hollow grip handle

Catalog #	Description
201-165	9 ¹ / ₂ " (244mm), blade 1 ¹ / ₂ " x 2" deep (40mm x 54mm)
201-166	10" (254mm), blade 2" x 2 ¹ / ₂ " deep (53mm x 65mm)
201-167	10" (254mm), blade 2 ¹ / ₂ " x 3" deep (65mm x 81mm)
201-168	10 ¹ / ₂ " (266mm), blade 3" x 3 ¹ / ₂ " deep (76mm x 100mm)

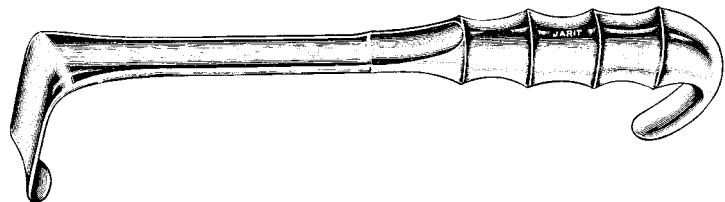

Kelly Retractors

loop handle

Catalog #	Description
202-165	9 ¹ / ₄ " (238mm), blade 1 ¹ / ₂ " x 2" deep (42mm x 55mm)
202-166	9 ³ / ₄ " (246mm), blade 2" x 2 ¹ / ₂ " deep (51mm x 66mm)
202-167	10 ¹ / ₂ " (266mm), blade 2 ¹ / ₂ " x 3" deep (65mm x 80mm)
202-168	10 ³ / ₄ " (275mm), blade 3" x 3 ¹ / ₂ " deep (76mm x 102mm)

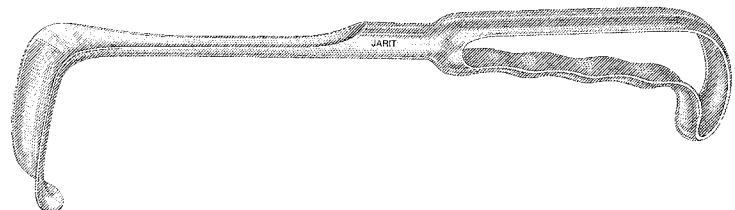

Mayo Abdominal Retractor

Lamb handle

Catalog #	Description
200-170	10 ³ / ₄ " (275mm), blade 2 ³ / ₄ " wide (70mm)

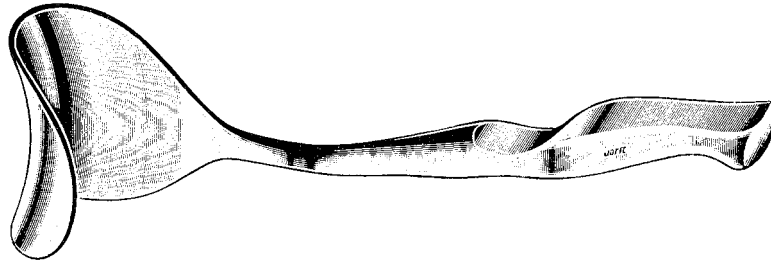

Hibbs Retractors

Catalog #	Description
200-172	9 ¹ / ₂ " (242mm), blade 1" x 3" deep (26mm x 76mm)
200-173	9 ¹ / ₄ " (235mm), blade ³ / ₄ " x 2 ¹ / ₄ " deep (19mm x 56mm)

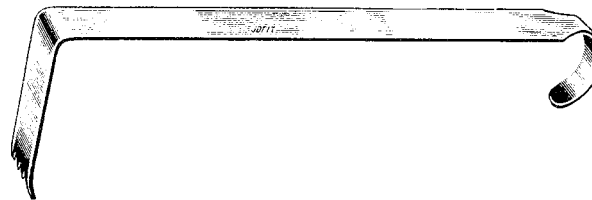

Harrington Splanchnic Retractors

Lamb handle

Catalog #	Description
200-175	12 ¹ / ₂ " (318mm), blade 1 ³ / ₄ " wide (44mm)
200-176	12 ¹ / ₂ " (318mm), blade 2 ⁵ / ₈ " wide (66mm)

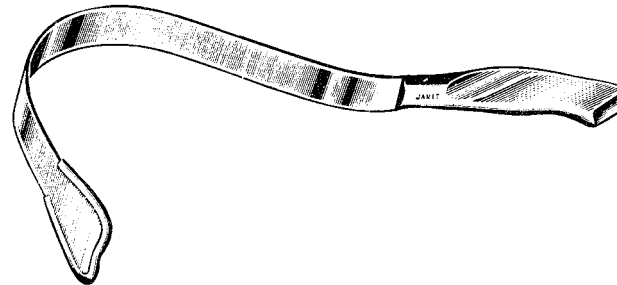

Harrington-Pemberton Retractors

Catalog #	Description
200-178	12" (305mm), blade 2 ³ / ₈ " wide (60mm)

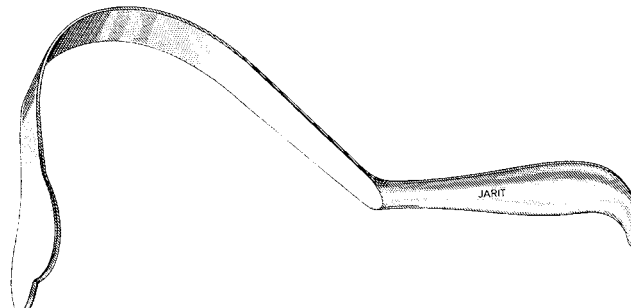

Ford-Deaver Retractors

lamb handle, 16½" (420mm), blade 10" x 6" deep (254mm x 152mm)

Catalog #	Description
200-180	2" wide (50mm)
200-181	3" wide (75mm)
200-182	4" wide (100mm)

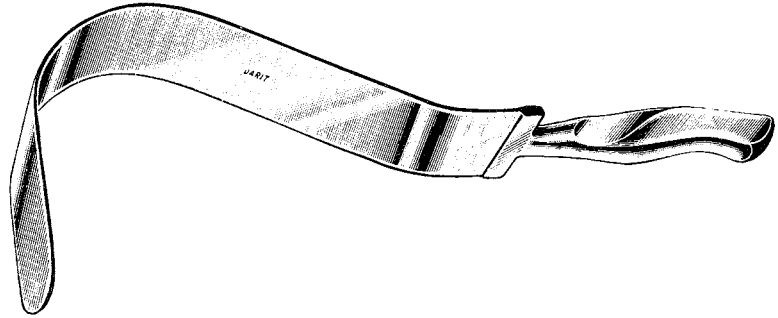

Meyerding Retractors

Catalog #	Description
200-190	8" (205mm), blade 5/8" x 2" deep (16mm x 53mm)
200-191	8¾" (225mm), blade 1" x 3" deep (25mm x 76mm)
200-192	9¾" (250mm), blade 2" x 3½" deep (50mm x 90mm)

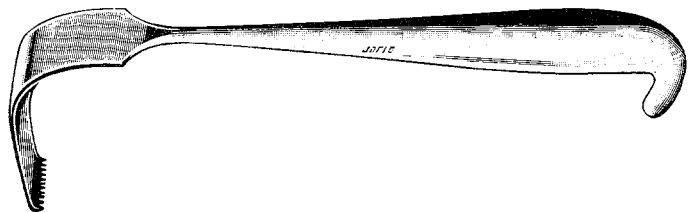

Deaver Pediatric Retractors

double-ended, pediatric sizes

Catalog #	Description
200-194	6¾" (172mm), blade 8mm wide
200-195	6¾" (172mm), blade 10mm wide
200-196	6¾" (172mm), blade 13mm wide
200-197	Set of 3

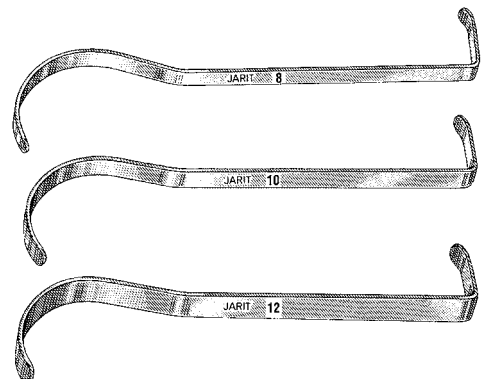

Deaver Retractor

Catalog #	Description
200-198	3/8" wide x 7 1/4" long (9.6mm x 182mm), pediatric size

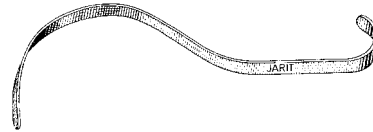

Deaver Retractor

Catalog #	Description
200-200	3/4" wide x 7" long (19mm x 178mm)

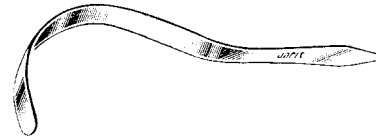

Deaver Retractor

Catalog #	Description
200-201	7/8" wide x 8 1/2" long (22mm x 216mm)

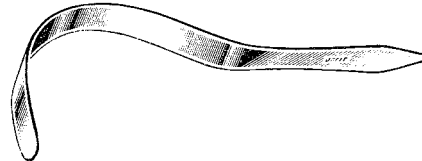

Deaver Retractors

Catalog #	Description
200-208	1" wide x 10 1/2" long (25mm x 265mm)
200-202	1" wide x 12" long (25mm x 305mm)
200-203	1" wide x 13" long (25mm x 330mm)
200-204	1" wide x 14" long (25mm x 356mm)

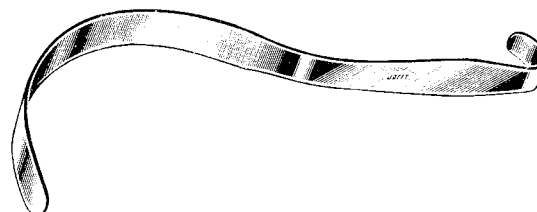

Deaver Retractors

Catalog #	Description
200-205	1½" wide x 12" long (38mm x 305mm)
200-206	2" wide x 12" long (50mm x 305mm)

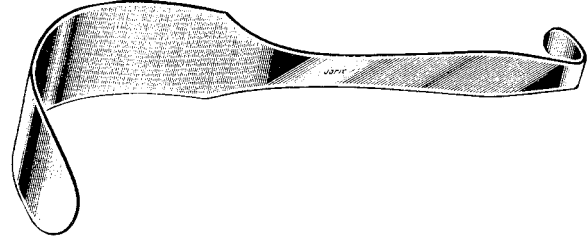

Deaver Retractor

Catalog #	Description
200-207	3" wide x 12" long (76mm x 305mm)

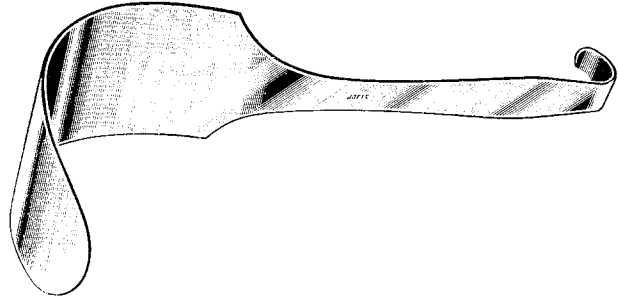

Deaver Retractor

Catalog #	Description
200-210	1" wide x 9" long (25mm x 228mm)

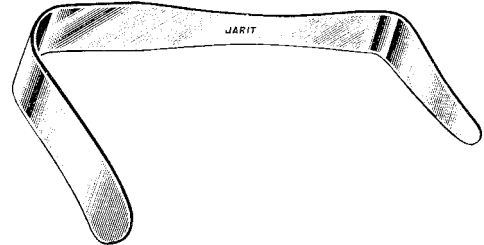

Deaver Retractors

hollow grip handle

Catalog #	Description
201-200	1" wide x 10" long (25mm x 254mm)
201-201	1" wide x 12" long (25mm x 305mm)
201-202	1" wide x 13" long (25mm x 330mm)
201-203	2½" wide x 14½" long (63mm x 368mm)
201-204	3½" wide x 12" long (89mm x 305mm)
201-205	2" wide x 12" long (50mm x 305mm)
201-206	3" wide x 12" long (75mm x 305mm)

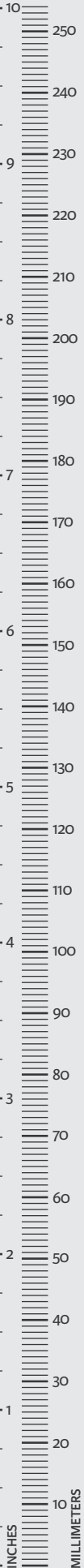
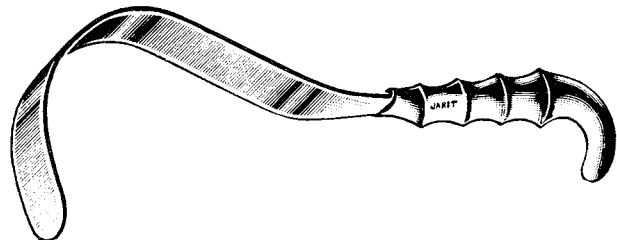

Children's Hospital Retractor

double-ended

Catalog #	Description
200-116	5 ³ / ₄ " (145mm), Small blade: 9/16" wide x 1 ³ / ₈ " deep (14mm x 35mm) Large blade: 7/16" wide x 7/8" deep (11mm x 22mm)



Ribbon Retractor

malleable blade, pediatric sizes

Catalog #	Description
200-217	1" wide x 10" long (25mm x 254mm)
200-218	5/8" wide x 6 ³ / ₄ " long (16mm x 171mm)
200-219	1" wide x 7 ¹ / ₂ " long (25mm x 190mm)

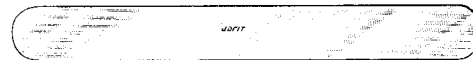

Ribbon Retractors

malleable blade

Catalog #	Description
200-220	13" (330mm), 3/4" wide (19mm)
200-221	13" (330mm), 1" wide (25mm)
200-222	13" (330mm), 1 ¹ / ₄ " wide (32mm)
200-223	13" (330mm), 1 ¹ / ₂ " wide (38mm)
200-225	13" (330mm), 2" wide (51mm)
200-226	13" (330mm), 2 ¹ / ₂ " wide (64mm)
200-227	13" (330mm), 3" wide (76mm)
200-228	13" (330mm), 4" wide (102mm)

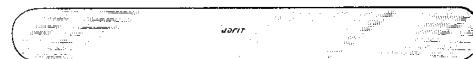

Ribbon Retractors

hollow grip handle, malleable blade 13" (330mm),
overall length 18" (457mm)

Catalog #	Description
201-220	3/4" wide (19mm)
201-221	1" wide (25mm)
201-222	1 ¹ / ₄ " wide (32mm)
201-223	1 ¹ / ₂ " wide (38mm)
201-225	2" wide (51mm)

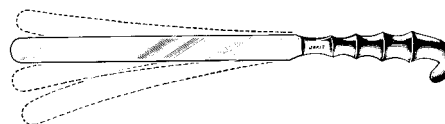

Willauer-Deaver Retractors

Catalog #	Description
200-235	15" length, 6¼" deep, 1" wide (380mm x 159mm x 25mm)
200-237	15¼" length, 6¼" deep, 2" wide (390mm x 159mm x 50mm)



Weinberg Vagotomy Retractor

Catalog #	Description
200-255	9" (229mm) Large blade: 3⅝" wide x 6¼" deep (93mm x 157mm) Small blade: 1⅞" wide x 2¼" deep (42mm x 57mm)

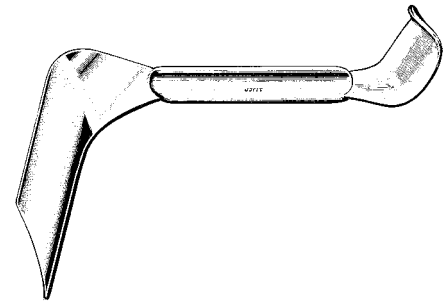

Volkman Retractors, Sharp, (Satin Finish)

Manufactured from high grade German surgical stainless steel which is ground and polished to a satin finish

Catalog #	Description
200-270	8½" (215mm), 2 prongs, 9mm x 8mm wide
200-271	8½" (215mm), 3 prongs, 9mm x 13mm wide
200-272	8½" (215mm), 4 prongs, 9mm x 18mm wide
200-273	8½" (215mm), 6 prongs, 9mm x 28mm wide

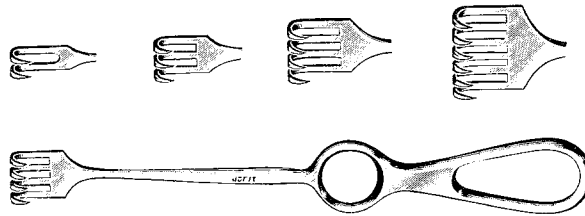

Volkman Retractors, Sharp, (Matte Finish)

Manufactured from high grade German surgical stainless steel which is glass beaded to a matte finish

Catalog #	Description
199-272	8½" (215mm), 4 prongs, 9mm x 18mm wide

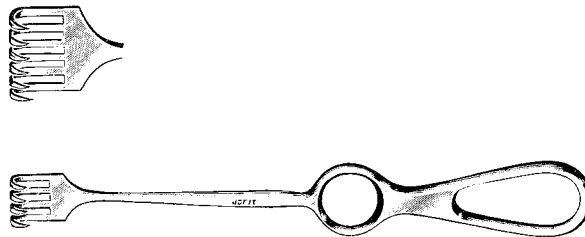

Volkman Retractors, Blunt, (Satin Finish)

Manufactured from high grade German surgical stainless steel which is ground and polished to a satin finish

Catalog #	Description
200-280	8½" (215mm), 2 prongs, 9mm x 8mm wide
200-281	8½" (215mm), 3 prongs, 9mm x 13mm wide
200-282	8½" (215mm), 4 prongs, 9mm x 18mm wide
200-283	8½" (215mm), 6 prongs, 9mm x 28mm wide

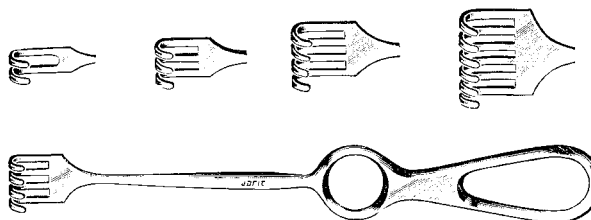

Volkman Retractors, Blunt, (Matte Finish)

Manufactured from high grade German surgical stainless steel which is glass beaded to a matte finish

Catalog #	Description
199-282	8½" (215mm), 4 prongs, 9mm x 18mm wide

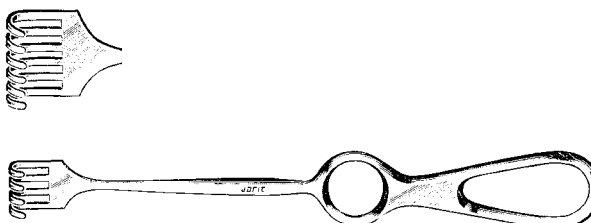

Volkman Retractors, USA Pattern, Sharp, (Satin Finish)

Manufactured from high grade German surgical stainless steel which is ground and polished to a satin finish

Catalog #	Description
200-290	9 1/8" (232mm), 2 prongs, 16mm x 11mm wide
200-291	9 1/8" (232mm), 3 prongs, 16mm x 18mm wide
200-292	9 1/8" (232mm), 4 prongs, 16mm x 26mm wide
200-293	9 1/8" (232mm), 6 prongs, 16mm x 40mm wide

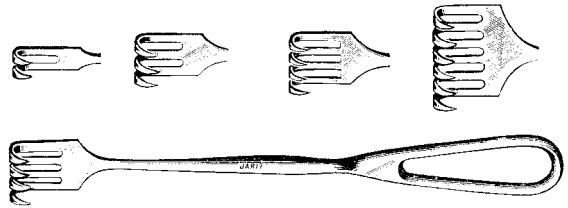

Volkman Retractors, USA Pattern, Sharp, (Matte Finish)

Manufactured from high grade German surgical stainless steel which is glass beaded to a matte finish

Catalog #	Description
199-292	9 1/8" (232mm), 4 prongs, 16mm x 26mm wide

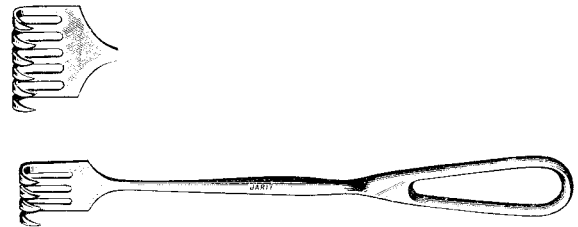

Volkman Retractors, USA Pattern, Blunt, (Satin Finish)

Manufactured from high grade German surgical stainless steel which is ground and polished to a satin finish

Catalog #	Description
200-295	9 1/8" (232mm), 2 prongs, 16mm x 11mm wide
200-296	9 1/8" (232mm), 3 prongs, 16mm x 18mm wide
200-297	9 1/8" (232mm), 4 prongs, 16mm x 26mm wide
200-298	9 1/8" (232mm), 6 prongs, 16mm x 40mm wide

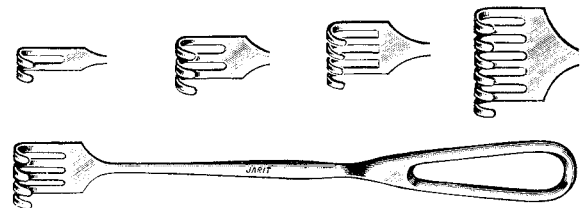

Volkman Retractors, USA Pattern, Blunt, (Matte Finish)

Manufactured from high grade German surgical stainless steel which is glass beaded to a matte finish

Catalog #	Description
199-297	9 1/8" (232mm), 4 prongs, 16mm x 26mm wide

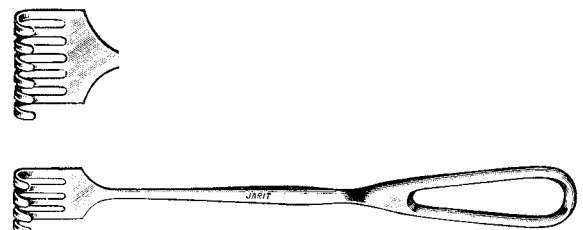

Murphy Retractors

sharp

Catalog #	Description
200-300	7¾" (200mm), 2 prongs, 10.7mm x 8.5mm wide
200-301	7¾" (200mm), 3 prongs, 10.7mm x 12.75mm wide
200-302	7¾" (200mm), 4 prongs, 10.7mm x 18.9mm wide
200-303	7¾" (200mm), 6 prongs, 10.7mm x 28mm wide

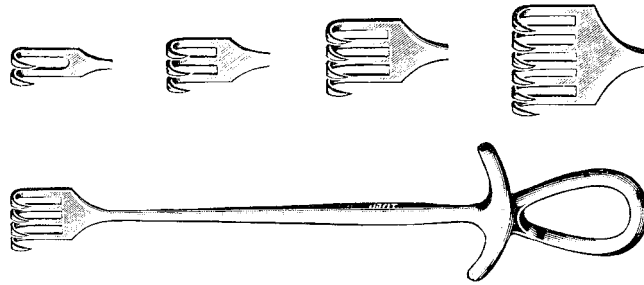

Murphy Retractors

blunt

Catalog #	Description
200-310	7¾" (200mm), 2 prongs, 10.7mm x 8.5mm wide
200-311	7¾" (200mm), 3 prongs, 10.7mm x 12.75mm wide
200-312	7¾" (200mm), 4 prongs, 10.7mm x 18.9mm wide
200-313	7¾" (200mm), 6 prongs, 10.7mm x 28mm wide

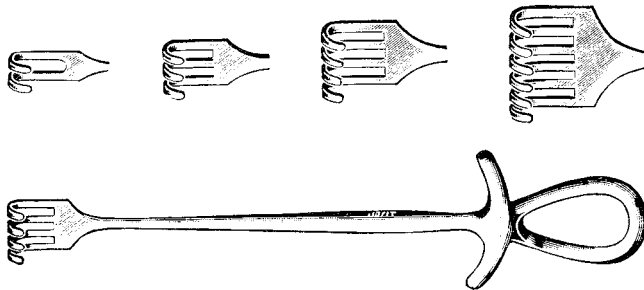

Israel Retractor

blunt

Catalog #	Description
200-315	7¼" (187mm), 4 prongs, 48mm x 42mm wide

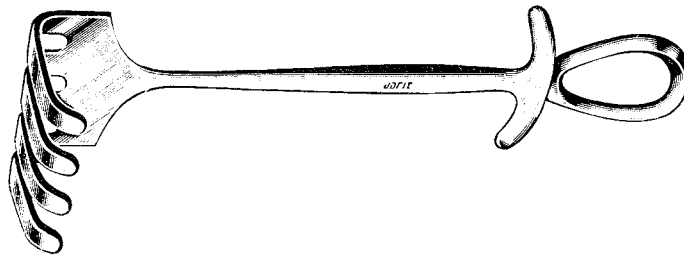

Ollier Retractor

blunt

Catalog #	Description
200-318	9" (230mm), 4 prongs, 42mm x 56mm wide

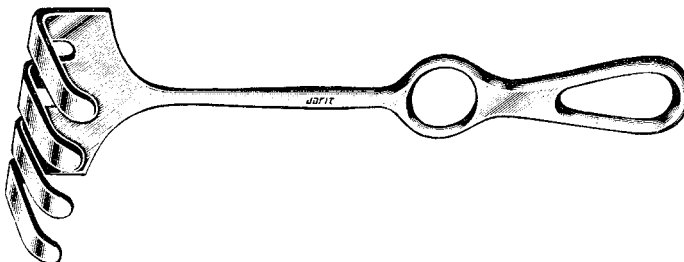

Alm Retractor

Catalog #	Description
205-100	2 3/4" (70mm), 2" (50mm) spread

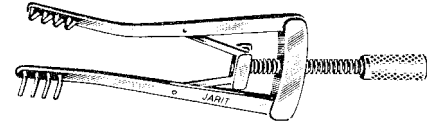

Alm Retractor

Catalog #	Description
205-105	3 7/8" (100mm), 2 1/2" (64mm) spread

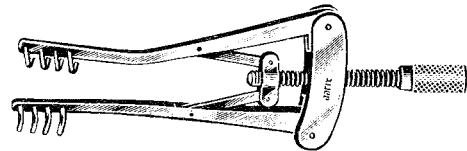

Heiss Automatic Skin Retractor

Catalog #	Description
205-110	3 7/8" (100mm), 1" (25mm) spread, sharp prongs
205-111	3 7/8" (100mm), 1" (25mm) spread, blunt prongs

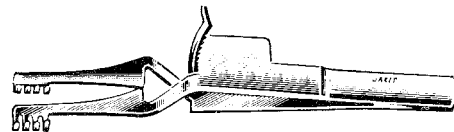

Gelpi Perineal Retractor, (Satin Finish)

Manufactured from high grade German surgical stainless steel which is ground and polished to a satin finish

Catalog #	Description
205-120	7 1/2" (190mm)

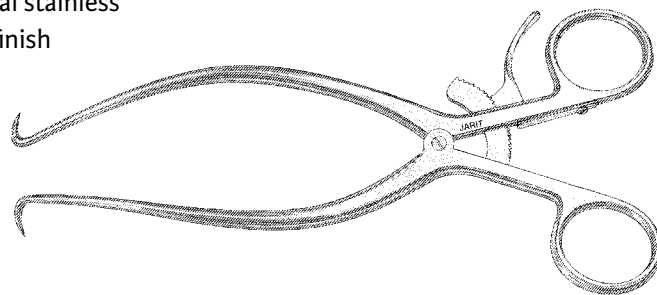

Gelpi Perineal Retractor, (Matte Finish)

Manufactured from high grade German surgical stainless steel which is glass beaded to a matte finish

Catalog #	Description
204-120	7 3/4" (195mm)
205-SPS-120	Replacement Spring and Screw

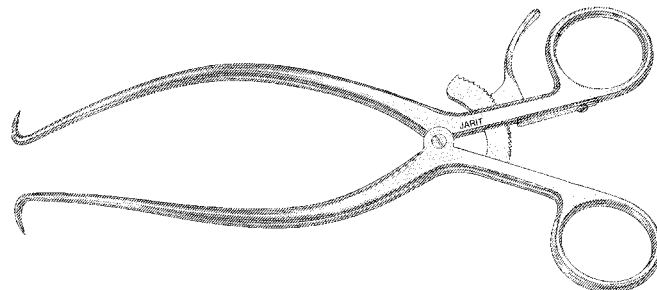

Gelpi Perineal Retractor

with ball stops

Catalog #	Description
205-121	7 ³ / ₄ " (195mm)
205-SPS-120	Replacement Spring and Screws

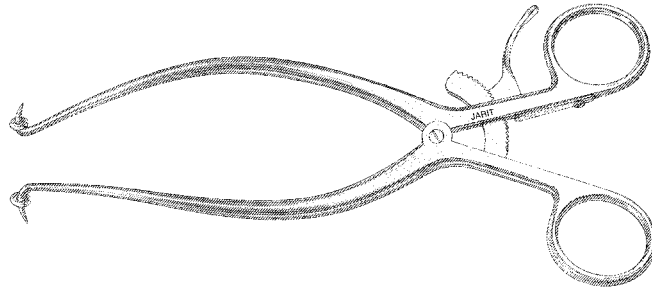

Gelpi Perineal Retractors, pediatric sizes, (Satin Finish)

Manufactured from high grade German surgical stainless steel which is ground and polished to a satin finish

Catalog #	Description
205-123	3 ⁷ / ₈ " (97mm)
205-124	4 ³ / ₈ " (117mm)
205-125	5 ¹ / ₈ " (130mm)
205-SPS-123	Replacement Spring and Screw
205-SPS-124	Replacement Spring and Screw

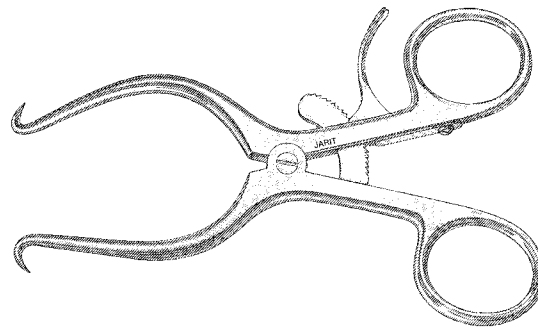

Gelpi Perineal Retractor, pediatric sizes, (Matte Finish)

Manufactured from high grade German surgical stainless steel which is glass beaded to a matte finish

Catalog #	Description
204-123	3 ³ / ₄ " (95mm)
204-124	4 ³ / ₄ " (120mm)
204-125	5 ¹ / ₄ " (133mm)
205-SPS-123	Replacement Spring and Screw
205-SPS-124	Replacement Spring and Screw

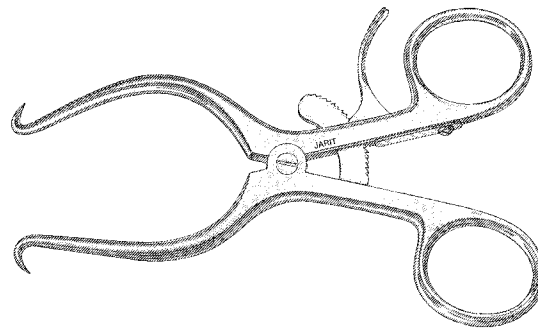

Farr Style Spring Retractors

Catalog #	Description
205-127	5½" (140mm), ½" (14mm) tips
205-128	5½" (140mm), ⅝" (15mm) tips
205-130	1½" (38mm), 10mm sharp points
205-131	2" (50mm), 11mm sharp points
205-132	2¼" (58mm), 11mm sharp points
205-133	2½" (64mm), 11mm sharp points
205-134	3" (75mm), 11mm sharp points
205-135	2½" (64mm), 12mm flat blades

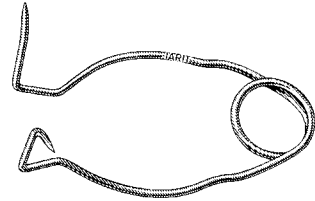

Spring Wire Retractors

Catalog #	Description
205-136	3" (75mm), style 1, 10.5mm sharp points
205-137	3½" (90mm), style 2, 11mm x 15.5mm flat blades
205-138	4½" (115mm), style 3, 15.5mm x 20.5mm flat blades

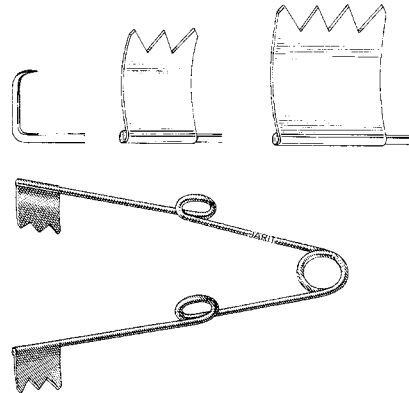

Weitlaner Retractors, (Satin Finish)

Manufactured from high grade German surgical stainless steel which is ground and polished to a satin finish

Catalog #	Description
205-140	4 ³ / ₈ " (110mm)
205-141	4 ³ / ₈ " (110mm)
205-150	5 ³ / ₈ " (135mm)
205-151	5 ³ / ₈ " (135mm)
205-155	6 ¹ / ₂ " (165mm)
205-156	6 ¹ / ₂ " (165mm)
205-160	7 ³ / ₄ " (195mm)
205-161	7 ³ / ₄ " (195mm)
205-165	9 ¹ / ₂ " (240mm)
205-166	9 ¹ / ₂ " (240mm)

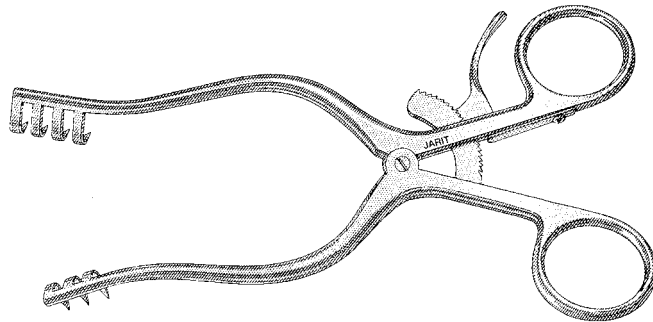

Weitlaner Retractors, (Matte Finish)

Manufactured from high grade German surgical stainless steel which is glass beaded to a matte finish

Catalog #	Description
204-140	4 ³ / ₈ " (110mm)
204-141	4 ³ / ₈ " (110mm)
204-150	5 ³ / ₈ " (135mm)
204-151	5 ³ / ₈ " (135mm)
204-155	6 ¹ / ₂ " (165mm)
204-156	6 ¹ / ₂ " (165mm)
204-160	7 ³ / ₄ " (195mm)
204-161	7 ³ / ₄ " (195mm)
204-165	9 ¹ / ₂ " (240mm)
204-166	9 ¹ / ₂ " (240mm)

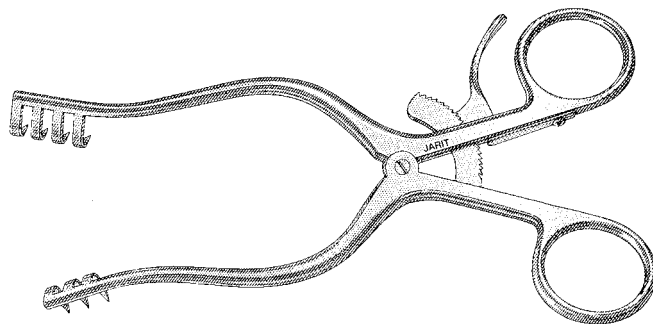

Weitlaner Retractor Replacement Parts

Catalog #	Description
205-SPS-140	Replacement Spring and Screw
205-SPS-141	Replacement Spring and Screw
205-SPS-150	Replacement Spring and Screw
205-SPS-151	Replacement Spring and Screw
205-SPS-155	Replacement Spring and Screw
205-SPS-156	Replacement Spring and Screw
205-SPS-160	Replacement Spring and Screw
205-SPS-161	Replacement Spring and Screw

Weitlaner Retractors

hinged blades

Catalog #	Description
205-175	5½" (140mm), 3 x 4 sharp prongs, 18mm deep
205-176	5½" (140mm), 3 x 4 blunt prongs, 18mm deep
205-180	6½" (162mm), 3 x 4 sharp prongs, 18mm deep
205-181	6½" (162mm), 3 x 4 blunt prongs, 18mm deep
205-190	8¼" (210mm), 3 x 4 sharp prongs, 20mm deep

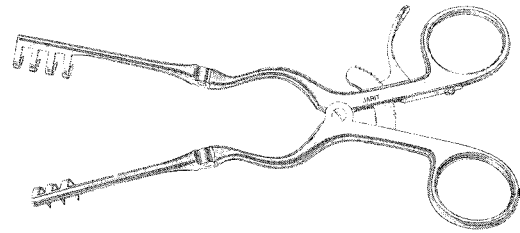

Adson Cerebellar Retractors

straight

Catalog #	Description
205-200	7¾" (195mm), 4 x 4 sharp prongs, 22mm deep
205-201	7¾" (195mm), 4 x 4 blunt prongs, 22mm deep

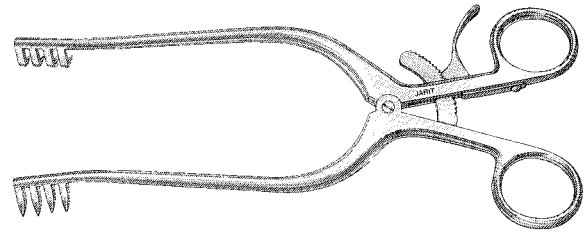

Adson Cerebellar Retractors

angled

Catalog #	Description
205-205	7¼" (182mm), angled, 4 x 4 sharp prongs, 22mm deep
205-206	7¼" (182mm), angled shanks, angular, 4 x 4 blunt prongs, 22mm deep

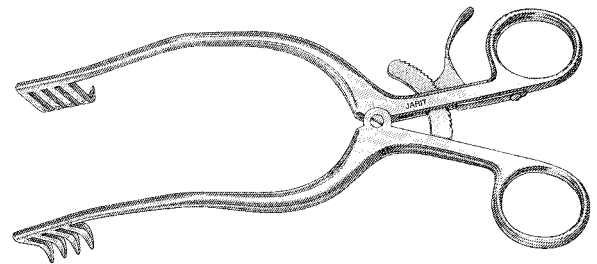

Beckman Thyroid Retractors, Hinged Blades

Catalog #	Description
205-209	9½" (240mm), 3 x 4 sharp prongs, 1½" deep (28mm)
205-210	12¾" (316mm), 4 x 4 sharp prongs, 5/8" deep (16mm)

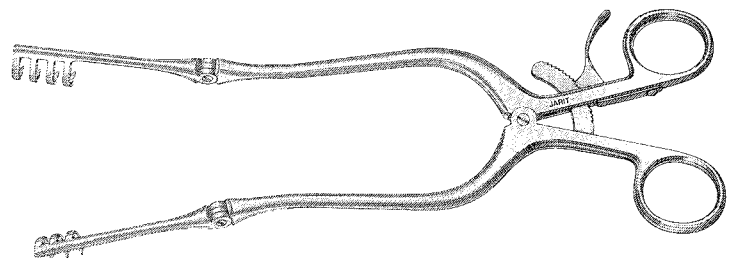

INCHES
MILLIMETERS

Beckman-Adson Retractors, Hinged Blades

Catalog #	Description
205-220	12¼" (309mm), 4 x 4 sharp prongs, 1" x 1" deep (25mm x 25mm)
205-221	12¼" (309mm), 4 x 4 blunt prongs, 1" x 1" deep (25mm x 25mm)
205-225	12¼" (309mm), 4 x 4 sharp prongs, 1" x 1¾" deep (25mm x 44mm)
205-226	12¼" (309mm), 4 x 4 blunt prongs, 1" x 1¾" deep (25mm x 44mm)

205-SPS-226 Replacement Spring and Screws



Beckman-Eaton Retractor, Hinged Blades

Catalog #	Description
205-230	12¾" (324mm), 7 x 7 sharp prongs, 1¾" x 1⅞" deep (44mm x 48mm)

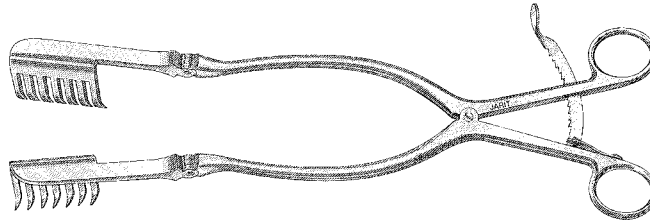

Mayo-Adams Retractor

Catalog #	Description
205-235	6½" (168mm), removable center blade 7" x ⅜" x 1⅝" (180mm x 41mm x 10mm)

205-CBL-235 Removable center blade 7" x ⅜" x 1⅝" (180mm x 41mm x 10mm)

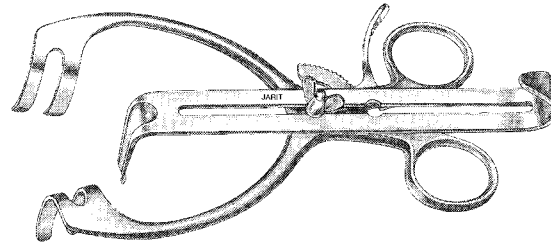

Rigby Retractor

Catalog #	Description
205-237	7½" (190mm), blades 7⁄8" x 2 1⁄34" deep (21mm x 69mm)

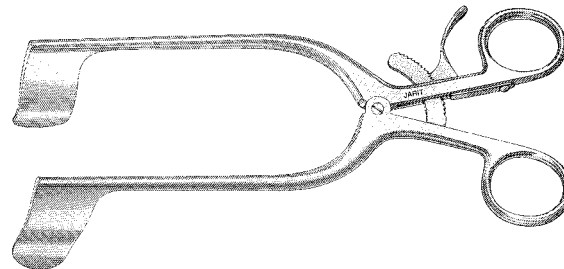

Meyerding Laminectomy Retractors

Catalog #	Description
205-240	7¾" (194mm), blades 1" x 1¼" deep (25mm x 31mm)
205-242	7¾" (194mm), blades 1" x 2⅛" deep (25mm x 54mm)
205-244	7¾" (194mm), blades ¾" x 2⅜" deep (19mm x 63mm)
205-245	7¾" (194mm), blades 1" x 2⅜" deep (25mm x 60mm)

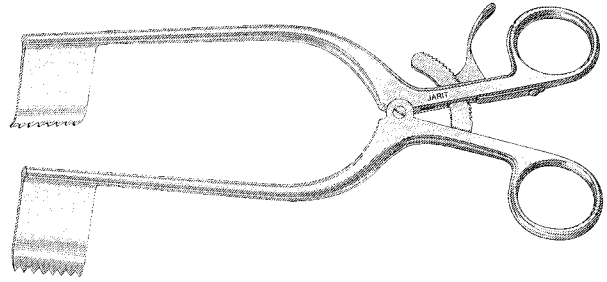

Gosset Retractor

Catalog #	Description
205-251	5½" (140mm) spread, blades 1" x 2½" deep (25mm x 64mm)

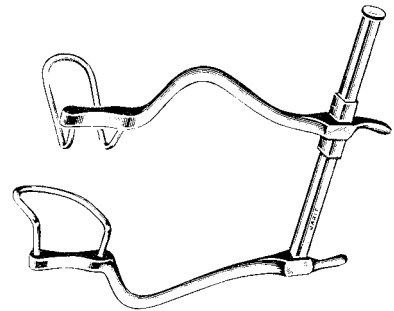

Markham-Meyerding Hemilaminectomy Retractor

Catalog #	Description
205-255	6¾" (170mm), blade 1" x 2½" deep (25mm x 64mm), blade on right side

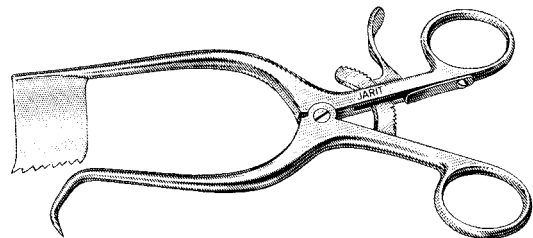

Markham-Meyerding Hemilaminectomy Retractor

Catalog #	Description
205-256	6¾" (170mm), blade 1" x 2½" deep (25mm x 64mm), blade on left side

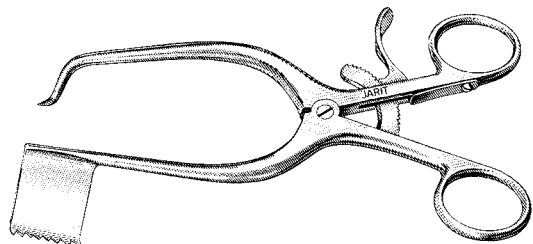

Balfour Retractors

"Spread" is measured: distal tip of blade or proximal end where blade attaches to arm.

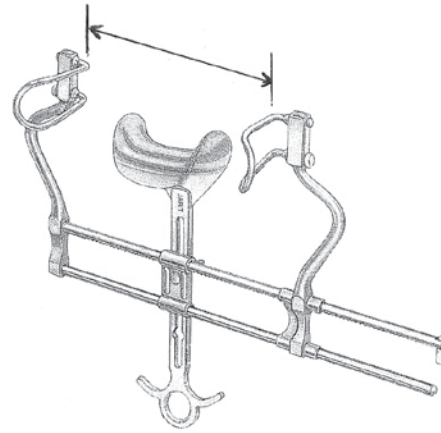

Balfour Abdominal Retractors

with attached wire lateral blades 2" (51mm) deep

set includes: 205-298, 1 each center blade, 3 1/8" wide x 1 7/8" deep (80mm x 48mm)

Catalog #	Description
205-270	7" (176mm) spread
205-275	9 1/2" (243mm) spread
205-ESC-270	Replacement End Screws pkg/6ea
205-SLB-270	Replacement Sliding Bracket
205-WGN-270	Replacement Wing Nut pkg/6ea

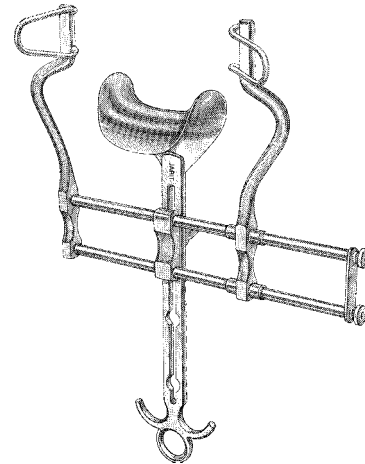

Balfour Abdominal Retractors

with attached solid lateral blades 2" (51mm) deep

set includes: 205-298, 1 each center blade, 3 1/8" wide x 1 7/8" deep (80mm x 48mm)

Catalog #	Description
205-280	7" (176mm) spread
205-ESC-270	Replacement End Screws pkg/6ea

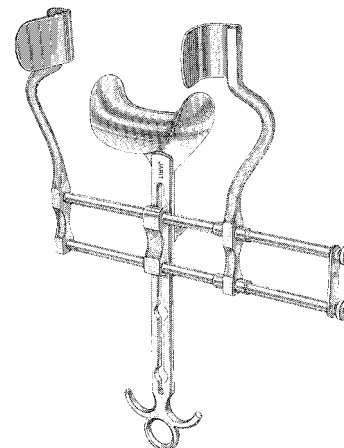

Balfour Abdominal Retractor

with attached wire lateral blades 2" (51mm) deep

set includes: 205-298, 1 each center blade, 3 1/8" wide x 1 7/8" deep (80mm x 48mm)

Catalog #	Description
205-290	7" (176mm) spread
205-291	9 1/2" (243mm) spread
205-SLB-290	Slide bar only
205-SLB-291	Slide bar only
205-FRM-291	Frame only

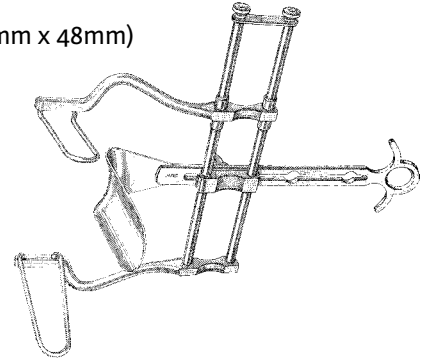

Balfour Abdominal Retractor with Ratchet Bar

Catalog #	Description
205-295	7" (178mm) spread Set includes: 205-335, 1 pair 2" (51mm), deep interchangeable wire lateral blades 205-336, 1 pair 3" (76mm), deep interchangeable wire lateral blades 205-292, 1 each center blade, 2 5/8" wide x 1 1/2" deep (67mm x 38mm) 205-293, 1 each center blade, 3 1/4" x 2 3/4" deep (83mm x 70mm)

205-SLB-295 Slide bar only

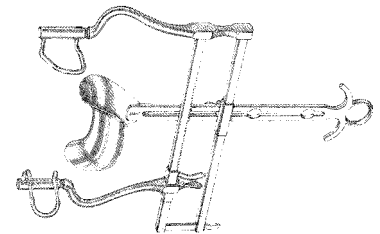

Balfour Abdominal Retractor with Ratchet Bar

Catalog #	Description
205-296	10" (254mm) spread Set includes: 205-335, 1 pair 2" (51mm), deep interchangeable wire lateral blades 205-336, 1 pair 4" (102mm), deep interchangeable wire lateral blades 205-298, 1 each center blade, 3 1/8" wide x 1 7/8" deep (80mm x 48mm) 205-299, 1 each center blade, 2 1/2" x 4" deep (64mm x 101mm)

205-SLB-296 Slide bar only

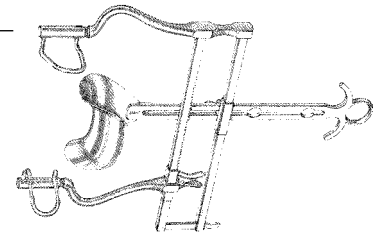

Balfour Wire Lateral Blades, 2/Per

Catalog #	Description
205-335	2" (50mm) deep
205-336	3" (76mm) deep
205-337	4" (102mm) deep

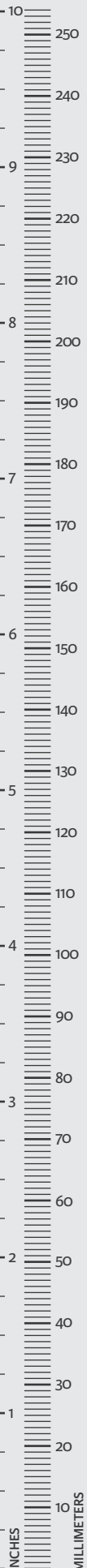
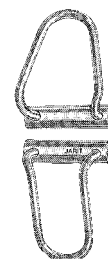

Balfour Center Blade

Catalog #	Description
205-292	12" (306mm), standard 2 ⁵ / ₈ " wide x 1 ¹ / ₂ " deep (68mm x 38mm)

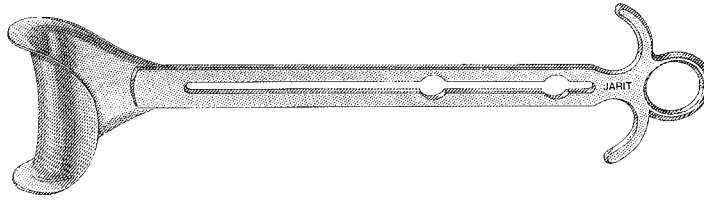

Balfour Center Blade

Catalog #	Description
205-293	12 ¹ / ₄ " (309mm), supra-pubic, 3 ¹ / ₄ " wide x 2 ⁷ / ₈ " deep (84mm x 72mm)

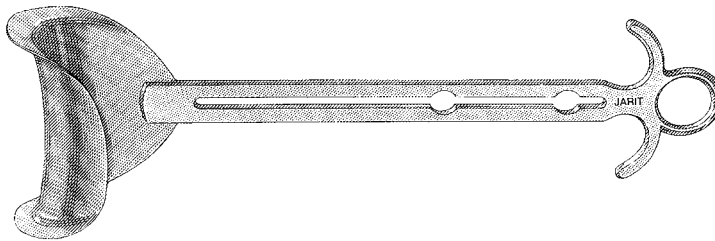

Balfour Center Blade (Horgan)

Catalog #	Description
205-294	12 ¹ / ₄ " (310mm), Horgan, malleable, 2" wide x 5 ⁵ / ₈ " deep (50mm x 142mm)

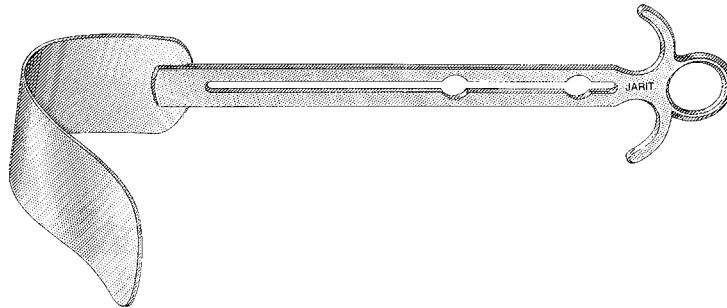

Balfour Center Blade

Catalog #	Description
205-298	12" (306mm), standard 3 ¹ / ₈ " wide x 1 ⁷ / ₈ " deep (80mm x 48mm)

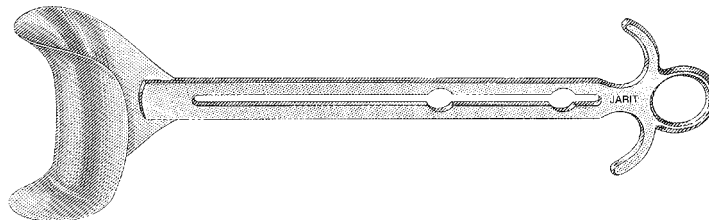

Balfour Center Blade

Catalog #	Description
205-299	11 ¹ / ₂ " (292mm), extra deep, 2 ³ / ₈ " wide x 3 ⁷ / ₈ " deep (60mm x 100mm)

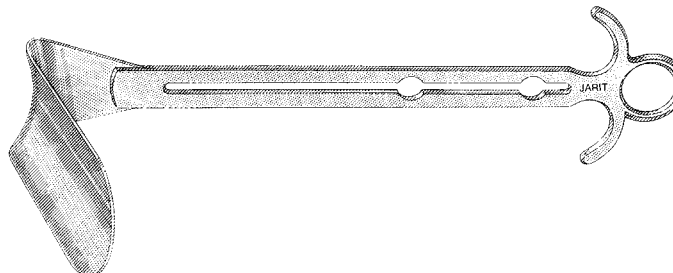

Balfour Abdominal Retractor with Ratchet Bar

Catalog #	Description
205-300	7" (178mm) spread with attached 2" (51mm) deep wire lateral blades Set includes: 205-298, 1 each center blade, 3 1/8" wide x 1 7/8" deep (80mm x 48mm)
205-305	7" (178mm) spread with attached 4" (101mm) deep wire lateral blades Set includes: 205-298, 1 each center blade, 3 1/8" wide x 1 7/8" deep (80mm x 48mm)
205-SPS-305	Replacement Spring and Screw

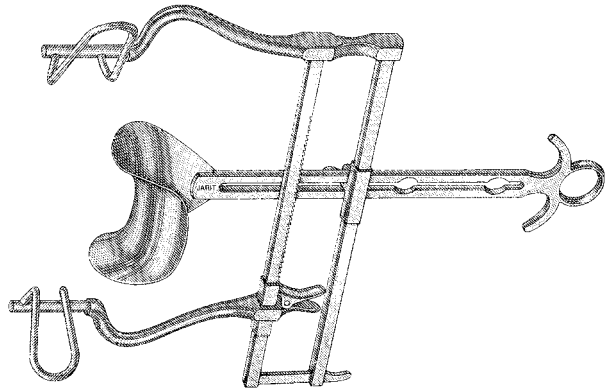

Balfour Abdominal Retractor, Pediatric Size

Catalog #	Description
205-310	3 1/2" (89mm) spread Set includes: attached 1 3/8" (35mm) deep wire lateral blades 205-CTR-310, 1 each center blade 7/8" wide x 7/8" deep (22mm x 22mm)
205-KNT-310	Replacement Knurled Nut pkg/6ea
205-CTR-310	Replacement Center Blade 1" x 1" x 3 3/8" (24mm x 25mm x 87mm)
205-ESC-310	Replacement End Screw
205-SBW-310	Replacement Slide Bar and Wing Nut
205-TSC-310	Replacement Thumb Screw

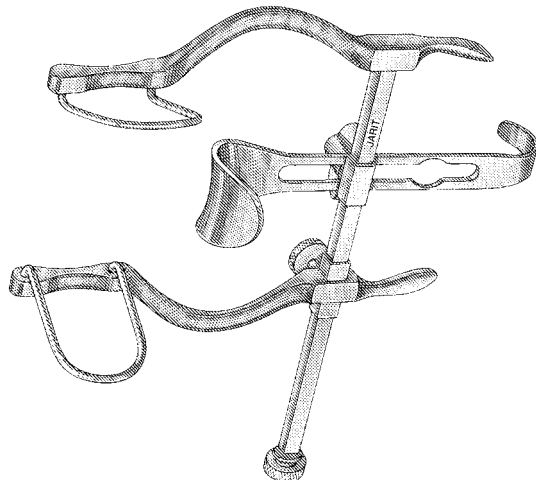

Balfour Abdominal Retractor with Ratchet Bar Positioning Mechanism

Catalog #	Description
205-315	7¾" (197mm) spread Set includes: 205-330, 1 pair 2½" (64mm), deep interchangeable wire lateral blades 205-331, 1 pair 3½" (88mm), deep interchangeable wire lateral blades 205-320, 1 each center blade, 2⅝" wide x 1⅝" deep (67mm x 42mm) Snap-on lateral blades can be attached and removed in seconds
205-316	10½" (267mm) spread Set includes: 205-330, 1 pair 2½" (64mm), deep interchangeable wire lateral blades 205-331, 1 pair 3½" (88mm), deep interchangeable wire lateral blades 205-320, 1 each center blade, 2⅝" wide x 1⅝" deep (67mm x 42mm) Snap-on lateral blades can be attached and removed in seconds
205-ARM-315	Replacement Removable Arm only
205-FRM-315	Replacement Frame only for 205-315
205-SLB-315	Replacement Slide bar w/Wing Nut
205-FRM-316	Replacement Frame only for 205-316

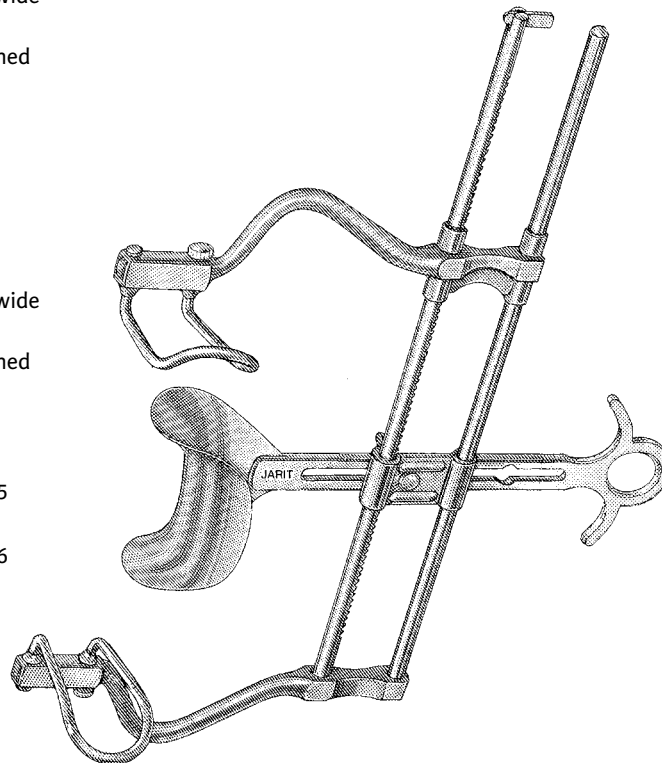

Balfour Wire Lateral Blades

for 205-315 and 205-316, supplied in pairs (2/Per)

Catalog #	Description
205-330	2½" (64mm) deep
205-331	3½" (89mm) deep
205-332	4" (101mm) deep

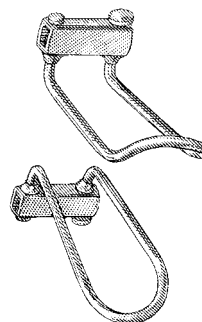

Balfour Center Blade

for 205-315 and 205-316

Catalog #	Description
205-320	10 ³ / ₄ " (270mm), standard 2 ⁵ / ₈ " wide x 1 ⁵ / ₈ " deep (67mm x 42mm)

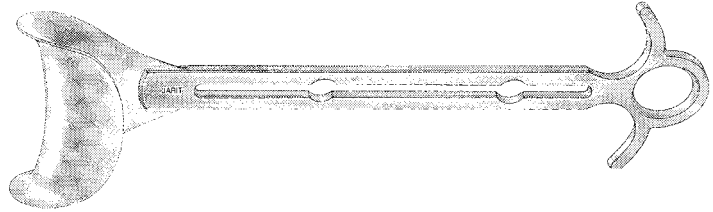

Balfour Center Blade

for 205-315 and 205-316

Catalog #	Description
205-321	10 ³ / ₄ " (270mm), standard, 3 ⁵ / ₈ " wide x 1 ³ / ₄ " deep (92mm x 44mm)

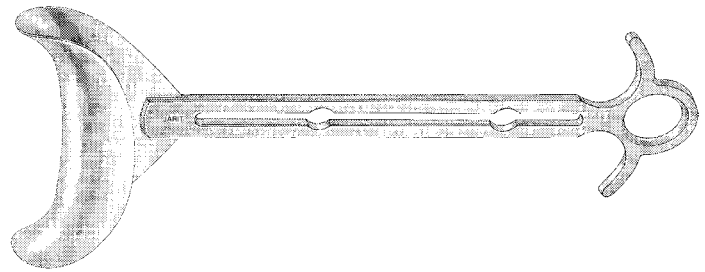

Balfour Center Blade

for 205-315 and 205-316

Catalog #	Description
205-322	10 ³ / ₄ " (270mm), supra-pubic, 2 ⁵ / ₈ " wide x 2 ³ / ₄ " deep (67mm x 70mm)

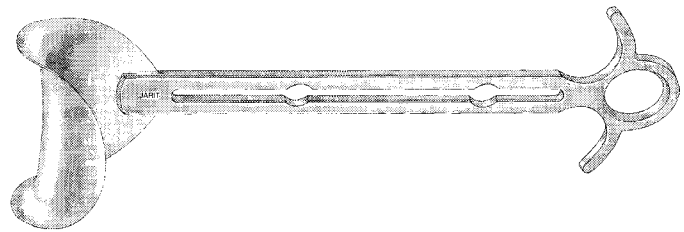

Balfour Center Blade

for 205-315 and 205-316

Catalog #	Description
205-323	10 ³ / ₄ " (270mm), supra-pubic, 3 ¹ / ₄ " wide x 2 ³ / ₄ " deep (83mm x 69mm)

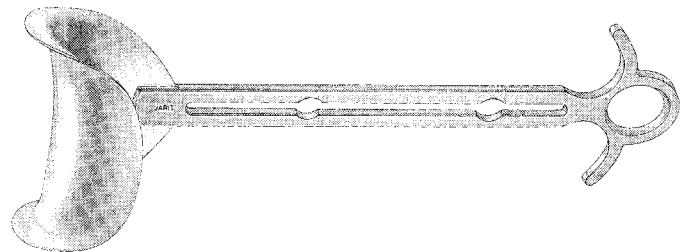

Balfour Center Blade (Horgan)

for 205-315 and 205-316

Catalog #	Description
205-324	15 ³ / ₄ " (400mm), Horgan, malleable, 2" wide x 7 ³ / ₄ " deep (51mm x 195mm)

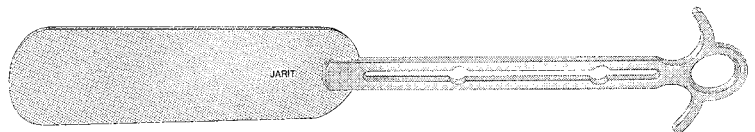

Balfour Fourth Blade Attachments

for 205-315 and 205-316 (center blade not included)

Catalog #	Description
205-312	For right arm, arm depth 241mm
205-313	For left arm (illustrated), arm depth 241mm
205-SB-312	Replacement Slide Bar (clamp)

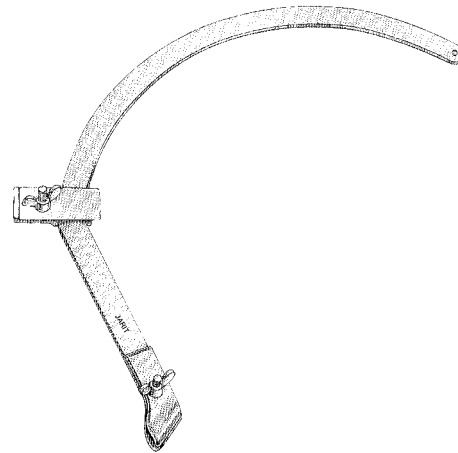

O'Sullivan-O'Connor Abdominal Retractor

with 3 removable and 2 fixed blades

Catalog #	Description
205-325	Opening 189mm x 141mm Removable blades: 1 3/4" x 3 1/4" deep (46mm x 83mm) 1 3/4" x 3 1/4" deep (46mm x 83mm) 2 7/8" x 4 3/8" deep (72mm x 112mm) Fixed blades: 1" x 2 5/8" deep (25mm x 66mm)
205-FRM-325	Replacement Frame only
205-SRW-325	Replacement Screw
205-WGN-325	Replacement Wing Nut
205-BLD-325	Replacement Blades (Set of 3)
205-SBL-325	Replacement Small Blade only
205-LBL-325	Replacement Large Blade only

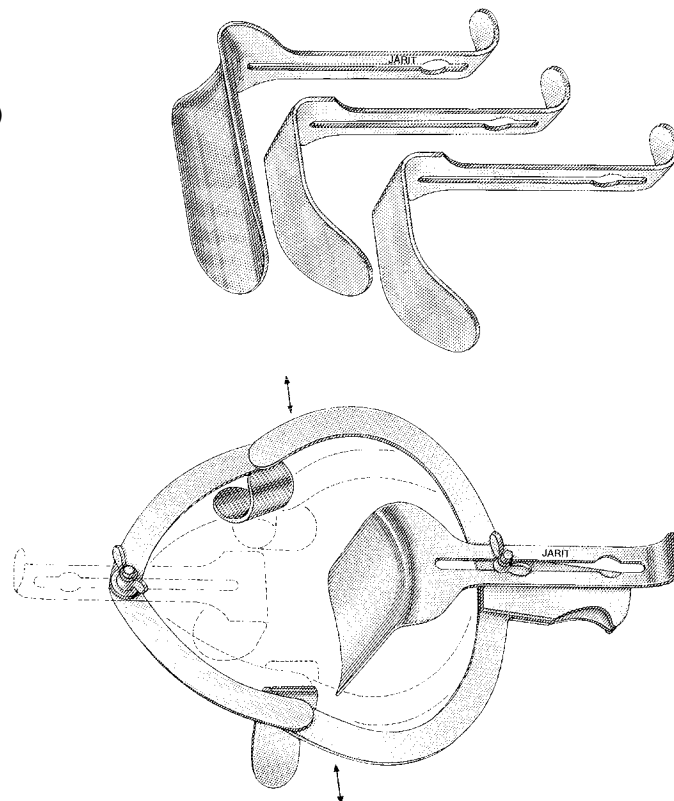

The Seton Shallow Surgical Retractor is a four sided stainless steel surgical retractor developed to aid the surgeon during shallow or superficial surgery with the use of a combination of different retractor blades, toothed or cupped.

- A complete, obstruction-free surgical window.
- A reduction of extraneous motion, fatigue and constant repositioning.
- An operative window that can be incrementally increased or decreased.
- The ability to perform an unassisted surgical procedure.

Seton* Shallow Surgical Retractor

Catalog #	Description
205-500	Complete set includes: 205-502, 1 ea: retractor frame 205-504, 1 ea: retractor blade semi-sharp, 1" x 2" (25mm x 53mm) 205-506, 1 ea: retractor blade semi-sharp, 1" x 1 1/8" (25mm x 30mm) 205-508, 1 ea: retractor blade semi-sharp, 1" x 11/16" (25mm x 20mm) 205-510, 1 ea: retractor blade Balfour-type, 7/8" x 2" (21mm x 51mm) 205-512, 1 ea: retractor blade Balfour-type, 1 1/8" x 1 1/4" (27mm x 33mm) 205-514, 1 ea: retractor blade Balfour-type, 7/8" x 1 1/8" (21mm x 27mm)
205-502	Retractor Frame, 1" x 2 1/8" (25mm x 53mm)

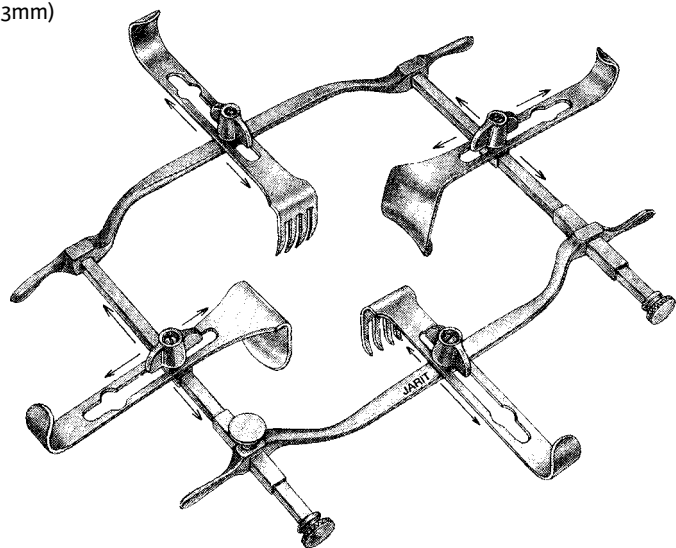

*Developed in cooperation with Joseph Z. Seton, M.D., Lenox Hill Hospital, New York, New York.

Seton Retractor Blades

semi-sharp type

Catalog #	Description
205-504	4 prong semi-sharp, set of two, 1" x 2" deep (25mm x 53mm)
205-506	4 prong semi-sharp, set of two, 1" x 1 1/8" deep (25mm x 30mm)
205-508	4 prong semi-sharp, set of two, 1" x 1 1/16" deep (25mm x 20mm)

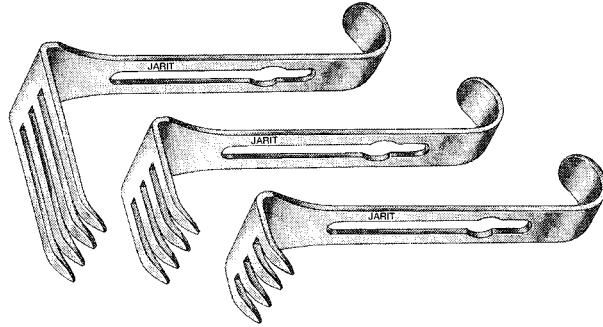

Seton Retractor Blades

Balfour-type

Catalog #	Description
205-510	Balfour-type, set of two, 7/8" x 2" deep (21mm x 51mm)
205-512	Balfour-type, set of two, 1 1/8" x 1 1/4" deep (27mm x 33mm)
205-514	Balfour-type, set of two, 7/8" x 1 1/8" deep (21mm x 27mm)

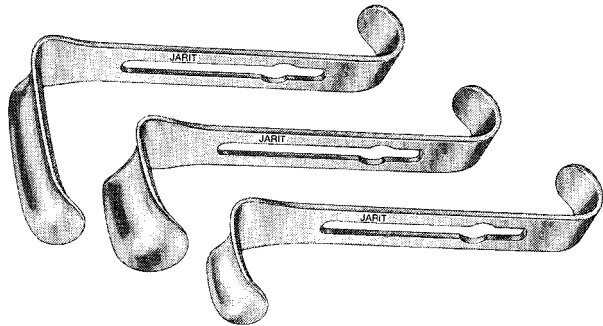

Henly Retractor

Catalog #	Description
205-530	7" (180mm), improved pattern, with interchangeable lateral and center blades
	Complete set includes: 1 frame
205-532	1 pair lateral blades, blunt, 7/8" wide x 1" deep (22mm x 25mm)
205-534	1 pair lateral blades, blunt, 7/8" wide x 2" deep (22mm x 51mm)
205-536	1 pair lateral blades, blunt, 7/8" wide x 3" deep (22mm x 76mm)
205-540	1 center blade, 3/4" wide x 3/4" deep (18mm x 19mm)
205-542	1 center blade, 3/4" wide x 1" deep (18mm x 25mm)
205-544	1 center blade, 3/4" wide x 1 1/4" deep (18mm x 32mm)
205-FRM-530	Replacement Frame only

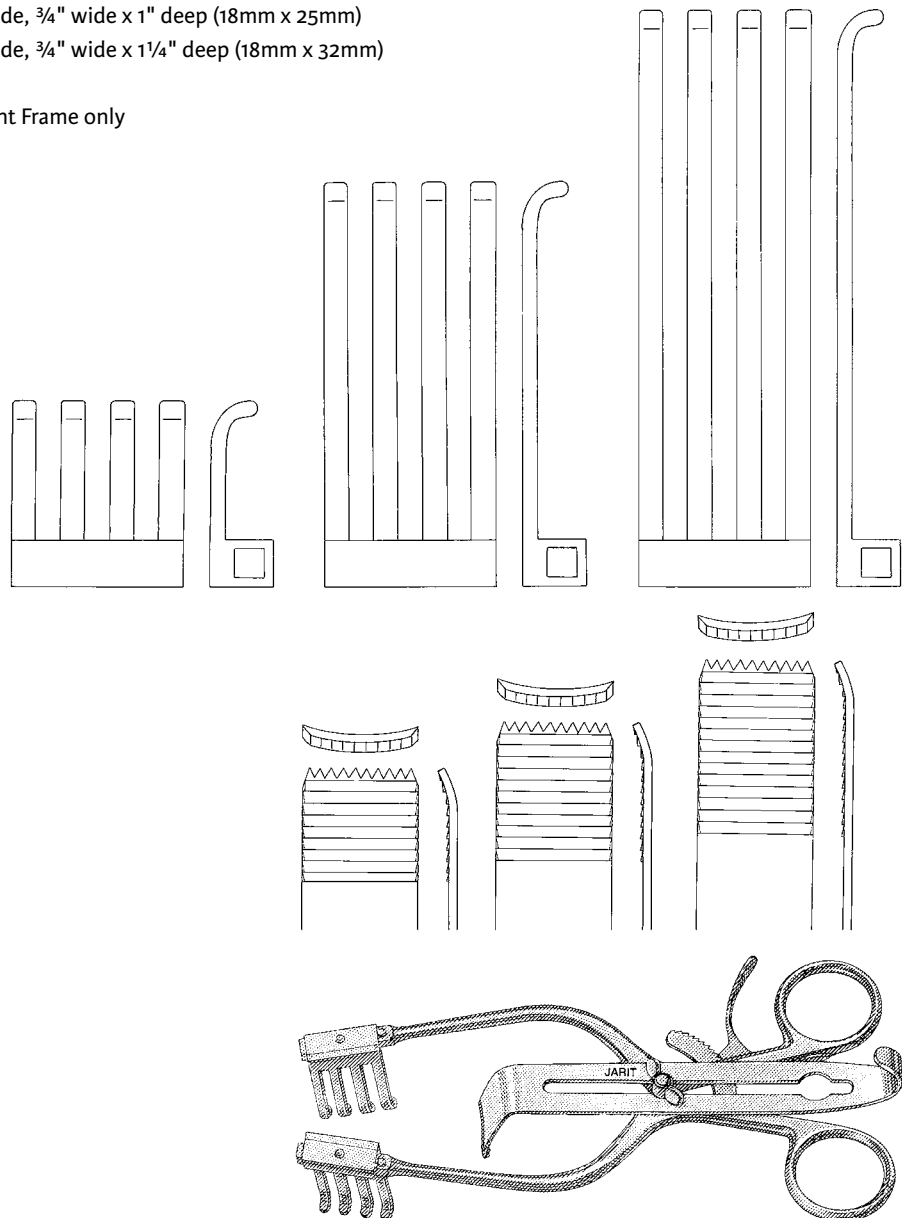

Henly Retractor

Catalog #	Description
205-550	7" (180mm), original pattern, with 3 interchangeable center blades
	Center blades measure:
205-540	3/4" wide x 3/4" deep (18mm x 19mm)
205-542	3/4" wide x 1" deep (18mm x 25mm)
205-544	3/4" wide x 1 1/4" deep (18mm x 32mm)
205-FRM-550	Replacement Retractor Frame only

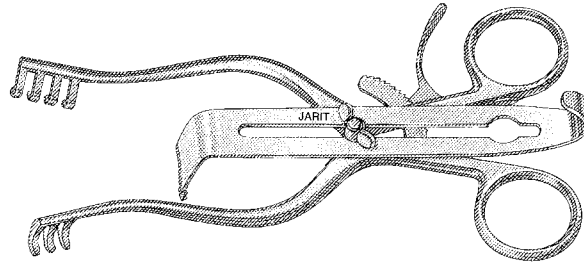

Garrett, Peripheral Vascular Self-Retaining Retractor

Catalog #	Description
205-560	7 1/4" (184mm), retractor set consists of retractor body and 3 pairs of (6) detachable blades
205-561	Frame only
205-562	1 1/2" x 1 1/4" (37mm x 32mm)
205-563	1 1/2" x 2 1/4" (37mm x 57mm)
205-564	1 1/2" x 3 1/4" (37mm x 82mm)

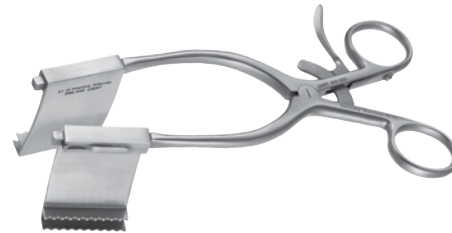

Darling Popliteal Retractor, Self-Retaining

left: overall length 7" (175mm), total opening 3 3/4" (95mm)

Catalog #	Description
205-260	Short blade, width 1" (25mm), depth 2 5/8" (68mm), left Long blade, width 1 5/8" (40mm), depth 2 5/8" (68mm), left



Darling Popliteal Retractor, Self-Retaining

right: overall length 7" (175mm), total opening 3 3/4" (95mm)

Catalog #	Description
205-261	Short blade, width 1" (25mm), depth 2 5/8" (68mm), right Long blade, width 1 5/8" (40mm), depth 2 5/8" (68mm), right



Ochsner Vascular Retractor

self-retaining, swivel blades, flexible arms
overall length 8" (203mm), total opening 5½" (140mm)

Catalog #	Description
205-570	Arm length: ¾" (83mm) Blades: 1" (25mm) wide x 2" (52mm) depth





Integra™
Orthopedic
Instruments and
General Surgical
Instruments

Esmarch Plaster Shears

Catalog#	Description
220-100	8" (202mm)

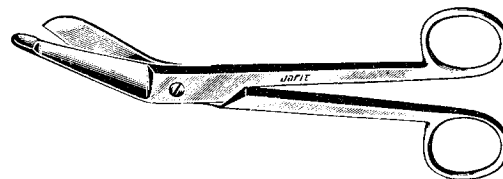

Bruns Plaster Shears

Catalog#	Description
220-105	9 1/4" (238mm)

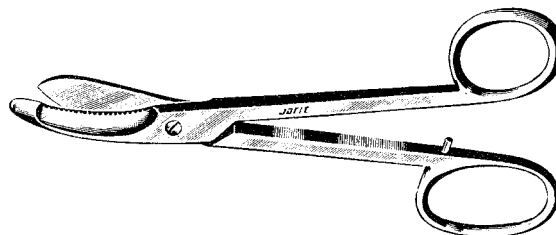

Hercules Plaster Shears

Catalog#	Description
220-110	7 1/2" (191mm), eccentric lock

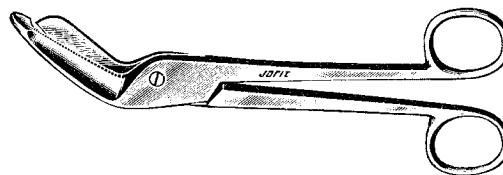

Plaster and Utility Shears

Catalog#	Description
220-115	8 1/4" (210mm), notched blade

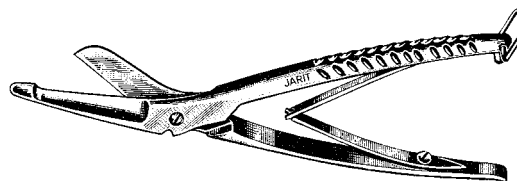

Universal Bandage Scissors

one serrated blade, stainless steel with autoclavable plastic finger rings

Catalog #	Description
100-539	5 3/4" (145mm), Black

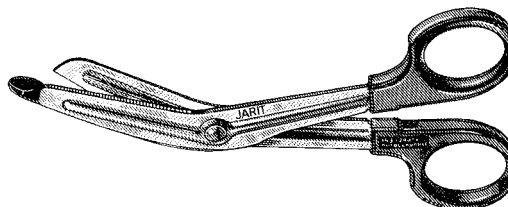

Universal Bandage Scissors

one serrated blade, stainless steel with autoclavable plastic finger rings

Catalog #	Description
100-540	7½" (190mm), black
100-541	7½" (190mm), red
100-542	7½" (190mm), orange
100-543	7½" (190mm), blue
100-544	7½" (190mm), purple
100-545	7½" (190mm), green
100-546	7½" (190mm), yellow



Stille Plaster Shears

Catalog#	Description
220-130	15" (380mm)

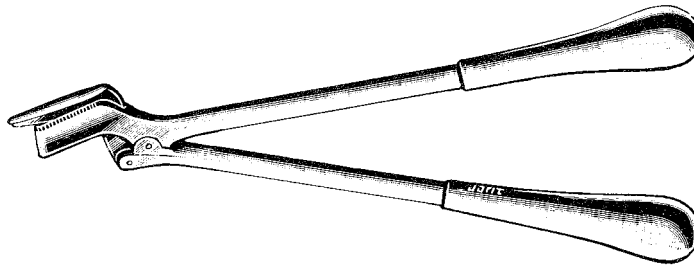

Wolfe-Boehler Cast Breaker

Catalog#	Description
220-155	10½" (267mm)

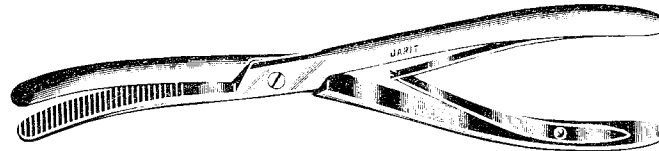

Hennig Cast Spreader

Catalog#	Description
220-175	11" (280mm)

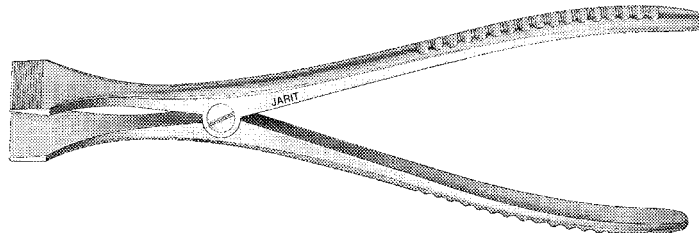

Walton Cast Spreader

Catalog#	Description
220-180	8¾" (225mm)
220-SPS-180	Replacement Spring and Screw pkg/3ea

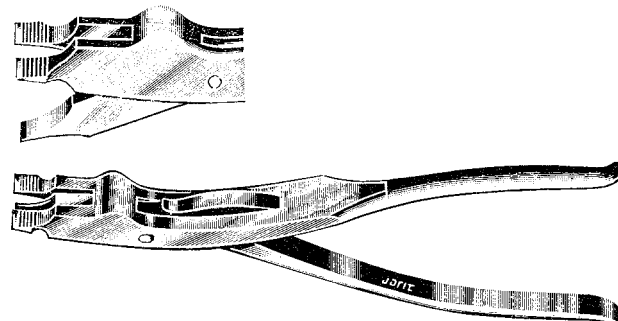

Kern Bone Holding Clamps

ratchet

Catalog #	Description
225-105	6½" (163mm)
225-115	9¾" (245mm)
225-SPS-105	Replacement Screw and Spring for Ratchet Mechanism

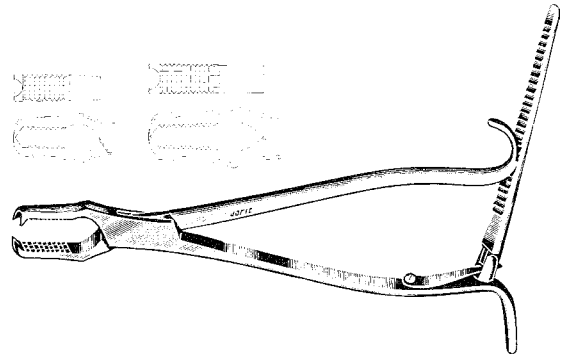

Lane Bone Holding Clamps

ratchet

Catalog #	Description
225-121	13" (328mm)
225-126	13" (330mm), heavy model
225-131	16¾" (425mm)

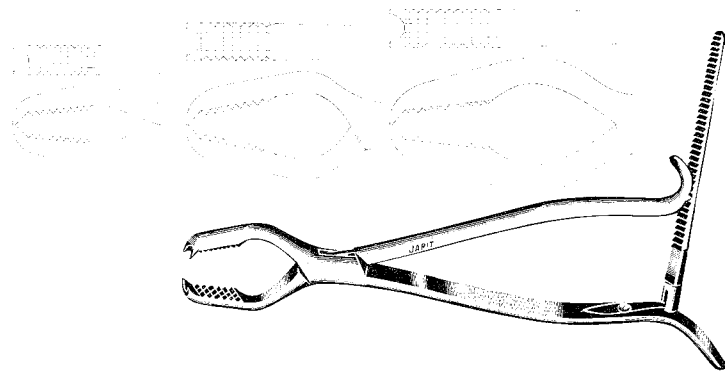

Bone Reduction Forceps

speed lock, curved jaws

Catalog #	Description
225-135	6¾" (170mm)
225-136	9¼" (235mm)

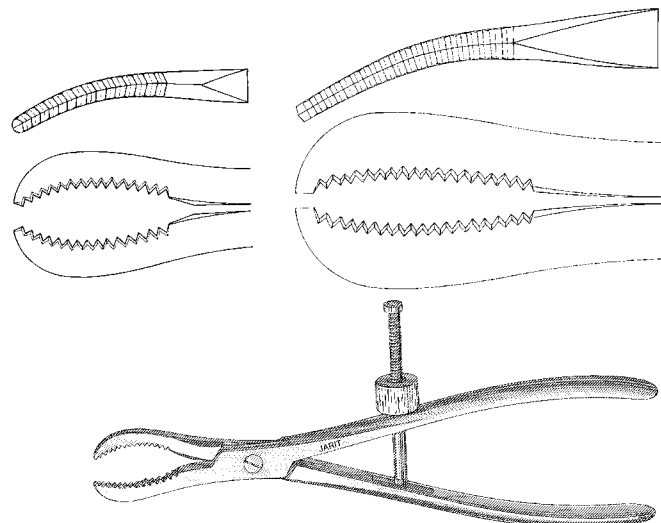

Bone Reduction Forceps

curved jaws

Catalog #	Description
225-137	5 ⁵ / ₈ (144mm)

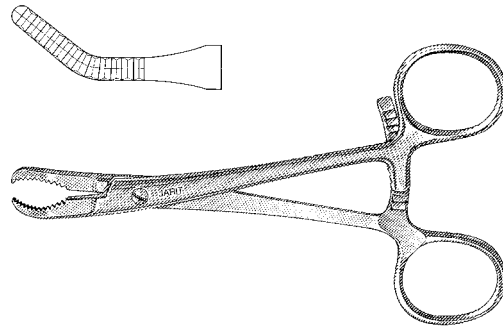

Bone Reduction Forceps

Catalog #	Description
225-138	7 ³ / ₄ (198mm), 2" (51mm) long ratchet, jaw opening from 3 ³ / ₈ " to 4" (9mm x 101mm)

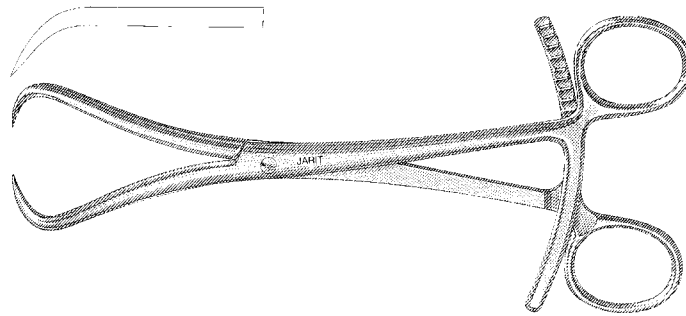

Bone Reduction Forceps

curved jaws

Catalog #	Description
225-139	5 ⁷ / ₈ (150mm)

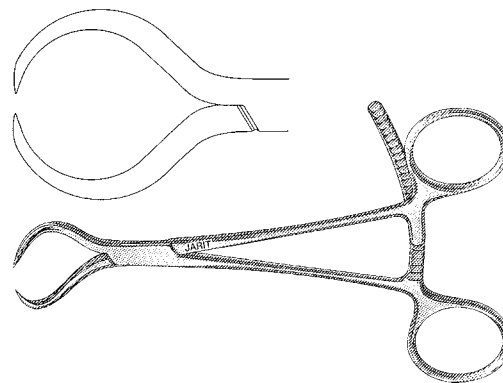

Lambotte Bone Holding Clamp

Catalog #	Description
225-162	12" (305mm)

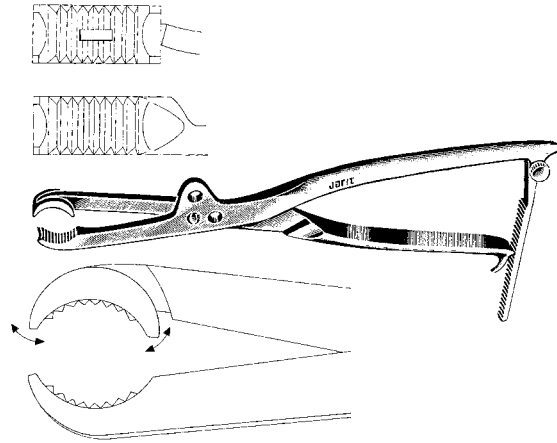

Farabeuf-Lambotte Bone Holding Clamp

Catalog #	Description
225-170	10" (257mm)

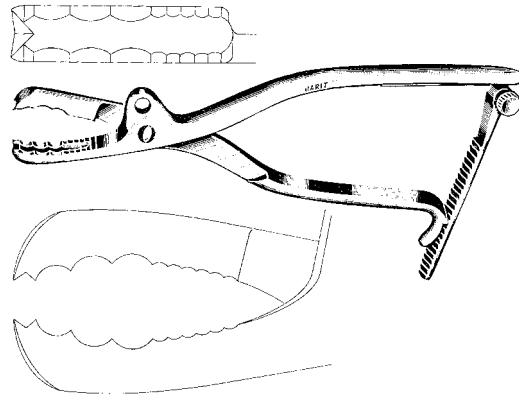

Lewin Bone Holding Clamp

Catalog #	Description
225-175	7" (180mm)

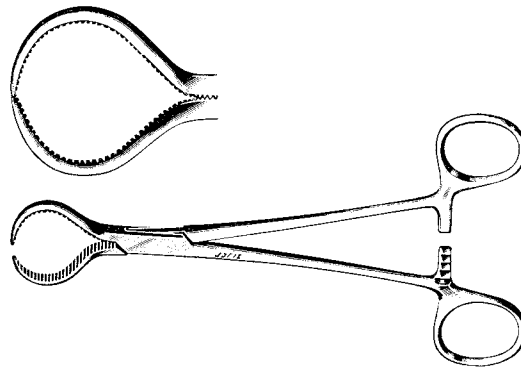

Self-Centering Bone Forceps

with speed lock, angled to the side

Catalog#	Description
225-176	5¾" (145mm), for small fragment, 3mm wide jaw
225-177	7¾" (195mm), 8mm wide jaw
225-178	9¾" (246mm), 10mm wide jaw
225-179	10¼" (260mm), 10mm wide jaw
225-180	11" (282mm), 11.7mm wide jaw

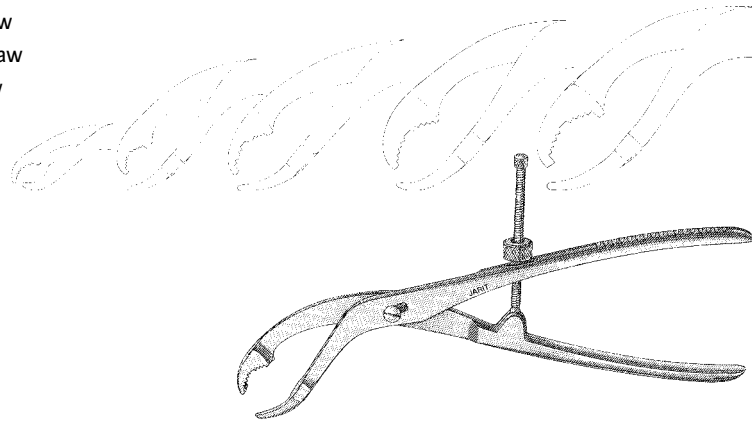

Verbrugge Bone Holding Clamp

angled to the side

Catalog #	Description
225-185	7" (175mm) small, 5.2mm wide jaw

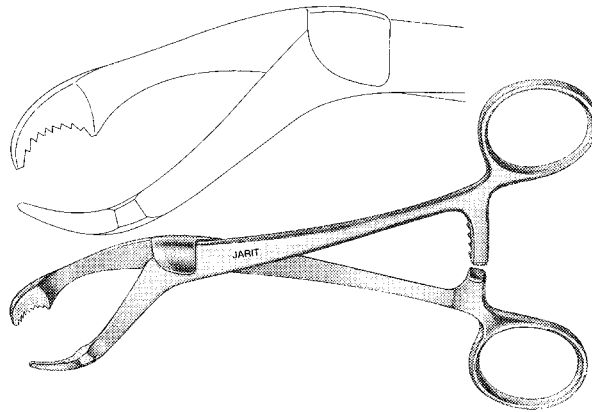

Verbrugge Bone Holding Clamps

angled to the side

Catalog #	Description
225-186	10¼" (263mm), 9.5mm wide jaw
225-187	10½" (264mm), 10.5mm wide jaw
225-188	10¾" (271mm), 12mm wide jaw

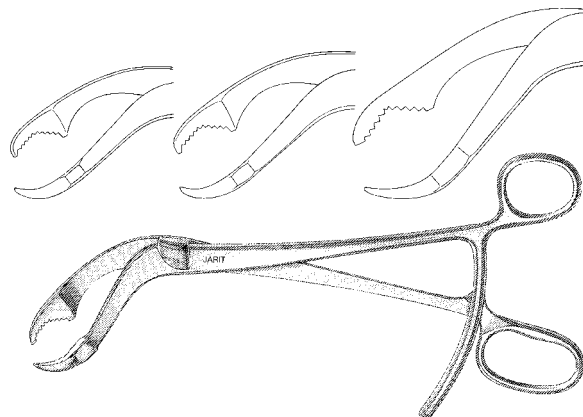

Ulrich-Style Bone Holding Forceps
with speed lock

Catalog#	Description
225-190	7¼" (185mm), 2.9mm wide jaws
225-191	9" (229mm), 9mm wide jaws
225-192	10" (255mm), 9mm wide jaws
225-193	11" (280mm), 9mm wide jaws
225-194	11" (280mm), angled on side, 8.7mm wide jaws

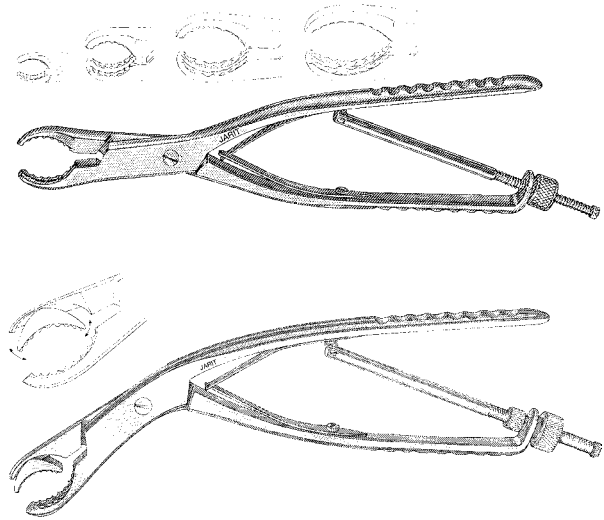

Lowman Bone Holding Clamps
1 x 2 prongs

Catalog#	Description
225-200	5¼" (134mm)
225-205	7¼" (184mm)
225-210	8½" (215mm)
225-THB-200	Replacement Threaded Blade
225-THB-205	Replacement Threaded Blade
225-THB-210	Replacement Threaded Blade

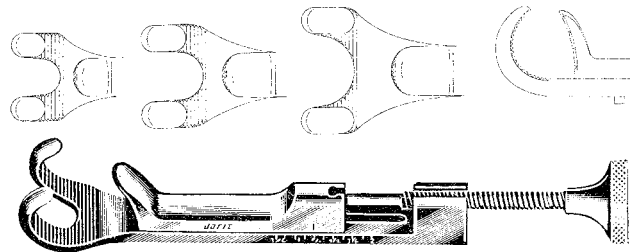

Lowman Bone Holding Clamps
1 x 1 prongs

Catalog#	Description
225-215	5¼" (134mm)
225-220	7¼" (184mm)
225-225	8½" (215mm)
225-TRK-225	Replacement Threaded Rod w/Knob

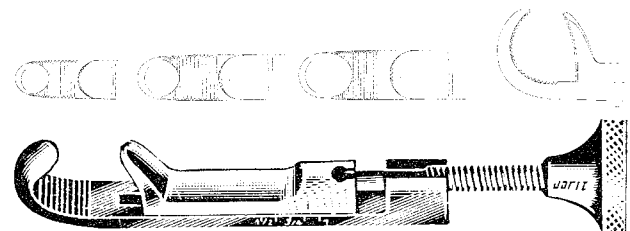

Lambert-Lowman Bone Holding Clamps
2 x 2 prongs

Catalog#	Description
225-230	7¼" (184mm)
225-235	8½" (215mm)

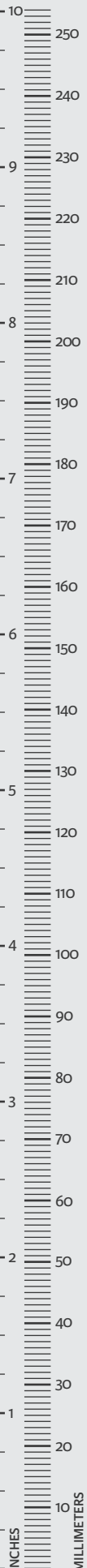
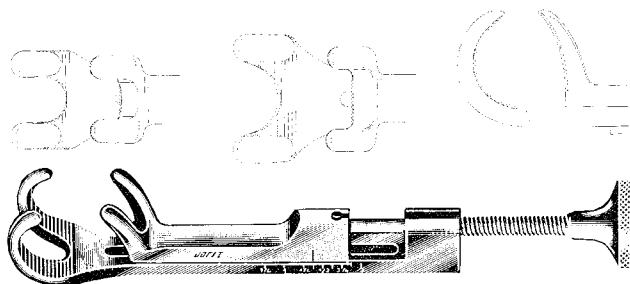

Bennett Tibia Retractors

Catalog#	Description
225-400	9¾" (245mm), 1¾" (45mm) narrow blade
225-402	9¾" (245mm), 2½" (62.25mm) wide blade

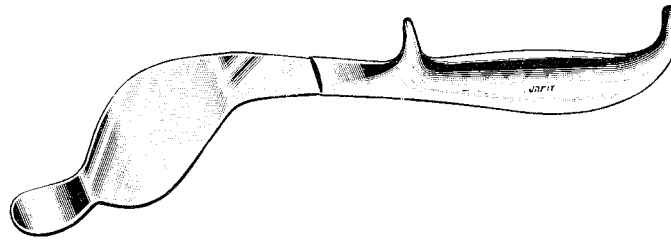

Blount Knee Retractor

Catalog#	Description
225-405	7" (175mm), ¼" (7mm) wide blade

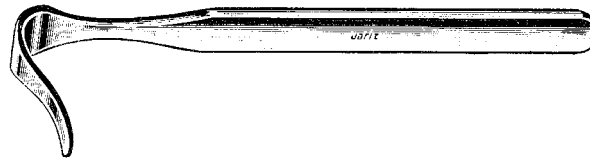

Blount Retractor

Catalog#	Description
225-407	10¼" (260mm), single prong, 1½" (38mm) wide blade



Blount Retractor

Catalog#	Description
225-408	10½" (265mm), double prong, 1⅝" (41mm) wide blade

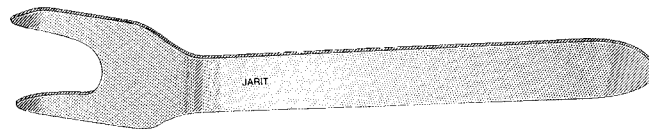

Liston Amputating Knives

Catalog#	Description
225-412	6¼" (159mm) blade
225-413	8½" (216mm) blade



Murphy-Lane Bone Skid

Catalog #	Description
225-420	11 3/4" (300mm), double-ended 3/4" x 1 1/8" (18mm x 30mm)

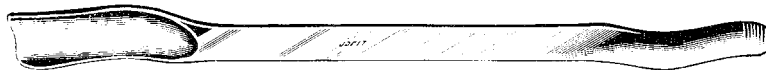

Meyerding Hip and Shoulder Skid

Catalog #	Description
225-425	13 1/2" (340mm), blade size 4 1/4" x 1 1/8" wide (108mm x 30mm)

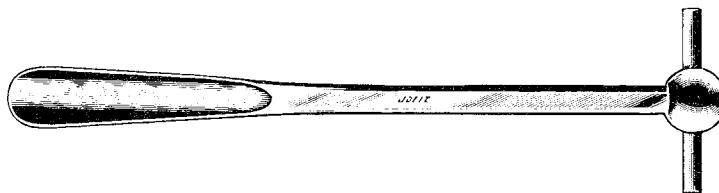

Smillie Retractors

Catalog #	Description
225-430	5 3/8" (138mm), reverse curved, 1/2" wide x 2 1/8" long blade (13mm x 54mm)
225-431	5 3/8" (138mm), angled, 3/4" wide x 1 3/8" long blade (19mm x 35mm)
225-432	5 3/8" (138mm), angled, 3/4" wide x 2" long blade (19mm x 51mm)
225-433	5 3/8" (138mm), angled, 3/4" wide x 2 3/8" long blade (19mm x 60mm)
225-434	5 3/8" (138mm), curved, 1/2" wide x 5/8" long blade (13mm x 16mm)

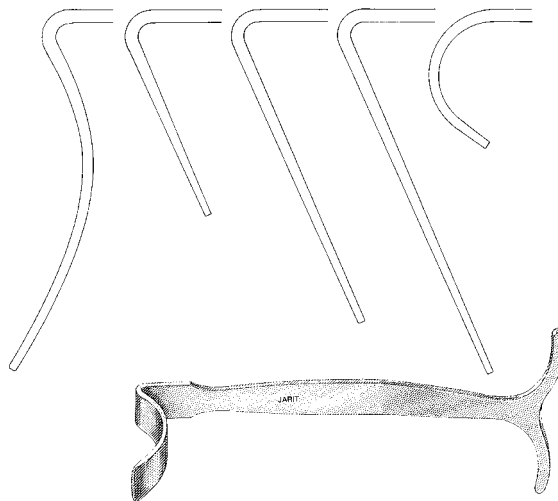

Hayes Hand Retractors

Catalog #	Description
225-436	5 1/4" (134mm), blade 1/2" x 1 1/8" (13mm x 30mm)
225-438	6 1/4" (160mm), blade 1/2" x 1 1/8" (13mm x 30mm)

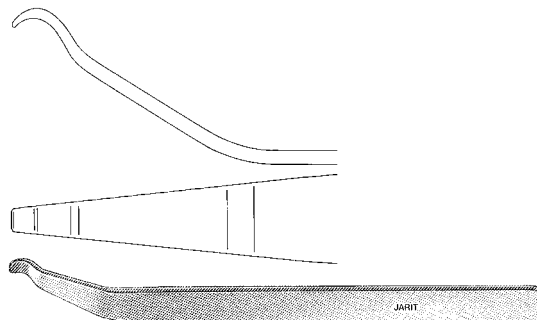

Mini-Hohmann Retractors

Catalog #	Description
225-440	6½" (164mm), 6mm wide blade
225-441	6½" (164mm), 8mm wide blade

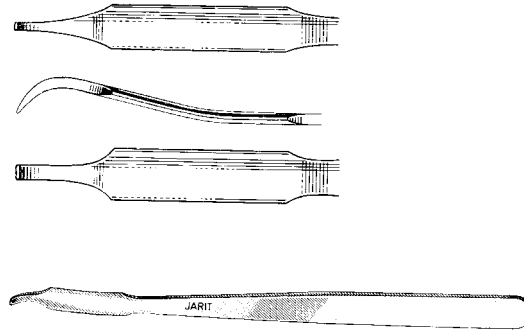

Hohmann Retractor

Catalog #	Description
225-443	4¾" (160mm), 16mm wide blade

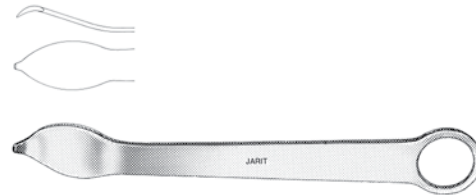

Hohmann Retractors

6¼" (160mm)

Catalog #	Description
225-444	15mm wide blade



Hohmann Retractors

Catalog #	Description
225-449	9¼" (235mm), 8mm wide blade
225-450	9¼" (235mm), 10mm wide blade
225-452	9¼" (235mm), 18mm wide blade
225-453	9¼" (235mm), 25mm wide blade
225-454	9¼" (235mm), 43mm wide blade
225-456	9¾" (248mm), 70mm wide blade



Aufranc Cobra Retractors

Catalog #	Description
225-470	10¼" (260mm), 32mm wide blade, pointed tip, serrated
225-471	10¼" (260mm), 32mm wide blade, blunt tip, serrated
225-472	10¼" (260mm), 32mm wide blade, blunt tip, smooth

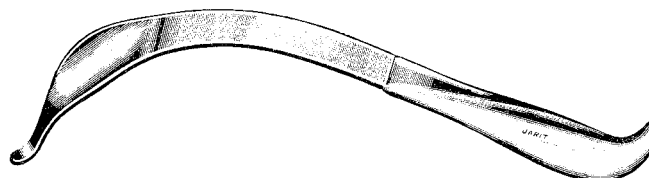

Deep Rake Retractors w/ Lamb Handles

4 blunt prongs, 2 1/4" (57mm) wide

Catalog#	Description
225-480	10 3/4" (273mm), 1 1/2" deep (38mm)
225-481	10 3/4" (273mm), 2" deep (51mm)
225-482	10 3/4" (273mm), 2 1/2" deep (64mm)
225-483	10 3/4" (273mm), 3" deep (76mm)

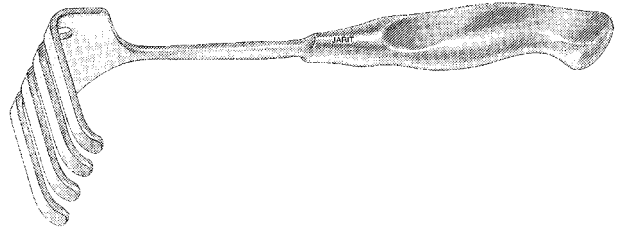

Initial Incision (Charnley) Retractor Set

Catalog#	Description
225-500	Set Includes: 1 ea. 225-499 frame only, 11 3/4" x 9 1/2" (300mm x 242mm) 1 ea. 225-502 short blade, 1" wide x 1 1/4" deep (25mm x 32mm) 1 ea. 225-503 long blade, 1" wide x 1 1/2" deep (25mm x 38mm) 1 ea. 225-504 weight on chain, stainless steel 3 3/4" x 2 1/8" (95mm x 55mm)
225-499	Frame only: 11 3/4 x 9 1/2 (300mm x 242mm)
225-502	Short blade: 2 3/8" (60mm), 1" wide x 1 1/4" deep (25mm x 32mm)
225-503	Long blade: 6 3/4" (174mm), 1" wide x 1 1/2" deep (25mm x 38mm)
225-501	Short blade: 2 3/8" (60mm), 1" wide x 3" deep (25mm x 76mm)
225-505	Long blade: 6 3/4" (174mm), 1" wide x 3" deep (25mm x 76mm)
225-506	Short blade: 2 3/8" (60mm), 1" wide x 4" deep (25mm x 103mm)
225-507	Long blade: 6 3/4" (174mm), 1" wide x 4" deep (25mm x 103mm)
225-508	Short blade: 2 3/8" (60mm), 1" wide x 5" deep (25mm x 130mm)
225-509	Long blade: 6 3/4" (174mm), 1" wide x 5" deep (25mm x 127mm)
225-504	Weight on chain, stainless steel 3 3/4" x 2 1/8" (95mm x 55mm)
225-CHN-500	Replacement Chain
225-XDB-500	Replacement Extra Deep Blades
225-XDP-500/S	Replacement Retr Blade Deep Short
225-XDP-500/L	Replacement Retr Blade Deep Long

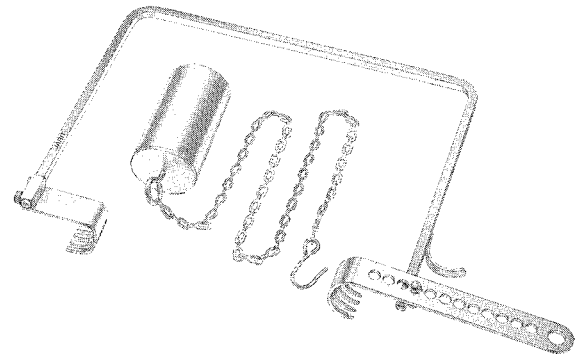

Horizontal Retractor

Catalog#	Description
225-510	12" (305mm), 4 x 2 prongs

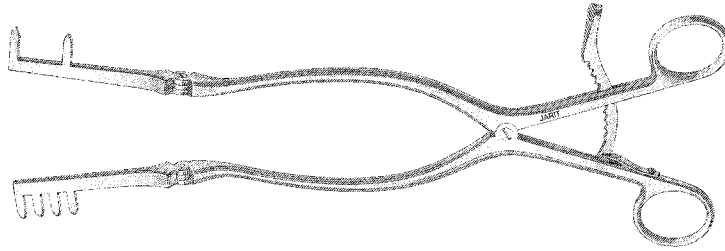

Vertical Retractor

Catalog#	Description
225-512	13" (330mm), 3 x 4 prongs

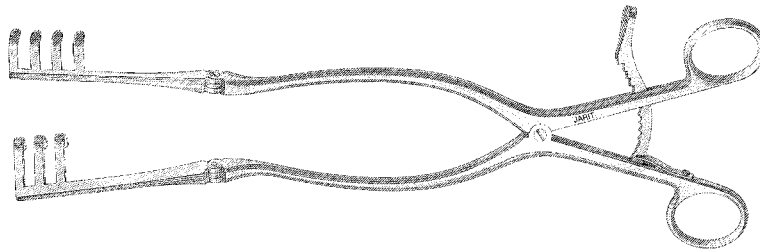

Lead hand
malleable

Catalog#	Description
225-520	Adult 14¾" x 10" (372mm x 255mm)
225-525	Pediatric 10¼" x 7" (260mm x 175mm)

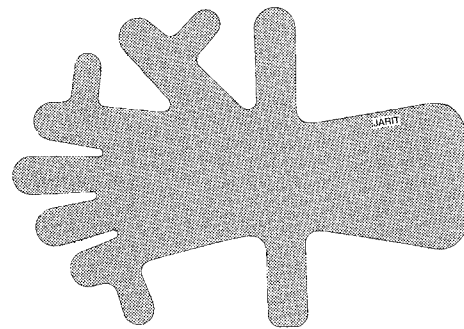

Blumenthal Rongeurs

3mm bite

Catalog #	Description
230-097	6" (155mm), 30°
230-095	6" (155mm), 45°
230-096	5¾" (147mm), 90°

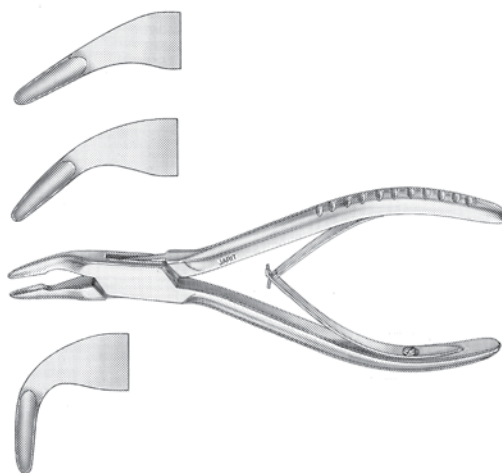

Micro Friedman Rongeurs

1.3mm bite

Catalog #	Description
230-093	5½" (140mm), straight

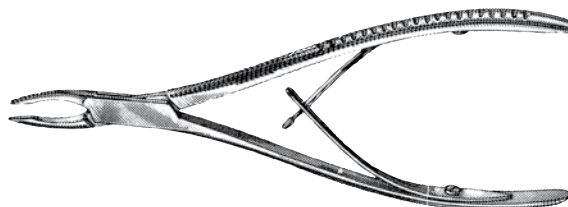

Micro Friedman Rongeur

2.4mm bite

Catalog #	Description
230-098	5¼" (132mm), curved
230-099	5⅝" (142mm), curved

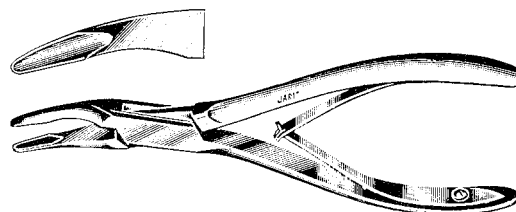

Luer Rongeurs

8mm bite

Catalog #	Description
230-100	7¼" (182mm), straight
230-102	7¼" (182mm), curved

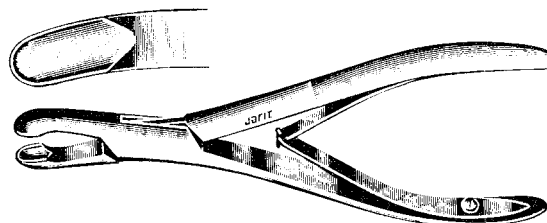

Shearer Chicken Bill Rongeurs

Catalog #	Description
230-105	5 ⁵ / ₈ " (142mm), strong curve, 5mm bite
230-106	6 ³ / ₄ " (170mm), light curve, 4.4mm bite

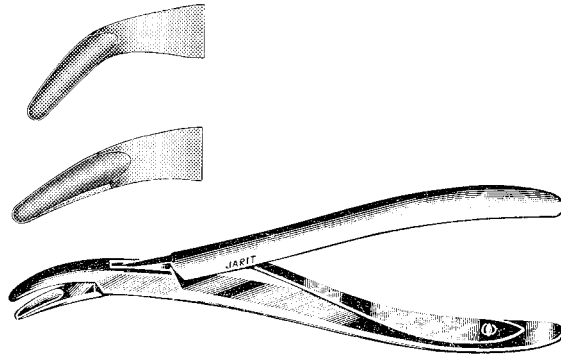

Reiner Rongeurs

Catalog #	Description
230-110	7" (178mm), 3.2mm bite, light curve
230-111	7" (178mm), 4.2mm bite, light curve
230-112	7" (178mm), 5.8mm bite, light curve

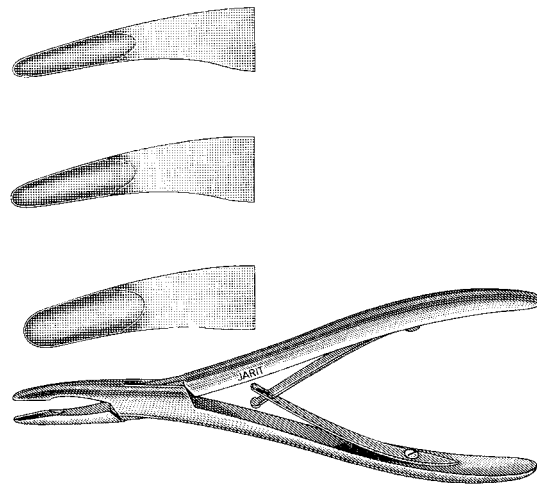

Hartman Rongeurs

5⁷/₈" (150mm)

Catalog #	Description
230-120	4.5mm bite, straight, jaw width from 4.5mm to 5.7mm
230-121	4.5mm bite, half curved, jaw width from 4.5mm to 5.4mm
230-122	4.5mm bite, full curved, jaw width from 4.5mm to 5.5mm

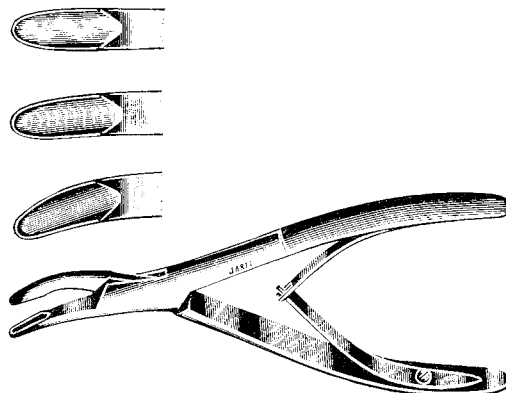

Bane Rongeurs

Catalog #	Description
230-124	7" (175mm), 4mm bite, curved
230-125	7" (175mm), 5mm bite, curved

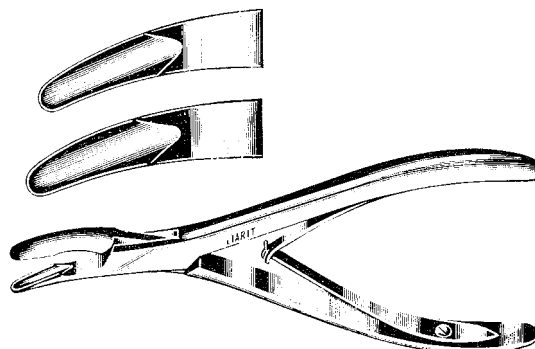

Lempert Rongeurs

2.5mm bite

Catalog #	Description
230-130	6¼" (158mm), straight
230-131	6¼" (158mm), curved
230-135	7½" (188mm), straight
230-136	7½" (188mm), curved

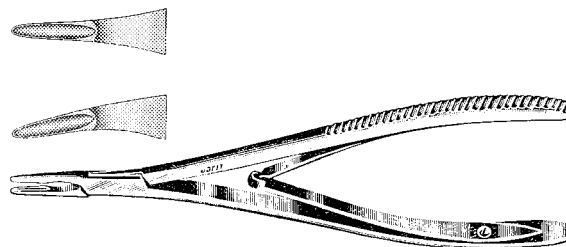

Juers-Lempert Rongeur

Catalog #	Description
230-138	7¼" (185mm), curved handle, 3mm bite

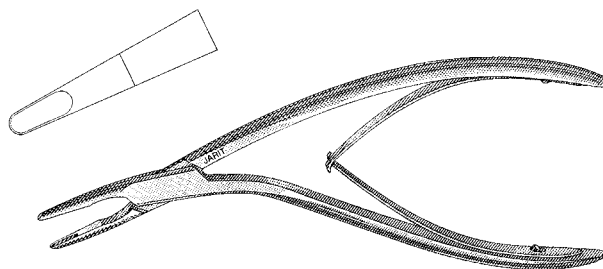

Dean Rongeur

Catalog #	Description
230-142	5¾" (146mm), 5mm bite, strong curve

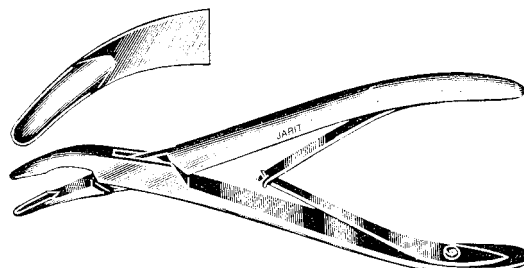

Cicherelli Rongeur

Catalog #	Description
230-145	6½" (165mm), 3.5mm bite, strong curve

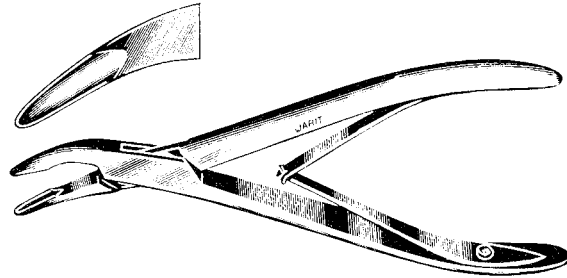

Adson Rongeurs

Catalog #	Description
230-150	8¼" (212mm), 8mm bite, straight
230-151	8¼" (212mm), 8mm bite, straight, serrated cup jaws

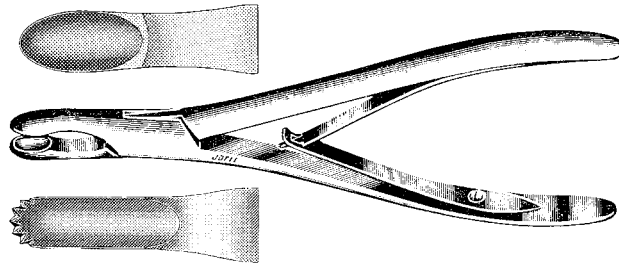

Cushing Rongeurs

6mm bite

Catalog #	Description
230-160	8" (204mm), straight
230-161	8" (204mm), curved

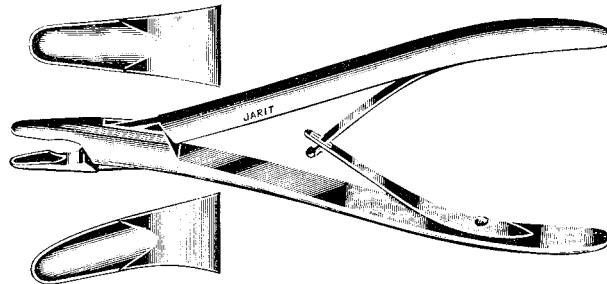

Ruskin Mini Bone Rongeurs

Catalog #	Description
230-195	6" (155mm), straight, 2mm bite
230-196	6" (155mm), curved, 2mm bite
230-197	6" (155mm), full curved, 3mm bite
230-200	6" (155mm), curved, 4mm bite
230-SPS-196	Replacement Spring and Screw

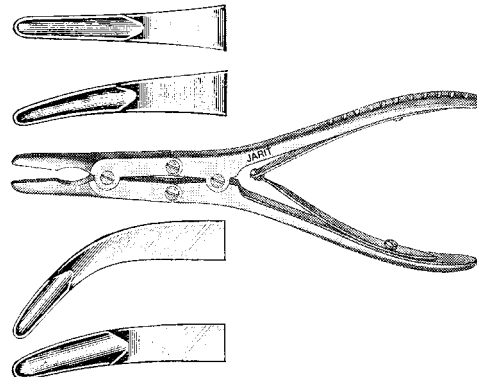

Beyer Rongeur

Catalog #	Description
230-205	7" (178mm), 3mm bite, light curve
230-SPS-205	Replacement Spring and Screw

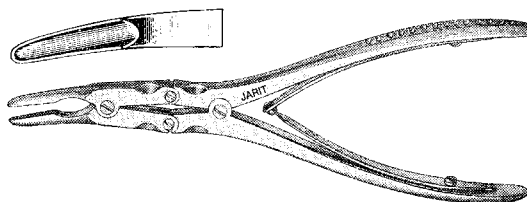

Jansen-Zaufel Rongeur

Catalog #	Description
230-207	7" (178mm), 4mm bite, light curve
230-SPS-205	Replacement Spring and Screw

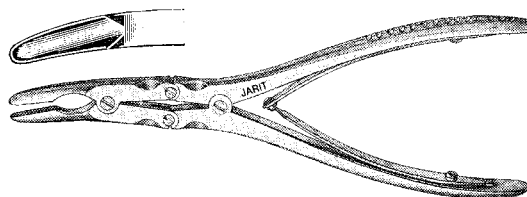

Ruskin Rongeurs

Catalog #	Description
230-210	7¼" (185mm), straight, 5mm bite
230-211	7¼" (185mm), curved, 5mm bite
230-214	7¼" (185mm), straight, 6mm bite
230-215	7¼" (185mm), curved, 6mm bite
230-SPS-205	Replacement Spring and Screw

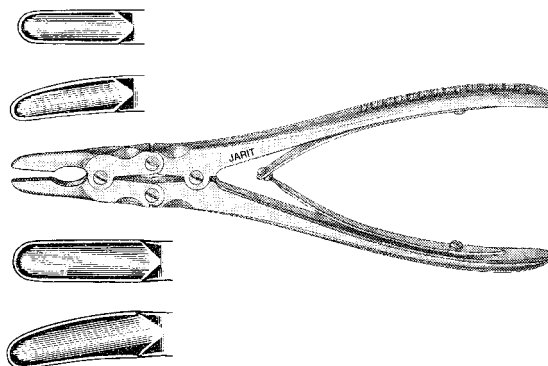

Ruskin-Jay Rongeur

Catalog #	Description
230-216	8" (202mm), heavy duty, light curved, 6mm bite

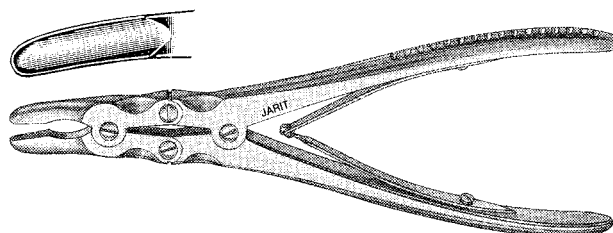

Ruskin Angular Duckbill Rongeur

Catalog #	Description
230-218	7¼" (181mm), 6mm bite
230-SPS-205	Replacement Spring and Screw

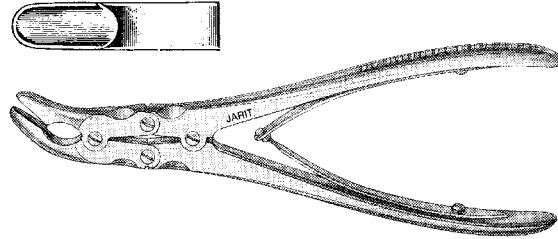

Stille-Luer Rongeurs

straight, 10mm bite

Catalog #	Description
230-230	8¾" (222mm)
230-235	10" (255mm)

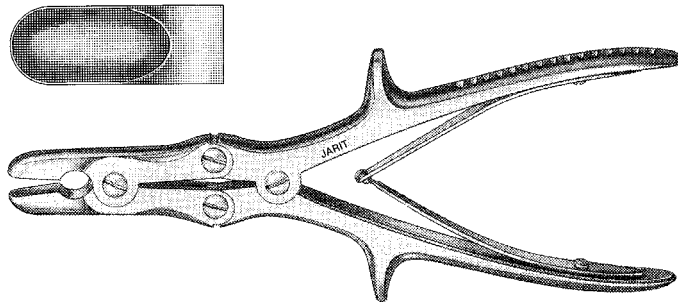

Stille-Luer Rongeurs

curved, 10mm bite

Catalog #	Description
230-231	8¾" (222mm)
230-236	10" (255mm)

230-SPS-236 Replacement Spring and Screw

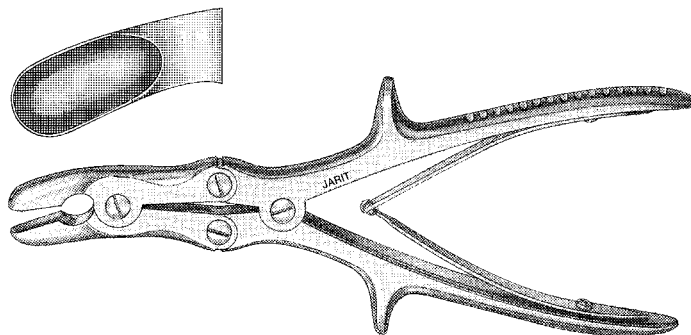

Stille-Luer Angular Duckbill Rongeurs

Catalog #	Description
230-240	9" (230mm), 6mm bite

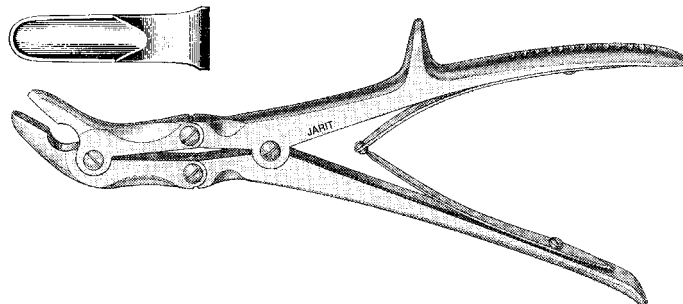

Echlin Angular Duckbill Rongeurs

Catalog #	Description
230-245	9" (230mm), 2mm bite
230-246	9" (230mm), 3mm bite
230-247	9" (230mm), 4mm bite
230-SPS-246	Replacement Spring and Screw

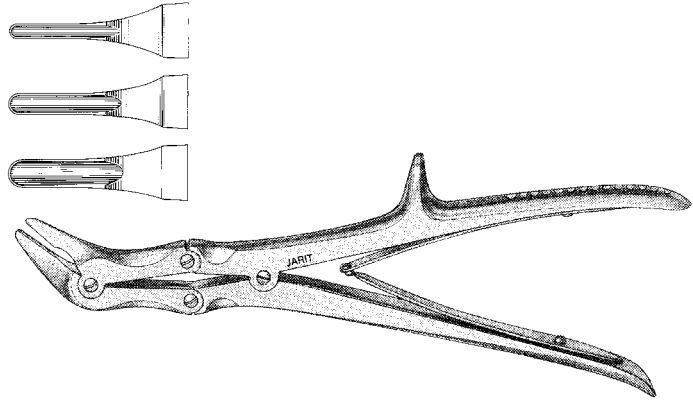

Stille-Luer-Echlin Angular Duckbill Rongeur

Catalog #	Description
230-250	9" (230mm), 6mm bite

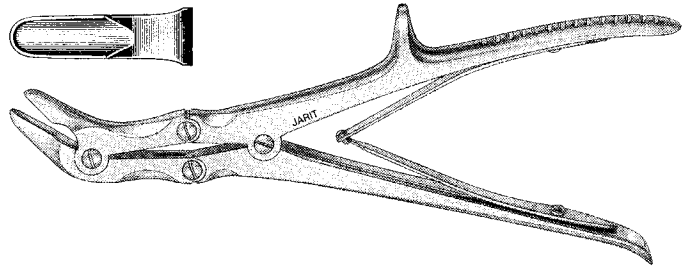

Leksell Rongeurs
slight curve

Catalog #	Description
230-260	9 1/4" (237mm), 3mm bite
230-261	9 1/4" (237mm), 8mm bite
230-262	9 1/4" (237mm), 5mm bite

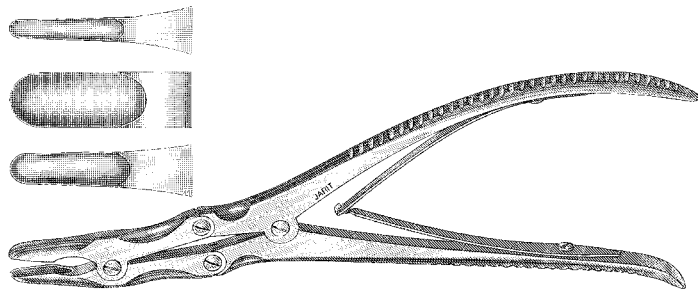

Leksell Rongeurs
full curve

Catalog #	Description
230-265	9 1/4" (237mm), 3mm bite
230-266	9 1/4" (237mm), 8mm bite
230-267	9 1/4" (237mm), 5mm bite

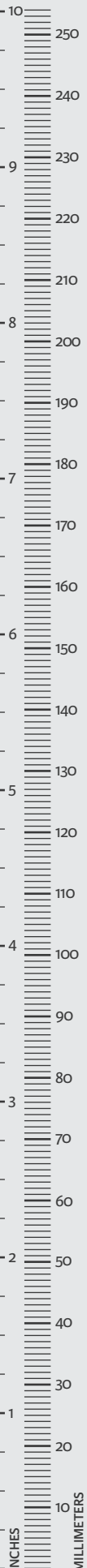
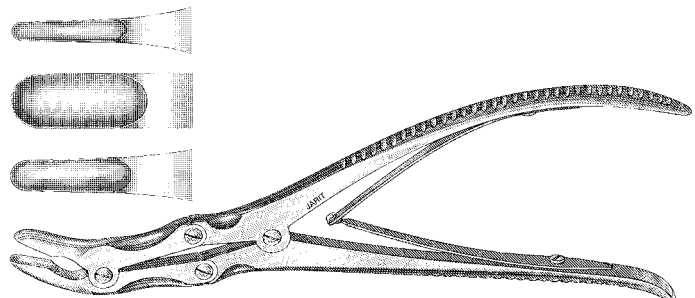

Smith-Petersen Laminectomy Rongeurs

3.5mm bite

Catalog #	Description
230-270	9½" (240mm), straight
230-271	9½" (240mm), half curved
230-272	9½" (240mm), full curved

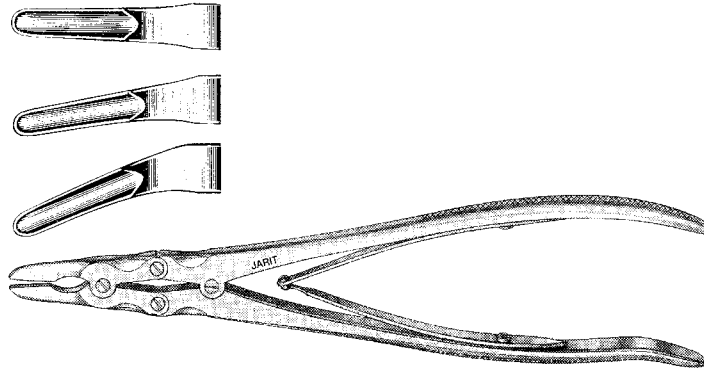

Sauerbruch Rib Rongeurs

square bite

Catalog #	Description
230-275	12" (305mm), 5/8" (16mm) wide jaw
230-276	12" (305mm), 3/4" (19mm) wide jaw

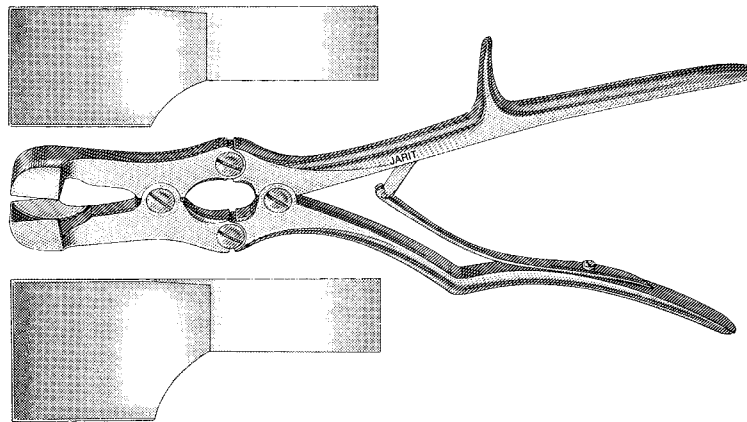

Dale Thoracic Rongeurs

3mm bite, slight curve

Catalog #	Description
230-280	13½" (343mm)

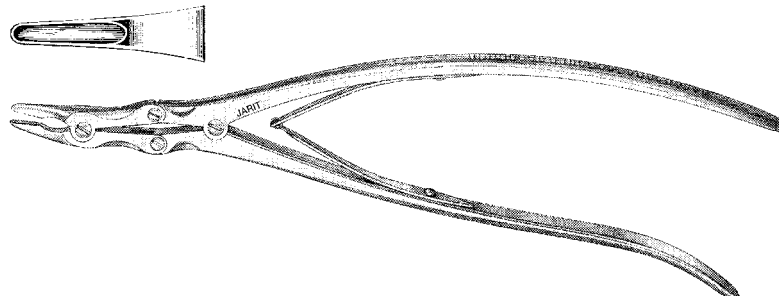

Walton-Liston Bone Cutting Forceps

14mm cutting jaws

Catalog #	Description
230-300	5 ⁵ / ₈ " (143mm), straight
230-301	5 ⁵ / ₈ " (143mm), up-angled
230-302	5 ⁵ / ₈ " (143mm), down-curved

230-SPS-300 Replacement Spring and Screws

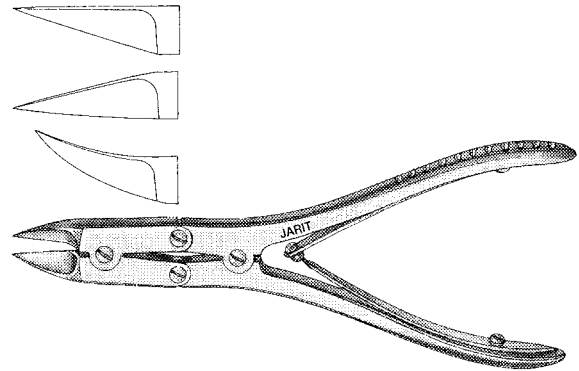

Ruskin-Liston Bone Cutting Forceps

22mm cutting jaws

Catalog #	Description
230-305	7 ¹ / ₄ " (185mm), straight
230-306	7 ¹ / ₄ " (185mm), up-angled

230-SPS-305 Replacement Spring and Screws

230-SPS-306 Replacement Spring and Screws

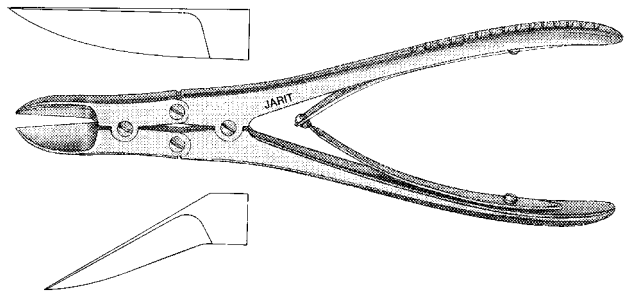

Ruskin-Liston Bone Splitting Forceps

14mm cutting jaw, narrow jaw

Catalog #	Description
230-310	7 ¹ / ₄ " (182mm), straight
230-311	7 ¹ / ₄ " (182mm), up-angled

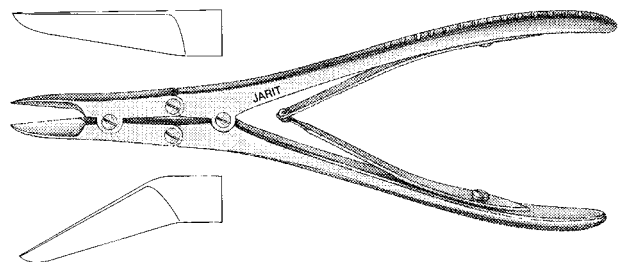

Littauer-Liston Bone Cutting Forceps

12mm cutting jaw

Catalog #	Description
230-315	6 ¹ / ₄ " (158mm), straight

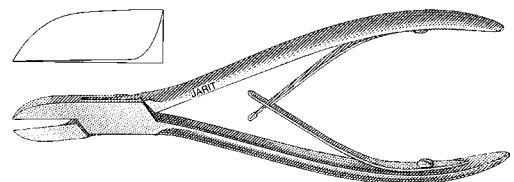

Stille-Liston Bone Cutting Forceps

Catalog #	Description
230-320	10 ³ / ₄ " (270mm), straight, 32.7mm cutting jaws
230-321	10 ³ / ₄ " (270mm), up-angled, 27.3mm cutting jaws

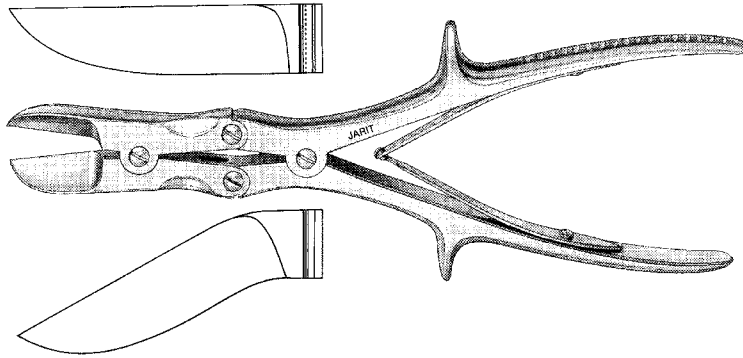

Stille-Horsley Rongeur

Catalog #	Description
230-325	9 ³ / ₄ " (250mm), S-shaped, 25mm cutting edge

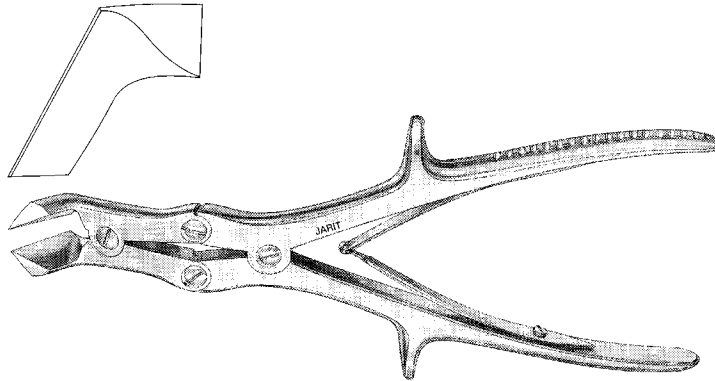

Liston Bone Cutting Forceps

Catalog #	Description
230-330	5 ³ / ₄ " (145mm), straight, 12mm cutting jaws
230-331	6 ¹ / ₂ " (167mm), straight, 16mm cutting jaws
230-332	7 ¹ / ₂ " (190mm), straight, 25mm cutting jaws
230-340	5 ³ / ₄ " (145mm), up-angled, 12mm cutting jaws
230-341	6 ¹ / ₂ " (167mm), up-angled, 16mm cutting jaws
230-342	7 ¹ / ₂ " (190mm), up-angled, 25mm cutting jaws

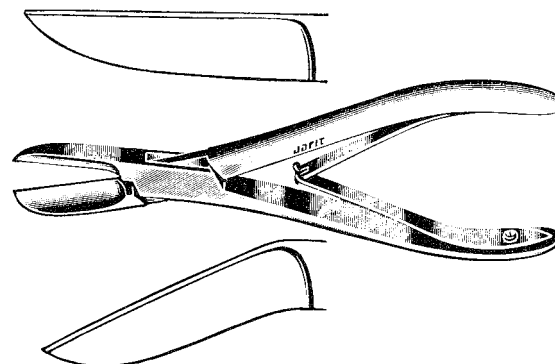

Bruns Oval Cup Currettes

7" (175mm), straight

Catalog #	Description
240-098	Size 5-0
240-099	Size 4-0
240-100	Size 3-0
240-101	Size 2-0
240-102	Size 0
240-103	Size 1
240-104	Size 2
240-105	Size 3
240-106	Size 4
240-107	Size 5
240-108	Size 6

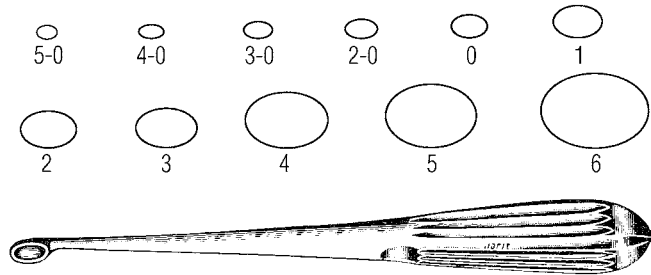

8" (203mm), straight

Catalog #	Description
240-070	Size 5-0
240-071	Size 4-0
240-072	Size 3-0
240-073	Size 2-0
240-074	Size 0
240-075	Size 1
240-076	Size 2
240-077	Size 3
240-078	Size 4
240-079	Size 5
240-080	Size 6

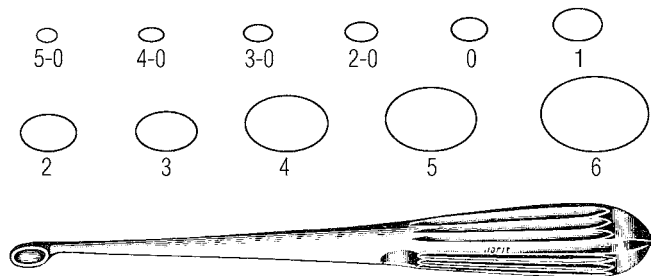

9" (230mm), straight

Catalog #	Description
240-118	Size 5-0
240-119	Size 4-0
240-120	Size 3-0
240-121	Size 2-0
240-122	Size 0
240-123	Size 1
240-124	Size 2
240-125	Size 3
240-126	Size 4
240-127	Size 5
240-128	Size 6

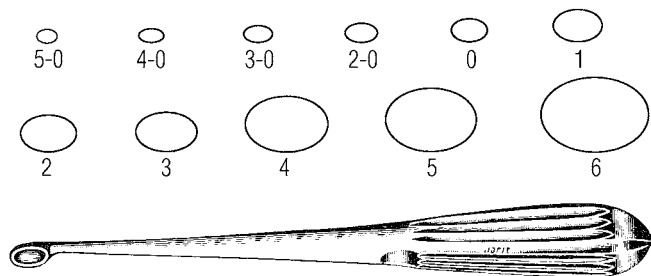

Bruns Oval Cup Curettes

8" (203mm), angled tip

Catalog #	Description
240-085	Size 5-0
240-086	Size 4-0
240-087	Size 3-0
240-088	Size 2-0
240-089	Size 0
240-090	Size 1
240-091	Size 2
240-092	Size 3
240-093	Size 4
240-094	Size 5
240-095	Size 6

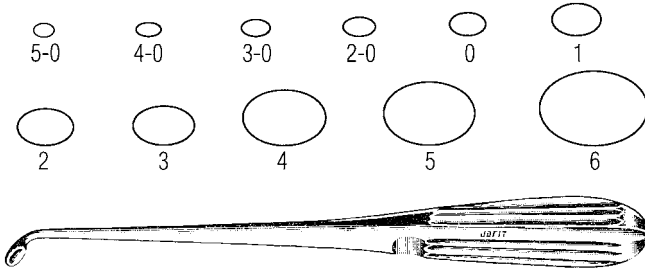

9" (230mm), angled

Catalog #	Description
240-138	Size 5-0
240-139	Size 4-0
240-140	Size 3-0
240-141	Size 2-0
240-142	Size 0
240-143	Size 1
240-144	Size 2
240-145	Size 3
240-146	Size 4
240-147	Size 5
240-148	Size 6

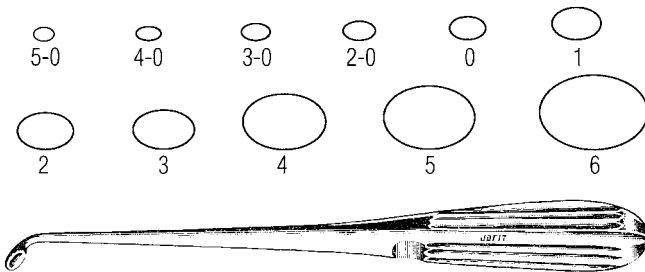

Spinal Fusion Curettes

9" (230mm), reverse angle

Catalog #	Description
240-149	Size 5-0
240-150	Size 4-0
240-151	Size 3-0
240-152	Size 2-0
240-153	Size 0
240-154	Size 1
240-155	Size 2
240-156	Size 3
240-157	Size 4
240-158	Size 5
240-159	Size 6

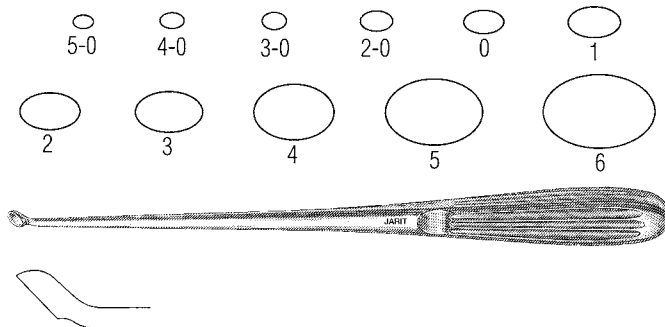

Bruns Oval Cup Currettes

straight, solid hexagonal handle

Catalog #	Description
240-160	9" (228mm), Size 3-0
240-161	9" (228mm), Size 2-0
240-162	9" (230mm), Size 0
240-163	9" (230mm), Size 1
240-164	9 1/4" (232mm), Size 2
240-165	9 1/4" (232mm), Size 3
240-166	9 1/4" (232mm), Size 4
240-167	9 1/4" (235mm), Size 5
240-168	9 1/4" (235mm), Size 6

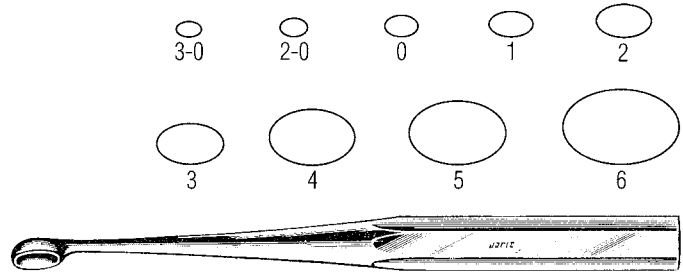

Semmes (Howard) Spinal Currettes

9" (228mm), 5 x 7 mm cup

Catalog #	Description
240-170	Straight
240-171	Slight Angle
240-172	Acute Angle

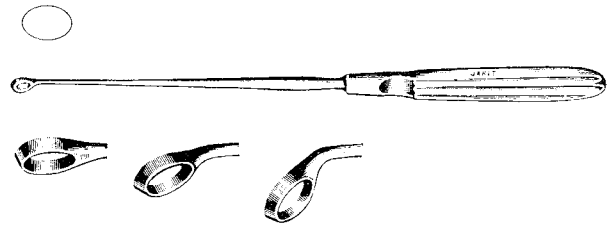

Cobb-Type Oval Cup Currettes

11" (280mm), hollow knurled handle, straight

Catalog #	Description
240-175	Size 3-0
240-176	Size 2-0
240-177	Size 0
240-178	Size 1
240-179	Size 2
240-180	Size 3
240-181	Size 4
240-182	Size 5
240-183	Size 6

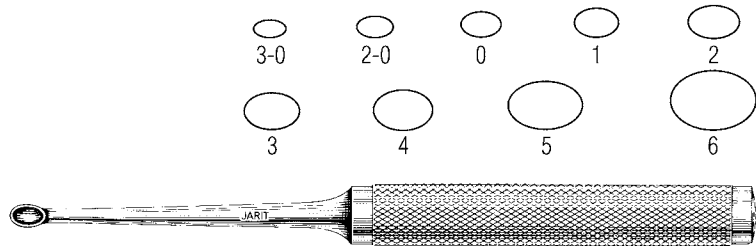

11" (280mm), hollow knurled handle, angled tip

Catalog #	Description
240-185	Size 3-0
240-186	Size 2-0
240-187	Size 0
240-188	Size 1
240-189	Size 2
240-190	Size 3
240-191	Size 4
240-192	Size 5
240-193	Size 6

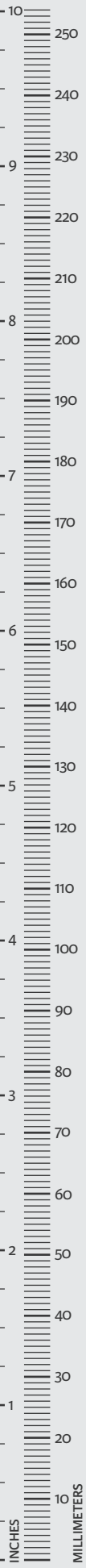
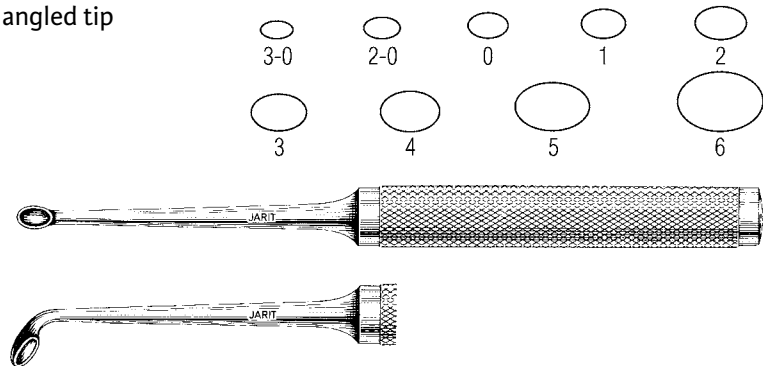

Bone Hook

Catalog #	Description
240-195	9" (230mm), 3/8" (9.5mm) hook
240-196	9" (230mm), 3/4" (19mm) hook
240-197	9" (230mm), 1" (25mm) hook

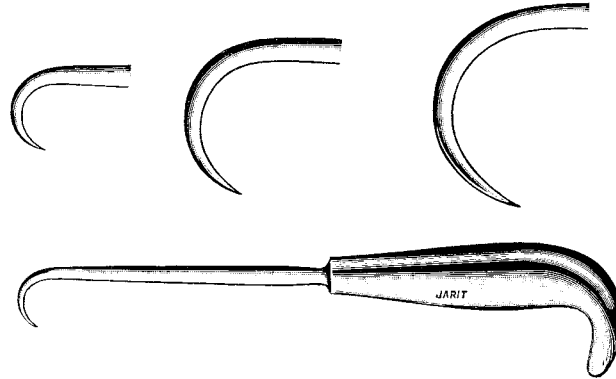

Boyes-Goodfellow Hooks

Catalog #	Description
240-198	8 1/4" (214mm), modified points



Volkman Bone Currettes

double ended

Catalog #	Description
240-200	5 1/4" (132mm), one round and one oval cup, 10.5mm and 63mm x 68mm
240-202	6 1/2" (167mm), two oval cups, 7.3mm x 13mm and 8.3mm x 22mm
240-203	6 1/2" (167mm), one round and one oval cup, 14mm and 7mm x 9mm
240-205	8" (201mm), one round and one oval cup, 17.5mm and 9mm x 11mm

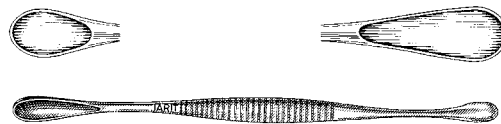

Scoville Disc Currettes

4 x 10mm cup

Catalog #	Description
240-207	10" (254mm), straight
240-208	10" (254mm), reverse angled
240-209	10" (254mm), angled

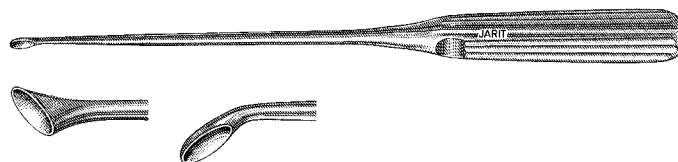

Cone Ring Currettes

Catalog #	Description
240-210	9" (229mm), straight, size 1, 8mm diameter
240-211	9" (229mm), straight, size 2, 6mm diameter
240-212	9" (229mm), straight, size 3, 3mm diameter
240-214	9" (229mm), angular, size 1, 8mm diameter
240-215	9" (229mm), angular, size 2, 6mm diameter
240-216	9" (229mm), angular, size 3, 3mm diameter

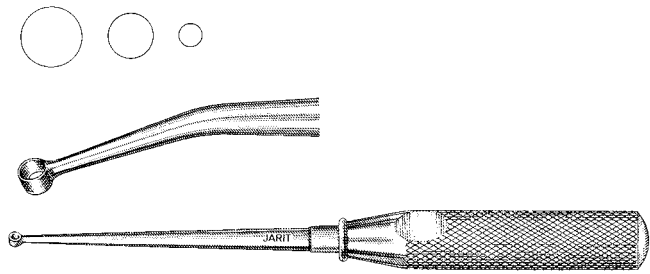

Cone Ring Currettes

8mm cup

Catalog #	Description
240-220	9" (229mm), 5° angle
240-221	9" (229mm), 30° angle

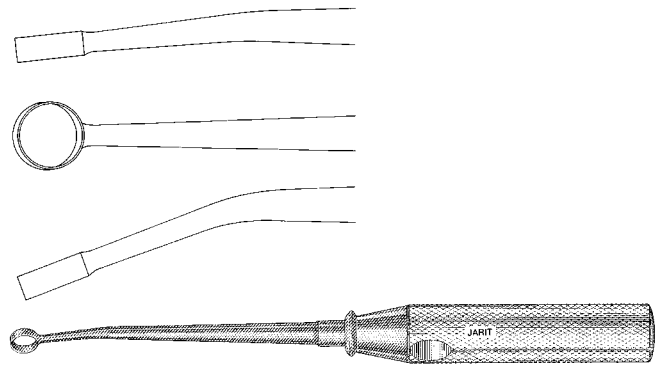

Epstein Spinal Fusion Currettes

reverse angle

Catalog #	Description
240-230	7¾" (200mm), size 3-0
240-231	7¾" (200mm), size 2-0
240-232	7¾" (200mm), size 0

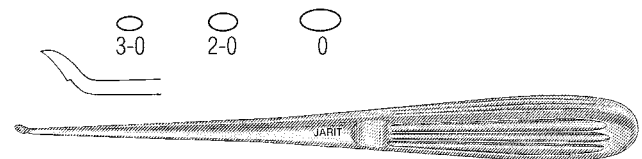

Lambotte Osteotome Rack

Catalog #	Description
250-090	Stainless steel, holds 12 Jarit Lambotte 9" osteotomes, rack size: 3" x 7 ³ / ₈ " x 11 ¹ / ₈ " (76mm x 187mm x 283mm)

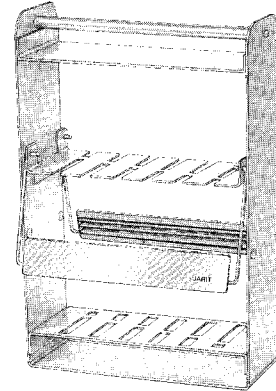

Hibbs-Bruns Curette Rack

Catalog #	Description
250-092	Stainless steel, holds 12 Jarit 6 ³ / ₄ ", 8" and 9" Bruns, curettes, rack size: 2 ¹ / ₂ " x 7 ³ / ₈ " x 11 ¹ / ₈ " (64mm x 187mm x 283mm)

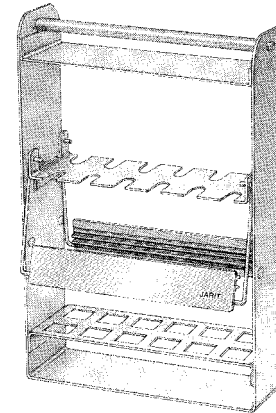

Hibbs-Bruns Curette Rack

Catalog #	Description
250-084	Stainless steel, holds 12 Jarit 6 ³ / ₄ ", 8" and 9" Bruns, curettes, rack size: 2 ¹ / ₂ " x 9" x 12 ¹ / ₂ " (64mm x 231mm x 305mm)



Bruns Curette Rack

Catalog #	Description
250-093	Stainless steel, holds 12 Jarit Bruns 6 ³ / ₄ " curettes, rack size: 2 ¹ / ₂ " x 7 ³ / ₈ " x 9 ¹ / ₄ " (64mm x 187mm x 235mm)

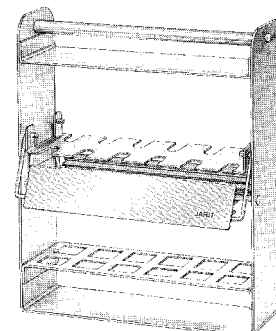

Smith-Petersen Osteotome Rack

Catalog #	Description
250-095	Stainless steel, holds 7 Jarit Smith-Petersen 8" gouges, osteotomes, rack size: 2" x 10 ⁵ / ₈ " x 9 ⁷ / ₈ " (51mm x 270mm x 251mm)

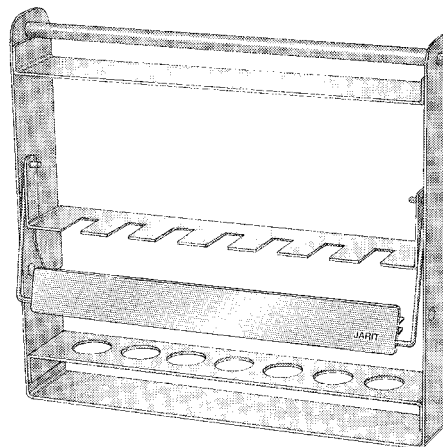

Cobb Type Instrument Rack

Catalog #	Description
250-097	Stainless steel, holds 9 Jarit Cobb-type 11" instruments, rack size: 1 ³ / ₄ " x 14" x 13 ¹ / ₄ " (44mm x 356mm x 337mm)

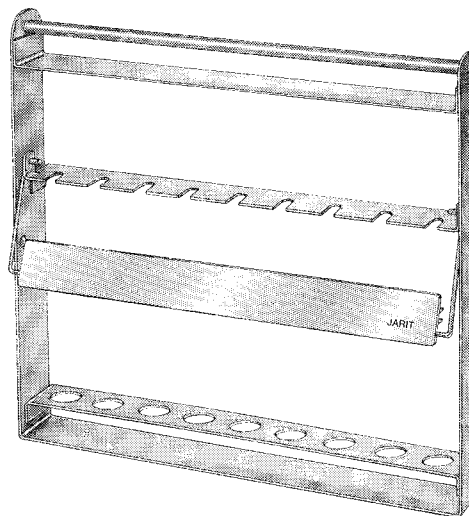

Hoke Osteotome Rack

Catalog #	Description
250-099	Stainless steel, holds 6 Jarit Hoke 5" osteotomes, rack size: 1 ¹ / ₂ " x 5 ³ / ₄ " x 7" (38mm x 146mm x 178mm)

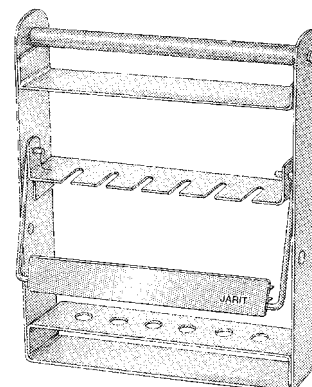

Hibbs Chisels

9³/₄" (245mm), straight

Catalog #	Description
250-100	1/4" (6mm)
250-101	3/8" (9mm)
250-102	1/2" (12mm)
250-103	5/8" (16mm)
250-104	3/4" (19mm)
250-105	7/8" (22mm)
250-106	1" (25mm)
250-107	1 1/8" (29mm)
250-108	1 1/4" (32mm)
250-109	1 1/2" (38mm)



Hibbs Chisels

9³/₄" (245mm), curved

Catalog #	Description
250-120	1/4" (6mm)
250-121	3/8" (9mm)
250-122	1/2" (12mm)
250-123	5/8" (16mm)
250-124	3/4" (19mm)
250-125	7/8" (22mm)
250-126	1" (25mm)
250-127	1 1/8" (29mm)
250-128	1 1/4" (32mm)
250-129	1 1/2" (38mm)



Hibbs Osteotomes

9 1/2" (241mm), straight

Catalog #	Description
250-140	1/4" (6mm)
250-141	3/8" (9mm)
250-142	1/2" (12mm)
250-143	5/8" (16mm)
250-144	3/4" (19mm)
250-145	7/8" (22mm)
250-146	1" (25mm)
250-147	1 1/8" (29mm)
250-148	1 1/4" (32mm)
250-149	1 1/2" (38mm)



Hibbs Osteotomes

9½" (241mm), curved

Catalog #	Description
250-160	¼" (6mm)
250-161	⅜" (9mm)
250-162	½" (12mm)
250-163	⅝" (16mm)
250-164	¾" (19mm)
250-165	⅞" (22mm)
250-166	1" (25mm)
250-167	1⅛" (29mm)
250-168	1¼" (32mm)
250-169	1½" (38mm)



Hibbs Gouges

9½" (241mm), straight

Catalog #	Description
250-180	¼" (6mm)
250-181	⅜" (9mm)
250-182	½" (12mm)
250-183	⅝" (16mm)
250-184	¾" (19mm)
250-185	⅞" (22mm)
250-186	1" (25mm)
250-187	1⅛" (29mm)
250-188	1¼" (32mm)
250-189	1½" (38mm)



Hibbs Gouges

9½" (241mm), curved

Catalog #	Description
250-190	¼" (6mm)
250-191	⅜" (9mm)
250-192	½" (12mm)
250-193	⅝" (16mm)
250-194	¾" (19mm)
250-195	⅞" (22mm)
250-196	1" (25mm)
250-197	1⅛" (29mm)
250-198	1¼" (32mm)
250-199	1½" (38mm)



Smith-Petersen Osteotomes

8" (203mm), straight

Catalog #	Description
250-200	1/4" (6mm)
250-201	3/8" (9mm)
250-202	1/2" (12mm)
250-203	5/8" (16mm)
250-204	3/4" (19mm)
250-205	1" (25mm)
250-206	1 1/4" (32mm)

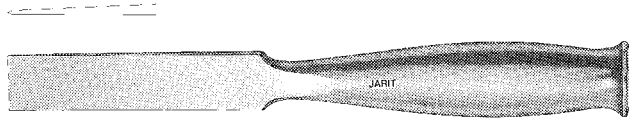

Smith-Petersen Osteotomes

8" (201mm), curved

Catalog #	Description
250-210	1/4" (6mm)
250-211	3/8" (9mm)
250-212	1/2" (12mm)
250-213	5/8" (16mm)
250-214	3/4" (19mm)
250-215	1" (25mm)
250-216	1 1/4" (32mm)

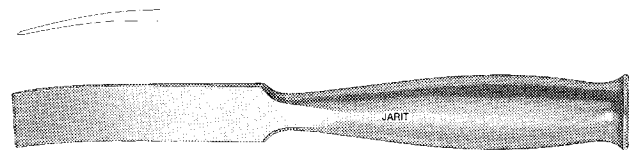

Smith-Petersen Gouges

8" (201mm), straight

Catalog #	Description
250-220	1/4" (6mm)
250-221	3/8" (9mm)
250-222	1/2" (12mm)
250-223	5/8" (16mm)
250-224	3/4" (19mm)
250-225	1" (25mm)
250-226	1 1/4" (32mm)

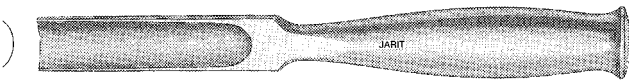

Smith-Petersen Gouges

8" (201mm), curved

Catalog #	Description
250-230	1/4" (6mm)
250-231	3/8" (9mm)
250-232	1/2" (12mm)
250-233	5/8" (16mm)
250-234	3/4" (19mm)
250-235	1" (25mm)
250-236	1 1/4" (32mm)

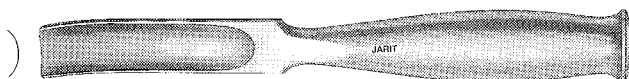

Cobb-Type Spinal Gouges

11" (280mm), round knurled handle,
9/32" (7.5mm) wide

Catalog #	Description
250-240	Straight
250-241	Medium curved
250-242	Strong curved
250-243	Reverse curved

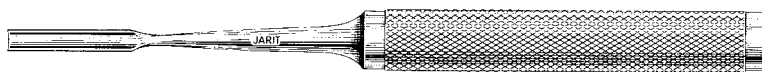
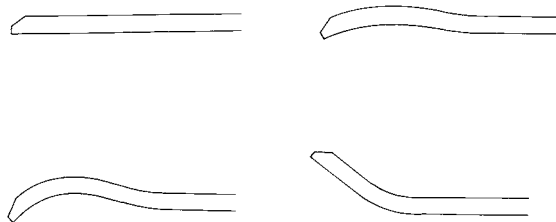

Cobb-Type Spinal Gouges

9 1/4" (235mm), solid hexagonal handle,
5/16" (8mm) wide

Catalog #	Description
251-240	Straight
251-241	Medium curved
251-242	Strong curved
251-243	Reverse curved

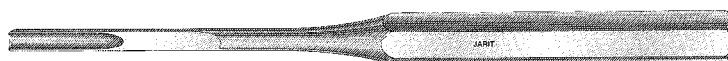
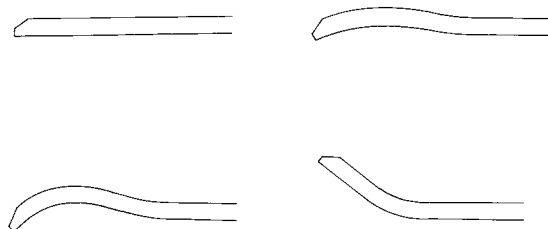

Cobb-Type Spinal Elevators

round knurled handle

Catalog #	Description
250-244	11" (280mm), 3/8" (9mm) blade
250-245	11" (280mm), 1/2" (12mm) blade
250-246	11" (280mm), 3/4" (19mm) blade
250-247	11" (280mm), 1" (25mm) blade
250-248	11" (280mm), 1 1/4" (32mm) blade

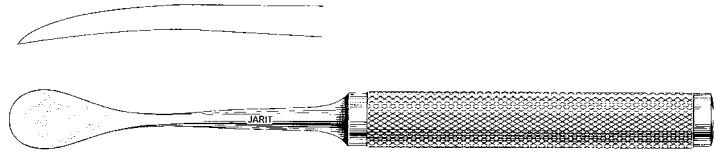

Cobb-Type Spinal Elevators

solid hexagonal handle

Catalog #	Description
251-244	9 1/2" (240mm), 3/8" (9mm) blade
251-245	9 1/2" (240mm), 1/2" (12.5mm) blade
251-246	9 1/2" (240mm), 3/4" (19mm) blade

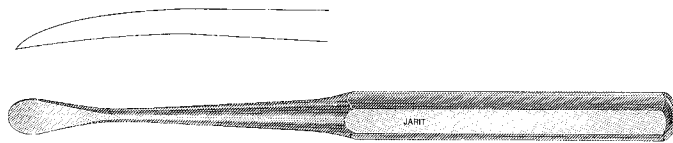

Lambotte Osteotomes

9" (229mm), straight

Catalog #	Description
250-250	1/4" (6mm)
250-251	1/2" (12mm)
250-252	3/4" (19mm)
250-253	1" (25mm)
250-254	1 1/4" (32mm)
250-255	1 1/2" (38mm)

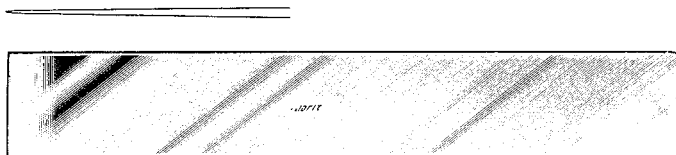

Lambotte Osteotomes

9" (229mm), curved

Catalog #	Description
250-260	1/4" (6mm)
250-261	1/2" (12mm)
250-262	3/4" (19mm)
250-263	1" (25mm)
250-264	1 1/4" (32mm)
250-265	1 1/2" (38mm)

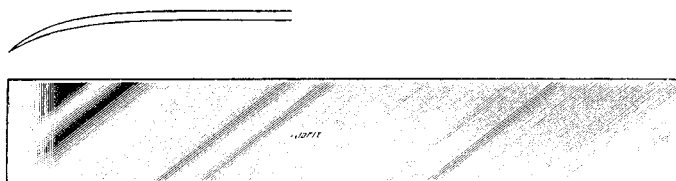

Hoke Osteotomes

5 1/2" (140mm), straight

Catalog #	Description
250-280	1/8" (3mm)
250-281	3/16" (5mm)
250-282	1/4" (6mm)
250-283	5/16" (8mm)
250-284	3/8" (9mm)
250-285	1/2" (12mm)
250-286	5/8" (16mm)

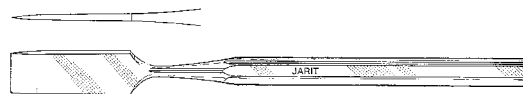

Hoke Osteotomes

5 1/2" (140mm), curved

Catalog #	Description
250-290	1/8" (3mm)
250-291	3/16" (5mm)
250-292	1/4" (6mm)
250-293	5/16" (8mm)
250-294	3/8" (9mm)
250-295	1/2" (12mm)
250-296	5/8" (16mm)

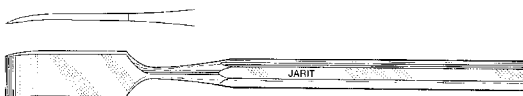

Bone Awl

Catalog #	Description
275-563	5¾" (146mm)

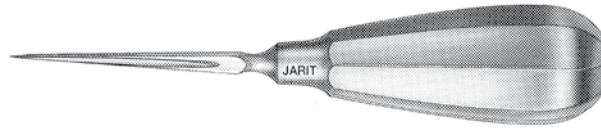

Stille-Type Osteotomes

Catalog #	Description
250-320	8" (204mm), ⅜" (10mm)
250-321	8" (204mm), 9/16" (14mm)
250-322	8" (204mm), 11/16" (18mm)
250-323	8" (204mm), 7/8" (22mm)

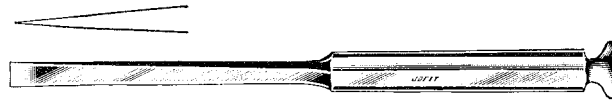

Stille-Type Gouges

Catalog #	Description
250-330	7¾" (200mm), ⅜" (10mm)
250-331	7¾" (200mm), 9/16" (14mm)
250-332	7¾" (200mm), 11/16" (18mm)
250-333	7¾" (200mm), 7/8" (22mm)



Stille-Type Chisels

Catalog #	Description
250-335	8" (204mm), ⅜" (10mm)
250-336	8" (204mm), 9/16" (14mm)
250-337	8" (204mm), 11/16" (18mm)
250-338	8" (204mm), 7/8" (22mm)

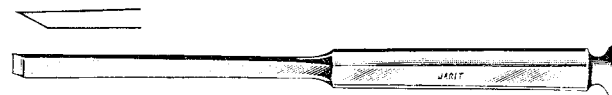

Lambotte Mini Osteotome Set

Catalog #	Description
250-390	Includes: 7 straight osteotomes, 5" (127mm) long, 2mm, 4mm, 6mm, 8mm, 10mm, 12mm, 14mm wide, nylon capped mallet in canvas roll
250-CVB-390	Canvas Bag

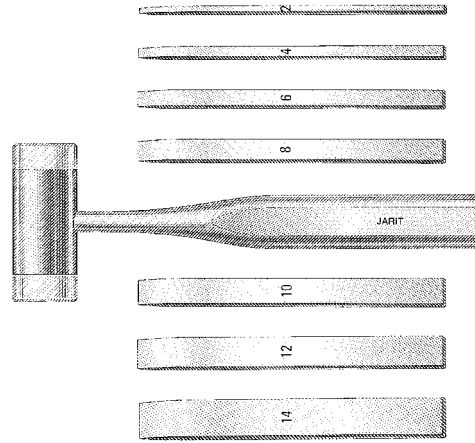

Lambotte Mini Osteotome Rack (Metal)

Catalog #	Description
250-380	5 1/2" x 6 1/2" x 1/2" (140mm x 165mm x 13mm), holds up to 9 assorted mini osteotomes 2mm to 20mm



Lambotte Mini Osteotomes

5" (127mm), curved

Catalog #	Description
250-381	1/16" (2mm)
250-382	5/32" (4mm)
250-383	1/4" (6mm)
250-384	5/16" (8mm)
250-385	3/8" (10mm)
250-386	1/2" (12mm)
250-387	9/16" (14mm)

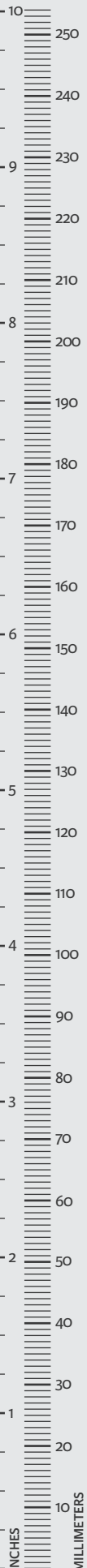
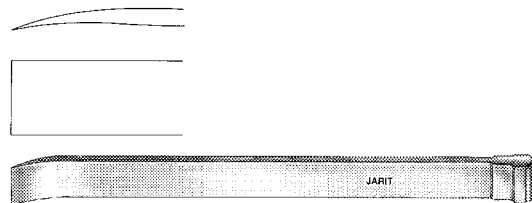

Lambotte Mini Osteotomes

5" (127mm), straight

Catalog #	Description
250-391	1/16" (2mm)
250-392	5/32" (4mm)
250-393	1/4" (6mm)
250-394	5/16" (8mm)
250-395	3/8" (10mm)
250-396	1/2" (12mm)
250-397	9/16" (14mm)

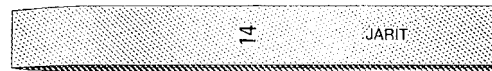

Mallet w/Nylon Head

7 1/4" (187mm), anodized aluminum handle

Catalog #	Description
250-398	2 replaceable nylon caps, head: weight 4 oz., diameter 1" (25mm)
250-399	1 replaceable nylon cap and 1 stainless facing, head: weight 5 oz., diameter 1" (25mm)
250-410	Nylon cap for 250-398 and 250-399

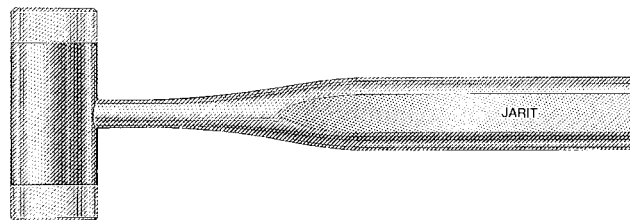

Kirk Mallet

Catalog #	Description
250-400	7¾" (197mm) bronze head, head: weight 1 lb. 2 oz., diameter 1⅝" (41mm)

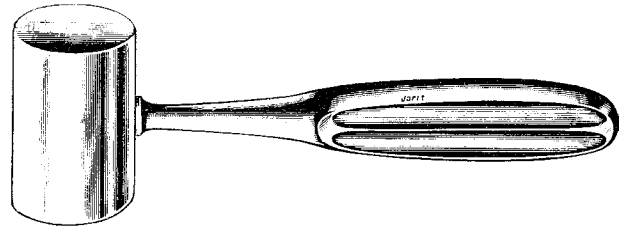

Orthopedic Mallet

Catalog #	Description
250-403	7¼" (183mm), head: weight 1 lb., diameter 1¼" (30mm)
250-404	7½" (193mm), head: weight 2 lbs., diameter 1½" (38mm)

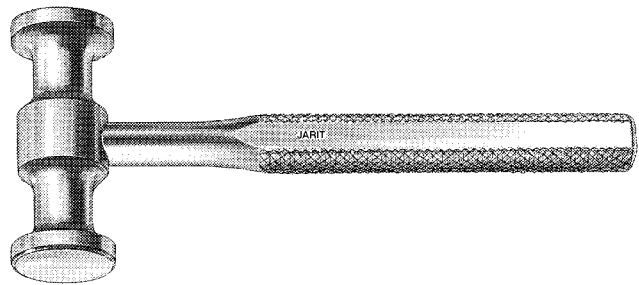

Bone Mallet

Catalog #	Description
250-405	11" (280mm), lightweight, head: weight 1 lb., diameter 1⅜" (35mm)

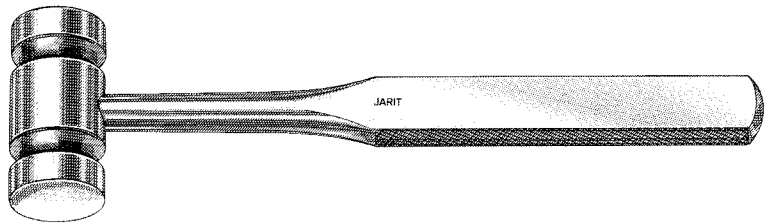

Bone Mallet

Catalog #	Description
250-406	11" (280mm), heavyweight, head: weight 2 lbs., diameter 2" (50mm)

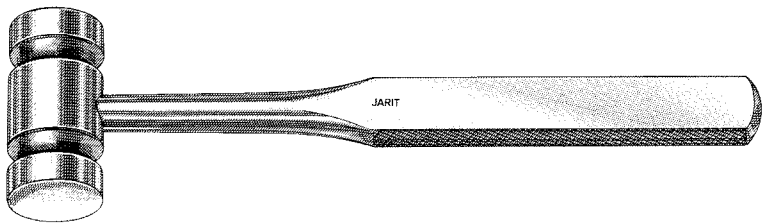

Lucae Mallet

Catalog #	Description
250-408	7¾" (200mm), head: weight 5 oz., diameter 1" (25mm)

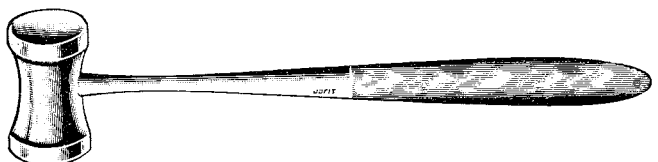

Cloward Style Ball Pean Hammer

Catalog #	Description
250-411	7½" (192mm), head: weight 8 oz., small face diameter 11/16" (11mm), large face diameter ¾" (20mm)
250-412	9¼" (232mm), head: weight 13 oz., small face diameter 7/8" (22mm), large face diameter 1" (25mm)

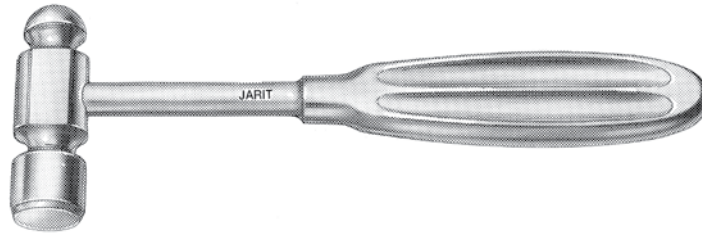

Mead Mallet

Catalog #	Description
250-415	7½" (190mm), 2 replaceable nylon caps, head: weight 6 oz., diameter 13/16" (20mm)
250-416	Nylon cap for 250-415
250-CLR-415	Replacement Collar

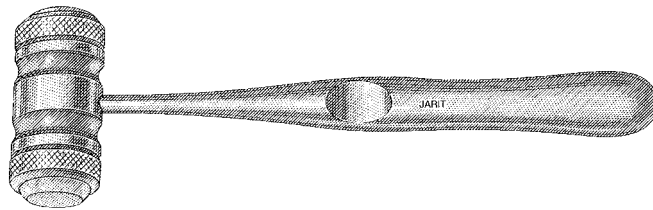

Kiene Bone Tamp

Catalog #	Description
250-418	6" (152mm), tip 10mm diameter

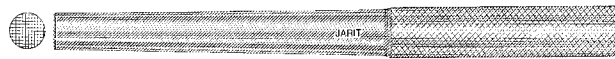

Bone Tamp

with serrated tips

Catalog #	Description
250-430	6¼" (160mm), tip 2mm diameter
250-431	6¼" (160mm), tip 3mm diameter
250-432	6¼" (160mm), tip 4mm diameter
250-433	6¼" (160mm), tip 5mm diameter
250-434	6¼" (160mm), tip 6mm diameter
250-435	6¼" (160mm), tip 8mm diameter
250-436	6¼" (160mm), tip 10mm d

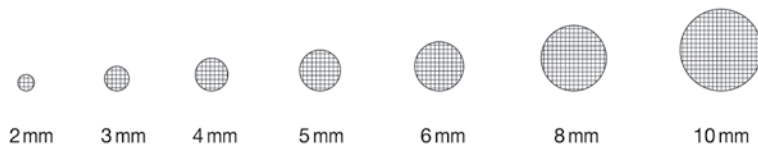

Key Elevators

solid hexagonal handle

Catalog #	Description
250-420	6¾" (172mm), ⅛" (3mm) wide
250-421	7" (176mm), ¼" (6mm) wide
250-422	7½" (188mm), ⅜" (9mm) wide
250-423	7½" (188mm), ½" (13mm) wide
250-424	7¾" (200mm), ⅝" (16mm) wide
250-425	7¾" (200mm), ¾" (19mm) wide
250-426	8½" (216mm), 1" (25mm) wide

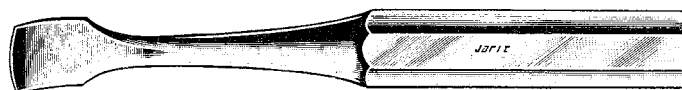

Crego Elevators

Catalog #	Description
250-470	8" (203mm), 7mm wide, 1⅝" inside radius
250-471	8" (203mm), 7.2mm wide, 1⅞" inside radius
250-472	8" (203mm), 13.5mm wide, 1⅞" inside radius

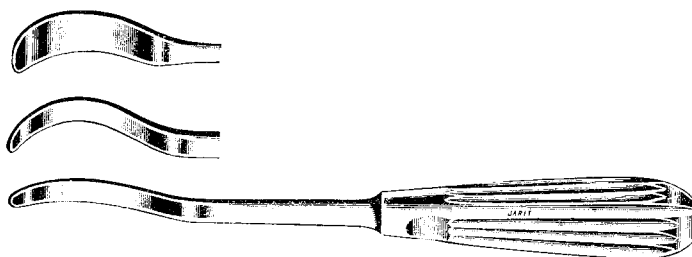

Chandler Elevators

Catalog #	Description
250-480	7¼" (182mm), maximum blade width 13mm
250-481	8" (203mm), maximum blade width 20mm
250-482	9¼" (232mm), maximum blade width 25mm
250-483	10" (254mm), maximum blade width 31mm

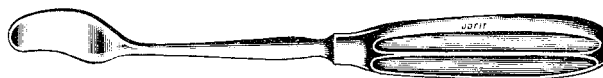

Langenbeck Elevator

Catalog #	Description
250-490	8¼" (210mm), blade 6.5mm wide

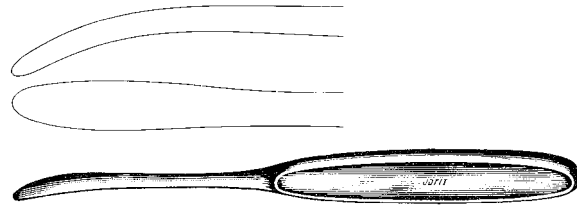

Langenbeck Elevator

Catalog #	Description
250-492	7¾" (198mm), blade 17.5mm wide

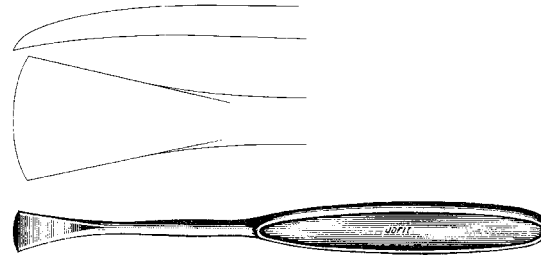

Lane Elevator

Catalog #	Description
250-495	7¾" (195mm), blade 7mm wide

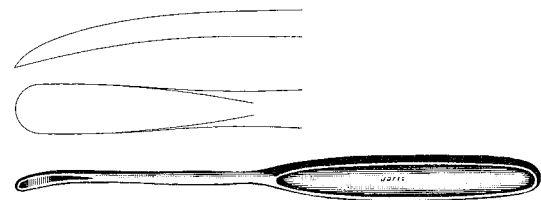

Lane Elevator

Catalog #	Description
250-496	7¾" (195mm), blade 10mm wide

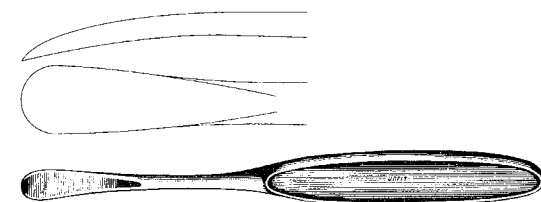

Sayre Elevator

Catalog #	Description
250-500	6¾" (171mm), double ended, sharp, blade 9.5mm wide



Sayre Elevator

Catalog #	Description
250-502	6¾" (171mm), double ended, blunt, blade 9.5mm wide



McGlamry Elevators

Catalog #	Description
250-503	6½" (168mm), sharp, 11mm wide
250-504	6½" (168mm), sharp, 13mm wide
250-505	6½" (168mm), sharp, 15mm wide
250-506	6½" (168mm), sharp, 17mm wide

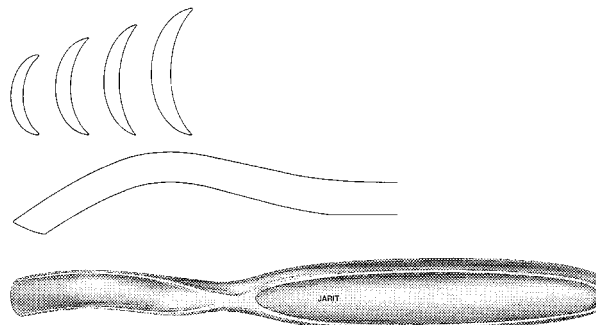

Seldin Periosteal Elevator #23

Catalog #	Description
250-509	7¾" (200mm), double ended, blades ½" x 2½" (13mm x 55mm) and ¾" x 2" (10mm x 51mm)



Sedillot Elevator

Catalog #	Description
250-510	7½" (190mm), blade 18mm wide



Mathieu Raspatory

Catalog #	Description
255-100	6¼" (160mm), straight blade 11.7mm wide

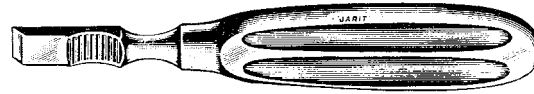

Farabeuf Raspatory

Catalog #	Description
255-110	5⅞" (150mm), straight blade 12.8mm wide



Farabeuf Raspatory

Catalog #	Description
255-111	5⅞" (150mm), curved blade 12.8mm wide



Farabeuf Raspatory

Catalog #	Description
255-112	7½" (190mm), double ended, straight and curved blades 13mm wide



Gigli Wire Saw Blades

Stille-type, package of 10

Catalog #	Description
260-104	12" (305mm)
260-105	16" (406mm)
260-106	20" (505mm)

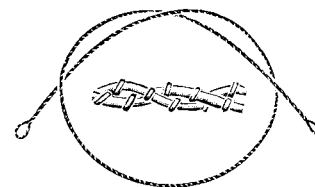

Gigli Saw Handles

Catalog #	Description
260-109	loop style, pair

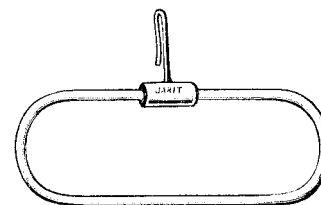

Gigli Saw Handles

Catalog #	Description
260-110	solid, pair

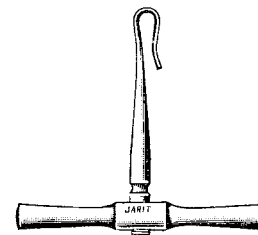

Bailey Gigli Saw Guide

Catalog #	Description
260-112	13" (330mm)

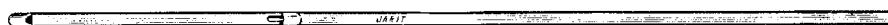

Satterlee Saw

Catalog #	Description
260-120	11½" (290mm)
260-121	Replacement blade 8½" (213mm)
260-HDL-120	Replacement Handle only

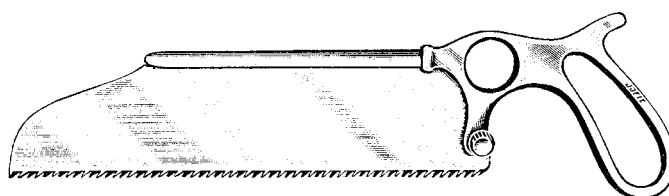

Langenbeck Metacarpal Saw

Catalog #	Description
260-135	9¼" (235mm), blade 5⅛" (130mm)



Sweet Amputation Retractor

Catalog #	Description
260-160	11¾" (296mm) wide, neck 4½" (115mm) deep, 1⅝" (41.5mm) tapered

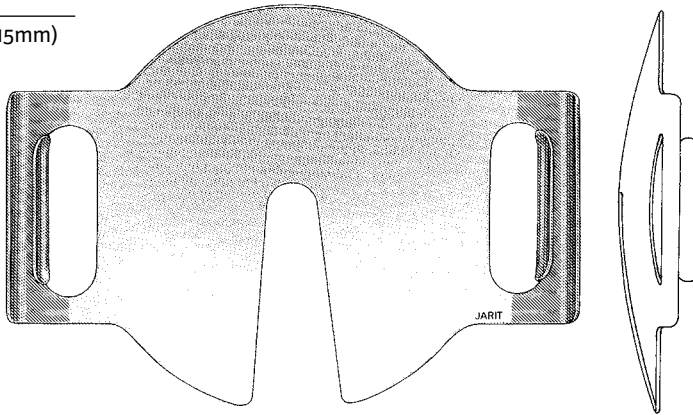

Putti Rasps

double ended

Catalog #	Description
260-200	11¾" (300mm), one round blade and one half round blade
260-201	10¾" (270mm), flat blades, one blade curved up and one blade curved sideways

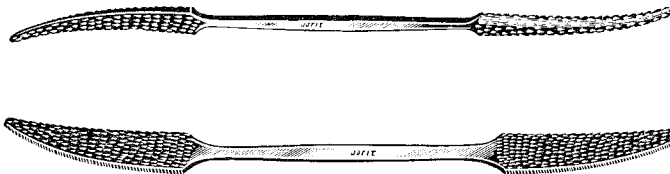

Miller Rasp

Catalog #	Description
260-205	7" (180mm), double ended, 5.3mm x 6.3mm wide serrated tips

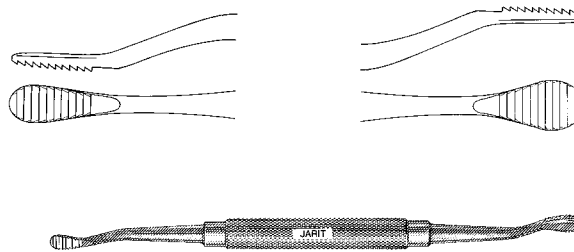

Bone File

Catalog #	Description
260-210	9¾" (245mm), half round blade, ⅝" wide x ¾" length (15mm x 95mm)



Smillie Meniscus Knives

Catalog #	Description
270-120	6¾" (171mm), straight edge
270-121	6¾" (171mm), left
270-122	6¾" (171mm), right

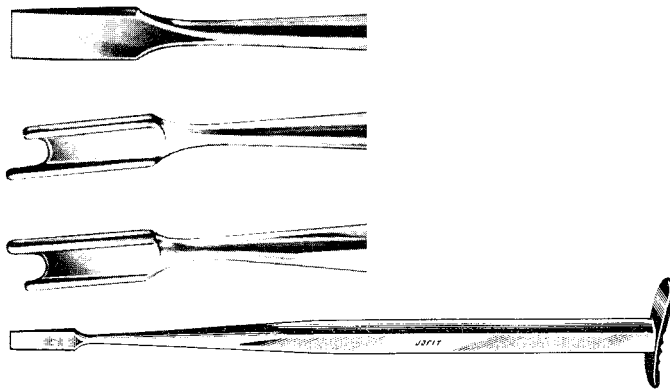

Martin Cartilage Scissors

Catalog #	Description
270-150	7¾" (200mm), curved, 50mm serrated blade

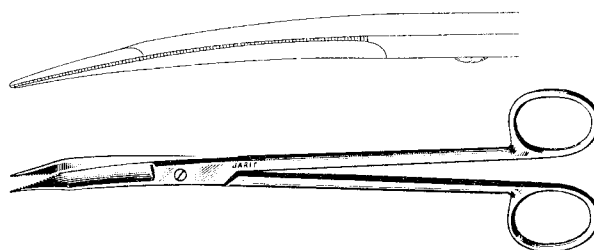

Martin Cartilage Clamp

Catalog #	Description
270-157	7¼" (187mm), straight, ⅛" wide x ⅞" length (3.5mm x 22mm) jaws

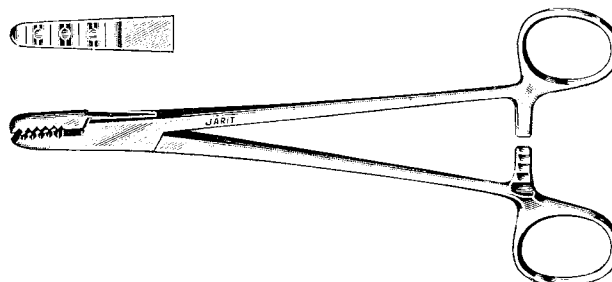

Walton Meniscus Clamp

Catalog #	Description
270-165	7" (180mm), straight, 1/4" wide x 7/8" length (5.7mm x 22mm) jaws

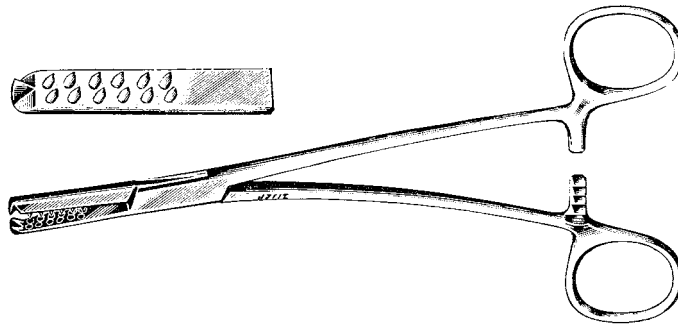

Walton Cartilage Clamp angled on the flat

Catalog #	Description
270-170	8" (205mm), angled jaws, 1/4" wide x 3/4" length (6.6mm x 20mm) jaws

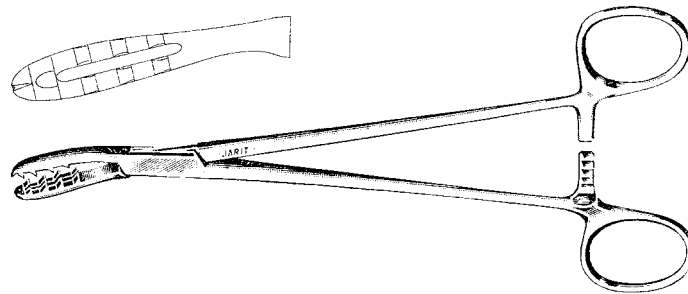

Dingman Cartilage Clamps angled on the side

Catalog #	Description
270-175	7 1/4" (186mm), straight jaws, delicate, 3/16" wide x 1/2" length (4mm x 37mm) jaws
270-176	7 1/4" (186mm), straight jaws, heavy, 3/16" wide x 1/2" length (5mm x 37mm) jaws

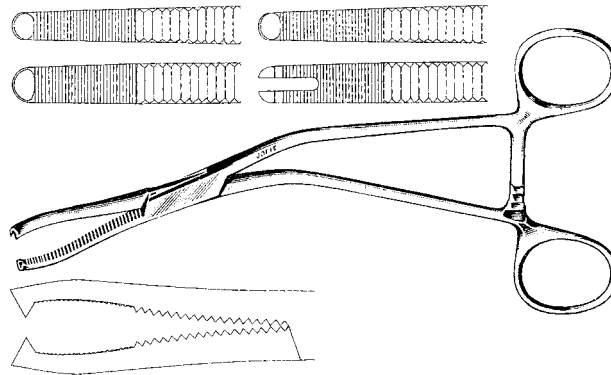

Preston Ligamentum Flavum Forceps

Catalog #	Description
270-180	7 1/4" (185mm)

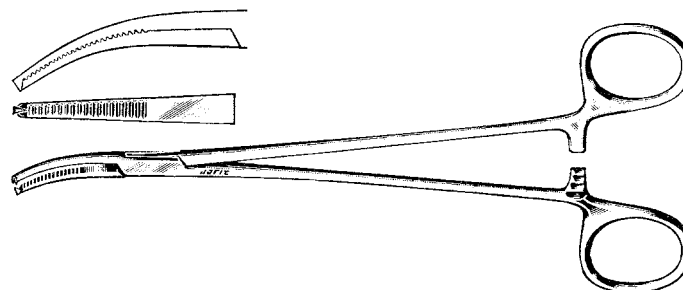

Locke Phalangeal Forceps

Catalog #	Description
270-182	6¼" (156mm), 22mm serrated jaws, 1 x 2 teeth

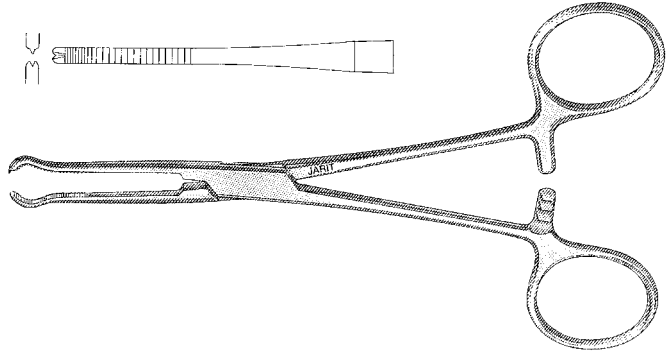

Sesamoidectomy Clamp

Catalog #	Description
270-183	6½" (167mm), curved

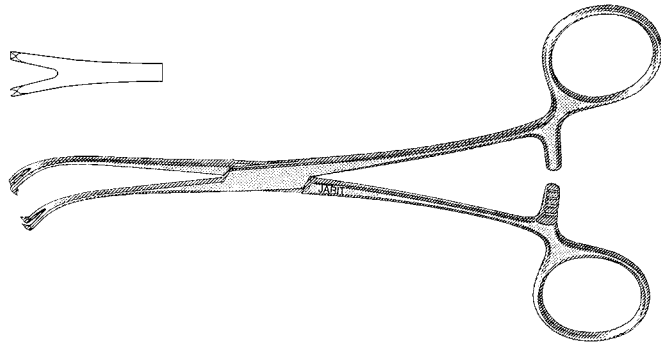

Carroll Tendon Retriever

Catalog #	Description
270-185	5½" (140mm), curved shaft, 2mm x 8mm serrated jaws, alligator action

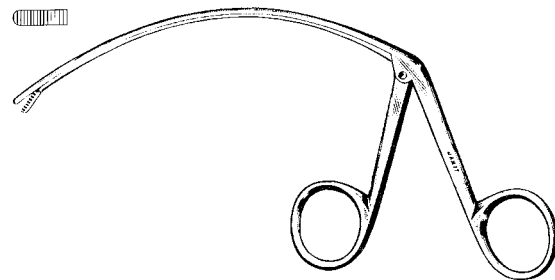

Carroll Small Bone Holding Clamp

Catalog #	Description
270-186	6½" (164mm), serrated jaws

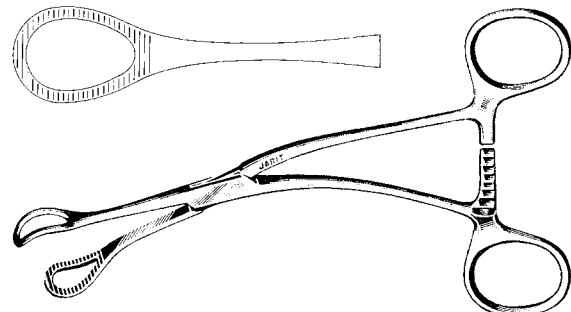

Brand Tendon Pulling Forceps

2 x 3 teeth

Catalog #	Description
270-187	6" (155mm), 1/8" wide x 5/8" length (3.4mm x 15mm) jaws
270-188	7 1/2" (190mm), 1/8" wide x 7/8" length (3.5mm x 22mm) jaws
270-189	9 3/4" (245mm), 1/8" wide x 7/8" length (3.5mm x 22mm) jaws

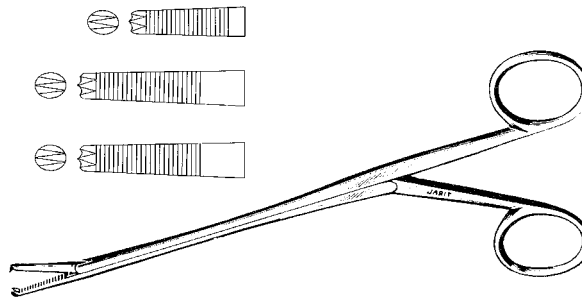

Tendon Braiding Forceps

Catalog #	Description
270-195	6" (152mm), 8mm pointed tip, straight
270-196	6" (152mm), 8mm pointed tip, curved

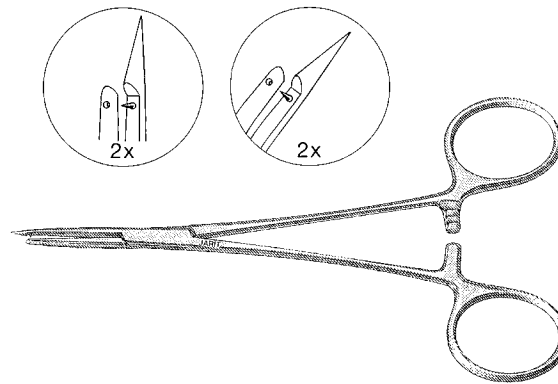

Bunnell Tendon Passers and Forwarding Probes

Catalog #	Description
270-197	7 1/4" (185mm)
270-198	9" (230mm)



Kleinert-Kutz Tendon Retriever

Catalog #	Description
270-200	8 1/2" (215mm), 1.5mm wide x 8mm length, serrated, 1 x 2 teeth

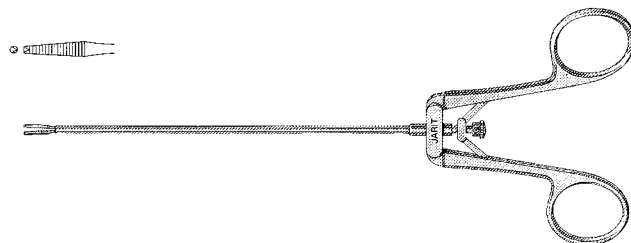

Finger Goniometer

Catalog #	Description
270-225	5 1/2" (140mm)



Nail Splitters

with solid octagon handles

Catalog #	Description
840-100	5" (127mm), straight 2mm
840-110	5" (127mm), angled 2mm
840-120	5" (127mm), straight 3.5mm
840-130	5" (127mm), angled 3.5mm

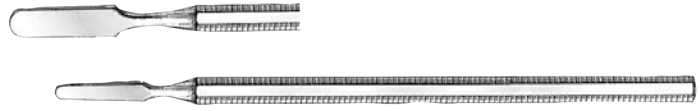

Hand Gouge

with solid octagon handles

Catalog #	Description
840-140	5" (127mm), round tip, 2.5mm

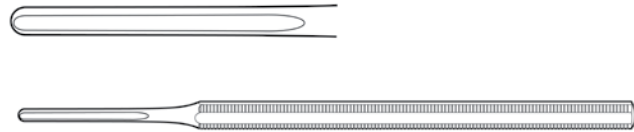

Curette Excavators

with solid octagon handles, single end without holes

Catalog #	Description
840-200	5" (127mm), 1mm
840-205	5" (127mm), 1.5mm
840-210	5" (127mm), 2mm
840-215	5" (127mm), 2.5mm



Curette Excavators

with solid octagon handles, double ended with holes

Catalog #	Description
840-220	5½" (140mm), 1.5mm x 2mm



Williger Bone Curette

double ended

Catalog #	Description
840-225	5½" (140mm), 3mm and 4mm wide oval cups



Martini Bone Curette

double ended

Catalog #	Description
840-230	5½" (140mm), 4mm and 5mm dia round cups



Locke Elevator

with solid octagon handles

Catalog #	Description
840-300	Small blade, 5" (127mm), 3mm wide x 15mm length
840-305	Large blade, 5½" (140mm), 5mm wide x 20mm length



Nail or Bone Rasp

with solid octagon handle

Catalog #	Description
840-310	6¾" (172mm), double ended, 1 end inside and 1 end outside for better conformity



Ingrown Nail Cutter

with solid octagon handle

Catalog #	Description
840-315	5" (127mm), sharp hook edge



Probe and Packer

with solid octagon handle

Catalog #	Description
840-320	6" (152mm), double ended, blunt probe and 2mm x 25mm packer



Platypus Nail Pulling Forceps

stainless

Catalog #	Description
840-325	5 1/2" (140mm), standard wide jaws
840-330	5 1/2" (140mm), narrow jaws

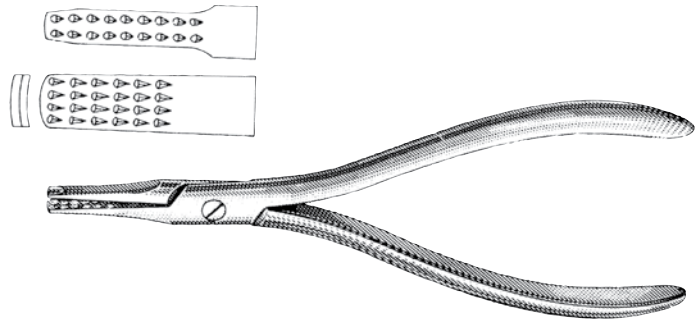

Ingrown Nail Splitting Scissors

stainless

Catalog #	Description
840-335	6" (152mm), one blade serrated

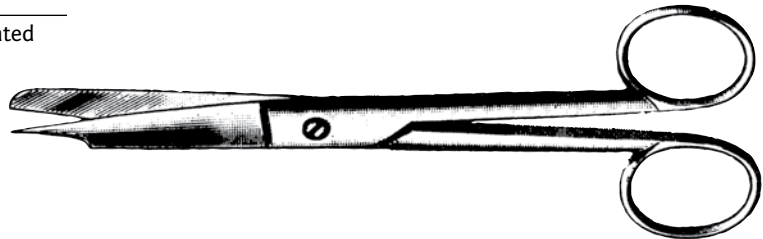

Tissue and Cuticle Nipper

stainless

Catalog #	Description
840-340	4" (102mm), 5mm long convex blades

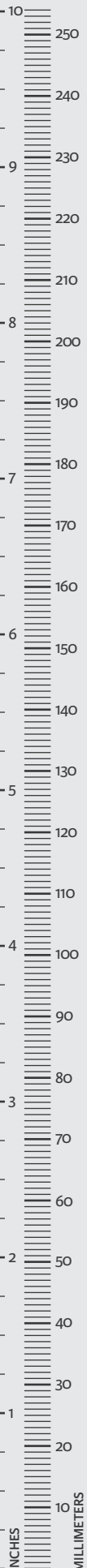
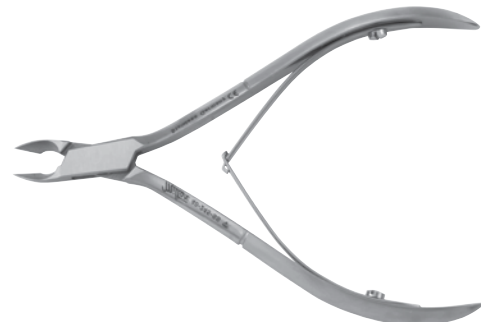

Tissue Nipper

stainless

Catalog #	Description
840-345	4½" (115mm), 10mm convex blades
840-350	5" (140mm), 8mm convex blades



Collar and Crown Style Wire Scissors

smooth blades

Catalog #	Description
840-355	4¼" (108mm), straight
840-360	4¾" (115mm), straight
840-365	4¼" (108mm), curved
840-370	4¾" (115mm), curved

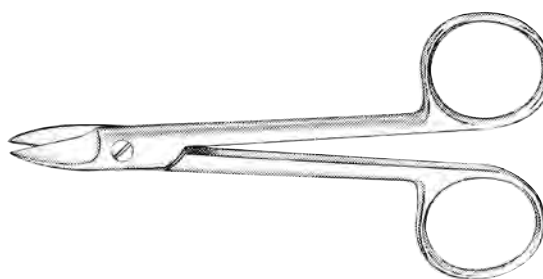

Schink Metatarsal Spreader

Catalog #	Description
841-110	4½" (115mm)



Polokoff Bone Files

Catalog #	Description
842-100	7¼" (184mm), double ended, narrow pattern
842-105	6" (152mm), short head, fine serrations
842-110	6½" (165mm), 1.3mm wide, straight



Nail Nippers

stainless

Catalog #	Description
842-500	5½" (140mm), angled concave jaws, double spring
842-505	5½" (140mm), straight jaws, double spring



Hand Chisel

with solid octagon handle

Catalog #	Description
842-600	5" (127mm), curved edge, 6mm wide



Nucleus Knife

with solid octagon handles

Catalog #	Description
842-605	5" (127mm), 2mm wide
842-610	5" (127mm), 3mm wide
842-615	5" (127mm), 4mm wide



Packer and Excavator

with solid octagon handle

Catalog #	Description
842-620	5½" (140mm), blunt hook end and 2mm x 25mm packer



Universal Hand Drill

Catalog #	Description
275-125	9 ³ / ₄ " (247mm) cannulated, 3-jaw stainless Jacobs chuck, accepts wire/pin up to 4mm (3/16"), aluminum body with offset handle

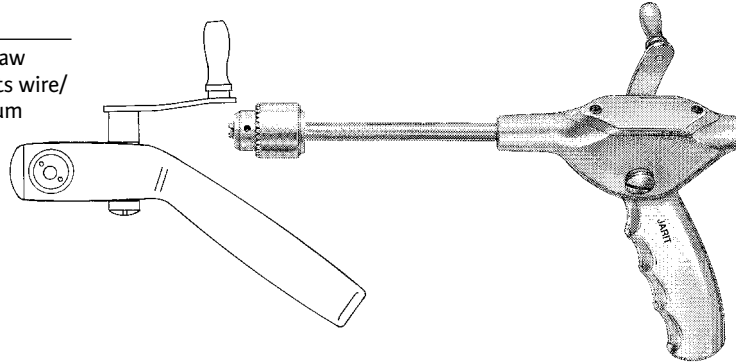

Universal Hand Drill

Catalog #	Description
275-126	6 ¹ / ₄ " (160mm) cannulated, 3-jaw stainless Jacobs chuck, accepts wire/pin up to 4mm (3/16"), aluminum body with offset handle

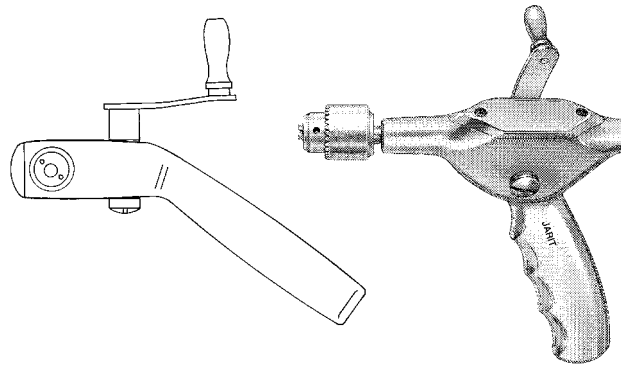

**Bunnell Hand Drill
with Jacobs Hand Chuck**

Catalog #	Description
275-135	5 ¹ / ₂ " (141mm), accepts wire/pin up to 4mm (3/16")
275-KEY-135	Replacement Jacobs Chuck Key Only

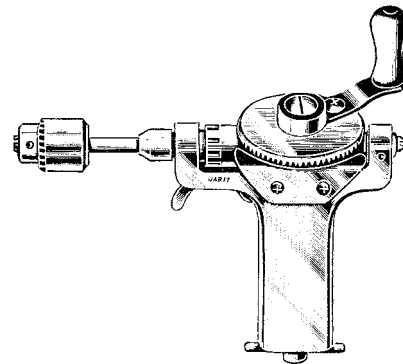

Wire Pulling Forceps

Catalog #	Description
275-140	6 1/2" (166mm), maximum capacity 1mm, 21.5mm jaw with 17mm platform

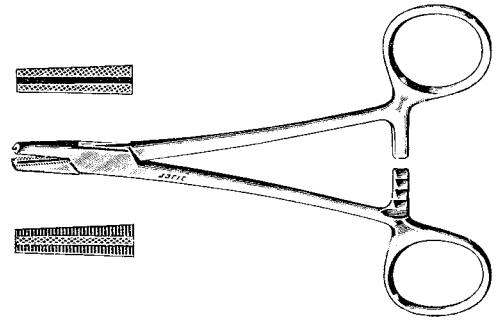

Corwin Wire Twister, Carb-Bite

Catalog #	Description
275-145	11" (280mm), overall length, 5 7/8" (150mm) working length, 3.2mm wide tip x 11mm long jaws

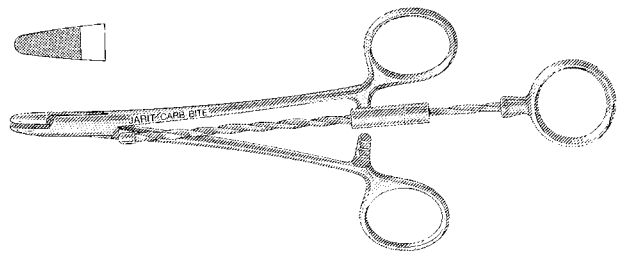

Sternal Needle Holder and Wire Twister, Carb-Bite
4000 teeth per square inch, for use with 1.0 and 2.0 suture

Catalog #	Description
121-250	5 1/4" (132mm) (Rubio)
121-255	7" (176mm)
121-260	7 1/4" (186mm), heavy duty 5mm wide jaws (Berry)

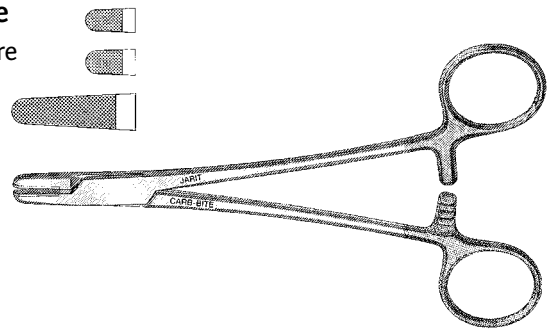

Cooley-Baumgarten, Sternal Wire Twister, Carb-Bite
2500 teeth per square inch, for use with 1.0 and 2.0 suture

Catalog #	Description
121-265	8" (205mm), heavy duty, blunt jaws, textured tips

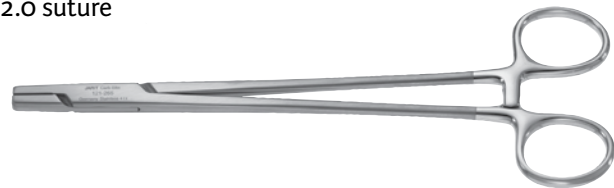

Wire Twisters, Carb-Bite
2500 teeth per square inch, for use with 1.0 and 2.0 suture

Catalog #	Description
121-257	6" (155mm), short delicate jaws
121-258	6" (155mm), short blunt jaws

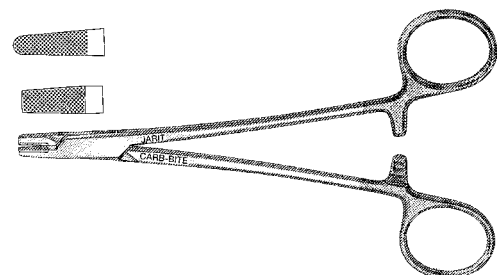

Hercules Supercutter, Large

tungsten-carbide blades are replaceable

Catalog #	Description
275-500	8½" (219mm) length, maximum capacity 0.118" (3mm)
275-501	Replacement blade kit for 275-500 includes: 1 pair tungsten carbide blades 4 screws 1 hexagonal key
275-502	Protective Shield for 275-500, set of 2

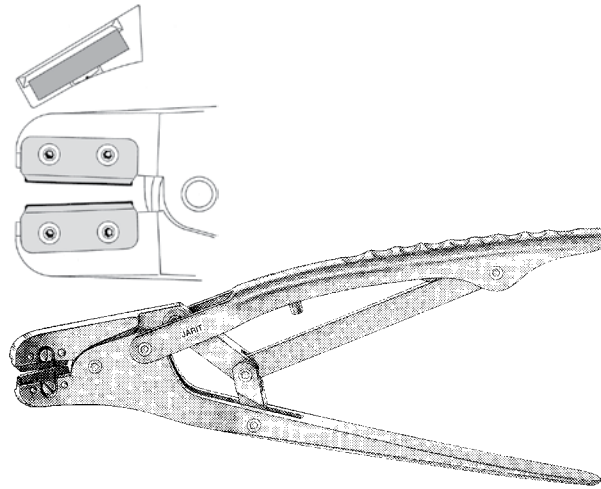

Hercules Supercutter, Small

Catalog #	Description
275-503	7" (175mm) length, maximum capacity 0.087" (2.2mm)
275-504	Replacement blade kit for 275-503 includes: 1 pair tungsten carbide blades 4 screws 1 hexagonal key
275-505	Protective Shield for 275-503, set of 2

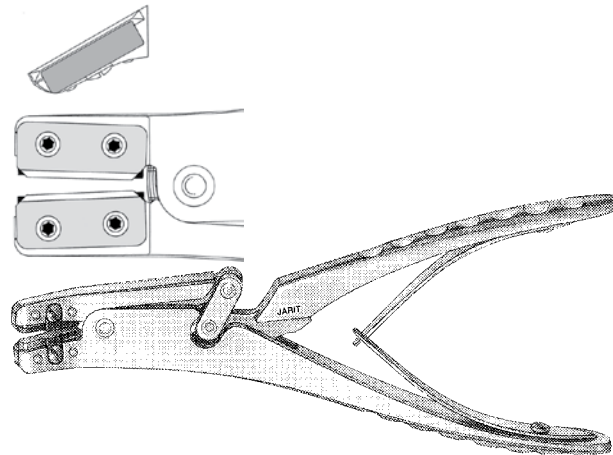

Diamond Pin Cutter

Catalog #	Description
275-155	6½" (162mm), maximum capacity 0.079" (2mm)

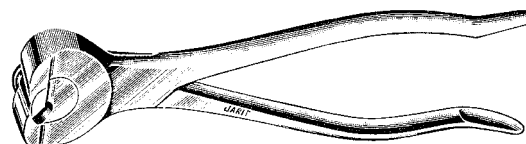

Double Action Wire Cutters, Carb-Edge

up-angled jaws

Catalog #	Description
275-510	7¼" (181mm), maximum capacity 0.067" (1.7mm)
275-515	8¾" (222mm), maximum capacity 0.098" (2.5mm)

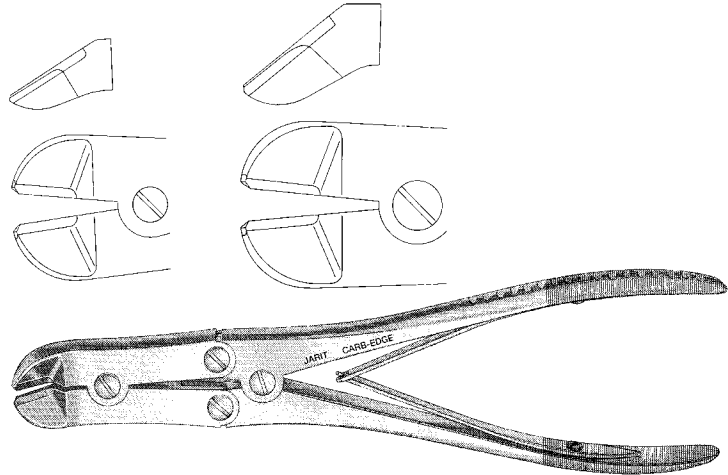

Flush Wire Cutter, Carb-Edge

straight

Catalog #	Description
275-525	6¾" (170mm), maximum capacity 0.067" (1.7mm)

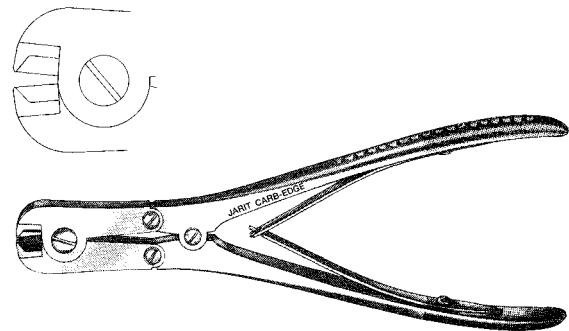

Wire Cutter, Side Cutting, Carb-Edge

Catalog #	Description
275-530	7¼" (186mm), maximum capacity 0.059" (1.5mm)

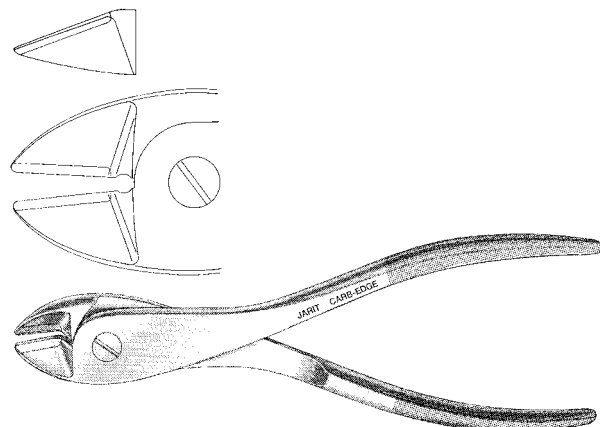

Cannulated Pin Cutter

Catalog #	Description
275-540	7 ¹ / ₄ " (184mm), end-cutting, maximum capacity .063" (1.6mm)

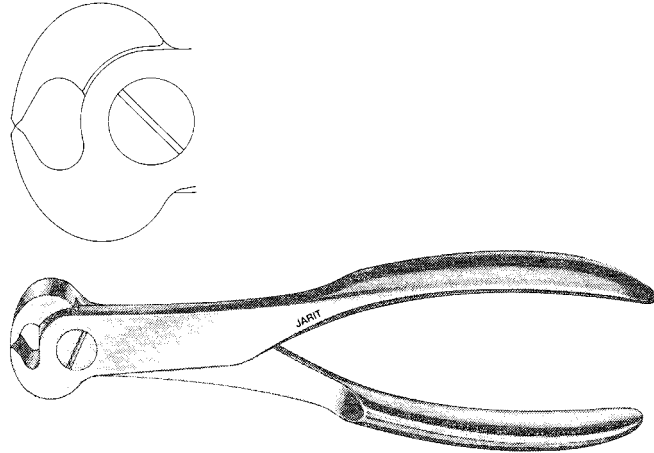

Large Pin Cutter

Catalog #	Description
275-550	22 ¹ / ₂ " (571mm), cuts rods up to .250" (6.3mm) with toggle joint

- 275-JWA-550 Replacement Jaw Assembly
- 275-JWA-550I Replacement Jaw Assembly Installed

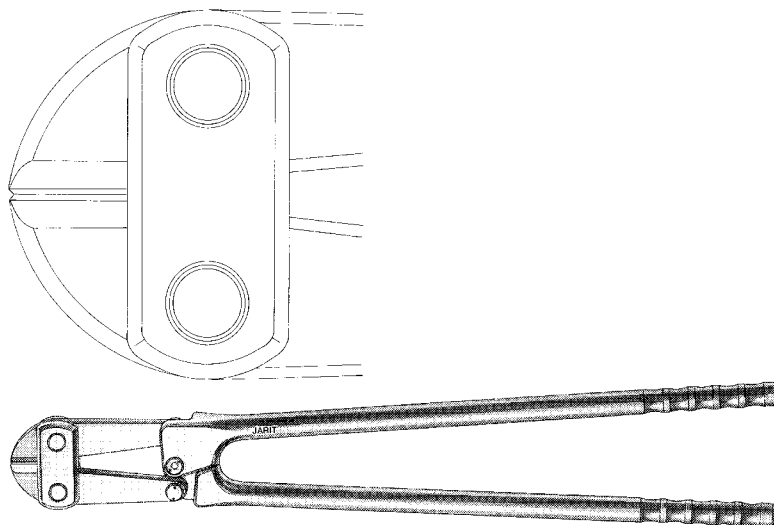

Slip Joint Utility Pliers

Catalog #	Description
275-555	7 ³ / ₄ " (198mm)
275-NTB-555	Replacement Nut and Bolt Set

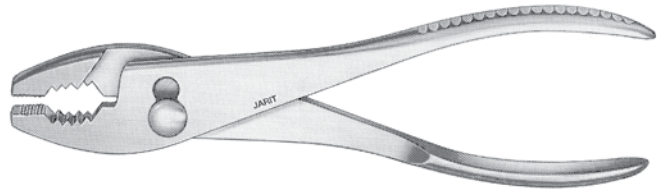
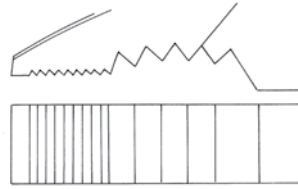

Parallel Pliers

Catalog #	Description
275-560	7 ¹ / ₄ " (184mm), grooved 10mm wide jaws for pin removal

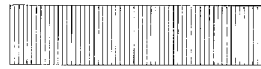
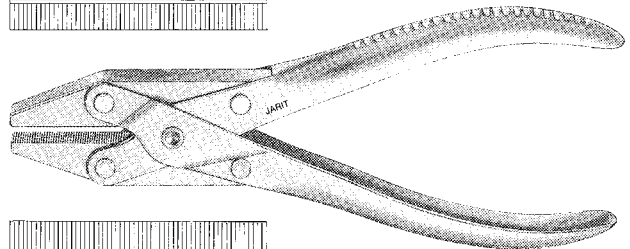
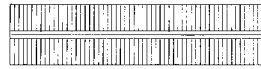

Parallel Pliers with side cutter

Catalog #	Description
275-561	7 ¹ / ₄ " (184mm), grooved 10mm wide jaws for pin removal, maximum capacity .063" (1.6mm)

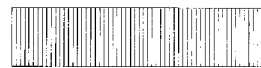
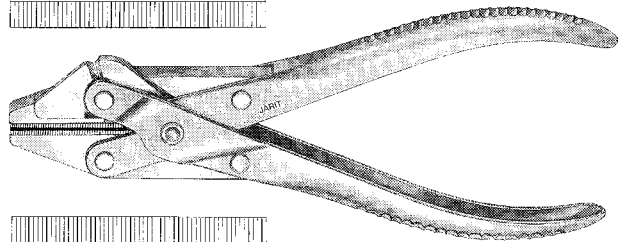

Needle Nose Pliers

Catalog #	Description
275-565	5 ¹ / ₄ " (133mm), grooved jaws, tips taper to 1mm

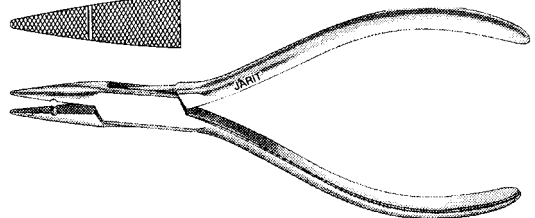

Flat Nose Pliers

Catalog #	Description
275-570	5 ⁷ / ₈ " (150mm), tips taper to 2mm

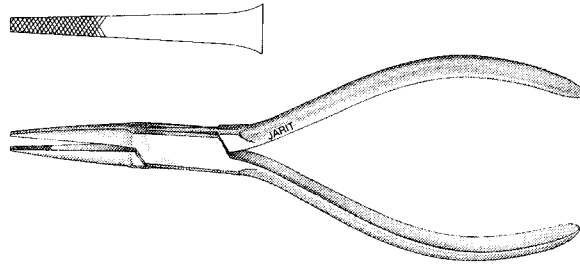

Flat Nose Pliers

with side cutter

Catalog #	Description
275-580	6 ¹ / ₂ " (162mm) side cutting blades, tips taper to 3.5mm

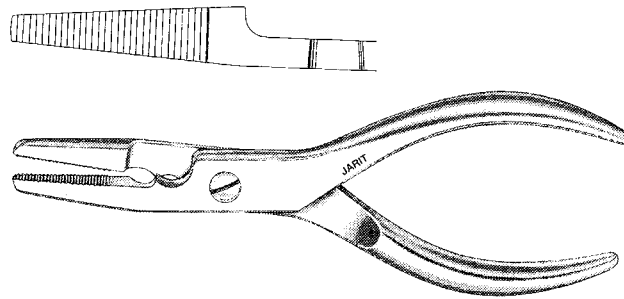

Heavy Duty Locking Pliers

reinforced jaw hinge, self-locking lever with adjustment screw and one-handed quick release

Catalog #	Description
275-589	7" (180mm), 8mm wide tip
275-590	8" (205mm), 9mm wide tip
275-591	10" (255mm), 13mm wide tip

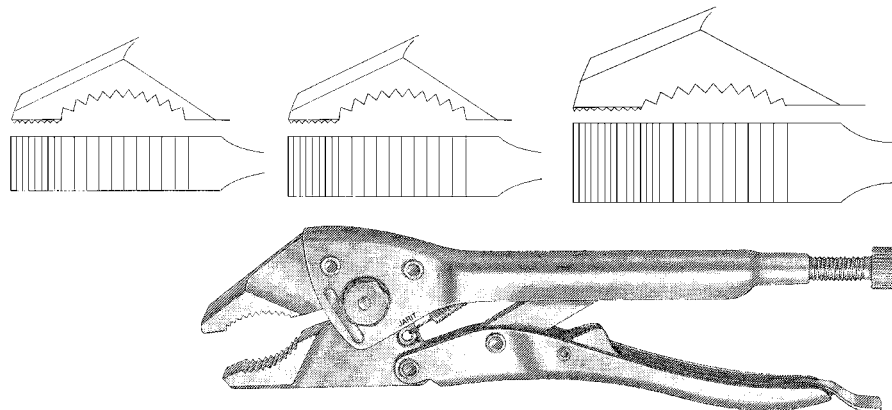

Heavy Duty Needle Nose Locking Pliers

reinforced jaw hinge, self-locking lever with adjustment screw and one-handed quick release

Catalog #	Description
275-594	8¾" (220mm), 5mm wide tip
275-595	9½" (241mm), 5mm wide tip
275-596	11½" (292mm), 7mm wide tip

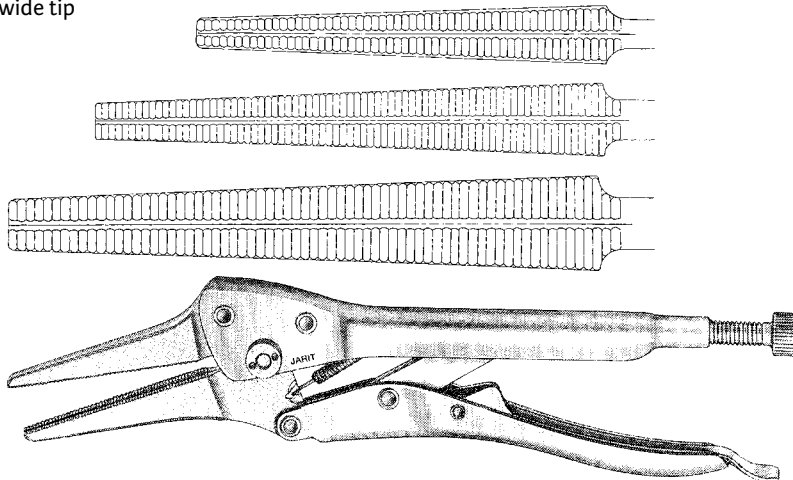

Townley Femur Caliper

Catalog #	Description
275-600	4½" (115mm)
275-SSC-600	Replacement Set Screw pkg/2ea

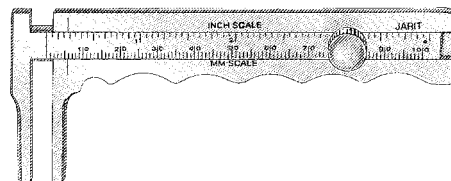

Integra[™]
Microsurgical
Instruments and
General Surgical
Instruments

Broli-Adson Forceps

1.2mm tips

Catalog #	Description
130-246	6" (152mm), straight, serrated tips
130-247	6" (152mm), curved, serrated tips
130-248	6" (152mm), straight, Stardust tips
130-249	6" (152mm), straight, 1 x 2 teeth



Microsurgical Forceps with Platform

7" (180mm) round handle

Catalog #	Description
277-040	Straight, 0.4mm micro tip
277-041	Straight, 0.5mm micro tip, 1 x 2 teeth
277-042	Straight, 0.8mm delicate tip
277-043	Straight, 0.8mm delicate tip, 1 x 2 teeth
277-044	Curved, 0.4 micro tip
277-045	Curved, 0.5mm micro tip, 1 x 2 teeth
277-046	Curved, 0.8mm delicate tip
277-047	Curved, 0.8mm delicate tip, 1 x 2 teeth

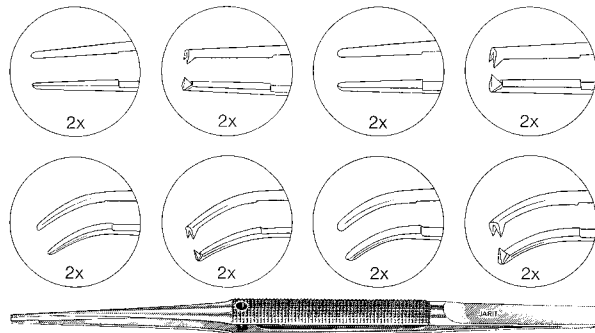

Rhoton-Type Suture Tying Forceps

with 6mm platform, round handle

Catalog #	Description
277-049	7" (178mm), straight

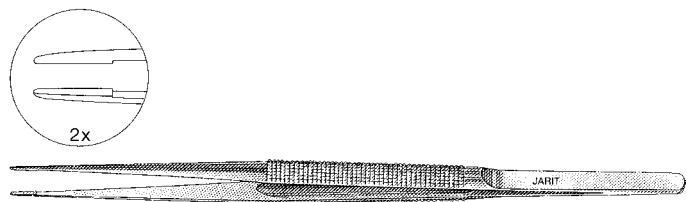

Micro Suture Tying Forceps

with 6mm platform, round handle

Catalog #	Description
277-080	6" (152mm), straight
277-081	6" (152mm), curved

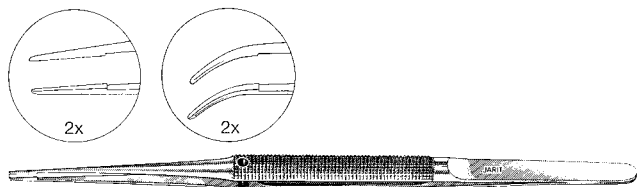

Microsurgical Scissors, Wide Handle

5½" (140mm), 12mm regular blades

Catalog #	Description
277-050	Straight
277-051	Curved
277-053	Straight, serrated
277-054	Curved, serrated

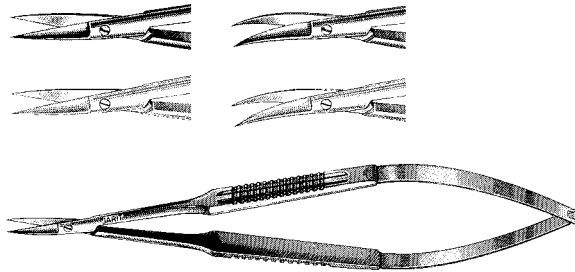

Microsurgical Scissors, Wide Handle

5½" (140mm), 12mm micro blades

Catalog #	Description
277-056	Straight
277-057	Curved

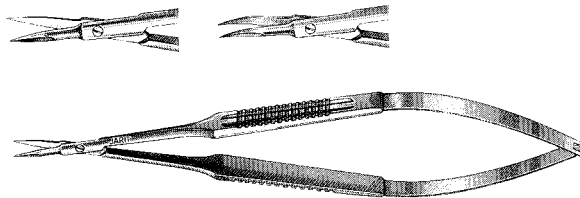

Dennis Micro Scissors, Round Handle, Double-Action

7¼" (184mm), 8mm micro blades

Catalog #	Description
277-058	Straight blades
277-059	Curved blades



Microsurgical Scissors, Round Handle

7" (178mm), 13mm regular blades

Catalog #	Description
277-060	Straight
277-061	Curved
277-062	Angled to side, 60°

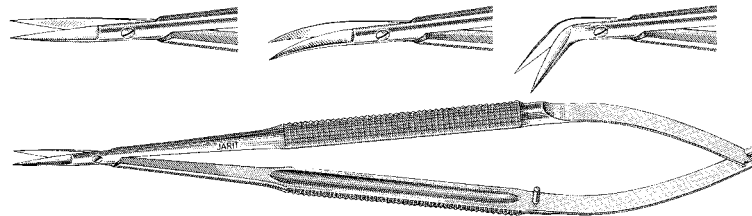

Microsurgical Scissors, Round Bayonet Handle

8½" (215mm), 14mm regular blades

Catalog #	Description
277-065	Straight
277-066	Curved

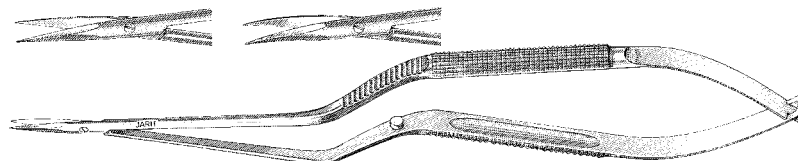

Microsurgical Needle Holders, Round Handle

5½" (140mm), 0.6mm x 10mm length jaws

Catalog #	Description
277-070	Straight jaw
277-071	Curved jaw
277-072	Straight jaw, catch
277-073	Curved jaw, catch

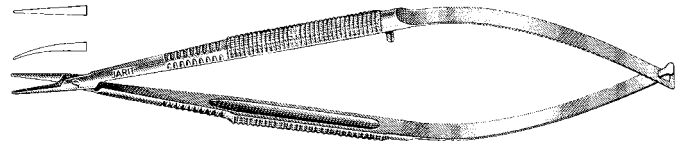

Microsurgical Needle Holders, Wide Handle

5¾" (146mm), 0.7mm x 12mm length jaws

Catalog #	Description
277-075	Straight jaw
277-076	Curved jaw

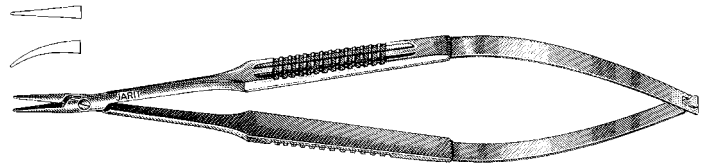

Microsurgical Needle Holders, Round Handle

7" (180mm)

Catalog #	Description
277-090	Straight jaw (0.6mm wide x 10mm long), micro tip
277-091	Straight jaw (0.6mm wide x 10mm long), micro tip, catch
277-092	Straight jaw (0.8mm wide x 9mm long), delicate tip
277-093	Straight jaw (0.8mm wide x 9mm long), delicate tip, catch
277-094	Curved jaw (0.6mm wide x 10mm long), micro tip
277-095	Curved jaw (0.6mm wide x 10mm long), micro tip, catch
277-096	Curved jaw (0.8mm wide x 10mm long), delicate tip
277-097	Curved jaw (0.8mm wide x 10mm long), delicate tip, catch

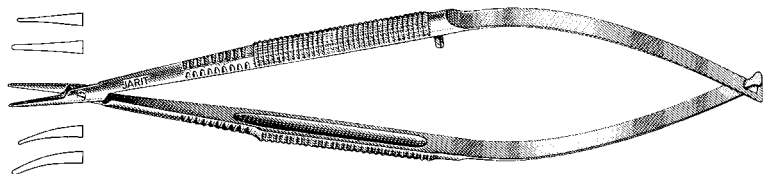

Yasargil Scissors, Flat Bayonet Handle

9" (227mm)

Catalog #	Description
277-100	Straight, 14mm regular blade
277-101	Curved, 14mm regular blade
277-103	Straight, 12mm micro blade
277-104	Curved, 12mm micro blade

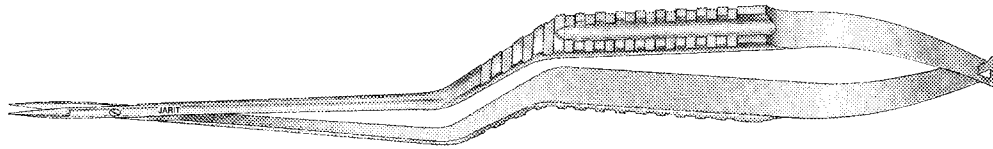

Yasargil Needle Holders, Flat Bayonet Handle

8¾" (225mm)

Catalog #	Description
277-110	Straight jaw
277-111	Curved jaw

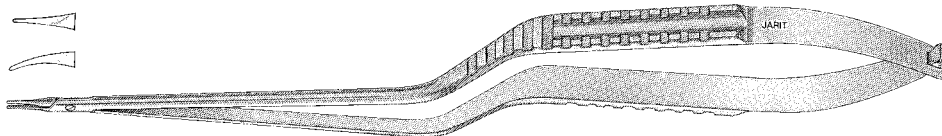

Yasargil Forceps, Flat Bayonet Handle

9" (229mm)

Catalog #	Description
277-115	Blunt tips, 0.8mm
277-116	Sharp tips, 0.3mm

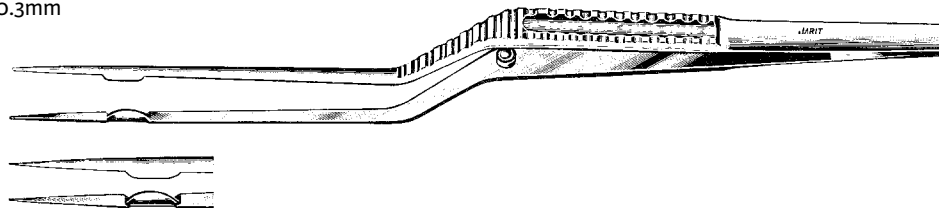

Jacobson Scissors, Flat Handle

7" (180mm)

Catalog #	Description
277-120	Straight, 15mm blade
277-121	Curved, 15mm blade
277-122	Angled on the side, 10mm blade

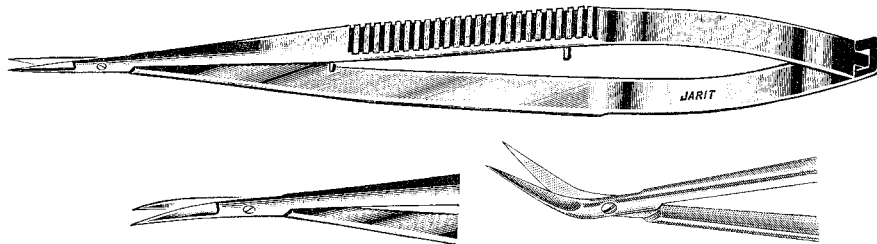

Jacobson Micro Scissors, Flat Handle

7" (178mm), 12mm blades

Catalog #	Description
277-123	Straight blades, blunt tips
277-124	Curved blades, blunt tips



Jacobson Scissors, Flat Bayonet Handle

7 1/4" (185mm)

Catalog #	Description
277-130	Straight, 13mm regular blade
277-131	Curved, 13mm regular blade
277-132	Angled on the side, 10mm regular blade
277-135	Straight, 11mm micro blade
277-136	Curved, 11mm micro blade

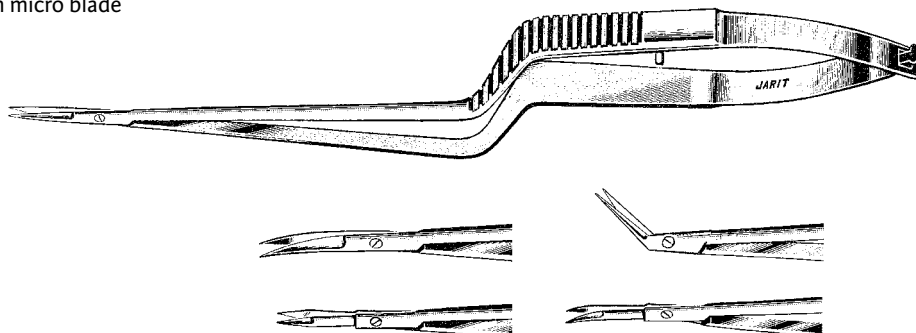

Jacobson Micro Scissors, Flat Handle

9mm micro fine blades

Catalog #	Description
277-330	6 1/2" (165mm), 25 degree angle
277-331	6 1/2" (165mm), 45 degree angle
277-332	6 1/2" (165mm), 60 degree angle
277-333	6 1/4" (159mm), 90 degree angle
277-334	6 1/4" (159mm), 120 degree angle



Jacobson Micro Scissors, Round Handle

9mm micro fine blades

Catalog #	Description
277-335	6 3/4" (170mm), 25 degree angle
277-336	6 3/4" (170mm), 45 degree angle
277-337	6 3/4" (170mm), 60 degree angle
277-338	6 1/2" (165mm), 90 degree angle
277-339	6 1/2" (165mm), 120 degree angle

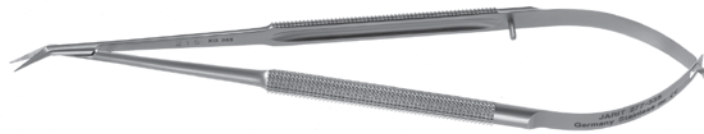

Jacobson Needle Holder, Flat Handle, Straight

7" (178mm), 1.4mm x 12mm length jaws

Catalog #	Description
277-140	Without catch
277-141	With catch

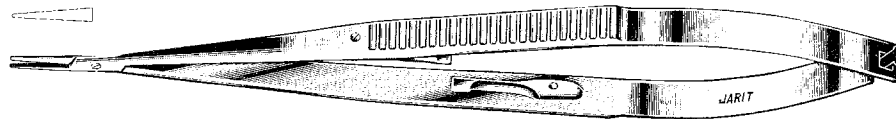

Jacobson Needle Holder, Flat Bayonet Handle, Without Catch

7" (180mm)

Catalog #	Description
277-145	Straight jaw, jaws 0.8mm wide x 12mm long
277-147	Fine curved jaw, jaws 0.8mm wide x 9mm long

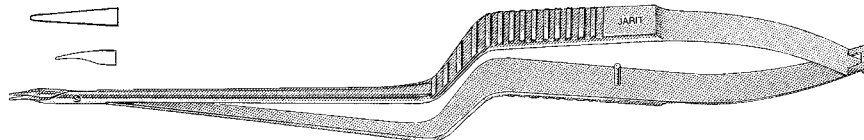

Castroviejo Style Microsurgical Needle Holders, Carb-Bite

7000 teeth per square inch, 1mm tips, for use with 5.0, 6.0 and 7.0 suture serrated jaws

Catalog #	Description
121-229	7" (178mm)
121-229NL	7" (178mm) (Non Locking)
121-231	8½" (216mm)
121-231NL	8½" (216mm) (Non Locking)

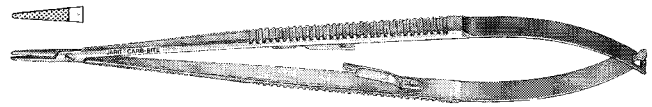

Castroviejo Style Microsurgical Needle Holders, Carb-Bite

1mm tips, for use with 5.0, 6.0 and 7.0 suture smooth jaws

Catalog #	Description
121-228	7" (178mm)
121-228NL	7" (178mm) (Non Locking)
121-230	8½" (216mm)
121-230NL	8½" (216mm) (Non Locking)

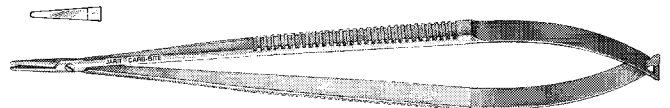

Jacobson Forceps, Flat Bayonet Handle

6¼" (160mm)

Catalog #	Description
277-159	sharp tips

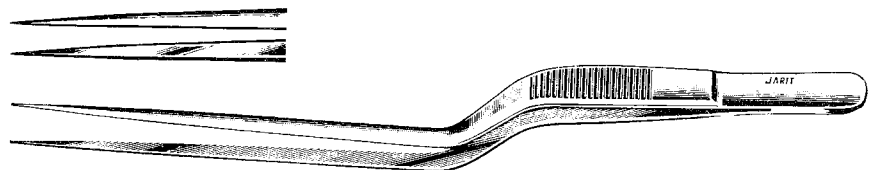

Jacobson Forceps, Flat Bayonet Handle

7¼" (185mm)

Catalog #	Description
277-160	0.8mm blunt tips
277-161	0.3mm sharp tips
277-162	0.8mm angled blunt tips

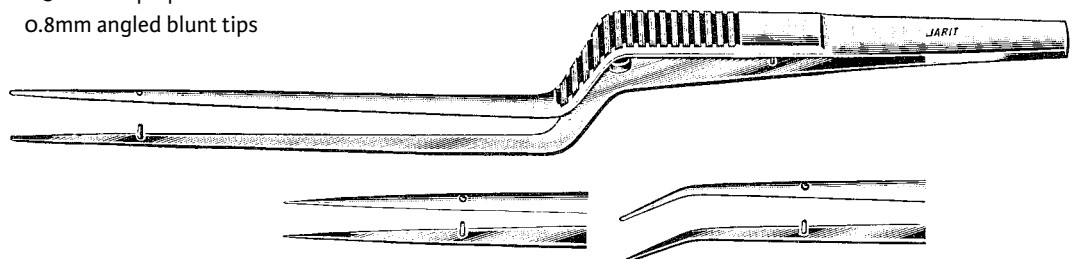



Jacobson Instruments, Straight Round Handle

7 1/4" (185mm)

Catalog #	Description	
277-200	Vessel knife	
277-202	Blood vessel probe	
277-204	Blood vessel probe and supporter	
277-206	Suture pusher	

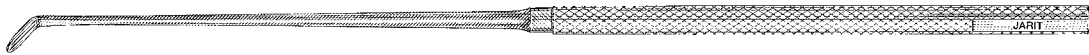

Yasargil Instruments, Straight Round Handle

7 1/4" (185mm)

Catalog #	Description	
277-210	Raspatory, wide blade	
277-211	Raspatory, narrow, light curve	
277-212	Raspatory, narrow, strong curve	
277-213	Raspatory, angled	
277-215	Dissector	

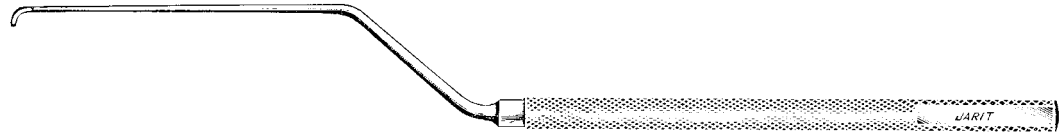

Yasargil Instruments, Round Bayonet Handle
7 1/4" (185mm)

Catalog #	Description
-----------	-------------

277-217	Arachnoid knife
---------	-----------------



277-220	Raspatory, light curve
---------	------------------------

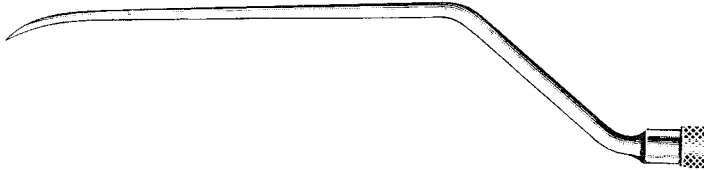

277-221	Raspatory, forward cutting
---------	----------------------------



277-222	Raspatory, backward cutting
---------	-----------------------------

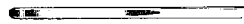

277-225	Curette
---------	---------

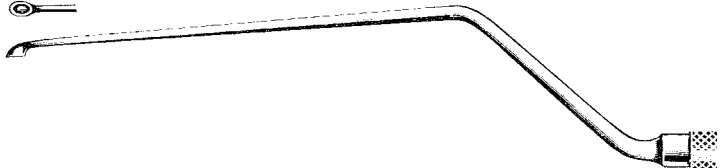

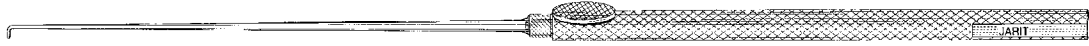

Krayenbuehl Nerve Hooks

7¼" (185mm)

Catalog #	Description
277-235	Small



277-236	Large
---------	-------



277-237	Small, ball tip
---------	-----------------



277-238	Large, ball tip
---------	-----------------



Krayenbuehl Dura Hooks

7¼" (185mm)

Catalog #	Description
277-240	Curved
277-241	Right angle

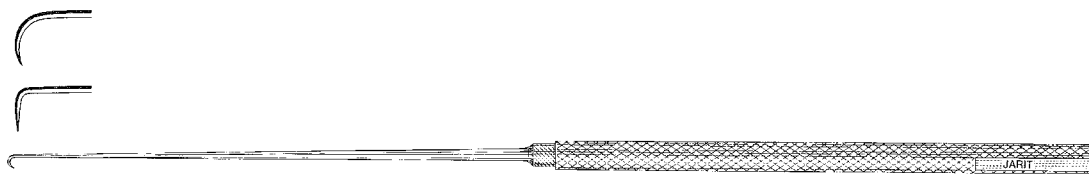

Krayenbuehl Twist Hooks

7¼" (185mm)

Catalog #	Description
277-244	Small, 1mm diameter
277-245	Large, 1.8mm diameter

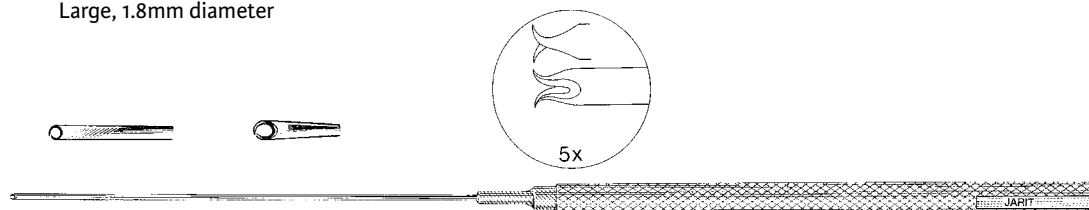

Yasargil Ligature Carriers

7¼" (185mm)

Catalog #	Description
277-250	Right angle
277-251	Short strong curve
277-252	Long strong curve
277-253	Long light curve

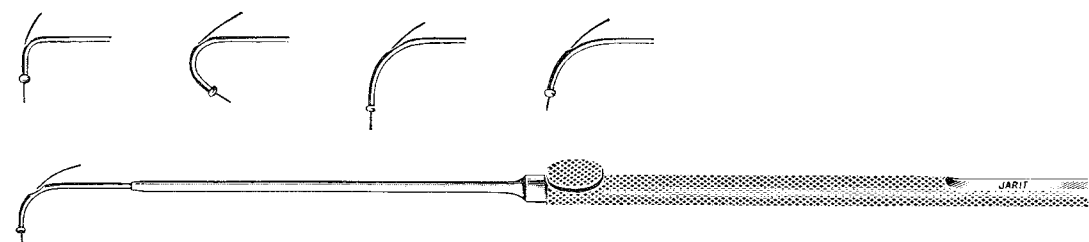

Rhoton-Type

dissectors, round, 7½" (190mm)

Catalog #	Description
277-260	1mm blade, #1
277-261	2mm blade, #2
277-262	3mm blade, #3



Titanium

Rhoton-Type

dissectors, round, 7½" (190mm)

Catalog #	Description
277-260TI	1mm blade, #1
277-261TI	2mm blade, #2
277-262TI	3mm blade, #3



Rhoton-Type

elevators, 7½" (190mm)

Catalog #	Description
277-263	Curved, #4
277-264	Angled, #5



Titanium

Rhoton-Type

elevators, 7½" (190mm)

Catalog #	Description
277-263TI	Curved, #4
277-264TI	Angled, #5



Rhoton-Type

spatula-dissectors, 7½" (190mm)

Catalog #	Description
277-265	Small, #6
277-266	Medium, #7
277-267	Large, #8



Titanium

Rhoton-Type
spatula-dissectors, 7½" (190mm)

Catalog #	Description
277-265TI	Small, #6
277-266TI	Medium, #7
277-267TI	Large, #8



Rhoton-Type
hooks, 7½" (190mm)

Catalog #	Description
277-268	90° angle, semi-sharp, #9
277-269	90° angle, blunt, #10
277-270	45° angle, semi-sharp, #11



Titanium

Rhoton-Type
hooks, 7½" (190mm)

Catalog #	Description
277-268TI	90° angle, semi-sharp, #9
277-269TI	90° angle, blunt, #10
277-270TI	45° angle, semi-sharp, #11



Rhoton-Type
needle, 7½" (190mm)

Catalog #	Description
277-271	Straight, #12



Titanium

Rhoton-Type
needle, 7½" (190mm)

Catalog #	Description
277-271TI	Straight, #12

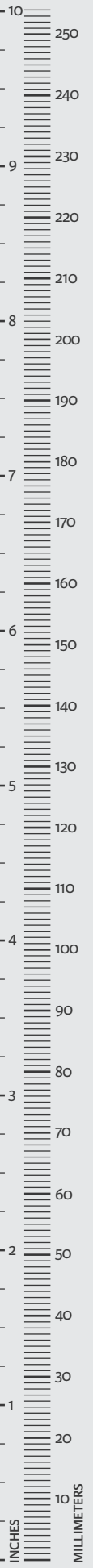

Rhoton-Type

curettes, 7½" (190mm)

Catalog #	Description
277-272	Straight, #13
277-273	Angled, #14



Titanium

Rhoton-Type

curettes, 7½" (190mm)

Catalog #	Description
277-272TI	Straight, #13
277-273TI	Angled, #14



Rhoton-Type

ball-dissectors, round, 7½" (190mm)

Catalog #	Description
277-274	90° angle, 3mm, #16



Titanium

Rhoton-Type

ball-dissectors, round, 7½" (190mm)

Catalog #	Description
277-274TI	90° angle, 3mm, #16
277-276TI	Straight, #15
277-277TI	90° angle, 5mm, #17
277-278TI	40° angle, 4mm, #18
277-279TI	40° angle, 8mm, #19



Rhoton-Type Instrument Rack

Catalog #	Description
277-275	10" x 8" x 1" (253mm x 201mm x 25mm), for 15 stainless steel or titanium instruments, 277-260 through 277-274

Catalog #	Description
277-275TI	10" x 8¾" x 1" (253mm x 223mm x 25mm), for 19 stainless steel or titanium instruments, 277-260TI through 277-279TI

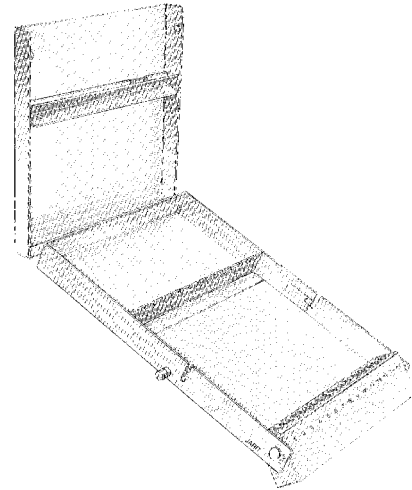

Rhoton-Type Micro Forceps

5⅜" (135mm) shaft, 1mm cup

Catalog #	Description
277-290	Straight
277-291	Angled right
277-292	Angled left

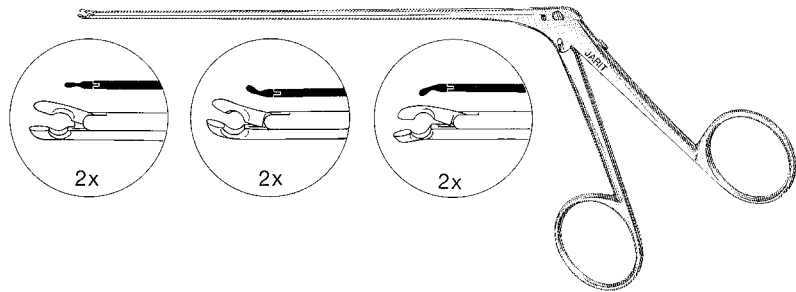

Rhoton-Type Micro Forceps

5⅜" (135mm) shaft, 2mm cup

Catalog #	Description
277-295	Straight

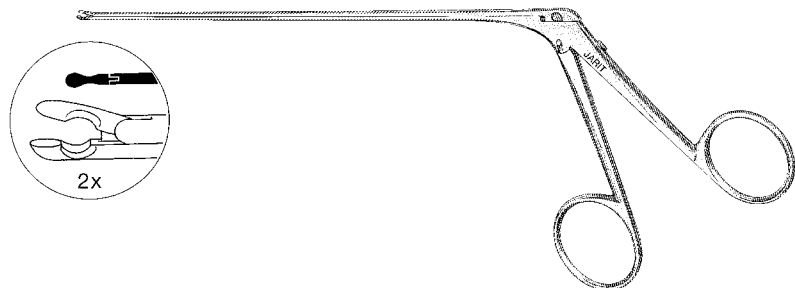

Jarit Stardust® Needle Holders

Unique metallurgical process bonds Tungsten Carbide particles to the jaws.
Extra hardness assures durability and firm grip without damaging needles.

Jarit Stardust Needle Holders

Tungsten Carbide coated jaws, round handles,
1.2mm delicate jaw needle holders, for 6.0 and 7.0 sutures

straight delicate jaws,
without catch

Catalog #	Description
278-092	7¼" (183mm)
278-094	8¼" (210mm)
278-096	9" (230mm)

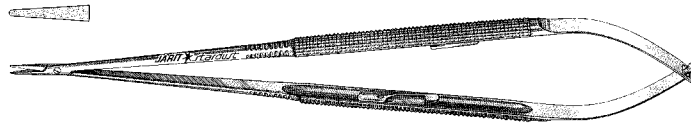

straight delicate jaws,
with catch

Catalog #	Description
278-093	7¼" (183mm)
278-095	8¼" (210mm)
278-097	9" (230mm)

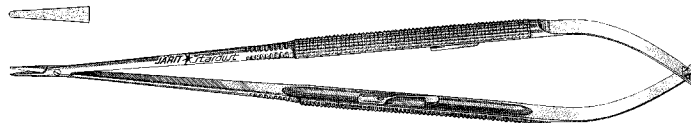

curved delicate jaws,
without catch

Catalog #	Description
278-100	7¼" (184mm)
278-102	8" (204mm)
278-104	9" (230mm)

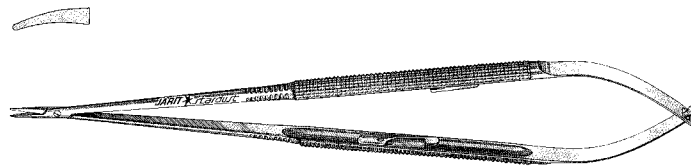

curved delicate jaws,
with catch

Catalog #	Description
278-101	7" (179mm)
278-103	8" (204mm)
278-105	9" (230mm)

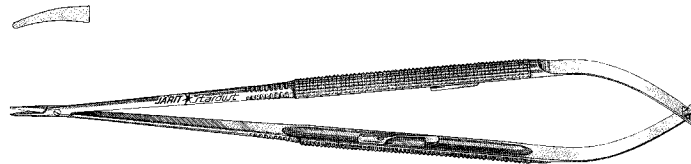

Jarit Stardust Needle Holders

Tungsten Carbide coated jaws, round handles,
0.9mm micro jaw needle holders, for 8.0, 9.0, and 10.0 sutures

straight micro jaws,
without catch

Catalog #	Description
278-110	7" (179mm)
278-112	8" (204mm)
278-114	9" (230mm)

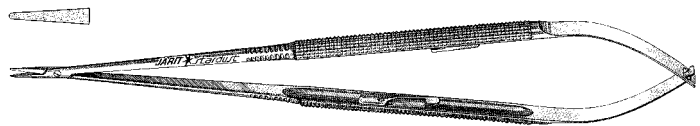

straight micro jaws,
with catch

Catalog #	Description
278-111	7" (179mm)
278-113	8" (204mm)
278-115	9" (230mm)

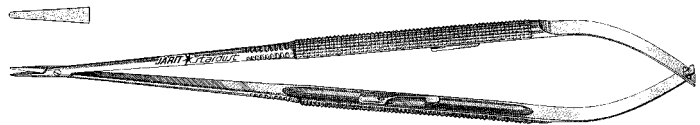

curved micro jaws,
without catch

Catalog #	Description
278-116	7" (179mm)
278-118	8" (204mm)
278-120	9" (230mm)

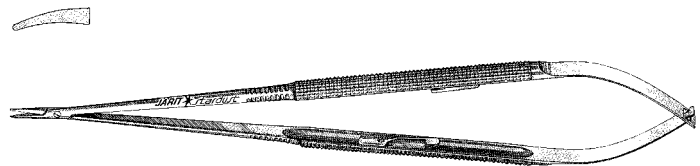

curved micro jaws,
with catch

Catalog #	Description
278-117	7" (179mm)
278-119	8" (204mm)
278-121	9" (230mm)

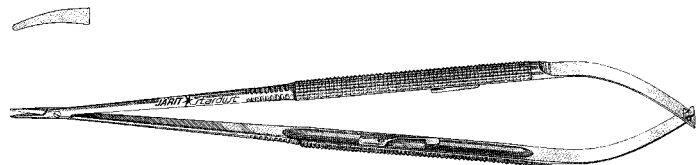

Jacobson Micro Stardust Needle Holders

Tungsten Carbide coated jaws, flat serrated handles, 1.3mm delicate needle holders, for 5.0 and 6.0 suture

Catalog #	Description
278-180	7" (178mm), straight jaws, with catch
278-183	7" (180mm), straight jaws, without catch
278-181	8½" (216mm), straight jaws, with catch
278-184	8½" (216mm), straight jaws, without catch
278-182	8½" (216mm), curved jaws, with catch
278-185	8½" (216mm), curved jaws, without catch
278-186	9½" (240mm), straight jaws, with catch



Jacobson Micro Stardust Needle Holders

Tungsten Carbide coated jaws, round handles, 1.2mm tip, low profile box lock, heavy pattern needle holders, for 5.0 and 6.0 sutures

Catalog #	Description
278-060	6" (155mm), straight jaws, with catch
278-061	6" (155mm), straight jaws, without catch
278-062	6" (155mm), curved jaws, with catch
278-063	6" (155mm), curved jaws, without catch

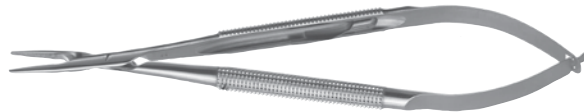

Castroviejo Micro Stardust Needle Holders, with catch

straight jaws, delicate 1.5mm tip

Catalog #	Description
278-040	5¾" (147mm), round handle
278-050	5½" (140mm), flat handle



Titanium

Jarit Stardust Needle Holders

titanium, Tungsten Carbide coated jaws

straight delicate jaws
with catch

Catalog #	Description
278-080TI	7" (180mm)
278-082TI	8¼" (210mm)



straight, delicate,
round with catch

Catalog #	Description
278-093TI	7" (180mm)
278-095TI	7¾" (200mm)
278-097TI	10" (255mm)



straight, micro,
round without catch

Catalog #	Description
278-108TI	5⅞" (148mm)
278-111TI	7" (178mm)
278-113TI	7¾" (200mm)



Jacobson Micro Stardust Needle Holders

Tungsten Carbide coated jaws, for larger needles,
recommended for use with 2.0, 3-0, and 4.0 suture

Catalog #	Description
278-125NL	6¾" (169mm), straight, flat serrated handle
278-126NL	6¾" (169mm), curved, flat serrated handle
278-125	6¾" (169mm), straight, flat serrated handle, with catch
278-126	6¾" (169mm), curved, flat serrated handle, with catch



Jacobson Micro Stardust Needle Holders

Tungsten Carbide coated jaws, for larger needles, recommended for use with 2.0, 3-0, and 4.0 suture

Catalog #	Description
278-130NL	7½" (190mm), straight, round handle
278-132NL	9" (229mm), straight, round handle
278-134NL	9¾" (250mm), straight, round handle



Jacobson Micro Stardust Needle Holders

Tungsten Carbide coated jaws, for larger needles, recommended for use with 2.0, 3-0, and 4.0 suture

Catalog #	Description
278-131NL	7½" (190mm), curved, round handle
278-133NL	9" (229mm), curved, round handle
278-135NL	9¾" (250mm), curved, round handle

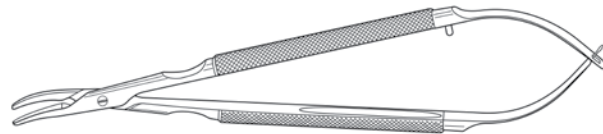

Jacobson Micro Stardust Needle Holders

Tungsten Carbide coated jaws, for larger needles, recommended for use with 2.0, 3-0, and 4.0 suture

Catalog #	Description
278-130	7½" (190mm), straight, round handle with catch
278-132	9" (229mm), straight, round handle with catch
278-134	9¾" (250mm), straight, round handle with catch



Jacobson Micro Stardust Needle Holders

Tungsten Carbide coated jaws, for larger needles, recommended for use with 2.0, 3-0, and 4.0 suture

Catalog #	Description
278-131	7½" (190mm), curved, round handle with catch
278-133	9" (229mm), curved, round handle with catch
278-135	9¾" (250mm), curved, round handle with catch



Jarit Stardust® Micro Suture Forceps

A matched set of forceps designed for tissue manipulation and needle guide.
Unique metallurgical process bonds Tungsten Carbide particles to the jaws.
Extra hardness assures durability and firm grip without damaging needles.

Jarit Stardust Micro Suture Forceps

Tungsten Carbide coated jaws, round handles

straight with tying platform

Catalog #	Description
279-100	7¼" (184mm)
279-101	8¼" (210mm)
279-102	9" (229mm)



curved, with tying platform

Catalog #	Description
279-105	7¼" (184mm)
279-106	8¼" (210mm)
279-107	9" (229mm)



Jarit Stardust Micro Forceps

round handle, 0.8mm micro DeBakey tips

Catalog #	Description
279-149	7¼" (181mm)



Jarit Stardust Micro Forceps

round handle, delicate, 1mm platform tips
straight with tying platform

Catalog #	Description
279-150	7¼" (181mm), 1 x 2 teeth



Jarit Stardust Micro Ring Forceps

delicate, 1mm ring tips

Catalog #	Description
279-110	7¼" (184mm), straight
279-130	7¼" (181mm), curved
279-111	8¼" (210mm)
279-131	8¼" (210mm), curved
279-112	9" (229mm)

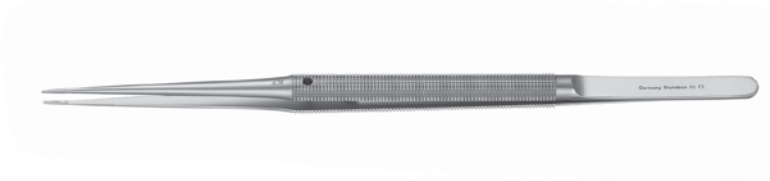

Dennis Micro Forceps

round handle, counter balance, delicate, 1mm Stardust platform tips

Catalog #	Description
279-158	7" (178mm), straight
279-159	7" (178mm), curved
279-125	8¼" (212mm), straight



Dennis Micro Ring Forceps

round handle, counter balance, delicate, 1mm Stardust tips

Catalog #	Description
279-113	6" (152mm), straight
279-114	6" (152mm), curved
279-115	7¼" (186mm), straight
279-116	7¼" (186mm), curved
279-117	8¼" (209mm), straight
279-118	8¼" (209mm), curved
279-119	9" (230mm), straight
279-120	9" (230mm), curved
279-121	10" (254mm), straight
279-122	10" (254mm), curved



Titanium

Jarit Stardust Micro Suture Forceps

titanium, Tungsten Carbide coated, round handles with counter-balance

straight with tying platform

Catalog #	Description
279-100TI	7¼" (184mm)
279-101TI	8¼" (210mm)
279-102TI	9" (229mm)



micro ring (1.0mm OD x 0.5mm ID)

Catalog #	Description
279-110TI	7¼" (181mm)
279-111TI	8¼" (210mm)
279-112TI	9" (229mm)



Integra™
Neurosurgical/
Spinal Instruments
and General Surgical
Instruments

Micro Kerrison Rongeurs

7" (178mm) shaft, 90° up-bite,
small improved handle

Catalog #	Description
280-040	1mm bite
280-050	2mm bite
280-051	3mm bite
280-052	4mm bite
280-053	5mm bite
280-054	6mm bite

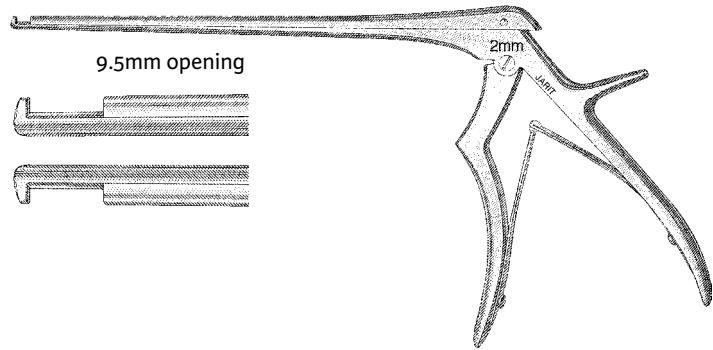

7" (178mm) shaft, 90° down-bite,
small improved handle

Catalog #	Description
280-055	2mm bite
280-056	3mm bite
280-057	4mm bite
280-058	5mm bite
280-059	6mm bite

Micro Kerrison Rongeurs

8" (203mm) shaft, 90° up-bite,
small improved handle

Catalog #	Description
281-040	1mm bite
281-050	2mm bite
281-051	3mm bite
281-052	4mm bite
281-053	5mm bite
281-054	6mm bite

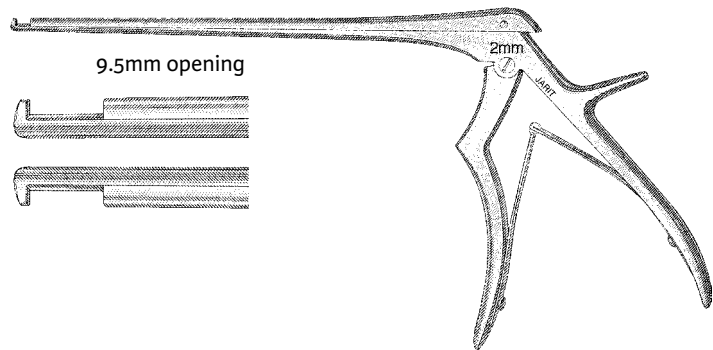

8" (203mm) shaft, 90° down-bite,
small improved handle

Catalog #	Description
281-055	2mm bite
281-056	3mm bite
281-057	4mm bite
281-058	5mm bite
281-059	6mm bite

Replacement Parts

Catalog #	Description
280-SPS-050	Replacement Spring and Screw
280-HSC-050	Replacement Handle Screw pkg/3ea



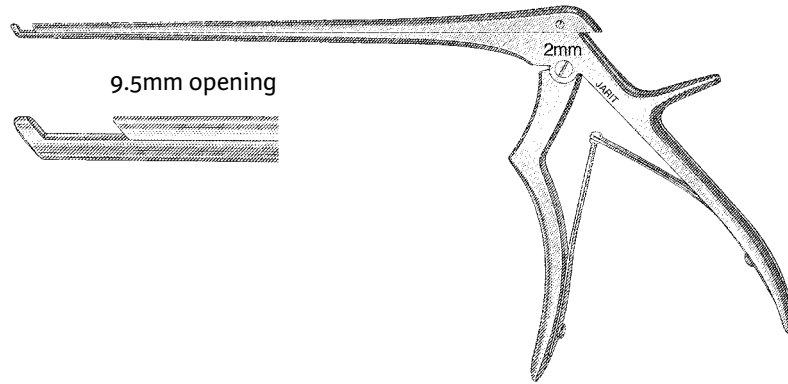

Micro Kerrison Rongeurs

7" (178mm) shaft, 40° forward angle, small improved handle

Catalog #	Description
280-041	1mm bite
280-060	2mm bite
280-061	3mm bite
280-062	4mm bite
280-063	5mm bite
280-064	6mm bite

Micro Kerrison Rongeurs

8" (203mm), 40° forward angle, small improved handle

Catalog #	Description
281-041	1mm bite
281-060	2mm bite
281-061	3mm bite
281-062	4mm bite
281-063	5mm bite
281-064	6mm bite

Micro Kerrison Rongeurs

9" (229mm), 40° forward angle, small improved handle

Catalog #	Description
282-060	2mm bite
282-061	3mm bite
282-062	4mm bite
282-063	5mm bite
282-064	6mm bite

Micro Kerrison Rongeurs

10" (279mm), 40° forward angle, small improved handle

Catalog #	Description
283-060	2mm bite
283-061	3mm bite
283-062	4mm bite
283-063	5mm bite
283-064	6mm bite

Micro Kerrison Rongeurs

11" (254mm), 40° forward angle, small improved handle

Catalog #	Description
284-060	2mm bite
284-061	3mm bite
284-062	4mm bite
284-063	5mm bite
284-064	6mm bite

Replacement Parts

Catalog #	Description
280-SPS-050	Replacement Spring and Screw
280-HSC-050	Replacement Handle Screw Pkg/3ea

Micro Kerrison Cervical Rongeurs, Thin Footplate

7" (178mm), 40° forward angle,
small improved handle

Catalog #	Description
280-060TF	2mm bite
280-061TF	3mm bite
280-062TF	4mm bite
280-063TF	5mm bite

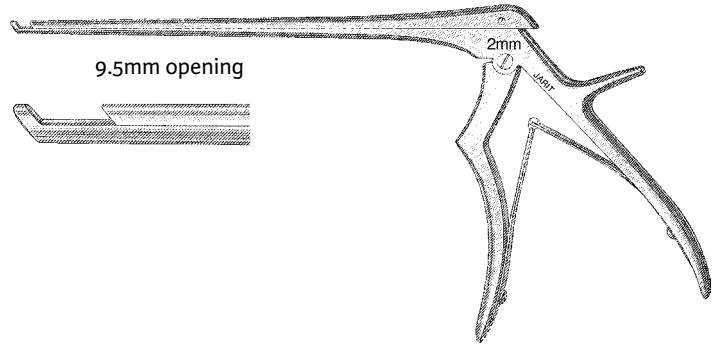

Micro Kerrison Cervical Rongeurs, Thin Footplate

8" (203mm), 40° forward angle,
small improved handle

Catalog #	Description
281-060TF	2mm bite
281-061TF	3mm bite
281-062TF	4mm bite
281-063TF	5mm bite

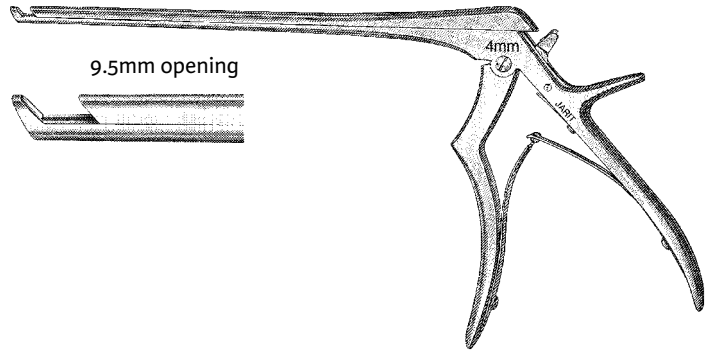

Replacement Parts

Catalog #	Description
280-SPS-TF	Replacement Spring and Screw



Jarit Detach® Micro Kerrison Cervical Rongeurs

7" (178mm) shaft, thin footplate,
40° forward angle, small improved handle

Catalog #	Description
280-040DT	1mm bite
280-060DT	2mm bite
280-061DT	3mm bite
280-062DT	4mm bite
280-063DT	5mm bite

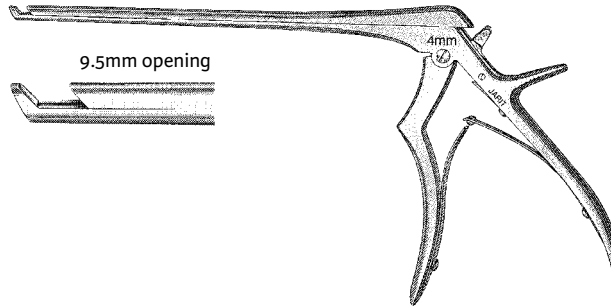

Jarit Detach® Micro Kerrison Cervical Rongeurs

8" (203mm) shaft, thin footplate,
40° forward angle, small improved handle

Catalog #	Description
281-040DT	1mm bite
281-060DT	2mm bite
281-061DT	3mm bite
281-062DT	4mm bite
281-063DT	5mm bite

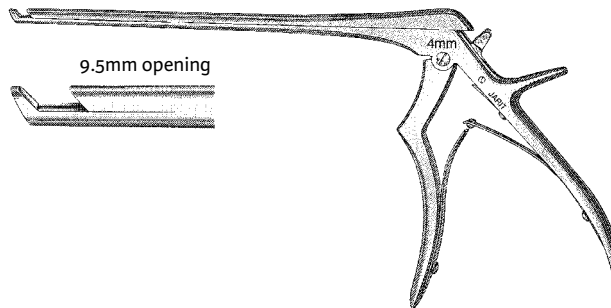

Spurling- Kerrison Rongeurs

7" (178mm) shaft, 40° forward angle,
cherry-type handle

Catalog #	Description
280-160	2mm bite
280-161	3mm bite
280-162	4mm bite
280-163	5mm bite
280-164	6mm bite

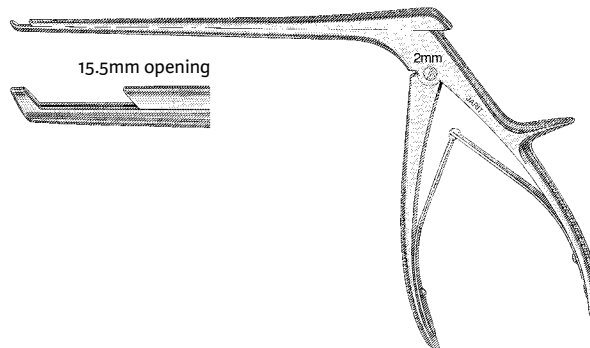

Spurling- Kerrison Rongeurs

8" (203mm) shaft, 40° forward angle,
cherry-type handle

Catalog #	Description
280-199	2mm bite
280-200	3mm bite
280-201	4mm bite
280-202	5mm bite
280-203	6mm bite

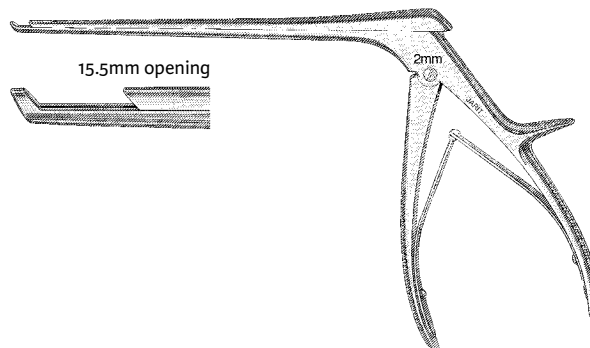

Spurling- Kerrison Rongeurs

7" (178mm) shaft, 90° up-bite,
large improved handle

Catalog #	Description
280-209	2mm bite
280-210	3mm bite
280-211	4mm bite
280-212	5mm bite
280-213	6mm bite

Spurling- Kerrison Rongeurs

8" (203mm) shaft, 90° up-bite,
large improved handle

Catalog #	Description
280-229	2mm bite
280-230	3mm bite
280-231	4mm bite
280-232	5mm bite
280-233	6mm bite

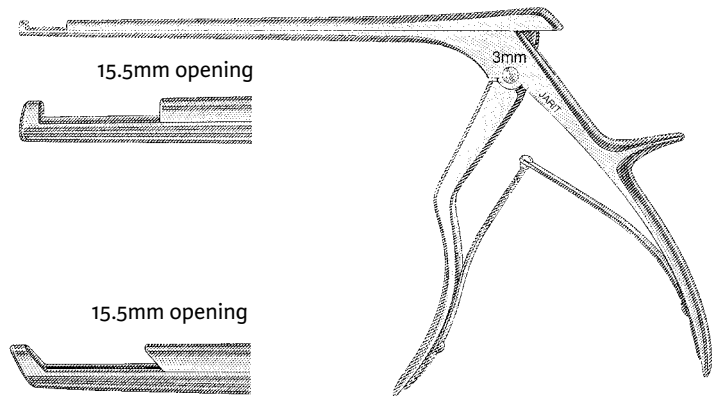

Spurling- Kerrison Rongeurs

7" (178mm) shaft, 40° forward angle,
large improved handle

Catalog #	Description
280-219	2mm bite
280-220	3mm bite
280-221	4mm bite
280-222	5mm bite
280-223	6mm bite

Spurling- Kerrison Rongeurs

8" (203mm) shaft, 40° forward angle,
large improved handle

Catalog #	Description
280-239	2mm bite
280-240	3mm bite
280-241	4mm bite
280-242	5mm bite
280-243	6mm bite

Spurling- Kerrison Rongeurs

9" (229mm) shaft, 40° forward angle,
large improved handle

Catalog #	Description
281-239	2mm bite
281-240	3mm bite
281-241	4mm bite
281-242	5mm bite
281-243	6mm bite

Spurling- Kerrison Rongeurs

11" (280mm) shaft, 40° forward angle,
large improved handle

Catalog #	Description
283-239	2mm bite
283-240	3mm bite
283-241	4mm bite
283-242	5mm bite
283-243	6mm bite



Spurling- Kerrison Rongeurs

8" (203mm) shaft, 90° down-bite,
large improved handle

Catalog #	Description
280-234	2mm bite
280-235	3mm bite
280-236	4mm bite
280-237	5mm bite
280-238	6mm bite

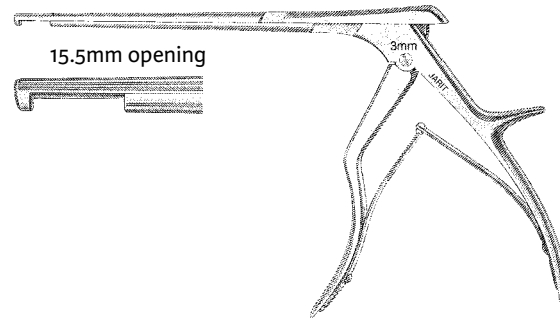

Ferris-Smith Laminectomy Rongeurs

7" (175mm), 40° forward-angle

Catalog #	Description
280-286	3mm bite
280-288	5mm bite

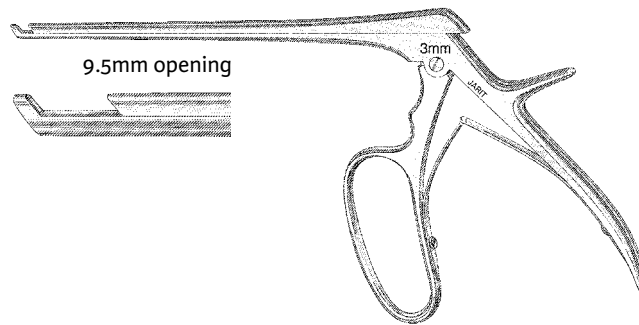

Ferris-Smith Laminectomy Rongeurs

8" (203mm), 40° forward-angle

Catalog #	Description
280-290	3mm bite
280-292	5mm bite

Hardy Sella Punches

7" (178mm) shaft, 2mm bite,
small improved handle

Catalog #	Description
280-295	90° up-bite
280-296	40° up-bite
280-297	90° down-bite
280-298	40° down-bite

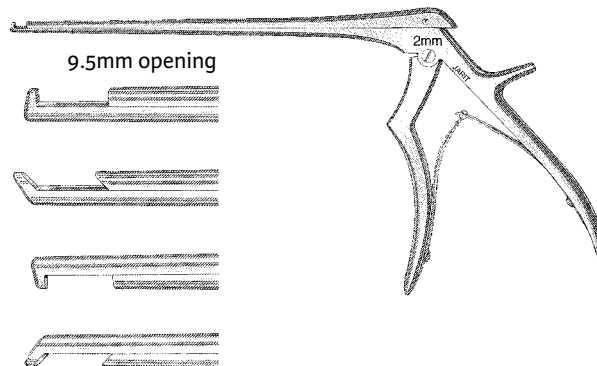

Cushing Pituitary Rongeurs

2 x 10mm bite

5" (127mm) shaft

Catalog #	Description
280-400	Straight
280-401	Up-angled
280-402	Down-angled

6" (150mm) shaft

Catalog #	Description
280-380	Straight
280-381	Up-angled
280-382	Down-angled

7" (180mm) shaft

Catalog #	Description
280-405	Straight
280-406	Up-angled
280-407	Down-angled

9" (230mm) shaft

Catalog #	Description
281-405	Straight
281-406	Up-angled
281-407	Down-angled

11" (280mm) shaft

Catalog #	Description
282-405	Straight
282-406	Up-angled
282-407	Down-angled

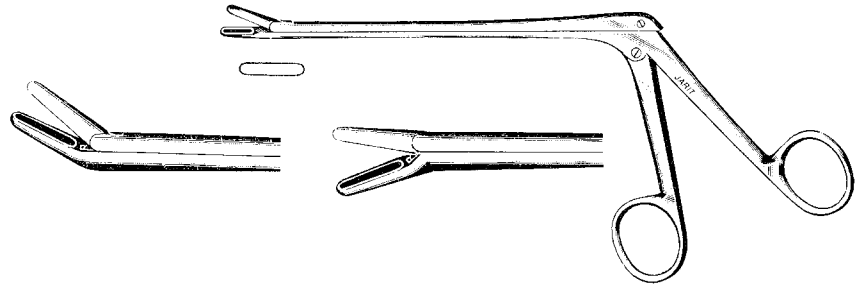

Love Gruenwald Pituitary Rongeurs

3 x 10mm bite

5" (127mm) shaft

Catalog #	Description
280-410	Straight
280-411	Up-angled
280-412	Down-angled

6" (150mm) shaft

Catalog #	Description
280-383	Straight
280-384	Up-angled
280-385	Down-angled

7" (180mm) shaft

Catalog #	Description
280-415	Straight
280-416	Up-angled
280-417	Down-angled

9" (230mm) shaft

Catalog #	Description
281-415	Straight
281-416	Up-angled
281-417	Down-angled

11" (280mm) shaft

Catalog #	Description
282-415	Straight
282-416	Up-angled
282-417	Down-angled

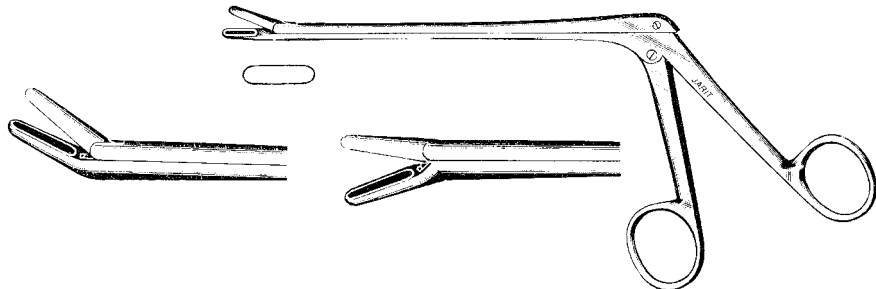

Spurling Pituitary Rongeurs

4 x 10mm bite

5" (127mm) shaft

Catalog #	Description
280-420	Straight
280-421	Up-angled
280-422	Down-angled

6" (150mm) shaft

Catalog #	Description
280-386	Straight
280-387	Up-angled
280-388	Down-angled

7" (180mm) shaft

Catalog #	Description
280-425	Straight
280-426	Up-angled
280-427	Down-angled

9" (230mm) shaft

Catalog #	Description
281-425	Straight
281-426	Up-angled
281-427	Down-angled

11" (280mm) shaft

Catalog #	Description
282-425	Straight
282-426	Up-angled
282-427	Down-angled

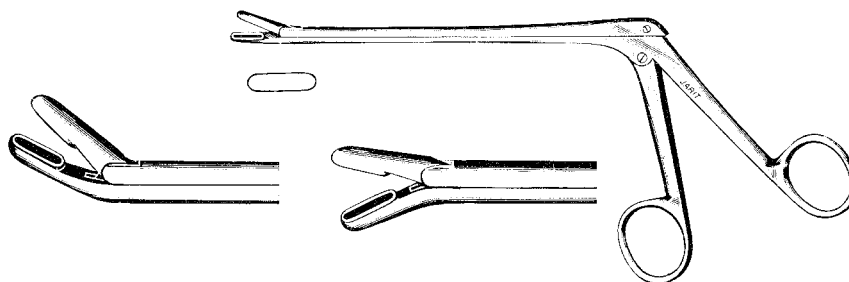

Schlesinger Rongeurs

6" (151mm) shaft, serrated jaws

Catalog #	Description
280-430	2 x 10mm bite, straight
280-431	3 x 10mm bite, straight
280-432	4 x 10mm bite, straight

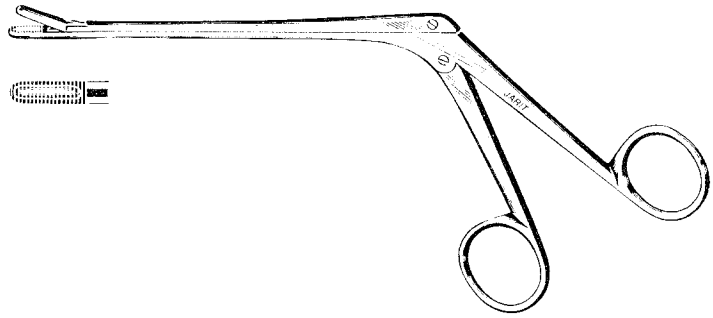

Cloward Style Rongeurs

5 3/8" (135mm) shaft, serrated jaws,
6 x 10mm bite

Catalog #	Description
280-440	Straight
280-441	Up-angled
280-442	Down-angled

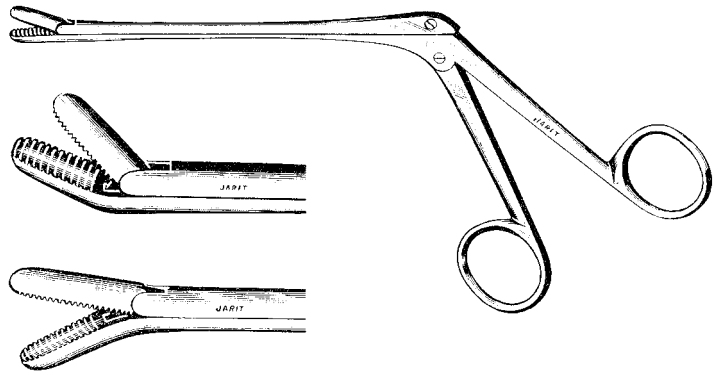

Wilde Rongeurs

fenestrated jaws, straight

5½" (140mm) working length

7" (180mm) working length

9" (229mm) working length

Catalog #	Description
280-450	4mm bite
280-451	5mm bite
280-452	6mm bite

Catalog #	Description
281-450	4mm bite
281-451	5mm bite
281-452	6mm bite

Catalog #	Description
282-450	4mm bite
282-451	5mm bite
282-452	6mm bite

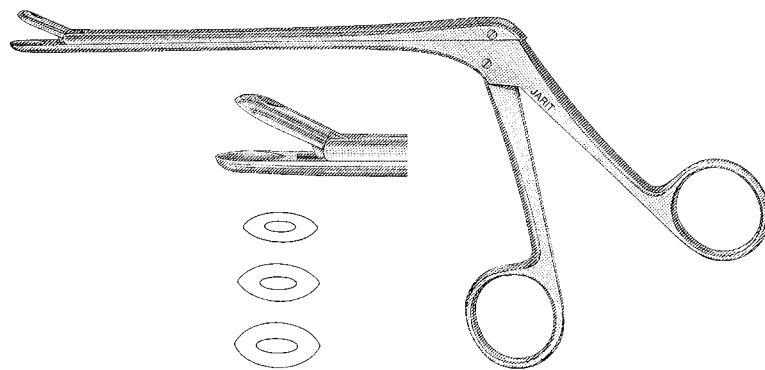

Wilde Rongeur

Catalog #	Description
280-454	4½" (115mm) working length, 6⅞" (175mm) overall length, up-angled, fenestrated, 5mm x 10mm cup jaws

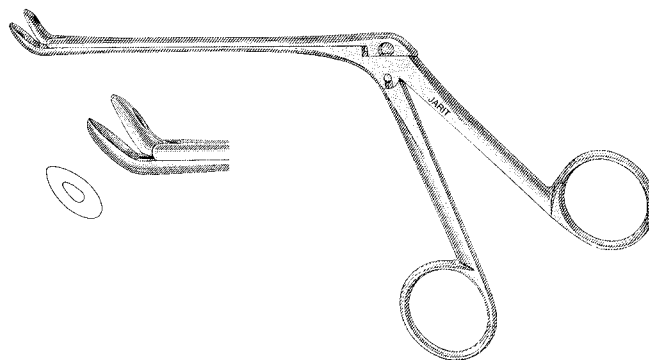

Jackson Rongeur

7" (178mm) shaft, fenestrated jaws

Catalog #	Description
280-460	4 x 8mm bite, 7° up-angled

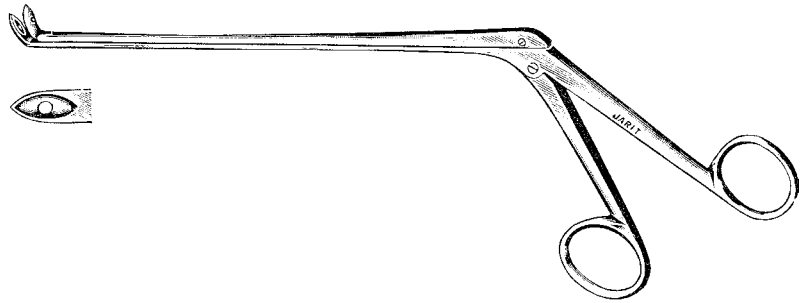

Peapod (Bead-Type) Forceps

5½" (140mm) shaft, 45° up-angled

Catalog #	Description
280-465	2 x 7mm bite
280-466	2.5 x 7mm bite
280-467	3 x 7mm bite

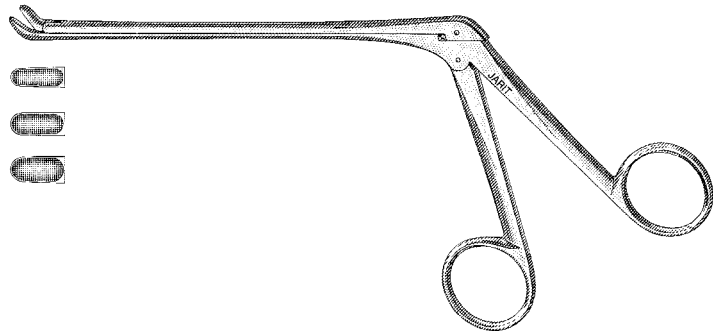

Takahashi Rongeur

5" (130mm) shaft

Catalog #	Description
280-470	4 x 10mm bite

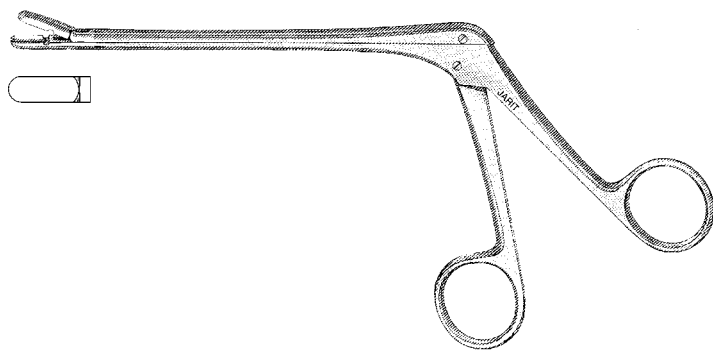

Ferris-Smith Cup Jaw Rongeurs

7" (177mm) shaft, straight

Catalog #	Description
280-500	2 x 10mm bite
280-501	3 x 10mm bite
280-502	4 x 10mm bite
280-503	4 x 8mm bite
280-504	6 x 10mm bite
280-505	6 x 12mm bite

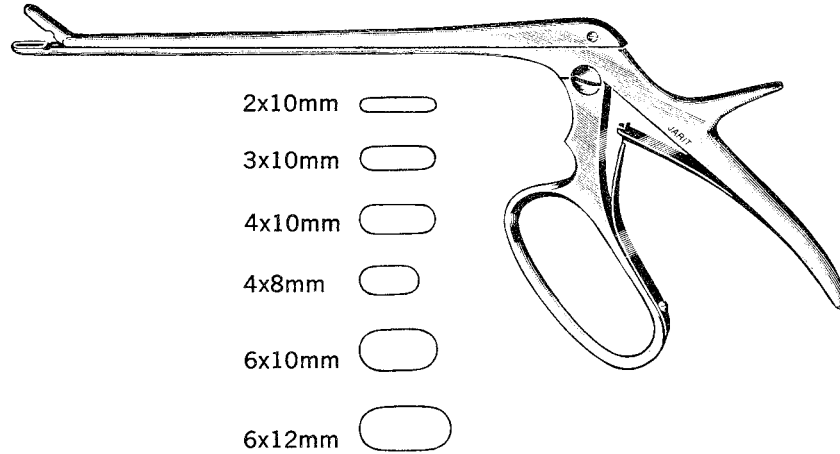

Ferris-Smith Cup Jaw Rongeurs

7" (177mm) shaft, up-angled

Catalog #	Description
280-510	2 x 10mm bite
280-511	3 x 10mm bite
280-512	4 x 10mm bite
280-514	6 x 10mm bite

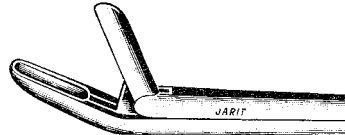

Ferris-Smith Cup Jaw Rongeurs

7" (177mm) shaft, down-angled

Catalog #	Description
280-515	2 x 10mm bite
280-516	3 x 10mm bite
280-517	4 x 10mm bite

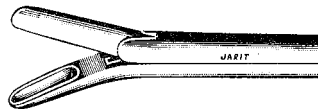

Stokey Cranial Rongeur

7½" (190mm)

Catalog #	Description
280-530	3.6mm bite

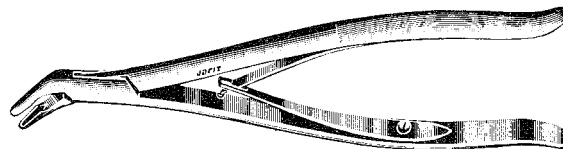

Craig Vertebral Biopsy Set

Catalog #	Description
280-550	Biopsy Set Includes:
280-551	1 socket wrench
280-552	1 needle, 20 gauge
280-553	1 needle, 22 gauge
280-554	1 calibrated cannula
280-555	2 trephine cutters, with teeth
280-556	1 stylet pusher
280-557	1 twist hook
280-558	2 trocars, blunt, calibrated
280-559	1 instrument rack

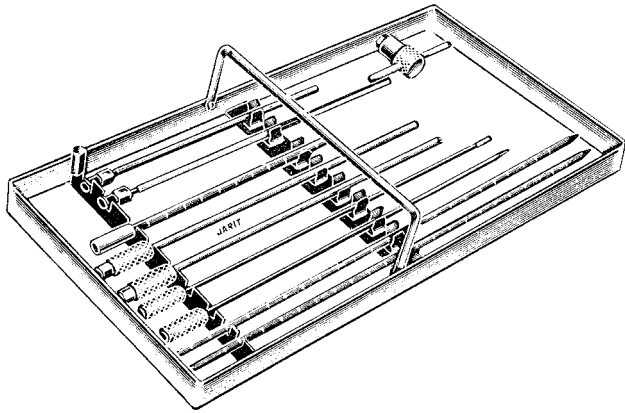

Dandy (Cairns) Scalp Forceps

5¾" (145mm)

Catalog #	Description
285-100	Curved to side

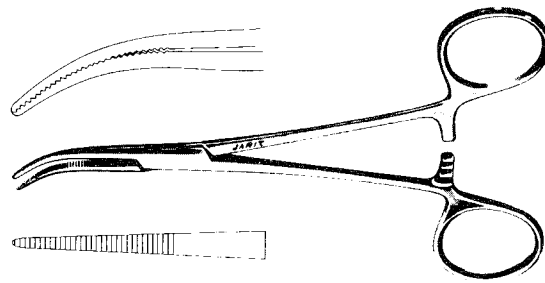

Dandy (Baby) Scalp Forceps

4" (102mm)

Catalog #	Description
285-101	Curved to side

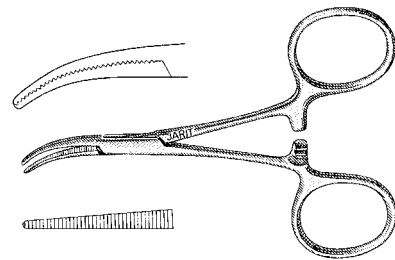

Petit-Point® Jacobson Mosquito Forceps

4⅞" (124mm)

Catalog #	Description
105-088	Straight
105-089	Curved

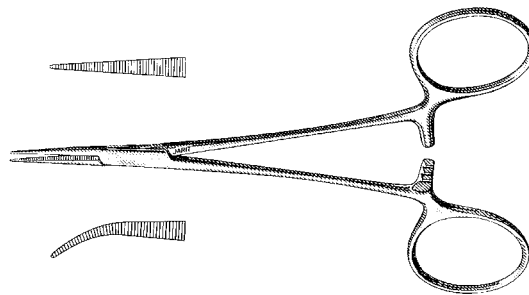

Petit-Point Jacobson Mosquito Forceps

7¼" (185mm), serrated jaws

Catalog #	Description
105-092	Slightly curved
105-093	Fully curved



Petit-Point Mosquito Forceps

6" (152mm)

Catalog #	Description
105-098	Straight
105-099	Curved

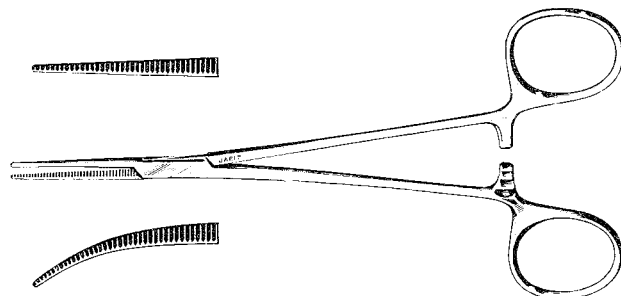

Gemini Artery Clamp

Catalog #	Description
140-330	7½" (190mm)
140-331	8¼" (205mm)
140-332	9" (230mm)

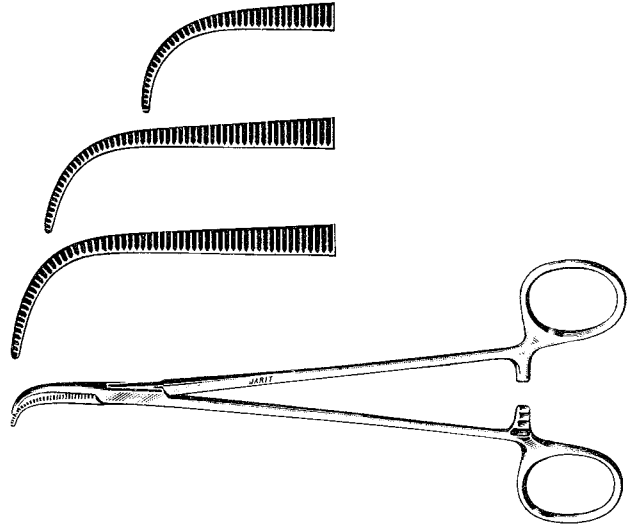

Adson Hemostatic Forceps, Fine Tips

Catalog #	Description
285-103	8½" (215mm), straight
285-104	8½" (215mm), curved
285-105	7½" (190mm), straight
285-106	7½" (190mm), curved

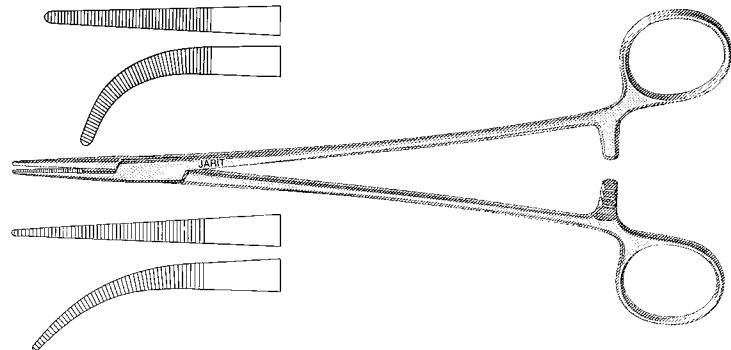

Petit-Point Mosquito Forceps

7¼" (184mm)

Catalog #	Description
285-107	Straight
285-108	Curved

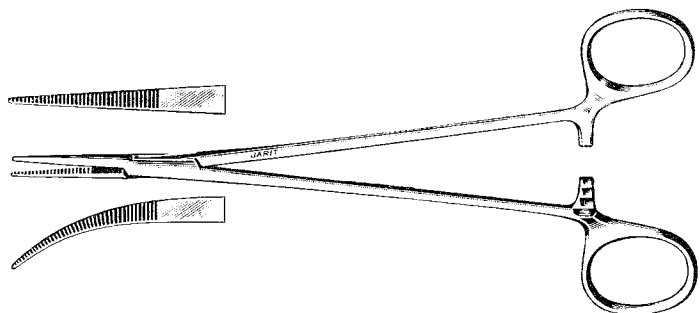

Decker Microsurgical Rongeurs

6" (153mm), 2mm x 6mm cup

Catalog #	Description
285-110	Straight
285-111	Curved left

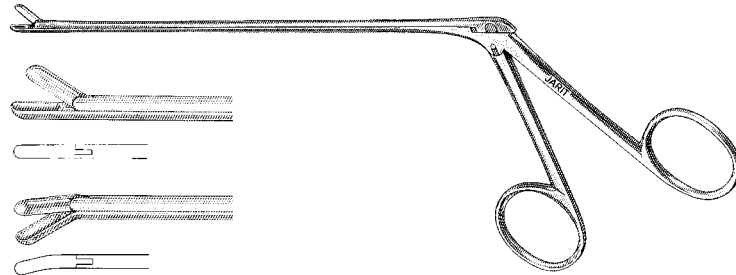

Decker Microsurgical Scissors

6" (153mm)

Catalog #	Description
285-112	Straight

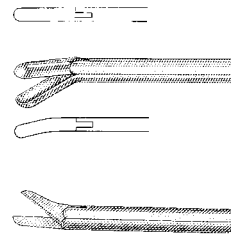

Williams-Type Dissectomy Forceps

5 1/2" (140mm)

Catalog #	Description
285-114	2.3mm wide with 1.0mm bite

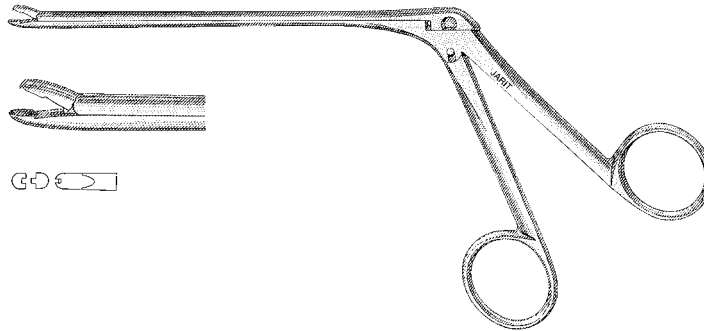

Hoen Alligator Forceps

5 1/2" (140mm)

Catalog #	Description
285-115	Serrated jaws, 1 x 2 teeth

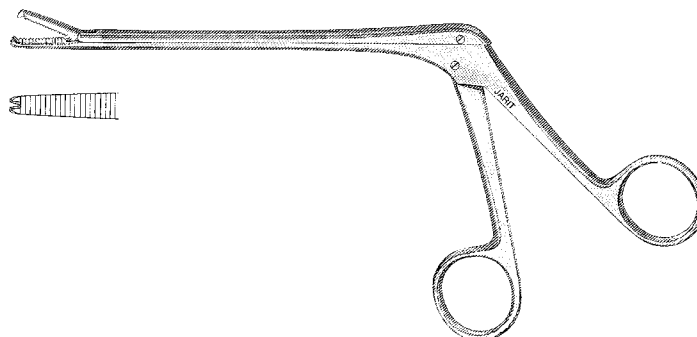

Adson Dressing Forceps, Serrated, (Matte Finish)

Manufactured from high grade German surgical stainless steel which is glass beaded to a matte finish

Catalog #	Description
130-230	4¾" (120mm)
130-231	4¾" (120mm), extra delicate, 0.8mm wide tip

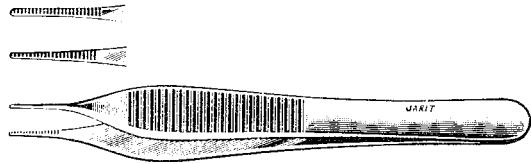

Adson Dressing Forceps, Serrated, (Satin Finish)

Manufactured from high grade German surgical stainless steel which is ground and polished to a satin finish

Catalog #	Description
129-230	4¾" (120mm)

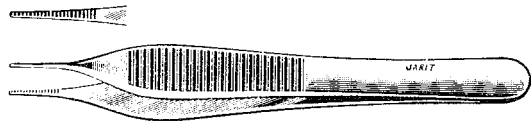

Adson Dressing Forceps

Catalog #	Description
130-232	4¾" (120mm), cross serrated tip

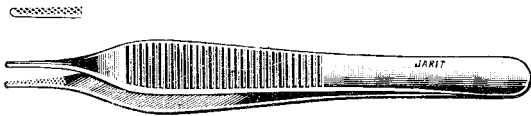

Adson Tissue Forceps, 1 x 2 teeth, (Matte Finish)

Manufactured from high grade German surgical stainless steel which is glass beaded to a matte finish

Catalog #	Description
130-234	4¾" (120mm)
130-235	4¾" (120mm), extra delicate, 0.8mm wide tip
130-237	4⅝" (117mm), angled jaw
130-238	4¾" (120mm), with tying platform

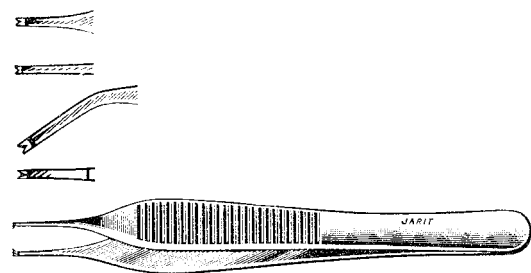

Adson Tissue Forceps, 1 x 2 teeth, (Satin Finish)

Manufactured from high grade German surgical stainless steel which is ground and polished to a satin finish

Catalog #	Description
129-234	4¾" (120mm)

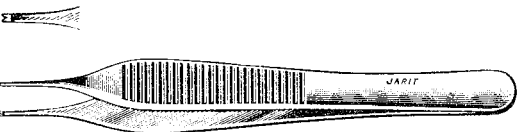

Adson Tissue Forceps, Carb-Bite

Catalog #	Description
130-236	4¾" (120mm)

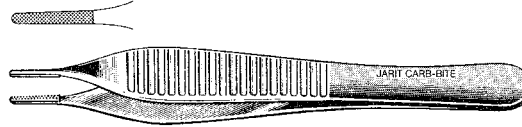

Adson Dressing Forceps

Catalog #	Description
130-243	4¾" (120mm), cross serrated handle

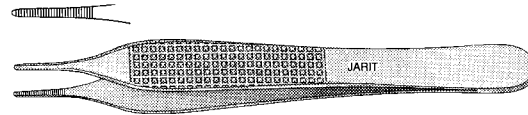

Adson Tissue Forceps

Catalog #	Description
130-244	4¾" (120mm), 1 x 2 teeth, cross serrated handle

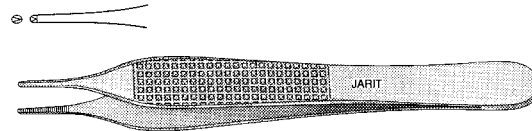

Adson Tissue Forceps

Catalog #	Description
130-245	4¾" (120mm), 1 x 2 teeth, serrated

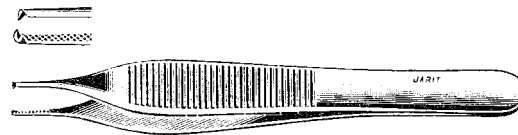

Broli-Adson Forceps

6" (152mm), 1.2mm tips

Catalog #	Description
130-246	Straight, serrated tips
130-247	Curved, serrated tips
130-248	Straight, Stardust tips
130-249	Straight, 1 x 2 teeth



Semken Dressing Forceps

serrated

Catalog #	Description
130-275	5" (126mm)
130-276	6" (152mm)



Semken Tissue Forceps

Catalog #	Description
130-280	5" (126mm), 1 x 2 teeth
130-281	6" (154mm), 1 x 2 teeth
130-282	5" (126mm), 2 x 3 teeth

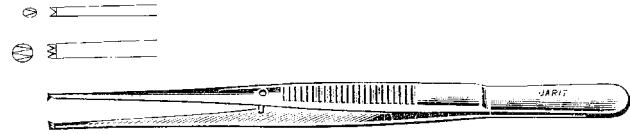

Hoehn Dressing and Tissue Forceps, Bayonet Handle

7³/₄" (200mm)

Catalog #	Description
285-116	Serrated
285-117	1 x 2 teeth



Brain Dressing and Tissue Forceps

7" (176mm), delicate

Catalog #	Description
285-118	Serrated
285-119	1 x 2 teeth

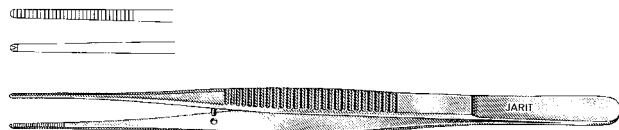

Cushing Dressing Forceps

straight, serrated, scraper end

Catalog #	Description
130-400	6 ³ / ₄ " (170mm), 1.5mm tip
130-445	7 ³ / ₄ " (200mm), 2mm tip

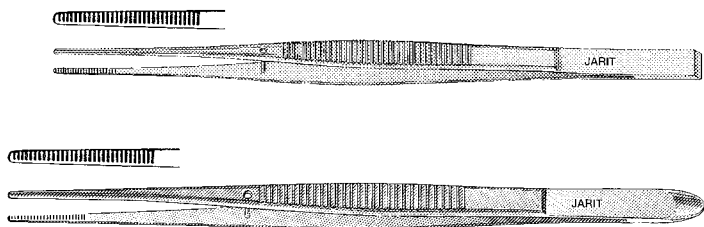

Cushing Tissue Forceps

straight, 1 x 2 teeth, scraper end

Catalog #	Description
130-405	6 ³ / ₄ " (171mm), 1.5mm tip
130-446	7 ³ / ₄ " (200mm), cross serrated, 2mm tip

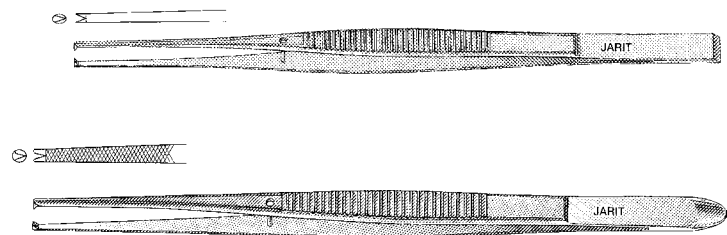

Cushing Dressing Forceps

bayonet, serrated, scraper end

Catalog #	Description
130-410	7¼" (183mm), 1.7mm tip
130-420	7¾" (200mm), 1.9mm tip

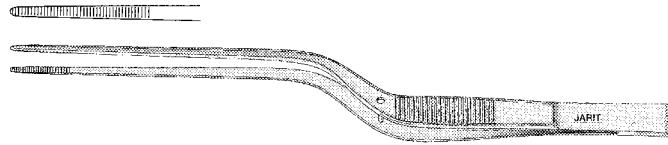

Cushing Tissue Forceps

bayonet, 1 x 2 teeth, scraper end

Catalog #	Description
130-415	7¼" (181mm), 1.7mm tip
130-421	7¾" (200mm), 1.7mm tip

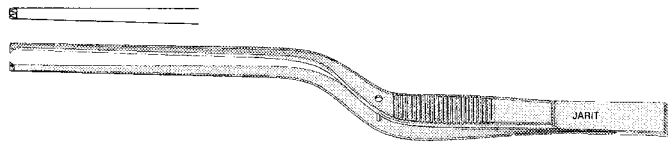

Cushing Dressing and Tissue Forceps

Gutsch handle, straight, scraper end

Catalog #	Description
130-425	7" (178mm), serrated, 1.5mm wide tips
130-430	7" (178mm), 1 x 2 teeth, 1.5mm wide tips
130-435	7" (178mm), 1 x 2 teeth, serrated, 1.5mm wide tips



Cushing Needle and Tissue Pulling Forceps, Carb-Bite

straight, Gutsch handle, scraper end

Catalog #	Description
122-530	7" (176mm), 1.8mm wide x 12mm long tips
122-535	7" (178mm), delicate, 1.6mm wide x 8mm long tips

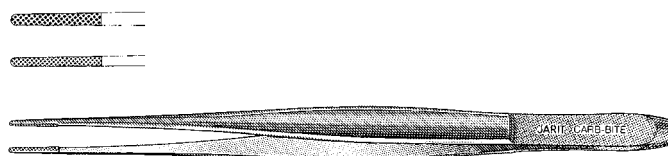

Cushing Tissue Forceps, Carb-Bite

Catalog #	Description
130-417	7" (176mm), angled, 1.8mm wide x 12mm long tips, Gutsch handle, scraper end

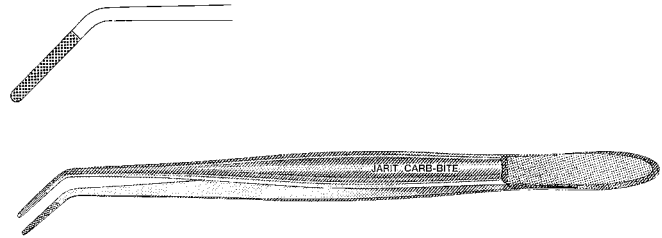

Cushing Tissue Forceps, Carb-Bite

Catalog #	Description
130-418	7 1/2" (191mm), bayonet, 1.8mm wide x 14mm long tips, scraper end

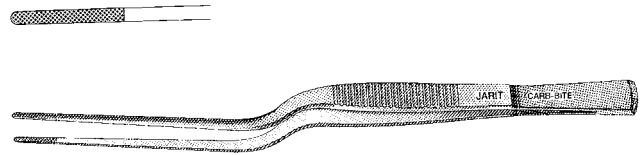

Cushing-Brown Tissue Forceps

Catalog #	Description
130-440	6 3/4" (174mm), straight, double row of 9 x 9 delicate teeth, scraper end

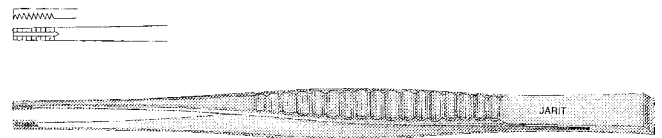

Cushing-Brown Tissue Forceps

Catalog #	Description
130-442	7" (180mm), bayonet, double row of 9 x 9 delicate teeth, scraper end

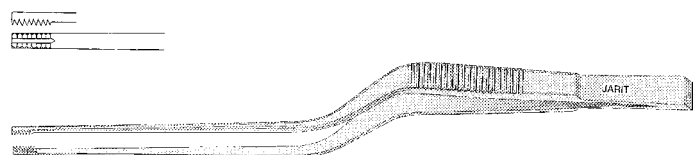

Gerald Dressing Forceps

narrow, 1.3mm wide tips

Catalog #	Description
285-120	7" (175mm), straight
285-121	7" (175mm), curved
285-122	7½" (192mm), bayonet
285-128	9¼" (233mm), straight

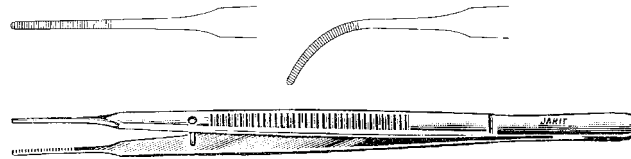

Gerald Tissue Forceps

narrow, 1 x 2 tips

Catalog #	Description
285-125	7" (176mm), straight
285-127	7½" (192mm), bayonet
285-129	9¼" (233mm), straight



Gerald Forceps, Cardio-Grip™ (DeBakey Type Teeth)

straight, 1.2mm wide tips

Catalog #	Description
285-126	7" (180mm)
285-132	7¾" (200mm)
285-130	9½" (240mm)

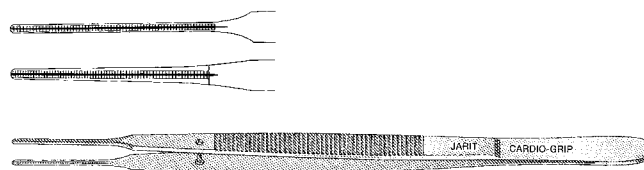

Gerald Dressing Forceps

1.3mm wide tips

Catalog #	Description
285-135	9⅞" (250mm)

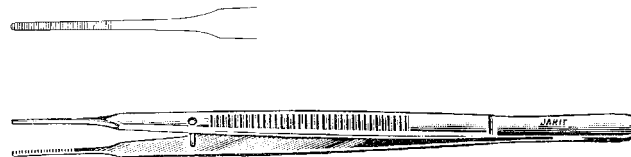

Adson Dressing Forceps

Catalog #	Description
285-140	7¾" (196mm), bayonet, 2.4mm tips



D'Errico Dressing and Tissue Forceps, Bayonet Handle

8¾" (222mm)

Catalog #	Description
285-147	Serrated, 3mm tips
285-148	1 x 2 teeth, 2.5mm tips

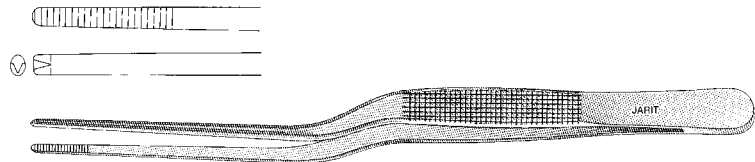

Adson Hypophyseal Forceps

bayonet shape, 7.5mm round cup

Catalog #	Description
285-170	9" (229mm), straight
285-171	8¾" (225mm), Curved up
285-172	8¾" (225mm), Curved down

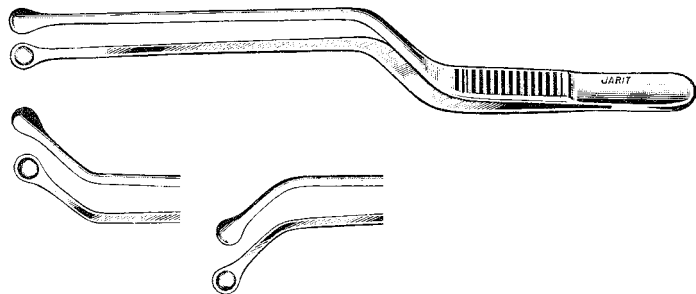

Semken Bipolar Forceps

Catalog #	Description
285-185	6" (152mm), 1.8mm tip, straight, insulated

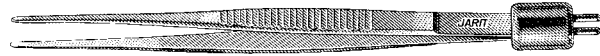

Cushing Bipolar Forceps

Catalog #	Description
285-186	7 1/4" (184mm), 1.5mm tip, straight, insulated

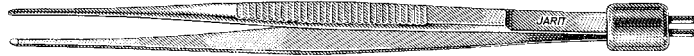

Cushing Bipolar Forceps

Catalog #	Description
285-187	7 1/4" (184mm), 2.2mm tip, bayonet shaped, insulated

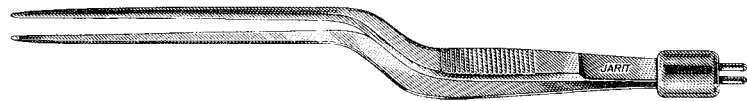

Cushing Bipolar Forceps

Catalog #	Description
285-188	7 1/4" (184mm), 0.8mm micro-tip, bayonet shaped, insulated

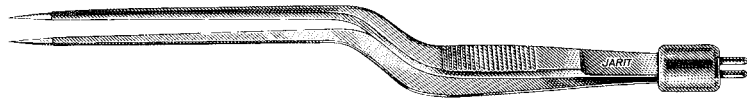

Jacobson Bipolar Forceps

Catalog #	Description
285-189	6 1/4" (159mm), 0.8mm micro-tip, bayonet shaped, insulated



Gerald Bipolar Forceps

Catalog #	Description
285-190	7 1/4" (184mm), 1mm fine tip, straight, insulated



Gerald Bipolar Forceps

Catalog #	Description
285-191	7 1/4" (184mm), 1mm fine tip, bayonet shaped, insulated

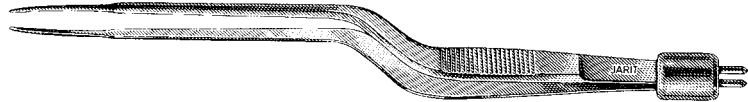

Cushing Bipolar Forceps

Catalog #	Description
285-192	6" (152mm), 1.3mm tip, bayonet shaped, insulated



Jeweler-Type Forceps

Catalog #	Description
285-193	4" (102mm), 0.5mm fine tip, insulated



IMPORTANT: When disconnecting electrosurgical cables from the generator or instrument, always grasp the cables by the connector only. Never pull the cable by the cord. Do not use instruments or cables if the insulation is not fully intact.

Bipolar Cord

Catalog #	Description
285-199	Bipolar Cord (10ft)

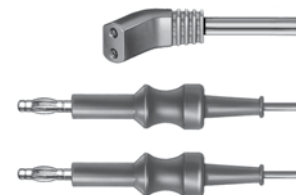

Disposable Bipolar Forceps

Jewelers Disposable Bipolar Forcep (insulated)

Catalog #	Description
286-100	4½" (114mm), straight, 0.4mm tip with 12' cord, 10/per



Jewelers Disposable Bipolar Forcep (non-insulated)

Catalog #	Description
286-101	4½" (114mm), straight, 0.4mm tip with 12' cord, 10/per



Adson Disposable Bipolar Forceps (insulated)

Catalog #	Description
286-102	4¾" (121mm), smooth, 1.0mm tip with 12' cord, 10/per



Adson Disposable Bipolar Forceps (non-insulated)

Catalog #	Description
286-103	4¾" (121mm), smooth, 1.0mm tip with 12' cord, 10/per



Cushing Disposable Bayonet Bipolar Forcep (insulated)

Catalog #	Description
286-104	7½" (190mm), smooth, 3½" (90mm) working length, 0.7mm tip with 12' cord, 10/per



Cushing Disposable Bayonet Bipolar Forcep (non-insulated)

Catalog #	Description
286-105	7½" (190mm), smooth, 3½" (90mm) working length, 0.7mm tip with 12' cord, 10/per



Scoville Disposable Bayonet Bipolar Forcep (insulated)

Catalog #	Description
286-106	7¾" (197mm), smooth, 2¾" (70mm) working length, 1.5mm tip with 12' cord, 10/per



Disposable Bipolar Forceps

Scoville Disposable Bayonet Bipolar Forcep (non-insulated)

Catalog #	Description
286-107	7¾" (197mm), smooth, 2¾" (70mm) working length, 1.5mm tip with 12' cord, 10/per



Hardy Disposable Bayonet Bipolar Forcep (insulated)

Catalog #	Description
286-108	8½" (215mm), smooth, 4½" (115mm) working length, 1.5mm tip with 12' cord, 10/per



Hardy Disposable Bayonet Bipolar Forcep (non-insulated)

Catalog #	Description
286-109	8½" (215mm), smooth, 4½" (115mm) working length, 1.5mm tip with 12' cord, 10/per



Hardy Disposable Bayonet Bipolar Forcep (insulated)

Catalog #	Description
286-110	8½" (215mm), smooth, 4½" (115mm) working length, 0.5mm tip with 12' cord, 10/per



Hardy Disposable Bayonet Bipolar Forcep (non-insulated)

Catalog #	Description
286-111	8½" (215mm), smooth, 4½" (115mm) working length, 0.5mm tip with 12' cord, 10/per



Disposable 12' Bipolar Cord with Banana Pin Connector

Catalog #	Description
286-112	10/per



Frazier Dura Hook

Catalog #	Description
285-200	4 ⁷ / ₈ " (125mm), sharp



Dura Hook

Catalog #	Description
285-202	6 ¹ / ₂ " (165mm), sharp

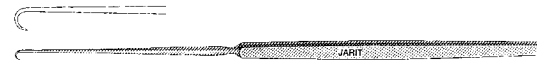

Cushing Dura Hook

Catalog #	Description
285-205	5 ⁵ / ₈ " (142mm), sharp



Lahey Clinic Dura Hook

Catalog #	Description
285-210	5 ¹ / ₄ " (133mm), sharp



Graham Dura Hook

Catalog #	Description
285-215	6 ¹ / ₂ " (166mm), blunt

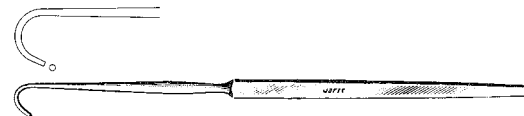

Sachs Dura Hooks

Catalog #	Description
285-219	6" (154mm), sharp
285-220	8 ¹ / ₂ " (218mm), sharp
285-221	8 ¹ / ₂ " (218mm), blunt

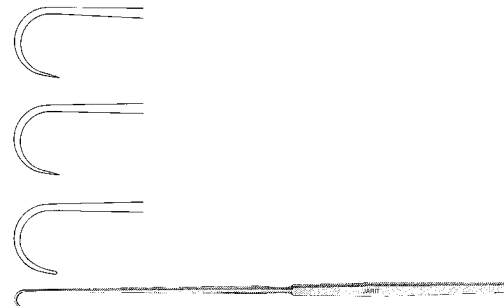

Adson Dura Hook

Catalog #	Description
285-225	7¾" (200mm), 6.5mm long, sharp tip

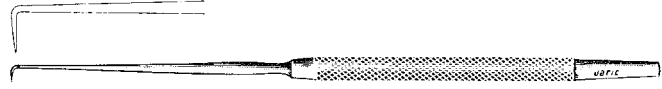

Adson Dura Hook

Catalog #	Description
285-227	8" (202mm), 7mm long, blunt tip

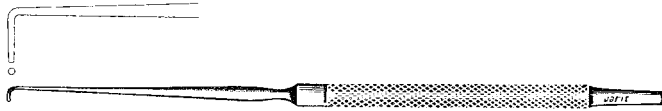

Dandy Nerve Hook

Catalog #	Description
285-230	9" (230mm), 5mm long, blunt tip

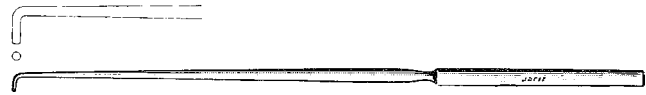

Cushing Gasserian Ganglion Hook

Catalog #	Description
285-233	9" (230mm), 6.1mm long, blunt tip

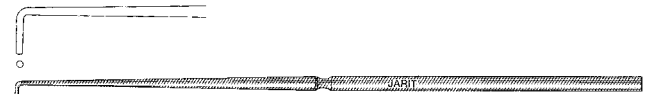

Hoer Nerve Hooks

blunt

Catalog #	Description
285-235	Straight, 9" (230mm), 7mm long tip
285-236	Angled, 8¾" (225mm), 7mm long tip

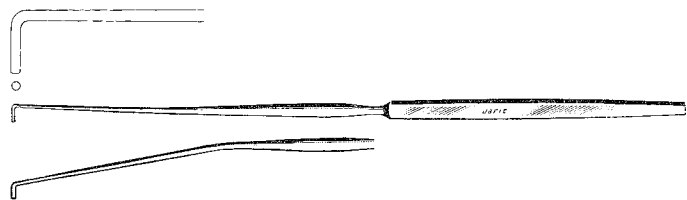

Strully Dura Twist Hook

Catalog #	Description
285-240	6¼" (157mm)



Smithwick Sympathectomy Hook and Dissector

Catalog #	Description
285-315	12¼" (312mm)

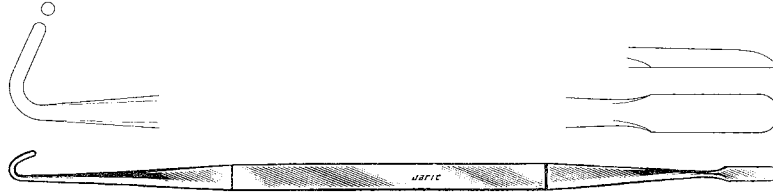

Dissector (Neuro)

Catalog #	Description
285-318	8¾" (222mm), sharp end, blunt blades 6.5mm wide

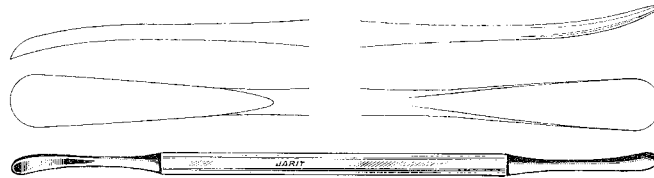

Frazier Dura Separator

Catalog #	Description
285-320	6½" (165mm), 3.2mm wide x 10.5mm length blade



Horsley Dura Separator

Catalog #	Description
285-325	7" (180mm), 7mm wide x 57mm length blade

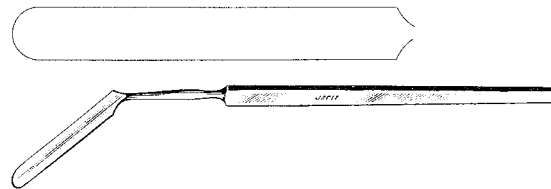

Dorsey Dura Separator

Catalog #	Description
285-327	6" (153mm), grooved blade, 4.75mm wide x 20mm length blade

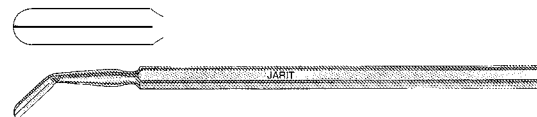

Hoen Dura Separator

6¼" (156mm)

Catalog #	Description
285-330	45° angle, 3.6mm wide x 10mm length blade
285-331	90° angle, 3.6mm wide x 10mm length blade



Sachs Nerve Separator

Catalog #	Description
285-340	7 ³ / ₄ " (196mm), 2.4mm blade

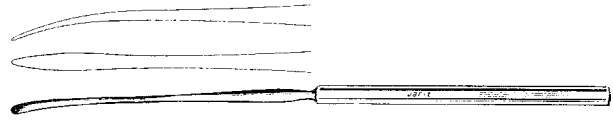

Sachs Dural Separator

Catalog #	Description
285-342	9" (230mm), 6mm wide x 84mm length blade

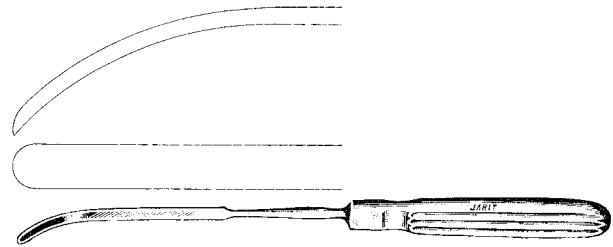

Jarit Periosteal Elevators

6¹/₄" (160mm), curved blade

Catalog #	Description
285-345	Blunt
285-346	Semi-sharp



Adson Periosteal Elevators

6³/₄" (170mm)

Catalog #	Description
285-350	Straight, chisel edge (9.3mm)
285-351	Curved, blunt (6.5mm)
285-352	Curved, semi-sharp (6.5mm)
285-353	Straight, semi-sharp (6.5mm)

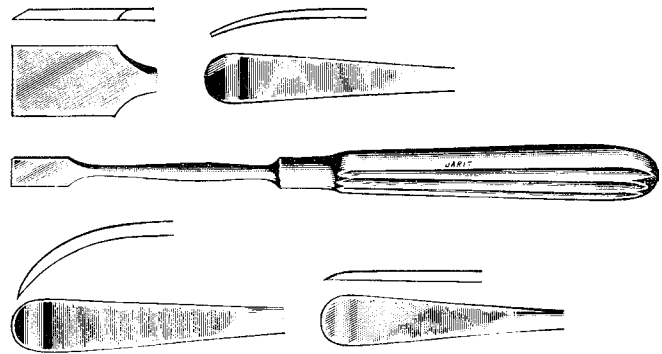

Love-Adson Periosteal Elevator

Catalog #	Description
285-355	6 ¹ / ₂ " (165mm), curved, semi-sharp (5mm)

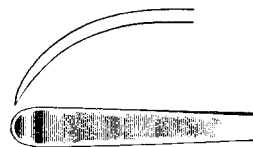

Oldberg Dissector

Catalog #	Description
285-357	7" (178mm), 5.6mm wide blade

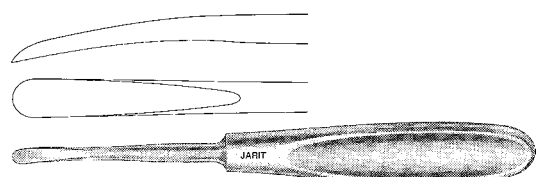

Hoen Periosteal Elevators

Catalog #	Description
285-360	7¼" (183mm), 7mm wide blade
285-361	7½" (192mm), 15mm wide blade
285-362	7½" (192mm), 20mm wide blade



Penfield Dissector

Catalog #	Description
285-365	No. 1: 7" (178mm), broad curved dissector, sharp round spoon

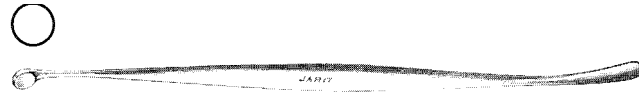

Penfield Dissector

Catalog #	Description
285-366	No. 2: 7¼" (184mm), slightly curved dissector, wax packer



Penfield Dissector

Catalog #	Description
285-367	No. 3: 7¼" (184mm), full curved dissector, wax packer

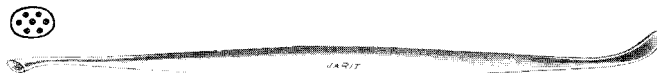

Penfield Dissector

Catalog #	Description
285-368	No. 4: 8" (205mm), slightly curved dissector, light



Penfield Dissector

Catalog #	Description
285-369	No. 5: 11¼" (287mm), slightly curved dissector, double ended, blunt

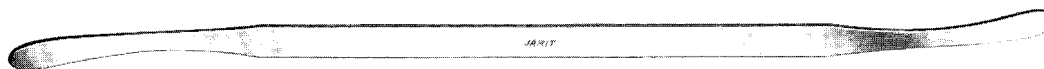

Alderdyce Elevator and Dissector

8½" (216mm)

Catalog #	Description
285-370	6.5mm and 8.5mm widths

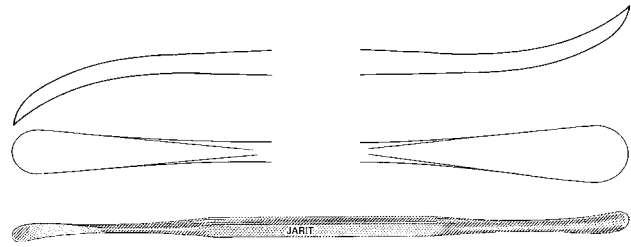

Cushing Wide Sharp Elevators

7½" (190mm), 15.5mm wide

Catalog #	Description
285-375	Convex edge
285-376	Square edge

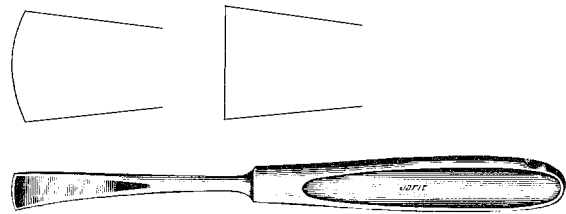

Freer Double-ended Elevators

7¾" (198mm), sharp-blunt blades

Catalog #	Description
285-379	6.5mm wide blades
285-380	5mm wide blades

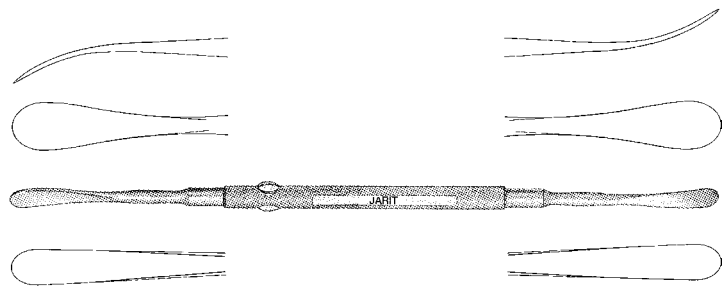

Presbyterian Hospital Double-ended Elevators

7¼" (184mm)

Catalog #	Description
285-381	Straight, 3.5mm and 4.5mm wide blades, blunt
285-382	Curved, 3.3mm and 4.1mm wide blades, blunt

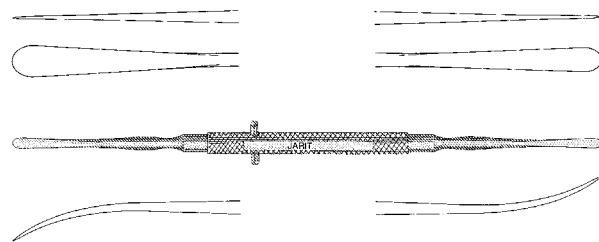

Crile Ganglion Knife and Dissector

8 1/2" (215mm)

Catalog #	Description
285-383	3.3mm knife and 3.3mm dissector, width

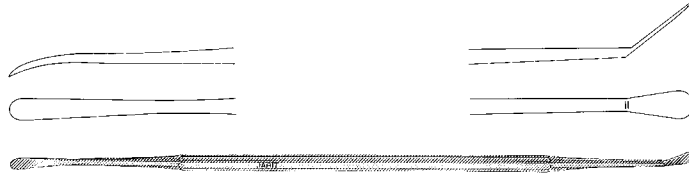

Cushing Periosteal Elevator

7 5/8" (195mm)

Catalog #	Description
285-384	5mm wide blade, sharp

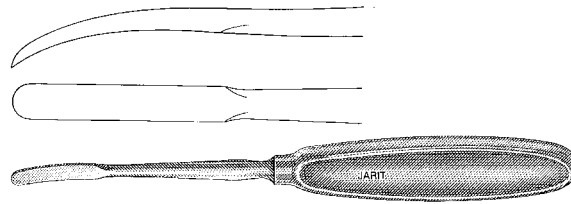

Cushing Staphylorrhaphy Elevators

Catalog #	Description
285-385	8 1/8" (205mm), grooved handle, 6.5mm wide blade

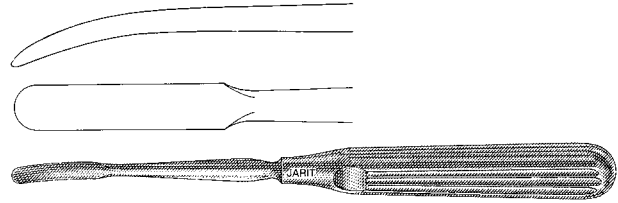

285-386	7 1/2" (190mm), Gutsch handle, 6.5mm wide blade
---------	---

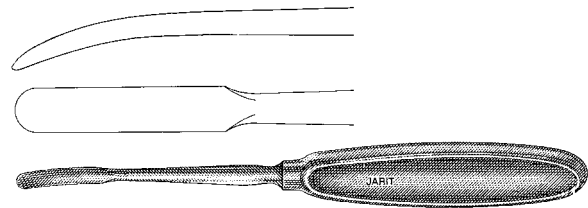

Cushing "Little Joker" Periosteal Elevators

Catalog #	Description
285-388	6" (152mm), hollow handle, 7mm wide blade

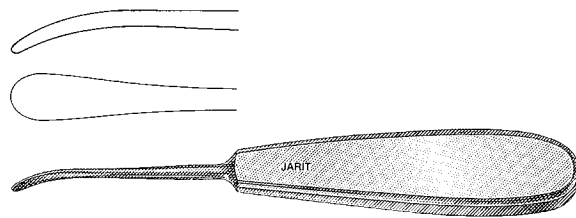

285-389	7 1/2" (190mm), solid handle, 6.5mm wide blade
---------	--

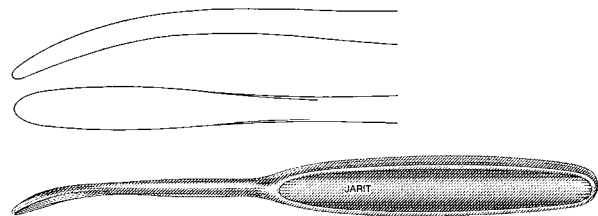

Woodson Elevator and Spatula

10" (254mm)

Catalog #	Description
285-390	2.75mm x 3.3mm wide blades



Woodson Dura Separator and Packer

7" (178mm)

Catalog #	Description
285-391	3mm x 3.32mm wide blades

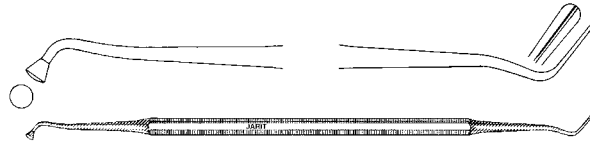

Cloward Style Periosteal Elevators

7³/₄" (198mm), Gutsch handle

Catalog #	Description
285-394	5mm wide blade, sharp
285-395	6.4mm wide blade, sharp
285-396	8mm wide blade, sharp

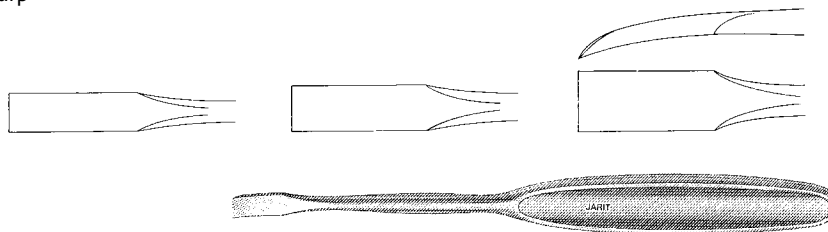

Cloward Style Periosteal Elevator

8" (203mm)

Catalog #	Description
285-397	6mm wide x 10mm long wide blade, sharp

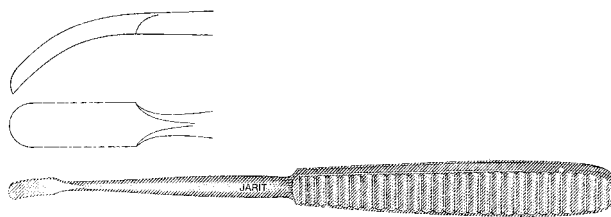

Cushing Periosteal Elevator

Catalog #	Description
285-398	8" (205mm), 6mm wide x 30mm length blade, sharp

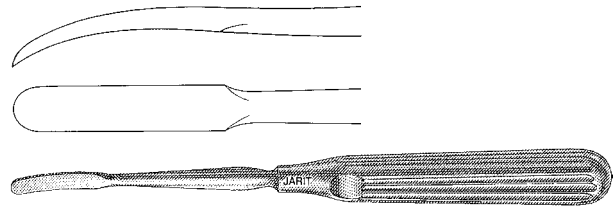

Cushing Decompression Retractor

Catalog #	Description
285-405	8 3/4" (220mm), 12mm wide blade

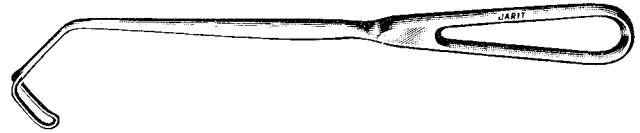

Sachs Vein Retractors

8 3/4" (220mm), angled

Catalog #	Description
285-411	8 3/4" (220mm), smooth, 12mm wide blade
285-412	8 1/2" (215mm), toothed, 16mm wide blade

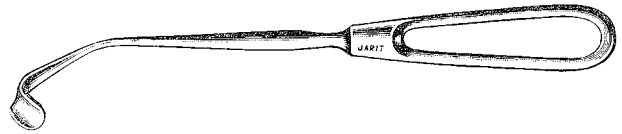

Love Nerve Root Retractor

Catalog #	Description
285-420	7 3/4" (195mm), straight, 7mm wide blade



Love Nerve Root Retractor

Catalog #	Description
285-421	6 1/2" (167mm), 45° angle, 7mm wide blade

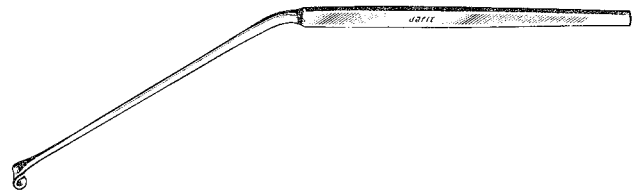

Love Nerve Root Retractor

Catalog #	Description
285-422	3 7/8" (98mm), 90° angle, 7mm wide blade

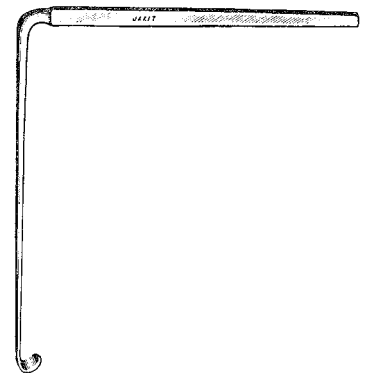

D'Errico Nerve Root Retractor

Catalog #	Description
285-425	8¾" (220mm), 7.2mm wide blade

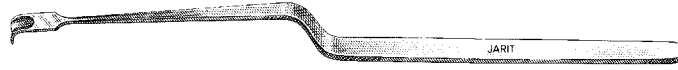

Scoville Nerve Root Retractor

Catalog #	Description
285-430	9¼" (235mm), straight, 7.8mm wide blade



Scoville Nerve Root Retractor

Catalog #	Description
285-431	7" (178mm), angular, 8mm wide blade

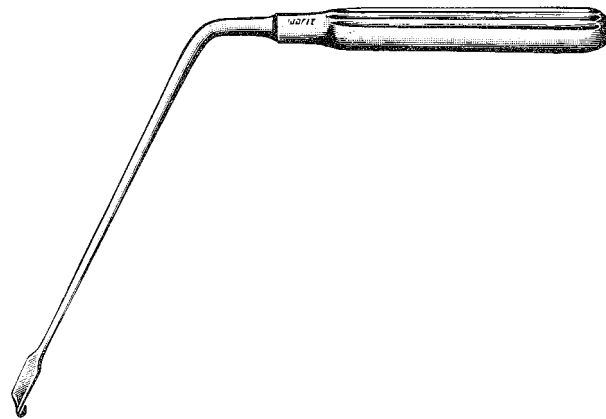

Holscher Nerve Root Retractor

Catalog #	Description
285-433	9¾" (245mm), 6.5mm wide blade



Holscher Nerve Root Retractor

Catalog #	Description
285-434	9¾" (245mm), 13mm wide blade

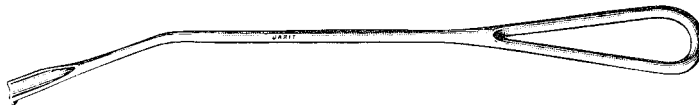

Campbell Nerve Root Retractor

Catalog #	Description
285-435	8¾" (224mm), 10.5mm wide blade

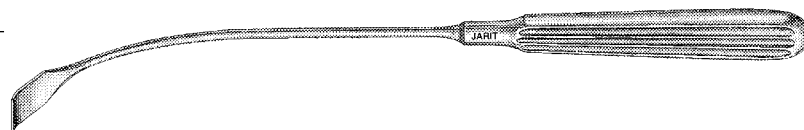

Frazier Suction Tubes

7½" (193mm), angular,
working length 4" (102mm)

Catalog #	Description
285-449	5 French
285-450	6 French
285-451	7 French
285-452	8 French
285-453	9 French
285-454	10 French
285-455	11 French
285-456	12 French
285-457	14 French
285-458	15 French

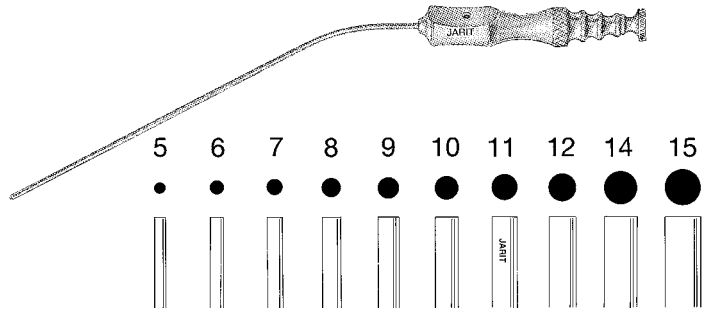

*For stylets (angled Frazier Suction Tube only)
add the letter "S" to catalog number.

Frazier Suction Tubes

7½" (192mm), straight,
working length 5¼" (133mm)

Catalog #	Description
285-460	6 French
285-461	7 French
285-462	8 French
285-463	9 French
285-464	10 French
285-465	11 French
285-466	12 French

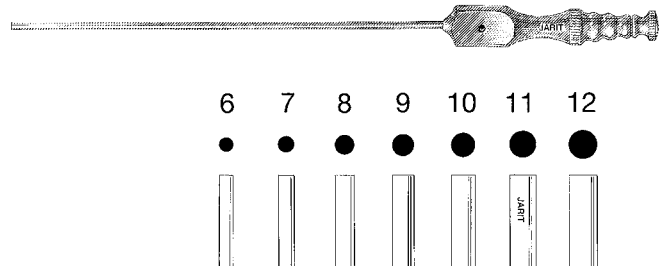

Frazier Suction Tubes

9" (231mm), straight,
working length 6¾" (171mm)

Catalog #	Description
285-470	6 French
285-471	7 French
285-472	8 French
285-473	9 French
285-474	10 French
285-475	11 French
285-476	12 French

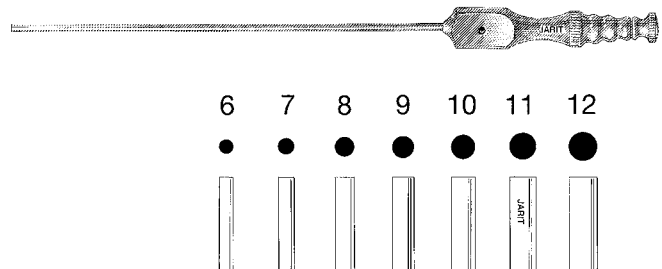

Frazier Suction Tubes

7½" (190mm), angular,
working length 6½" (165mm)

Catalog #	Description
285-477	7 French
285-478	9 French
285-479	11 French

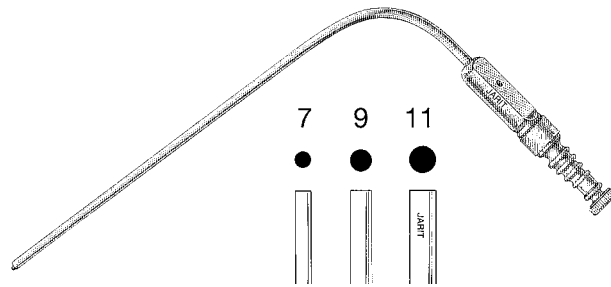

*For stylets (angled Frazier Suction Tube only)
add the letter "S" to catalog number.

Baron Suction Tubes

6½" (165mm), angular,
working length 4" (100mm)

Catalog #	Description
285-480	3 French
285-482	5 French
285-484	7 French

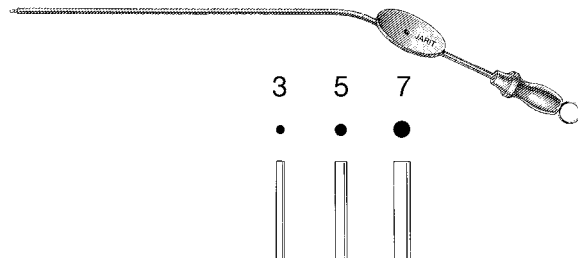

285-STY-480 Replacement Stylet

Adson Suction Tubes

12 French

Catalog #	Description
285-490	5⅛" (130mm)
285-492	7¾" (200mm)

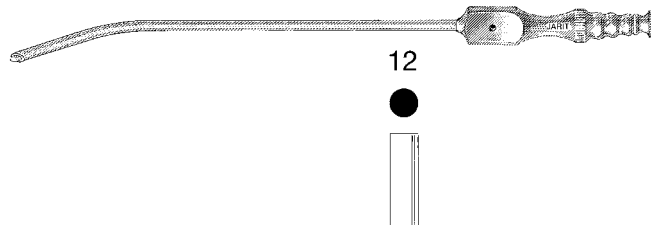

Adson Cannula, Open End

9 French, graduated in CM

Catalog #	Description
285-495	3⅞" (100mm) working length
285-496	5½" (140mm) working length



Elsberg Cannula, 3-Hole Closed End

4⅜" (110mm) working length, luer lock

Catalog #	Description
285-497	5 French
285-498	7 French
285-499	9 French



Children's Hospital Spatula

Catalog #	Description
285-530	8½" (218mm), 14mm wide blade

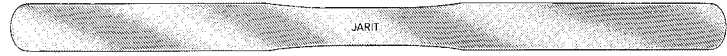

Mayfield Spatula

Catalog #	Description
285-531	8" (205mm), 22mm wide blade

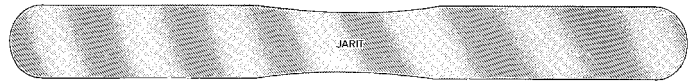

Scoville Spatulas

8" (204mm), double-ended

Catalog #	Description
285-533	Small: 10 and 13mm wide blades
285-534	Large: 16 and 19mm wide blades

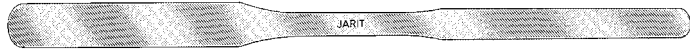

Davis Spatulas

7" (178mm), malleable, German silver

Catalog #	Description
285-540	¼" (6mm) wide
285-541	⅜" (9mm) wide
285-542	½" (13mm) wide
285-543	⅝" (16mm) wide
285-544	¾" (19mm) wide
285-545	1" (25mm) wide
285-546	1¼" (32mm) wide
285-547	1½" (38mm) wide



Cushing Spatulas

double-ended

Catalog #	Description
285-550	6½" (168mm), 13mm and 19mm wide blades
285-551	7¾" (197mm), 19 and 25mm wide blades



Jansen Retractors

3" (76mm)

Catalog #	Description
290-100	3 x 3 sharp prongs, 13mm deep
290-101	3 x 3 blunt prongs, 13mm deep

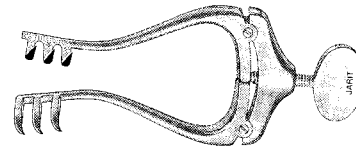

Jansen Retractor

3¾" (94mm)

Catalog #	Description
290-102	4 x 4 blunt prongs, 22mm deep

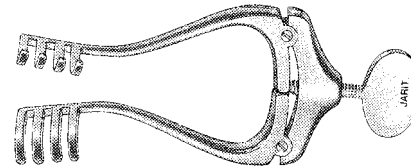

Scalp Retractor

5¼" (133mm), curved arms to fit contour of skull

Catalog #	Description
290-120	3 x 4 blunt prongs, 17.5mm deep

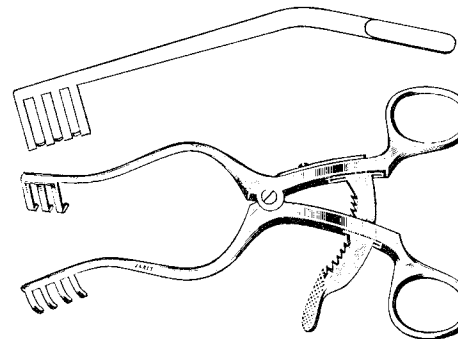

Anderson-Adson Scalp Retractor

7¾" (197mm), angled arms

Catalog #	Description
290-122	4 x 4 sharp prongs, 16mm deep

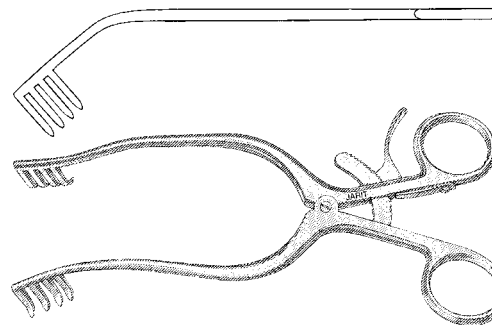

Miskimon Cerebellar Retractor

7¾" (198mm), angled arms

Catalog #	Description
290-125	7 x 7 sharp prongs, 34mm deep

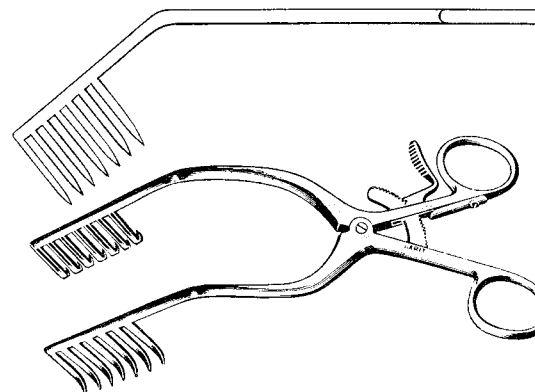

Weitlaner Retractor, (Satin Finish)

Manufactured from high grade German surgical stainless steel which is ground and polished to a satin finish

Catalog #	Description
205-140	4 ³ / ₈ " (110mm), 2 x 3 sharp prongs, 15mm deep
205-141	4 ³ / ₈ " (110mm), 2 x 3 blunt prongs, 15mm deep
205-150	5 ³ / ₈ " (135mm), 3 x 4 sharp prongs, 17mm deep
205-151	5 ³ / ₈ " (135mm), 3 x 4 blunt prongs, 17mm deep
205-155	6 ¹ / ₂ " (165mm), 3 x 4 sharp prongs, 18mm deep
205-156	6 ¹ / ₂ " (165mm), 3 x 4 blunt prongs, 18mm deep
205-160	7 ³ / ₄ " (195mm), 3 x 4 sharp prongs, 20mm deep
205-161	7 ³ / ₄ " (195mm), 3 x 4 blunt prongs, 20mm deep
205-165	9 ¹ / ₂ " (240mm), 3 x 4 sharp prongs, 27mm deep
205-166	9 ¹ / ₂ " (240mm), 3 x 4 blunt prongs, 27mm deep

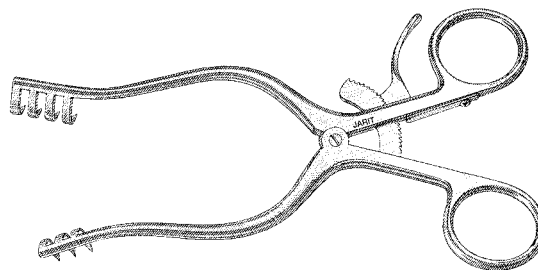

Weitlaner Retractor, (Matte Finish)

Manufactured from high grade German surgical stainless steel which is glass beaded to a matte finish

Catalog #	Description
204-140	4 ³ / ₈ " (110mm), 2 x 3 sharp prongs, 15mm deep
204-141	4 ³ / ₈ " (110mm), 2 x 3 blunt prongs, 15mm deep
204-150	5 ³ / ₈ " (135mm), 3 x 4 sharp prongs, 17mm deep
204-151	5 ³ / ₈ " (135mm), 3 x 4 blunt prongs, 17mm deep
204-155	6 ¹ / ₂ " (165mm), 3 x 4 sharp prongs, 18mm deep
204-156	6 ¹ / ₂ " (165mm), 3 x 4 blunt prongs, 18mm deep
204-160	7 ³ / ₄ " (195mm), 3 x 4 sharp prongs, 20mm deep
204-161	7 ³ / ₄ " (195mm), 3 x 4 blunt prongs, 20mm deep
204-165	9 ¹ / ₂ " (240mm), 3 x 4 sharp prongs, 27mm deep
204-166	9 ¹ / ₂ " (240mm), 3 x 4 blunt prongs, 27mm deep

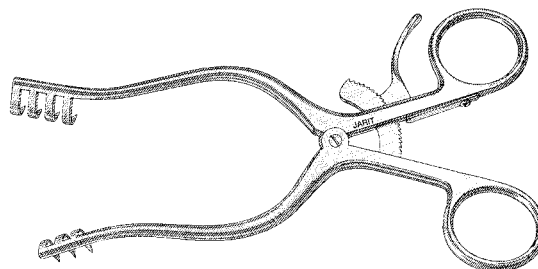

Weitlaner Retractor Replacement Parts

Catalog #	Description
205-SPS-140	Replacement Spring and Screw
205-SPS-141	Replacement Spring and Screw
205-SPS-150	Replacement Spring and Screw
205-SPS-151	Replacement Spring and Screw
205-SPS-155	Replacement Spring and Screw
205-SPS-156	Replacement Spring and Screw
205-SPS-160	Replacement Spring and Screw
205-SPS-161	Replacement Spring and Screw

Weitlaner Retractors

hinged blades

Catalog #	Description
205-175	5½" (140mm), 3 x 4 sharp prongs, 18mm deep
205-176	5½" (140mm), 3 x 4 blunt prongs, 18mm deep
205-180	6½" (162mm), 3 x 4 sharp prongs, 18mm deep
205-181	6½" (162mm), 3 x 4 blunt prongs, 18mm deep
205-190	8¼" (210mm), 3 x 4 sharp prongs, 20mm deep

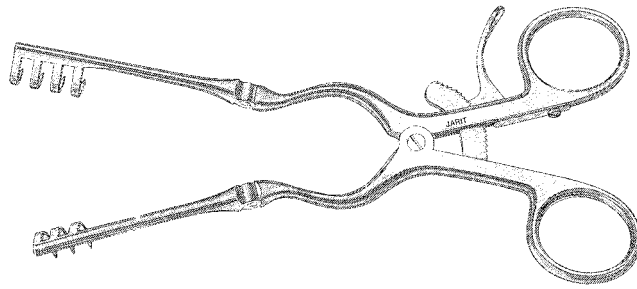

Adson Cerebellar Retractors

7¾" (140mm), straight

Catalog #	Description
205-200	4 x 4 sharp prongs, 22mm deep
205-201	4 x 4 blunt prongs, 22mm deep

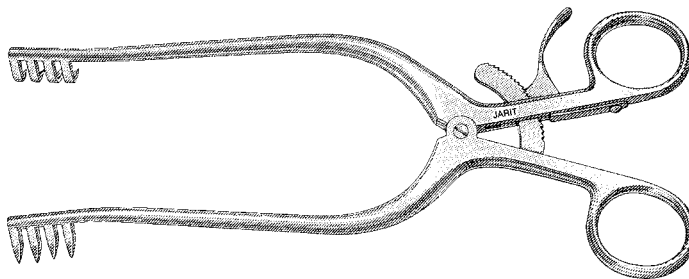

Adson Cerebellar Retractors

7½" (188mm), angled

Catalog #	Description
205-205	4 x 4 sharp prongs, 22mm deep
205-206	4 x 4 blunt prongs, 22mm deep

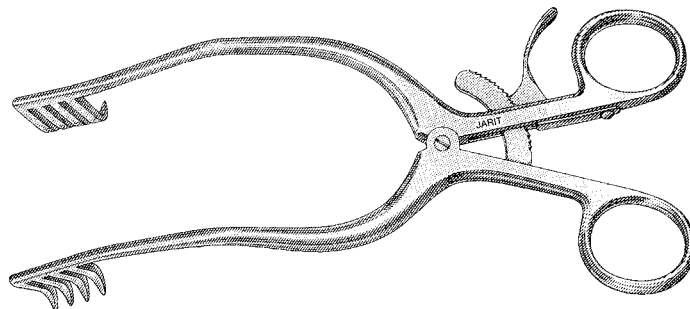

Beckman Thyroid Retractor

Catalog #	Description
205-209	9 1/2" (240mm), 3 x 4 sharp prongs, 1 1/8" deep (28mm)
205-210	12 3/8" (316mm), 4 x 4 sharp prongs, 1" deep (24mm)

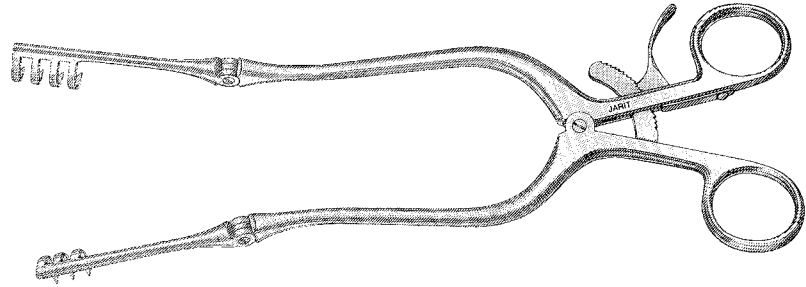

Beckman-Adson Laminectomy Retractors

12 1/4" (309mm)

Catalog #	Description
205-220	4 x 4 sharp prongs, 1 1/8" x 1 1/8" (28mm x 29.5mm)
205-221	4 x 4 blunt prongs, 1 1/8" x 1 1/8" (28mm x 29.5mm)
205-225	4 x 4 sharp prongs, 1 1/8" x 1 7/8" (28mm x 48mm)
205-226	4 x 4 blunt prongs, 1 1/8" x 1 7/8" (28mm x 48mm)

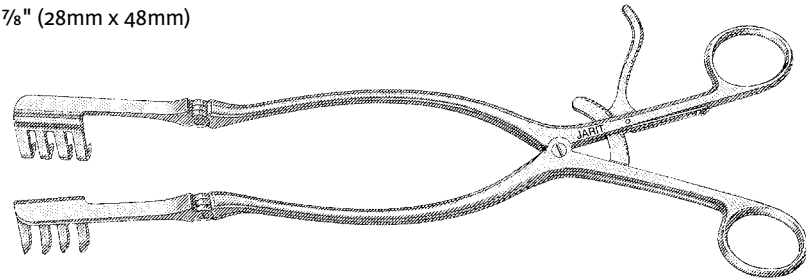

Beckman-Eaton Laminectomy Retractor

12 3/4" (324mm)

Catalog #	Description
205-230	7 x 7 sharp prongs, 1 5/8" x 2" (42mm x 50mm)

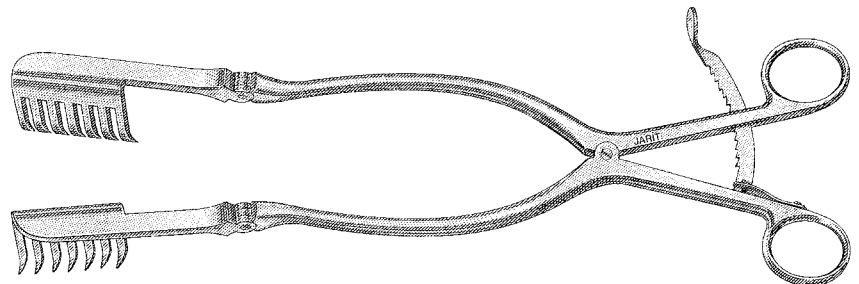

Meyerding Laminectomy Retractors

7³/₄" (194mm)

Catalog #	Description
205-240	Blades 1" x 1 ¹ / ₄ " deep (25mm x 31mm)
205-242	Blades 1" x 2 ¹ / ₈ " deep (25mm x 54mm)
205-244	Blades 3 ³ / ₄ " x 2 ³ / ₈ " deep (19mm x 63mm)
205-245	Blades 1" x 2 ³ / ₈ " deep (25mm x 60mm)

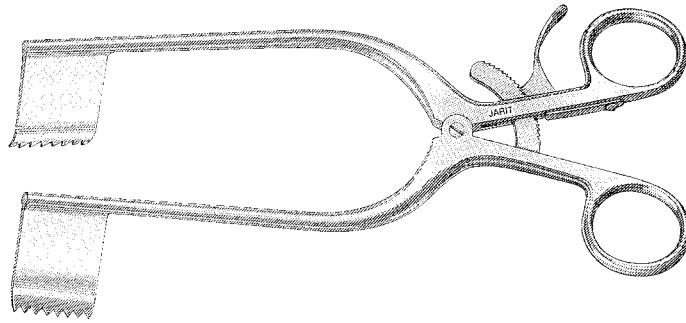

Markham-Meyerding Hemilaminectomy Retractor

6³/₄" (170mm), blade on right side

Catalog #	Description
205-255	Blades 1" x 2 ¹ / ₈ " deep (25mm x 63mm)

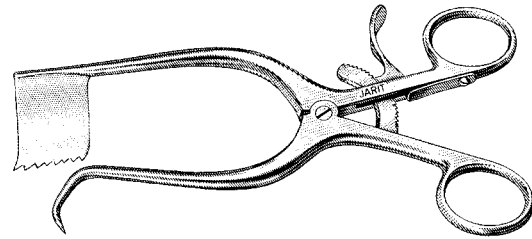

Markham-Meyerding Hemilaminectomy Retractor

6³/₄" (170mm), blade on left side

Catalog #	Description
205-256	Blades 1" x 2 ¹ / ₂ " deep (25mm x 66mm)

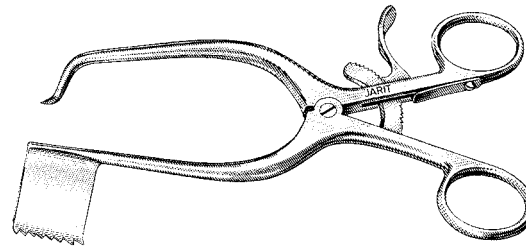

Lamina Spreader

Catalog #	Description
290-145	11" (277mm), concave blades, 16mm wide

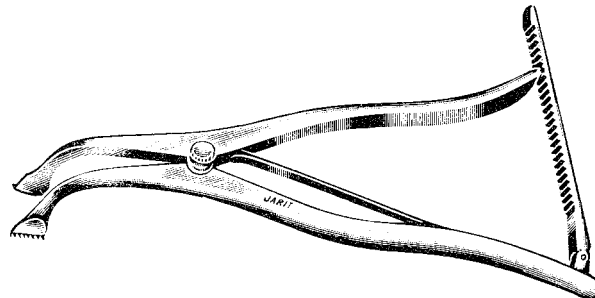

Inge Lamina Spreader
with teeth

Catalog #	Description
290-150	10¼" (260mm), adult size, 11mm wide blades
290-152	6½" (165mm), child size, 7.2mm wide blades
290-THS-152	Replacement Thumb Screw
290-SPS-152	Replacement Spring and Screws

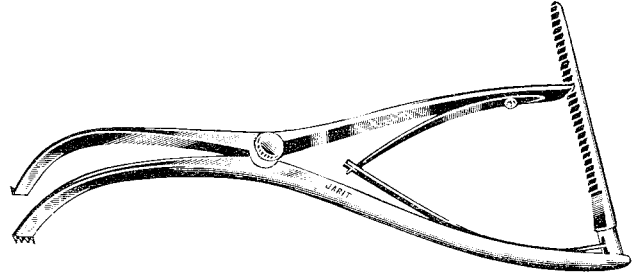

Inge Lamina Spreader
without teeth

Catalog #	Description
290-153	6½" (164mm), child size, 7.3mm wide blades

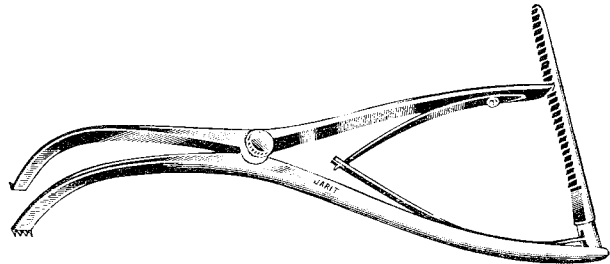

Cloward Style Cervical Spreader
with teeth

Catalog #	Description
290-166	6¼" (156mm), improved model

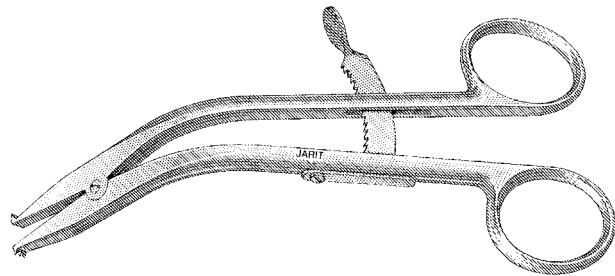

Cloward Style Blade Retractor
3¼" (83mm) long blades

Catalog #	Description
290-175	7¾" (188mm), 18mm wide
290-176	7¾" (188mm), 20mm wide
290-177	7¾" (188mm), 23mm wide

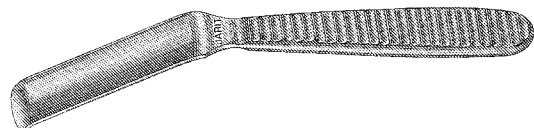

Taylor Spinal Retractors

7¼" (184mm)

Catalog #	Description
290-180	1¼" x 3" blade (32mm x 76mm)
290-181	1¼" x 4" blade (32mm x 103mm)

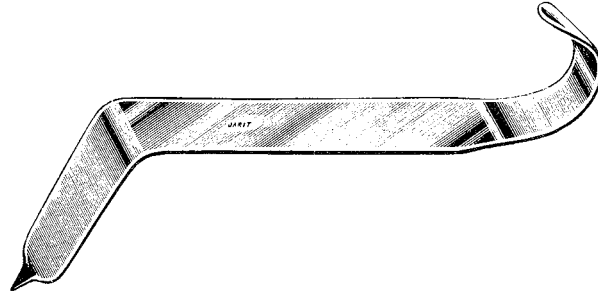

Hoehn Hemilaminectomy Retractor

10" (254mm)

Catalog #	Description
290-190	Sets consist of 1 ea. retractor body 1 pair small blades, left and right 1 pair large blades, left and right
290-SBL-190LL	Replacement Small Blade Left
290-SBL-190IR	Replacement Small Blade Right
290-BLD-190	Replacement Set of 4 Blades
290-SBL-190	Replacement Small Blades
290-LBL-190LL	Replacement Large Blade Left
290-LBL-190IR	Replacement Large Blade Right
290-LBL-190	Replacement Large Blades

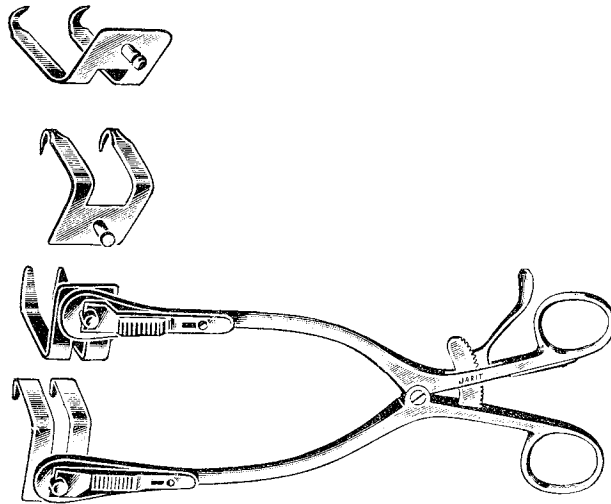

Seletz-Gelpi Laminectomy Retractor

Catalog #	Description
290-200	6½" (165mm), arm length 2¼" (57mm) from bend

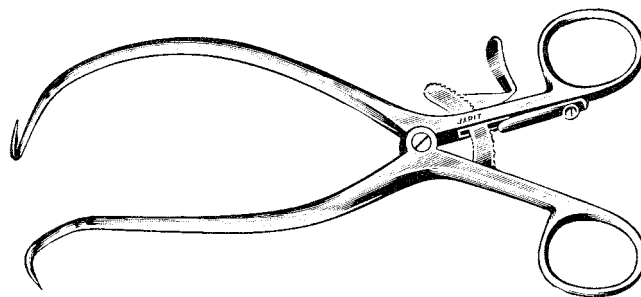

Scoville Hemilaminectomy Retractor Frame

Catalog #	Description
290-210	Overall opening: 7½" (190mm) Spread: 5¾" (145mm) Arm length: 5½" (140mm)
290-TSG-210	Thumbscrew and Gear

Haverfield-Scoville Hemilaminectomy Retractor Frame

Catalog #	Description
290-220	Overall opening: 7½" (190mm) Spread: 5¾" (145mm) Arm length: 5¾" (146mm)
290-TSG-210	Thumbscrew and Gear

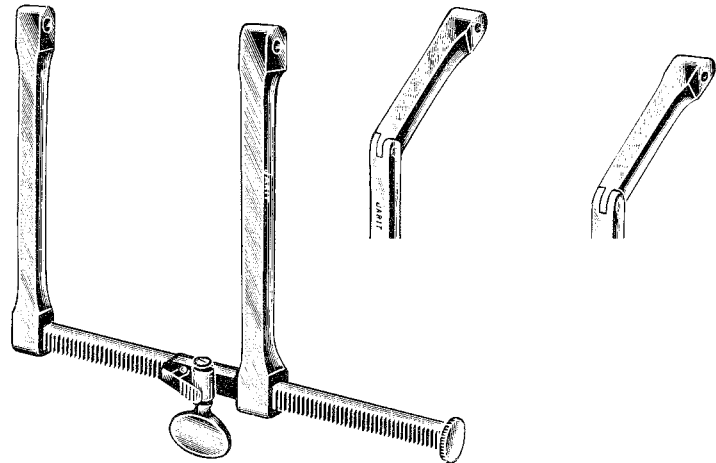

Scoville Blades

hook style

Catalog #	Description
290-211	2" deep (51mm)
290-212	3" deep (76mm)
290-213	2" deep (51mm), with cross bar
290-214	2¾" deep (70mm), with cross bar
290-KNS-212	Replacement Knurled Sleeve

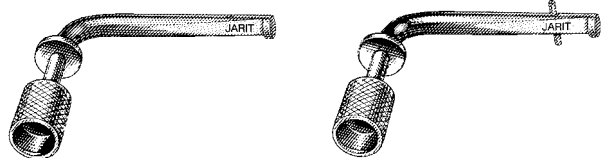

Scoville Blades

solid

Catalog #	Description
290-215	1" wide x 2 1/2" deep (25mm x 64mm)
290-216	2" wide x 2 1/2" deep (51mm x 64mm)
290-217	1 1/4" wide x 2 5/8" deep (32mm x 67mm)
290-218	1" wide x 3 1/2" deep (25mm x 89mm)

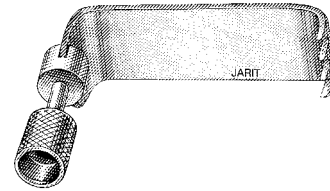

Scoville Blades

4 prongs

Catalog #	Description
290-221	1 1/2" wide x 1 5/8" deep (38mm x 41mm)
290-222	1 7/8" wide x 2 5/8" deep (48mm x 67mm)

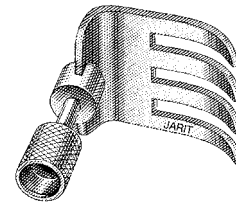

Meyerding Blades

Catalog #	Description
290-225	1" wide x 2 1/4" deep (25mm x 57mm)
290-226	1" wide x 3" deep (25mm x 76mm)
290-227	2" wide x 3 1/2" deep (51mm x 89mm)

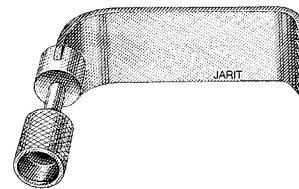

Hibbs Blades

Catalog #	Description
290-230	1" wide x 2" deep (25mm x 51mm)
290-231	2" wide x 2" deep (51mm x 51mm)
290-232	1" wide x 2 1/2" deep (25mm x 64mm)
290-233	1 1/2" wide x 2 1/2" deep (38mm x 64mm)
290-234	1" wide x 3" deep (25mm x 76mm)
290-235	1 1/2" wide x 3" deep (38mm x 76mm)
290-236	2" wide x 3" deep (51mm x 76mm)
290-237	1" wide x 4" deep (25mm x 102mm)
290-238	2" wide x 4" deep (51mm x 102mm)

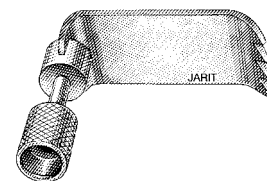

Taylor Spinal Blades

Catalog #	Description
290-240	1 1/4" wide x 3" deep (32mm x 76mm)
290-241	1 1/4" wide x 4" deep (32mm x 102mm)

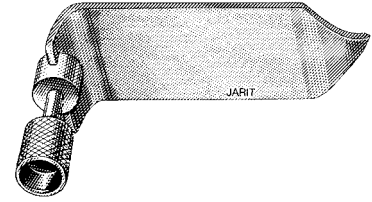

Taylor Laminectomy Blade

3 prongs

Catalog #	Description
290-242	1 1/2" wide x 1 3/4" deep (38mm x 44mm)

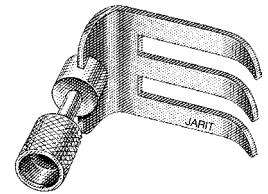

Taylor Laminectomy Blades

4 prongs

Catalog #	Description
290-244	2" wide x 1 7/8" deep (51mm x 48mm)
290-245	2 1/2" wide x 2 1/2" deep (64mm x 64mm)
290-246	2 1/4" wide x 3 1/8" deep (57mm x 79mm)

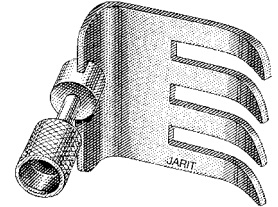

Badgley Laminectomy Retractor

Catalog #	Description
290-251	6 1/2" (165mm) spread Overall opening: 9" (230mm) Blades: 1 3/4" x 2 1/8" (44mm x 55mm) Arm length: 4 1/4" (110mm)

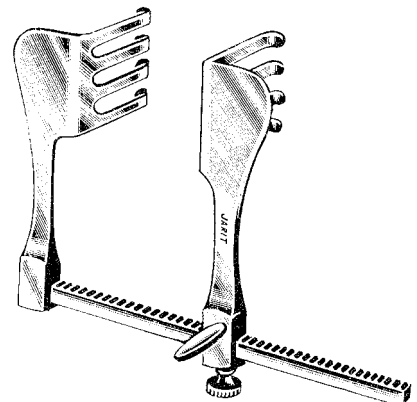

Cloward Style Cervical Retractor Set

Catalog #	Description
290-260	Large, 10" (254mm) with 7 pairs of sharp blades

Cloward Style Cervical Retractor Body

Catalog #	Description
290-261	Large, 10" (254mm)

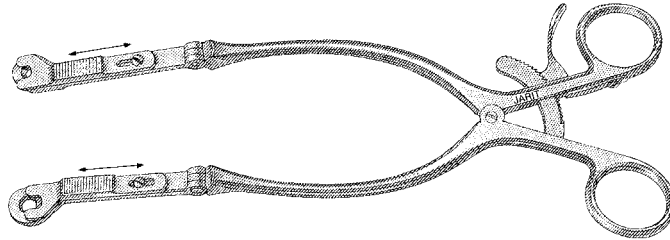

Cloward Style Cervical Retractor Blades

4 sharp prongs, 15mm wide, individually sold

Catalog #	Description
290-262	25mm deep blade
290-263	30mm deep blade
290-264	35mm deep blade
290-265	40mm deep blade
290-266	45mm deep blade
290-267	50mm deep blade
290-268	55mm deep blade

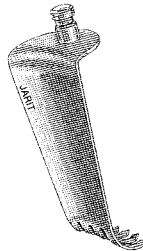

Cloward Style Cervical Retractor Set

Catalog #	Description
290-280	Small, 6¾" (171mm) with 7 pairs of blunt blades

Cloward Style Cervical Retractor Body

Catalog #	Description
290-281	Small, 6¾" (171mm)

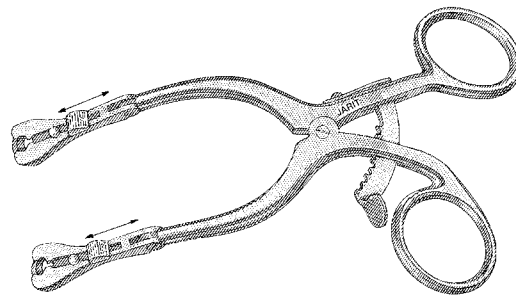

Cloward Style Cervical Retractor Blades

blunt, 15mm wide, individually sold

Catalog #	Description
290-282	25mm deep blade
290-283	30mm deep blade
290-284	35mm deep blade
290-285	40mm deep blade
290-286	45mm deep blade
290-287	50mm deep blade
290-288	55mm deep blade

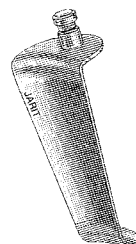

Cloward Style Cervical Vertebra Spreader

Catalog #	Description
290-300	Total length: 5" (127mm) Maximum opening: 5/8" (15mm) Arm length: 2 3/4" (70mm)

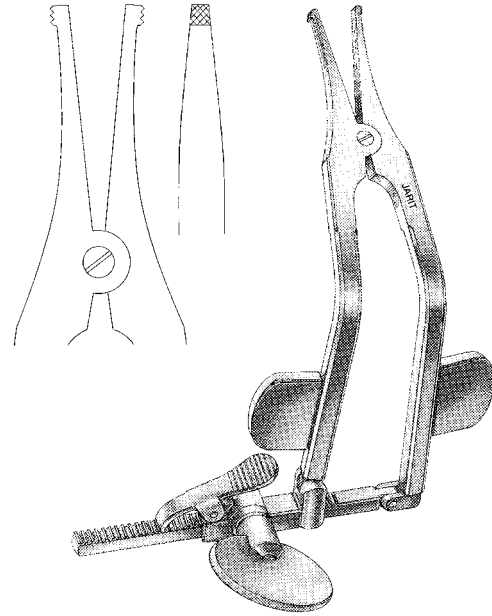

Cloward Style Cervical Vertebra Spreader

Catalog #	Description
290-305	2 3/4" (70mm) arm length, maximum opening 3" (79mm)

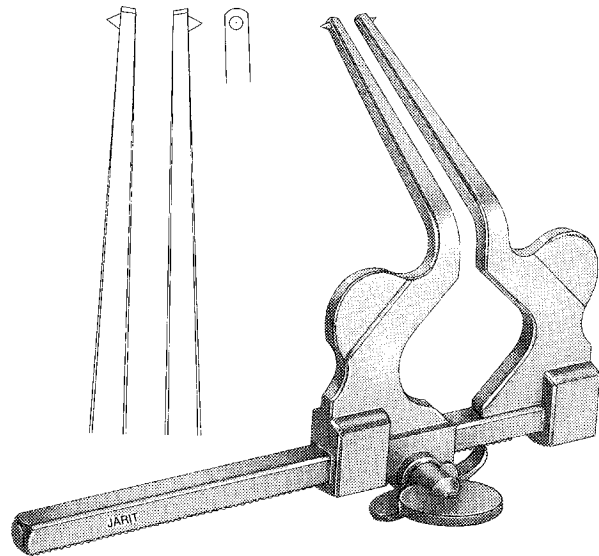

Cloward Style Lumbar Lamina Spreader

Catalog #	Description
290-310	Total length: 5½" (140mm) Maximum opening: 2½" (62mm) Total arm length: 3¾" (95mm)

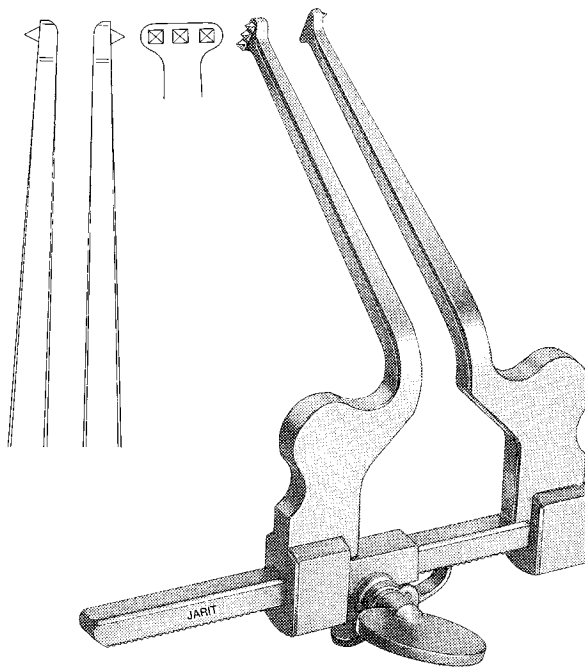

Cloward Style Lumbar Interbody Spreader

Catalog #	Description
290-315	Total length: 5⅞" (150mm) Maximum opening: 2⅜" (60mm) Total arm length: 3⅞" (100mm)

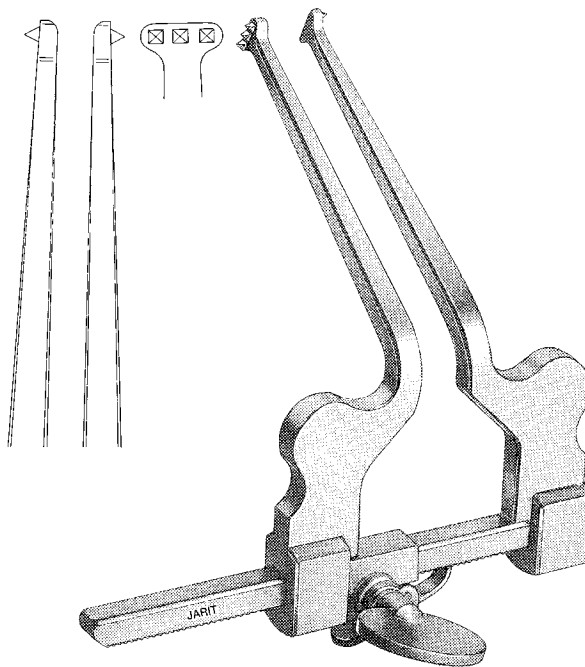

Williams-Type Discectomy Retractors
narrow blade, 6¾" (170mm)

Catalog #	Description
290-320	50mm x 10mm, left
290-321	50mm x 10mm, right
290-322	60mm x 10mm, left
290-323	60mm x 10mm, right
290-324	70mm x 10mm, left
290-325	70mm x 10mm, right

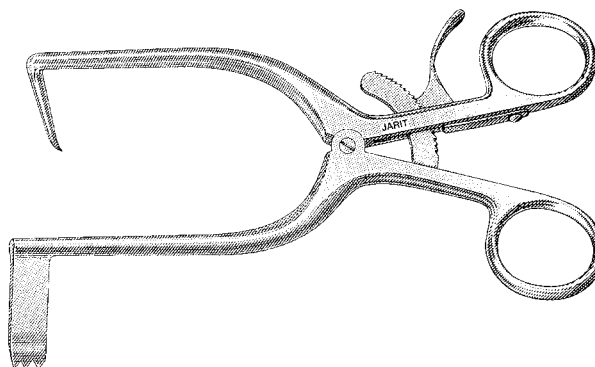

Williams-Type Discectomy Retractors
wide blade, 6¾" (170mm)

Catalog #	Description
290-330	50mm x 20mm, left
290-331	50mm x 20mm, right
290-332	60mm x 20mm, left
290-333	60mm x 20mm, right
290-334	70mm x 20mm, left
290-335	70mm x 20mm, right

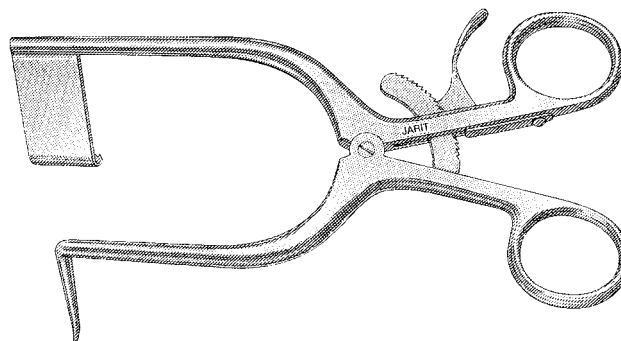

Hudson Cranial Drill Set

Catalog #	Description
295-110	Hudson cranial drill set

Includes:

295-111	Hudson brace, 9½" (243mm), 9mm diameter
295-112	Hudson burr, 9mm diameter
295-113	Hudson burr, 14mm diameter
295-114	Hudson burr, 16mm diameter
295-115	Hudson burr, 22mm diameter
295-116	Hudson cerebellar extension

295-SRW-116 Replacement Set Screw

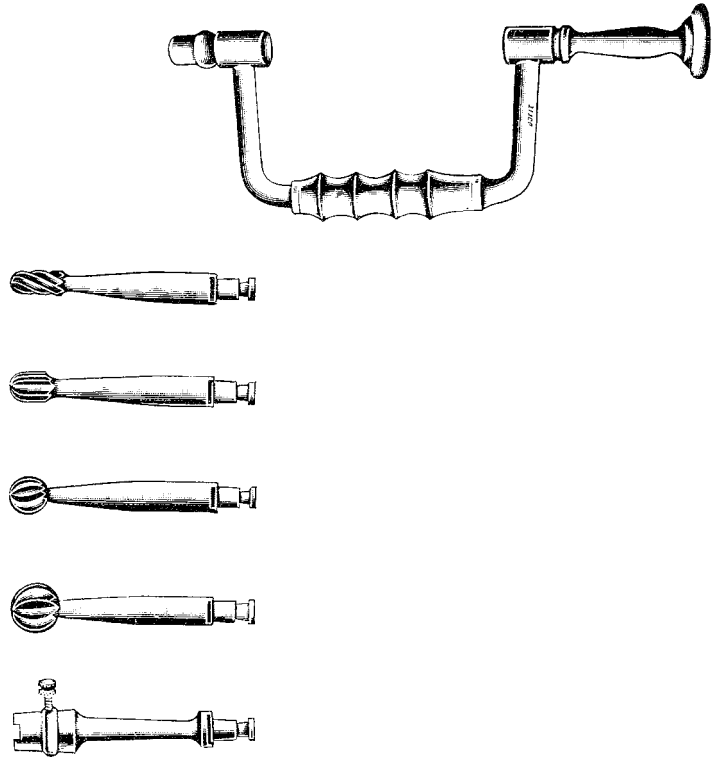

Hudson Brace

improved model with precision snap lock

Catalog #	Description
295-117	9¾" (247mm)

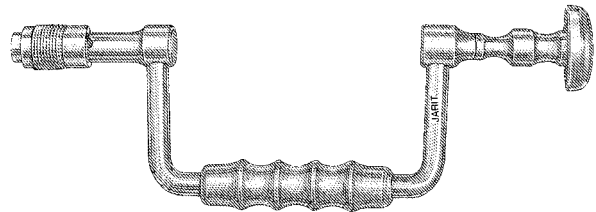

Cushing Perforator Drills

3½" (90mm)

Catalog #	Description
295-130	10mm (¾") diameter
295-131	13mm (½") diameter
295-132	16mm (⅝") diameter

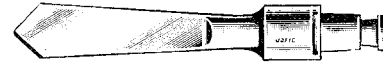

McKenzie Perforator Drill

3⅞" (98mm)

Catalog #	Description
295-140	13mm (½") diameter



D'Errico Perforator Drill

3¾" (96mm)

Catalog #	Description
295-145	16mm (⅝") diameter



McKenzie Enlarging Burr

3⅞" (98mm)

Catalog #	Description
295-150	20mm (¾") diameter



Michele Trephine

6" (155mm) working length

Catalog #	Description
260-116	⅜" (5mm)
260-117	¼" (6mm)
260-118	⅝" (8mm)

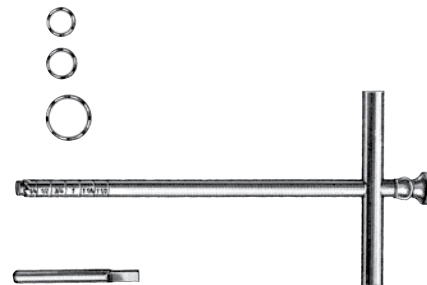

Adson Drill Guide

Catalog #	Description
295-175	6" (155mm), angled on side

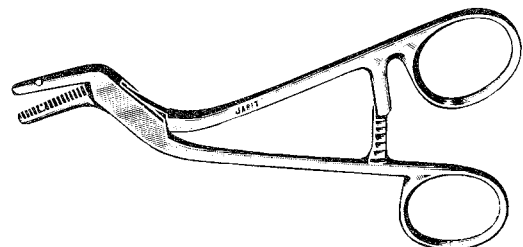

Frazier (Schmeden) Dura Scissors

Catalog #	Description
295-200	6 1/2" (165mm)

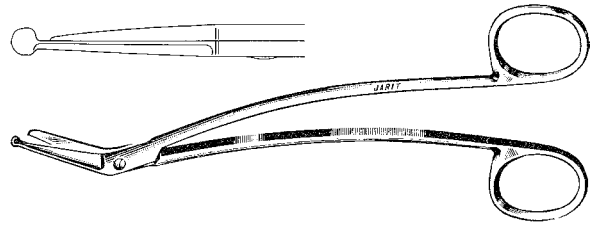

Taylor Dura Scissors

Catalog #	Description
295-205	5 1/2" (140mm), delicate

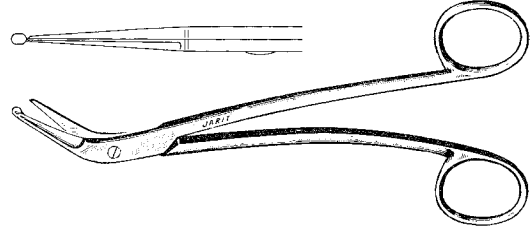

Dandy Trigeminal Scissors

Catalog #	Description
295-210	6 3/4" (172mm)
295-211	7 3/4" (197mm)

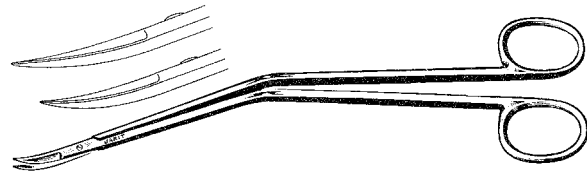

Strully Scissors

Catalog #	Description
295-215	7 3/4" (200mm)

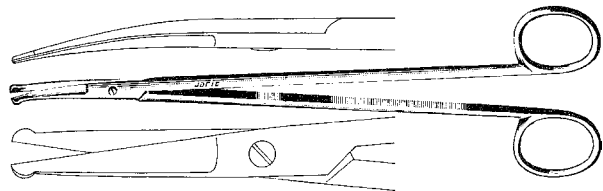

Metzenbaum Scissors, Carb-Edge

Catalog #	Description
101-261	7" (179mm), curved, delicate

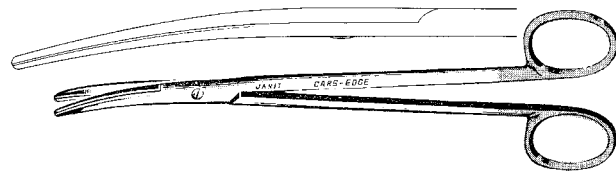

Metzenbaum Scissors, Delicate, Supercut

Catalog #	Description
102-310	7" (178mm), curved, delicate

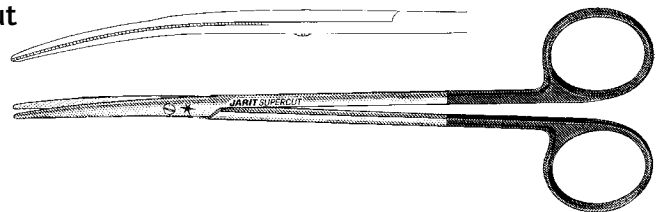

Adson Ganglion Scissors

6 1/4" (158mm)

Catalog #	Description
295-220	Straight
295-221	Curved

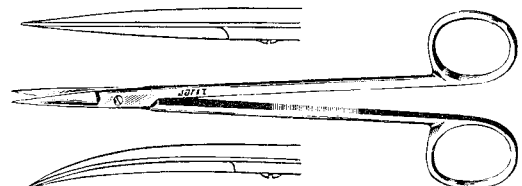

Integra™ Thoracic and Cardiovascular Instruments and General Surgical Instruments

Integra™ Jarit® Cardiovascular Thoracic Instruments have been designed to meet the needs of Cardiovascular, Peripheral Vascular and Thoracic surgeons worldwide.

Davidson Scalpula Retractors

7¾" (197mm)

Catalog #	Description
300-450	Small size, 3¼" x 2" (82mm x 51mm)
300-451	Large size, 3¼" x 3½" (82mm x 89mm)

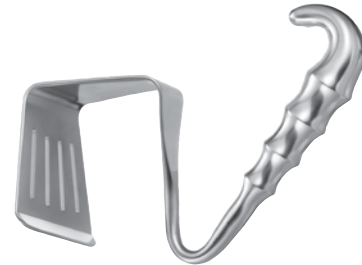

Allison Lung Retractors

Catalog #	Description
310-420	Large size, 12½" x 2⅛" (315mm x 55mm)
310-424	Small size, 10" x 1⅝" (255mm x 40mm)



Cooley Atrial Valve Retractors

Catalog #	Description
310-150	Right, 7¾" (196mm), 25mm wide x 46mm deep
310-151	Right, 7¾" (196mm), 35mm wide x 45mm deep
310-152	Right, 7¾" (196mm), 50mm wide x 45mm deep
310-155	Left, 9" (230mm), 50mm wide x 20mm deep

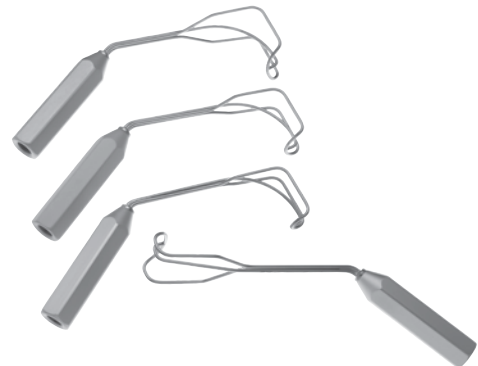

Desmarres-Type Valve Retractors

7¼" (185mm), malleable

Catalog #	Description
310-490	4mm wide
310-491	6mm wide
310-492	8mm wide
310-493	10mm wide
310-494	12mm wide
310-495	15mm wide

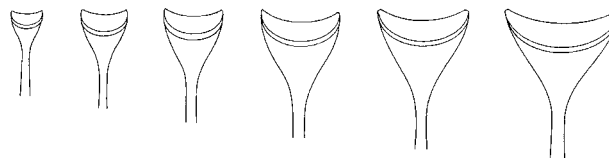

Ross Aortic Valve Retractors

Catalog #	Description
310-140	No 1 blade: 9½" (241mm), blade ⅝" x ⅝" (15mm x 16mm)
310-141	No 2 blade: 9¾" (246mm), blade ½" x ⅞" (13mm x 23mm)
310-142	No 3 blade: 9¾" (248mm), blade ¾" x 1" (18mm x 24mm)
310-143	No 4 blade: 10" (253mm), blade ½" x 1⅛" (14mm x 27mm)
310-144	No 5 blade: 10" (256mm), blade 1⅛" x 1⅛" (27mm x 29mm)
310-145	No 6 blade: 10" (252mm), blade 1" x 1⅝" (25mm x 40mm)zss

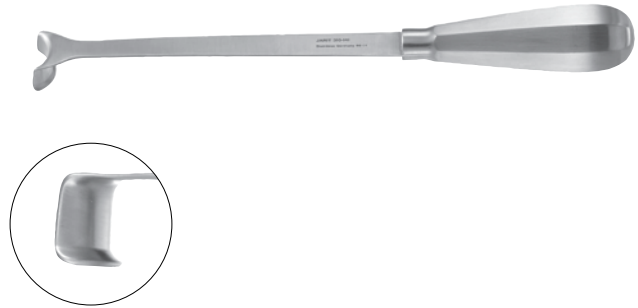

Crawford Aortic Retractors

7½" (190mm)

Catalog #	Description
310-500	Small blade, width ⅝" x ¾" (15mm x 19mm)
310-502	Large blade, width ⅞" x ¾" (22.5mm x 20mm)



Parsonnet Epicardial Retractors

3 x 3 Sharp Prongs

Catalog #	Description
310-508	1" (26mm)
310-507	1¼" (32mm)
310-506	1½" (38mm)
310-505	2" (50mm)

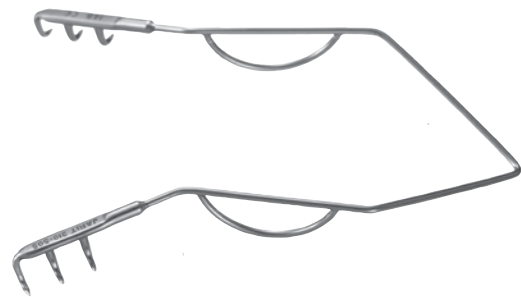

Semb Lung Retractor

9 3/4" (248mm)

Catalog #	Description
200-261	Small blade, 3/4" wide x 3/4" deep (18mm x 43mm)



Henly Retractor, Improved Pattern

with interchangeable lateral and center blades

Catalog #	Description
205-530	7" (180mm) Complete set includes:
205-FRM-530	Retractor frame only
205-532	1 pair lateral blades, blunt, 7/8" x 1" (22mm x 25mm)
205-534	1 pair lateral blades, blunt, 7/8" x 2" (22mm x 51mm)
205-536	1 pair lateral blades, blunt, 7/8" x 3" (22mm x 76mm)
205-540	1 center blade, 3/4" x 3/4" (18mm x 19mm)
205-542	1 center blade, 3/4" x 1" (18mm x 25mm)
205-544	1 center blade, 3/4" x 1 1/4" (18mm x 32mm)



Henly Retractor, Original Pattern

with 3 interchangeable center blades

Catalog #	Description
205-550	7" (180mm) Complete set includes:
205-RTB-550	1 retractor frame only
205-540	1 center blade, 3/4" x 3/4" (18mm x 19mm)
205-542	1 center blade, 3/4" x 1" (18mm x 25mm)
205-544	1 center blade, 3/4" x 1 1/4" (18mm x 32mm)



Garrett Peripheral Vascular, Self-Retaining Retractor

Catalog #	Description
205-560	Retractor set consists of: retractor body and 3 pairs of (6) detachable blades
205-561	Garrett retractor body only, 7 ¹ / ₄ " (184mm)
205-562	Small blade, width, 1 ¹ / ₂ " x 1 ¹ / ₄ " (37mm x 32mm)
205-563	Medium blade, width, 1 ¹ / ₂ " x 2 ¹ / ₄ " (37mm x 57mm)
205-564	Large blade, width, 1 ¹ / ₂ " x 3 ¹ / ₄ " (37mm x 82mm)

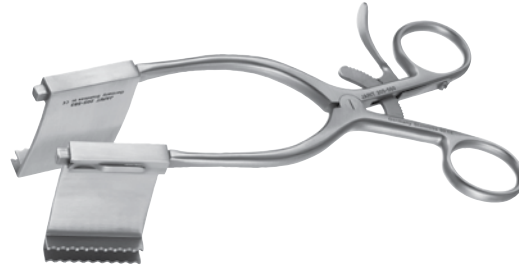
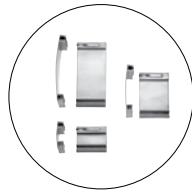

Darling Popliteal Retractor, Self-Retaining

Catalog #	Description
205-260	Left: overall length 7" (184mm), total opening 3 ³ / ₄ " (95mm) Short blade, width 1" (25mm), depth 2 ⁵ / ₈ " (68mm), left Long blade, width 1 ⁵ / ₈ " (40mm), depth 2 ⁵ / ₈ " (68mm), left
205-261	Right: overall length 7" (184mm), total opening 3 ³ / ₄ " (95mm) Short blade, width 1" (25mm), depth 2 ⁵ / ₈ " (68mm), right Long blade, width 1 ⁵ / ₈ " (40mm), depth 2 ⁵ / ₈ " (68mm), right



Ochsner Vascular Retractor, Self-Retaining, Swivel Blades, Flexible Arms

Catalog #	Description
205-570	Overall length 8" (203mm), Total Opening 5 ¹ / ₂ " (140mm) Arm length: 3 ¹ / ₄ " (83mm) Blades: width 1" (25mm), depth 2" (52mm)



Finochietto Rib Spreaders, Curved Stainless Steel Arms

Catalog #	Description
300-100	Child size Spread: 5 ⁵ / ₈ " (142mm) Arm length: 5 ¹ / ₄ " (138mm) Blades: 1 ³ / ₄ " wide x 1 ¹ / ₂ " deep (45mm x 38mm)
300-105	Adult size, medium Spread: 8" (203mm) Arm length: 7 ¹ / ₄ " (184mm) Blades: 2 ⁵ / ₈ " wide x 2" deep (67mm x 51mm)
300-115	Adult size, large Spread: 8 ³ / ₄ " (222mm) Arm length: 7 ¹ / ₄ " (184mm) Blades: 2 ³ / ₄ " wide x 2 ⁵ / ₈ " deep (70mm x 66mm)



Replacement Parts

Catalog #	Description
300-HDG-100	Replacement Handle/Gear
300-HDS-105	Replacement Handle/Gear

Finochietto Infant Rib Spreader straight, stainless steel arms

Catalog #	Description
300-200	Spread: 3" (75mm) Arm length: 3" (75mm) Blades: 3/4" x 3/4" (19mm x 19mm)



Finochietto Infant Rib Spreader curved stainless steel arms

Catalog #	Description
300-202	Spread: 2 ³ / ₄ " (70mm) Arm length: 2 ¹ / ₄ " (58mm) Blades: 7/8" x 7/8" (21mm x 21mm)



Finochietto Infant Rib Spreader-Approximator

straight stainless steel arms

Catalog #	Description
300-225	Spread: 3½" (89mm) Arm length: 2⅝" (68mm) Blades: ⅞" x ¾" (21mm x 19mm)



Bailey-Finochietto Pediatric Rib Spreader

arms and blades aluminum, ratchet bar stainless steel

Catalog #	Description
320-518	Spread: 2½" (65mm) Arm length: 2⅛" (55mm) Blades: ⅝" x ⅝" deep (15mm x 15mm)



Titanium

Bailey-Finochietto Pediatric Rib Spreader

Catalog #	Description
320-517TI	Spread: 2¾" (70mm) Arm length: 2⅞" (60mm) Blades: ⅝" x ¾" deep (16mm x 20mm)



Haight Pediatric Rib Spreader

fixed stainless steel blades

Catalog #	Description
300-210	Spread: 4 ³ / ₄ " (120mm) Arm length: 2 ¹ / ₂ " (64mm) Blades: 1 ¹ / ₈ " x 1 ¹ / ₈ " (30mm x 30mm)
300-211	Spread: 4 ³ / ₄ " (120mm) Arm length: 3 ¹ / ₂ " (89mm) Blades: 1 ¹ / ₈ " x 1 ¹ / ₈ " (30mm x 30mm)



Replacement Parts

Catalog #	Description
300-THC-211	Thumb Screw Assembly
300-HDS-105	Replacement Handle/Gear

Haight-Finocchio Pediatric Rib Spreader

aluminum arms and blades, stainless steel ratchet bar

Catalog #	Description
300-213	Spread: 3 ⁷ / ₈ " (98mm) Arm length: 3 ¹ / ₈ " (79mm) Blades: 1 ¹ / ₄ " x 1 ¹ / ₈ " (31mm x 27mm)



Tuffier Rib Spreaders

Catalog #	Description
300-150	Roughened blades Spread: 6¾" (170mm) Arm length: 4¼" (108mm) Blades: 1⅞" wide x 2" deep (47mm x 51mm)
300-151	Grooved blades Spread: 6¾" (170mm) Arm length: 4¼" (108mm) Blades: 1⅞" wide x 2" deep (47mm x 51mm)



Replacement Parts

Catalog #	Description
300-ST5-150	Replacement Locking Screw
300-TSG-150	Replacement Thumb Screw and Gear
300-TSG-151	Replacement Thumb Screw and Gear

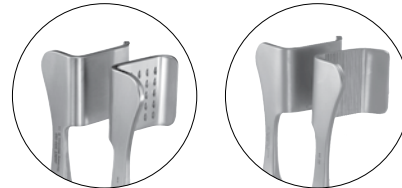

Burford Rib Spreader

Catalog #	Description
300-175	2 pair of interchangeable blades, arms and blades stainless steel, Spread: 7¾" (197mm) Arm length: 7¾" (197mm) Small blades: 1¼" wide x 2½" deep (32mm x 65mm) Large blades: 2½" wide x 3¼" deep (65mm x 82mm)



Replacement Parts

Catalog #	Description
300-BLD-175	Replacement Set of 4 Blades
300-HDG-175	Replacement Handle/Gear
300-LBL-175IL	Replacement Large Blade Left
300-LBL-175IR	Replacement Large Blade Right
300-SBL-175IL	Replacement Small Blade Left
300-SBL-175IR	Replacement Small Blade Right
300-LBL-175	Replacement Large Blade 1PR
300-SBL-175	Replacement Small Blade 1PR
300-SLB-175	Replacement Slide Bar Lock
300-KLS-175	Replacement Knurled Lock Screw 1 PR



Burford Rib Spreader

Catalog #	Description
300-180	2 pair of interchangeable blades, arms and blades aluminum, Spread: 8" (203mm) Arm length: 7½" (192mm) Small blades: 1⅝" wide x 2⅛" deep (40mm x 60mm) Large blades: 2⅜" wide x 2⅜" deep (60mm x 60mm)



Replacement Parts

Catalog #	Description
300-SBL-180	Replacement Small Blade Set
300-SBL-180IL	Replacement Small Blade Left
300-SBL-180IR	Replacement Small Blade Right
300-LBL-180IL	Replacement Large Blade Left
300-LBL-180IR	Replacement Small Blade Right
300-LBL-180	Replacement Large Blade Set

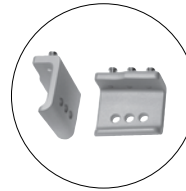

Burford-Finochietto Rib Spreader

Catalog #	Description
300-183	Infant-child Size, 4 pairs of blades, Spread: 6" (154mm) Arm length: 4¼" (108mm) Blade #1: ⅞" x ⅞" (22mm x 23mm) Blade #2: 1⅛" x 1¼" (29mm x 32mm) Blade #3: 1⅛" x 1¾" (29mm x 44mm) Blade #4: 1⅞" x 1¾" (48mm x 44mm)

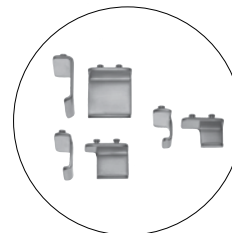

Harken Rib Spreader and Scalpula Retractor

Catalog #	Description
300-185	2 pair of stainless steel blades, Spread: 11" (280mm) Arm length: 8¼" (210mm) Fixed blades: 2½" x 1⅞" (65mm x 49mm) Scalpula blades: 2" x 2" (51mm x 51mm)



Replacement Parts

Catalog #	Description
300-BLS-185	Replacement Scalpula Blades



Ankeney Sternal Retractor, Adult

six swivel blades, with suture holding springs

Catalog #	Description
300-165	Spread: 7½" (190mm) Arm length: 11¾" (300mm) Blades: 1⅜" x 1¼" deep (35mm x 32mm)
300-166	Set of 6 blades: 1⅜" x 2" (35mm x 52mm)



Ankeney Sternal Retractor, Child

aluminum arms with stainless steel rack

Catalog #	Description
300-160	Spread: 4⅞" (125mm) Arm length: 4½" (115mm) Blades: ¾" x 1" deep (20mm x 25mm)



Himmelstein Sternal Retractor

stainless steel

Catalog #	Description
300-205	Spread: 6" (152mm) Arm length: 5¾" (145mm) Blades: 1¾" x 1¼" deep (35mm x 32mm)



Morse Sternal Retractor

stainless steel, child size

Catalog #	Description
300-250	Spread: 6" (152mm) Arm length: 4¾" (121mm) Blades: 7⁄8" x 5⁄8" (22mm x 16mm)



Morse Sternal Retractor

stainless steel, adult size

Catalog #	Description
300-251	Spread: 7¾" (195mm) Arm length: 6" (152mm) Blades: 1½" x 1" (29mm x 24mm)



Replacement Parts

Catalog #	Description
300-BLS-251	Replacement Set of Blades 1 Set
300-HDG-251	Replacement Handle
300-HDG-253	Replacement Gear

Favaloro-Morse Sternal Retractor

stainless steel

Catalog #	Description
300-253	Spread: 7¾" (195mm) Arm length: 6" (152mm) Blades: 1⅝" x 1⅛" (42mm x 29mm)

Replacement Parts

Catalog #	Description
300-SRW-253	Replacement Screw
300-BLS-253	Replacement Blade Set 1 Set (4)
300-HDG-251	Replacement Handle
300-HDG-253	Replacement Gear

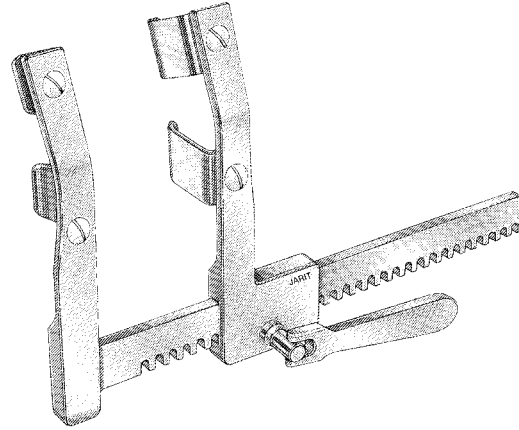

Cooley Sternal Retractors

stainless steel

Catalog #	Description
300-260	Child size Spread: 5⅞" (130mm) Arm length: 4½" (113mm) Blades: 1¾" x 1" (46mm x 25mm)
300-261	Adult size Spread: 6½" (165mm) Arm length: 5½" (140mm) Blades: 2" x 1⅜" (51mm x 34mm)
300-262	Extra large size Spread: 7¾" (194mm) Arm length: 6¼" (158mm) Blades: 4" x 1⅛" (102mm x 29mm)



Replacement Parts

Catalog #	Description
300-HDG-261	Replacement Handle/Gear

Cooley Neonatal Sternal Retractor

arms and blades aluminum, ratchet bar stainless steel

Catalog #	Description
320-510	Spread: 3 1/8" (79mm) Arm length: 2 1/8" (54mm) Blades: 5/8" x 3/8" (17mm x 10mm)



Cooley Pediatric Sternal Retractor

arms and blades aluminum, ratchet bar stainless steel

Catalog #	Description
320-515	Spread: 3 1/8" (79mm) Arm length: 2 1/4" (58mm) Blades: 5/8" x 1/2" (16mm x 14mm)
320-516	Spread: 4" (102mm) Arm length: 3" (77mm) Blades: 3/4" x 5/8" (19mm x 17mm)
320-514	Spread: 4 5/8" (117mm) Arm length: 3 1/8" (79mm) Blades: 1 1/8" x 3/4" (30mm x 20mm)



Castaneda Sternal Retractors

arms and blades aluminum, ratchet bar stainless steel

Catalog #	Description
300-190	Newborn size Spread: 2 1/2" (65mm) Arm length: 2 3/8" (60mm) Blades: 1 3/8" x 1/2" (34mm x 13mm)
300-192	Infant size Spread: 3 1/8" (80mm) Arm length: 3 1/8" (80mm) Blades: 1 3/4" x 1/2" (45mm x 13mm)
300-194	Child size Spread: 4 3/4" (120mm) Arm length: 5" (127mm) Blades: 2 3/8" x 3/4" (60mm x 17.5mm)



Bailey Rib Contractor, Adult

Catalog #	Description
300-230	7¾" (194mm)

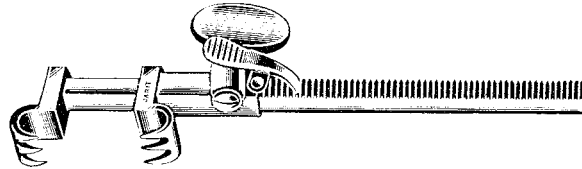

Replacement Parts

Catalog #	Description
300-THC-230	Replacement Thumbscrew Assembly

Bailey Rib Contractor, Pediatric

Catalog #	Description
300-231	6" (154mm)

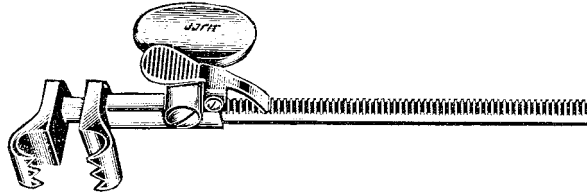

Replacement Parts

Catalog #	Description
300-THC-230	Replacement Thumbscrew Assembly

Bailey-Gibbon Rib Contractor

Catalog #	Description
300-235	7¾" (194mm)

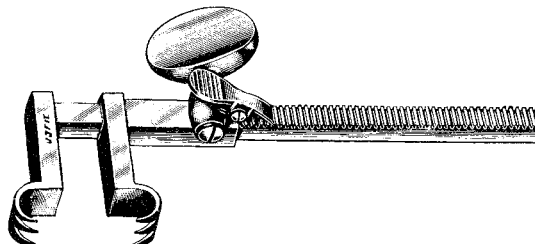

Replacement Parts

Catalog #	Description
300-THC-230	Replacement Thumbscrew Assembly
300-SGA-235	Replacement Screw Gear Assembly

Lemmon Sternal Approximator, Adult

Catalog #	Description
300-238	7" (180mm)

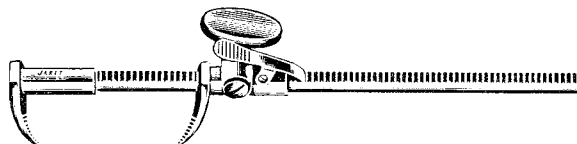

ALL DIMENSIONS ARE APPROXIMATE

Catalog #

NEWBORN

Castaneda	300-190	Aluminum body and frame
Castaneda	300-192	Aluminum body and frame
Cooley	320-510	Aluminum arms and blades, Stainless Steel ratchet bar
Bailey-Finochietto	320-518	Aluminum body and frame
Bailey-Finochietto	320-517TI	Titanium

INFANT TO YOUNG CHILDREN

Cooley	320-515	Aluminum arms and blades, Stainless Steel ratchet bar
Cooley	320-516	Aluminum arms and blades, Stainless Steel ratchet bar
Cooley	320-514	Aluminum arms and blades, Stainless Steel ratchet bar
Castaneda	300-194	Aluminum body and frame
Finochietto	300-225	
Finochietto	300-200	
Haight-Finochietto	300-213	Aluminum arms and blades, Stainless Steel ratchet bar
Finochietto	300-202	
Haight	300-210	
Haight	300-211	

OLDER CHILD 6-10 YEARS

Ankeney	300-160	
Cooley	300-260	
Morse	300-250	
Cooley	300-261	
Finochietto	300-100	
Burford	300-183	

Tuffier	300-151	
Tuffier	300-150	

ADULT

Ankeney	300-165	
Blades	300-166	
Himmelstein	300-205	
Cooley	300-262	
Morse	300-251	
Favaloro-Morse	300-253	
Burford	300-180	Aluminum arms and blades, Stainless Steel ratchet bar
Small Blades		
Large Blades		
Finochetto-Medium	300-105	
Finochetto	300-115	
Buford	300-175	
Small Blades		
Large Blades		
Harken	300-185	
Fixed Blades		
Scapula Blades		

Blade Style	Maximum Spread	Blade Width	Blade Depth	Arm Length	Page #
Sternal, Single, Fixed	2 1/2" (6.5cm)	1 1/4" (3.3cm)	1/2" (1.3cm)	2 1/8" (5.4cm)	358
Sternal, Single, Fixed	2 1/2" (8.8cm)	1 3/4" (4.5cm)	5/8" (1.7cm)	3 1/8" (7.9cm)	358
Sternal, Single, Fixed	2 3/4" (7cm)	1 1/16" (1.7cm)	1/2" (1.4cm)	2 1/8" (5.5cm)	358
Rib, Single, Fixed	2 1/2" (6.5cm)	1/2" (1.5cm)	1/2" (1.5cm)	2 1/8" (5.5cm)	351
Rib, Single, Fixed	2 7/8" (7.2cm)	3/4" (2cm)	3/4" (2cm)	2 1/4" (5.9cm)	351
Sternal, Single, Fixed	3 3/8" (8.7cm)	5/8" (1.6cm)	5/8" (1.6cm)	2 1/4" (5.6cm)	358
Sternal, Single, Fixed, with Teeth	3 1/2" (8.9cm)	3/4" (1.9cm)	3/4" (1.9cm)	3" (7.6cm)	358
Sternal, Single, Fixed	3 3/4" (9.6cm)	1 1/8" (2.9cm)	7/8" (2cm)	3" (7.8cm)	358
Sternal, Single, Fixed	4 1/8" (10.5cm)	2 3/8" (6cm)	7/8" (2.2cm)	5" (12.8cm)	358
Rib, Single, Fixed, with Rib Approximator	3" (7.5cm)	3/4" (2cm)	7/8" (2.2cm)	2 3/8" (6cm)	351
Rib, Single, Fixed, Straight Arms	3 1/4" (8.3cm)	3/4" (1.9cm)	3/4" (1.9cm)	2 3/4" (7cm)	350
Rib, Single, Fixed	3 1/2" (9cm)	1 3/16" (3cm)	1 3/8" (3.5cm)	3 1/8" (8cm)	352
Rib, Single, Fixed, Curved Arms	3 3/4" (6.9cm)	3/4" (2.1cm)	7/8" (2.2cm)	2 1/4" (5.6cm)	350
Rib, Single, Fixed	4 3/4" (12cm)	1 3/16" (3cm)	1 3/8" (3.5cm)	2 1/2" (6.4cm)	352
Rib, Single, Fixed	4 3/4" (12cm)	1 3/16" (3cm)	1 3/8" (3.5cm)	3 1/2" (9cm)	352
Sternal, 4 Swivel Blades	4 3/4" (12cm)	3/4" (1.9cm)	1" (2.5cm)	4 1/2" (11.4cm)	355
Sternal, Single, Fixed	5 1/4" (13.3cm)	1 3/4" (4.5cm)	1" (2.7cm)	4 1/2" (11.4cm)	357
Sternal, 4 Swivel Blades	6" (15.5cm)	7/8" (2.2cm)	5/8" (1.8cm)	4 7/8" (12.4cm)	356
Sternal, Single, Fixed	6 1/2" (16.5cm)	1 1/2" (3.9cm)	2" (5.1cm)	5 1/2" (13.9cm)	357
Rib, Single, Fixed, Curved Arms	5 1/2" (13.8cm)	1 3/4" (4.4cm)	1 3/4" (4.3cm)	5 1/4" (13.5cm)	350
Rib, Single, Interchangeable	6 1/4" (16cm)		1" (2.3cm)	4 1/8" (10.5cm)	354
			1 1/4" (3.3cm)	1" (2.5cm)	
			1 3/4" (4.3cm)	1 3/8" (3.5cm)	
			1 3/4" (4.3cm)	1 3/8" (3.5cm)	
			1 3/4" (4.3cm)	2" (5cm)	
Rib, Single, Fixed, Grooved Blades	6 7/8" (17.4cm)	1 3/4" (4.4cm)	2" (5.1cm)	4 1/4" (10.8cm)	353
Rib, Single, Fixed, Roughened Blades	6 7/8" (17.4cm)	1 3/4" (4.4cm)	2" (5.1cm)	4 1/4" (10.8cm)	353
Sternal, 6 Swivel Blades	7" (19.7cm)	1 3/8" (3.5cm)	1 3/8" (3.5cm)	13" (33cm)	355
			1 3/8" (3.5cm)	2" (5.2cm)	355
Sternal, Single, Swivel Blades	7 1/4" (18.5cm)	1 3/8" (3.5cm)	1 1/8" (3cm)	5 3/4" (14.7cm)	356
Sternal, Fixed	7 1/4" (18.5cm)	4" (10.2cm)	1 1/8" (3cm)	6" (15.5cm)	357
Sternal, 4 Swivel Blades	9" (23cm)	1 1/8" (2.9cm)	1" (2.4cm)	5 3/4" (14.7cm)	356
Sternal, 4 Swivel Blades	9" (23cm)	1 1/8" (3cm)	1 1/2" (4cm)	6" (15.2cm)	357
Rib, Single, Interchangeable	7" (17.5cm)		2 1/2" (6.2cm)	7 5/8" (19.5cm)	354
			2 1/2" (6.2cm)	2" (5.3cm)	
			2 1/2" (6.2cm)	2 7/8" (7.3cm)	
Rib, Single, Fixed, Medium, Curved Arms	7 7/8" (20cm)	2 5/8" (6.6cm)	2 1/8" (5.5cm)	7 1/4" (18.4cm)	350
Rib, Single, Fixed, Large, Curved Arms	7 7/8" (20cm)	2 5/8" (6.6cm)	2 7/8" (7.3cm)	7 1/4" (18.4cm)	350
Rib, Single, Interchangeable	8" (20.5cm)			7 5/8" (19.5cm)	353
			2 1/2" (6.4cm)	2" (5cm)	
			2 1/2" (6.4cm)	3 1/8" (8cm)	
Rib, Single, Fixed, with Scapula Blades	11" (28cm)			8 1/2" (21.5cm)	355
			2 1/2" (6.4cm)	2" (5.3cm)	
			2" (4.9cm)	2" (5.1cm)	

Plain Rib Shears

Catalog #	Description
300-300	9" (230mm)

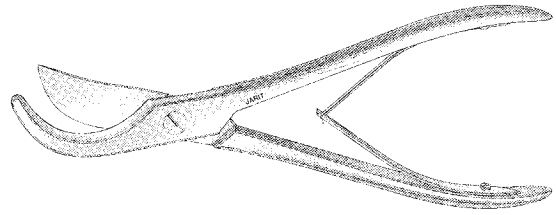

Gluck Rib Shears

Catalog #	Description
300-302	7½" (190mm)

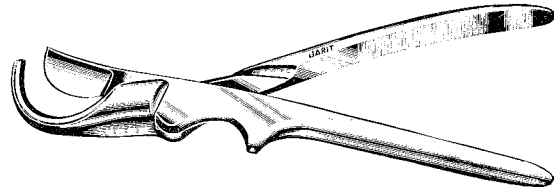

Sauerbruck Rib Shears

Catalog #	Description
300-304	10" (256mm)

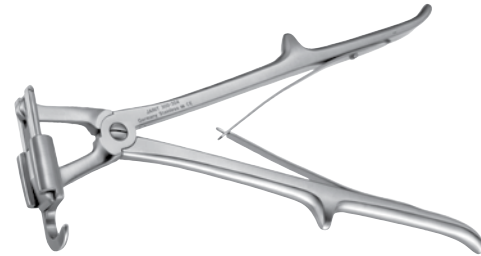

Stille-Giertz Rib Shears

Catalog #	Description
300-305	10" (252mm)

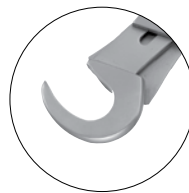

Bethune Rib Shears

Catalog #	Description
300-310	14" (353mm)



Replacement Parts

Catalog #	Description
300-SPS-310	Replacement Spring and Screw



Bethune-Coryllos Rib Shears, Left

<u>Catalog #</u>	<u>Description</u>
300-315	14½" (370mm)



Bethune-Coryllos Rib Shears, Right

<u>Catalog #</u>	<u>Description</u>
300-316	14½" (370mm)

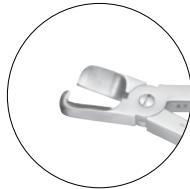

Ruskin-Liston Bone Splitting Forceps

14mm cutting jaw, narrow jaw

Catalog #	Description
230-310	7¼" (182mm), straight
230-311	7¼" (182mm), up-angled
230-SPS-305	Replacement Spring and Screws
230-SPS-306	Replacement Spring and Screws



Stille-Liston Bone Cutting Forceps

Catalog #	Description
230-320	10¾" (270mm), straight, 32.7mm cutting jaws
230-321	10¾" (270mm), up-angled, 27.3mm cutting jaws



Stille-Horsley Bone Cutting Forceps

Catalog #	Description
230-325	9¾" (250mm), S-shaped, 25mm cutting edge



Ruskin-Mini Bone Rongeurs

Catalog #	Description
230-195	6" (155mm), straight, 2mm bite
230-196	6" (155mm), curved, 2mm bite
230-197	6" (155mm), full curved, 3mm bite
230-200	6" (155mm), curved, 4mm bite

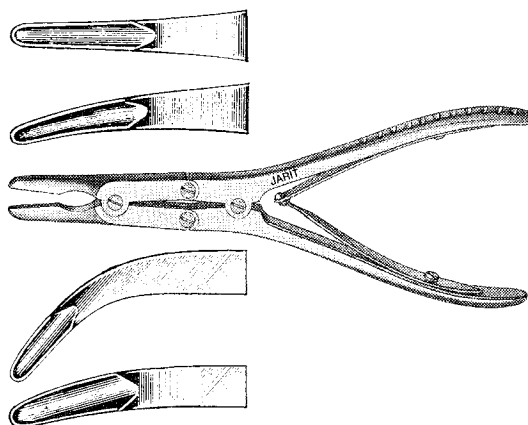

Replacement Parts

Catalog #	Description
230-SPS-196	Replacement Spring and Screw

Ruskin Rongeurs

Catalog #	Description
230-210	7¼" (185mm), straight, 5mm bite
230-211	7¼" (185mm), curved, 5mm bite
230-214	7¼" (185mm), straight, 6mm bite
230-215	7¼" (185mm), curved, 6mm bite



Ruskin-Jay Rongeur

Catalog #	Description
230-216	8" (202mm), heavy duty, light curved, 6mm bite



Ruskin Angular Duckbill Rongeur

Catalog #	Description
230-218	7¼" (181mm), 6mm bite



Stille- Luer Rongeurs

straight, 10mm bite

Catalog #	Description
230-230	8¾" (225mm)
230-235	10" (255mm)

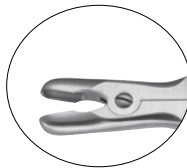

Stille- Luer Rongeurs

curved, 10mm bite

Catalog #	Description
230-231	8¾" (225mm)
230-236	10" (255mm)

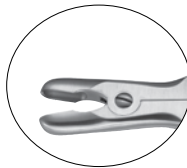

Stille- Luer Angular Duckbill Rongeur

9" (230mm)

Catalog #	Description
230-240	6mm bite



Echlin Angular Duckbill Rongeurs

Catalog #	Description
230-245	9" (230mm), 2mm bite
230-246	9" (230mm), 3mm bite
230-247	9" (230mm), 4mm bite
230-SPS-246	Replacement Spring and Screw

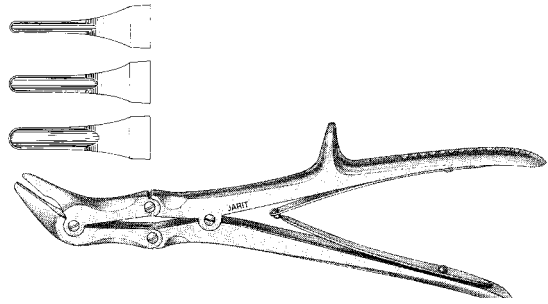

Stille-Luer-Echlin Angular Duckbill Rongeur

Catalog #	Description
230-250	9" (230mm), 6mm bite



Leksell Rongeurs
slight curve

Catalog #	Description
230-260	9 1/4" (237mm), 3mm bite
230-261	9 1/4" (237mm), 8mm bite
230-262	9 1/4" (237mm), 5mm bite

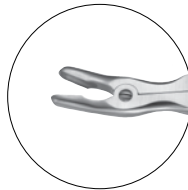

Dale Thoracic Rongeurs
3mm bite, slight curve

Catalog #	Description
230-280	13 1/2" (343mm)



Sauerbruch Rib Rongeurs
square bite

Catalog #	Description
230-275	12" (305mm), 5/8" (16mm) wide jaw
230-276	12" (305mm), 3/4" (19mm) wide jaw

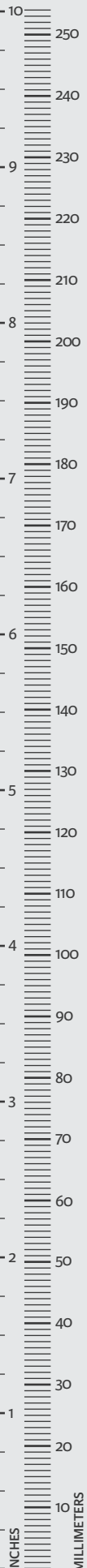

Doyen Raspatories

Catalog #	Description
300-400	6½" (165mm), 6mm x 40mm large blade, left
300-402	6½" (165mm), 6mm x 40mm large blade, right
300-405	7¼" (183mm), 5mm x 29mm small blade, left
300-407	7¼" (183mm), 5mm x 29mm small blade, right

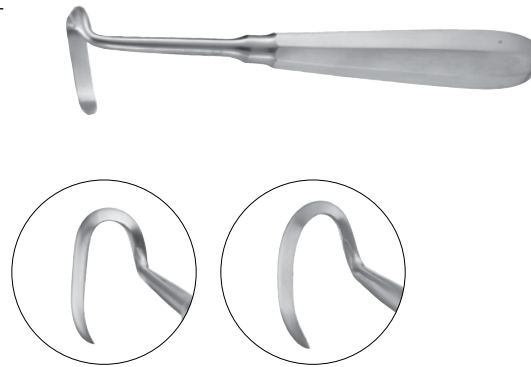

Matson-Alexander Rib Stripper

Catalog #	Description
300-410	8½" (215mm)



Matson Rib Stripper and Elevator

Catalog #	Description
300-411	8¾" (221mm)



Alexander-Farabeuf Periosteotome

Catalog #	Description
300-415	8¼" (209mm)



Alexander Periosteotome, Pediatric

Catalog #	Description
300-416	5⅞" (148mm)



Lebsche Sternum Knife

Catalog #	Description
300-425	9¾" (245mm)



Adson Dura Hook

Catalog #	Description
285-225	7¾" (200mm), 6.5mm long, sharp tip



Adson Dura Hook

Catalog #	Description
285-227	8" (202mm), 7mm long, blunt tip



Dandy Nerve Hook

Catalog #	Description
285-230	9" (230mm), 5mm long, blunt tip



Smithwick Sympathectomy Hook and Dissector

Catalog #	Description
285-315	12¼" (312mm)



Penfield Dissector No. 4, Slightly Curved

Catalog #	Description
285-368	8" (205mm)



Freer Double-Ended Elevators

7¾" (195mm), sharp-blunt blades

Catalog #	Description
285-379	6.5mm blades
285-380	4.5mm blades



Metzenbaum-Nelson Scissors, Stainless

Catalog #	Description
305-100	9¼" (235mm), straight
305-101	9¼" (232mm), curved
305-105	11¼" (286mm), straight
305-106	11¼" (286mm), curved
305-110	14½" (367mm), curved

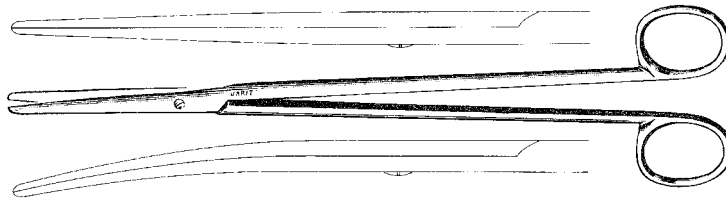

Metzenbaum-Nelson Scissors, Carb-Edge

Catalog #	Description
101-266	9¼" (233mm), straight, blunt tips
101-267	9¼" (233mm), curved, blunt tips
101-275	9¼" (233mm), straight, delicate tips
101-276	9¼" (233mm), curved, delicate tips
101-278	9¼" (233mm), straight, sharp tips
101-279	9¼" (233mm), curved, sharp tips
101-269	10¼" (260mm), curved, blunt tips
101-270	11¼" (285mm), curved, blunt tips
101-272	12¼" (310mm), curved, blunt tips
101-256	14¼" (364mm), curved, blunt tips

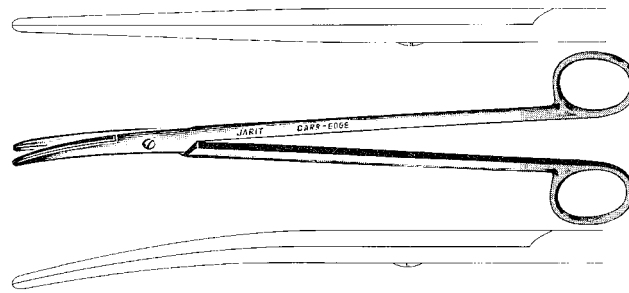

Metzenbaum Scissors, Supercut

Catalog #	Description
102-122	7" (180mm), curved
102-125	9¼" (232mm), curved
102-126	10¼" (260mm), curved
102-128	11¼" (285mm), curved
102-129	12" (302mm), curved
102-127	14" (356mm), curved

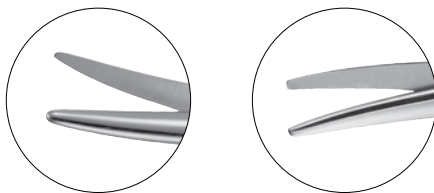

Jorgenson Scissors

Catalog #	Description
305-120	8¾" (222mm)



Cooley Scissors

Catalog #	Description
305-125	7½" (191mm)



Willauer Scissors

Catalog #	Description
305-130	10¼" (260mm), straight
305-131	10¼" (260mm), curved
305-135	12" (305mm), straight
305-136	12" (303mm), curved

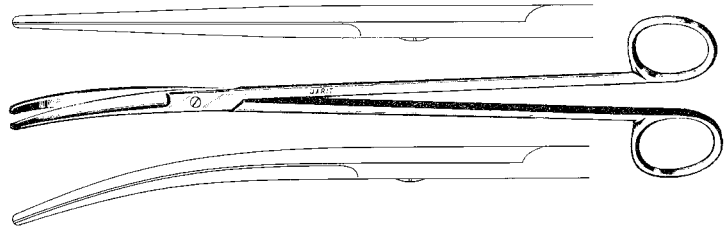

Mayo-Harrington Scissors

Catalog #	Description
305-140	9" (230mm), straight
305-141	9" (230mm), curved
305-145	11" (280mm), straight
305-146	11" (280mm), curved

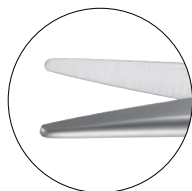

Mayo-Harrington Scissors, Carb-Edge

Catalog #	Description
101-225	9" (230mm), straight
101-226	9" (230mm), curved
101-230	14¼" (361mm), straight
101-232	14¼" (361mm), curved

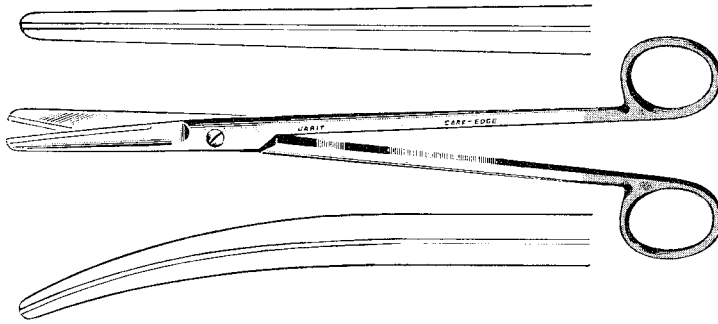

Mayo-Harrington Scissors, Supercut

Catalog #	Description
102-115	9" (230mm), straight
102-116	9" (230mm), curved
102-113	10" (256mm), straight
102-118	11" (280mm), curved
102-114	12" (305mm), straight

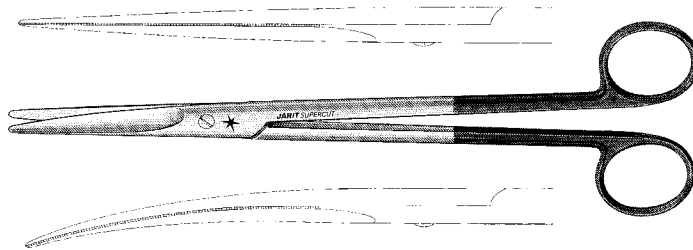

Lillehei-Potts Scissors, 7" (180mm)

Catalog #	Description
100-240	Straight blades, blunt tips
100-241	Curved blades, blunt tips
100-242	Straight blades, sharp tips
100-243	Curved blades, sharp tips
100-244	Straight blades, tenotomy tips
100-245	Curved blades, tenotomy tips

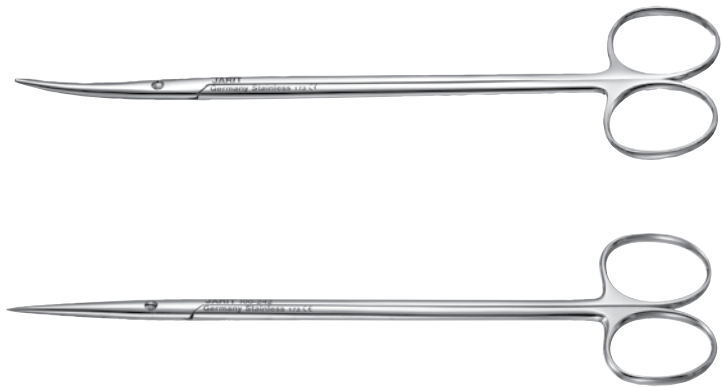

Lillehei-Potts Scissors, 9" (230mm), Supercut

Catalog #	Description
102-305	Curved blades, 34mm sharp tips
102-306	Curved blades, 34mm blunt tips
102-307	Curved blades, 14mm tenotomy tips

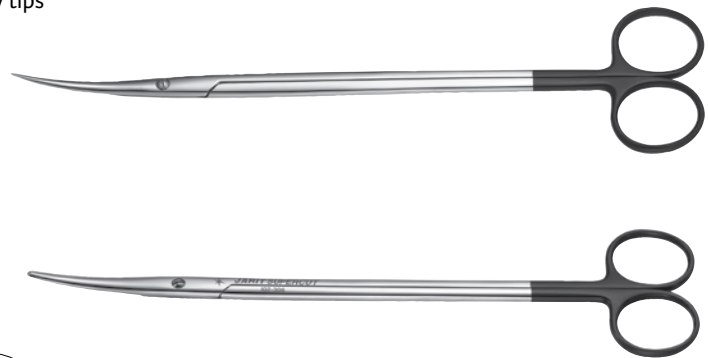

Reynolds Scissors, Narrow Tip, Curved

Catalog #	Description
100-295	5 5/8" (143mm), plain edge, very narrow tips
100-296	5 5/8" (143mm), serrated edge, very narrow tips
100-297	7" (179mm), plain edge, very narrow tips
100-298	7" (179mm), serrated edge, very narrow tips

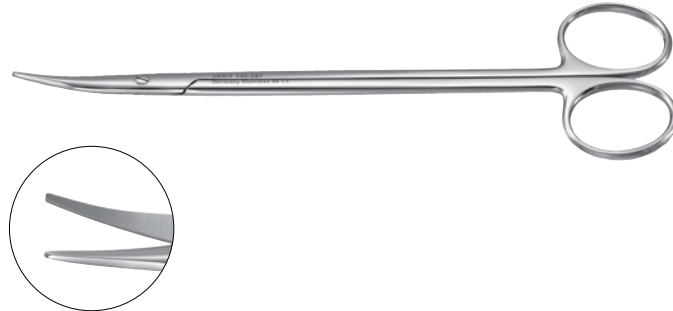

Jamison-Metzenbaum Scissors, Narrow Tip, Curved

Catalog #	Description
100-300	6" (155mm)
100-302	7" (180mm)
100-304	8" (205mm)
100-306	9" (230mm)

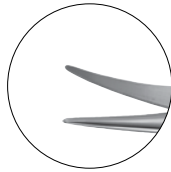

Jamison-Metzenbaum Scissors, Supercut, Curved

Catalog #	Description
102-300	5 5/8" (143mm)
102-302	7" (180mm)



Metzenbaum Scissors, Delicate Pattern (Mirror Finish)

Catalog #	Description
100-261	7" (178mm), curved

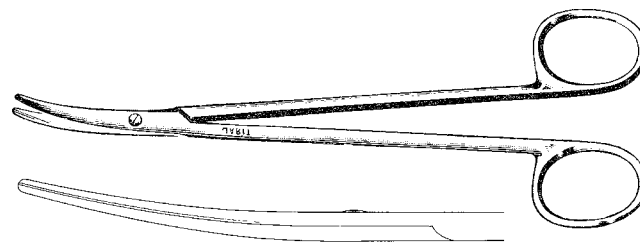

Metzenbaum-Lahey Scissors, Carb-Edge

Catalog #	Description
101-251	5 3/4" (145mm), curved

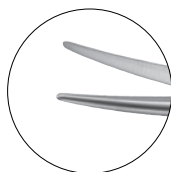

Metzenbaum Scissors, Carb-Edge

Catalog #	Description
101-258	7" (179mm), curved, blunt/blunt tips
101-259	7" (179mm), curved, delicate sharp/sharp tips
101-260	7" (179mm), straight, delicate, blunt/blunt tips
101-261	7" (179mm), curved, delicate, blunt/blunt tips
101-265	8" (206mm), curved, blunt/blunt tips

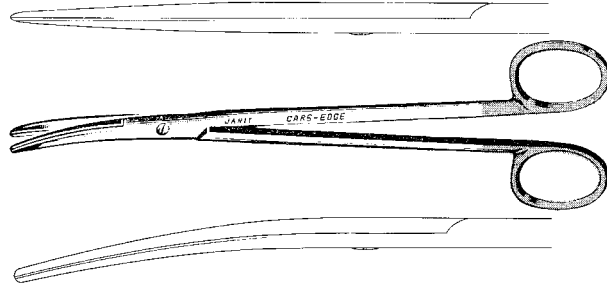

Metzenbaum Scissors, Supercut

Catalog #	Description
102-120	5 5/8" (143mm), curved
102-122	7" (180mm), curved
102-310	7" (180mm), curved, delicate
102-311	7 3/4" (200mm), curved, delicate
102-125	9 1/4" (232mm), curved
102-126	10 1/4" (260mm), curved
102-128	11 1/4" (285mm), curved
102-129	12" (302mm), curved
102-127	14" (356mm), curved

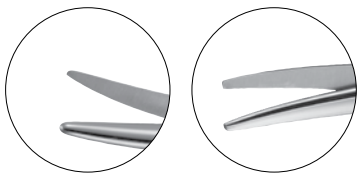

Reynolds, Petit Point Scissors, Carb-Edge

curved, one blade serrated

Catalog #	Description
101-255	5 1/8" (130mm)

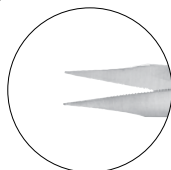

Reynolds, Petit Point Scissors, Supercut

Catalog #	Description
102-245	5 1/8" (129mm), curved, tenotomy tips

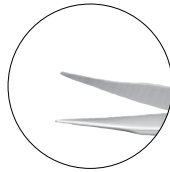

Flat Tip Scissors, Tenotomy Tips, Supercut

Catalog #	Description
102-313	7" (177mm), curved

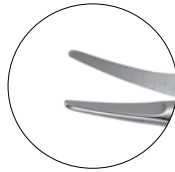

Potts-Smith Dissecting Scissors, Curved

Catalog #	Description
310-290	5 3/4" (145mm)
310-291	7 1/4" (184mm)
310-292	9 1/4" (232mm)



Satinsky Vascular Scissors

Catalog #	Description
310-300	9 1/2" (243mm), curved shanks, acutely curved tips



DeMartel Vascular Scissors, Curved

Catalog #	Description
310-302	6 3/4" (174mm), blunt tips
310-303	6 3/4" (172mm), sharp tips

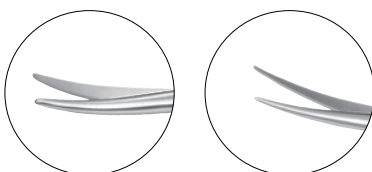

Endarterectomy Vascular Scissors

Catalog #	Description
310-330	6¾" (172mm), curved



Endarterectomy Vascular Scissors, Supercut

Catalog #	Description
102-315	6¾" (173mm), curved

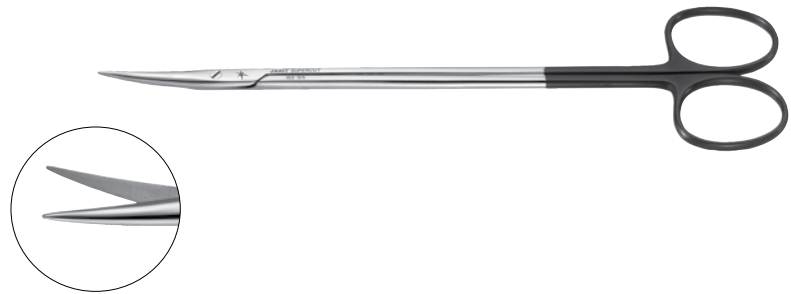

DeBakey Endarterectomy Vascular Scissors

Catalog #	Description
310-349	7" (178mm), full curve



Lincoln Vascular Scissors

Catalog #	Description
310-367	10" (255mm), straight
310-368	10" (254mm), curved
310-369	6¾" (174mm), straight
310-370	6¾" (173mm), curved

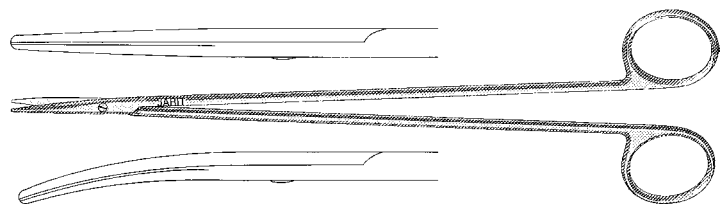

Church Vascular Scissors

Catalog #	Description
310-375	7" (175mm), straight
310-376	7" (175mm), curved

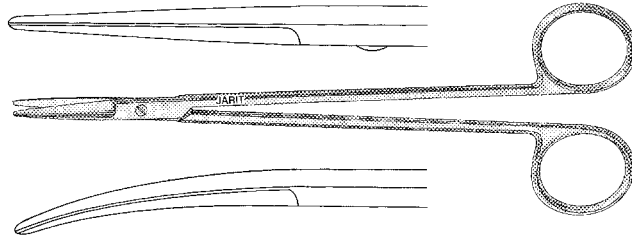

Mattox-Potts Scissors

Catalog #	Description
310-304	5 3/8" (137mm), 45° angle, 22mm blades



You-Potts Scissors, Fine 10mm Blades

Catalog #	Description
310-305	7" (178mm), 45° angle
310-306	7" (178mm), 90° angle
310-307	7" (178mm), 120° angle

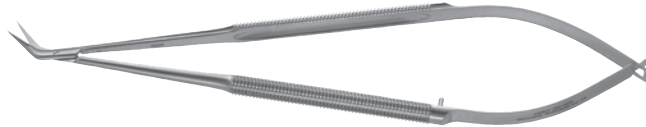
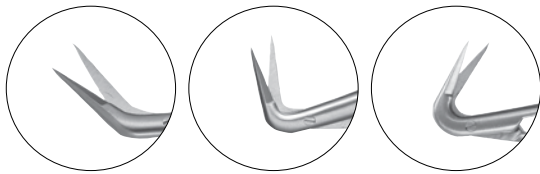

Yasargil Vascular Scissors, Bayonet Handle

Catalog #	Description
310-308	7 3/4" (195mm), 45° angle, 13mm blades

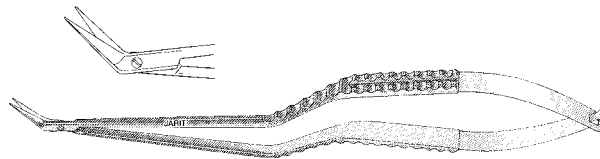

310-309	7" (178mm), left circumflex coronary artery scissors, 125° angle, 10.5mm reverse angle blades
---------	---

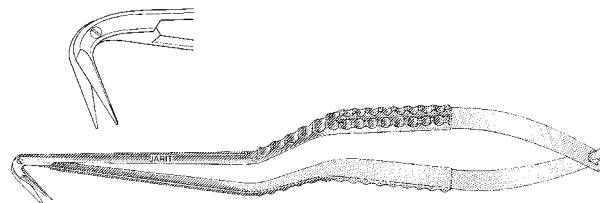

Potts-Smith Vascular Scissors

Catalog #	Description
310-310	7½" (189mm), 25° angle, 22mm blades
310-315	7¼" (185mm), 45° angle, 22mm blades
310-320	7" (180mm), 60° angle, 19mm blades

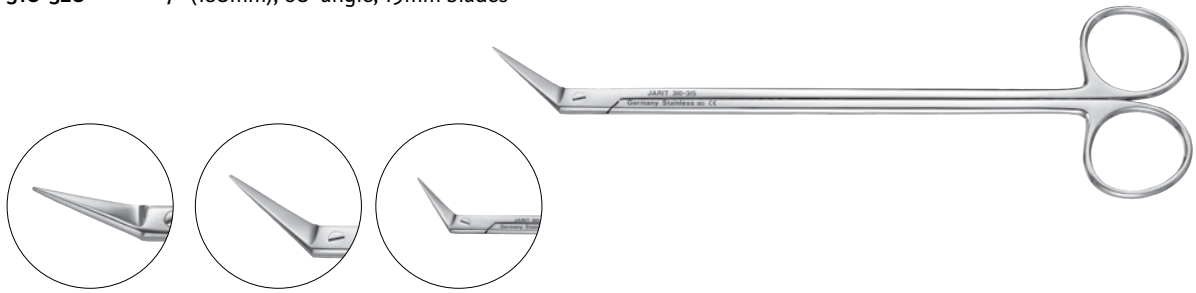

Potts-Smith Vascular Scissors, Supercut

Catalog #	Description
102-320	7½" (189mm), 25° angle, 22mm blades
102-321	7¼" (185mm), 45° angle, 20mm blades
102-322	7" (180mm), 60° angle, 19mm blades

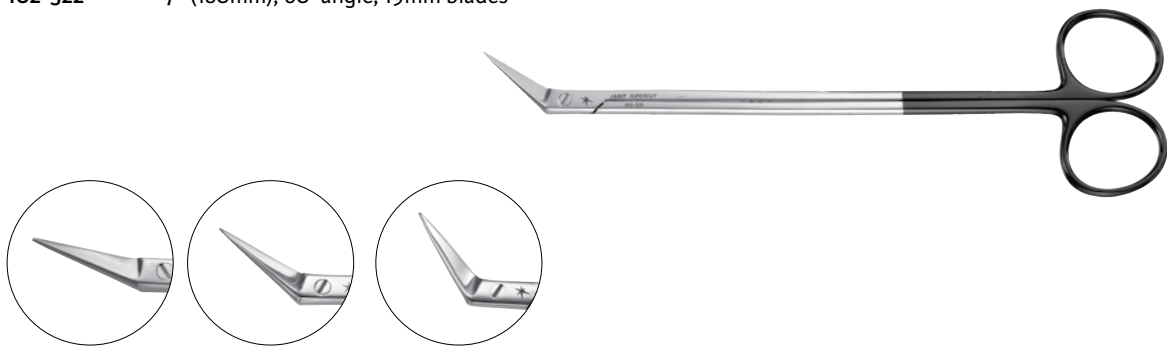

DeBakey-Potts Vascular Scissors, 23mm Blades

Catalog #	Description
310-332	6½" (168mm), 25° angle
310-333	6½" (168mm), 45° angle
310-334	6¼" (158mm), 60° angle

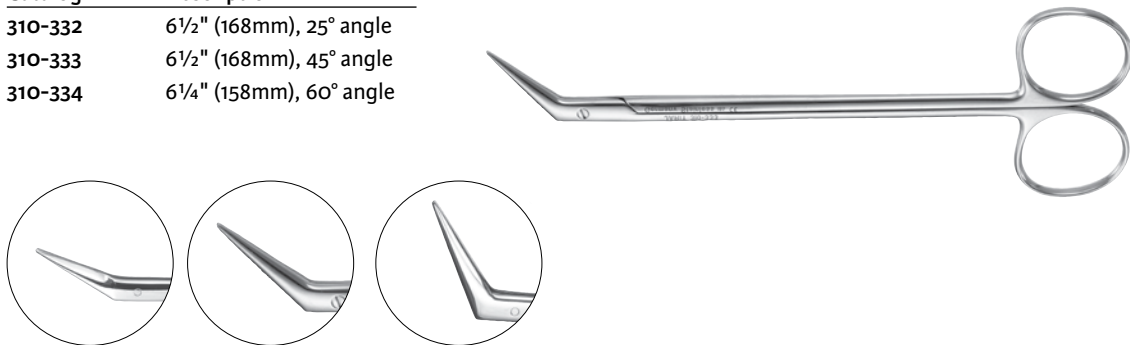

DeBakey Vascular Scissors, 23mm Blades

Catalog #	Description
310-340	6½" (168mm), 25° angle
310-341	6½" (168mm), 45° angle
310-342	6¼" (158mm), 60° angle
310-343	9" (230mm), 25° angle
310-344	9" (230mm), 45° angle
310-345	8¾" (221mm), 60° angle



Diethrich Coronary Artery Scissors

Catalog #	Description
310-350	7" (182mm), 12mm blades, 25° angle
310-351	7" (180mm), 13mm blades, 45° angle
310-352	7" (177mm), 13mm blades, 60° angle
310-353	7" (172mm), 13.5mm blades, 90° angle
310-354	7" (172mm), 12.5mm blades, 125° angle



Diethrich Coronary Artery Scissors, Extra Delicate Blade

Catalog #	Description
311-350	7" (182mm), 14mm blades, 25° angle
311-351	7" (180mm), 14mm blades, 45° angle
311-352	7" (177mm), 14mm blades, 60° angle
311-353	7" (176mm), 14mm blades, 90° angle
311-354	7" (176mm), 14mm blades, 125° angle

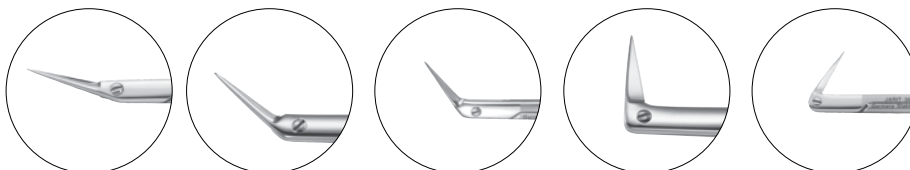

Diethrich Coronary Artery Scissors, Supercut

Catalog #	Description
102-350	7¼" (182mm), 25° angle, 12mm blades
102-351	7" (180mm), 45° angle, 13mm blades
102-352	7" (177mm), 60° angle, 13mm blades
102-353	6¾" (170mm), 90° angle, 13.5mm blades
102-354	6¾" (172mm), 125° angle, 11mm blades



Diethrich Circumflex Artery Scissors, with Stabilizing Bar

Catalog #	Description
310-360	6¾" (172mm), 130° angle, 13mm blades

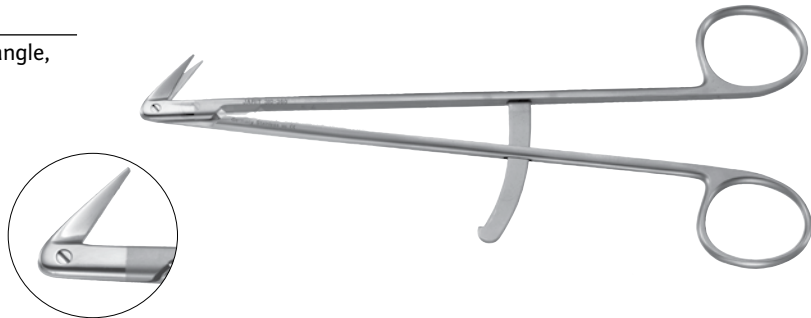

Diethrich Circumflex Artery Scissors, with Stabilizing Bar, Supercut

Catalog #	Description
102-360	6¾" (172mm), 130° angle, 13mm blades



Diethrich-Potts Peripheral Vascular Scissors

Catalog #	Description
310-355	5 ³ / ₈ " (138mm), 25° angle, 12mm blades
310-356	5 ³ / ₈ " (138mm), 45° angle, 13mm blades
310-357	5 ¹ / ₄ " (133mm), 60° angle, 13mm blades
310-358	5" (126mm), 90° angle, 13.5mm blades

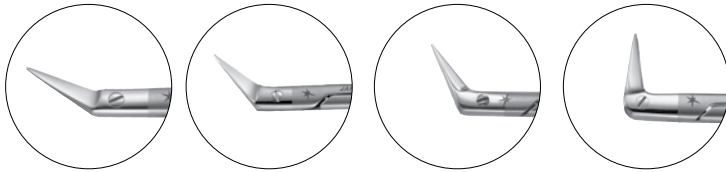

Favaloro Coronary Artery Scissors

Catalog #	Description
310-374	6 ³ / ₄ " (170mm), 130° angle, 9.5mm blades



Favaloro Coronary Artery Scissors, Supercut

Catalog #	Description
102-374	6 ¹ / ₄ " (158mm), 125° angle, 9.5mm blades



Karmody In-Situ Valve Scissors

Catalog #	Description
310-535	6" (152mm), working shaft, serrated blades, blunt tips

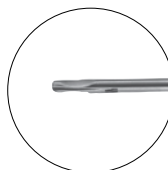

Valve Leaflet Excision Scissors

Catalog #	Description
310-540	4 ³ / ₈ " (110mm), 45° angled on the flat



Potts Finger Arteriotomy Scissors

Catalog #	Description
310-542	5 ³ / ₈ " (135mm), 45° angled to the flat

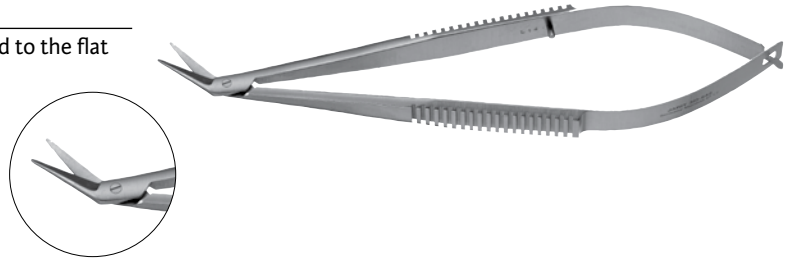

Dennis Micro Scissors, Round Handle, Counter Balanced

7¹/₄" (184mm), double action, 9mm micro blades

Catalog #	Description
277-058	Straight blades
277-059	Curved blades



Jacobson Micro Scissors, Flat Handle

Catalog #	Description
277-120	7" (180mm), straight, 15mm blades
277-121	7" (180mm), curved, 15mm blades
277-122	6 ³ / ₄ " (172mm), angled to the side, 10mm blades

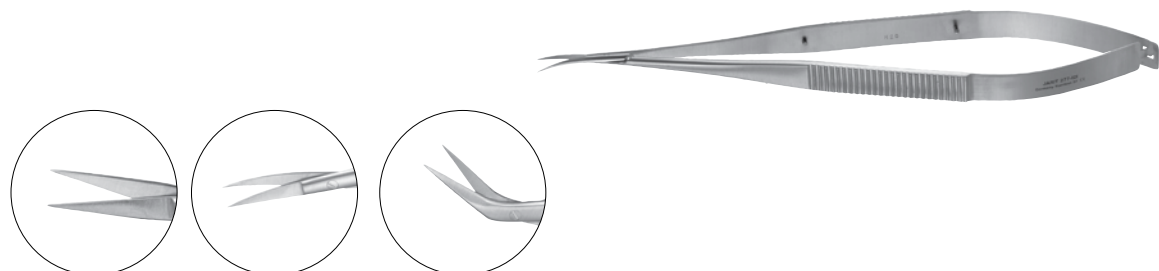

Jacobson Micro Scissors, Flat Handle, Bayonet

Catalog #	Description
277-130	7¼" (185mm), straight, 13mm regular blades
277-131	7¼" (185mm), curved, 13mm regular blades
277-132	7¼" (185mm), angled on edge, 10mm regular blades
277-135	7¼" (185mm), straight, 11mm micro blades
277-136	7¼" (185mm), curved, 11mm micro blades

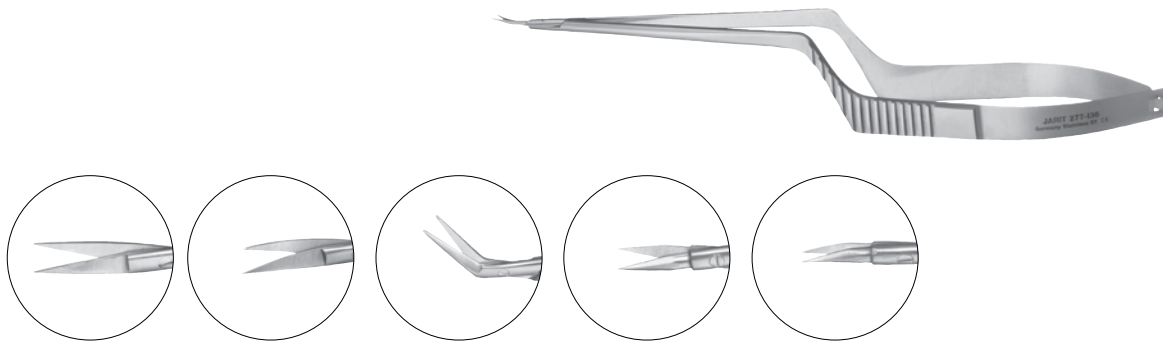

Jacobson Micro Scissors, Round Handle

Micro Fine 9mm Blades

Catalog #	Description
277-335	6¾" (170mm), 25° angle
277-336	6¾" (170mm), 45° angle
277-337	6¾" (170mm), 60° angle
277-338	6½" (165mm), 90° angle
277-339	6½" (165mm), 120° angle

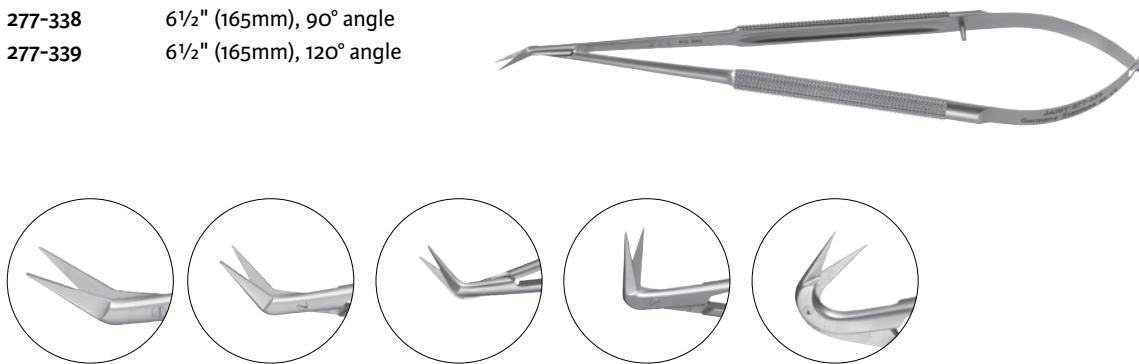

Jacobson Micro Scissors, Flat Wide Handle

micro fine 9mm blades

Catalog #	Description
277-330	6½" (165mm), 25° angle
277-331	6½" (165mm), 45° angle
277-332	6½" (165mm), 60° angle
277-333	6¼" (159mm), 90° angle
277-334	6¼" (159mm), 120° angle

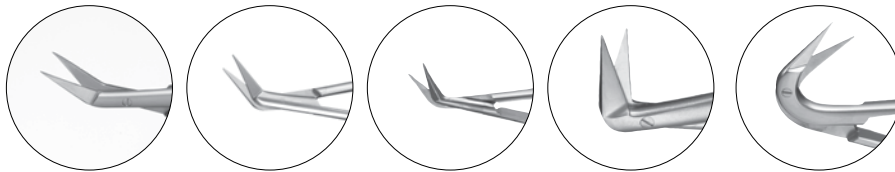

Jacobson Micro Scissors, Flat Handle

7" (178mm), 12mm blades

Catalog #	Description
277-123	Straight blades, blunt tips
277-124	Curved blades, blunt tips

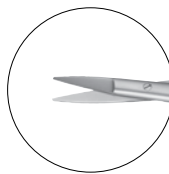

Brolly-Adson Forceps, 1.2mm tips

Catalog #	Description
130-246	6" (152mm), straight, serrated tips
130-247	6" (152mm), curved, serrated tips
130-248	6" (152mm), straight, Stardust tips
130-249	6" (152mm), straight, 1 x 2 teeth

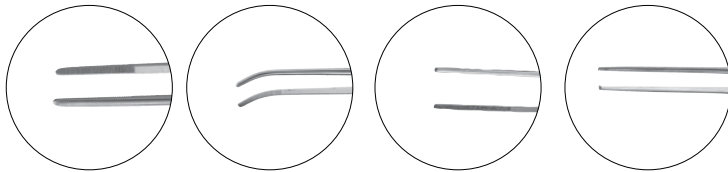

Brown Tissue Forceps, double row of 8 x 8 teeth

Catalog #	Description
130-265	6" (151mm)
130-266	8" (202mm)
130-267	10" (251mm)



Nelson Tissue Forceps, 6 x 7 teeth

Catalog #	Description
130-370	6" (151mm)
130-375	7" (178mm)
130-280	9" (228mm)



Russian Tissue Forceps, (Mirror Finish)

Manufactured from high grade German surgical stainless steel which is ground and polished to a mirror finish

Catalog #	Description
130-390	5 7/8" (150mm)
130-392	7 3/4" (200mm)
130-395	10 1/4" (258mm)
130-394	12" (305mm)
130-396	14" (355mm)

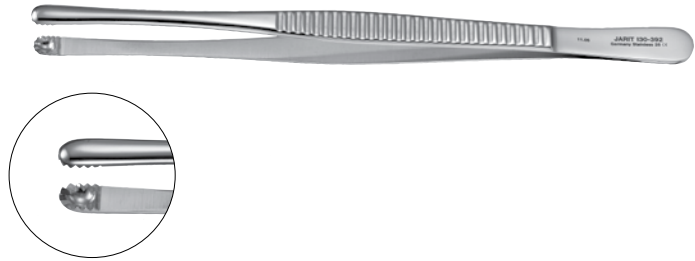

Russian Tissue Forceps, (Matte Finish)

Manufactured from high grade German surgical stainless steel which is glass beaded to a matte finish

Catalog #	Description
129-390	5 7/8" (150mm)
129-392	7 3/4" (200mm)
129-395	10 1/4" (258mm)

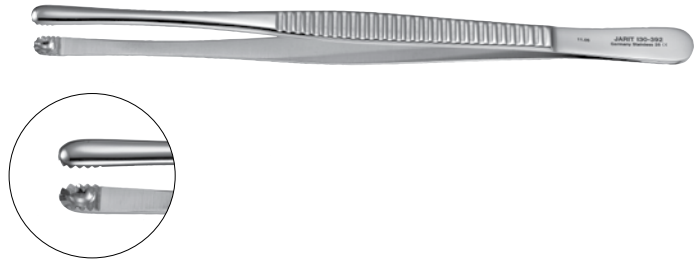

Singley Tissue Forceps

Catalog #	Description
135-250	9" (229mm)
135-248	14" (356mm)



Selman Tissue Forceps

3.8mm round cup with teeth

Catalog #	Description
135-252	6" (155mm)
135-253	8" (205mm)
135-254	9 3/4" (250mm)



Wangensteen Tissue Forceps, Carb-Bite

Catalog #	Description
135-256	6" (151mm)
135-257	9" (230mm)
135-258	10" (257mm)



Mills Coronary Mammary Tissue Forceps

Catalog #	Description
310-528	7" (180mm), ring tip (1.0mm OD x 0.5mm ID)



Wheeler-Type Plaque and Vessel Forceps, Cardio-Grip™ Serrations

Catalog #	Description
130-296	5 5/8" (142mm)
130-297	7 1/4" (182mm)
130-298	9" (226mm)

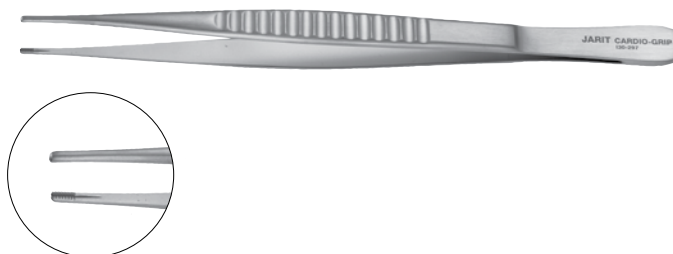

Reul Coronary Tissue Forceps, Delicate, Carb-Bite

Catalog #	Description
130-437	8" (206mm), 1.6mm wide x 12mm length jaw



Potts-Smith Dressing Forceps, Serrated

Catalog #	Description
130-350	7" (180mm)
130-355	8¼" (209mm)
130-360	9¾" (249mm)
130-367	10¼" (260mm)
130-365	11¾" (301mm)

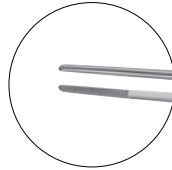

Potts-Smith Tissue Forceps, 1 x 2 teeth

Catalog #	Description
130-352	7¼" (184mm)
130-357	8¼" (210mm)
130-362	9¾" (249mm)
130-368	10¼" (260mm)
130-366	12" (305mm)

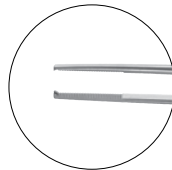

Potts-Smith Tissue Forceps, Carb-Bite

Catalog #	Description
130-353	7¼" (184mm)
130-358	8" (202mm)
130-363	9½" (241mm)
130-369	10¼" (261mm)

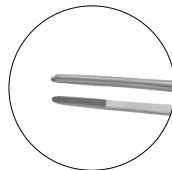

Evans Tissue Forceps, Carb-Bite

Catalog #	Description
130-383	9¾" (250mm)

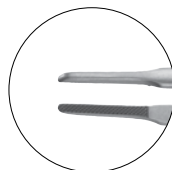

Cushing Dressing Forceps

straight, serrated, scraper end

Catalog #	Description
130-400	6¾" (170mm), 1.5mm tip
130-445	7¾" (200mm), 2mm tip

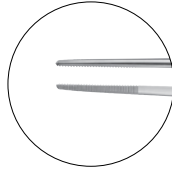

Cushing Tissue Forceps

straight, 1 x 2 teeth, scraper end

Catalog #	Description
130-405	6¾" (171mm), 1.5mm tip
130-446	7¾" (200mm), cross serrated, 2mm tip

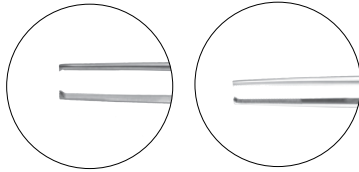

Cushing Dressing Forceps

bayonet, serrated, scraper end

Catalog #	Description
130-410	7¼" (183mm), 1.7mm tip
130-420	7¾" (200mm), 1.9mm tip

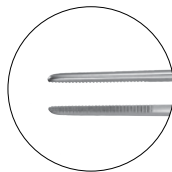

Cushing Tissue Forceps

bayonet, 1 x 2 teeth, scraper end

Catalog #	Description
130-415	7¼" (181mm), 1.7mm tip
130-421	7¾" (200mm), 1.7mm tip



Cushing Dressing and Tissue Forceps

Gutsch handle, straight, scraper end

Catalog #	Description
130-425	7" (178mm), serrated, 1.5mm wide tips
130-430	7" (178mm), 1 x 2 teeth, 1.5mm wide tips
130-435	7" (178mm), 1 x 2 teeth, serrated, 1.5mm wide tips

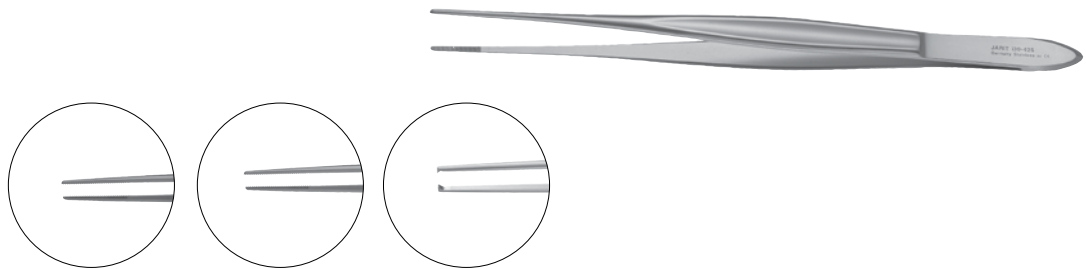

Cushing Needle and Tissue Pulling Forceps, Carb-Bite

straight, semi-sharp dissecting end, Gutsch handle

Catalog #	Description
122-530	7" (176mm), 1.8mm wide x 12mm length jaw, standard
122-535	7" (176mm), 1.6mm wide x 12mm length jaw, delicate



Cushing Tissue Forceps, Carb-Bite

square dissecting end, Gutsch handle

Catalog #	Description
130-417	7" (176mm), 1.8mm wide x 12mm length jaw, angled



Cushing Dressing Forceps, Carb-Bite

square dissecting end, bayonet

Catalog #	Description
130-418	7½" (191mm), 1.8mm wide x 14mm length jaw

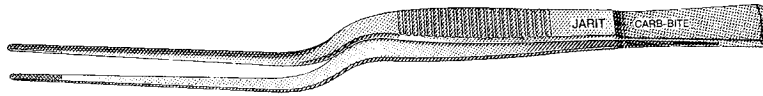

Cushing-Brown Tissue Forceps

double row of 9 x 9 delicate teeth, scraper end

Catalog #	Description
130-440	6¾" (174mm), straight

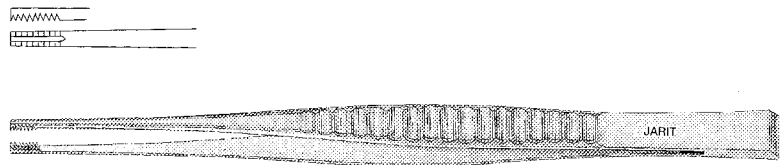

Cushing-Brown Tissue Forceps

bayonet, double row of 9 x 9 delicate teeth, scraper end

Catalog #	Description
130-442	7" (180mm)

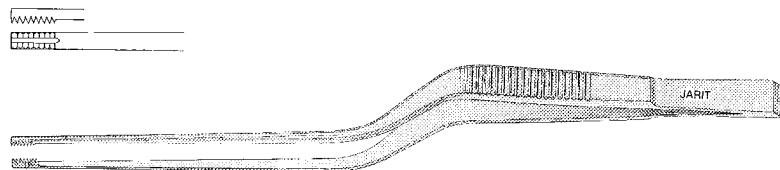

Gerald Forceps, Cardio-Grip (DeBakey) Type Teeth

straight, 1.2mm wide tips

Catalog #	Description
285-126	7" (180mm)
285-132	7¾" (200mm)
285-130	9½" (240mm)

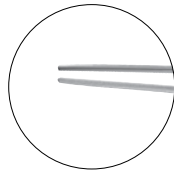

Gerald Dressing Forceps

straight, narrow, 1.3mm wide tips

Catalog #	Description
285-120	7" (175mm), serrated tips
285-128	9¼" (233mm), serrated tips
285-135	9¾" (250mm), cross-serrated tips

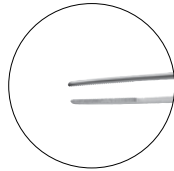

Gerald Tissue Forceps

straight, narrow, 1 x 2 teeth

Catalog #	Description
285-125	7" (176mm), 1.3mm wide tips
285-127	7½" (192mm), 1.4mm wide tips
285-129	9¼" (233mm), 1.4mm wide tips

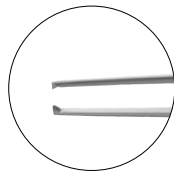

Gerald Needle and Tissue Pulling Forceps, Carb-Bite

straight, 1 x 2 teeth, 12mm length serrated tips

Catalog #	Description
122-570	7" (176mm), 1.2mm wide tips

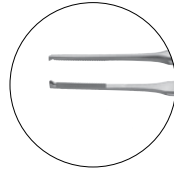

Bonney Needle and Tissue Pulling Forceps, Carb-Bite

straight, 1 x 2 teeth

Catalog #	Description
122-520	6¾" (173mm), 3.4mm wide tips

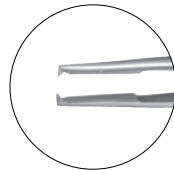

DeBakey Needle and Tissue Pulling Forceps, Carb-Bite

straight, 3 x 6 teeth, 2.0mm tips

Catalog #	Description
122-540	5⅞" (150mm)
122-542	7¾" (197mm)
122-544	9½" (240mm)

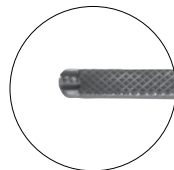

DeBakey Needle and Tissue Pulling Forceps, Carb-Bite

straight, 3 x 6 teeth, 1.5mm wide tips

Catalog #	Description
122-541	5 ⁷ / ₈ " (150mm)
122-543	7 ³ / ₄ " (197mm)
122-545	9 ¹ / ₂ " (240mm)

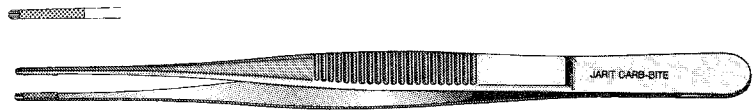

Ferris-Smith Needle and Tissue Pulling Forceps, Carb-Bite

1 x 2 teeth, 12.5mm length serrated tips

Catalog #	Description
122-550	6 ³ / ₄ " (174mm), 3mm wide tips



Semkin Needle and Tissue Pulling Forceps, Carb-Bite

6" (153mm), 1 x 2 teeth, 12mm length serrated tips

Catalog #	Description
122-590	Standard, 1.7mm wide tips
122-591	Delicate, 1mm wide tips

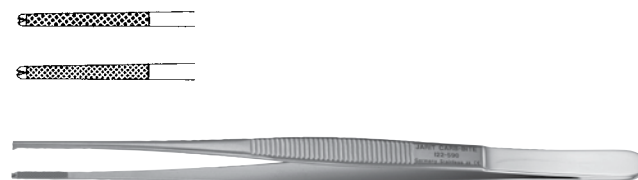

Skinner Needle and Tissue Pulling Forceps, Carb-Bite

9¼" (232mm), 1 x 2 teeth, 8mm length serrated tips

Catalog #	Description
122-600	Standard, 4.5mm wide tips
122-601	Delicate, 2.6mm wide tips
122-602	Micro, 2mm wide tips



DeBakey-Diethrich Vascular Tissue Forceps

straight, extra delicate, 1mm tips

Catalog #	Description
320-050	6" (152mm), 20mm length serrated tips
320-051	7 ³ / ₄ " (197mm), 20mm length serrated tips
320-052	9 ¹ / ₂ " (241mm), 20mm length serrated tips

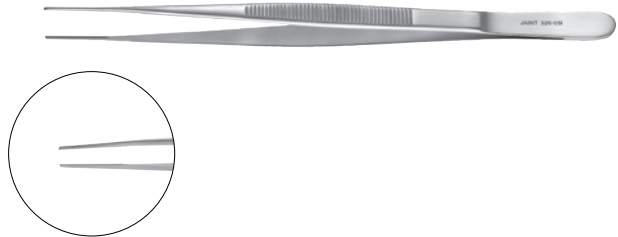

DeBakey-Diethrich Coronary Artery Forceps

straight, delicate, 1.5mm tips

Catalog #	Description
320-113	5 ⁷ / ₈ " (150mm), 24mm length serrated tips
320-114	7 ³ / ₄ " (195mm), 24mm length serrated tips
320-115	9 ¹ / ₂ " (240mm), 24mm length serrated tips
320-099	11 ³ / ₄ " (300mm), 24mm length serrated tips



DeBakey Vascular Tissue Forceps

angled, standard, 2mm tips

Catalog #	Description
320-105	5 ⁷ / ₈ " (148mm), 21.5mm length serrated tips
320-106	7 ¹ / ₂ " (192mm), 21.5mm length serrated tips
320-107	9 ¹ / ₄ " (237mm), 21.5mm length serrated tips

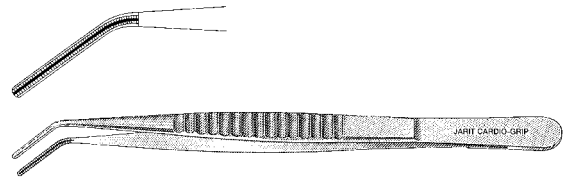

DeBakey Vascular Tissue Forceps

straight, standard, 2mm tips

Catalog #	Description
320-110	5 ⁷ / ₈ " (150mm), 24mm length serrated tips
320-111	7 ³ / ₄ " (195mm), 24mm length serrated tips
320-112	9 ¹ / ₂ " (240mm), 24mm length serrated tips
320-109	11 ³ / ₄ " (300mm), 24mm length serrated tips
320-108	14 ¹ / ₄ " (360mm), 24mm length serrated tips



DeBakey Thoracic Tissue Forceps

straight, heavy, 2.8mm tips

Catalog #	Description
320-100	5 ⁷ / ₈ " (150mm), 24mm length serrated tips
320-101	7 ³ / ₄ " (195mm), 24mm length serrated tips
320-102	9 ¹ / ₂ " (240mm), 24mm length serrated tips
320-103	11 ³ / ₄ " (300mm), 24mm length serrated tips
320-104	14 ¹ / ₄ " (360mm), 24mm length serrated tips



DeBakey Thoracic Tissue Forceps

straight, extra heavy, 3.2mm tips

Catalog #	Description
320-070	5 ⁷ / ₈ " (150mm), 24mm length serrated tips
320-071	7 ³ / ₄ " (195mm), 24mm length serrated tips
320-072	9 ¹ / ₂ " (240mm), 24mm length serrated tips
320-073	11 ³ / ₄ " (300mm), 24mm length serrated tips
320-074	14 ¹ / ₄ " (360mm), 24mm length serrated tips

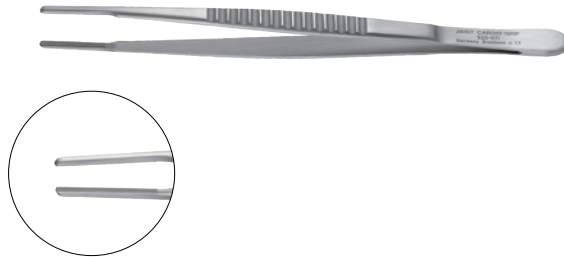

Cooley Vascular Tissue Forceps

straight, standard, 2mm tips

Catalog #	Description
320-116	5 ⁷ / ₈ " (150mm), 24mm length serrated tip
320-117	7 ³ / ₄ " (195mm), 24mm length serrated tips
320-118	9 ¹ / ₂ " (240mm), 24mm length serrated tips

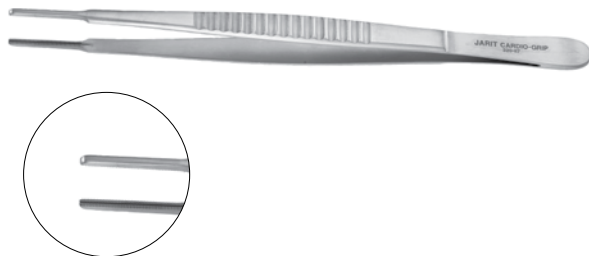

Cooley Vascular Tissue Forceps

straight, delicate, 1.2mm cross-serrated tips

Catalog #	Description
320-119	7 ³ / ₄ " (200mm), 1.2mm wide x 18mm length serrated tips

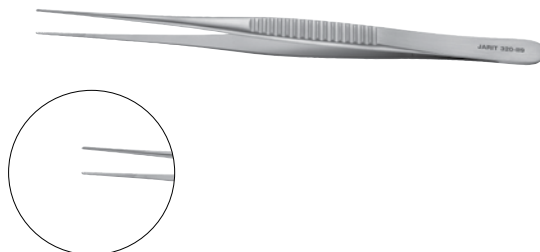

Microsurgical Forceps with Platform

7" (180mm) round handle

Catalog #	Description
277-040	Straight, 0.5mm micro tip
277-044	Curved, 0.5mm micro tip
277-042	Straight, 1mm micro tip
277-046	Curved, 1mm micro tip
277-041	Straight, 0.5mm 1 x 2 teeth
277-045	Curved, 0.5mm 1 x 2 teeth
277-043	Straight, 1mm 1 x 2 teeth
277-047	Curved, 1mm 1 x 2 teeth

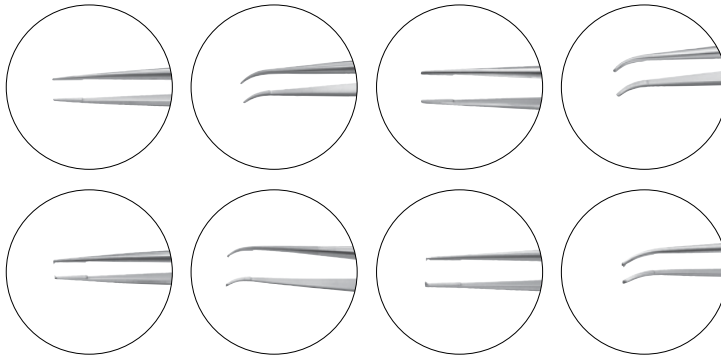

Rhoton-Type Suture Tying Forceps, Round Handle with Platform Tips

6mm platform

Catalog #	Description
277-049	7" (180mm), straight

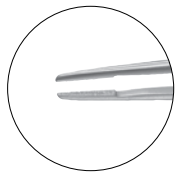

Micro Suture Tying Forceps, Round Handle with Platform Tips

6mm platform

Catalog #	Description
277-080	6" (152mm), straight
277-081	6" (152mm), curved

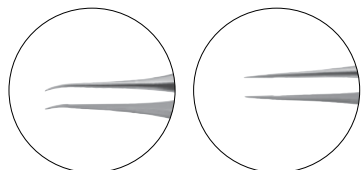

Micro Forceps, Round Handle, Stardust

straight, extra delicate, .8mm micro tips

Catalog #	Description
279-149	7¼" (181mm)



Micro Forceps, Round Handle, Stardust

straight, delicate, 1mm platform tips

Catalog #	Description
279-100	7¼" (184mm), straight
279-101	8¼" (210mm), straight
279-102	9" (229mm), straight



Micro Forceps, Round Handle, Stardust

curved, delicate, 1mm platform tips

Catalog #	Description
279-105	7¼" (184mm), straight
279-106	8¼" (210mm), straight
279-107	9" (229mm), straight

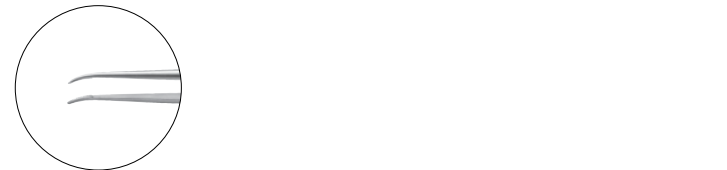

Micro Forceps, Round Handle, Stardust

straight, delicate, 1mm 1 x 2 teeth

Catalog #	Description
279-150	7¼" (181mm), straight



Dennis Micro Forceps, Round Handle, Counter Balance

delicate, 1mm Stardust platform tips

Catalog #	Description
279-158	7" (178mm), straight
279-159	7" (178mm), curved
279-125	8¼" (212mm), straight

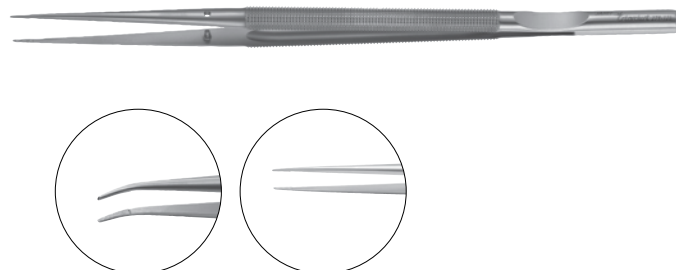

Micro Ring Forceps, Stardust

delicate, 1mm ring tips

Catalog #	Description
279-110	7¼" (184mm), straight
279-130	7¼" (181mm), curved
279-111	8¼" (210mm), straight
279-131	8¼" (210mm), curved
279-112	9" (229mm), straight

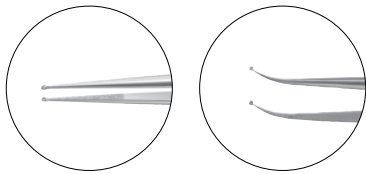

Dennis Micro Ring Forceps, Round Handle, Counter Balance

delicate, 1mm Stardust tips

Catalog #	Description
279-113	6" (152mm), straight
279-114	6" (152mm), curved
279-115	7¼" (186mm), straight
279-116	7¼" (186mm), curved
279-117	8¼" (209mm), straight
279-118	8¼" (209mm), curved
279-119	9" (230mm), straight
279-120	9" (230mm), curved
279-121	10" (254mm), straight
279-122	10" (254mm), curved

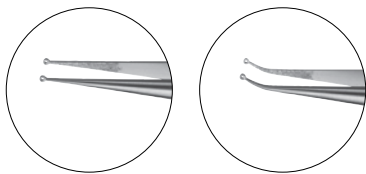

Pennington Tissue Forceps

Catalog #	Description
305-200	8¼" (212mm), jaw width 10mm

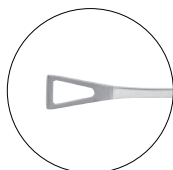

Collins Tissue Forceps

Catalog #	Description
305-205	9" (229mm), jaw width 25mm

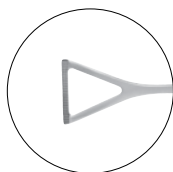

Duval Lung Forceps

Catalog #	Description
305-210	8" (205mm), jaw width 28mm
305-215	9" (228mm), jaw width 28mm

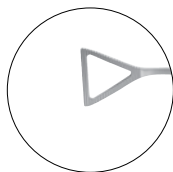

Lovelace Lung Forceps

Catalog #	Description
305-220	7¼" (186mm), jaw width 28mm

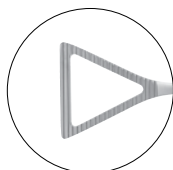

Allis-Willauer Tissue Forceps

5 x 6 teeth

Catalog #	Description
305-230	10" (255mm), jaw width 6.5mm
305-231	11" (282mm), jaw width 5.7mm
305-233	13¾" (350mm), jaw width 5.7mm

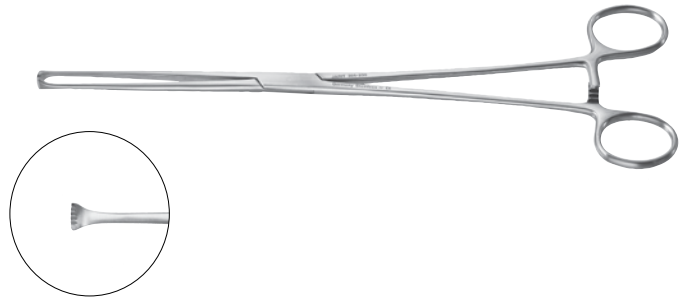

Kantrowitz Thoracic Forceps

Catalog #	Description
305-294	6" (152mm)
305-295	7¾" (195mm)
305-296	9½" (240mm)
305-297	10¾" (272mm)



Petit-Point Jacobson Mosquito Forceps, very delicate

Catalog #	Description
105-092	7¼" (185mm), slightly curved
105-093	7¼" (185mm), fully curved

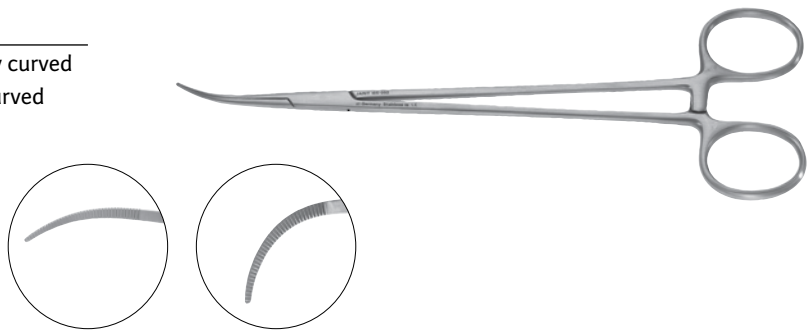

Ochsner Forceps, Very Fine Serrated Jaws

Catalog #	Description
105-235	4⅝" (116mm), 90 degree angle

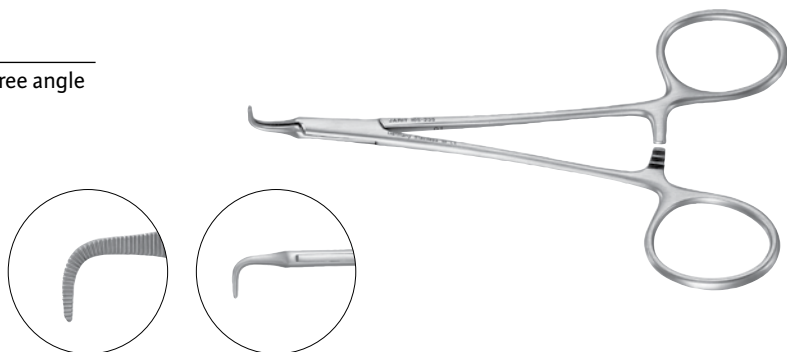

Bainbridge Forceps, Longitudinal Serrations

Catalog #	Description
105-300	5 ⁷ / ₈ " (150mm), 40mm length jaws
105-302	5 ⁷ / ₈ " (150mm), 40mm length jaws
105-304	7 ¹ / ₄ " (185mm), 60mm length jaws
105-306	7 ¹ / ₄ " (185mm), 60mm length jaws



Bainbridge Forceps, DeBakey serrations

Catalog #	Description
320-228	8" (203mm), straight, delicate, 63mm jaws
320-229	8" (203mm), curved, delicate, 61mm jaws



Diethrich Right Angle Clamps

Catalog #	Description
140-232	4 ⁷ / ₈ " (124mm)
140-233	5 ³ / ₈ " (138mm)
340-234	7" (180mm)

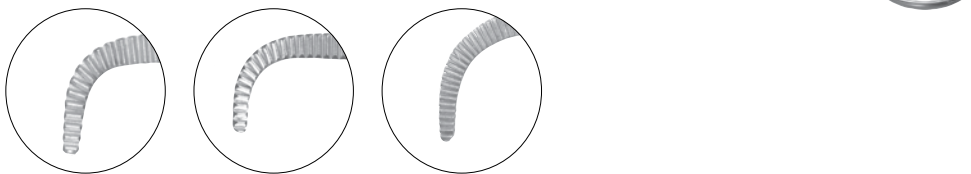

Gemini Artery Clamps

Catalog #	Description
140-329	5 ³ / ₈ " (137mm)
140-330	7 ¹ / ₂ " (190mm)
140-331	8" (205mm)
140-332	9" (230mm)
140-333	11" (280mm)
140-335	14 ¹ / ₄ " (360mm)



Coller Artery Forceps, Full Horizontal Serrations

Catalog #	Description
105-330	Slight curve, 9¼" (238mm)
105-331	Strong curve, 9¼" (234mm)
105-332	Right angle, 8¾" (225mm)

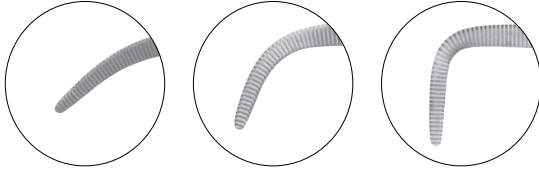

Storey Artery Forceps, Cross Serrations

Catalog #	Description
105-340	Slight curve, 8¾" (225mm)
105-341	Strong curve, 8¾" (225mm)
105-342	Right angle, 8½" (214mm)

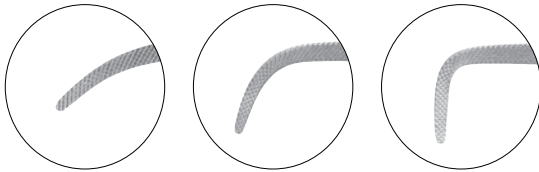

Meeker Artery Clamp

Catalog #	Description
140-231	7¼" (181mm)
305-300	10¾" (275mm)



Lawrence Forceps

Catalog #	Description
305-305	7¼" (187mm)
305-306	11" (280mm)

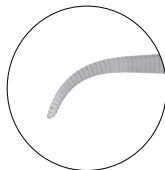

Bridge Deep Surgery Forceps

Catalog #	Description
305-308	Curved, 7½" (191mm)
305-309	Straight, 11" (279mm)
305-310	Curved, 11" (279mm)

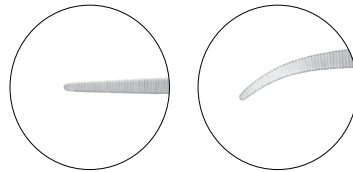

Julian Thoracic Artery Forceps

Catalog #	Description
305-320	9½" (240mm), slightly curved

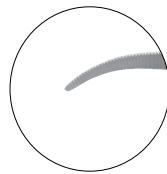

Woodward Thoracic Artery Forceps

Catalog #	Description
305-325	8¾" (220mm), slightly curved

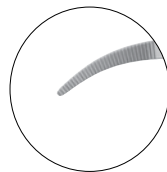

Thoracic Mosquito Forceps

Catalog #	Description
305-330	7¼" (184mm)
305-332	7¼" (185mm)
305-337	9¼" (232mm)



Heiss Artery Forceps

8" (205mm)

Catalog #	Description
305-350	Straight
305-351	Half curved
305-352	Full curved

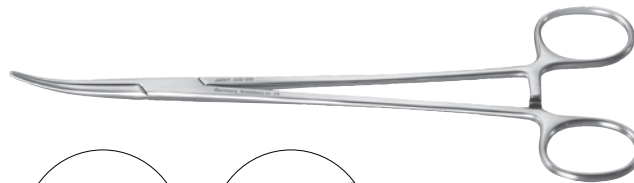
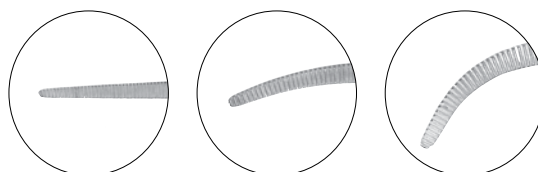

Vanderbilt University Deep Vessel Clamp

Catalog #	Description
305-355	9" (228mm)

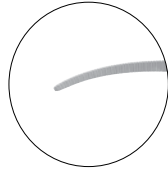

Bengolea Forceps

Catalog #	Description
305-359	8½" (215mm)

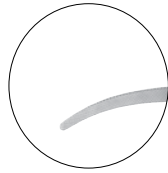

Crafoord (Coller) Artery Forceps

Catalog #	Description
305-360	7½" (191mm)
305-362	9¾" (248mm)

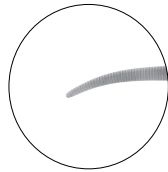

Sarot Artery Forceps

Catalog #	Description
305-363	7¾" (195mm)
305-365	9¾" (248mm)
305-366	13¾" (350mm)

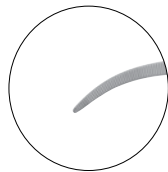

DeBakey-Collier Artery Forceps

Catalog #	Description
305-367	8" (202mm)
305-368	10" (253mm)
305-369	14" (356mm)

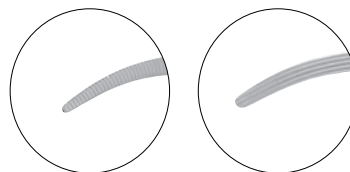

Lahey Gall Duct Forceps

Catalog #	Description
140-205	7½" (191mm)
140-206	7¾" (195mm), delicate
140-228	7½" (190mm), cross serrated tips

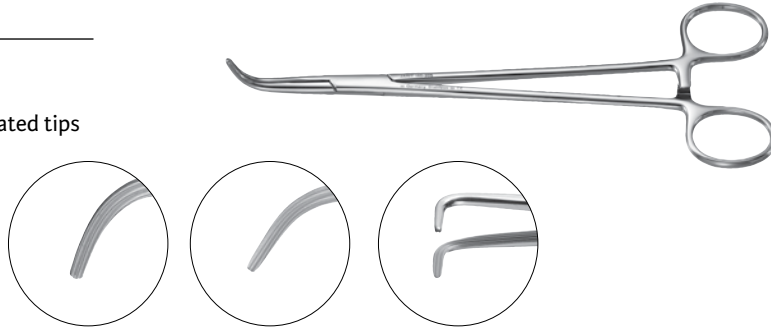

Lahey Thoracic Forceps

Catalog #	Description
305-370	9" (226mm), full curved
305-372	9" (228mm), full curved, delicate
305-373	8½" (216mm), 90° angle, delicate

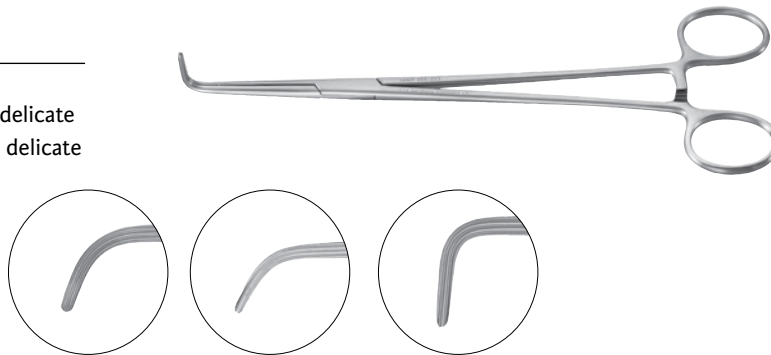

Mixer Forceps, Pediatric

Catalog #	Description
140-216	5¾" (138mm), curved
140-217	5" (127mm), right angle

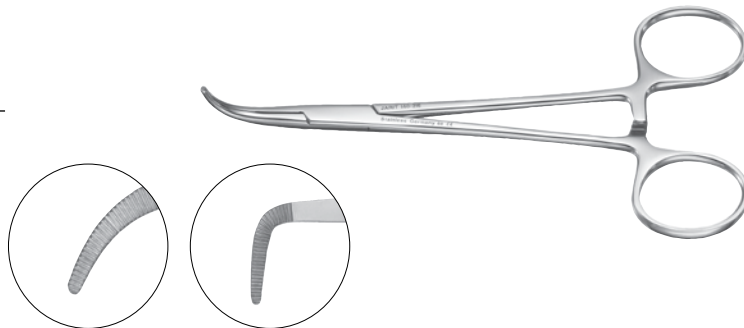

Petit-Point Mixer Forceps

right angle

Catalog #	Description
140-218	5¾" (137mm), partial jaw serrations

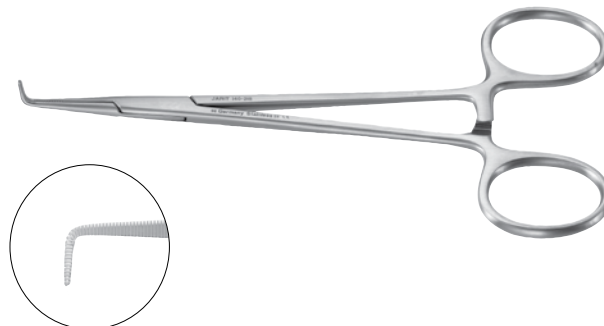

Petit-Point Mixer Forceps

right angle

Catalog #	Description
140-223	7¼" (185mm), full jaw serrations

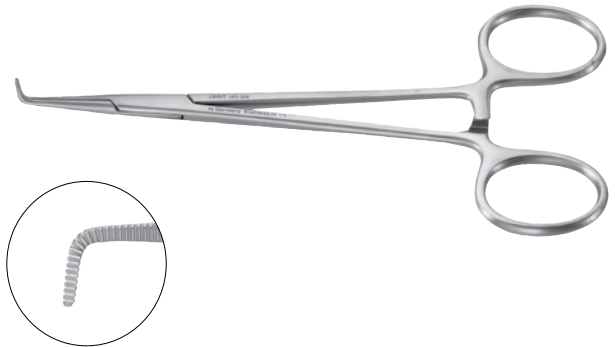

Mixer Forceps, Full Horizontal Serrations

Catalog #	Description
140-224	6¼" (160mm)
140-225	7" (175mm)

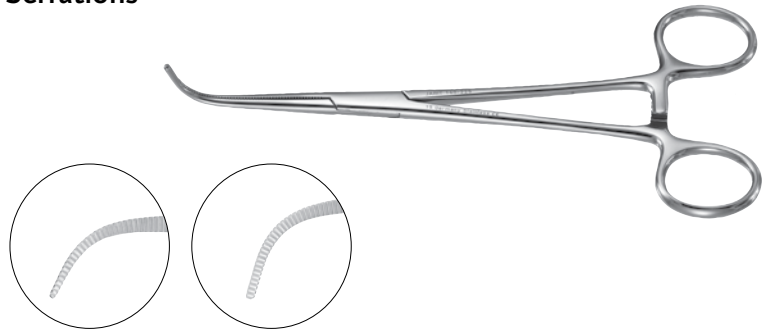

Mixer Forceps, Partial Horizontal Serrations

Catalog #	Description
140-226	8¾" (224mm)
140-230	9¼" (232mm)

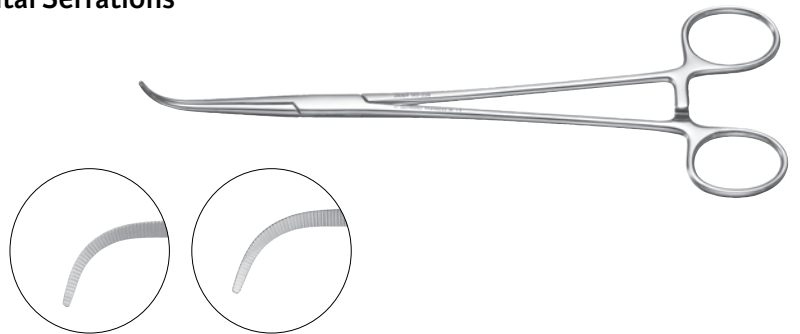

Mixer Forceps, Longitudinal Serrations

Catalog #	Description
305-380	10¾" (274mm), full curved



Mixer Forceps

11" (280mm), delicate

Catalog #	Description
305-385	Horizontal serrations
305-386	Longitudinal serrations with cross serrated tips

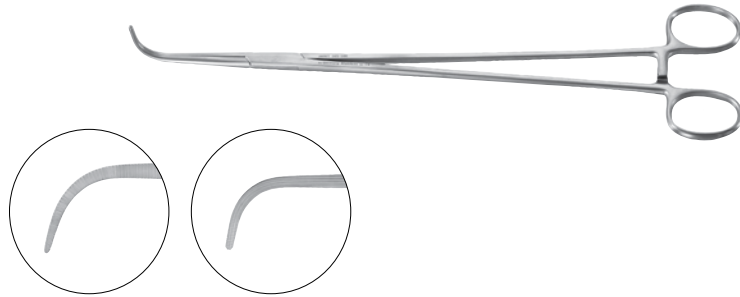

Mixer Forceps, Longitudinal Serrations

delicate, cross serrated tips

Catalog #	Description
305-388	8¾" (220mm)
305-389	10¼" (260mm)

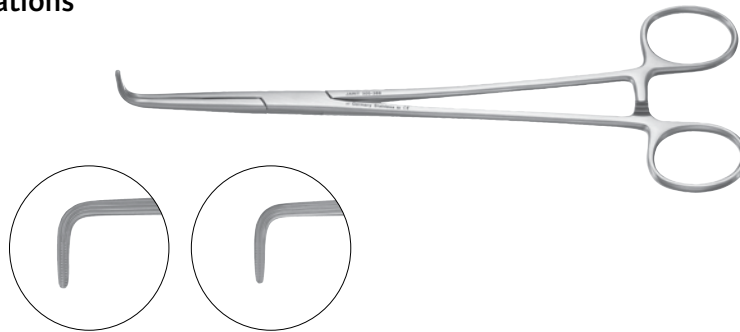

Harrington Mixer Forceps, Longitudinal Serrations

right angle

Catalog #	Description
305-390	12" (305mm), heavy pattern
305-395	12¼" (311mm), light pattern
305-396	14¼" (360mm), light pattern

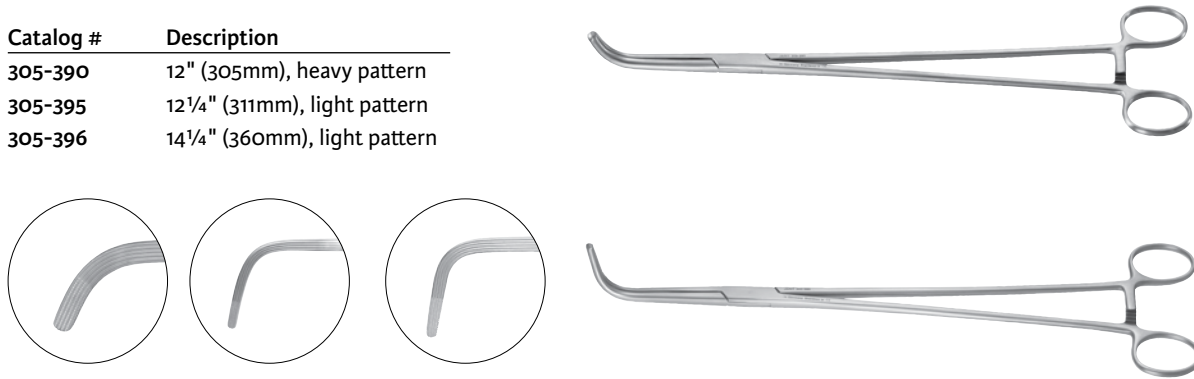

Carmalt Forceps, Cross-Serrated Tips

Catalog #	Description
305-397	12¼" (313mm), jaw length 2¾" (71mm)



Rochester-Pean Forceps

Catalog #	Description
305-398	11¾" (300mm), jaw length 3⅞" (99mm)
305-399	14" (354mm), jaw length 4⅜" (111mm)

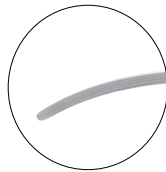

Rummel Thoracic Artery Forceps

Catalog #	Description
305-400	"A" curve, 9½" (240mm)
305-401	"B" curve, 9½" (240mm)
305-402	"C" curve, 9¼" (235mm)
305-403	"D" curve, 9" (230mm)

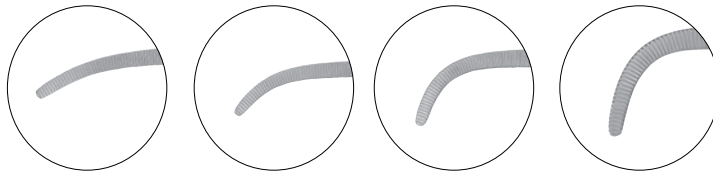

DeBakey Thoracic Dissecting Forceps, Cardio-Grip

Catalog #	Description
305-405	8" (203mm), "C" curve
305-406	8" (203mm), "D" curve
305-407	8½" (216mm), "C" curve
305-408	8½" (216mm), "D" curve

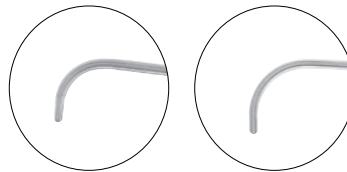

Jones Thoracic Clamp

Catalog #	Description
305-431	9" (229mm)

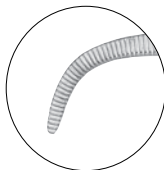

Semb Ligature Carrier

Catalog #	Description
305-441	9½" (240mm)



DeBakey-Semb Ligature Carrier

Catalog #	Description
320-274	11" (280mm), jaw working length 3" (75mm), length of serrations ¾" (20mm)

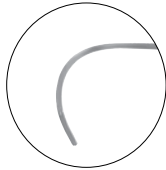

Sarot Bronchus Clamps

8¾" (225mm), total jaw length 2¾" (60mm), jaw working length 1¾" (35mm)

Catalog #	Description
305-450	Right
305-451	Left

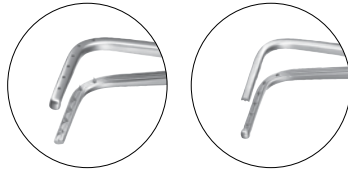

Rummel Tourniquets

Catalog #	Description
305-500	Adult size, 12" (307mm)
305-501	Child size, 8¼" (209mm)
305-498	Obturator only, adult size (Crochet Hook), 11" (280mm)
305-499	Obturator only, child size (Crochet Hook), 8½" (215mm)

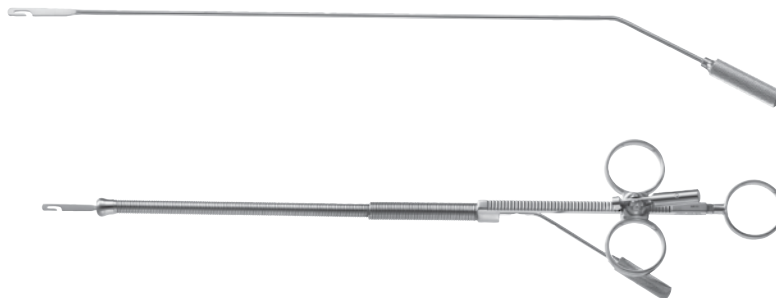

Webster Needle Holders, Carb-Bite

3600 teeth per square inch, for use with 5.0 and 6.0 suture

Catalog #	Description
121-119	4 ⁵ / ₈ " (118mm), serrated jaws
121-118	4 ⁵ / ₈ " (118mm), smooth jaws



Fell Needle Holders, Carb-Bite

4000 teeth per square inch, for use with 2.0, 3.0 and 4.0 suture

Catalog #	Description
121-270	5 ¹ / ₄ " (132mm), 1.8mm wide x 13mm length jaws
121-271	6 ¹ / ₄ " (159mm), 2mm wide x 13mm length jaws
121-272	7" (178mm), 2mm wide x 14mm length jaws
121-273	8" (203mm), 2mm wide x 15mm length jaws
121-274	9" (227mm), 1.9mm wide x 16mm length jaws

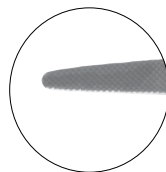

Crile-Wood Needle Holders, Carb-Bite

4000 teeth per square inch, for use with 4.0, 5.0 and 6.0 suture
curved jaw

Catalog #	Description
121-126	7 ¹ / ₂ " (188mm)
121-127	9 ¹ / ₄ " (232mm)

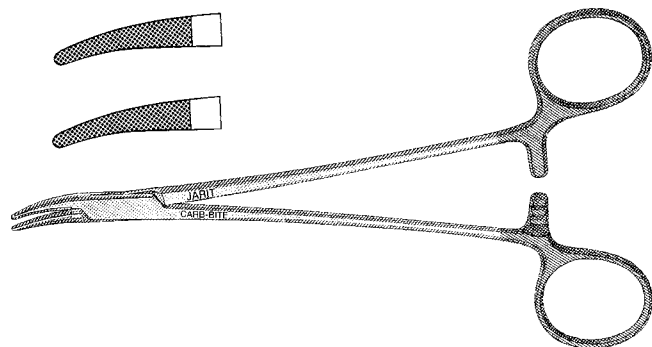
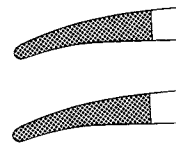

Crile-Wood Needle Holders, Carb-Bite, (Satin Finish)

4000 teeth per square inch, for use with 4.0, 5.0 and 6.0 suture
Manufactured from high grade German surgical stainless steel which is ground and polished to a satin finish

Catalog #	Description
121-130	6" (152mm)
121-131	7" (180mm)
121-132	8" (205mm)
121-133	9" (231mm)
121-134	10½" (267mm)
121-129	12¼" (311mm)
121-128	14" (356mm)



Crile-Wood Needle Holders, Carb-Bite, (Matte Finish)

4000 teeth per square inch, for use with 4.0, 5.0 and 6.0 suture
Manufactured from high grade German surgical stainless steel which is glass beaded to a matte finish

Catalog #	Description
123-130	6" (152mm)
123-131	7" (180mm)
123-132	8" (205mm)



Mayo-Hegar Needle Holders, Carb-Bite, (Satin Finish)

2500 teeth per square inch, for use with 1.0, 2.0, 3.0 and 4.0 suture
Manufactured from high grade German surgical stainless steel which is ground and polished to a satin finish

Catalog #	Description
121-135	6¼" (160mm)
121-140	7¼" (187mm)
121-145	8" (206mm)
121-146	9½" (240mm)
121-142	10¾" (263mm)
121-143	11" (280mm)
121-147	11¾" (300mm)
121-144	13¾" (350mm)

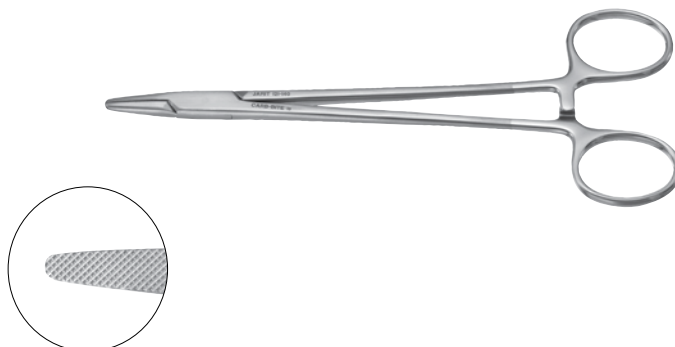

Mayo-Hegar Needle Holder, Carb-Bite, (Matte Finish)

2500 teeth per square inch, for use with 1.0, 2.0, 3.0 and 4.0 suture

Manufactured from high grade German surgical stainless steel which is glass beaded to a matte finish

Catalog #	Description
123-135	6 1/4" (160mm)
123-140	7 1/4" (187mm)
123-145	8" (206mm)

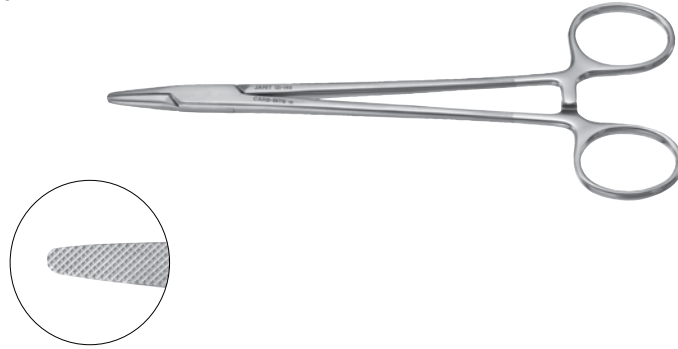

Ryder Needle Holders, Carb-Bite

4000 teeth per square inch, for use with 4.0, 5.0 and 6.0 suture

Catalog #	Description
121-160	5" (126mm)
121-161	5 7/8" (149mm)
121-162	7 1/4" (184mm)
121-163	8" (202mm)
121-164	9" (230mm)
121-165	10 1/4" (262mm)

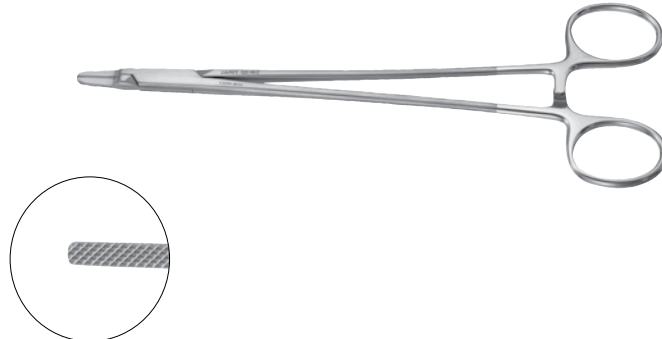

Petit-Point Ryder Needle Holders, Carb-Bite

7000 teeth per square inch, for use with 4.0, 5.0 and 6.0 suture
serrated jaws

Catalog #	Description
121-170	4 7/8" (124mm)
121-172	6 1/4" (156mm)
121-174	7" (176mm)
121-176	7 3/4" (200mm)
121-177	9" (228mm)

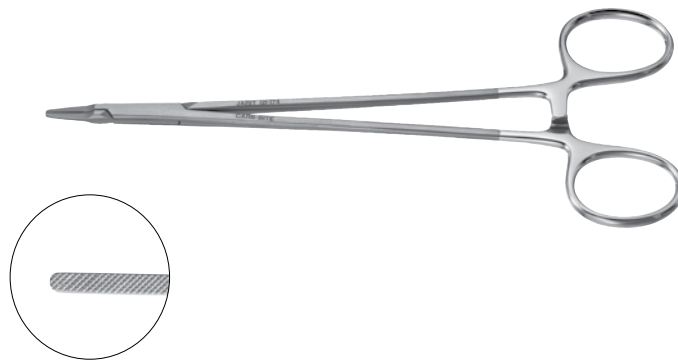

Petit-Point Ryder Needle Holders, Carb-Bite

smooth jaws, for use with 4.0, 5.0 and 6.0 suture

Catalog #	Description
121-171	4 ⁷ / ₈ " (124mm)
121-173	6 ¹ / ₄ " (156mm)
121-175	7" (176mm)
121-179	7 ³ / ₄ " (200mm)
121-178	9" (228mm)

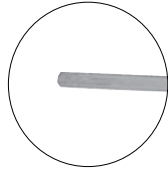

Hufnagel-Ryder Needle Holder, Carb-Bite

4000 teeth per square inch, for use with 4.0, 5.0 and 6.0 suture

Catalog #	Description
121-166	8 ³ / ₄ " (225mm)

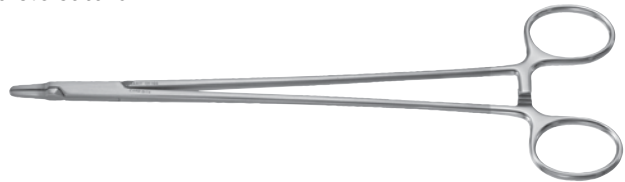
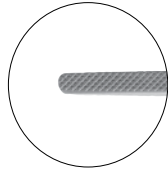

Cooley Intracardiac Needle Holders, Carb-Bite

4000 teeth per square inch, for use with 2.0, 3.0 and 4.0 suture

Catalog #	Description
121-216	7" (179mm)
121-217	8" (202mm)
121-218	9" (229mm)
121-219	10 ¹ / ₄ " (261mm)

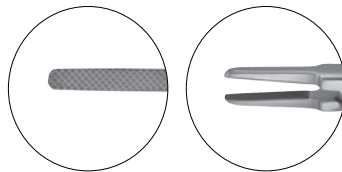

Masson Needle Holder, Carb-Bite

2500 teeth per square inch, for use with 1.0, 2.0, 3.0 and 4.0 suture

Catalog #	Description
121-180	10 ¹ / ₂ " (268mm)

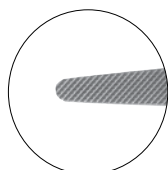

Diethrich Microvascular Needle Holders, Carb-Bite

7000 teeth per square inch, for use with 6.0 and 7.0 suture

Catalog #	Description
121-181	7" (180mm)
121-182	7¾" (200mm)
121-183	9" (230mm)

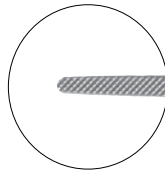

DeBakey Vascular Needle Holders, Carb-Bite

7000 teeth per square inch, for use with 5.0, 6.0 and 7.0 suture

Catalog #	Description
121-184	5⅞" (150mm)
121-185	7" (178mm)
121-186	8" (205mm)
121-187	9" (230mm)
121-188	10¼" (260mm)
121-189	12¼" (311mm)

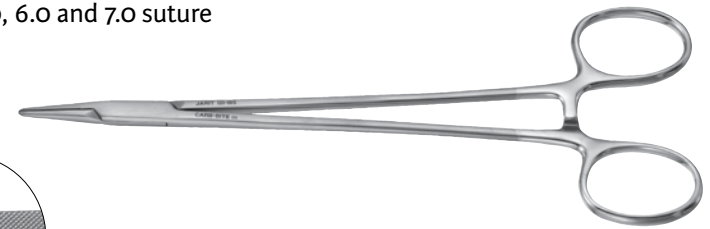
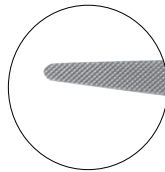

Finochietto Needle Holder, Carb-Bite

2500 teeth per square inch, for use with 2.0, 3.0 and 4.0 suture

Catalog #	Description
121-192	10¼" (262mm)

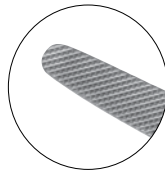

DeBakey Needle Holder, Carb-Bite

4000 teeth per square inch, for use with 4.0, 5.0 and 6.0 suture

Catalog #	Description
121-193	9" (230mm)

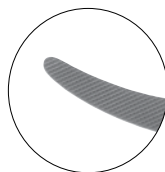

Stratte Valve Needle Holders, Carb-Bite

2500 teeth per square inch, for use with 2.0, 3.0 and 4.0 suture

Catalog #	Description
121-195	9" (227mm), double curved
121-196	10" (254mm), double curved, delicate tip

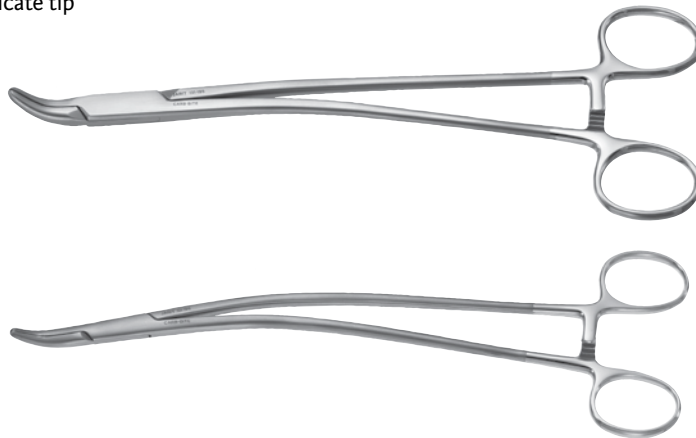
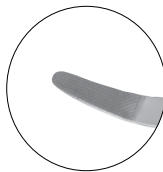
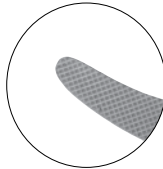

Petit-Point Sarot Needle Holders, Carb-Bite

4000 teeth per square inch, for use with 5.0 and 6.0 suture

Catalog #	Description
121-197	5 7/8" (150mm), delicate
121-198	6 3/4" (169mm), delicate

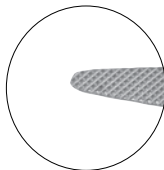

Sarot Needle Holders, Carb-Bite

2500 teeth per square inch, for use with 4.0, 5.0 and 6.0 suture

Catalog #	Description
121-200	7 1/4" (182mm)
121-205	10 1/4" (258mm)

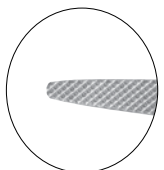

Julian Needle Holders, Carb-Bite

4000 teeth per square inch, for use with 4.0, 5.0 and 6.0 suture

Catalog #	Description
121-206	8¼" (210mm), straight
121-207	8¼" (210mm), curved

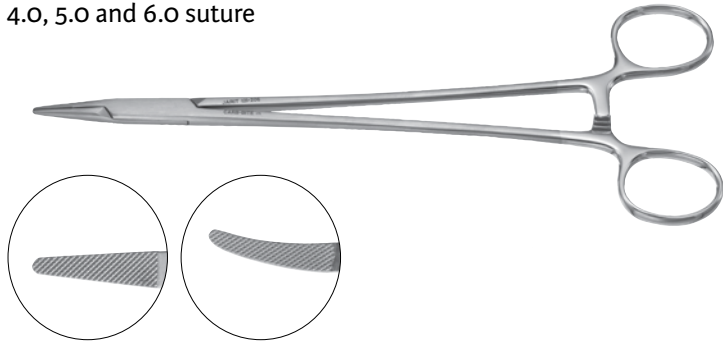

Microvascular Needle Holders, Carb-Bite

4000 teeth per square inch, for use with 4.0, 5.0 and 6.0 suture

Catalog #	Description
121-211	6" (152mm)
121-212	7¼" (184mm)
121-213	8" (203mm)
121-214	9" (228mm)
121-215	10½" (267mm)

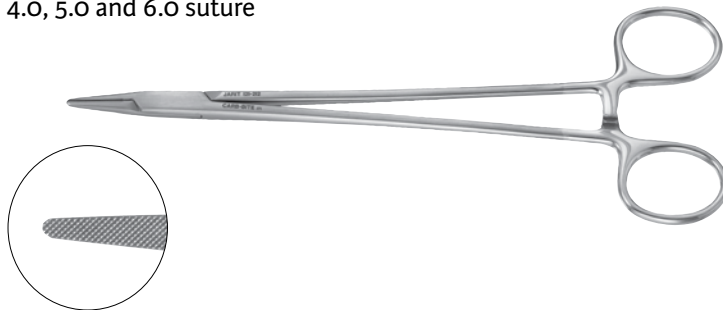

Micro Needle Holders, Stardust

straight, 1.6mm tips, for use with 5.0 and 6.0 suture

Catalog #	Description
277-400	5" (127mm)
277-402	5¾" (146mm)
277-404	6¼" (160mm)
277-407	7½" (190mm)
277-410	7½" (190mm), left handed
277-411	8¾" (225mm)
277-414	9¾" (250mm)



Micro Needle Holders, Stardust

curved, 1mm tips, for use with 5.0 and 6.0 suture

Catalog #	Description
277-401	5" (127mm)
277-403	5¾" (146mm)
277-406	6¼" (160mm)
277-409	7½" (190mm)
277-413	8¾" (225mm)
277-415	9¾" (250mm)

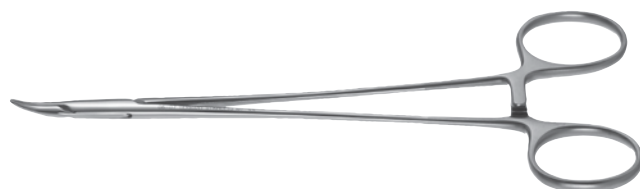

"Low Ryder" Needle Holders, Stardust

straight, 2mm tips, for use with 5.0, 6.0 and 7.0 suture

Catalog #	Description
277-405	6¼" (160mm)
277-408	7½" (190mm)
277-412	8¾" (225mm)



Castroviejo Style Microsurgical Needle Holders, Carb-Bite

1mm tips, for use with 5.0, 6.0 and 7.0 suture
serrated jaws

Catalog #	Description
121-229	7" (178mm)
121-229NL	7" (178mm) (Non Locking)
121-231	8½" (216mm)
121-231NL	8½" (216mm) (Non Locking)



Castroviejo Style Microsurgical Needle Holders, Carb-Bite

1mm tips, for use with 5.0, 6.0 and 7.0 suture
smooth jaws

Catalog #	Description
121-228	7" (178mm)
121-228NL	7" (178mm) (Non Locking)
121-230	8½" (216mm)
121-230NL	8½" (216mm) (Non Locking)

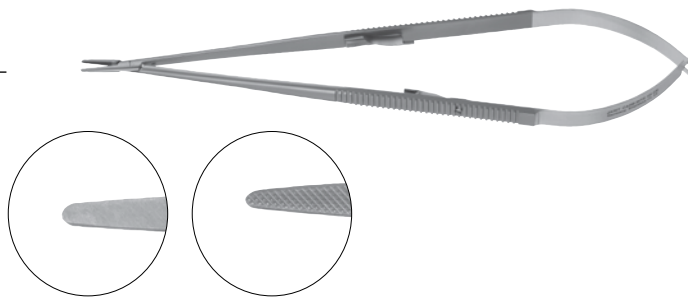

Rubio Sternal Needle Holder and Wire Twister, Carb-Bite

4000 teeth per square inch, for use with 1.0 and 2.0 suture

Catalog #	Description
121-250	5¼" (132mm)



Sternal Needle Holder and Wire Twister, Carb-Bite

4000 teeth per square inch, for use with 1.0 and 2.0 suture

Catalog #	Description
121-255	7" (176mm)

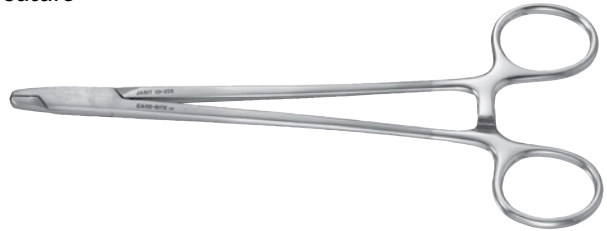
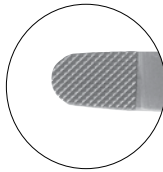

Wire Twisters, Carb-Bite

2500 teeth per square inch, for use with 1.0 and 2.0 suture

Catalog #	Description
121-257	6" (155mm), short delicate jaws
121-258	6" (155mm), short blunt jaws

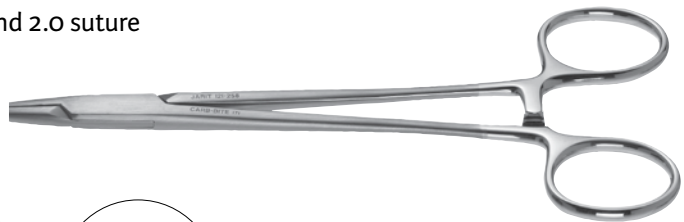
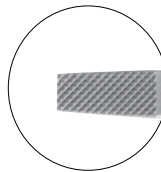
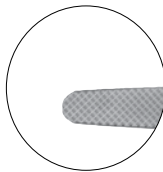

Berry Sternal Needle Holder and Wire Twister, Carb-Bite

1800 teeth per square inch, for use with 1.0 and 2.0 suture

Catalog #	Description
121-260	7¼" (186mm), heavy duty 5mm blunt jaws

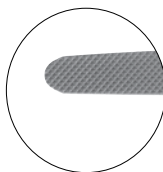

Cooley-Baumgarten, Sternal Wire Twister, Carb-Bite

2500 teeth per square inch, for use with 1.0 and 2.0 suture

Catalog #	Description
121-265	8" (205mm), heavy duty, square 5mm blunt jaws

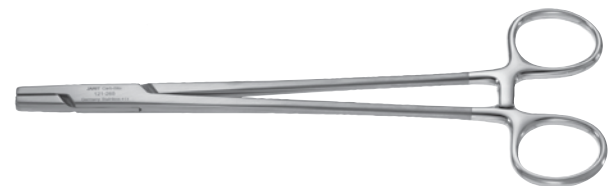
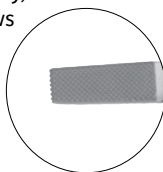

INCHES
MILLIMETERS

Cooley Graft Suction Tube

Catalog #	Description
310-103	14" (357mm), 8mm wide tip

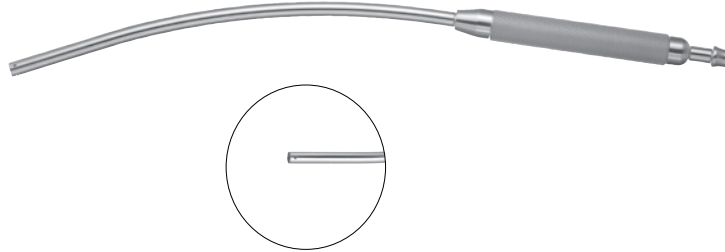

Cooley Vascular Suction Tube

Catalog #	Description
310-105	12" (307mm), 6mm wide tip
310-TIP-105	Replacement Tip pkg/12ea

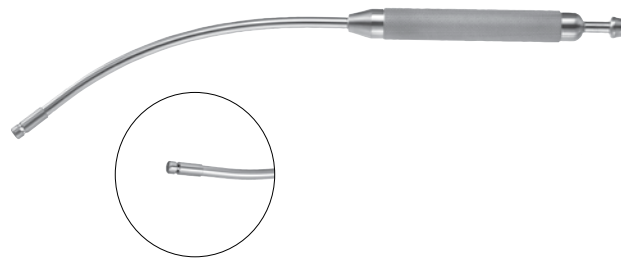

Cooley Intracardiac Suction Tube

Catalog #	Description
310-108	12 1/4" (309mm), detachable 10mm tip
310-TIP-108	Replacement Tip pkg/12ea

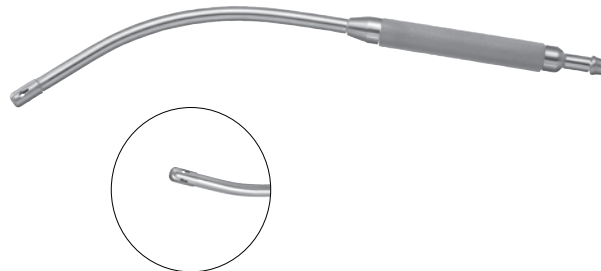

Cooley Sump-Suction Tube
entire tube removable from handle

Catalog #	Description
310-110	30° angle, 14 1/4" (362mm), 8mm wide tip
310-SFT-110	Replacement Shaft
310-TIP-110	Replacement Tip pkg/12ea
310-112	Right angle, 11 1/4" (287mm), 7mm wide tip
310-TIP-112	Replacement Tip pkg/12ea

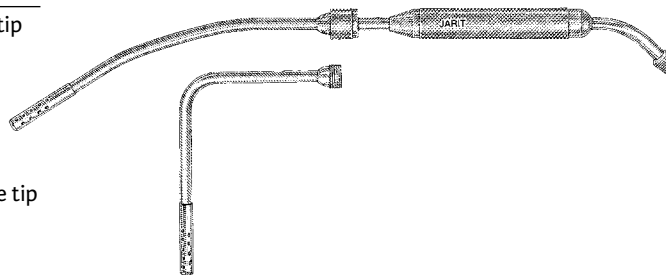

Diethrich Coronary Artery Bypass Kit

Catalog #	Description
310-380	Coronary Artery Bypass Kit Set consisting of:
310-350	1ea Coronary Artery Scissors, 7¼" (182mm), 25° angle
350-351	1ea Coronary Artery Scissors, 7" (180mm), 45° angle
310-352	1ea Coronary Artery Scissors, 7" (177mm), 60° angle
310-353	1ea Coronary Artery Scissors, 6¾" (172mm), 90° angle
310-360	1ea Circumflex Artery Scissors, 6¾" (172mm), 130° angle
140-330	1ea Gemini Clamp, 7" (180mm)
320-114	2ea DeBakey-Diethrich Coronary Artery Forceps, 7¾" (195mm)
320-170	2ea Diethrich Micro Coronary Bulldog Clamps, 8mm
320-172	2ea Diethrich Micro Coronary Bulldog Clamps, 12mm
310-383	2ea Heparin Flushing Needle, 2" (51mm)
310-385	1ea Set of 9 Garrett Vascular Dilators, 8¼" (210mm)
310-381	1ea Instrument Case

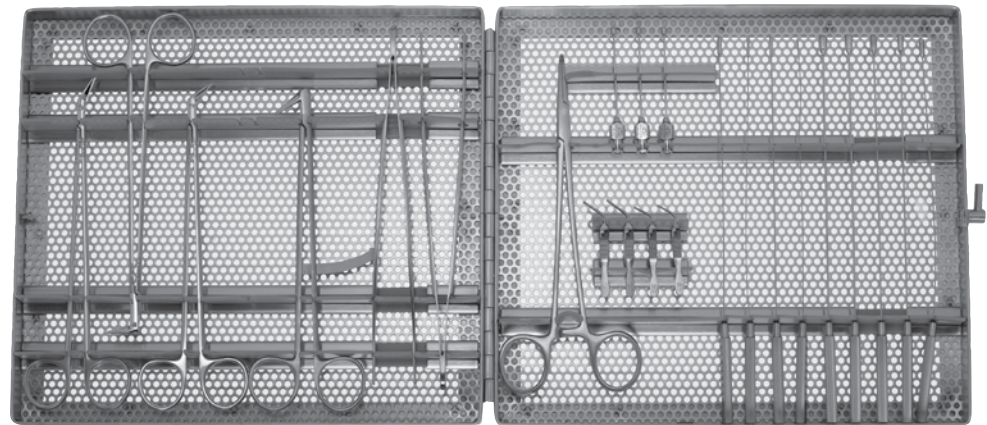

Stopcock, Female to Male Luer Lock Tip

Catalog #	Description
310-377	Female luer lock right-side connection



Luer Lock Adaptor

Catalog #	Description
310-378	For 1/8" tubing, male luer lock to hose end



Stoney Heparin Injector

Catalog #	Description
310-379	1 7/8" (48mm)



DeBakey Heparin Cannula

Catalog #	Description
310-382	6 1/4" (160mm), malleable, 5mm tip



Heparin Flushing Needle

Catalog #	Description
310-383	2" (51mm), malleable, 3mm tip



DeBakey Heparin Cannula

Catalog #	Description
310-384	2 1/8" (54mm), malleable, 3.5r



Garrett Vascular Dilator Set

Catalog #	Description
310-385	8¼" (210mm), set of 9, with holder

Garrett Vascular Dilators (Individual Sizes)

8¼" (210mm)

Catalog #	Description
310-386	1.0mm tip size
310-387	1.5mm tip size
310-388	2.0mm tip size
310-389	2.5mm tip size
310-390	3.0mm tip size
310-391	3.5mm tip size
310-392	4.0mm tip size
310-393	4.5mm tip size
310-394	5.0mm tip size

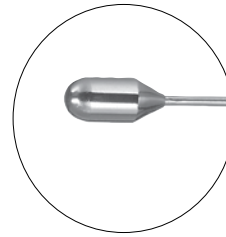

Garrett Vascular Dilator Set

Catalog #	Description
310-395	5½" (140mm), set of 9, with holder

Garrett Vascular Dilators (Individual Sizes)

5½" (140mm)

Catalog #	Description
310-396	1.0mm tip size
310-397	1.5mm tip size
310-398	2.0mm tip size
310-399	2.5mm tip size
310-400	3.0mm tip size
310-401	3.5mm tip size
310-402	4.0mm tip size
310-403	4.5mm tip size
310-404	5.0mm tip size



Garrett Vascular Dilator Case, (not included with set)

Catalog #	Description
310-405	9" x 5 1/8" x 3/4" (230mm x 130mm x 20mm)

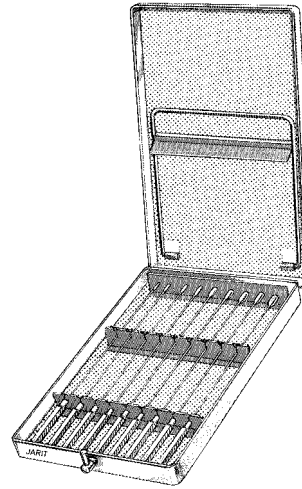

Garrett Vascular Dilator Holder

Catalog #	Description
310-406	7 3/4" (200mm)
310-407	5 1/2" (140mm)



Cooley Vascular Dilator Set

5 1/8" (130mm), set of 6

Catalog #	Description
310-410	malleable silver shaft

Cooley Vascular Dilators (Individual Sizes)

5 1/8" (130mm)

Catalog #	Description
310-411	0.5mm tip size
310-412	1.0mm tip size
310-413	1.5mm tip size
310-414	2.0mm tip size
310-415	2.5mm tip size
310-416	3.0mm tip size



DeBakey Vascular Dilator Set

Catalog #	Description
310-450	7½" (190mm), set of 12

DeBakey Vascular Dilators (Individual Sizes)

7½" (190mm)

Catalog #	Description
310-451	1.0mm tip size
310-452	1.5mm tip size
310-453	2.0mm tip size
310-454	2.5mm tip size
310-455	3.0mm tip size
310-456	4.0mm tip size
310-457	5.0mm tip size
310-458	6.0mm tip size
310-459	7.0mm tip size
310-460	8.0mm tip size
310-461	9.0mm tip size
310-462	10.0mm tip size



DeBakey Vascular Dilator Case, (not included in set)

Catalog #	Description
310-465	9¼" x 5¾" x ½" (232mm x 146mm x 13mm)



Serrefine Forceps

Catalog #	Description
105-260	1½" (37mm), straight
105-261	1½" (37mm), curved
105-262	2¾" (59mm), straight
105-263	2¾" (59mm), curved



Bulldog Clamp Applying Forceps

Catalog #	Description
310-430	9¼" (235mm)



John Hopkins Bulldog Clamps

Catalog #	Description
310-431	1½" (38mm), straight, 12mm serrated jaws
310-432	1⅞" (48mm), straight, 16mm serrated jaws
310-433	2¼" (57mm), straight, 20mm serrated jaws
310-436	3" (76mm), straight, 39mm serrated jaws
310-440	1½" (38mm), curved, 12mm serrated jaws
310-441	1⅞" (48mm), curved, 16mm serrated jaws
310-442	2¼" (57mm), curved, 20mm serrated jaws
310-445	3" (76mm), curved, 39mm serrated jaws



Lemmon Intima Dissectors

7" (175mm), 3.5mm wide dissector blade

Catalog #	Description
310-480	Slight curve
310-481	Medium curve
310-482	Full curve



Olivecrona Double Ended Dissectors

Catalog #	Description
310-485	7¼" (185mm), delicate
310-486	9½" (241mm), delicate
310-487	7¾" (196mm), heavy
310-488	9½" (241mm), heavy



Tubbs Mitral Valve Dilator

7¾" (200mm) overall working length

Catalog #	Description
310-520	Maximum blade opening 1¾" (45mm)



Bailey Aortic Valve Rongeur

4½" (115mm) overall working length

Catalog #	Description
310-522	3.1mm x 7.8mm jaws



Deep Arteriotomy Spring Retractor

3³/₈" (86mm)

Catalog #	Description
310-530	Blades 1/2" x 7/16" (12.8mm x 11.1mm)

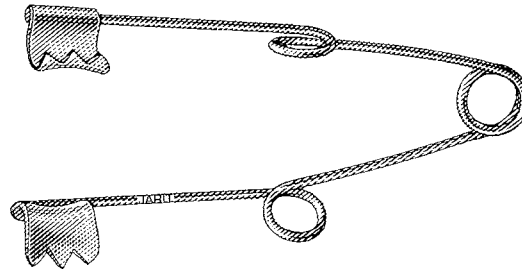

In-Situ Bypass Hooks

7" (178mm)

Catalog #	Description
310-532	2mm round tip
310-533	3mm ball tip

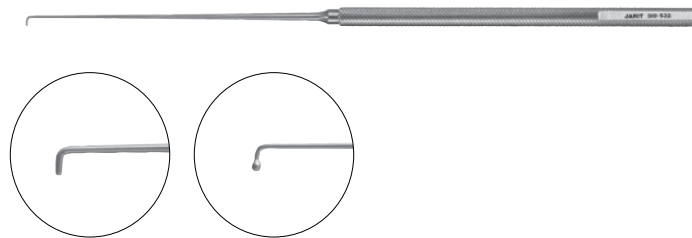

Ball Nerve Hooks

Catalog #	Description
310-545	7 ¹ / ₄ " (185mm), 10mm angled tip
310-544	7 ³ / ₄ " (197mm), 25mm angled tip



Mills Endarterectomy Spatula

7" (175mm)

Catalog #	Description
310-547	1.5mm blade



Plaque Retrievers

Catalog #	Description
310-551	Mini: 6½" (165mm), curved jaws 2" (50mm)
310-550	Short: 7¼" (185mm), angled jaws 5/16" (8mm)
310-549	Long: 8" (202mm), angled jaws 1½" (30mm)

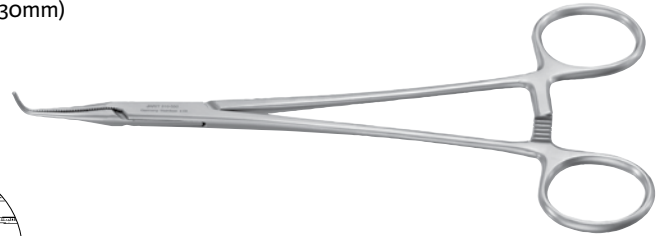

Nabatoff Vein Stripper

Catalog #	Description
160-120	Complete set in stainless steel case
160-HDL-120	Replacement T-Handle
160-CBL-120	Replacement Cable 35"
160-OLV-120-3	Replacement 3mm olive
160-OLV-120-6	Replacement 6mm olive
160-OLV-120-9	Replacement 9mm olive
160-OLV-120-12	Replacement 12mm olive
160-TIP-120	Replacement Tip for Suction Tube pkg/12ea



Crawford-Cooley Graft Tuner

Catalog #	Description
310-570	18" (457mm), light curve, 10mm inside diameter



Dardik Vascular Tuner

Catalog #	Description
310-575	19½" (498mm), 8mm inner diameter, 10mm outer diameter
310-576	25¼" (642mm), 12mm inner diameter, 14mm outer diameter

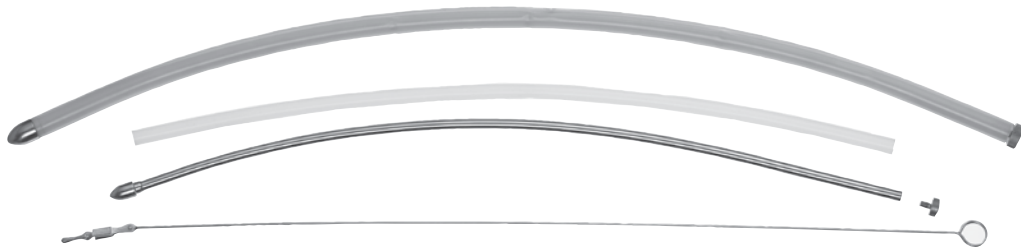

DeBakey Femoral Bypass Tuner

20¾" (525mm), malleable stainless steel shaft

Catalog #	Description
310-580	Tip size ⅝" x 1⅛" (30mm x 16mm)



Mediastinal Dissecting Forceps

Catalog #	Description
295-296	11 ³ / ₄ " (300mm), straight working length 4 ¹ / ₂ " (115mm), 16mm serrated tip



Integra™ Cardiovascular Clamps I; Abdominal and Thoracic Instruments

Introduction:

Jarit added hundreds of new cardiovascular instruments into an already extensive line of cardiovascular and thoracic instruments. The Jarit® line is now a comprehensive offering of high quality, precision instruments that meet the general and specific clinical needs of almost any cardiothoracic or vascular surgeon. We now offer a complete line of specially crafted instruments from delicate, atraumatic clamps and micro needle holders to the demanding bone cutting forceps and rib spreaders. Each instrument is made with high grade surgical stainless steel with exacting standards which provide the right "feel" surgeons demand.

DeBakey Aortic Aneurysm Clamps

Catalog #	Description
320-280	10" (254mm), DeBakey serrations, jaw working length 3 1/8" (78mm)
320-282	10 1/2" (265mm), DeBakey serrations, jaw working length 3 1/2" (88mm)
320-284	12 1/4" (311mm), 2 x 3 DeBakey serrations, jaw working length 3 7/8" (100mm)
320-286	13" (333mm), 2 x 3 DeBakey serrations, jaw working length 4 7/8" (125mm)



Cooley Aortic Aneurysm Clamp

Catalog #	Description
320-438	10 1/2" (267mm), Cooley serrations, jaw working length 3" (76mm)



Howard-DeBakey Aortic Aneurysm Clamp

Catalog #	Description
320-288	11 3/4" (300mm), curved shanks, curved jaws, jaw working length 3 7/8" (100mm)



Zanger Abdominal Aorta Clamps

Catalog #	Description
320-292	8" (202mm), DeBakey serrations, jaw working length 3 ⁵ / ₈ " (92mm)
320-293	9 ³ / ₄ " (250mm), DeBakey serrations, jaw working length 3 ³ / ₈ " (85mm)
320-294	11" (280mm), 2 x 3 DeBakey serrations, jaw working length 4 ¹ / ₈ " (120mm)



Wylie Abdominal Aorta Clamp

Catalog #	Description
320-291	9 ³ / ₄ " (245mm), angled shanks, curved jaws, jaw working length 2 ³ / ₄ " (60mm), jaw depth 20mm
320-290	10 ¹ / ₄ " (260mm), angled shanks, curved jaws, jaw working length 3 ¹ / ₈ " (65mm), jaw depth 20mm



Wylie Hypogastric Clamp

Catalog #	Description
320-289	8 ¹ / ₂ " (215mm), angled shanks, curved jaws, jaw working length 2 ³ / ₄ " (65mm)



Cherry Supraceliac Clamp, 60° Handle, Double Curve

Catalog #	Description
320-287	12 ¹ / ₂ " (319mm), angled shanks, curved jaws, jaw working length 5 ³ / ₄ " (122mm)



Lemole-Strong Aorta Clamp

Catalog #	Description
320-257	8¼" (210mm), straight shanks, jaw working length 2" (44mm), depth 7⁄8" (22mm)
320-258	8¼" (210mm), angled shanks, jaw working length 2" (44mm), depth 7⁄8" (22mm)



Bahnsen Aortic Clamp

Catalog #	Description
320-263	9¼" (235mm), angled shanks, curved jaws, jaw working length 2¾" (75mm)

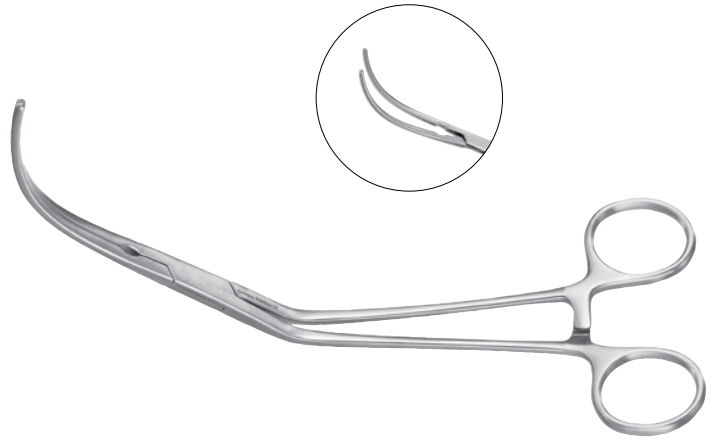

Lambert Abdominal Aortic Aneurysm Clamp

Catalog #	Description
320-266	9¼" (235mm), angled shanks, curved jaws, jaw working length 2" (50mm)



Grant Abdominal Aortic Aneurysm Clamps ("Texas Twister")

2 x 3 DeBakey jaw serrations

Catalog #	Description
320-269	10" (255mm), jaw working length 1¾" (50mm), 2" (50mm) beyond curve
320-264	10½" (267mm), jaw working length 2⅝" (65mm), 2½" (65mm) beyond curve



DeBakey Aorta Clamp (Sidewinder)

2 x 3 DeBakey jaw serrations

Catalog #	Description
320-245	10¾" (270mm), jaw working length 2¼" (60mm) beyond curve



Jarit Aortic Aneurysm Clamp

DeBakey jaw serrations

Catalog #	Description
320-357	10¾" (270mm), jaw working length 2⅞" (55mm) beyond curve



Beall-Morris Aorta Clamps

2 x 3 DeBakey jaw serrations

Catalog #	Description
320-267	8¼" (210mm), curved shanks, angled jaws, jaw working length 2¾" (67mm) wide jaws
320-259	8¾" (225mm), curved shanks, angled jaws, jaw working length 3¾" (95mm) delicate jaws
320-268	11" (279mm), curved shanks, angled jaws, jaw working length 3" (70mm) std jaws



Cooley Iliac Clamps

Catalog #	Description
320-494	8 ³ / ₄ " (220mm), jaw working length 2 ¹ / ₂ " (67mm), overall jaw length 75mm
320-495	10 ¹ / ₄ " (260mm), jaw working length 2 ¹ / ₂ " (67mm), overall jaw length 75mm

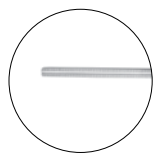

Cooley Aorta Clamps

Catalog #	Description
320-243	10 ³ / ₄ " (276mm), jaw working length 2 ¹ / ₄ " (55mm), depth 5 ⁸ / ₈ " (15mm)
320-244	10" (255mm), jaw working length 3" (70mm), depth 3 ⁴ / ₄ " (17mm)

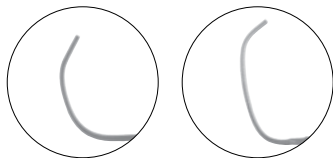

Ochsner Aorta Clamp

Catalog #	Description
320-242	9 ¹ / ₂ " (240mm), angled shanks, jaw working length 2 ⁷ / ₈ " (60mm), depth 3 ⁴ / ₄ " (18mm)



Diethrich Aorta Clamp

Catalog #	Description
320-246	7 ³ / ₄ " (200mm), angled shanks, jaw working length 2" (47mm), depth 5 ⁸ / ₈ " (16mm)

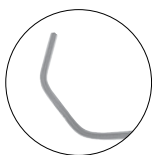

Kay Aorta Clamp

Catalog #	Description
320-247	7¾" (200mm), angled shanks, jaw working length 2¼" (45mm), depth 1⅛" (32mm)



Titanium

Lambert-Kay Aorta Clamp

Catalog #	Description
320-728TI	7¾" (200mm), jaw working length 1⅞" (48mm), depth ¾" (23mm)



Lambert-Kay Aorta Clamp

Catalog #	Description
320-248	7¾" (200mm), angled shanks, jaw working length 2" (50mm), depth ¾" (32mm)



Wylie "J" Clamp

Catalog #	Description
320-249	8" (203mm), curved shanks, jaw working length 1¾" (45mm), depth 1⅛" (32mm)



DeBakey Tangential Occlusion Clamps

Catalog #	Description
320-320	7¾" (197mm), jaw working length 1¾" (45mm), depth ½" (12mm)
320-322	10" (254mm), jaw working length 2⅛" (55mm), depth ¾" (18mm)
320-324	10¼" (260mm), jaw working length 2½" (60mm), depth ¾" (18mm)
320-326	10½" (265mm), jaw working length 2⅝" (65mm), depth ¾" (18mm)
320-328	11" (279mm), jaw working length 3" (80mm), depth ¾" (18mm)



Cooley Tangential Occlusion Clamps

Catalog #	Description
320-447	7¾" (194mm), jaw working length 1" (25mm), depth ⅝" (8mm)
320-448	7¾" (195mm), jaw working length 1⅛" (30mm), depth ⅝" (10mm)
320-449	8" (202mm), jaw working length 1½" (38mm), depth ⅝" (10mm)

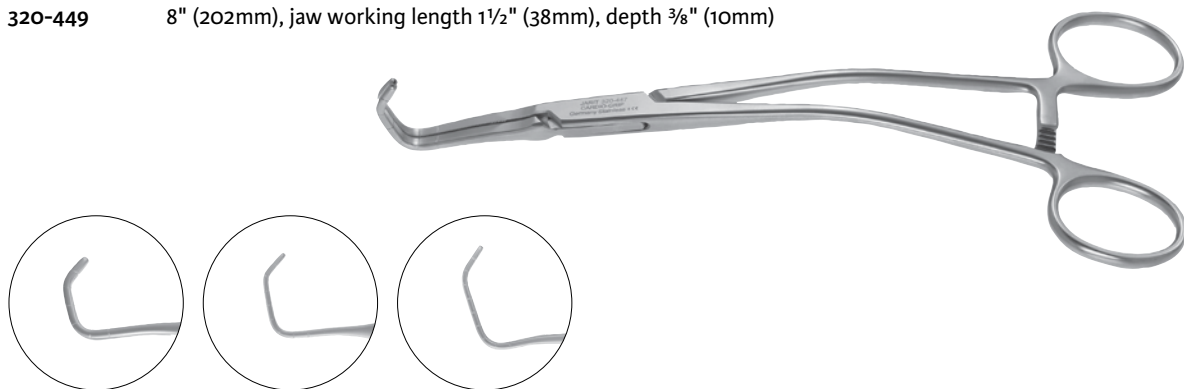

Cooley Partial Occlusion Clamps

Catalog #	Description
320-335	8" (205mm), jaw working length 1" (23mm), depth 1/4" (7mm)
320-336	8 1/4" (210mm), jaw working length 1 1/2" (35mm), depth 3/8" (8mm)
320-337	8 3/4" (225mm), jaw working length 2" (52mm), depth 1/2" (12mm)
320-338	9 1/4" (235mm), jaw working length 2 3/8" (60mm), depth 1/2" (12mm)
320-339	11" (280mm), jaw working length 2 7/8" (120mm), depth 1/2" (12mm)

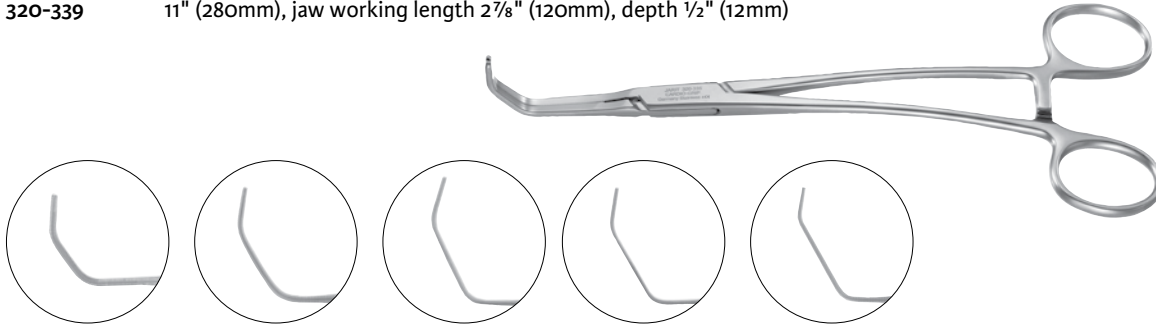

Beck Aorta Clamps

Catalog #	Description
320-296	8" (203mm), straight shanks, jaw working length 1 1/4" (40mm), depth 1/4" (10mm)
320-297	8 1/2" (213mm), straight shanks, jaw working length 1 3/4" (45mm), depth 3/8" (10mm)
320-298	8 1/2" (216mm), straight shanks, jaw working length 2 5/8" (67mm), depth 3/8" (10mm)

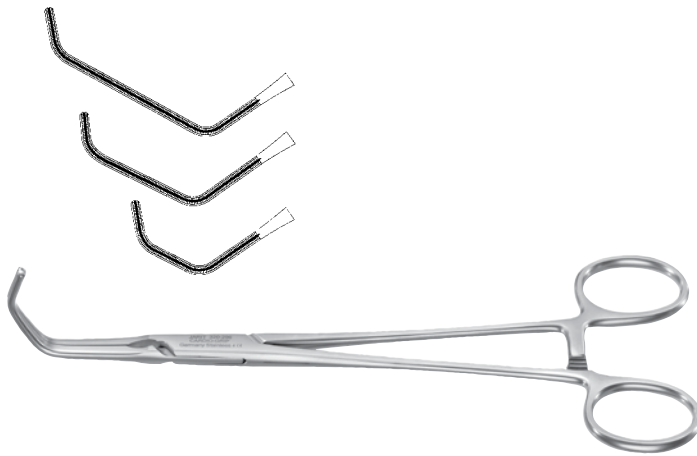

Satinsky Vena Cava Clamps

Catalog #	Description
320-390	9 1/2" (240mm), jaw working length 2" (55mm), depth 3/8" (15mm), large
320-391	9 1/2" (240mm), jaw working length 1 5/8" (45mm), depth 3/8" (13mm), medium
320-392	9 1/2" (240mm), jaw working length 1 3/8" (35mm), depth 1/4" (10mm), small

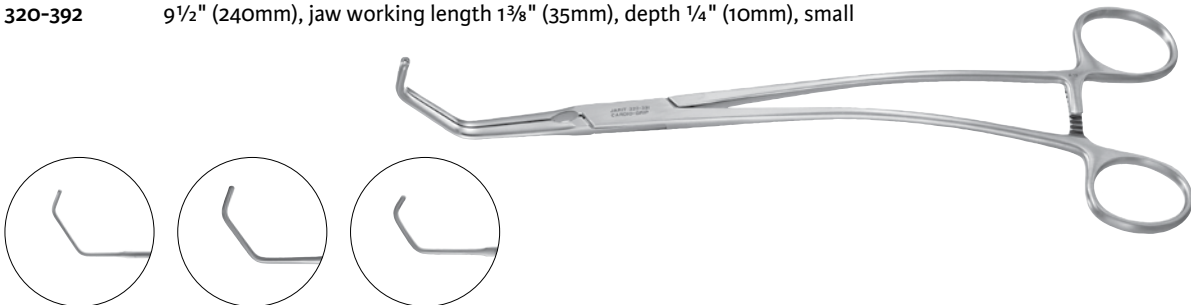

Satinsky Vena Cava Clamps

Catalog #	Description
310-204	6¼" (160mm), cross-serrated, pediatric sizes, jaw working length 30mm, jaw depth 8mm
310-200	9½" (240mm), cross-serrated, jaw working length 55mm, jaw depth 12mm
310-202	10½" (265mm), cross-serrated, heavy, jaw working length 50mm, jaw depth 12mm

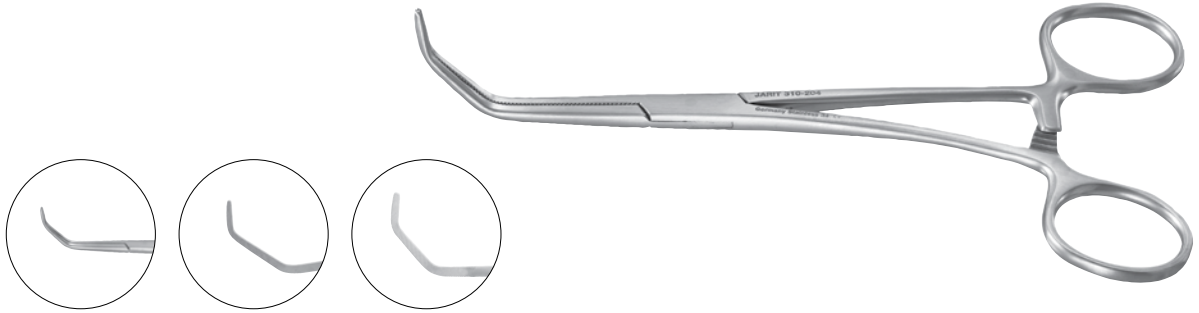

Glover Auricular Appendage Clamp

Catalog #	Description
320-375	9½" (241 mm), jaw working length 1⅞" (45mm), depth ¼" (7mm)



Reynolds Clamps

Catalog #	Description
320-483	50°, 7" (180mm), angled shanks, jaw working length 1¼" (33mm), depth ⅜" (5mm), small
320-484	50°, 7" (180mm), angled shanks, jaw working length 1⅜" (35mm), depth ⅜" (5mm), large
320-485	85°, 6½" (165mm), angled shanks, jaw working length 1⅞" (29mm), depth ⅜" (5mm), small
320-486	85°, 6½" (165mm), angled shanks, jaw working length 1¼" (32mm), depth ⅜" (5mm), large

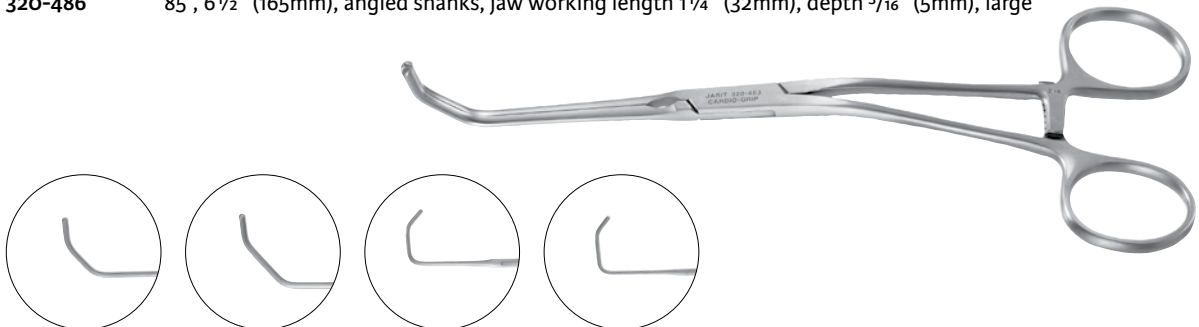

Harken Auricle Clamps

Catalog #	Description
320-380	10" (255mm), no. 1 curve, jaw working length 2¾" (70mm)
320-381	9¾" (245mm), no. 2 curve, jaw working length 2¼" (57mm)
320-382	9½" (240mm), no. 3 curve, jaw working length 2" (50mm), jaw depth ¾" (10mm)
320-383	9¾" (245mm), no. 4 curve, jaw working length 1¾" (45mm)

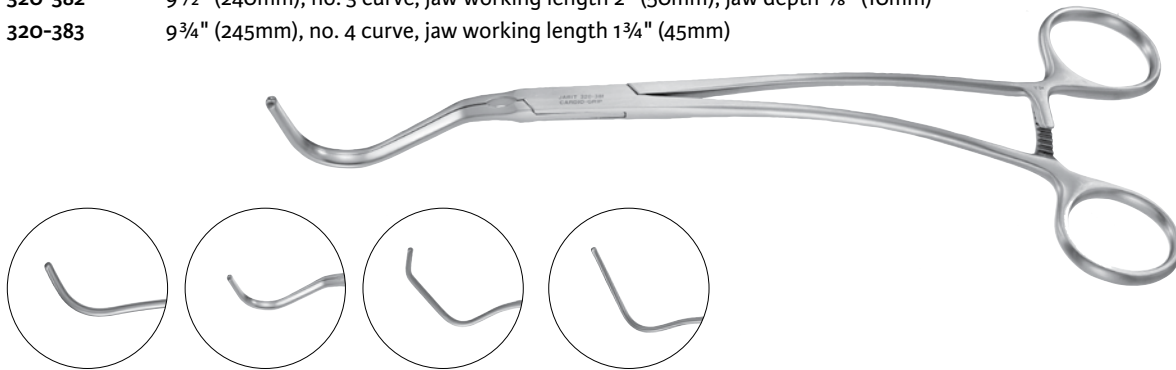

Glover Clamps

Catalog #	Description
320-370	8¼" (210mm), straight shanks, spoon shaped jaws, jaw working length 2" (50mm)
320-372	10¼" (260mm), straight shanks, spoon shaped jaws, jaw working length 2½" (65mm)
320-360	8¼" (210mm), straight shanks, standard curve, jaw working length 2" (50mm)
320-361	9½" (240mm), straight shanks, extra long curve, jaw working length 2½" (65mm)
320-362	7¼" (185mm), straight shanks, acutely curved, jaw working length 2" (50mm)
320-363	8¾" (220mm), straight shanks, extra long acute curve, jaw working length 2⅜" (60mm)

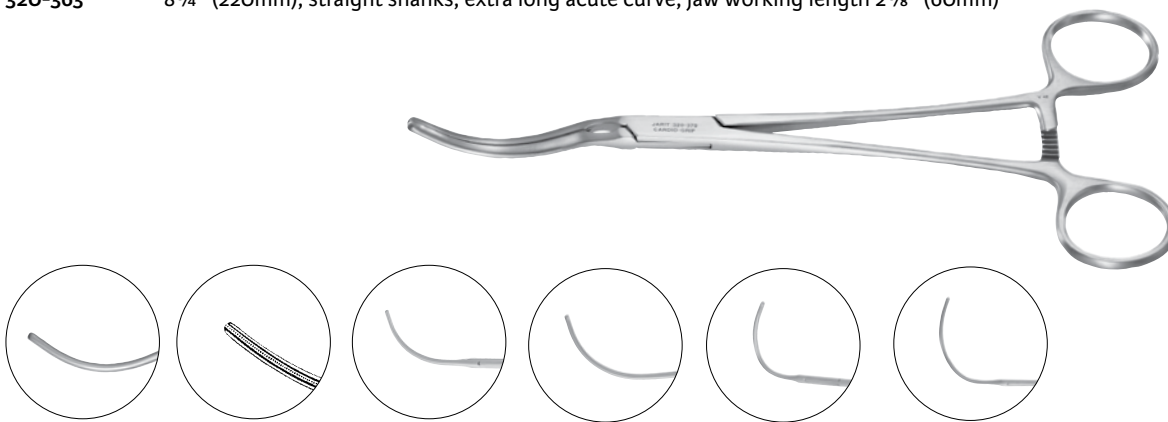

DeBakey-Bahnson Clamps

Catalog #	Description
320-275	11 ¹ / ₄ " (283mm), jaw working length 3" (76mm), light curve
320-276	11" (280mm), jaw working length 2 ¹ / ₂ " (66mm), medium curve
320-277	10 ³ / ₄ " (270mm), jaw working length 2" (50mm), acute curve

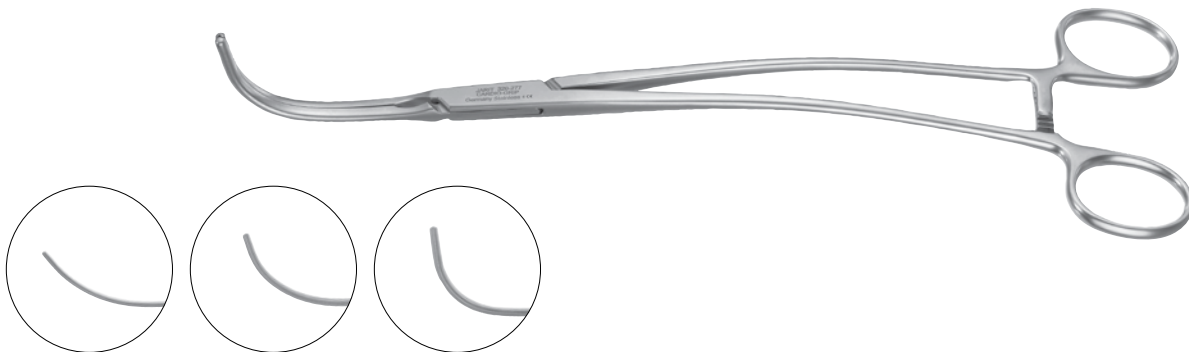

DeBakey-Vascular Clamps

Catalog #	Description
320-270	9 ³ / ₄ " (245mm), curved shanks, curved jaws, jaw working length 2" (50mm)
320-272	9 ³ / ₄ " (250mm), curved shanks, fully curved jaws, jaw working length 3" (75mm), jaw depth 30mm



Coolley Multi-Purpose Clamps

Catalog #	Description
320-472	8" (203mm), jaw working length 1 ³ / ₈ " (35mm), depth 5/8" (16mm)
320-473	8" (203mm), jaw working length 1 ⁵ / ₈ " (40mm), depth 3/4" (19mm)



DeBakey Multi-Purpose Clamps, 60° Angle

Catalog #	Description
320-302	8¼" (210mm), jaw working length 2⅛" (55mm)
320-304	9½" (241mm), jaw working length 2¾" (70mm)
320-300	10" (254mm), jaw working length 1⅝" (40mm)
320-306	12" (305mm), jaw working length 4" (100mm)

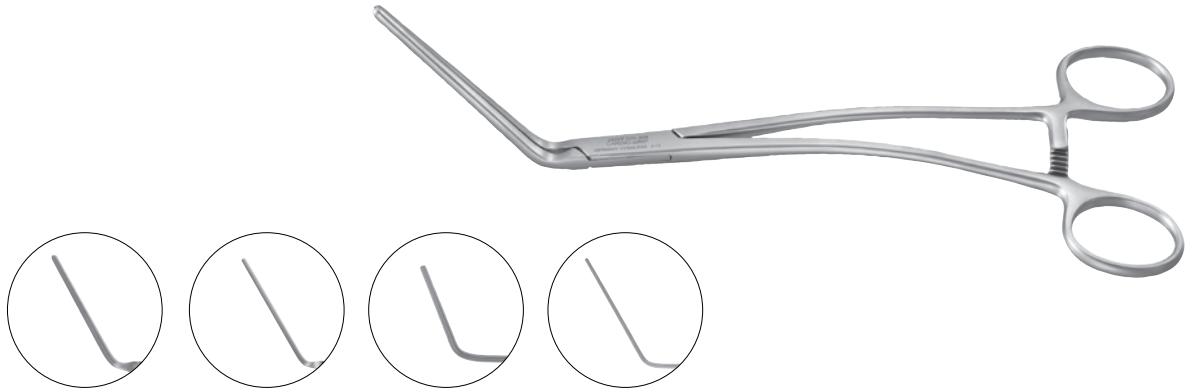

Leland Jones Peripheral Vascular Clamps

Catalog #	Description
320-215	7¾" (195mm), straight jaws, jaw working length 2¾" (70mm)
320-216	7¾" (195mm), 15° angle jaws, jaw working length 2¾" (70mm)
320-217	7½" (190mm), 30° angle jaws, jaw working length 2¾" (70mm)

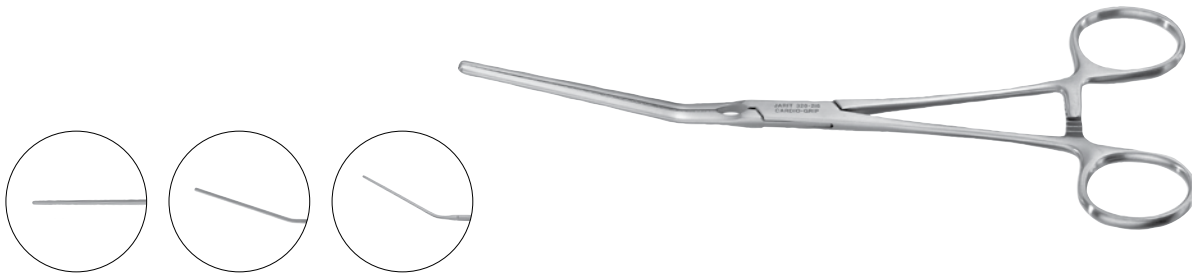

Cooley Peripheral Vascular Clamps

Catalog #	Description
320-209	6¾" (171mm), straight shanks, straight jaws, jaw working length 1¾" (45mm)
320-210	6½" (165mm), curved shanks, 55° angle jaws, jaw working length 1⅝" (40mm)
320-211	6¾" (171mm), curved shanks, 55° angle jaws, jaw working length 1¾" (45mm)
320-212	7¼" (182mm), curved shanks, 55° angle jaws, jaw working length 2½" (63mm)
320-213	7" (178mm), curved shanks, 45° angle jaws, jaw working length 2" (50mm)
320-214	6¼" (160mm), straight shanks, curved jaws, jaw working length 1⅝" (40mm)

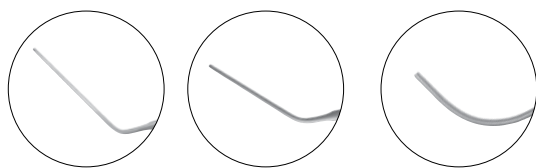

DeBakey Peripheral Vascular Clamps

Catalog #	Description
320-250	7¼" (185mm), curved shanks, angled jaws, jaw working length 2⅜" (60mm)
320-255	7¾" (200mm), curved shanks, curved jaws, jaw working length 3" (76mm), S-shape

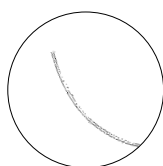
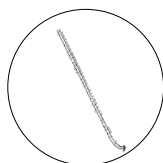

DeBakey Aortic Exclusion Clamp

Catalog #	Description
320-260	7½" (190mm), curved shanks, curved jaws, jaw working length 2⅞" (72mm), S-shape



DeBakey Peripheral Vascular Clamp

Catalog #	Description
320-265	6¼" (157mm), straight shanks, curved jaws, jaw working length 1⅝" (40mm)



Bainbridge Clamps, Longitudinal Serrations

Catalog #	Description
105-300	5⅞" (150mm), straight, 1⅝" (40mm) length jaws
105-302	5⅞" (150mm), curved, 1⅝" (40mm) length jaws
105-304	7¼" (185mm), straight, 2⅜" (60mm) length jaws
105-306	7¼" (185mm), curved, 2⅜" (60mm) length jaws

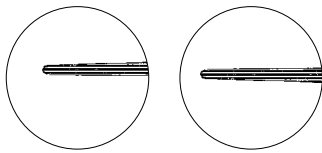

DeBakey-Bainbridge Clamps, DeBakey Serrations

Catalog #	Description
320-228	8" (203mm), straight jaws, jaw working length 2½" (63mm), delicate
320-229	8" (203mm), curved jaws, jaw working length 2⅜" (61mm), delicate

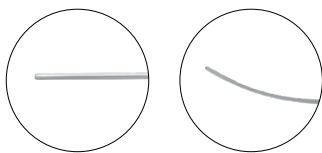

DeBakey Bulldog Clamps, Ring Handle

Catalog #	Description
320-180	5 1/8" (130mm), straight shanks, straight jaws, jaw working length 1 5/8" (40mm)
320-182	5 1/8" (130mm), straight shanks, curved jaws, jaw working length 1 5/8" (40mm)
320-185	5 1/8" (130mm), curved shanks, 45° angle jaws, jaw working length 1 5/8" (40mm)
320-187	3 7/8" (100mm), straight shanks, 90° angle jaws, jaw working length 1 5/8" (40mm)
320-190	4 7/8" (125mm), curved shanks, curved jaws, jaw working length 1 5/8" (42mm), S-shape

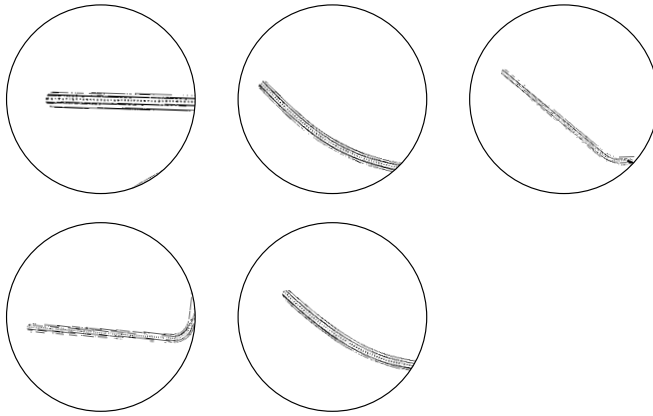

DeBakey Coarctation Clamps

Catalog #	Description
320-230	8 3/4" (222mm), straight shanks, straight jaws, jaw working length 2 3/8" (60mm)
320-231	8 3/4" (222mm), angled shanks, straight jaws, jaw working length 2 3/8" (60mm)

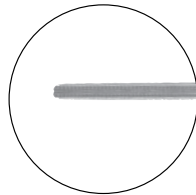

Glover Coarctation Clamps

Catalog #	Description
320-238	9" (228mm), straight shanks, straight jaws, jaw working length 2¼" (57mm)
320-239	8¾" (222mm), angled shanks, straight jaws, jaw working length 2⅜" (60mm)
320-240	10" (257mm), straight shanks, straight jaws, jaw working length 2¾" (70mm)
320-241	10" (257mm), angled shanks, straight jaws, jaw working length 2¾" (70mm)



Cooley Coarctation Clamps

Catalog #	Description
320-397	8¾" (222mm), straight shanks, straight jaws, jaw working length 2¼" (57mm)
320-398	8½" (217mm), angled shanks, straight jaws, jaw working length 2¼" (57mm)
320-399	9¼" (235mm), angled shanks, straight jaws, jaw working length 3" (76mm)



Crafoord Coarctation Clamps

Catalog #	Description
310-214	9¾" (245mm), longitudinal serrations, jaw working length 2¾" (70mm)



Cooley Patent Ductus Clamps

Catalog #	Description
320-395	8½" (213mm), straight shanks, straight jaws, jaw working length 1⅞" (30mm)
320-396	8½" (213mm), angled shanks, straight jaws, jaw working length 1⅞" (30mm)



DeBakey Patent Ductus Clamps

Catalog #	Description
320-233	7¾" (194mm), straight shanks, straight jaws, jaw working length 1⅞" (30mm)
320-234	7½" (191mm), angled shanks, straight jaws, jaw working length 1¼" (32mm)

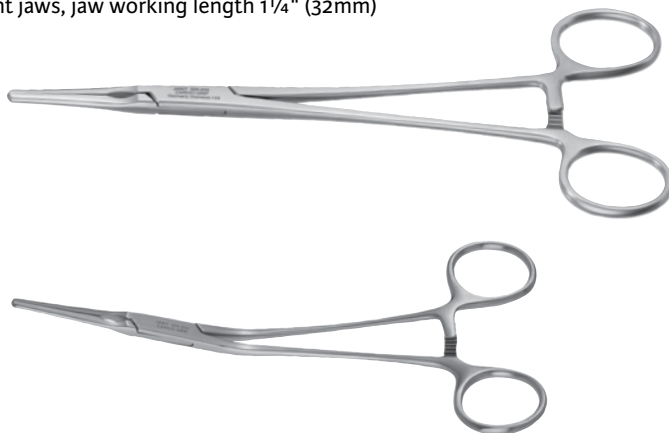
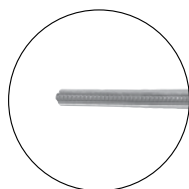

Glover Patent Ductus Clamps

Catalog #	Description
320-235	8" (205mm), straight shanks, straight jaws, jaw working length 1⅞" (30mm)
320-236	8" (205mm), angled shanks, straight jaws, jaw working length 1⅞" (30mm)

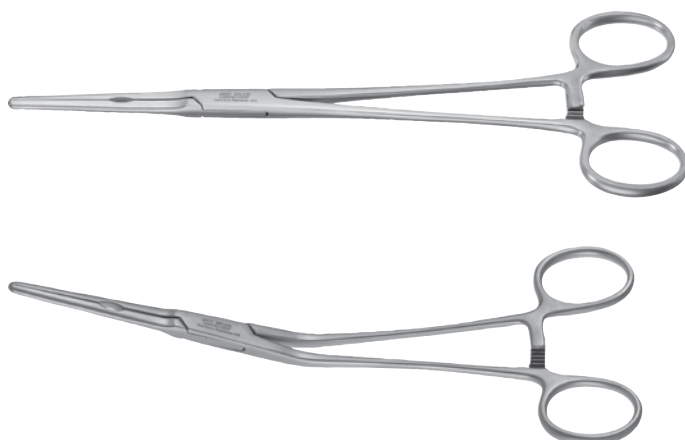
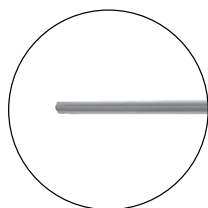

Gregory Profunda Clamps

Catalog #	Description
320-218	5" (128mm), jaw working length 1 $\frac{5}{8}$ " (40mm), delicate
320-220	6" (152mm), jaw working length 1 $\frac{3}{4}$ " (45mm)
320-221	7 $\frac{1}{4}$ " (187mm), jaw working length 2 $\frac{3}{8}$ " (60mm)
320-222	7 $\frac{3}{4}$ " (197mm), jaw working length 2 $\frac{3}{4}$ " (70mm)

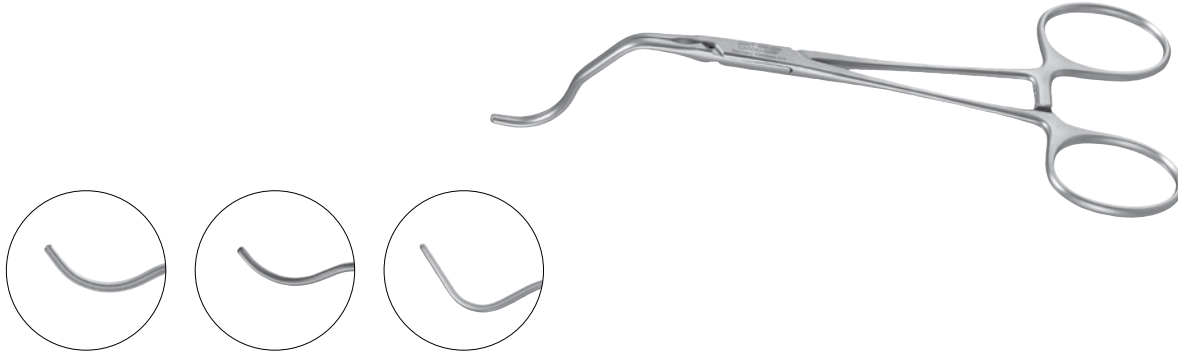

Dale Femoral-Popliteal Clamps

Catalog #	Description
320-225	7" (178mm), jaw working length 2" (50mm), depth 1/2" (12mm), small
320-226	7" (178mm), jaw working length 2 $\frac{1}{8}$ " (55mm), depth 3/4" (19mm), medium
320-227	7" (178mm), jaw working length 2 $\frac{1}{8}$ " (55mm), depth 1" (25mm), large



Renal Artery Clamps

Catalog #	Description
320-480	Overall jaw length 2 $\frac{3}{8}$ " (60mm), jaw working length 3/4" (20mm)
320-481	Overall jaw length 2 $\frac{7}{8}$ " (73mm), jaw working length 1" (25mm)
320-482	overall jaw length 4" (100mm), jaw working length 1 $\frac{1}{8}$ " (30mm)

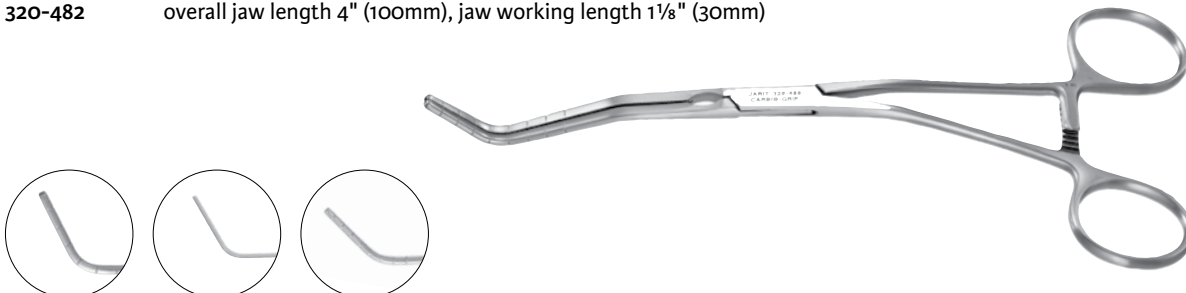

Henly Vacular Clamp

Catalog #	Description
320-262	7¾" (200mm), double angled jaws, jaw working length 3⅛" (80mm)

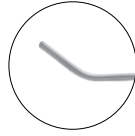

Demos Tibial Artery Clamp

Catalog #	Description
320-223	8¼" (210mm), jaw working length 1⅝" (42mm), perpendicular ring handle



DeBakey Multi-Purpose Clamps, 90° angle

Catalog #	Description
320-312	7" (180mm), jaw working length 2⅛" (55mm)
320-314	8½" (215mm), jaw working length 3" (75mm)
320-310	9" (230mm), jaw working length 1⅝" (40mm)
320-316	10¾" (275mm), jaw working length 4⅛" (105mm)

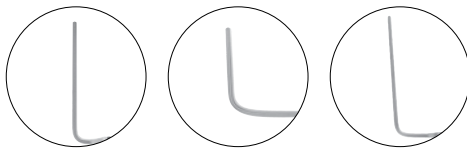

Lee Right Angle and Bronchus Clamps

Catalog #	Description
320-200	9" (230mm), right angle clamp, jaw working length 1⅝" (40mm) beyond angle
320-205	9¾" (250mm), bronchus clamp, jaw working length 1⅝" (40mm) beyond angle



Sarot Bronchus Clamps

Catalog #	Description
305-450	8¾" (225mm), jaw working length 1⅜" (35mm), right
305-451	8¾" (225mm), jaw working length 1⅜" (35mm), left

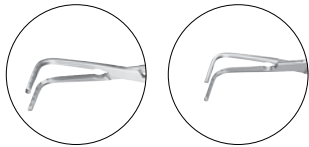

Harken Auricle Clamps

Catalog #	Description
310-190	Cross-serrated, no. 1 curve, 9½" (243mm), jaw working length 1¾" (45mm), jaw depth ¾" (20mm)
310-191	Cross-serrated, no. 2 curve, 9¾" (248mm), jaw working length 1¾" (45mm), jaw depth ⅝" (15mm)
310-192	Cross-serrated, no. 3 curve, 9¼" (235mm), jaw working length 1¾" (45mm), jaw depth ⅜" (10mm)
310-193	Cross-serrated, no. 4 curve, 9¼" (235mm), jaw working length 1¾" (45mm), jaw depth ¾" (20mm)

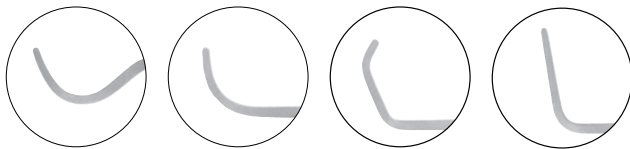

Stille Vessel Clamps

Catalog #	Description
475-500	8¾" (225mm), horizontal serrations, jaw working length 2⅞" (74mm)



Mayo (Guyon) Vessel Clamp

Catalog #	Description
475-505	10½" (265mm), horizontal serrations, jaw working length 2" (52mm)



Herrick Kidney Clamp

Catalog #	Description
475-510	9" (228mm), longitudinal serrations, jaw working length 2" (52mm)



Wertheim Pedicle Clamp

Catalog #	Description
475-520	10½" (265mm), horizontal serrations, jaw working length 2" (52mm)



Wertheim-Cullen Pedicle Clamp

Catalog #	Description
475-525	8¼" (211mm), longitudinal serrations, jaw working length 2¾" (60mm)



Integra[™]
Cardiovascular
Clamps II;
Pediatric and
Peripheral Vascular
Instruments

Ochsner Forceps, Very Fine Serrated Jaws

Catalog #	Description
105-235	4 5/8" (116mm), 90° angle

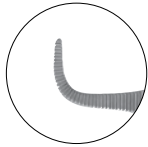

Bainbridge Forceps, with longitudinal serrations

Catalog #	Description
105-300	5 7/8" (150mm), straight, 40mm jaws
105-302	5 7/8" (150mm), curved, 40mm jaws

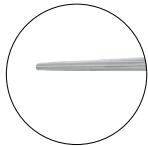

Mixer Forceps, Pediatric

1.7mm tips

Catalog #	Description
140-216	5 1/4" (133mm), curved
140-217	5" (126mm), right angle

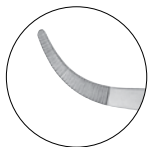

Petit-Point Mixer Forceps, Right Angle

Catalog #	Description
140-218	5 3/8" (137mm)



Gemini Artery Clamp

1.3mm wide x 22.5mm length jaws

Catalog #	Description
140-329	5 3/8" (137mm)

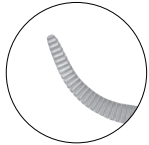

Vascular Hemostatic Forceps

fine pattern, serrated jaws

Catalog #	Description
320-630	5 5/8" (144mm), straight, 28mm jaws
320-631	5 5/8" (143mm), curved, 27mm jaws
320-632	5 1/2" (139mm), full curve, 23mm jaws
320-633	5 5/8" (142mm), straight, 1 x 2 teeth, 27mm jaws
320-634	5 1/2" (141mm), curved, 1 x 2 teeth, 26mm jaws

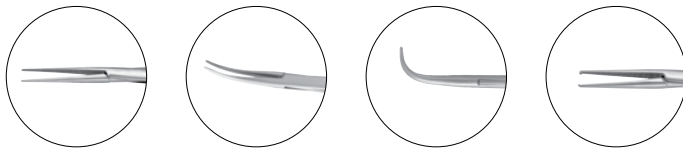

Bailey Forceps

very fine 1mm jaws w/full serrations

Catalog #	Description
320-650	7" (180mm), 30° angle
320-651	7" (178mm), 60° angle
320-652	6 3/4" (174mm), 90° angle

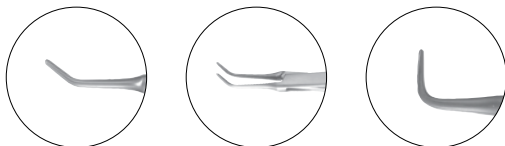

Noon AV Fistula Clamp

50° angle

Catalog #	Description
320-192	4¾" (120mm), jaw working length 25mm



Gregory Miniature Vascular Clamps

curved shanks, ring handle, extra light

Catalog #	Description
320-193	4¾" (110mm), jaw working length 12mm, curved shanks, curved jaws, S-shaped
320-194	4¾" (122mm), jaw working length 25mm, curved shanks, 45° angle jaws

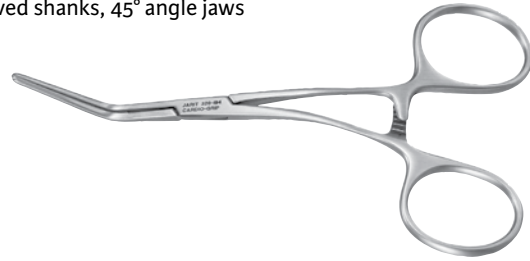
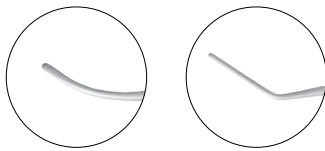

Selman Peripheral Blood Vessel Forceps, Cooley Serrations

Catalog #	Description
320-195	4¾" (121mm), straight jaws, jaw working length ½" (13mm)
320-196	5¼" (133mm), straight jaws, jaw working length 1" (25mm)
320-197	4¾" (121mm), angled jaws, jaw working length ½" (13mm)
320-198	5¼" (133mm), angled jaws, jaw working length 1" (25mm)

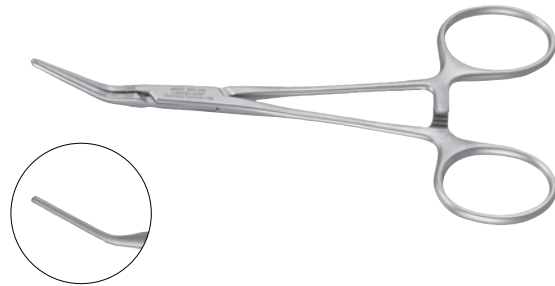

DeBakey Multi-Purpose Clamps, Jaw Length 1¾" (35mm)

Catalog #	Description
320-460	6½" (165mm), 30° angle, jaw working length 35mm
320-461	6" (160mm), 60° angle, jaw working length 35mm
320-462	5½" (145mm), 90° angle, jaw working length 35mm

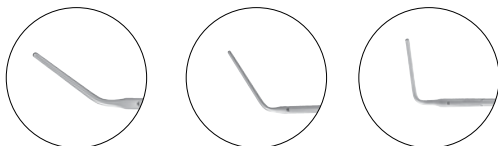

Cooley Multi-Purpose Clamps

Catalog #	Description
320-450	6½" (165mm), 30° angle, jaw working length 35mm
320-451	6¼" (160mm), 60° angle, jaw working length 35mm
320-452	5¾" (145mm), 90° angle, jaw working length 35mm



Castaneda Multi-Purpose Clamps

Catalog #	Description
320-600	5½" (130mm), straight, jaw working length 35mm
320-601	5" (126mm), 30° angle, jaw working length 35mm
320-602	4⅞" (124mm), 50° angle, jaw working length 35mm
320-603	3⅞" (100mm), 90° angle, jaw working length 35mm

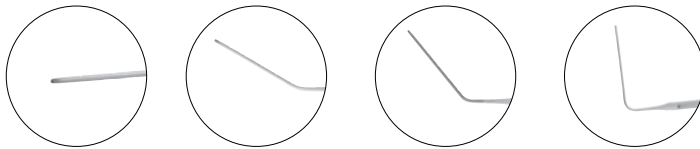

Cooley Pediatric Multi-Purpose Clamps, 90° Angle

Catalog #	Description
320-416	4½" (115mm), jaw working length ¾" (20mm)
320-417	4½" (115mm), jaw working length 1" (25mm)
320-418	4½" (115mm), jaw working length 1⅜" (35mm)



Dardik Multi-Purpose Clamps, "D" Clamp

Catalog #	Description
320-800	5 3/4" (146mm), jaw working length 1" (27mm), straight
320-801	5 3/4" (146mm), jaw working length 1 1/4" (30mm), 15° angle
320-802	5 3/4" (146mm), jaw working length 1 1/4" (30mm), 30° angle
320-803	5 3/4" (146mm), jaw working length 1 1/4" (30mm), 45° angle
320-804	5 1/8" (130mm), jaw working length 1 1/4" (30mm), 90° angle
320-810	6 1/4" (160mm), jaw working length 1 1/2" (41mm), straight
320-811	6 1/2" (165mm), jaw working length 1 1/2" (42mm), 15° angle
320-812	6 1/4" (160mm), jaw working length 1 1/2" (41mm), 30° angle
320-813	6" (155mm), jaw working length 1 1/2" (42mm), 45° angle
320-814	5 1/8" (130mm), jaw working length 1 1/2" (44mm), 90° angle

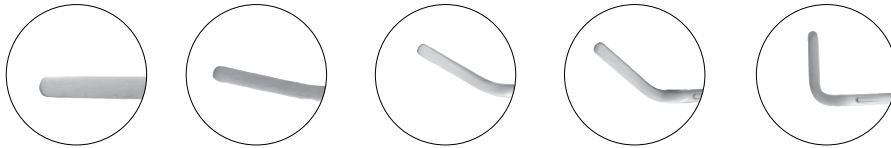

Titanium

Micro Clamps, Pediatric, DeBakey Serrations

Catalog #	Description
320-700TI	4¾" (121mm), straight shanks, jaw working length 1¼" (28mm)



320-701TI	4⅝" (119mm), slightly angled shanks, jaw working length 1¼" (28mm)
-----------	--



320-702TI	4⅜" (110mm), angled shanks, jaw working length 7⁄8" (22mm)
-----------	--



320-708TI	4⅜" (110mm), acutely angled shanks, jaw working length 1¼" (30mm)
-----------	---



Titanium

Micro Clamps, Pediatric, DeBakey Serrations

Catalog #	Description
320-703TI	4 ³ / ₈ " (110mm), straight shanks, 45° angled jaw, jaw working length 1" (25mm)



320-709TI	4 ¹ / ₂ " (114mm), straight shanks, 45° angled jaw, jaw working length 1 ¹ / ₈ " (30mm)
-----------	---



320-704TI	4" (102mm), straight shanks, 60° angled jaw, jaw working length 7 ⁷ / ₈ " (23mm)
-----------	--



320-710TI	4 ³ / ₈ " (110mm), straight shanks, 60° angled jaw, jaw working length 1 ¹ / ₈ " (30mm)
-----------	---



Titanium

Micro Clamps, Pediatric, DeBaKey Serrations

Catalog #	Description
320-706TI	4 1/8" (105mm), straight shanks, jaw working length 1/2" (14mm), jaw depth 1/4" (4mm)

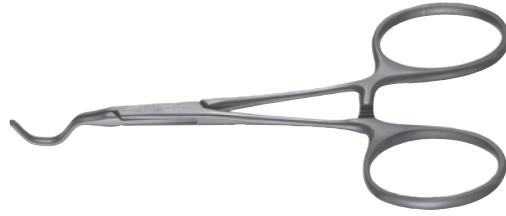

320-705TI	4 1/8" (105mm), slightly angled shanks, jaw working length 1/2" (14mm), jaw depth 1/4" (6mm)
-----------	--



320-711TI	4 3/8" (112mm), slightly angled shanks, jaw working length 7/8" (22mm), jaw depth 1/4" (6mm)
-----------	--



Titanium

Micro Clamps, Pediatric, DeBaKey Serrations

Catalog #	Description
320-707TI	4 1/8" (105mm), slightly angled shanks, jaw working length 5/8" (16mm), jaw depth 3/8" (5mm)



320-712TI	4 3/8" (112mm), slightly angled shanks, jaw working length 7/16" (11mm), jaw depth 3/8" (4mm)
-----------	---



320-713TI	4 5/8" (118mm), straight shanks, spoon-shaped, jaw working length 1/2" (13mm), jaw depth 1/4" (4mm)
-----------	---



DeBakey Patent Ductus Clamps, Delicate

Catalog #	Description
320-199	6" (152mm), straight shanks, jaw working length 1¼" (33mm), 1.9mm tips
320-453	6¾" (172mm), straight shanks, jaw working length 1⅜" (34mm), 2.8mm tips
320-454	6½" (165mm), angled shanks, jaw working length 1⅞" (30mm), 2.8mm tips

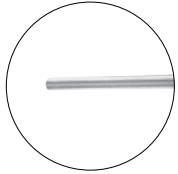

Cooley Patent Ductus Clamps

Catalog #	Description
320-400	6¼" (160mm), straight shanks, straight jaws, jaw working length 1⅞" (30mm), 2.1mm tips
320-401	6¼" (159mm), angled shanks, straight jaws, jaw working length 1⅞" (30mm), 2.1mm tips

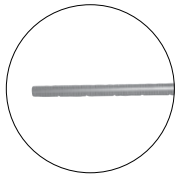

DeBakey Coarctation Clamps, Delicate

Catalog #	Description
320-455	7¼" (182mm), straight shanks, straight jaws, jaw working length 1¾" (45mm), 2.8mm tips
320-456	7" (178mm), angled shanks, straight jaws, jaw working length 1¾" (43mm), 2.8mm tips
320-457	7" (180mm), straight shanks, spoon-shaped jaws, jaw working length 1¾" (43mm), 2.8mm tips

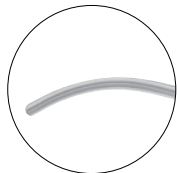
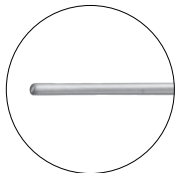

Cooley Coarctation Clamps

Catalog #	Description
320-405	6 ³ / ₄ " (171mm), angled shanks, straight jaws, jaw working length 1 ⁵ / ₈ " (42mm), 2.1mm tips
320-403	6 ³ / ₄ " (171mm), straight shanks, straight jaws, jaw working length 1 ³ / ₄ " (45mm), 2.1mm tips
320-406	6 ³ / ₄ " (170mm), straight shanks, curved jaws, jaw working length 1 ⁵ / ₈ " (42mm), 2.1mm tips
320-410	7" (180mm), straight shanks, spoon-shaped jaws, jaw working length 2" (50mm), 2.1mm tips



Cooley Pediatric Clamps

Catalog #	Description
320-411	5 ¹ / ₂ " (140mm), straight shanks, straight jaws, jaw working length 1 ¹ / ₈ " (30mm), 1.9mm tips
320-412	5 ¹ / ₂ " (140mm), straight shanks, angled jaws, jaw working length 1 ¹ / ₈ " (30mm), 1.9mm tips
320-413	5 ³ / ₄ " (146mm), angled shanks, straight jaws, jaw working length 1 ¹ / ₈ " (30mm), 1.9mm tips
320-414	5 ¹ / ₂ " (140mm), straight shanks, spoon-shaped jaws, jaw working length 1 ¹ / ₈ " (30mm), 1.9mm tips

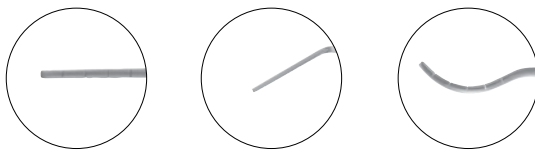

DeBakey Peripheral Vascular Clamp

Catalog #	Description
320-265	6¼" (157mm), curved jaws, jaw working length 1⅝" (40mm), jaw depth ⅜" (10mm)



Beck Vessel Clamps

Catalog #	Description
320-470	5⅞" (150mm), straight shanks, jaw working length 1⅞" (28mm), depth ⅝" (15mm)
320-471	6" (155mm), straight shanks, jaw working length 1⅝" (40mm), depth ¾" (18mm)

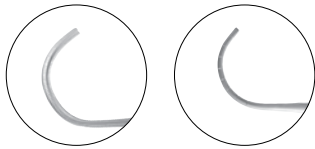

Cooley, Multi-Purpose Clamps, Angled Shanks

Catalog #	Description
320-474	Small: 6¾" (170mm), Ligature Carrier, jaw length 1⅜" (35mm), depth ½" (12mm), length of serrations ¾" (20mm)
320-475	Medium: 6½" (165mm), jaw length 1½" (38mm), depth ⅝" (15mm)
320-476	Large: 6½" (165mm), jaw length 2" (50mm), depth ¾" (18mm)

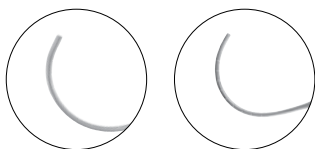

Kitzmilller Clamps, Cooley Serrations, Jaw Length 1 1/8" (30mm), Stainless Steel

Catalog #	Description
320-540	5 1/4" (133mm), left angled, jaw working length 3/8" (10mm)
320-542	5 1/4" (133mm), right angled, jaw working length 3/8" (10mm)

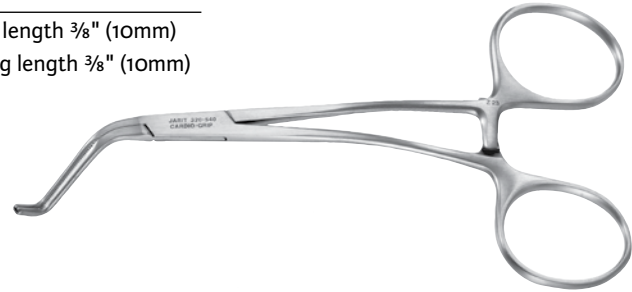

Titanium

Kitzmilller Micro Clamps, DeBakey Serrations, Jaw Length 7/8" (23mm)

Catalog #	Description
320-540TI	4 1/4" (108mm), left angled, jaw working length 5/16" (8mm)
320-542TI	4 1/4" (108mm), right angled, jaw working length 5/16" (8mm)

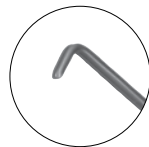

Cooley Neonatal Vascular Clamps

Catalog #	Description
320-500	5 1/8" (130mm), straight shanks, straight jaws, jaw working length 1 1/2" (37mm)

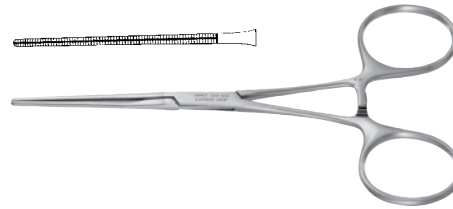

320-501	5 1/8" (130mm), angled shanks, straight jaws, jaw working length 1 1/2" (37mm)
---------	--

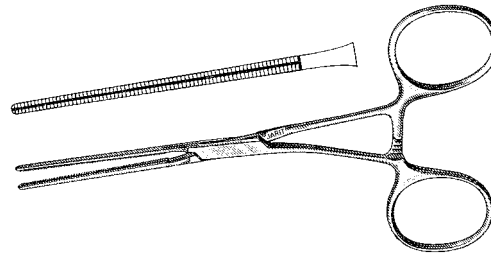

320-502	4 7/8" (125mm), curved shanks, angled jaws, jaw working length 1 3/8" (35mm)
---------	--

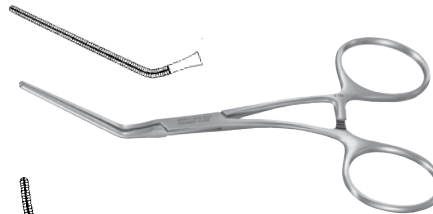

320-503	4 3/4" (122mm), straight shanks, curved jaws, working jaw length 1 1/8" (30mm)
---------	--



Anastomosis Partial Occlusion Clamp

Catalog #	Description
320-504	4 3/4" (120mm), curved shanks, jaw working length 1/2" (14mm), depth 3/16" (5mm)



Carotid Clamp

Catalog #	Description
320-505	4 7/8" (125mm), jaw length 1 3/8" (34mm), jaw working length 1/2" (12mm)



Calman Carotid Closure Clamp

Catalog #	Description
320-520	4 ³ / ₈ " (110mm), jaw working length 1 ¹ / ₈ " (28mm), jaw depth ³ / ₁₆ " (5mm)

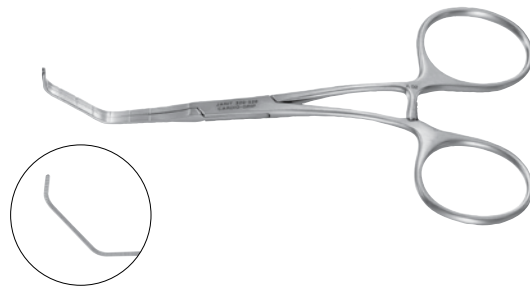

Thompson Carotid Closure Clamp

Catalog #	Description
320-525	6" (152mm), jaw working length 1" (25mm), jaw depth ³ / ₁₆ " (4mm)



Dennis Carotid Clamp

DeBakey atraumatic serrations

Catalog #	Description
320-261	7" (178mm), 2.5mm wide x 16mm jaw working length

(Not Pictured)

Example Clamp

Catalog #	Description
320-530	6 ¹ / ₄ " (159mm), jaw working length 1 ¹ / ₄ " (32mm), jaw depth ¹ / ₄ " (7mm)

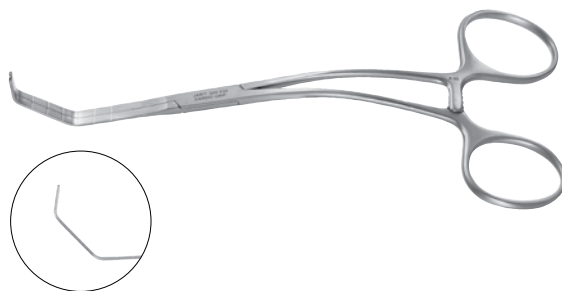

Kartchner Internal Carotid Clamp

Catalog #	Description
320-535	6 ¹ / ₄ " (160mm), jaw length 1 ³ / ₄ " (45mm), jaw working length ¹ / ₂ " (12mm)

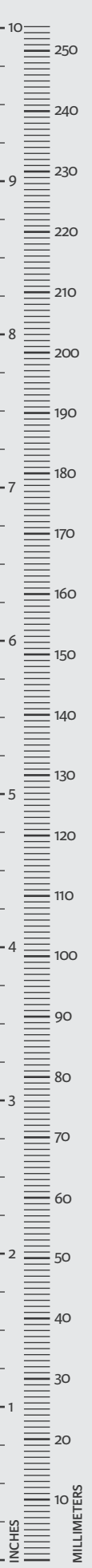
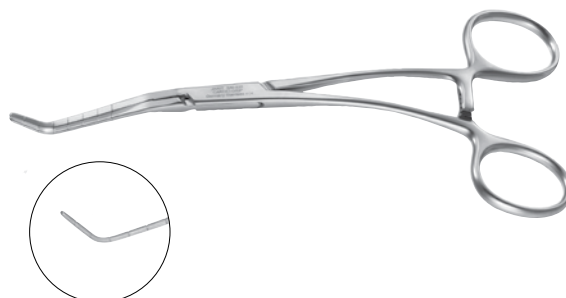

Gregory Profunda Clamp

Catalog #	Description
320-218	5" (128mm), jaw working length 1 1/8" (29mm), delicate



Beck Miniature Aorta Clamp

Catalog #	Description
320-487	6 1/2" (165mm), jaw working length 1 1/8" (30mm), jaw depth 3/16" (5mm)

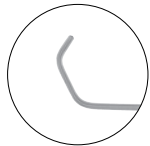

Subramanian Miniature Aorta Clamp

Catalog #	Description
320-490	6" (152mm), jaw working length 1 1/8" (30mm) beyond curve

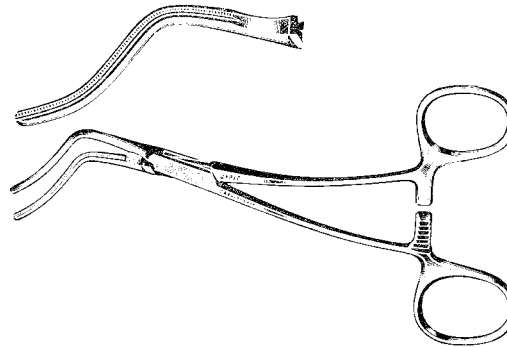

Cooley-Satinsky Clamp

Catalog #	Description
320-415	5 1/2" (140mm), jaw working length 1 1/8" (28mm), jaw depth 1/4" (7mm)



Cooley Pediatric Vascular Clamps

Catalog #	Description
320-506	5½" (140mm), curved shanks, jaw working length ⅝" (16mm), jaw depth ⅜" (5mm)
320-507	5½" (140mm), curved shanks, jaw working length ½" (12mm), jaw depth ⅜" (5mm)
320-508	5½" (140mm), curved shanks, jaw working length ⅝" (8mm), jaw depth ⅜" (5mm)

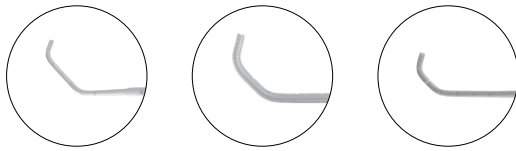

Cooley Vascular Clamps, 90° Angle

Catalog #	Description
320-440	6½" (165mm), jaw working length 1⅝" (27mm), jaw depth ¼" (7mm)
320-441	6½" (165mm), jaw working length 1¼" (32mm), jaw depth ¼" (7mm)

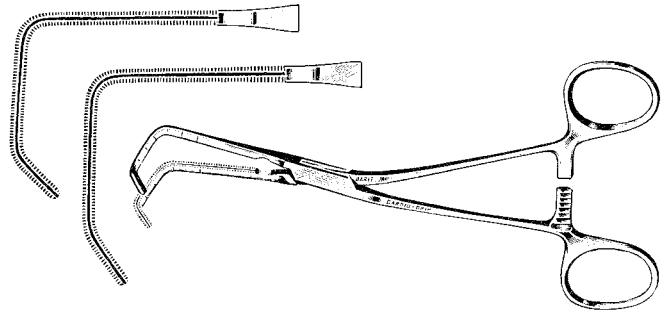

Cooley Vascular Clamps, 60° Angle

7" (175mm)

Catalog #	Description
320-445	Small, jaw working length 1¼" (32mm), jaw depth ¼" (7mm)
320-446	Large, jaw working length 1½" (37mm), jaw depth ¼" (7mm)

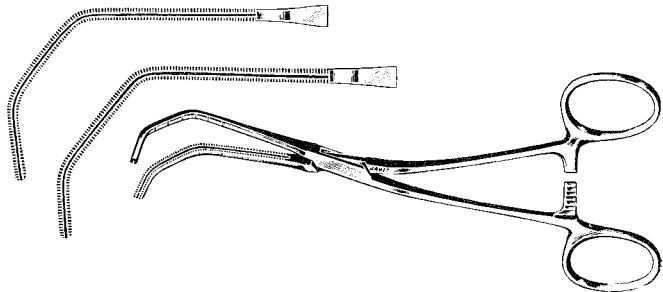

Reynolds Clamps, 85° Angle

Catalog #	Description
320-485	6½" (165mm), jaw working length 1⅛" (29mm), jaw depth ⅜" (5mm)
320-486	6½" (165mm), jaw working length 1¼" (32mm), jaw depth ⅜" (5mm)

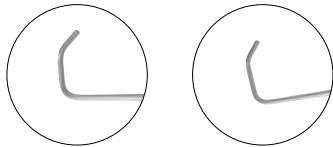

Anastomosis Clamps

Catalog #	Description
320-420	6¾" (170mm), angled shanks, jaw working length ¾" (20mm), jaw depth ⅜" (5mm), DeBakey serrations
320-422	7" (175mm), angled shanks, jaws angled left, jaw working length ¾" (20mm), jaw depth ¼" (7mm), Cooley serrations

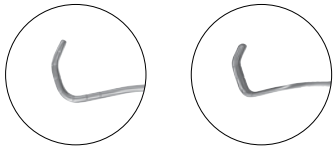

Anastomosis Clamp

Catalog #	Description
320-425	6¾" (170mm), jaw working length ⅞" (22mm), jaw depth ¼" (7mm), Cooley serrations



Castaneda Anastomosis Clamps

Catalog #	Description
320-610	5 ⁷ / ₈ " (150mm), jaw working length 5 ⁵ / ₈ " (15mm), jaw depth 1 ¹ / ₄ " (6mm)
320-611	5 ³ / ₄ " (146mm), jaw working length 3 ³ / ₄ " (18mm), jaw depth 1 ¹ / ₄ " (6mm)
320-612	5 ⁷ / ₈ " (150mm), jaw working length 1" (25mm), jaw depth 1 ¹ / ₄ " (6mm)

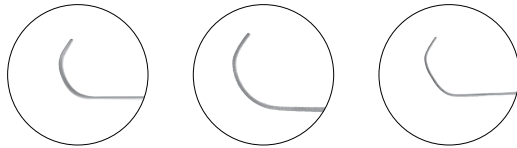

Derra Anastomosis Clamps

Catalog #	Description
320-430	6 ³ / ₄ " (170mm), jaw working length 3 ³ / ₄ " (20mm), jaw depth 7 ⁷ / ₁₆ " (11mm), small
320-431	6 ³ / ₄ " (170mm), jaw working length 1" (25mm), jaw depth 1 ¹ / ₂ " (13mm), medium
320-432	6 ³ / ₄ " (170mm), jaw working length 1 ¹ / ₈ " (30mm), jaw depth 5 ⁵ / ₈ " (15mm), large

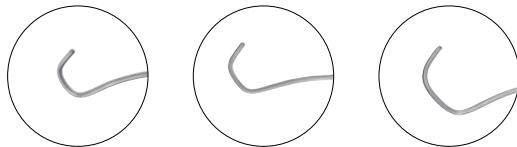

Cooley-Derra Anastomosis Clamps

Catalog #	Description
320-435	6 ¹ / ₂ " (163mm), jaw working length 3 ³ / ₄ " (20mm), jaw depth 7 ⁷ / ₁₆ " (11mm), small
320-436	6 ³ / ₄ " (170mm), jaw working length 1" (25mm), jaw depth 1 ¹ / ₂ " (13mm), medium
320-437	6 ¹ / ₂ " (165mm), jaw working length 1 ¹ / ₈ " (30mm), jaw depth 5 ⁵ / ₈ " (15mm), large

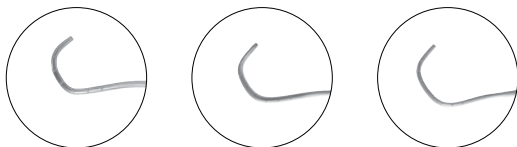

Derra Partial Occlusion Clamps

Catalog #	Description
320-433	4½" (115mm), angled shanks, jaw working length ¾" (10mm), jaw depth ⅜" (10mm), short, small curve
320-463	4½" (115mm), angled shanks, jaw working length ⅝" (16mm), jaw depth ⅜" (10mm), short, medium curve
320-464	4¾" (120mm), angled shanks, jaw working length 1⅛" (28mm), jaw depth ⅜" (10mm), short, large curve
320-465	5½" (140mm), curved shanks, jaw working length ¾" (18mm), jaw depth ⅜" (10mm), small curve
320-466	5½" (140mm), curved shanks, jaw working length ⅞" (22mm), jaw depth ⅜" (10mm), medium curve
320-467	5¾" (145mm), curved shanks, jaw working length 1" (25mm), jaw depth ⅜" (10mm), large curve

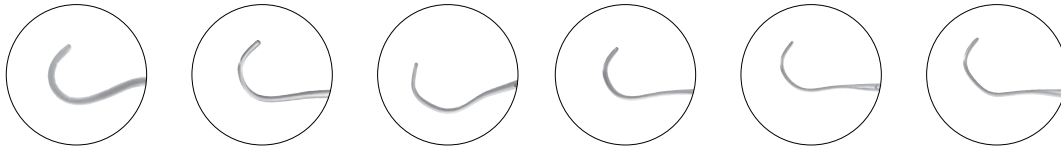

Castaneda Partial Occlusion Clamp

Catalog #	Description
320-604	4⅞" (124mm), jaw working length 1" (24mm), jaw depth ⅝" (8mm), spoon-shape

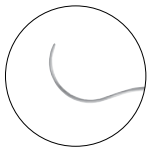

Jarit® Petit-Point® instruments feature a matched and balanced set of fine, delicate hemostats, soft-tension intestinal clamps, delicate scissors, and needle holders, for pediatric and other delicate procedures.

Petit-Point Mosquito Forceps

Catalog #	Description
105-090	3 ⁷ / ₈ " (100mm), straight
105-091	3 ⁷ / ₈ " (100mm), curved
105-095	4 ³ / ₄ " (120mm), straight
105-096	4 ³ / ₄ " (120mm), curved
105-098	6" (152mm), straight
105-099	6" (152mm), curved
285-107	7 ¹ / ₄ " (184mm), straight
285-108	7 ¹ / ₄ " (184mm), curved



Petit-Point Jacobson Mosquito Forceps

very delicate, 7¹/₄" (185mm), serrated jaws

Catalog #	Description
105-092	Slightly curved
105-093	Fully curved

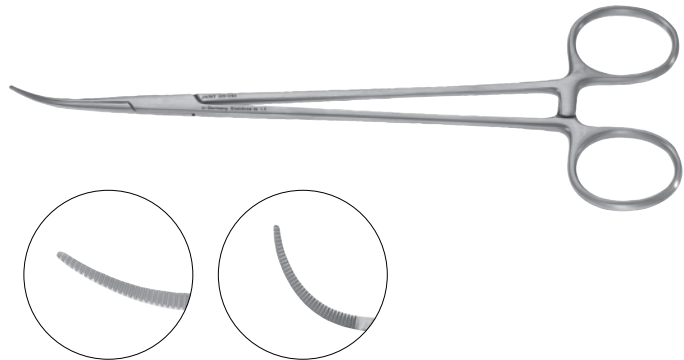

Ochsner Forceps, Very Fine Serrated Jaws

Catalog #	Description
105-235	4 ⁵ / ₈ " (116mm), 90° angle

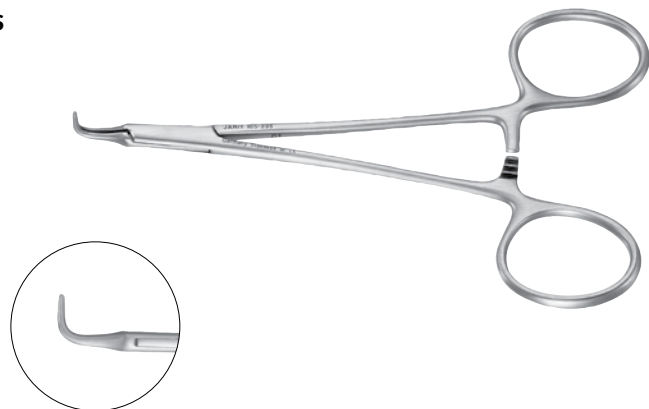

Vascular Hemostatic Forceps

fine pattern, serrated jaws

Catalog #	Description
320-630	5 ⁵ / ₈ " (144mm), straight
320-635	6 ¹ / ₂ " (166mm), straight
320-640	7 ¹ / ₄ " (186mm), straight
320-631	5 ⁵ / ₈ " (143mm), curved
320-636	6 ¹ / ₂ " (165mm), curved
320-641	7 ¹ / ₄ " (185mm), curved
320-632	5 ⁵ / ₈ " (137mm), full curve
320-637	6 ¹ / ₂ " (160mm), full curve
320-642	7 ¹ / ₄ " (181mm), full curve

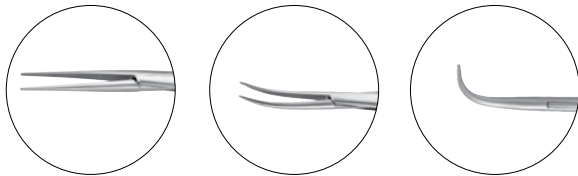

Vascular Hemostatic Forceps

fine pattern, 1 x 2 teeth

Catalog #	Description
320-633	5 ⁵ / ₈ " (142mm), straight
320-638	6 ¹ / ₂ " (163mm), straight
320-643	7" (175mm), straight
320-634	5 ¹ / ₂ " (141mm), curved
320-639	6 ¹ / ₂ " (162mm), curved
320-644	7" (175mm), curved

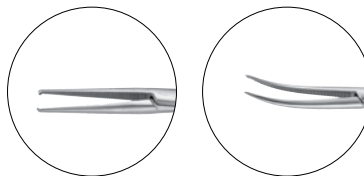

Bailey Forceps

very fine 1mm jaws w/full serrations

Catalog #	Description
320-650	7" (180mm), 30°
320-651	7" (178mm), 60°
320-652	6 ³ / ₄ " (174mm), 90°



DeBakey-Bainbridge Clamps, DeBakey Serrations

Catalog #	Description
320-228	8" (203mm), straight, delicate, 63mm jaws
320-229	8" (203mm), curved, delicate, 61mm jaws

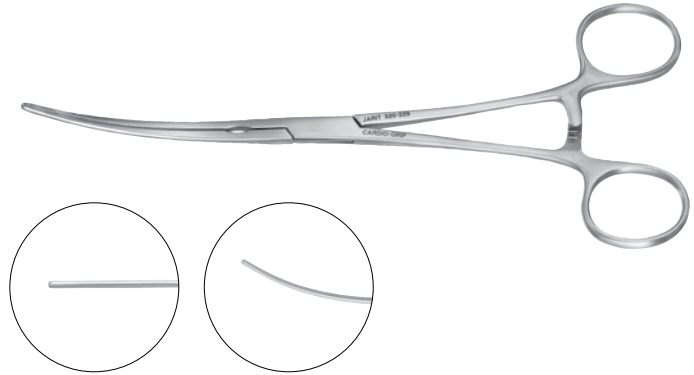

Sternal Chest Tube Passers

Catalog #	Description
320-620	9½" (240mm), without ratchet
320-621	9½" (240mm), with ratchet
320-622	13½" (340mm), without ratchet

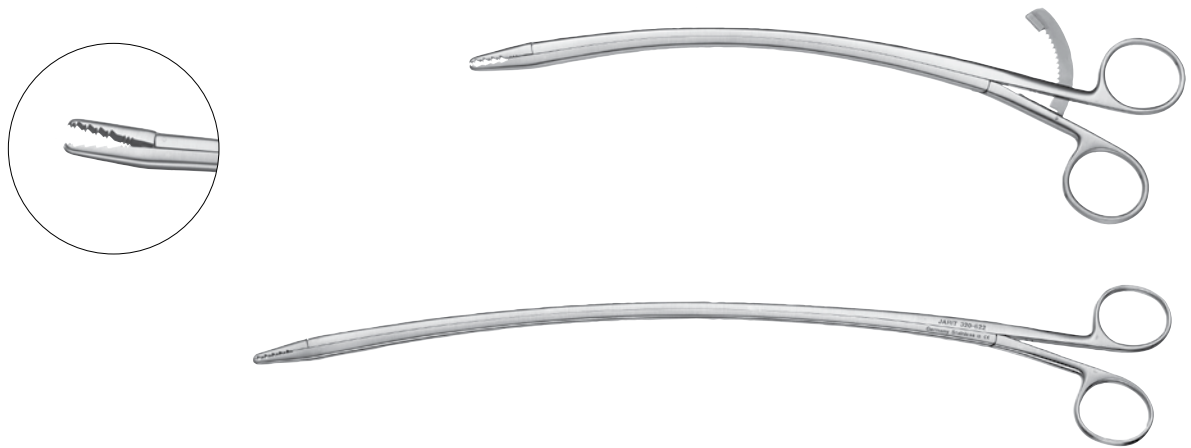

Castaneda Suture Tag Forceps

3⁵/₈" (93mm), numbered for identification, 14mm smooth jaws

Catalog #	Description
320-615	No. 1
320-616	No. 2
320-617	No. 3
320-618	No. 4



Gregory Stay Suture Clamps

4³/₄" (121mm), 14.5mm smooth jaws (for tricuspid valve)

Catalog #	Description
320-625	5/8" (16mm), gold band
320-626	3/4" (19mm), gold band
320-627	1 ⁵ / ₈ " (41mm), gold band

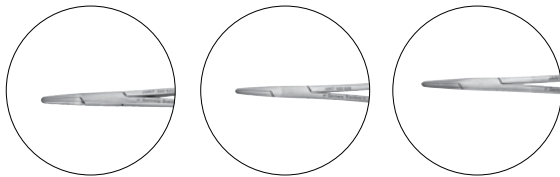

Adson Hemostatic Forceps, Fine Tips

Catalog #	Description
285-103	8 ¹ / ₂ " (215mm), straight
285-104	8 ¹ / ₂ " (215mm), curved
285-105	7 ¹ / ₂ " (190mm), straight
285-106	7 ¹ / ₂ " (190mm), curved

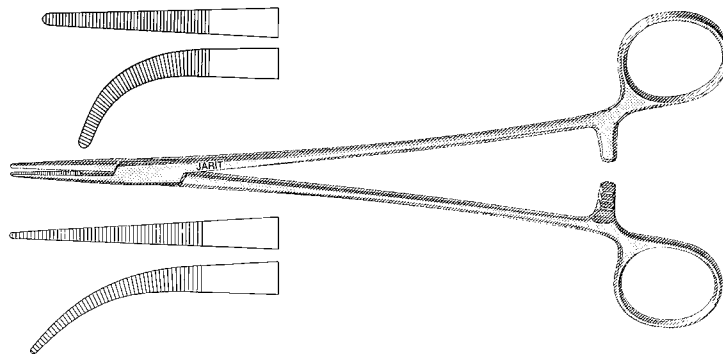

Schmidt Tonsil Forceps, (Mirror Finish)

Manufactured from high grade German surgical stainless steel which is ground and polished to a mirror finish

Catalog #	Description
450-310	7½" (190mm), half curved, closed rings

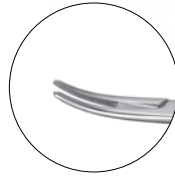

Schmidt Tonsil Forceps, (Matte Finish)

Manufactured from high grade German surgical stainless steel which is glass beaded to a matte finish

Catalog #	Description
449-310	7½" (190mm), half curved, closed rings



Javid Carotid Artery Bypass Clamps

Catalog #	Description
320-550	6¾" (160mm), 3.5mm ring
320-555	7¼" (182mm), 6.3mm ring

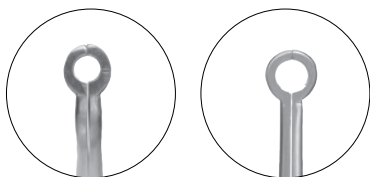

Cooley Vena Cava Catheter Clamp

jaw working length 45mm

Catalog #	Description
320-560	Child size, 6½" (165mm), 24FR
320-562	Child size, 7½" (190mm), 26FR
320-564	Adult size, 7½" (190mm), 28FR
320-566	Adult size, 7½" (190mm), 30FR
320-568	Adult size, 7½" (190mm), 32FR
320-570	Adult size, 7½" (190mm), 34FR
320-572	Adult size, 7½" (190mm), 36FR

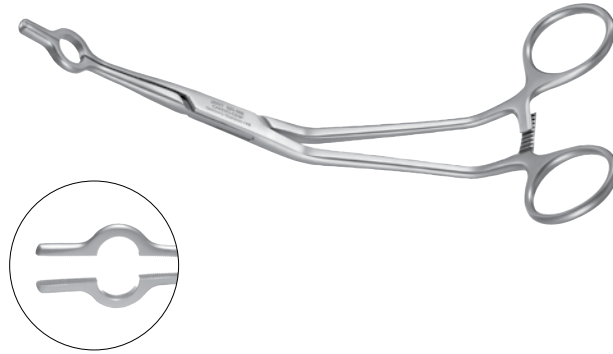

Tube Occluding Forceps Delicate

Catalog #	Description
110-150	6½" (165mm)



Tube Occluding Forceps Delicate

Catalog #	Description
110-154	5¾" (145mm), beveled edges, delicate jaws with smooth inner surfaces



Vorse Tube Occluding Forceps

Catalog #	Description
110-155	6" (154mm)
110-157	7½" (189mm)
110-159	8" (204), heavy jaw



Tube Occluding Forceps, with U-Shaped Guard

Catalog #	Description
110-160	6" (154mm)
110-161	7½" (189mm)
110-162	8" (204), heavy jaw



Glover Bulldog Clamps

adjusting screw to regulate tension

straight, with DeBaKey type jaws

Catalog #	Description
320-120	1⅞" (48mm), jaw working length 20mm, 1.8mm wide jaws
320-125	2¾" (69mm), jaw working length 30mm, 1.8mm wide jaws
320-130	3⅜" (85mm), jaw working length 45mm, 1.8mm wide jaws
320-135	5⅛" (131mm), jaw working length 60mm, 2.2mm wide jaws



Glover Bulldog Clamps

adjusting screw to regulate tension
curved, with DeBakey type jaws

Catalog #	Description
320-122	1¾" (45mm), jaw working length 15mm, 1.8mm wide jaws
320-127	2½" (64mm), jaw working length 25mm, 1.8mm wide jaws
320-132	3⅜" (80mm), jaw working length 35mm, 1.8mm wide jaws
320-137	4¾" (120mm), jaw working length 50mm, 2.2mm wide jaws



Glover Bulldog Clamp

adjusting screw to regulate tension

Catalog #	Description
320-148	2" (51mm), jaw working length 31mm, 90 degree, 1.7mm wide jaws



Cooley Bulldog Clamps

adjusting screw to regulate tension
straight, with Cooley type jaws

Catalog #	Description
320-140	2" (51mm), jaw working length 22mm, 1.7mm wide jaws
320-142	2⅝" (69mm), jaw working length 30mm, 1.7mm wide jaws
320-144	3⅜" (86mm), jaw working length 47mm, 1.7mm wide jaws
320-146	5" (127mm), jaw working length 60mm, 2.6mm wide jaws



Cooley Bulldog Clamps

adjusting screw to regulate tension
curved, with Cooley type jaws

Catalog #	Description
320-141	1¾" (44mm), jaw working length 18mm, 1.6mm wide jaws
320-143	2½" (64mm), jaw working length 25mm, 1.6mm wide jaws
320-145	3" (76mm), jaw working length 35mm, 1.6mm wide jaws
320-147	4½" (114mm), jaw working length 45mm, 2.5mm wide jaws



DeBakey Cross-Action Bulldog Clamps, 2.7kg Tension

straight, with DeBakey type jaws

Catalog #	Description
320-150	3⅛" (80mm), jaw working length 23mm, 2.9mm wide jaws
320-155	3½" (90mm), jaw working length 33mm, 2.9mm wide jaws
320-160	4⅛" (105mm), jaw working length 48mm, 2.9mm wide jaws
320-165	4¾" (120mm), jaw working length 68mm, 2.9mm wide jaws



DeBakey Cross-Action Bulldog Clamps, 2.7kg Tension

curved, with DeBakey type jaws

Catalog #	Description
320-152	3" (75mm), jaw working length 23mm, 2.9mm wide jaws
320-157	3⅜" (85mm), jaw working length 33mm, 2.9mm wide jaws
320-162	3⅞" (100mm), jaw working length 45mm, 2.9mm wide jaws
320-167	4½" (115mm), jaw working length 68mm, 2.9mm wide jaws



Gregory Cross-Action "soft" Bulldog Clamps

1.5kg Tension, with DeBaKey type teeth

Catalog #	Description
320-065	Right angle, short, 4¼" (107mm), jaw working length 16mm, 3.0mm wide jaws
320-179	Right angle, long, 4¾" (110mm), jaw working length 54mm, 3.0mm wide jaws
320-066	Straight, short, 3¾" (87mm), jaw working length 30mm, 2.9mm wide jaws
320-067	Straight, long, 4" (102mm), jaw working length 45mm, 2.8mm wide jaws
320-068	Curved body with right angle tip, long 4¾" (120mm), jaw working length 65mm, 2.7mm wide jaws



Weldon Miniature Bulldog Clamps, Fine Serrated Jaws

Catalog #	Description
320-168	Straight, 1⅜" (34mm), jaw working length 14mm, 0.8mm wide jaws
320-169	Curved, 1¼" (32mm), jaw working length 13mm, 0.8mm wide jaws



Jacobson Micro-Coronary Bulldog Clamps, Fine Serrated Jaws

Catalog #	Description
320-177	Straight, 1 ⁷ / ₈ " (48mm), jaw working length 20mm, 1.1mm wide jaws
320-178	Curved, 1 ³ / ₄ " (44mm), jaw working length 15mm, 1.1mm wide jaws



Diethrich Micro-Coronary Bulldog Clamps, 55gms Tension, Fine Serrated Jaws

Catalog #	Description
320-170	1 ³ / ₄ " (44mm), jaw working length 8mm, 1.1mm wide angled jaws
320-171	1 ⁷ / ₈ " (49mm), jaw working length 8mm, 1.2mm wide straight jaws
320-172	1 ³ / ₄ " (46mm), jaw working length 12mm, 1.2mm wide angled jaws
320-173	2 ¹ / ₈ " (53mm), jaw working length 12mm, 1.2mm wide straight jaws
320-174	1 ⁷ / ₈ " (49mm), jaw working length 18mm, 1.2mm wide angled jaws
320-175	2 ³ / ₈ " (59mm), jaw working length 18mm, 1.2mm wide straight jaws



Diethrich Micro-Coronary Bulldog Clamps, 180kg Tension, Fine Serrated Jaws

Catalog #	Description
320-172ST	1 ³ / ₄ " (46mm), jaw working length 12mm, 1.2mm wide angled jaws
320-175ST	2 ¹ / ₈ " (53mm), jaw working length 12mm, 1.2mm wide straight jaws

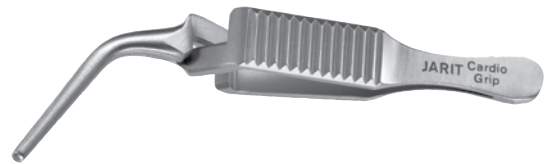

Integra™
Titanium
Instruments

Titanium

Micro Clamps, Pediatric, DeBakey Serrations, Titanium

Catalog #	Description
320-700TI	4¾" (121mm), straight shanks, jaw working length 1⅛" (28mm)



320-701TI	4⅝" (119mm), slightly angled shanks, jaw working length 1⅛" (28mm)
-----------	--



320-702TI	4⅜" (110mm), angled shanks, jaw working length ⅞" (22mm)
-----------	--



320-708TI	4⅜" (110mm), acutely angled shanks, jaw working length 1⅛" (30mm)
-----------	---



Titanium

Micro Clamps, Pediatric, DeBakey Serrations. Titanium

Catalog #	Description
320-703TI	4 ³ / ₈ " (110mm), straight shanks, 45° angled jaw, jaw working length 1" (25mm)



320-709TI	4 ¹ / ₂ " (114mm), straight shanks, 45° angled jaw, jaw working length 1 ¹ / ₈ " (30mm)
-----------	---



320-704TI	4" (102mm), straight shanks, 60° angled jaw, jaw working length 7 ⁷ / ₈ " (23mm)
-----------	--



320-710TI	4 ³ / ₈ " (110mm), straight shanks, 60° angled jaw, jaw working length 1 ¹ / ₈ " (30mm)
-----------	---



Titanium

Micro Clamps, Pediatric, DeBakey Serrations, Titanium

Catalog #	Description
320-706TI	4 1/8" (105mm), straight shanks, jaw working length 1/2" (14mm), jaw depth 1/4" (4mm)



320-705TI	4 1/8" (105mm), slightly angled shanks, jaw working length 1/2" (14mm), jaw depth 1/4" (6mm)
-----------	--



320-711TI	4 3/8" (112mm), slightly angled shanks, jaw working length 7/8" (22mm), jaw depth 1/4" (6mm)
-----------	--



Titanium

Micro Clamps, Pediatric, DeBakey Serrations, Titanium

Catalog #	Description
320-707TI	4 1/8" (105mm), slightly angled shanks, jaw working length 5/8" (16mm), jaw depth 3/8" (5mm)



320-712TI	4 3/8" (112mm), slightly angled shanks, jaw working length 7/16" (11mm), jaw depth 3/8" (4mm)
-----------	---



320-713TI	4 5/8" (118mm), straight shanks, spoon-shaped, jaw working length 1/2" (13mm), jaw depth 1/4" (4mm)
-----------	---



Titanium

Kitzmiller Micro Clamps, DeBakey Serrations, Titanium

Catalog #	Description
320-540TI	4 1/4" (108mm), left angled, jaw working length 5 1/6" (8mm)
320-542TI	4 1/4" (108mm), right angled, jaw working length 5 1/6" (8mm)



Right



Left



Lambert-Kay Aorta Clamp, Titanium

for abdominal and thoracic surgery

Catalog #	Description
320-728TI	7 3/4" (200mm), jaw working length 1 7/8" (48mm), jaw depth 7/8" (23mm)



Titanium
Jarit Stardust® Needle Holders

Unique metallurgical process bonds tungsten carbide particles to the jaws. Extra hardness assures durability and firm grip without damaging needles.

Microvascular Needle Holders, Titanium, Stardust

straight, for use with 3.0, 4.0, and 5.0 suture

Catalog #	Description
124-100TI	7¼" (185mm)
124-101TI	8¾" (220mm)
124-102TI	9¾" (250mm)

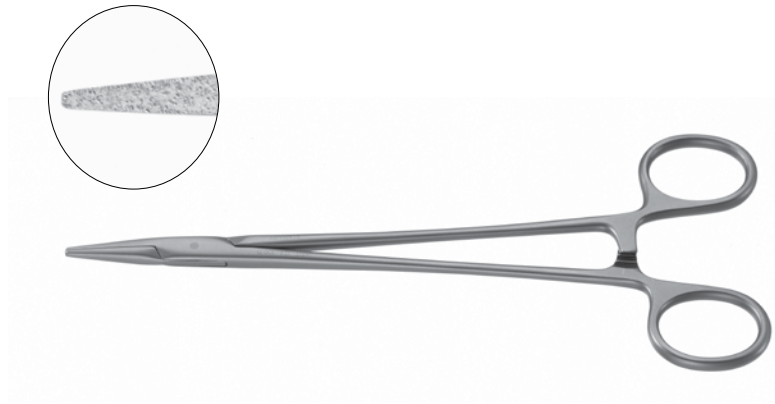
Richards Micro Needle Holders, Titanium, Stardust

extra fine, straight, 1mm tips, for use with 5.0, 6.0, and 7.0 suture

Catalog #	Description
124-105TI	6¼" (156mm)
124-106TI	7" (178mm)



Titanium

Ryder Needle Holders, Titanium, Stardust
straight, 1.5mm tips, for use with 5.0 and 6.0 suture

Catalog #	Description
124-108TI	6 1/4" (157mm)
124-109TI	7" (175mm)
124-110TI	7 3/4" (195mm)

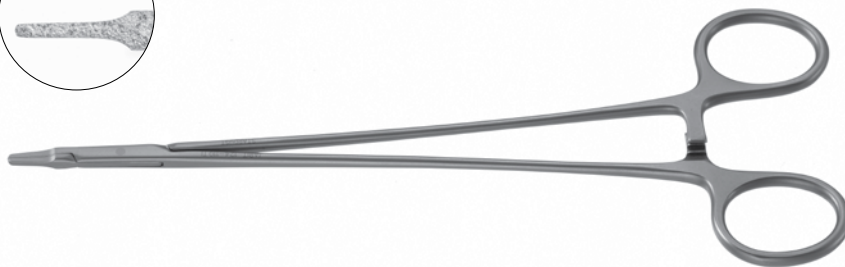
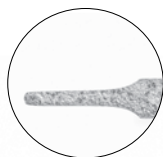

Ryder Needle Holders, Titanium, Carb-Bite
straight, 1.7mm tips, for use with 4.0, 5.0, and 6.0 suture

Catalog #	Description
121-161TI	6 1/4" (157mm)
121-162TI	7" (175mm)
121-163TI	7 3/4" (195mm)

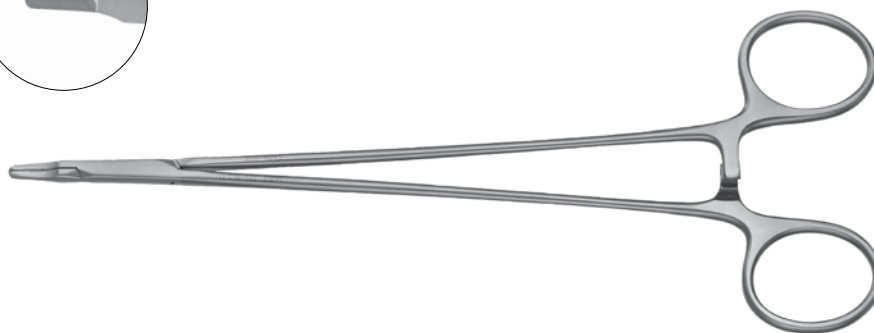
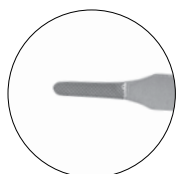

Titanium

DeBakey Forceps, Round Handle, Titanium
straight, 1.8mm tips

Catalog #	Description
320-111TI	7 1/8" (181mm)

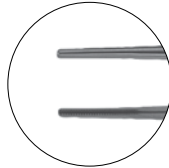

DeBakey Forceps, Titanium
straight, 2.5mm tips

Catalog #	Description
320-084TI	7 3/4" (197mm)
320-085TI	9 1/2" (241mm)

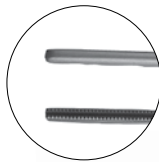

DeBakey Forceps, Titanium
straight, 2.5mm tips

Catalog #	Description
320-083TI	6" (150mm)

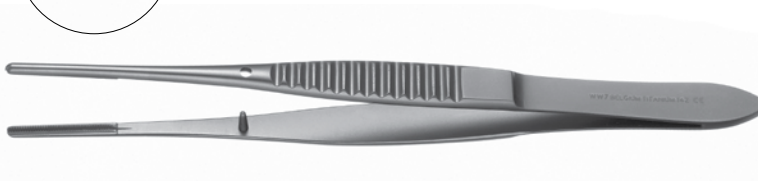
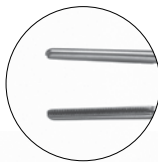

Cushing Tissue Forceps, Titanium
sharp dissecting end, Gutsch handle
straight, delicate, 1.2mm serrated tips

Catalog #	Description
130-425TI	7" (176mm), delicate 1.2mm serrated tips

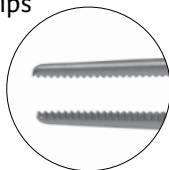

Titanium

Jarit Micro Stardust Needle Holder, Titanium, Flat Handle, Low Profile Box Lock

0.8mm micro tip

Catalog #	Description
278-080TI	7" (180mm), flat handles, straight jaws, with catch
278-082TI	8 1/4" (210mm), flat handles, straight jaws, with catch



Jarit Micro Stardust Needle Holder, Titanium, Round Handle, Low Profile Box Lock

0.7mm micro tip

Catalog #	Description
278-141TI	4 3/4" (120mm), straight jaws, with catch
278-093TI	7" (180mm), straight jaws, with catch
278-095TI	7 3/4" (200mm), straight jaws, with catch
278-097TI	10" (255mm), straight jaws, with catch
278-140TI	4 3/4" (120mm), straight jaws, without catch
278-142TI	4 3/4" (120mm), curved jaws, without catch



Jarit Micro Stardust Needle Holder, Titanium, Round Handle, Low Profile Box Lock

0.8mm micro tip

Catalog #	Description
278-108TI	5 7/8" (148mm), straight jaws, with catch
278-111TI	7" (178mm), straight jaws, with catch
278-113TI	7 3/4" (200mm), straight jaws, with catch

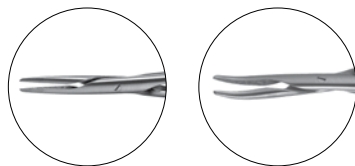

Titanium

Jarit Micro Stardust Needle Holder, Titanium

round handle, with catch, low profile box lock, delicate 1.2mm tip

Catalog #	Description
278-143TI	4¾" (120mm), curved jaws
278-145TI	5⅞" (148mm), straight jaws
278-147TI	5⅞" (148mm), curved jaws,
278-069TI	7" (178mm), straight jaws
278-071TI	7" (178mm), curved jaws
278-078TI	7¾" (200mm), curved jaws

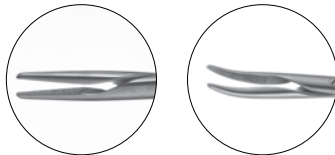

Jarit Micro Stardust Needle Holder, Titanium

round handle, without catch, low profile box lock, delicate 1.2mm tip

Catalog #	Description
278-144TI	5⅞" (148mm), straight jaws
278-146TI	5⅞" (148mm), curved jaws
278-070TI	7" (178mm), straight jaws,
278-072TI	7" (178mm), curved jaws
278-077TI	7¾" (200mm), straight jaws
278-079TI	7¾" (200mm), curved jaws

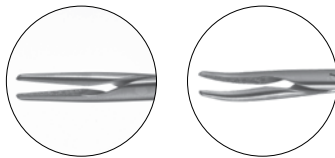

Jacobson Stardust Needle Holder, Titanium

round handle, low profile box lock, heavy style, 2mm tip

Catalog #	Description
278-171TI	7½" (190mm), straight jaws, with catch
278-172TI	5⅞" (148mm), curved jaws, with catch
278-173TI	7" (178mm), straight jaws, without catch
278-174TI	7" (178mm), curved jaws, without catch

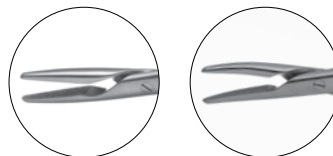

Titanium

DeBakey-Dietrich Coronary Artery Forceps, Titanium

round handle, delicate 1.2mm tips

Catalog #	Description
320-113TI	6 1/8" (156mm)
320-114TI	7 1/8" (180mm)
320-115TI	8 1/4" (210mm)

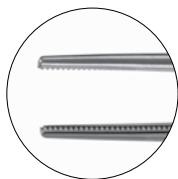

DeBakey Forceps, Titanium

flat handle, 1.5mm tips

Catalog #	Description
320-080TI	6" (150mm)
320-081TI	7 3/4" (195mm)
320-082TI	9 1/2" (241mm)

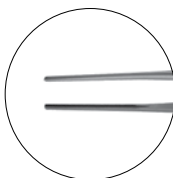

Dennis Micro Ring Forceps, Titanium

with contour balance, round handle, straight, 1mm Stardust tips

Catalog #	Description
279-110TI	7 1/4" (181mm)
279-111TI	8 1/8" (210mm)
279-112TI	9 1/8" (229mm)

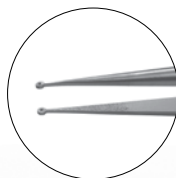

Titanium

Bailey-Finochietto Pediatric Rib Spreader, Titanium

Catalog #	Description
320-517TI	Spread: 2¾" (70mm), Arm length: 2⅜" (60mm) Blades: ⅝" x ¾" deep (16mm x 20mm)



Titanium

Rhoton-Type Dissectors, Titanium

round, 7½" (190mm)

Catalog #	Description
277-260TI	1mm blade, #1
277-261TI	2mm blade, #2
277-262TI	3mm blade, #3



Rhoton-Type Elevators, Titanium

7½" (190mm)

Catalog #	Description
277-263TI	Curved, #4
277-264TI	Angled, #5



Rhoton-Type Spatula Dissectors, Titanium

7½" (190mm)

Catalog #	Description
277-265TI	Small, #6
277-266TI	Medium, #7
277-267TI	Large, #8



Rhoton-Type Hooks, Titanium

7½" (190mm)

Catalog #	Description
277-268TI	90° angle, semi-sharp, #9
277-269TI	90° angle, blunt, #10
277-270TI	45° angle, semi-sharp, #11



Rhoton-Type Needle, Titanium

7½" (190mm)

Catalog #	Description
277-271TI	Straight, #12



Titanium

Rhoton-Type Currettes, Titanium

7½" (190mm)

Catalog #	Description
277-272TI	Straight, #13
277-273TI	Angled, #14



Rhoton-Type Ball-Dissectors, Titanium

7½" (190mm)

Catalog #	Description
277-274TI	90° angle, 3mm, #15
277-276TI	Straight, #16
277-277TI	90° angle, 5mm, #17
277-278TI	40° angle, 4mm, #18
277-279TI	40° angle, 8mm, #19



Rhoton-Type Instrument Rack

Catalog #	Description
277-275TI	For 19 stainless steel or titanium instruments, 277-260TI through 277-279TI, 10" x 8¾" x 1" (255mm x 223mm x 25mm)

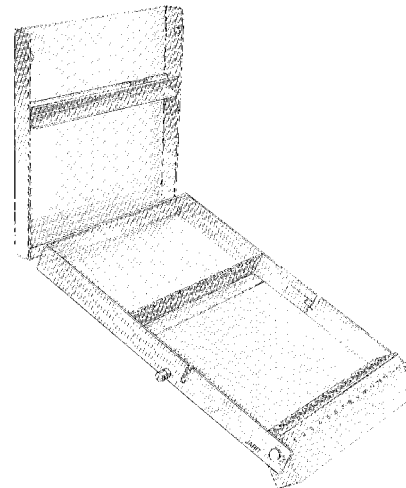

Titanium

Jarit Micro Stardust Needle Holder, Titanium

flat handles, low profile box lock, 0.8mm micro tip

Catalog #	Description
278-080TI	7" (180mm), straight jaws, with catch
278-082TI	8¼" (210mm), straight jaws, with catch



Jarit Micro Stardust Needle Holder, Titanium

round handles, low profile box lock, 0.8mm micro tip

Catalog #	Description
278-093TI	7" (180mm), straight jaws, with catch
278-095TI	7¾" (200mm), straight jaws, with catch
278-097TI	10" (255mm), straight jaws, with catch

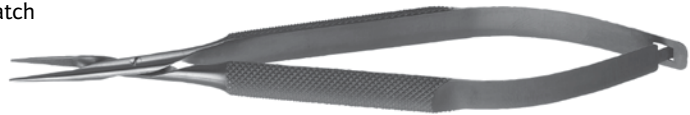

Jarit Micro Stardust Needle Holder, Titanium

round handles, low profile box lock, 0.8mm micro tip

Catalog #	Description
278-108TI	5⅞" (148mm), straight jaws, with catch
278-111TI	7" (178mm), straight jaws, with catch
278-113TI	7¾" (200mm), straight jaws, with catch

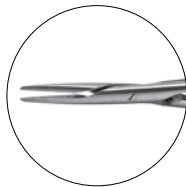

Titanium
Jarit Stardust® Micro Suture Forceps

A matched set of forceps designed for tissue manipulation and needle guide. Unique metallurgical process bonds tungsten carbide particles to the jaws. Extra hardness assures durability and firm grip without damaging needles.

Jarit Micro Forceps, Titanium, Round Handle, Stardust Platform Tips

Catalog #	Description
279-093TI	7¼" (184mm), straight
279-094TI	7¼" (184mm), curved
279-097TI	8¼" (210mm), straight
279-098TI	10" (254mm), straight

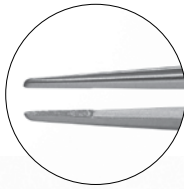
Jarit Micro Ring Forceps, Titanium, Stardust Tips

Catalog #	Description
279-083TI	6" (152mm), 1mm ring tips
279-088TI	6" (152mm), 2mm ring tips
279-084TI	7½" (181mm), 1mm ring tips
279-089TI	7½" (181mm), 2mm ring tips

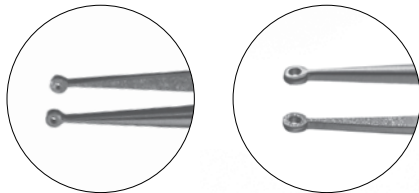

Titanium

Gerald Stardust Forceps, Titanium, Delicate 0.8mm Platform Tips

Catalog #	Description
279-150TI	7" (178mm)
279-151TI	8" (203mm)



Gerald Forceps, Titanium
delicate 1mm DeBakey tips

Catalog #	Description
285-131TI	7" (180mm)
285-132TI	8 1/4" (210mm)

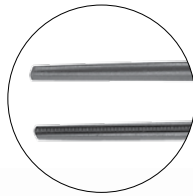

Cushing Tissue Forceps, Titanium, Semi-Sharp Dissecting End, Gutsch Handle

Catalog #	Description
130-425TI	7" (176mm), delicate 1.2mm serrated tips

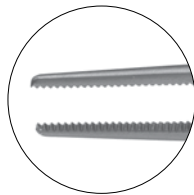

Titanium

Jarit Stardust Micro Suture Forceps, Titanium
tungsten carbide coated, round handles with counter-balance

straight,
with tying platform

Catalog #	Description
279-100TI	7¼" (184mm)
279-101TI	8¼" (210mm)
279-102TI	9" (229mm)



micro ring,
(1.0mm OD x 0.5mm ID)

Catalog #	Description
279-110TI	7¼" (181mm)
279-111TI	8¼" (210mm)
279-112TI	9" (229mm)



Titanium

Jewelers Style Forceps
style 1: fine

Catalog #	Description
355-170TI	4 ³ / ₄ " (120mm)

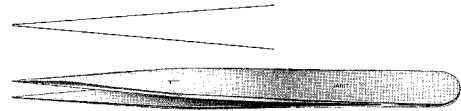

Jewelers Style Forceps
style 3: very fine

Catalog #	Description
355-171TI	4 ³ / ₄ " (120mm)



Jewelers Style Forceps
style 7: very fine, curved

Catalog #	Description
355-175TI	4 ⁵ / ₈ " (118mm)

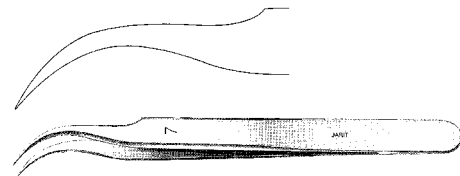

Integra™
Ophthalmic
Instruments and
General Surgical
Instruments

McPherson Eye Speculum

3 1/8" (80mm)

Catalog #	Description
350-090	14mm blades, 45mm spread

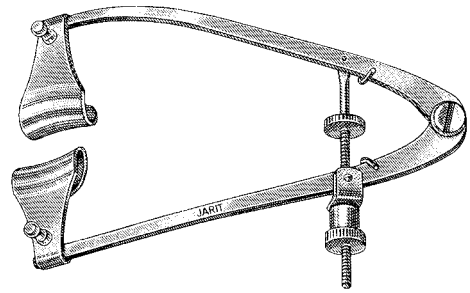

Barraquer Eye Specula

solid blades

Catalog #	Description
350-092	1 1/2" (37mm), 11mm blades, 18mm spread, pediatric size
350-093	1 5/8" (40mm), 14mm blades, 20mm spread

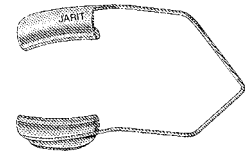

Barraquer Eye Specula

open wire blades

Catalog #	Description
350-094	1 1/8" (30mm), 9mm blades, 15mm spread, pediatric size
350-095	1 5/8" (40mm), 14mm blades, 18mm spread

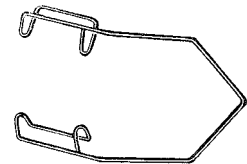

Kratz-Barraquer Eye Speculum

1 5/8" (42mm), open wire blades

Catalog #	Description
350-096	15mm blades, 18mm spread

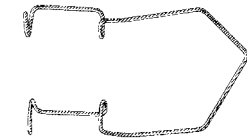

Sauer Eye Speculum, Infant

1 1/4" (31mm)

Catalog #	Description
350-097	11mm blades, 20mm spread

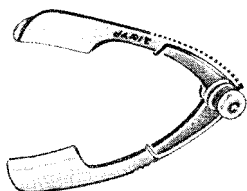

Alfonso Eye Speculum, Newborn

1¾" (44mm)

Catalog #	Description
350-098	5mm blades, 27mm spread

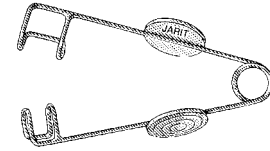

Williams Eye Specula

Catalog #	Description
350-100	2⅝" (67mm), 11mm blades, 26mm spread
350-101	3⅛" (79mm), 15mm blades, 32mm spread

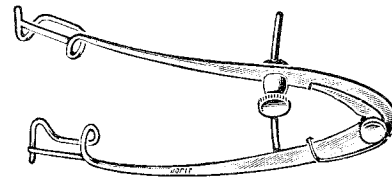

Lancaster Eye Speculum

3⅛" (79mm)

Catalog #	Description
350-105	15mm blades, 32mm spread

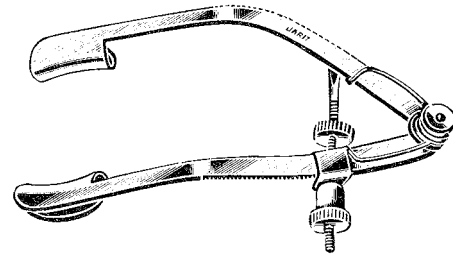

Wiener Eye Speculum

2" (50mm)

Catalog #	Description
350-110	14mm blades, 25mm spread

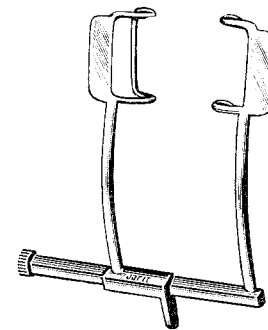

Cook Eye Speculum, Infant

1½" (37mm)

Catalog #	Description
350-112	with locking screw, 7.5mm blades, 21mm spread

350-TSC-112 Replacement Thumb Screw pkg/2ea

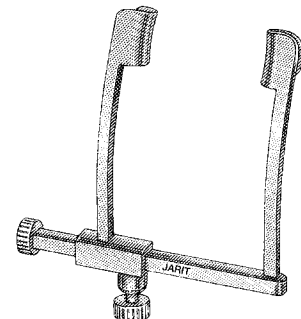

Maumenee-Park Eye Speculum

3 1/8" (80mm)

Catalog #	Description
350-118	Fenestrated blades and canthus bar, 14.5mm blades, 43mm spread

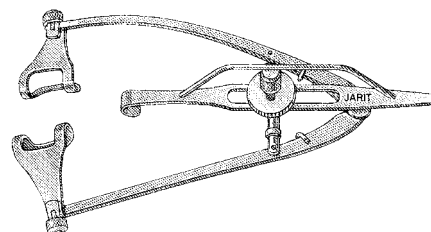

Maumenee-Park Eye Speculum

3 1/8" (80mm)

Catalog #	Description
350-119	Fenestrated blades and canthus bar, 14.5mm blades, 40mm spread

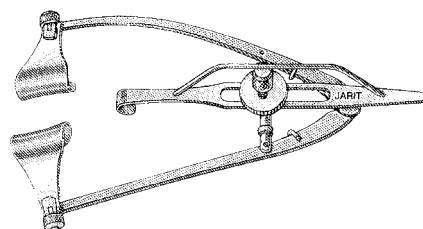

Park-Guyton Eye Speculum

3 1/8" (80mm)

Catalog #	Description
350-120	Fenestrated blades and canthus bar, 14mm blades, 43mm spread

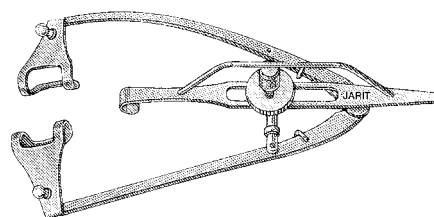

Park-Guyton Eye Speculum

3 1/8" (80mm)

Catalog #	Description
350-121	Solid blades and canthus bar, 14.5mm blades, 40mm spread

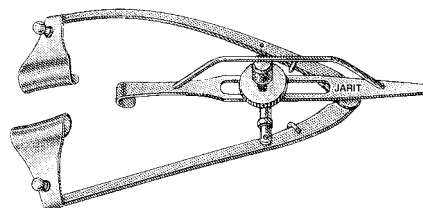

Castroviejo Eye Specula

3 5/8" (92mm)

Catalog #	Description
350-125	13.5mm blades, 34mm spread
350-126	15.5mm blades, 35mm spread

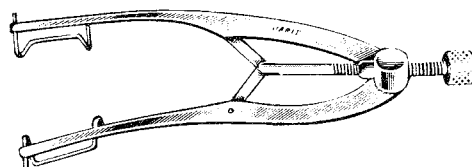

Stevenson Lacrimal Sac Retractor

Catalog #	Description
350-140	3mm deep semi-sharp prongs, 20mm spread

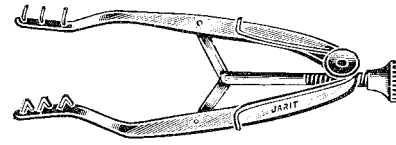

Agricola Lacrimal Sac Retractor

Catalog #	Description
350-142	4mm deep sharp prongs, 30mm spread

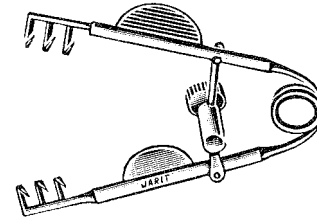

Goldstein Lacrimal Sac Retractor

Catalog #	Description
350-144	4mm deep sharp prongs, 17mm spread

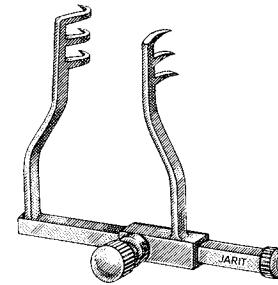

Desmarres Lid Retractors

5 1/2" (140mm)

Catalog #	Description
350-149	Size 0: 10mm
350-150	Size 1: 12mm
350-151	Size 2: 14mm
350-152	Size 3: 16mm
350-153	Size 4: 18mm

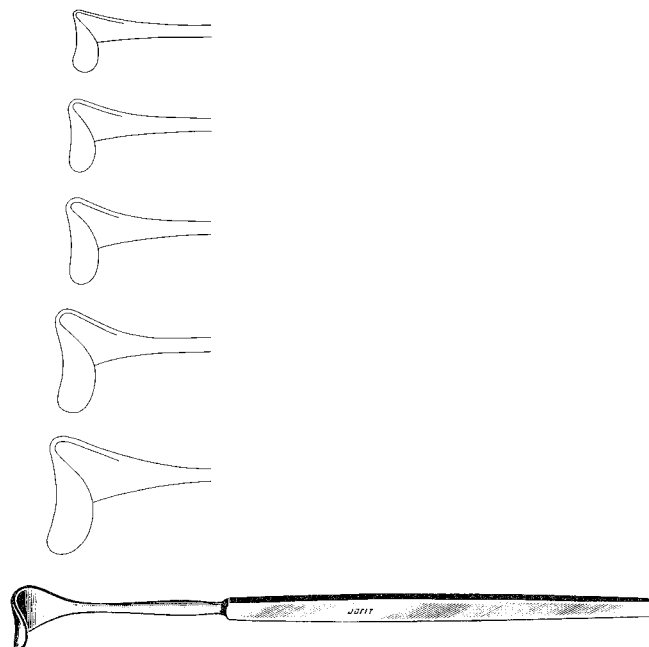

Jaffe Lid Retractor

1⁵/₈" (40mm), pair

Catalog #	Description
350-155	15mm wide curved blades



Schepens Orbital Retractor

6" (150mm)

Catalog #	Description
350-160	14mm wide x 60mm blade



Wheeler Discission Knife

4¹/₂" (114mm)

Catalog #	Description
350-210	1.3mm x 18mm blade

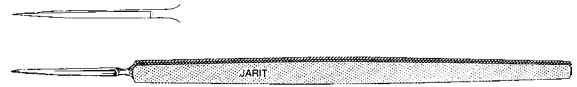

Paufique Garft Knife

4¹/₈" (105mm)

Catalog #	Description
350-250	1.6mm x 1.75mm angled blade

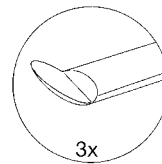

Gill Corneal Knives

4³/₄" (120mm), 3.3mm x 8mm blade

Catalog #	Description
350-255	Straight
350-256	Curved

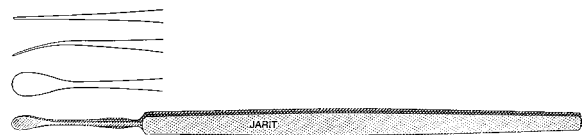

Tooke Corneal Knife

4¹/₂" (115mm)

Catalog #	Description
350-260	3mm x 18mm blade



Castroviejo Blade Breaker and Holder

5 1/8" (130mm)

Catalog #	Description
350-290	12mm smooth jaws, round knurled handle with end lock

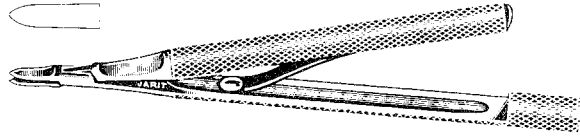

Barraquer Blade Breaker and Holder

4 3/8" (110mm)

Catalog #	Description
350-292	12mm smooth jaws, flat grooved handle with spring lock

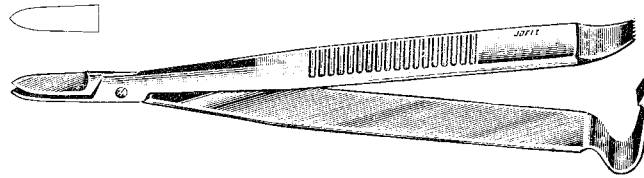

Castroviejo Blade Breaker and Holder

5 5/8" (143mm)

Catalog #	Description
350-294	12mm Stardust jaws, round knurled handle with slide lock

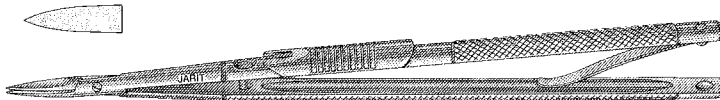

Meyhoeffer Chalazion Currettes

5" (127mm)

Catalog #	Description
350-300	Size 3-0: 0.5mm diameter
350-301	Size 2-0: 1mm diameter
350-302	Size 0: 1.5mm diameter
350-303	Size 1: 2mm diameter
350-304	Size 2: 2.5mm diameter
350-305	Size 3: 3mm diameter

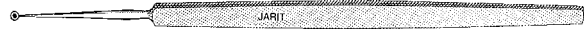

Gills-Welsh Curette Capsule Polisher

5 1/8" (130mm)

Catalog #	Description
350-310	2mm cup, 45° angled shaft, 8mm from tip to bend



Dix Foreign Body Spud

4 3/4" (121mm)

Catalog #	Description
350-320	Blade 2.3mm wide x 16mm long

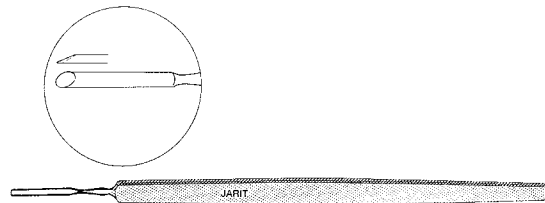

Francis Foreign Body Spud

4 5/8" (117mm)

Catalog #	Description
350-321	Blade 1.1mm wide x 1.3mm long

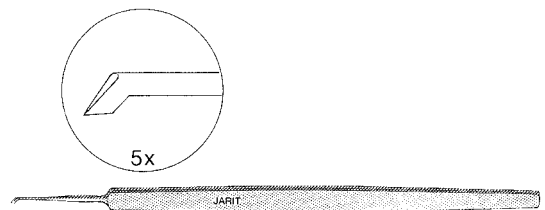

La Force Foreign Body Spud

Catalog #	Description
350-322	4¾" (120mm)

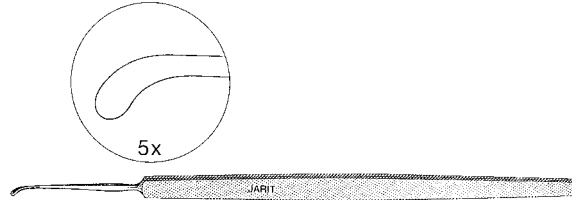

Foreign Body Spud w/ spear point

Catalog #	Description
350-325	4⅞" (124mm), 2.5mm, curved blade

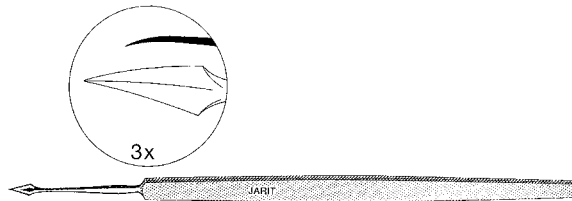

Magnetic Eye Probe w/ foreign body loop

Catalog #	Description
350-330	4¾" (120mm)

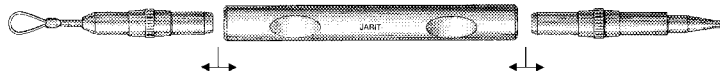

Fixation Hooks

5" (127mm), 2 sharp prongs

Catalog #	Description
350-340	1.5mm spread between tips
350-341	2.0mm spread between tips

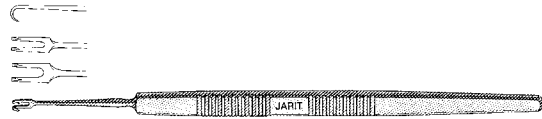

Tyrell Hooks

4¾" (120mm), 2mm

Catalog #	Description
350-344	Sharp
350-345	Blunt

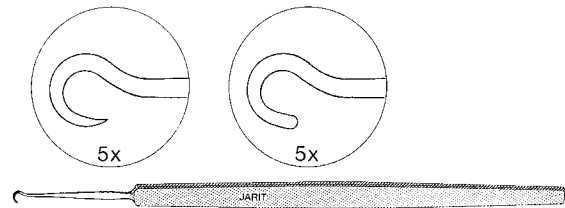

Shepard Iris Hook

4⅞" (124mm)

Catalog #	Description
350-347	1mm, blunt

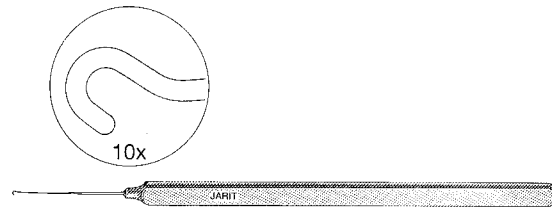

Bonn Iris Hook

4⅞" (124mm)

Catalog #	Description
350-348	0.3mm, blunt

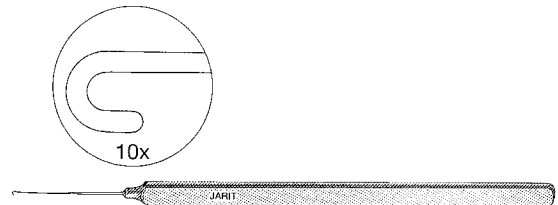

Hirschman Iris Hook

4¾" (121mm)

Catalog #	Description
350-349	0.75mm hook, 45° angled shaft, 9mm from tip to bend

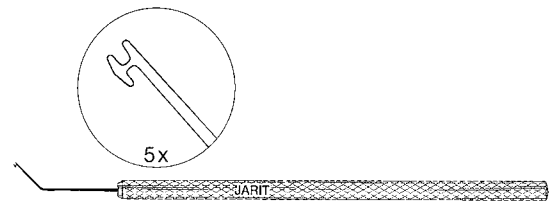

Von Graefe Strabismus Hooks

5½" (140mm)

Catalog #	Description
350-350	Size 1: 7.8mm hook
350-351	Size 2: 9.5mm hook
350-352	Size 3: 11.5mm hook

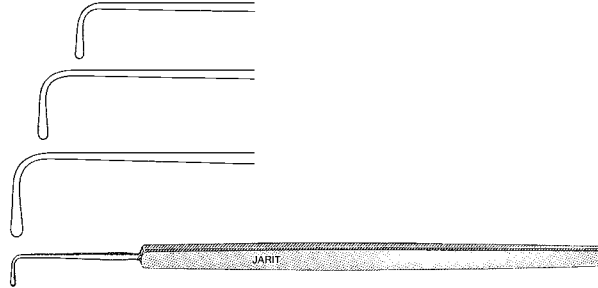

Jameson Muscle Hooks

5" (127mm)

Catalog #	Description
350-353	8mm hook, 1.4mm tip

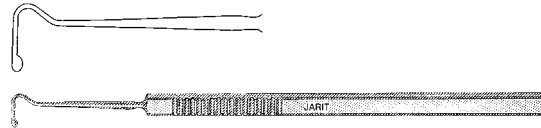

Jameson Muscle Hooks

5¼" (127mm)

Catalog #	Description
350-354	11mm hook, 1.8mm tip

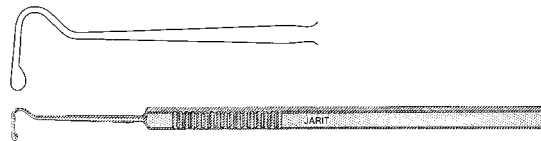

Stevens Tenotomy Hook

4⅞" (124mm)

Catalog #	Description
350-355	6mm hook

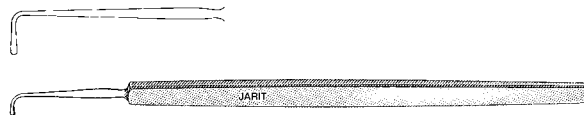

Green Strabismus Hook

5⅛" (130mm)

Catalog #	Description
350-357	10mm hook

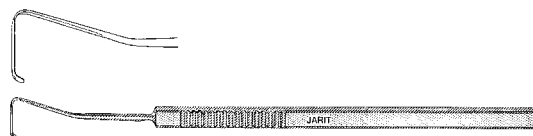

O'Connor Hook

4 7/8" (124mm)

Catalog #	Description
350-360	4.5mm hook

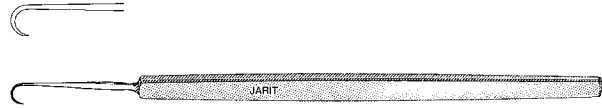

Clayman Iris Hook

4 5/8" (117mm)

Catalog #	Description
350-362	0.3mm hook, 45° angled shaft, 9mm from tip to bend

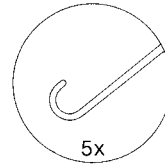

Clayman Iris Hook

4 1/2" (114mm)

Catalog #	Description
350-363	0.2mm hook, 45° angled shaft, 10mm from tip to bend

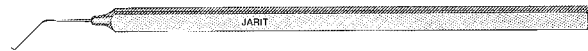
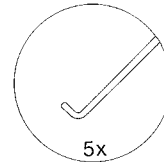

Sinskey Iris and I.O.L. Hook

4 1/2" (114mm)

Catalog #	Description
350-365	0.2mm hook

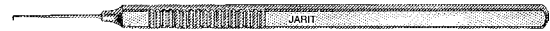
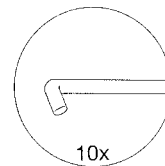

Sinskey Modified Hook

4 3/4" (121mm)

Catalog #	Description
350-366	0.2mm hook, curved shaft

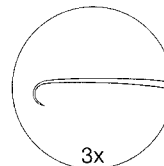

Knolle Iris Hook

4 7/8" (124mm)

Catalog #	Description
350-368	0.5mm hook

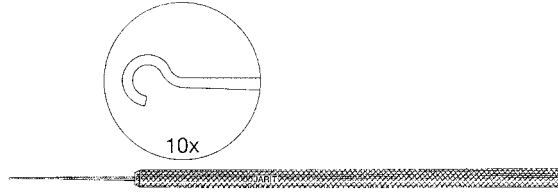

Kuglen Iris Hook and Lens Manipulator

4 5/8" (117mm)

Catalog #	Description
350-369	0.5mm "K" hook

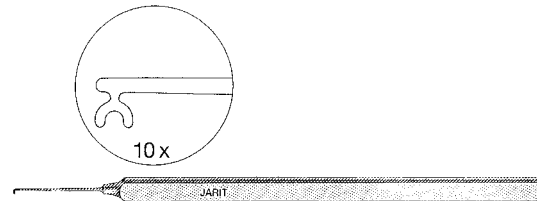

Guthrie Fixation Hooks

Catalog #	Description
350-370	4 3/4" (120mm), 1.5mm spread between the tips
350-371	5" (127mm), 2.5mm spread between the tips

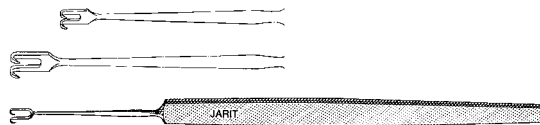

Gass Retinal Detachment Hook

5 3/4" (146mm)

Catalog #	Description
350-372	13mm hook

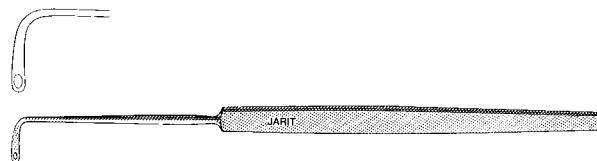

Burch Fixation Pick

5" (127mm)

Catalog #	Description
350-377	3mm spread between points

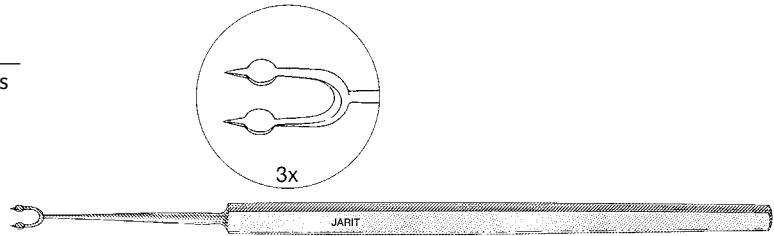

Scleral Twist Fixation Hooks

4 1/4" (109mm), 1mm tips

Catalog #	Description
350-380	Right
350-381	Left

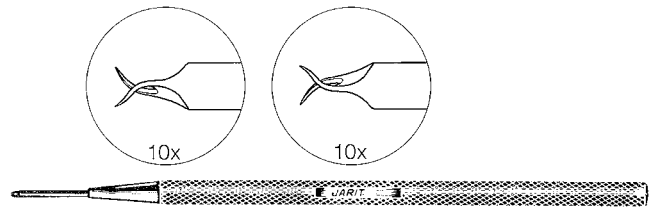

Barraquer Iris Spatula

4 1/2" (114mm)

Catalog #	Description
350-383	0.25mm x 15mm angled blade

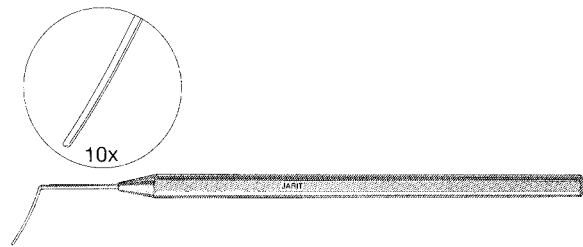

Knolle Lens Nucleus Spatula and Gauge

5" (127mm)

Catalog #	Description
350-384	30mm blade, with markings at 5mm, 6mm, and 7mm from tip

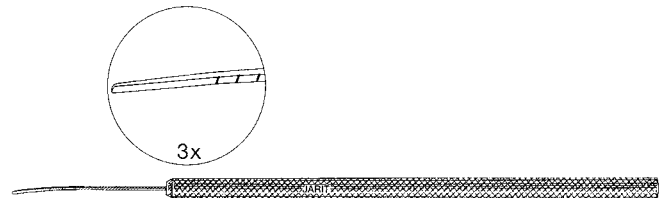

Hirschman Iris Lens Spatula

4 7/8" (124mm)

Catalog #	Description
350-385	10mm angled blade, notched on sides and tip

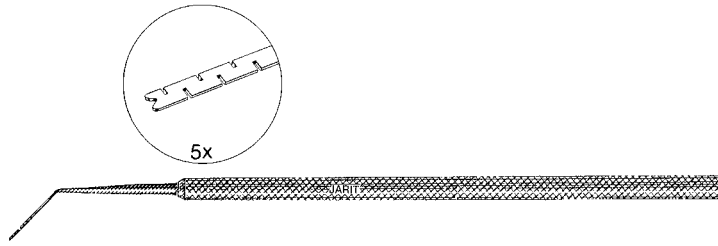

Kimura Platinum Spatula

5 7/8" (149mm)

Catalog #	Description
350-387	3.5mm wide x 30mm long blade



Wheeler Cyclodialysis Spatula

5 1/4" (134mm)

Catalog #	Description
350-390	Double ended, silver, 2mm x 22mm blades



Castroviejo Cyclodialysis Spatula

5" (127mm)

Catalog #	Description
350-392	Double ended, 0.5mm x 10mm and 15mm blades

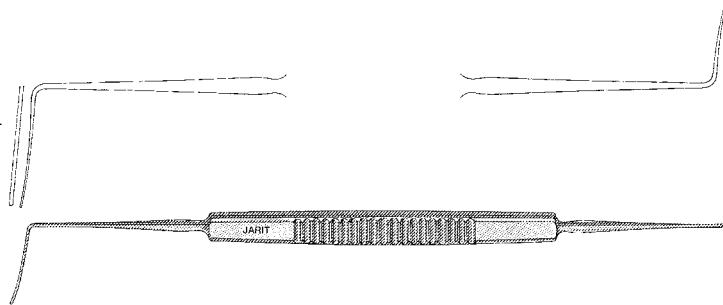

Wecker Iris Spatula

5 1/8" (129mm)

Catalog #	Description
350-395	Malleable, silver, 2.6mm x 30mm blade



Barraquer Cyclodialysis Spatula

4 3/4" (120mm)

Catalog #	Description
350-397	0.5mm x 15mm angled blade, round knurled handle

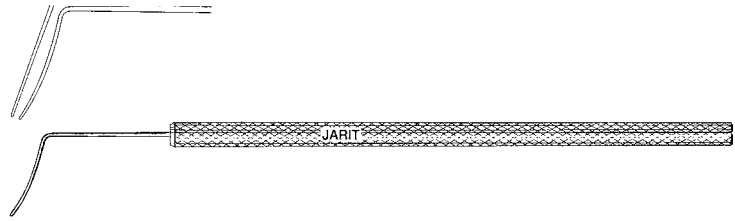

Barraquer Iris Spatula

3 1/2" (90mm)

Catalog #	Description
350-398	0.5mm x 15mm angled blade, hexagonal handle

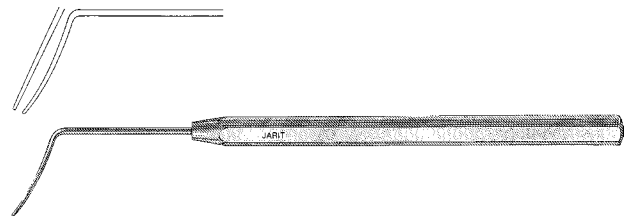

Castroviejo Synechia Spatula

5" (127mm)

Catalog #	Description
350-400	Double ended, 0.5mm x 10mm and 15mm blades

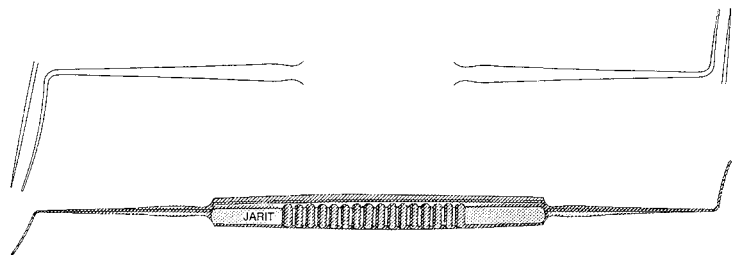

Culler Iris Spatula

5" (127mm)

Catalog #	Description
350-405	Sterling silver blade, 1mm x 28mm

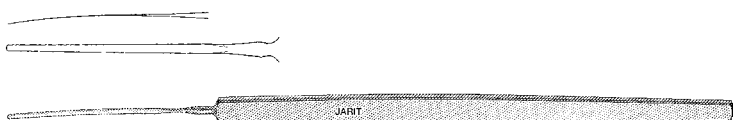

Bechert Nucleus Rotator

4 1/2" (113mm)

Catalog #	Description
350-410	"Y" shape tip, shaft angled 7mm from tip to bend

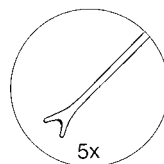

Lewis Lens Loop

5½" (140mm)

Catalog #	Description
350-415	6mm wide x 7mm loop

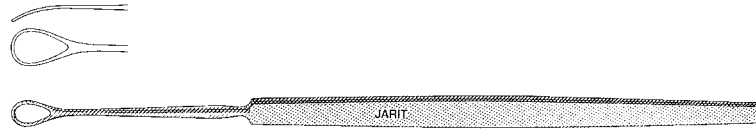

New Orleans Lens Loop

5½" (140mm)

Catalog #	Description
350-420	5mm wide x 10mm loop

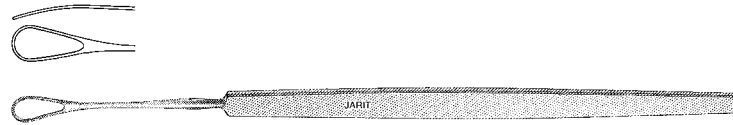

Wilder Lens Loop

5½" (140mm)

Catalog #	Description
350-425	4mm wide x 15mm loop, serrated

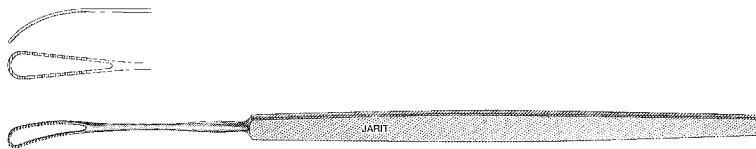

Gills-Welsh Lens Loop

4¾" (121mm)

Catalog #	Description
350-430	Double-ended, 5mm wide x 7mm loop, olive tip on opposite end

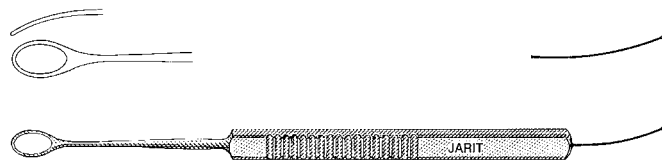

Simcoe Nucleus Loop

5½" (140mm)

Catalog #	Description
350-435	Double-ended, 4mm wide x 13mm left and right loops, serrated

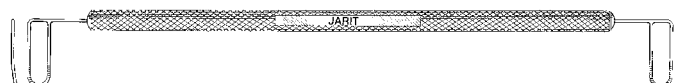

Bunge Evisceration Spoon

5 7/16" (138mm)

Catalog #	Description
350-440	Large, 12mm diameter

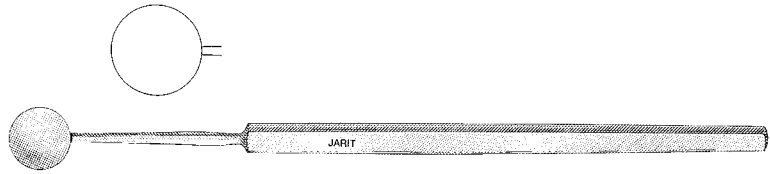

Bunge Evisceration Spoon

5 1/4" (132mm)

Catalog #	Description
350-441	Small, 8mm diameter

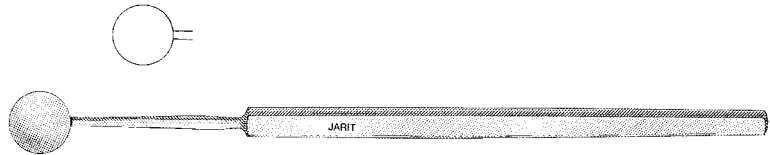

Wells Enucleation Spoon

5 3/4" (145mm)

Catalog #	Description
350-445	21mm wide

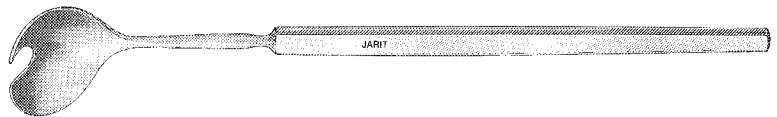

Eye Dressing Forceps

3⁷/₈" (99mm)

Catalog #	Description
355-090	Delicate, serrated, straight, 0.5mm wide at tip

Eye Dressing Forceps

3⁷/₈" (99mm)

Catalog #	Description
355-100	Serrated, straight, 0.8mm wide at tip

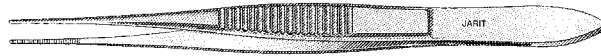

Eye Dressing Forceps

3⁷/₈" (99mm)

Catalog #	Description
355-091	Delicate, serrated, half curved, 0.5mm wide at tip

Eye Dressing Forceps

3⁷/₈" (99mm)

Catalog #	Description
355-101	Serrated, half curved, 0.8mm wide at tip

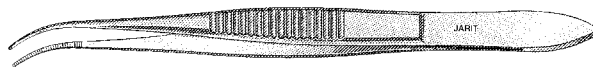

Eye Dressing Forceps

3⁷/₈" (99mm)

Catalog #	Description
355-092	Delicate, serrated, full curve, 0.5mm wide at tip

Eye Dressing Forceps

3⁷/₈" (99mm)

Catalog #	Description
355-102	Serrated, full curve, 0.8mm wide at tip

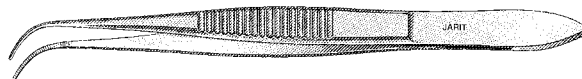

Iris Forceps

3 7/8" (99mm)

Catalog #	Description
355-095	Delicate, straight, 1 x 2 teeth, 0.6mm wide at tip

Iris Forceps

3 7/8" (99mm)



Catalog #	Description
355-110	Straight, 1 x 2 teeth, 0.8mm wide at tip

Iris Forceps

3 7/8" (99mm)

Catalog #	Description
355-096	Delicate, half curved, 1 x 2 teeth, 0.6mm wide at tip

Iris Forceps

3 7/8" (99mm)

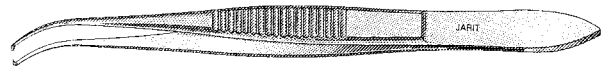

Catalog #	Description
355-111	Half curved, 1 x 2 teeth, 0.8mm wide at tip

Iris Forceps

3 7/8" (99mm)

Catalog #	Description
355-097	Delicate, full curve, 1 x 2 teeth, 0.6mm wide at tip

Iris Forceps

3 7/8" (99mm)

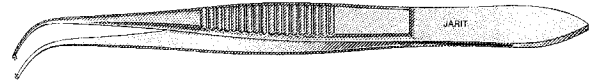

Catalog #	Description
355-112	Full curve, 1 x 2 teeth, 0.8mm wide at tip

Von Graefe Iris Forceps

2 3/4" (72mm), straight, 0.7mm tip

Catalog #	Description
355-115	Serrated
355-116	1 x 2 teeth

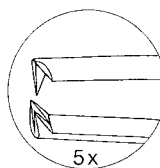
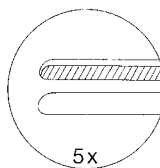

Von Graefe Iris Forceps

2¾" (72mm), curved, 0.7mm tip

Catalog #	Description
355-117	Serrated
355-118	1 x 2 teeth

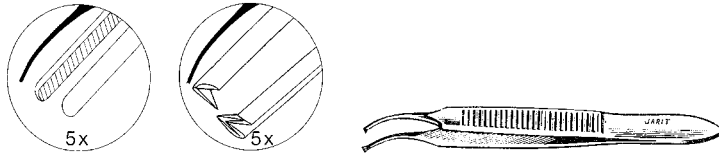

Gill Iris Forceps

3" (75mm)

Catalog #	Description
355-119	Curved, 0.5mm tip, 1 x 2 teeth

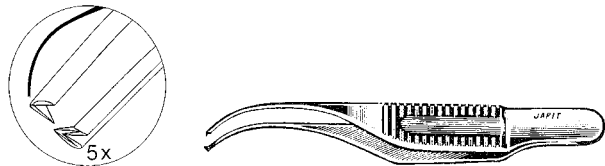

Bishop-Harmon Iris Forceps

Catalog #	Description
355-120	3½" (88mm), 0.6mm, 1 x 2 teeth
355-121	3¼" (82mm), 0.5mm, 1 x 2 teeth, extra delicate
355-122	3¼" (82mm), 0.4mm, 1 x 2 teeth, micro-surgery
355-123	3¾" (85mm), 0.6mm, serrated

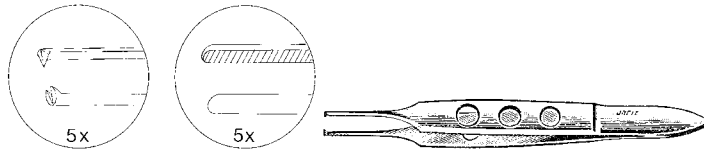

Gill Iris Forceps

3" (75mm)

Catalog #	Description
355-125	Curved, 0.7mm tip, 1 x 2 teeth down

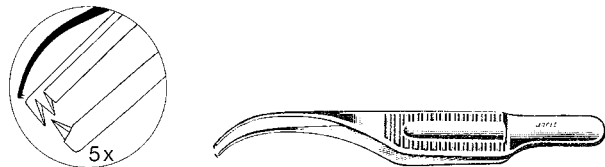

Gill Iris Forceps

3" (75mm)

Catalog #	Description
355-126	Curved, cross-serrated, .05mm tip

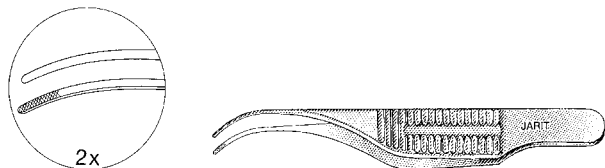

Botvin Iris Forceps

3" (75mm)

Catalog #	Description
355-128	Bayonet-shaped, cross-serrated, .05mm tip

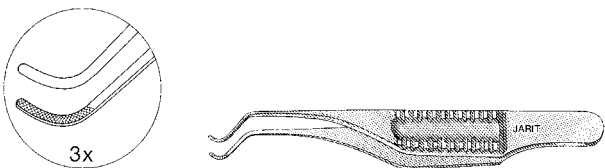

Von Graefe Fixation Forceps

4 3/8" (112mm)

Catalog #	Description
355-130	Plain, 4.5mm jaws

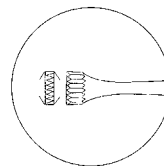

Von Graefe Fixation Forceps

4 3/8" (112mm)

Catalog #	Description
355-131	with Catch, 4.5mm jaws

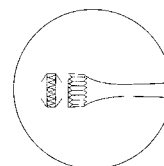

Thorpe Conjunctival Fixation Forceps

3 3/4" (95mm)

Catalog #	Description
355-132	2 x 3 teeth with (3mm) tying platform

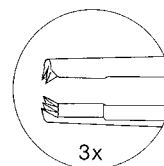

Elsching Fixation Forceps

4 1/8" (106mm)

Catalog #	Description
355-135	1 x 2 teeth (0.8mm tip)

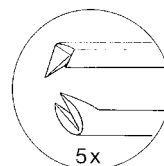

Bracken Fixation Forceps

4" (103mm)

Catalog #	Description
355-137	1 x 2 teeth (0.8mm tip)

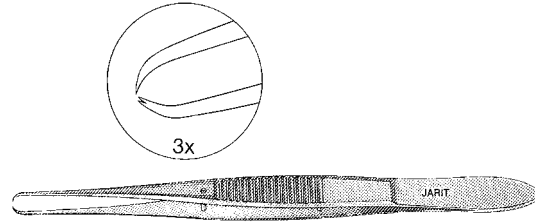

Green Fixation Forceps

4" (103mm)

Catalog #	Description
355-138	10mm jaws with fine teeth

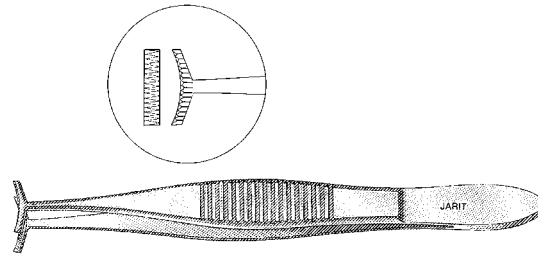

Lester Fixation Forceps

3 7/8" (97mm)

Catalog #	Description
355-140	1 x 2 teeth (0.55mm tip)

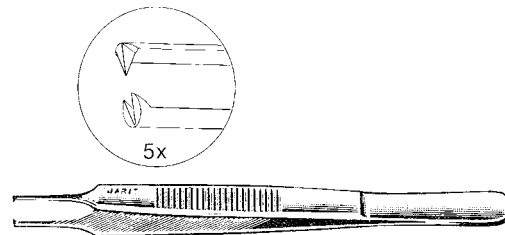

Lester Fixation Forceps

3 3/4" (96mm)

Catalog #	Description
355-141	2 x 3 teeth (1.1mm tip)

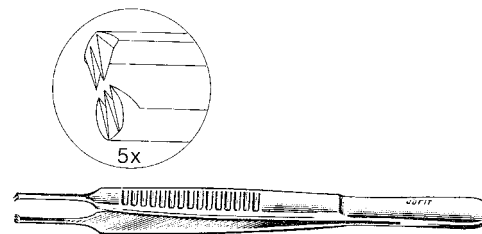

Bonn Suture Forceps

3¾" (96mm)

Catalog #	Description
355-142	0.12mm teeth, 4mm tying platform

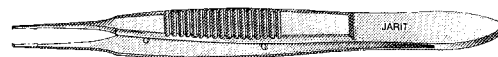
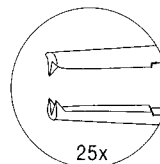

Bonn Iris Forceps

2¾" (70mm)

Catalog #	Description
355-143	Original pattern, 0.12mm teeth without tying platform

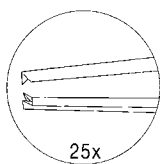

Bonn Iris Forceps

2¾" (70mm)

Catalog #	Description
355-144	0.12mm teeth, 4mm tying platform

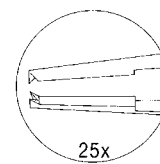

Troutman-Barraquer Utility Forceps (Colibri-Type)

2⅞" (73mm), teeth at 45° angle, 6.5mm tying platform

Catalog #	Description
355-145	0.12mm teeth
355-146	0.3mm teeth
355-147	0.5mm teeth

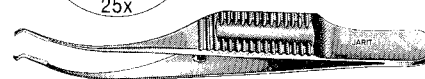
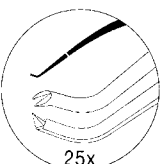

Castroviejo Colibri Forceps

4 1/8" (104mm)

Catalog #	Description
355-148	Wide handle, 0.12mm teeth, 7mm tying platform

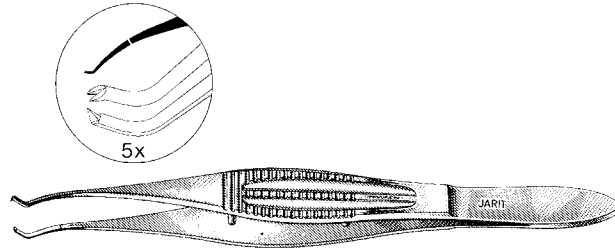

Castroviejo Corneo-Scleral Suture Forceps

3 7/8" (100mm), 6mm tying platform

Catalog #	Description
355-150	0.5mm teeth
355-151	0.9mm teeth
355-152	1.5mm teeth

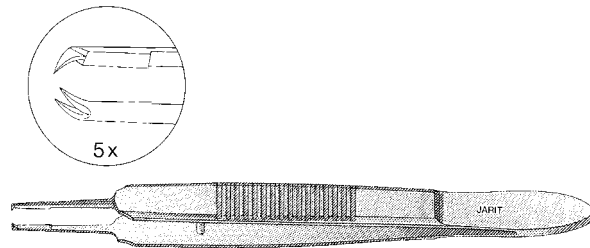

Girard Corneo-Scleral Forceps (Colibri-Type)

4 1/8" (104mm)

Catalog #	Description
355-155	For left hand, round knurled handle, 0.12mm teeth, 6mm tying platform

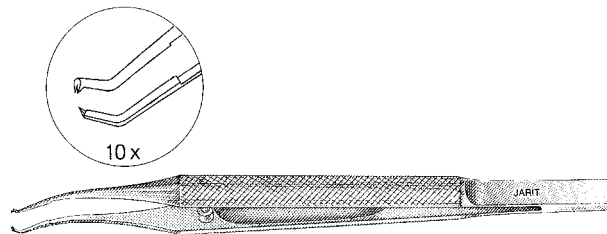

Girard Corneo-Scleral Forceps (Colibri-Type)

4 1/8" (104mm)

Catalog #	Description
355-156	For right hand, round knurled handle, 0.12mm teeth, 6mm tying platform

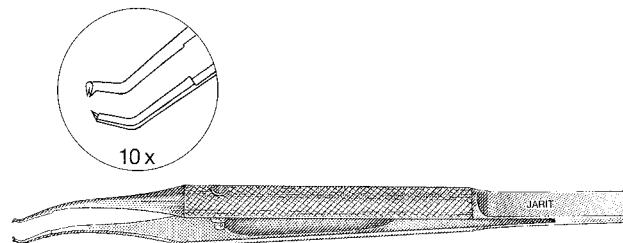

Castroviejo Suture Tying Forceps

4 1/4" (108mm), wide handle, 6mm tying platform

Catalog #	Description
355-159	0.12mm teeth
355-160	0.3mm teeth
355-161	0.5mm teeth
355-162	0.9mm teeth
355-163	1.5mm teeth

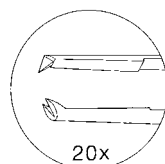

Pierse Colibri Forceps

3" (76mm)

Catalog #	Description
355-165	0.1mm Pierse type tip
355-166	0.2mm Pierse type tip

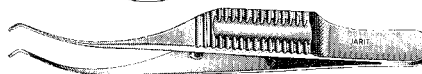
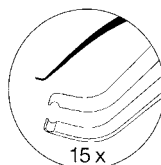

Castroviejo Fixation Forceps

4 1/4" (108mm), wide handle without tying platform

Catalog #	Description
355-168	0.3mm teeth
355-169	0.5mm teeth

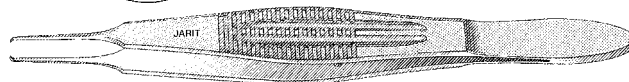
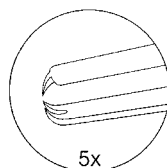

Jewelers Style Forceps

style #1: fine

Catalog #	Description
355-170	4 ³ / ₄ " (120mm)

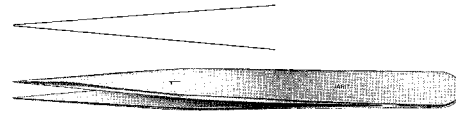

Jewelers Style Forceps

style #3: very fine

Catalog #	Description
355-171	4 ³ / ₄ " (120mm)

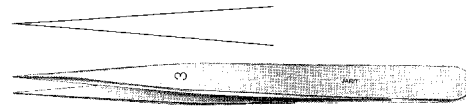

Jewelers Style Forceps

style #3C: very fine

Catalog #	Description
355-172	4 ³ / ₈ " (110mm)

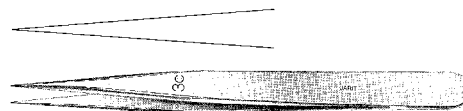

Jewelers Style Forceps

style #4: very fine

Catalog #	Description
355-173	Style 4: very fine, 4 ³ / ₈ " (110mm)

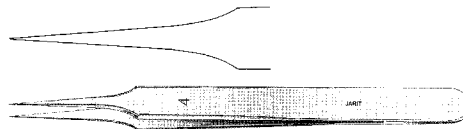

Jewelers Style Forceps

style #5: very fine

Catalog #	Description
355-174	Style 5: very fine, 4 ³ / ₈ " (110mm)

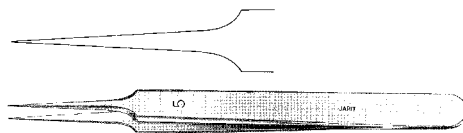

Jewelers Style Forceps

style #7: very fine

Catalog #	Description
355-175	4 ¹ / ₂ " (115mm)

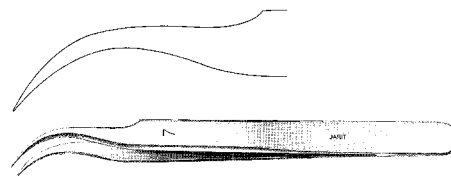

Titanium

Jewelers Style Forceps, Titanium

style #1: fine

Catalog #	Description
355-170TI	4 3/4" (120mm)

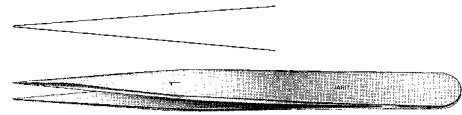

Jewelers Style Forceps, Titanium

style #3: very fine

Catalog #	Description
355-171TI	4 3/4" (120mm)

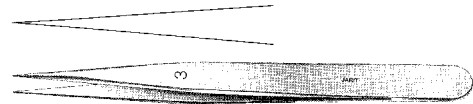

Jewelers Style Forceps, Titanium

style #7: very fine

Catalog #	Description
355-175TI	4 5/8" (118mm)

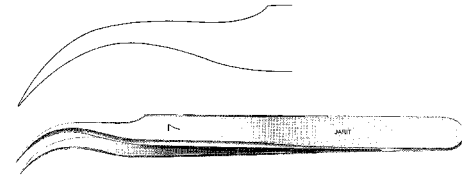

Nugent Utility Forceps

4 1/4" (108mm), 45° angled jaws (9.5mm)

Catalog #	Description
355-177	Smooth
355-178	Serrated

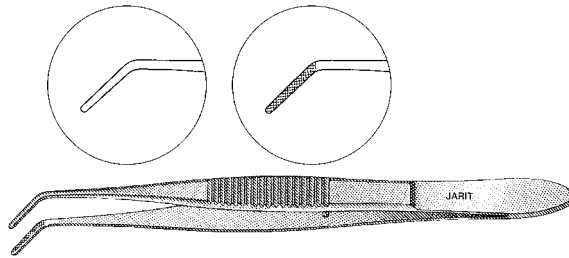

Wills Hospital Utility Forceps

4" (101mm)

Catalog #	Description
355-179	Cross-serrated (tips 14mm)

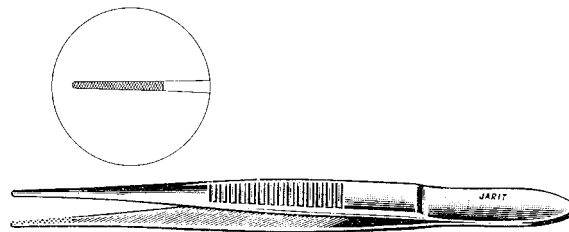

McCullough Utility Forceps

4" (101mm)

Catalog #	Description
355-180	Cross-serrated (tips 14mm)

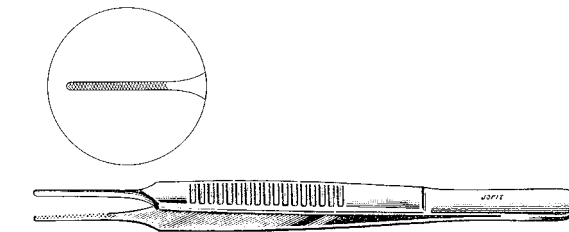

McCullough Utility Forceps

4" (101mm)

Catalog #	Description
355-181	1 x 2 teeth, cross-serrated (tips 14mm)

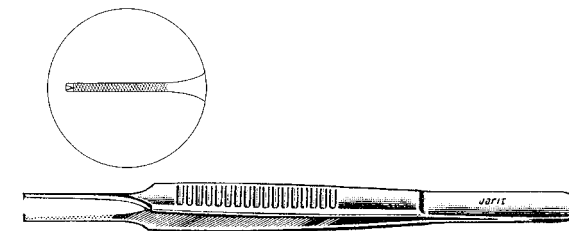

Harms Suture Tying Forceps

4 1/4" (108mm), wide handle, 6.5mm tying platform

Catalog #	Description
355-182	Straight
355-184	Curved

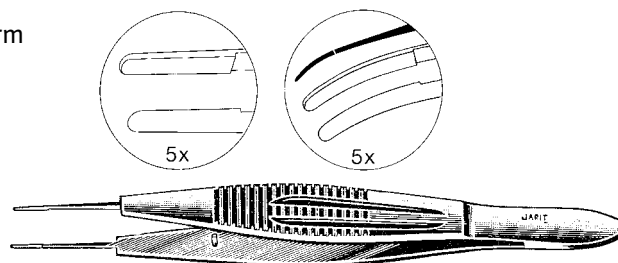

Harms Suture Tying Forceps

3 7/8" (100mm), regular handle, 6.2mm tying platform

Catalog #	Description
355-183	Straight
355-185	Curved

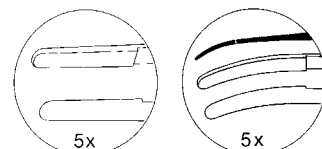

Castroviejo Suture Tying Forceps

4 1/8" (106mm)

Catalog #	Description
355-187	5mm tying platform

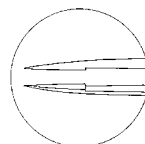

Troutman-Barraquer Corneal Utility Forceps (Colibri-Type)

3" (76mm)

Catalog #	Description
355-188	0.12mm teeth

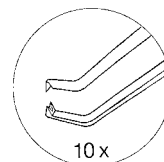

Polack Double Corneal Forceps (Colibri-Type)

2 7/8" (72mm)

Catalog #	Description
355-189	4mm long tips with 1 x 2 teeth

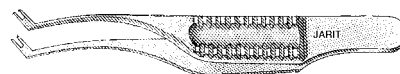
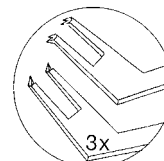

Bonaccolto Utility Forceps

4 3/8" (110mm), cross serrated

Catalog #	Description
355-191	1.25mm wide platform
355-192	1.75mm wide platform

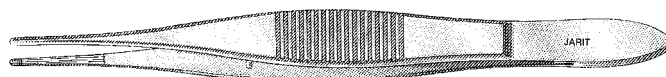
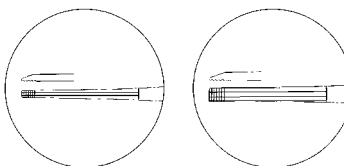

Chandler Iris Forceps

3" (75mm)

Catalog #	Description
355-193	0.5mm wide tips

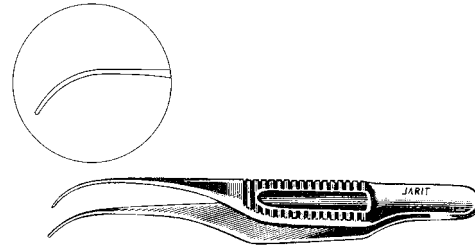

Schaaf Foreign Body Forceps

Catalog #	Description
355-200	3¾" (95mm)

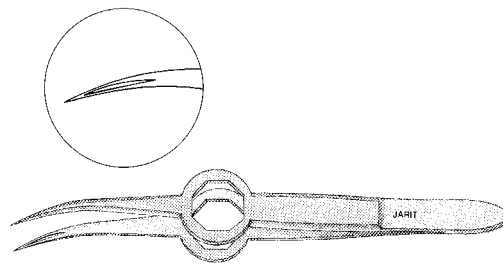

Watzke Sleeve Spreading Forceps

4⅝" (117mm)

Catalog #	Description
355-202	cross-action, 0.65mm x 9.5mm serrated angled tip

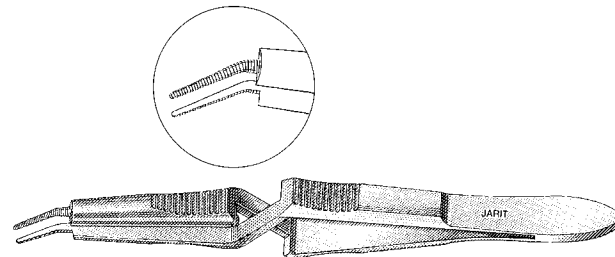

Sauer Suture Forceps

3⅜" (87mm)

Catalog #	Description
355-203	0.6mm 1 x 2 teeth

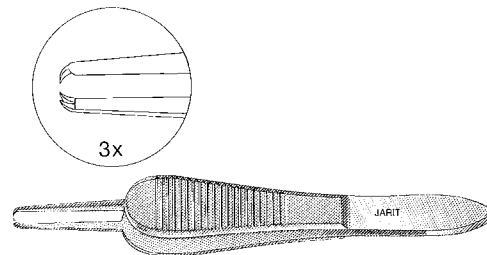

McPherson Suture Tying Forceps

3½" (89mm)

Catalog #	Description
355-205	Straight, 5.1mm tying platform

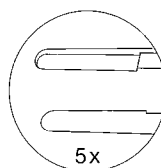

McPherson Suture Tying Forceps

3½" (89mm)

Catalog #	Description
355-206	Angled, 5.1mm tying platform

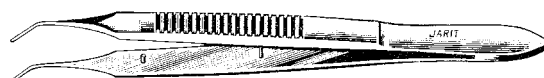
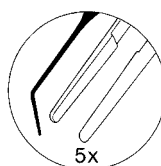

McPherson Micro Corneal Forceps

3½" (89mm)

Catalog #	Description
355-210	Straight, 1 x 2 teeth, 5.1mm tying platform

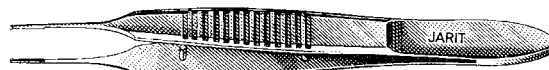
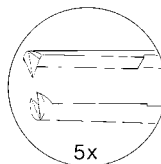

McPherson Micro Corneal Forceps

3½" (89mm)

Catalog #	Description
355-212	Angled, 0.4mm 1 x 2 teeth, 5.1mm tying platform

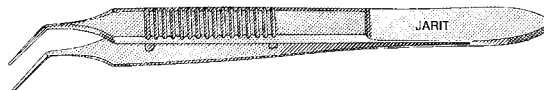
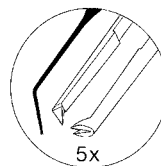

Kelman-McPherson Suture Tying Forceps

3³/₈" (86mm)

Catalog #	Description
355-214	Angled, 0.4mm wide x 7.5mm tying platform

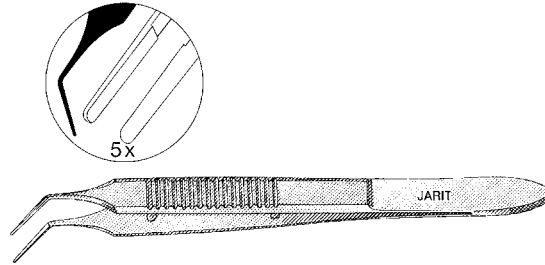

Kelman-McPherson Micro Corneal Forceps

3³/₈" (86mm)

Catalog #	Description
355-215	Angled, 0.4mm x 2 teeth, 7.5mm tying platform

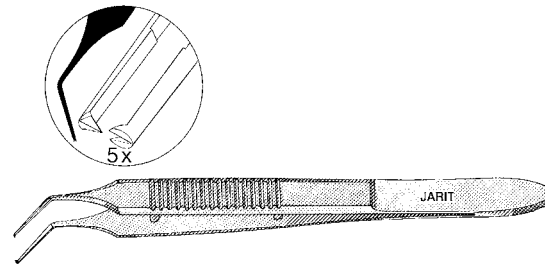

Sheets-McPherson Tying Forceps

3³/₈" (86mm)

Catalog #	Description
355-218	45° angled jaws, 1.5mm cross-serrated tips, 10mm tying platform

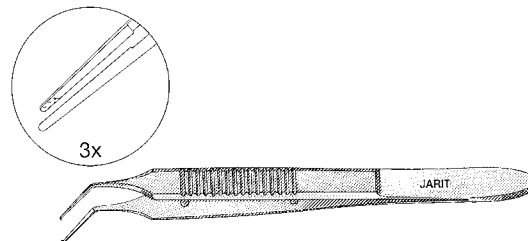

Sinskey Tying Forceps

4³/₈" (110mm)

Catalog #	Description
355-220	Straight, 0.5mm x 7.5mm tying platform

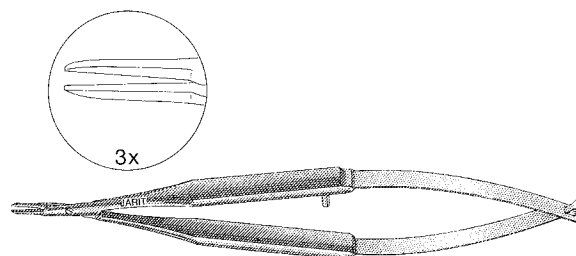

Shepard Tying Forceps

4 3/8" (111mm)

Catalog #	Description
355-225	Straight, wide handle, 0.4mm x 4.5mm tying platform

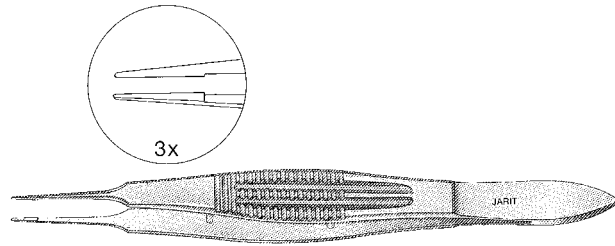

Shepard Tying Forceps

4 1/4" (108mm)

Catalog #	Description
355-226	45° angle, wide handle, 0.4mm wide x 5mm tying platform

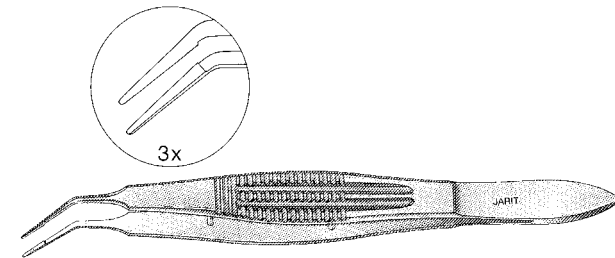

Suture and Tying Forceps

4 1/4" (108mm)

Catalog #	Description
355-230	Wide handle, 0.6mm wide x 7.3mm tying platform

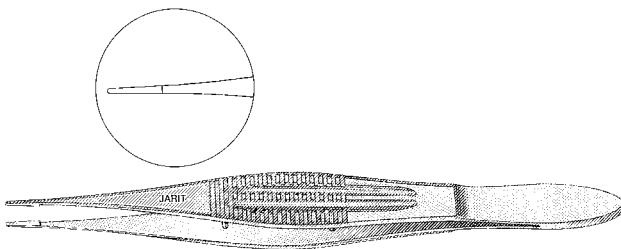

Fine Tying Forceps

4 1/4" (108mm)

Catalog #	Description
355-235	Wide handle, curved tips with tying surface

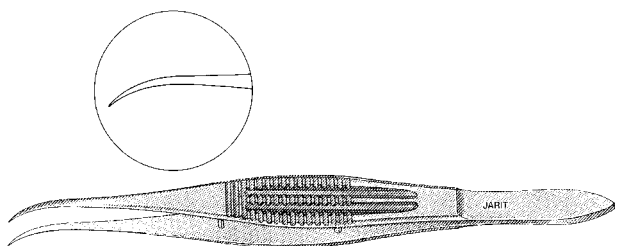

Ziegler Cilia Forceps

3½" (90mm)

Catalog #	Description
355-250	4mm wide x 3mm tapered tips



Littauer Cilia Forceps

3½" (90mm)

Catalog #	Description
355-255	3.5mm wide x 3.2mm tips



Douglas Cilia Forceps

3½" (90mm)

Catalog #	Description
355-260	2.5mm wide tips



Gradle Cilia Forceps

3⅞" (98mm)

Catalog #	Description
355-263	2.3mm wide platform

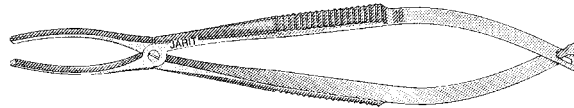

Barraquer Cilia Forceps

3⅞" (98mm)

Catalog #	Description
355-265	8.5mm long platform



Clayman Lens Forceps

4 7/8" (123mm)

Catalog #	Description
355-280	Curved shafts, 2.4mm angled tips

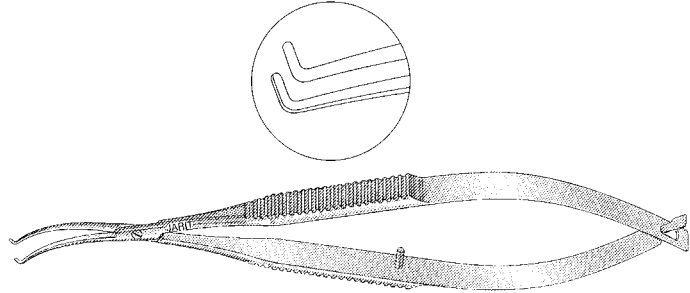

Thornton Intraocular Lens Forceps

3 3/8" (87mm)

Catalog #	Description
355-285	12mm angled jaws 45°

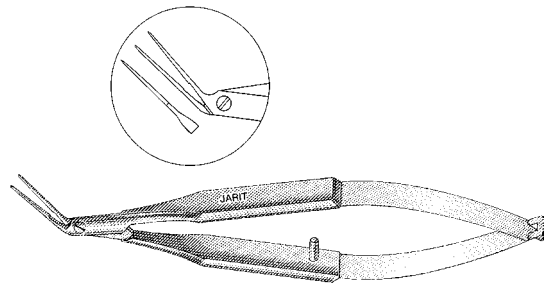

Lambert Chalazion Forceps

3⁵/₈" (92mm)

Catalog #	Description
355-300	8mm inside diameter of fenestrated jaw

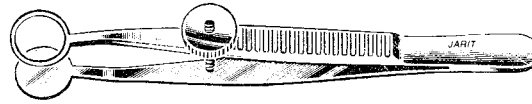

Heath Chalazion Forceps

3⁷/₈" (99mm)

Catalog #	Description
355-303	11mm x 14mm inside diameter of fenestrated jaw

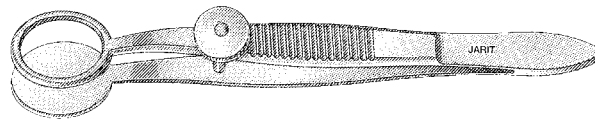

Hunt Chalazion Forceps

3⁷/₈" (99mm)

Catalog #	Description
355-305	12mm inside diameter of fenestrated jaw

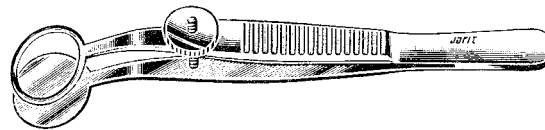

Desmarres Chalazion Forceps

3¹/₂" (89mm)

Catalog #	Description
355-310	12mm x 17mm inside diameter of fenestrated jaw
355-311	12.5mm x 23mm inside diameter of fenestrated jaw
355-312	17mm x 28mm inside diameter of fenestrated jaw

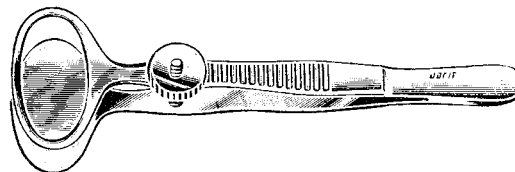

Francis Chalazion Forceps

3 7/8" (99mm)

Catalog #	Description
355-315	12 x 14mm inside diameter of fenestrated jaw

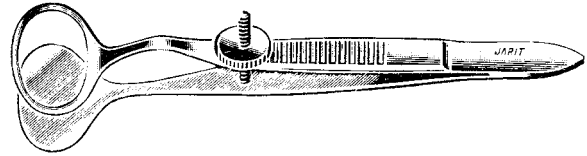

Lordan Chalazion Forceps

3 3/4" (95mm)

Catalog #	Description
355-320	7.5 x 12mm inside dimensions of fenestrated jaw

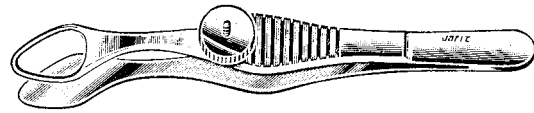

Snellen Entropium Forceps

3 7/8" (97mm), 35mm wide solid plate

Catalog #	Description
355-340	Left
355-341	Right

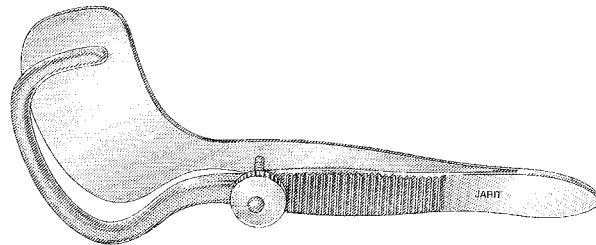

Arruga Capsule Forceps

4" (102mm)

Catalog #	Description
355-350	Capsule size 1.8mm x 3mm

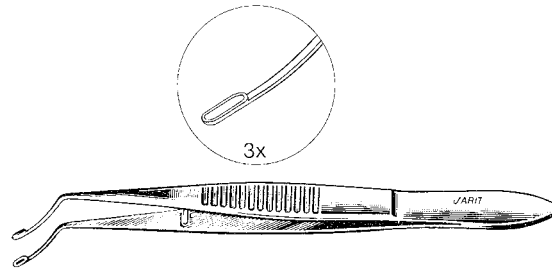

Capsule Fragment and Clot Forceps

2¼" (56mm)

Catalog #	Description
355-360	2mm platform and 1mm microscopic cups on inner jaw surface

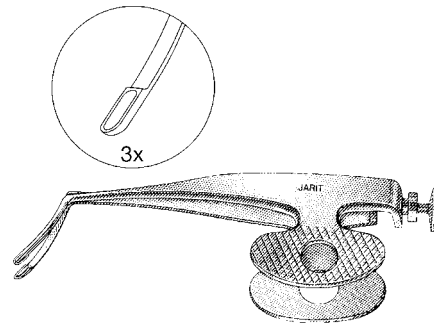

Berke Ptosis Clamp

3⅞" (100mm)

Catalog #	Description
355-370	20mm jaws

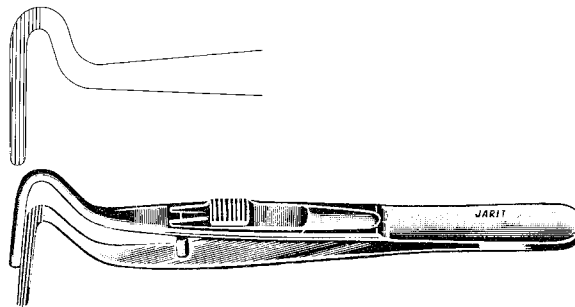

Jameson Muscle Recession Forceps

3⅞" (100mm)

Catalog #	Description
355-375	Left, 12mm jaws
355-376	Left, 7mm jaws
355-377	Right, 12mm jaws
355-378	Right, 7mm jaws

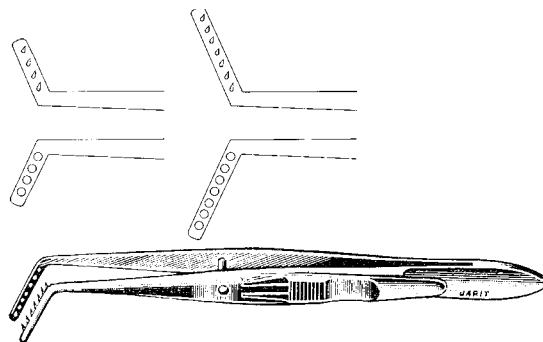

Troutman Superior Rectus Forceps

4⅛" (105mm)

Catalog #	Description
355-380	45° angle, 10mm from tip to bend

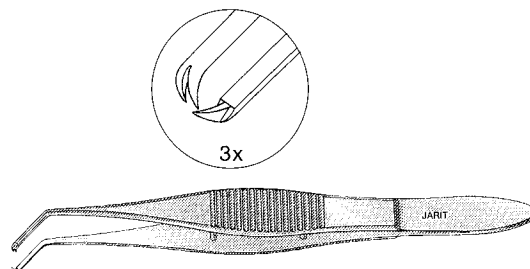

Kalt Needle Holder

5½" (140mm)

Catalog #	Description
355-400	12mm jaws, straight, serrated thumb plate with lock

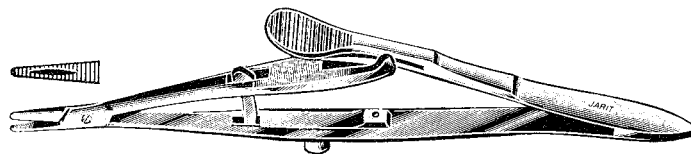

Castroviejo Needle Holders, Flat Serrated Handles

for use with 5.0 and 6.0 sutures
5½" (140mm), 11.5mm smooth jaws,
delicate tips 1.5mm

Catalog #	Description
355-404	Curved, locking
355-404NL	Curved, non-locking
355-405	Straight, locking
355-405NL	Straight, non-locking

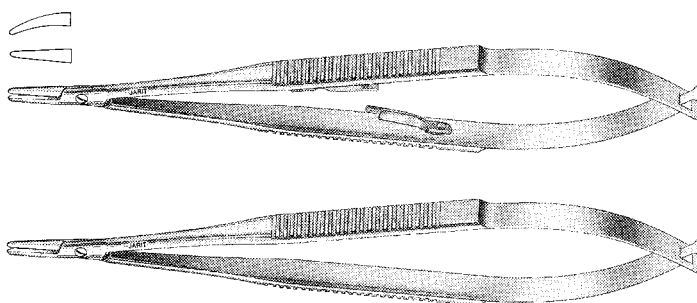

Castroviejo Needle Holders, Flat Serrated Handles

for use with 5.0 and 6.0 sutures
5½" (140mm), 10.5mm smooth jaws,
extra delicate tips 1.2mm

Catalog #	Description
355-406	Straight, locking
355-406NL	Straight, non-locking
355-407	Curved, locking
355-407NL	Curved, non-locking

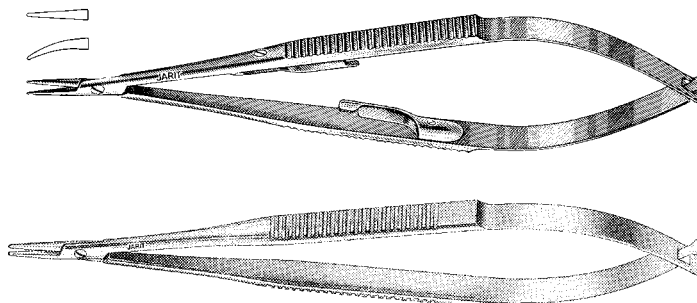

Castroviejo Needle Holders, Wide Serrated Handles

for use with 6.0, 7.0 and 8.0 sutures
5" (127mm), 9mm smooth jaws,
microsurgery tips 0.6mm

Catalog #	Description
355-408	Straight, non-locking
355-409	Curved, non-locking
355-410	Straight, locking
355-411	Curved, locking

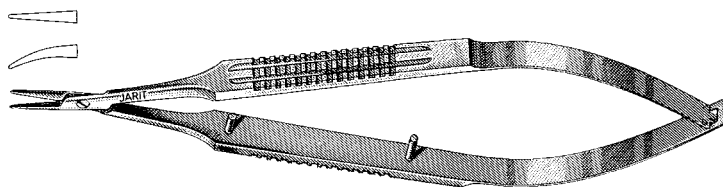

Castroviejo Needle Holders, Carb-Bite

flat serrated handles, for use with 6.0 and 7.0 sutures
5½" (140mm), 11mm straight jaws,
extra delicate tips 1.2mm

Catalog #	Description
355-412	Smooth, locking
355-412NL	Smooth, non-locking
355-413	Serrated, locking
355-413NL	Serrated, non-locking

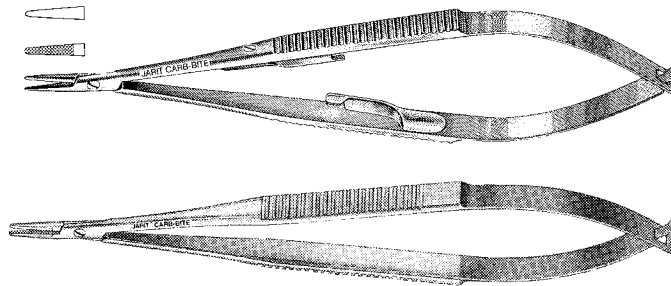

Castroviejo Micro Stardust Needle Holders

4¾" (120mm), round handle, 0.7mm micro tip

Catalog #	Description
278-220	Straight jaws, locking
278-221	Curved jaws, locking
278-222	Straight jaws, non-locking
278-223	Curved jaws, non-locking

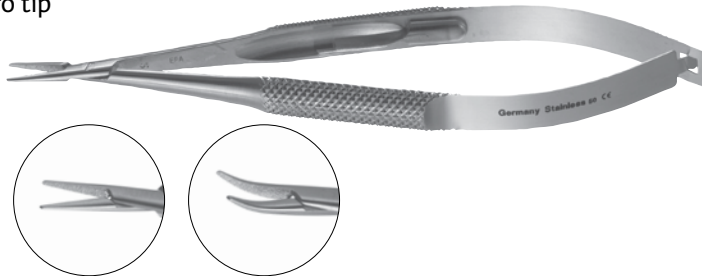

Barraquer Needle Holders

round knurled handles,
5¼" (133mm), 9mm curved jaws,
microsurgery tips .75mm

Catalog #	Description
355-415	Locking
355-416	Non-locking

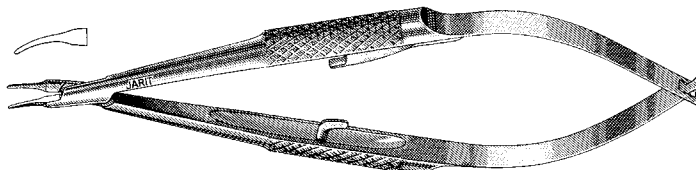

Barraquer Needle Holders

round knurled handles,
4¾" (120mm), 10mm smooth jaws,
microsurgery tips .7mm

Catalog #	Description
355-430	Straight, non-locking
355-432	Straight, locking
355-434	Curved, non-locking
355-436	Curved, locking

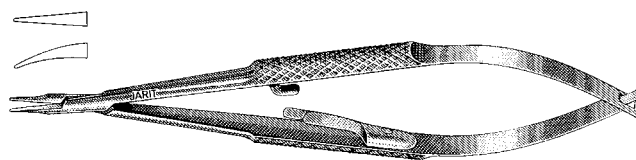

McPherson Needle Holders

flat serrated handles,
4" (102mm), 10mm smooth jaws,
microsurgery tips .75mm

Catalog #	Description
355-450	Straight, non-locking
355-451	Straight, locking
355-452	Curved, non-locking
355-453	Curved, locking

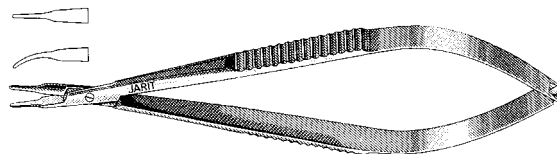

Anis Needle Holders

round knurled handle without lock,
5" (127mm), 8mm smooth jaws,
microsurgery tips .6mm

Catalog #	Description
355-460	Straight
355-464	Curved

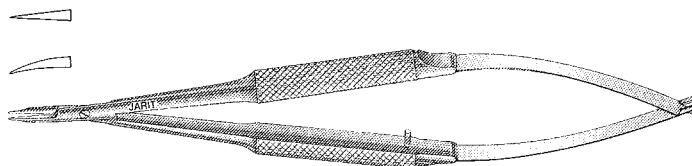

Anis Needle Holders

round knurled handle with lock,
5" (127mm), 8mm smooth jaws,
microsurgery tips .6mm

Catalog #	Description
355-462	Straight
355-466	Curved

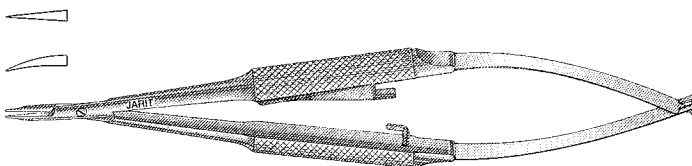

Cohan Miniature Needle Holders

round knurled handles,
4 1/8" (105mm), 7.5mm smooth curved jaws,
microsurgery tips .6mm

Catalog #	Description
355-470	Non-locking
355-472	Locking

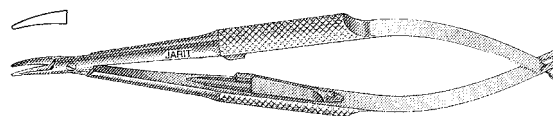

Troutman Needle Holder

round serrated handle,
4 5/8" (117mm), 10mm smooth curved jaws,
delicate tips 1mm

Catalog #	Description
355-475	Non-locking

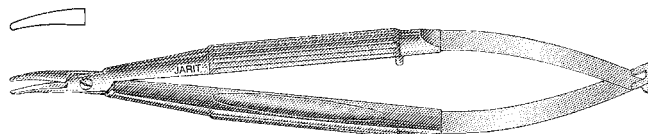

Knapp Iris Scissors, Sharp-Sharp

4" (103mm), 25mm blades

Catalog #	Description
360-090	Straight
360-093	Curved

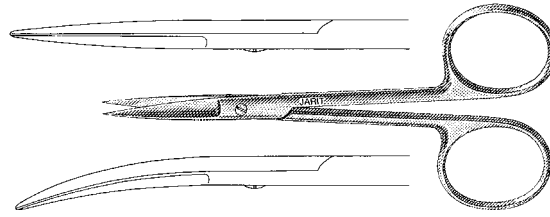

Knapp Iris Scissors, Sharp-Blunt

4" (103mm), 25mm blades

Catalog #	Description
360-091	Straight
360-094	Curved

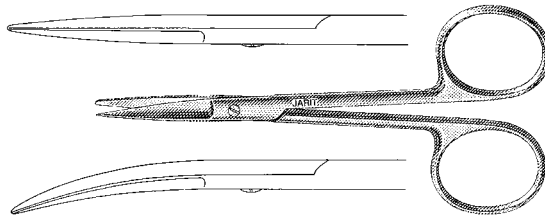

Knapp Iris Scissors, Blunt-Blunt

4" (103mm), 25mm blades

Catalog #	Description
360-092	Straight
360-095	Curved

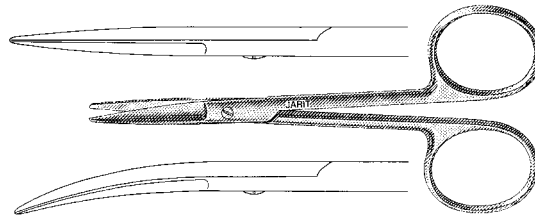

Iris Scissors, Sharp-Sharp, (Mirror Finish)

4 5/8" (116mm), 25mm blades

Manufactured from high grade German surgical stainless steel which is ground and polished to a mirror finish

Catalog #	Description
360-100	Straight
360-101	Curved

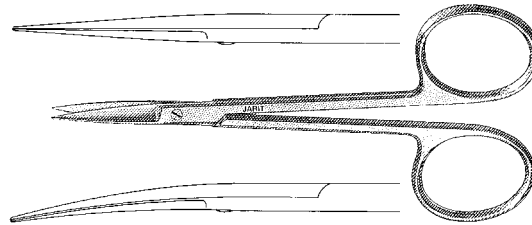

Iris Scissors, Sharp-Sharp, (Matte Finish)

4 5/8" (116mm), 25mm blades

Manufactured from high grade German surgical stainless steel which is glass beaded to a matte finish

Catalog #	Description
359-100	Straight
359-101	Curved

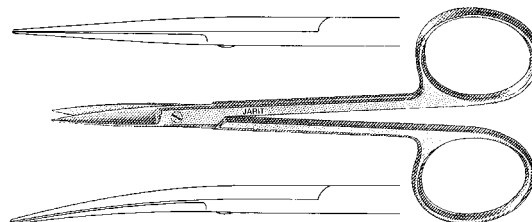

Iris Scissors, Carb-Edge
4½" (114mm), 25mm blades

Catalog #	Description
101-300	Straight
101-301	Curved

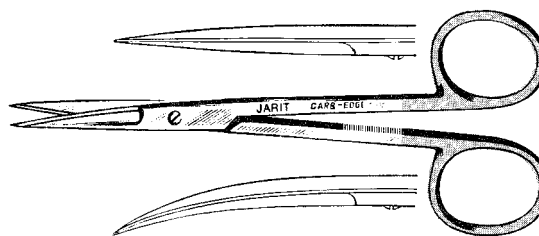

Iris Scissors, Supercut
4⅝" (116mm), 25mm blades

Catalog #	Description
102-130	Straight
102-131	Curved

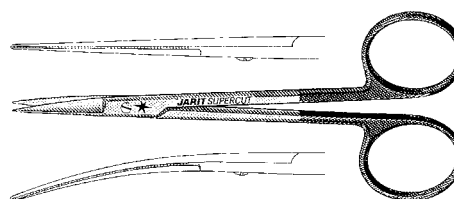

Iris Scissors, Angled on the Side
(Mirror Finish)

Catalog #	Description
360-102	4½" (115mm), 27mm blades

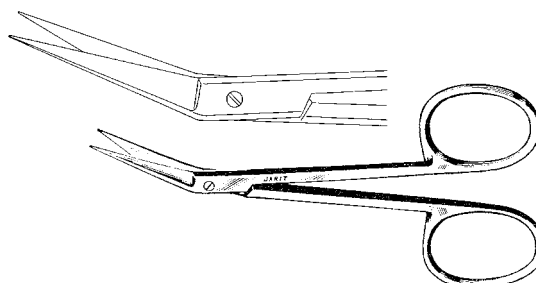

Iris Scissors, Angled on the Side, Probe Point
(Mirror Finish)

Catalog #	Description
360-103	4½" (115mm), 27mm blades

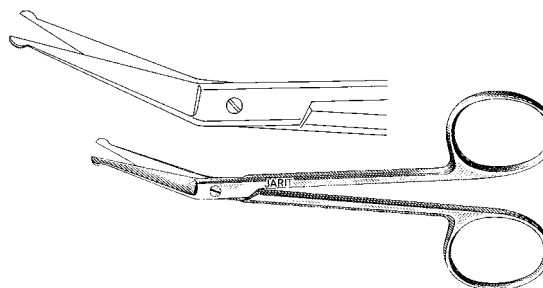

Iris Scissors, Sharp-Sharp
(Mirror Finish)

Catalog #	Description
360-104	3¾" (94mm), straight, 22mm blades
360-105	3¾" (94mm), curved, 22mm blades
360-110	4⅛" (105mm), extra delicate, straight, 22mm blades
360-111	4⅛" (105mm), extra delicate, curved, 22mm blades

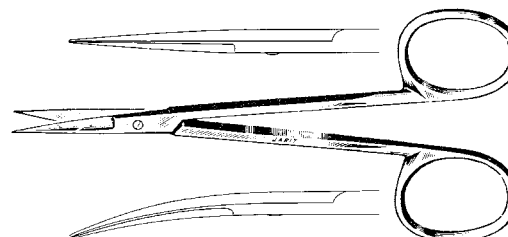

Wilmer Conjunctival Scissors, Angled on the Flat

Catalog #	Description
360-115	4 1/8" (105mm), delicate, 15mm blades

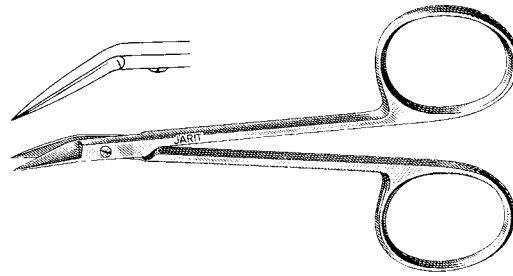

Iris Scissors, Large Finger Rings

3 7/8" (98mm), 22mm blades, (Satin Finish)

Catalog #	Description
360-117	Straight
360-118	Curved

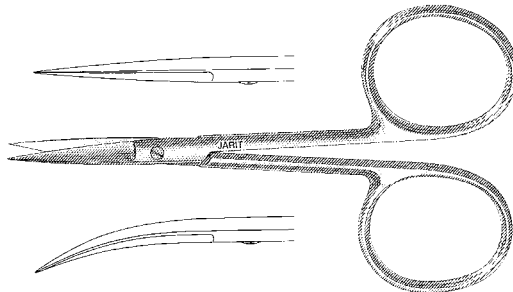

Iris Scissors, Sharp-Sharp

4" (103mm), delicate, 26mm blades, (Mirror Finish)

Catalog #	Description
360-120	Straight
360-121	Curved

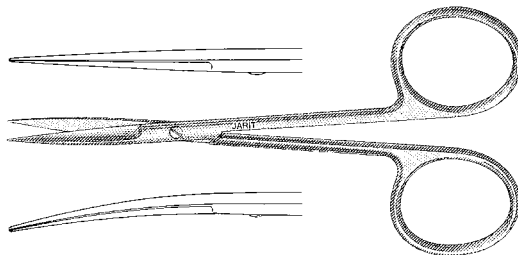

Iris Scissors, Flat Shanks, Sharp-Sharp

4 1/8" (104mm), 22mm blades, (Mirror Finish)

Catalog #	Description
360-122	Straight
360-123	Curved

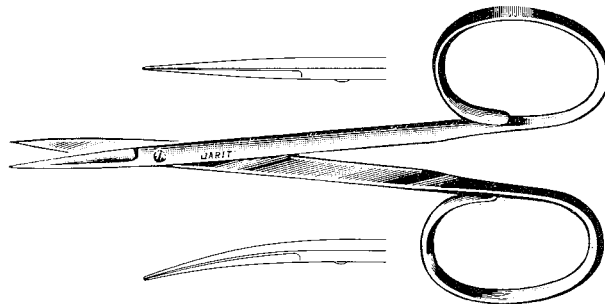

Iris Scissors, Flat Shanks, Sharp-Sharp

3 3/4" (96mm), delicate, 13.5mm blades, (Mirror Finish)

Catalog #	Description
360-125	Straight
360-126	Curved

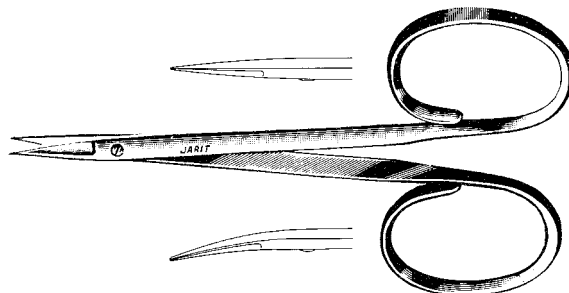

Eye Utility Scissors, Flat Shanks, Blunt-Blunt

3 7/8" (97mm), 16mm blades

Catalog #	Description
360-127	Straight
360-128	Curved

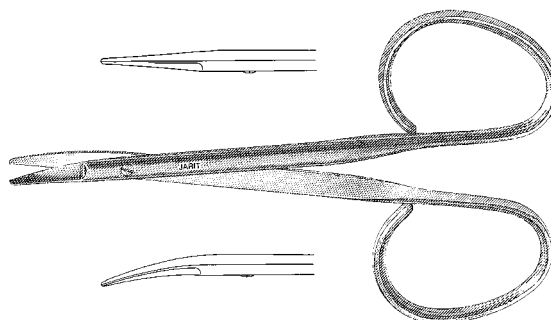

Strabismus Scissors

4 1/2" (115mm), 30mm blades

Catalog #	Description
360-130	Straight
360-131	Curved

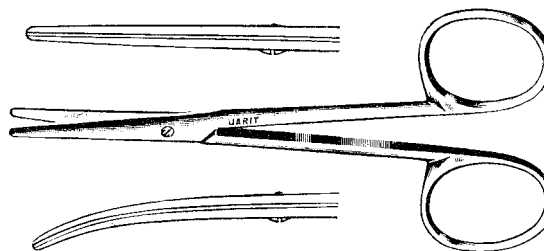

Strabismus Scissors, Carb-Edge

4 1/2" (114mm), 29mm blades

Catalog #	Description
101-310	Straight
101-311	Curved

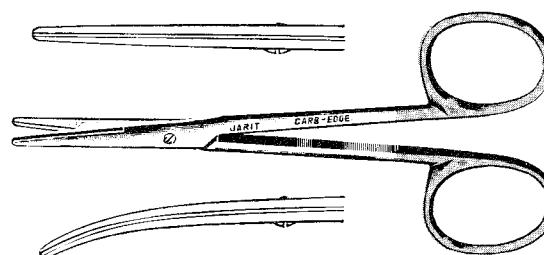

Strabismus Scissors, Flat Shanks

4 1/8" (106mm), 30mm blades

Catalog #	Description
360-134	Straight
360-135	Curved

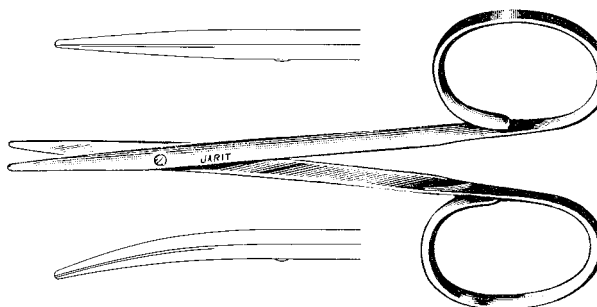

Stevens Tenotomy Scissors, Blunt-Blunt

Catalog #	Description
360-138	4½" (115mm), 13mm blades, straight, slender pattern
360-139	4½" (115mm), 13mm blades, curved, slender pattern
360-140	4½" (109mm), 12mm blades, straight, standard pattern
360-141	4½" (109mm), 12mm blades, curved, standard pattern

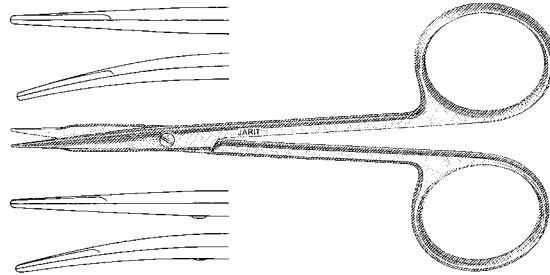

Stevens Tenotomy Scissors, Blunt-Blunt

3⅞" (98mm), flat shanks, 13mm blades

Catalog #	Description
360-142	Straight
360-143	Curved

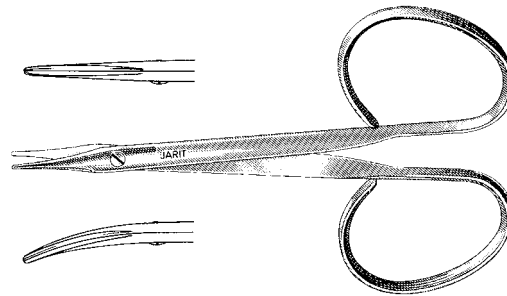

Westcott Utility Scissors

Catalog #	Description
360-144	5½" (130mm), 25mm blades, curved, round sharp tips

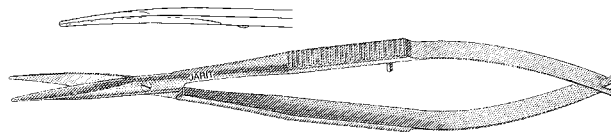

Westcott Tenotomy Scissors

4½" (115mm), 18mm blades, round blunt tips

Catalog #	Description
360-145	Right, curved
360-146	Left, curved
360-147	Straight

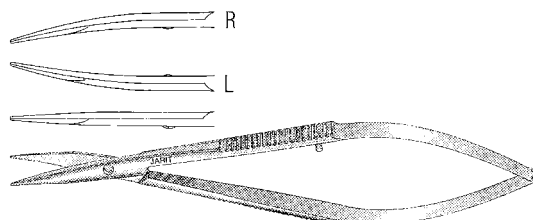

Stevens Stitch Scissors

Catalog #	Description
360-148	4 1/8" (105mm), 14mm blades, curved, sharp tips

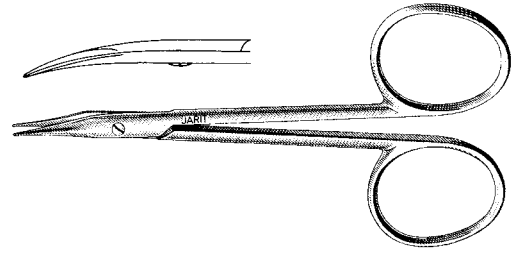

Stevens Stitch Scissors

Catalog #	Description
360-149	3 7/8" (98mm), 12mm blades, curved, sharp tips, flat shanks

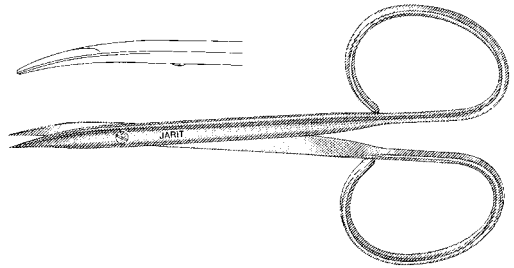

Westcott Stitch Scissors

Catalog #	Description
360-150	4 1/2" (115mm), 18mm blades, curved, fine sharp tips

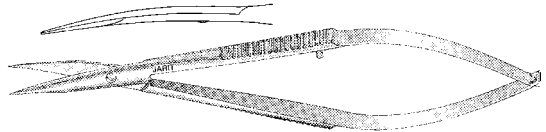

Stevens Removal Scissors

Catalog #	Description
360-151	4 3/8" (111mm), 12mm blades, curved, fine sharp tips, flat shanks

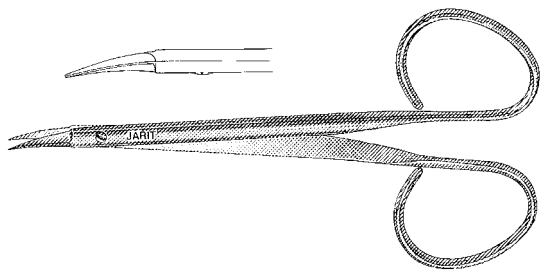

Enucleation Scissors, Strong Curve

Catalog #	Description
360-153	5 1/8" (130mm), 32mm blades

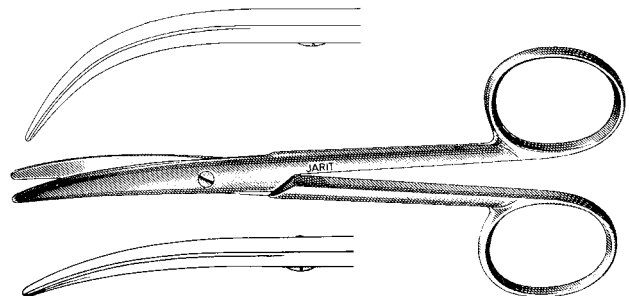

Enucleation Scissors, Light Curve

Catalog #	Description
360-157	5 1/8" (129mm), 27mm blades



Stitch Scissors, Semi-Sharp Tips

3 7/8" (100mm), 16.5mm blades

Catalog #	Description
360-154	Straight
360-155	Curved

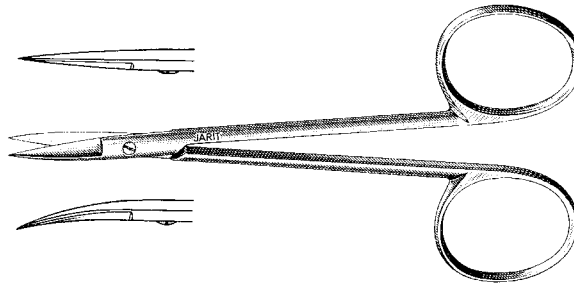

Gradle Stitch Scissors, Blunt Tips

Catalog #	Description
360-156	3 3/4" (95mm), 13mm blades

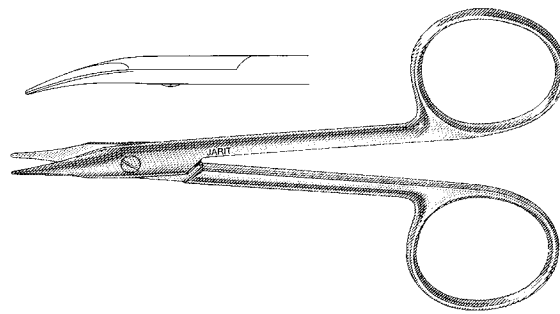

O'Brien Suture Scissors

Catalog #	Description
125-195	3 7/8" (100mm), 15mm blades, angled

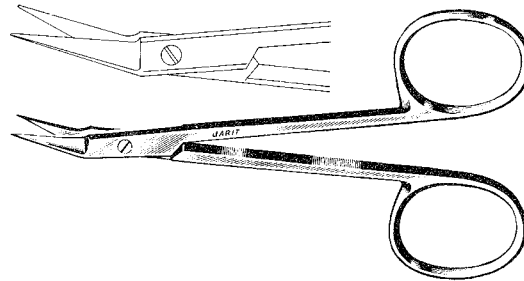

Micro Stitch Scissors

4" (102mm), 7mm blades, fine sharp tips

Catalog #	Description
360-158	Straight
360-159	Curved

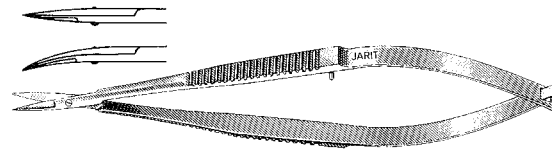

Micro Stitch Scissors

4 1/2" (114mm), 16mm blades, sharp tips

Catalog #	Description
360-160	Straight
360-161	Curved

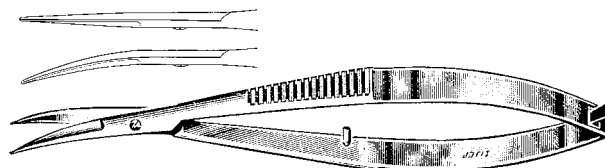

McClure Iris Scissors

4½" (114mm)

Catalog #	Description
360-165	15mm blades, angled on flat

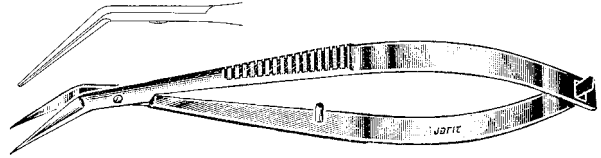

Castroviejo Corneal Scissors

4¾" (110mm)

Catalog #	Description
360-170	12mm blades, curved, blunt tips

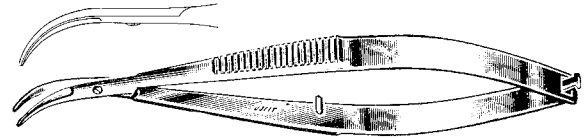

Castroviejo Iris Scissors

3¾" (95mm)

Catalog #	Description
360-172	11mm blades, curved, sharp tips

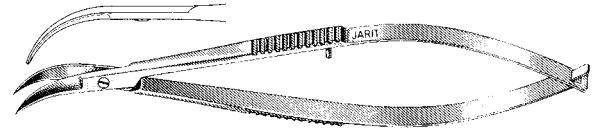

Castroviejo Corneal Scissors

4¼" (108mm)

Catalog #	Description
360-175	12mm blades, angled, blunt tips

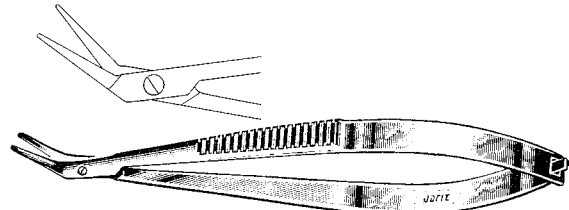

Castroviejo Corneal Section Scissors

4¼" (107mm), curved, blunt tips

Catalog #	Description
360-180	Right, standard, 13mm blades
360-181	Left, standard, 13mm blades
360-190	Right, miniature, 10mm blades
360-191	Left, miniature, 10mm blades

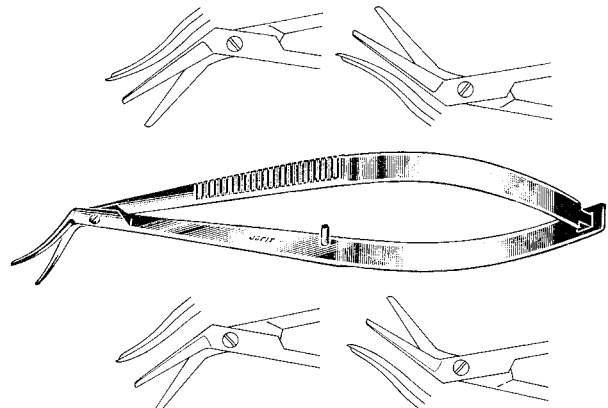

Castroviejo Corneal Section Scissors

37/8" (100mm), microsurgery 7mm blades, curved, blunt tips

Catalog #	Description
360-192	Right
360-193	Left

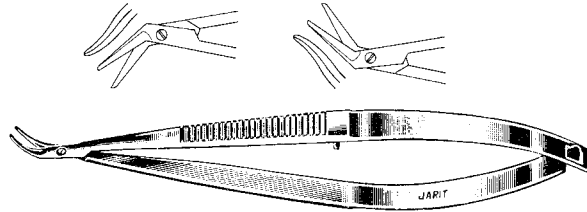

Castroviejo Corneal Section Scissors

41/8" (105mm), miniature 7mm blades, curved, blunt tips

Catalog #	Description
360-195	Left
360-196	Right

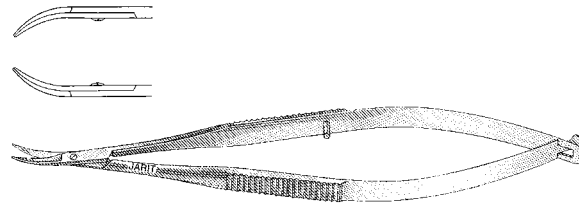

Troutman-Castroviejo Corneal Section Scissors

41/4" (108mm), miniature 10mm blades, curved, blunt tips

Catalog #	Description
360-198	Left
360-199	Right

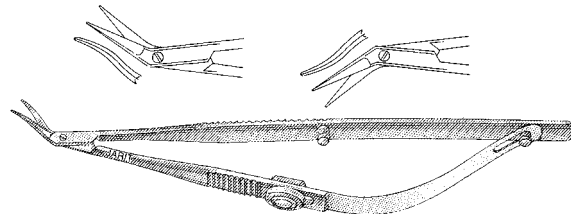

Vannas Capsulotomy Scissors

31/4" (82mm), sharp tips

Catalog #	Description
360-200	Straight, 5.5mm blades
360-201	Curved, 5.5mm blades
360-202	Angled to side, 6.5mm blades
360-203	Angled on flat, 6.5mm blades

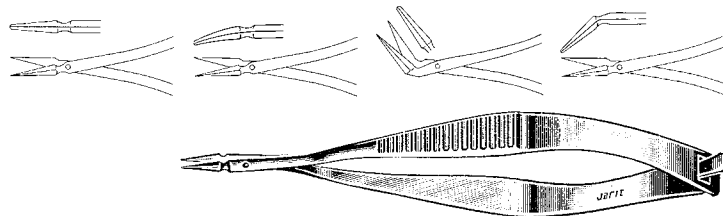

Katzin Corneal Transplant Scissors

4 1/4" (108mm), miniature 10mm blades, curved, blunt tips

Catalog #	Description
360-205	Left
360-206	Right

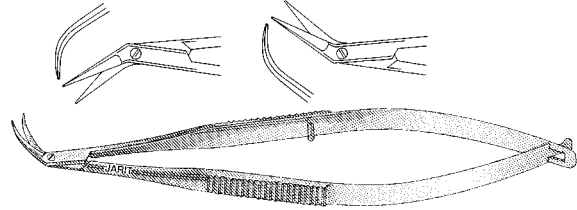

McPherson-Vannas Iris Scissors

3 1/4" (81mm)

Catalog #	Description
360-215	5mm blades, curved, sharp tips

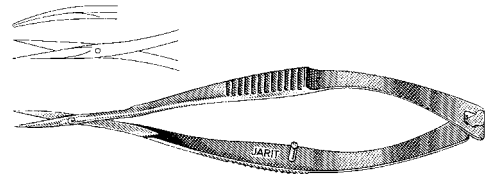

Gills-Welsh Vannas Scissors

angled, sharp tips

Catalog #	Description
360-220	3 1/4" (84mm), microsurgery 6.5mm blades
360-225	3 3/8" (87mm), microsurgery 10mm blades

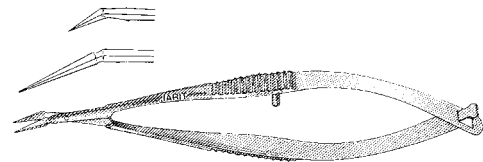

Barraquer-Dewecker Iris Scissors

2 1/8" (55mm)

Catalog #	Description
360-234	8.2mm blades, angled on flat, 0.5mm wide blunt tips

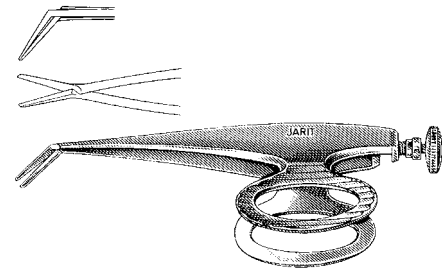

Castroviejo Caliper

3 1/4" (82mm)

Catalog #	Description
360-250	Straight, measures from 0mm to 20mm in 1mm increments

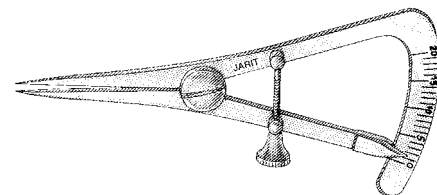

Castroviejo Marking Caliper

3³/₈" (86mm)

Catalog #	Description
360-251	Curved, measures from 0mm to 20mm in 1mm increments with grooves for marking fluid

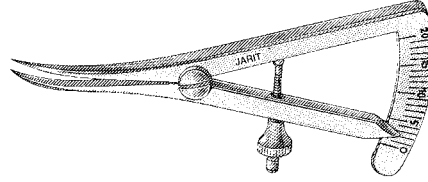

Thorpe Caliper

4³/₈" (110mm)

Catalog #	Description
360-253	Measures from 0mm to 80mm in 1mm increments and 0 to 3 inches in 1/16" increments

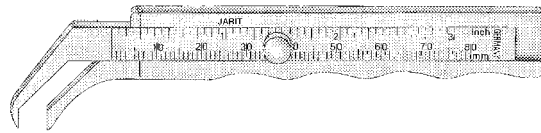

Jameson Caliper

3³/₈" (87mm)

Catalog #	Description
360-255	Measures from 0mm to 80mm in 1mm increments and 0 to 3 inches in 1/16" increments

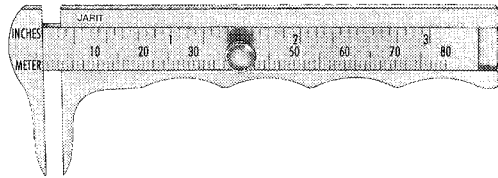

360-SSC-255 Replacement Set Screw Pkg/2ea

Steel Ruler

Catalog #	Description
360-260	Graduated, 6" and 150mm



Steel Ruler

Catalog #	Description
360-262	Graduated, 12" and 300mm



Bowman Lacrimal Probes

5 1/8" (130mm), double-ended stainless steel

Catalog #	Description
360-270	Set of 6
360-271	Sizes 0000-000
360-272	Sizes 00-0
360-273	Sizes 1-2
360-274	Sizes 3-4
360-275	Sizes 5-6
360-276	Sizes 7-8



Bowman Lacrimal Probes

5 1/8" (130mm), double-ended silver

Catalog #	Description
360-280	Sizes 0000-000
360-281	Sizes 00-0
360-282	Sizes 1-2
360-283	Sizes 3-4
360-284	Sizes 5-6
360-285	Sizes 7-8



Williams Lacrimal Probes

5 1/8" (130mm), double-ended silver

Catalog #	Description
360-286	Sizes 0000-000
360-287	Sizes 00-0
360-288	Sizes 1-2
360-289	Sizes 3-4
360-290	Sizes 5-6
360-291	Sizes 7-8



Wilder Lacrimal Dilators

3 7/8" (100mm)

Catalog #	Description
360-300	Short taper (14mm)
360-301	Medium taper (18mm)
360-302	Long taper (22mm)

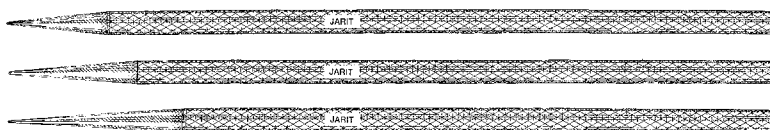

Castroviejo Lacrimal Dilator

5½" (140mm)

Catalog #	Description
360-305	dDouble-ended (23mm tips)



Ruedemann Lacrimal Dilator

2¾" (70mm)

Catalog #	Description
360-307	Short taper (22mm)



Worst "Pigtail" Probe

5⅞" (149mm)

Catalog #	Description
360-310	10mm curved blunt tips with eye



Harms Trabeculotome

1⅞" (48mm), 10mm long points with 3mm spread

Catalog #	Description
360-315	Right
360-316	Left

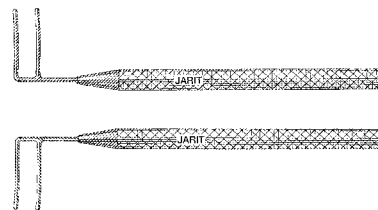

Lachrymal Cannulas

reinforced, 23 gauge

Catalog #	Description
360-325	2⅛" (53mm), straight
360-326	1⅞" (49mm), curved



Air Injection Cannulas

1 5/8" (40mm)

Catalog #	Description
360-330	30 gauge
360-331	27 gauge

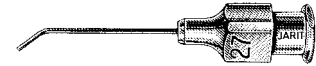

Eye and Plastic Surgery Cases

for eye, plastic surgery, and microsurgical instruments, scissors, knives, and forceps, etc., are held securely on bed of silicone rubber, cover is removable

Catalog #	Description
360-502	10 1/2" x 10" (267mm x 254mm)
360-504	10 1/2" x 15" (267mm x 381mm)

Eye and Plastic Surgery Cases

same as above; but stainless steel mesh is coated with autoclavable plastic for better protection of microsurgical instruments

Catalog #	Description
360-512	10 1/2" x 10" (267mm x 254mm)
360-514	10 1/2" x 15" (267mm x 381mm)



Integra[™]
Ear & Nose
Instruments and
General Surgical
Instruments

Farrior Ear Specula

oval, regular end

Catalog #	Description
375-020	3mm x 4mm
375-022	4mm x 5mm
375-024	4.5mm x 5.5mm
375-026	5mm x 6mm
375-028	5.5mm x 6.5mm
375-030	6mm x 7mm
375-032	6.5mm x 7.5mm
375-034	7mm x 8mm
375-036	7.5mm x 8.5mm

Farrior Ear Specula

oval, oblique end

Catalog #	Description
375-040	3mm x 4mm
375-042	4mm x 5mm
375-044	4.5mm x 5.5mm
375-046	5mm x 6mm
375-048	5.5mm x 6.5mm
375-050	6mm x 7mm
375-052	6.5mm x 7.5mm
375-054	7mm x 8mm
375-056	7.5mm x 8.5mm

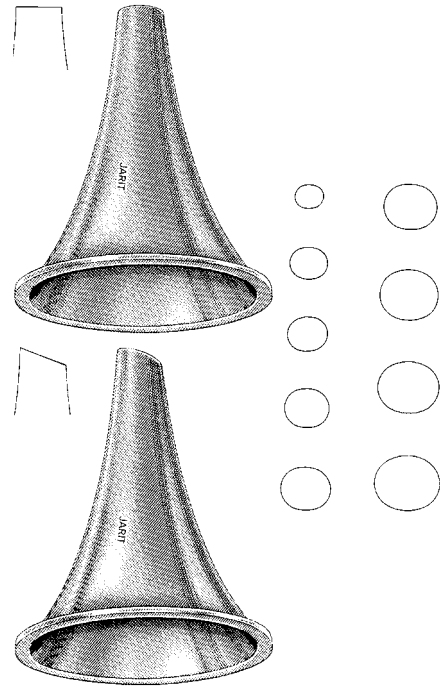

Boucheron Ear Specula

round

Catalog #	Description
375-100	Small set of 4
375-101	3mm
375-102	3.5mm
375-103	4.6mm
375-104	5.1mm

Boucheron Ear Specula

round

Catalog #	Description
375-110	Large set of 4
375-111	5.6mm
375-112	6.6mm
375-113	7.6mm
375-114	9.1mm

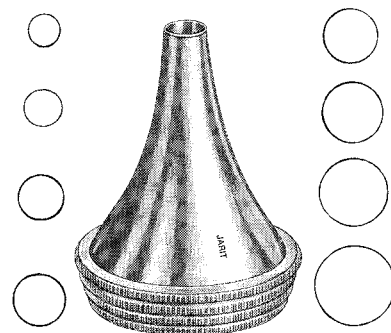

Toynbee Ear Specula

round

Catalog #	Description
375-130	Set of 4
375-131	3mm
375-132	4mm
375-133	5mm
375-134	6.5mm

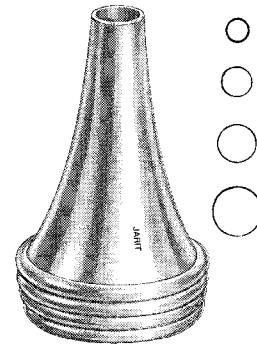

Gruber Ear Specula

oval

Catalog #	Description
375-140	Set of 4
375-141	2.8mm x 3.8mm
375-142	3.8mm x 4.8mm
375-143	5mm x 6.2mm
375-144	6mm x 7.2mm

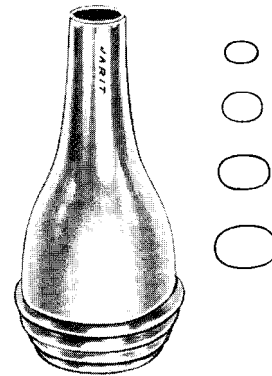

Hartman Ear Specula

round

Catalog #	Description
375-150	Set of 4
375-151	4mm
375-152	5mm
375-153	6mm
375-154	7.5mm

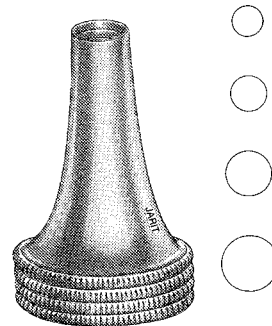

Hartman Ear Specula

oval

Catalog #	Description
375-160	Set of 4
375-161	3.6mm x 4.2mm
375-162	4.6mm x 5.5mm
375-163	5.6mm x 6.7mm
375-164	6.9mm x 8.0mm

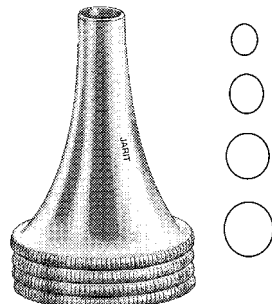

Lucae Ear Dressing Forceps

Catalog #	Description
380-100	5½" (140mm), 1.8mm wide x 16mm length serrations

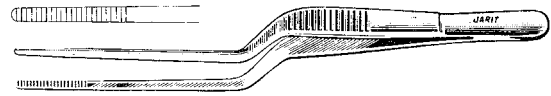

Jansen Ear Dressing Forceps

Catalog #	Description
380-105	6¼" (161mm), 2mm wide x 17mm length serrations

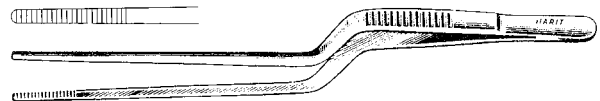

Wilde Ear Dressing Forceps

Catalog #	Description
380-110	4⅝" (117mm), 2mm wide x 14.5mm length serrations

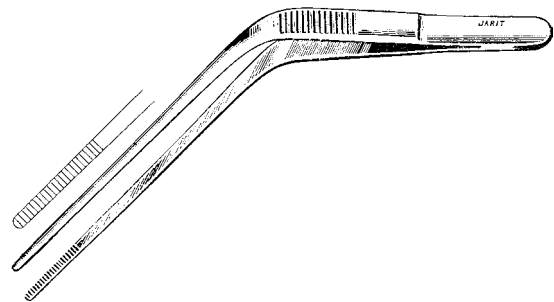

Hartman Ear Dressing Forceps

2" (50mm) working length

Catalog #	Description
380-140	2mm x 6mm tapered jaws
380-141	2mm x 6mm jaws

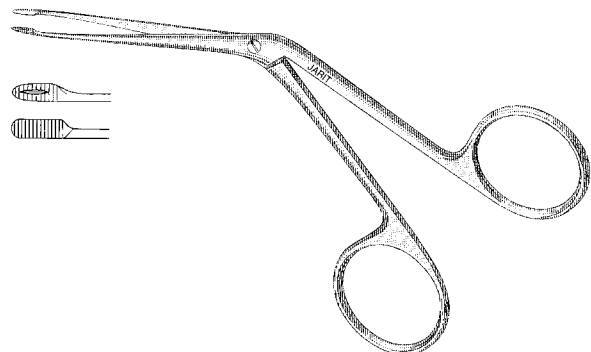

Struempel Alligator Ear Forceps

3³/₈" (87mm) working length, 5³/₄" (145mm) overall length

Catalog #	Description
380-143	oval cups, 2.5mm x 6mm

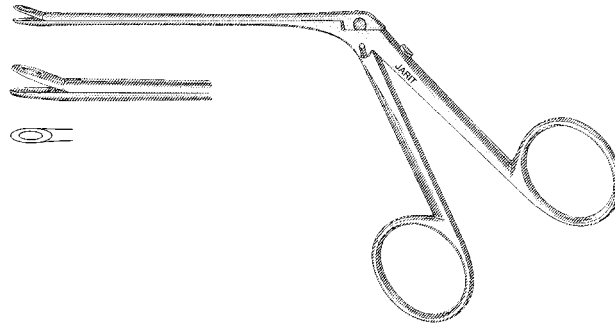

Hartman-Herzfeld Alligator Ear Forceps

3³/₈" (87mm) working length, 5³/₄" (145mm) overall length, round cups

Catalog #	Description
380-145	2mm
380-146	3mm
380-147	2mm, up-angled

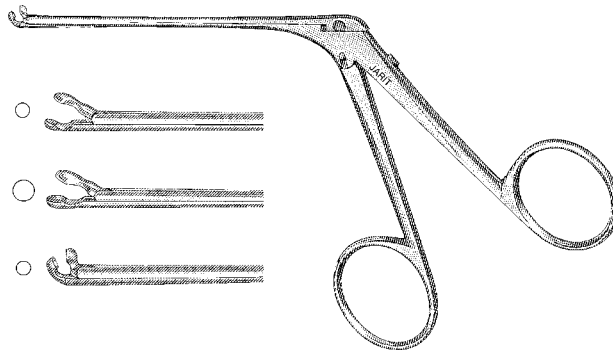

Hartman Alligator Ear Forceps

3³/₈" (87mm) working length, 5³/₄" (145mm) overall length

Catalog #	Description
380-149	1 x 2 teeth, serrated jaws, 1.6mm x 7mm
380-150	Serrated jaws, 1.8mm x 8mm

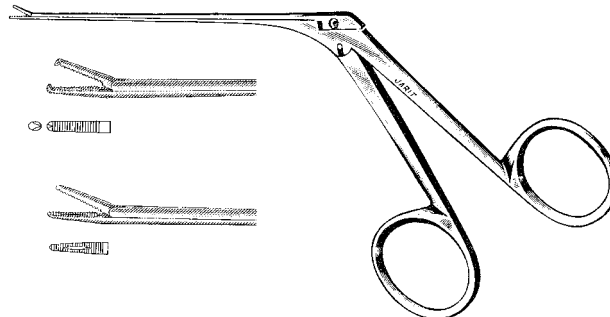

Hartman Alligator Ear Forceps

3 3/8" (87mm) working length, 5 3/4" (145mm) overall length

Catalog #	Description
380-153	Oval cups, 2mm x 7mm

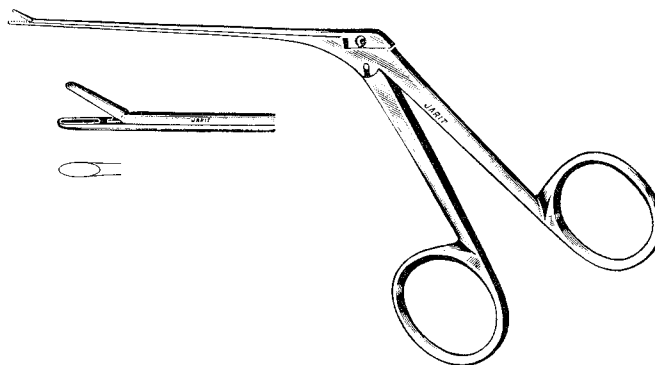

Hartman Alligator Ear Forceps

Catalog #	Description
380-155	5 1/2" (140mm) shaft, serrated jaws, 1.8mm x 8mm
380-156	6 1/4" (159mm) shaft, serrated jaws, 1.8mm x 8mm

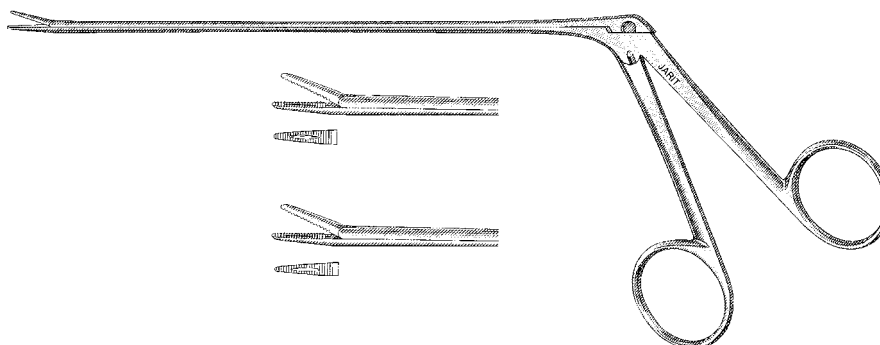

Bellucci Micro Ear Scissor

3 1/8" (78mm) shaft

Catalog #	Description
380-157	3.8mm length blade, ebony finish



Hartmann Tuning Fork

Catalog #	Description
380-165	128C, alloy metal



Hartmann Tuning Fork

Catalog #	Description
380-166	256C, alloy metal

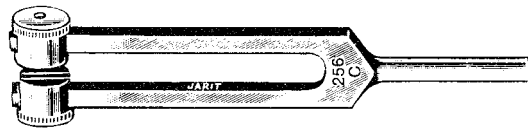

Hartmann Tuning Fork

Catalog #	Description
380-167	512C, alloy metal

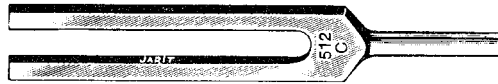

Hartmann Tuning Fork

Catalog #	Description
380-168	1024C, alloy metal

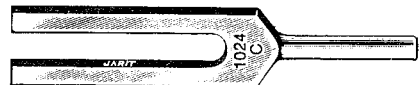

Hartmann Tuning Fork

Catalog #	Description
380-169	2048C, alloy metal



Krause Ear Snare

Catalog #	Description
380-175	7 1/8" (180mm), includes one package of 12 snare wires

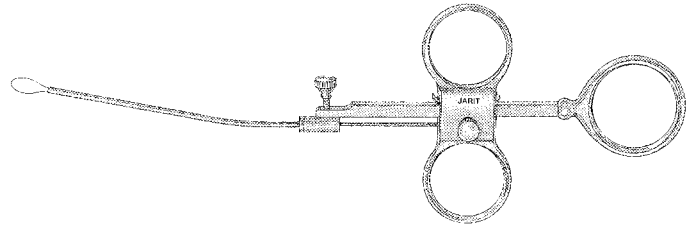

Buck Ear Curettes

5 3/4" (146mm), straight, blunt

Catalog #	Description
380-180	Size 00: 2.0mm OD
380-181	Size 0: 2.5mm OD
380-182	Size 1: 3.0mm OD
380-183	Size 2: 3.5mm OD
380-184	Size 3: 4.0mm OD



Buck Ear Curettes

5 3/4" (146mm), angled, blunt

Catalog #	Description
380-190	Size 00: 2.0mm OD
380-191	Size 0: 2.5mm OD
380-192	Size 1: 3.0mm OD
380-193	Size 2: 3.5mm OD
380-194	Size 3: 4.0mm OD



Buck Ear Curettes

5 3/4" (146mm), straight, sharp

Catalog #	Description
380-200	Size 00: 2.0mm OD
380-201	Size 0: 2.5mm OD
380-202	Size 1: 3.0mm OD
380-203	Size 2: 3.5mm OD
380-204	Size 3: 4.0mm OD



Buck Ear Curettes

5 3/4" (146mm), angled, sharp

Catalog #	Description
380-210	Size 00: 2.0mm OD
380-211	Size 0: 2.5mm OD
380-212	Size 1: 3.0mm OD
380-213	Size 2: 3.5mm OD
380-214	Size 3: 4.0mm OD



Lempert Endaural Curettes

7¾" (200mm)

Catalog #	Description
380-215	Size 5-0: 1.6mm x 2.5mm cup
380-216	Size 4-0: 2mm x 2.9mm cup
380-217	Size 3-0: 2.3mm x 3.6mm cup
380-218	Size 2-0: 2.8mm x 4mm cup
380-219	Size 0: 3.4mm x 5.7mm cup
380-220	Size 1: 3.8mm x 6.5mm cup
380-221	Size 2: 4.3mm x 7mm cup

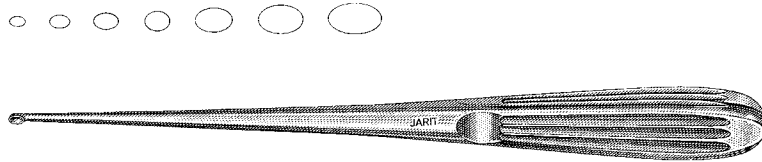

Shapleigh Ear Curettes

6" (155mm), serrated

Catalog #	Description
380-223	Small: 2mm loop
380-224	Large: 3mm loop

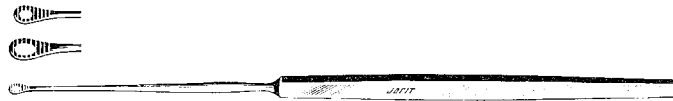

Billeau Ear Loops

6½" (165mm)

Catalog #	Description
380-225	Large: 5mm x 9.2mm loop
380-226	Medium: 3.6mm x 5.6mm loop
380-227	Small: 2.5mm x 4mm loop

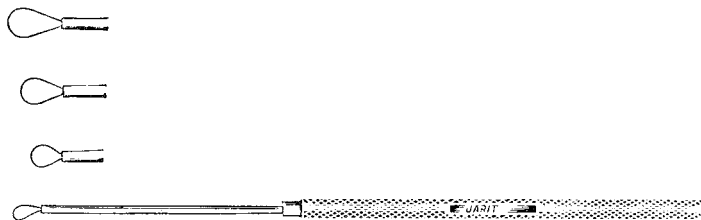

Day Ear Hooks

6¾" (171mm)

Catalog #	Description
380-230	Small: 2mm blunt tip
380-231	Large: 2.5mm blunt tip



Allport Incus Hook

Catalog #	Description
380-232	6¾" (171mm), 90° angle, 3mm blunt tip

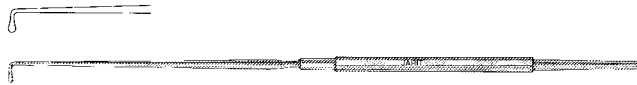

Gross Ear Hook and Spoon

Catalog #	Description
380-233	5⅞" (130mm), 90° angle, 4mm blunt tip, 3.6mm x 9mm spoon



Sexton (Gerzog) Ear Knives

Catalog #	Description
380-235	6½" (163mm), straight shaft, 2.5mm blade
380-236	7¼" (185mm), bayonet shaft, 2.3mm blade
380-237	6" (153mm), angular shaft, 2mm blade

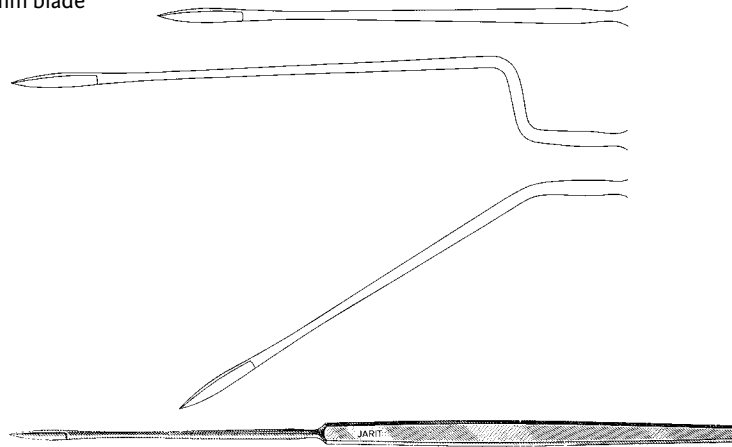

Myringotomy Knives

6½" (165mm)

Catalog #	Description
380-238	Straight, 9mm blade
380-239	Slightly curved, 11mm blade

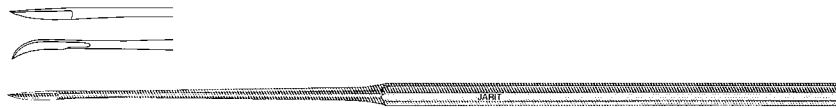

Politzer Ear Knife

Catalog #	Description
380-242	6½" (164mm), angular shaft, 2.6mm x 5.5mm blade

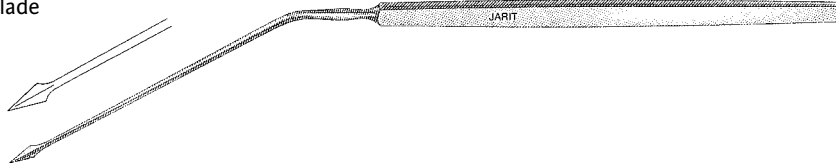

Buck Myringotomy Knife

Catalog #	Description
380-244	6 ⁷ / ₈ " (175mm), 2.7mm x 5.4mm blade



Andrew Mastoid Chisels

5⁷/₈" (150mm)

Catalog #	Description
380-270	5mm
380-271	7mm
380-272	9mm
380-273	11mm



Andrew Mastoid Gouges

5⁷/₈" (150mm)

Catalog #	Description
380-275	6mm
380-276	8mm
380-277	10mm



Kerrison Mastoid Rongeurs

3 1/2" (90mm) working length

Catalog #	Description
380-300	Size 0: 3mm bite
380-301	Size 1: 4mm bite
380-302	Size 2: 5mm bite
380-303	Size 3: 6mm bite

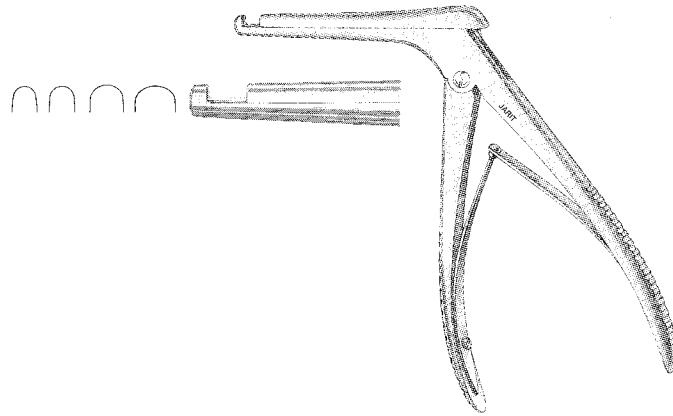

Kerrison-Costen Rongeur

4" (100mm) working length

Catalog #	Description
380-305	4mm bite

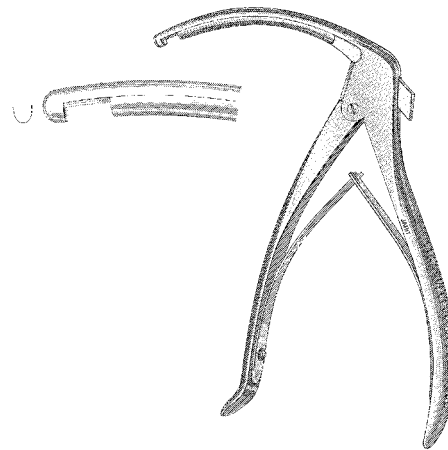

Citelli Rongeur

3 3/8" (86mm) working length

Catalog #	Description
380-307	Size 1: 2mm bite

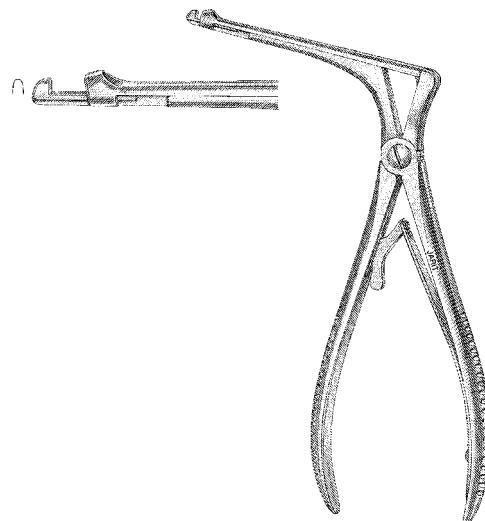

Blumenthal Rongeur

Catalog #	Description
230-097	6" (155mm), 30 deg, 3mm jaw width

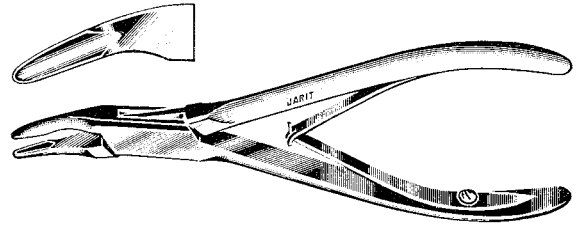

Micro Friedman Rongeur

1.3mm bite

Catalog #	Description
230-093	5½" (140mm), straight

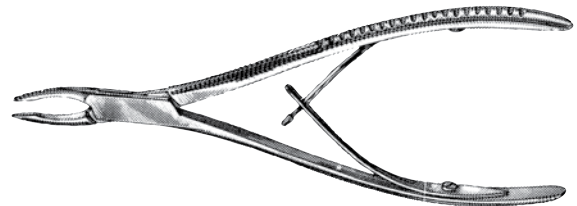

Micro Friedman Rongeurs

2.4mm bite

Catalog #	Description
230-098	4½" (132mm)
230-099	5⅝" (142mm)

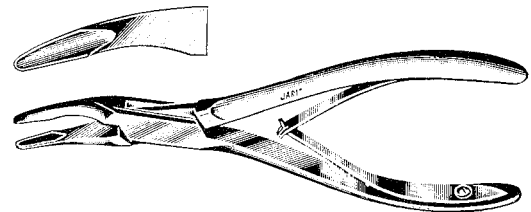

Luer Rongeurs

7¼" (182mm), 8mm bite

Catalog #	Description
230-100	Straight
230-102	Curved

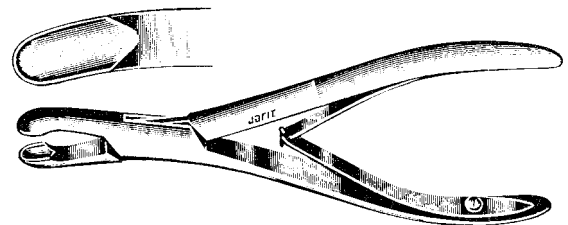

Shearer Chicken Bill Rongeurs

Catalog #	Description
230-105	5⅝" (142mm), 5mm bite
230-106	6¾" (170mm), 4.4mm bite

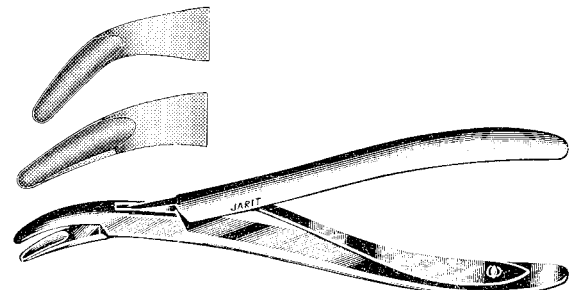

Reiner Rongeurs

7" (178mm)

Catalog #	Description
230-110	3.2mm bite, light curve
230-111	4.2mm bite, light curve
230-112	5.8mm bite, light curve

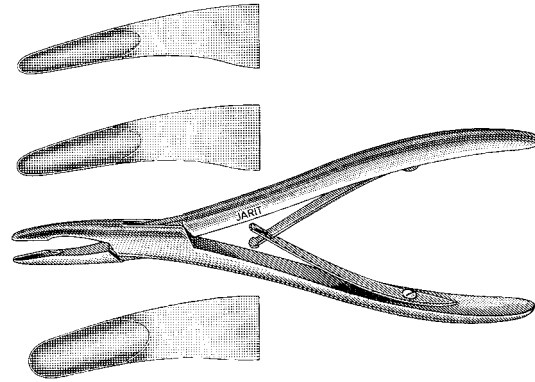

Hartman Rongeurs

5 7/8" (150mm)

Catalog #	Description
230-120	4.5mm bite, Straight, jaw width from 4.5mm to 5.7mm
230-121	4.5mm bite, Half curved, jaw width from 4.5mm to 5.4mm
230-122	4.5mm bite, Full curved, jaw width from 4.5mm to 5.5mm

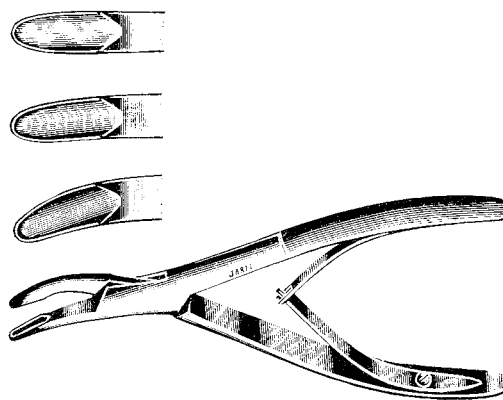

Bane Rongeurs

7" (175mm)

Catalog #	Description
230-124	4mm bite, curved
230-125	5mm bite, curved

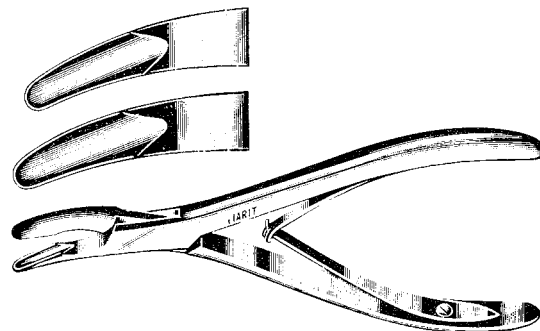

Lempert Rongeurs

2.5mm bite

Catalog #	Description
230-130	6¼" (158mm), straight
230-131	6¼" (158mm), curved
230-135	7½" (188mm), straight
230-136	7½" (188mm), curved

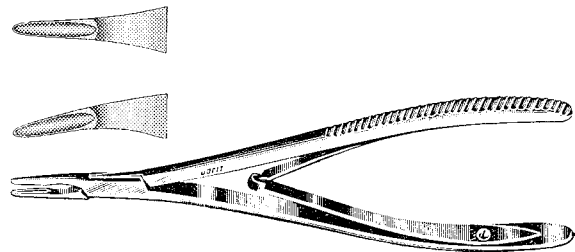

Juers-Lempert Rongeur

Catalog #	Description
230-138	7¼" (185mm), curved handle, 3mm bite

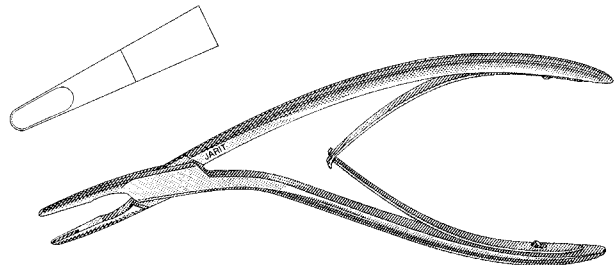

Dean Rongeur

Catalog #	Description
230-142	5¾" (146mm), 5mm bite, strong curve

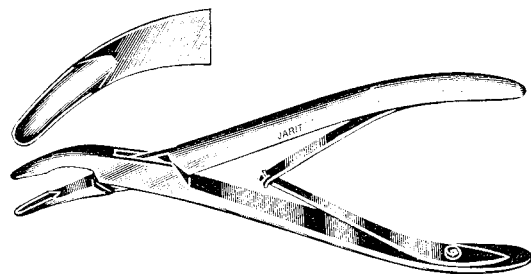

Cicherelli Rongeur

Catalog #	Description
230-145	6½" (165mm), 3.5mm bite, strong curve

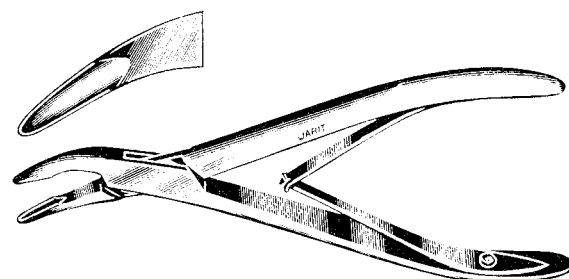

Beyer Rongeur

Catalog #	Description
230-205	7" (178mm), 3mm bite, light curve
230-SPS-205	Replacement Spring and Screw

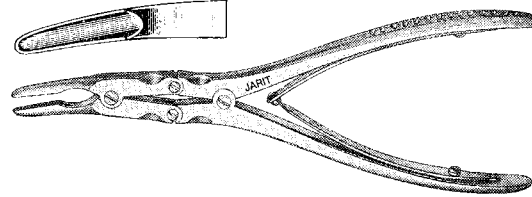

Ruskin Rongeurs

7 1/4" (185mm)

Catalog #	Description
230-210	Straight, 5mm bite
230-211	Curved, 5mm bite
230-214	Straight, 6mm bite
230-215	Curved, 6mm bite
230-SPS-205	Replacement Spring and Screw

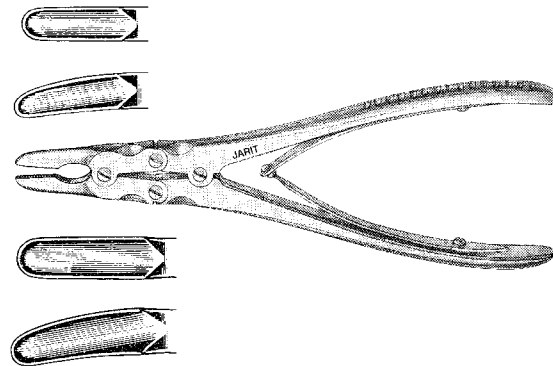

Molt Periosteal Elevator

(Also referred to as Molt #9)

Catalog #	Description
380-315	7¼" (184mm), double-ended, 6.1mm x 7.2mm

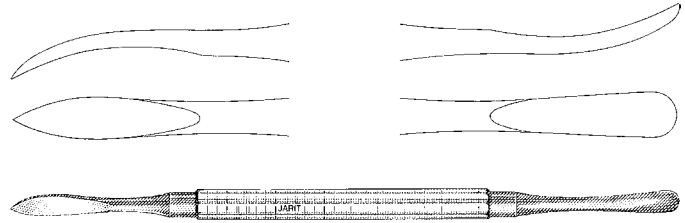

Seldin Periosteal Elevator #23

Catalog #	Description
250-509	7¾" (200mm), double-ended, blades ½" x 2⅛" (13mm x 55mm) and ¾" x 2" (10mm x 51mm)



Lempert Elevators

7" (175mm), slight angle

Catalog #	Description
380-320	2mm wide
380-321	3mm wide

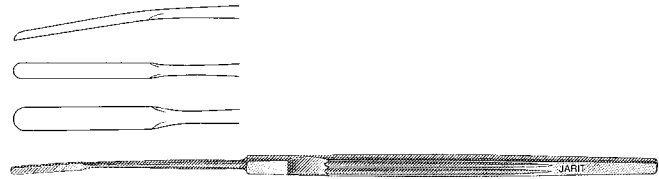

Lempert Elevator

Catalog #	Description
380-323	7¼" (184mm), curved blade, 7mm wide

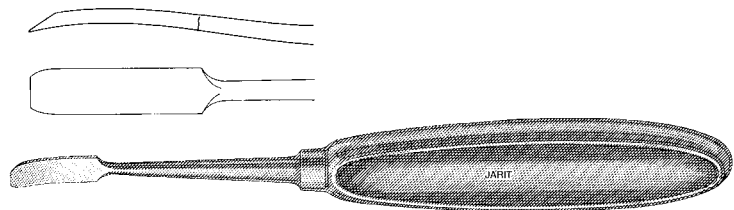

Periosteal Nasal Elevator

Catalog #	Description
380-325	8" (203mm), heavy, curved blade, 7mm wide

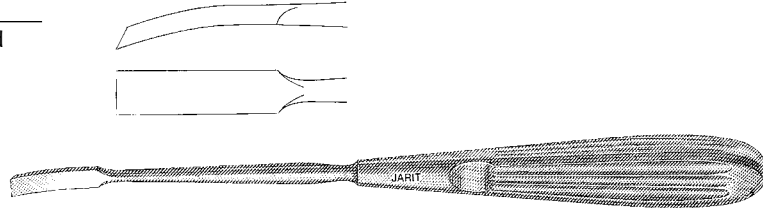

Henner Elevator

Catalog #	Description
380-330	7 1/2" (190mm), double-ended, 2mm wide

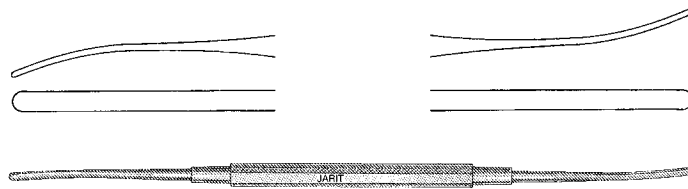

Farrell Applicator

Catalog #	Description
380-335	5½" (140mm), triangular end 18mm

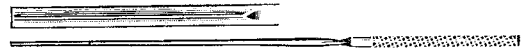

Farrell Applicator

Catalog #	Description
380-336	5½" (140mm), roughened end 18mm



Buck Applicator

Catalog #	Description
380-340	6¼" (159mm), triangular end 18mm

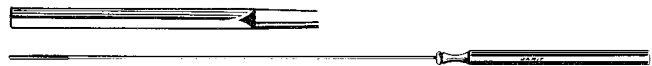

Brown Applicator

Catalog #	Description
380-350	6" (152mm), triangular end, copper 18mm



Uebe Applicator

Catalog #	Description
380-355	7" (180mm), twisted end



Uebe Applicator

Catalog #	Description
380-356	6 1/4" (160mm), triangular end

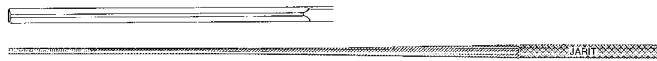

Pomeroys Ear Syringes

all metal, with one tapered tip and one bulbous tip

Catalog #	Description
380-360	2 ounce (60cc) capacity 3" (75mm)
380-362	4 ounce (120cc) capacity 4 7/8" (125mm)
380-365	Protective shield
380-366	Tapered tip
380-367	Bulbous tip

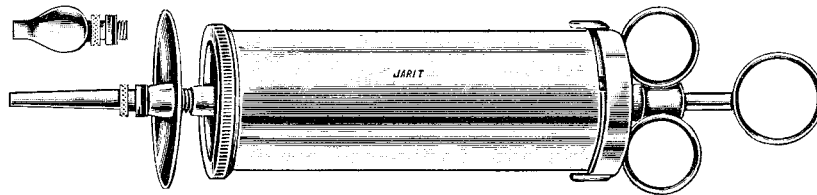

380-LOR-360	Replacement Large O-Ring Pkg/3ea
380-SOR-360	Replacement Small O-Ring Pkg/3ea
380-LOR-362	Replacement Large O-Ring Pkg/3ea
380-SOR-362	Replacement Small O-Ring Pkg/3ea

House Suction Adapter

Catalog #	Description
385-025	House Suction Adapter



House Suction Irrigators with thumb plate and cut-off

Catalog #	Description
385-030	2 x 2.5 FR, 5 ³ / ₈ " (138mm) overall length, 90mm working length
385-031	2.5 x 4 FR, 5 ³ / ₈ " (138mm) overall length, 75mm working length
385-032	2.5 x 4 FR, 6 ¹ / ₂ " (165mm) overall length, 100mm working length
385-033	4 x 5 FR, 5 ³ / ₈ " (138mm) overall length, 72mm working length
385-034	4 x 5 FR, 6 ¹ / ₂ " (165mm) overall length, 100mm working length
385-035	5 x 7 FR, 6 ¹ / ₂ " (165mm) overall length, 100mm working length
385-036	6 x 8 FR, 6 ¹ / ₂ " (165mm) overall length, 100mm working length
385-037	7 x 10 FR, 6 ¹ / ₂ " (165mm) overall length, 100mm working length
385-038	8 x 12 FR, 6 ¹ / ₂ " (165mm) overall length, 100mm working length
385-039	12 x 14 FR, 6 ¹ / ₂ " (165mm) overall length, 100mm working length

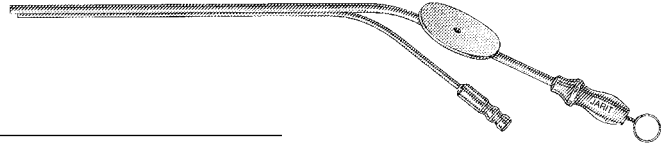

Rosen Suction Tubes

4" (101mm) overall length, 60mm working length

Catalog #	Description
385-040	14 gauge
385-041	15 gauge
385-042	16 gauge
385-043	17 gauge
385-044	18 gauge
385-045	19 gauge
385-046	20 gauge
385-047	22 gauge
385-048	24 gauge
385-049	26 gauge



Bellucci Suction Tube

Catalog #	Description
385-050	105mm working length, complete with 18, 20, and 22 gauge tips, thumb-plate and cut-off

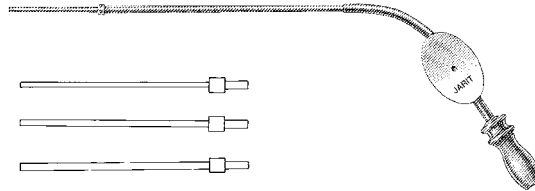

Bellucci Tips only

1" (25mm)

Catalog #	Description
385-051	18 gauge
385-052	20 gauge
385-054	22 gauge
385-055	24 gauge
385-056	26 gauge

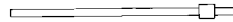

Bellucci Cannula only

Catalog #	Description
385-058	4 1/2" (115mm)

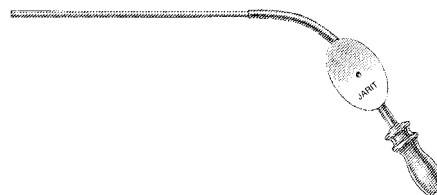

Anthony Suction Tubes

5 7/8" (149mm)

Catalog #	Description
385-060	Small: 2mm lumen at tip
385-062	Large: 3mm lumen at tip

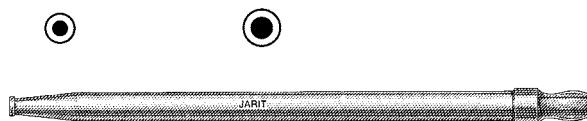

Baron Suction Tubes

5½" (140mm) overall length, 3" (75mm) working length

Catalog #	Description
385-080	3 French
385-082	5 French
385-084	7 French
385-STY-080	Replacement Stylet Pkg/3ea

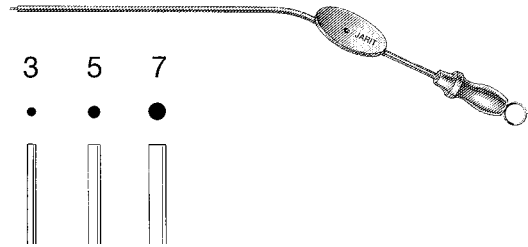

Frazier Suction Tubes

7½" (190mm) overall length, 4½" (114mm) working length

Catalog #	Description
285-449	5 French
285-450	6 French
285-451	7 French

*For stylets (angled Frazier Suction Tube only) add the letter "S" to catalog number.

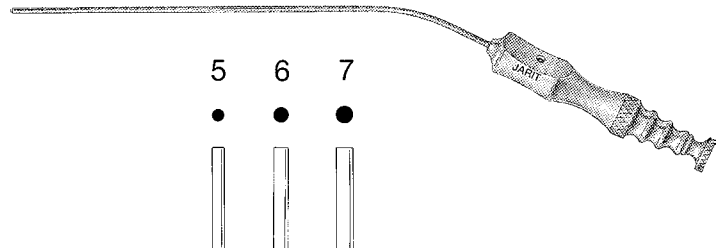

Baron Suction Tubes

6½" (165mm) overall length, 4" (100mm) working length

Catalog #	Description
285-480	3 French
285-482	5 French
285-484	7 French

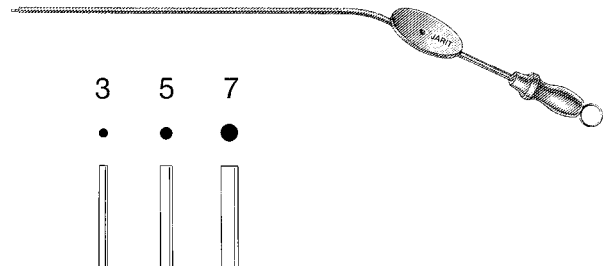

House Alligator Ear Forceps

3 7/8" (80mm) working length, serrated jaws, 0.9mm x 4mm
(details shown left to right)

Catalog #	Description
385-100	Straight
385-102	Up-angled
385-104	Down-angled
385-106	Left curved
385-108	Right curved

385-110 Side opening to right,
3 1/4" (82mm) working length,
serrated jaws, 0.9mm x 5.5mm
(details shown on far right)

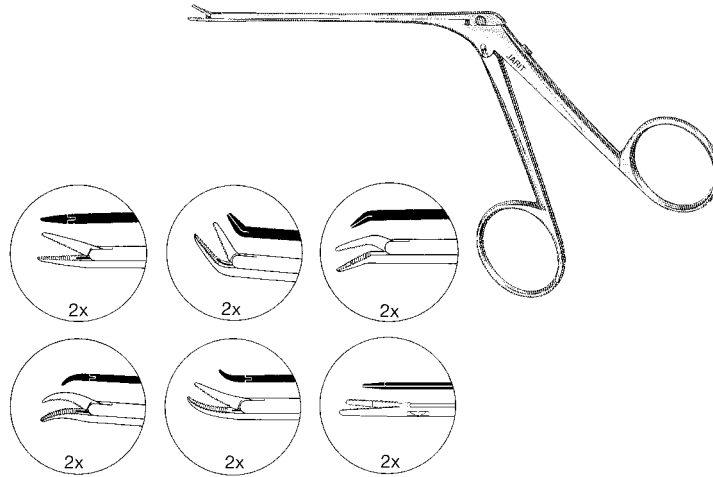

House Crimper Forceps

Catalog #	Description
385-115	3 3/8" (87mm) working length, flat tapered serrated jaws .75mm x 8mm

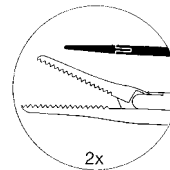

House Alligator Ear Forceps

3 1/4" (82mm) working length, serrated jaws

Catalog #	Description
385-120	Fine, .09mm x 5mm jaws
385-121	Delicate, .08mm x 4mm jaws

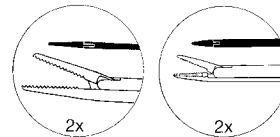

House Miniature Cup Forceps

3 1/4" (82mm) working length, oval cups 0.6mm x 1mm

Catalog #	Description
385-125	Straight
385-126	Angled left
385-127	Angled right

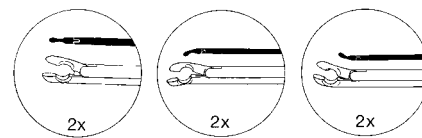

House Strut Forceps

Catalog #	Description
385-130	3 1/8" (80mm) working length, smooth jaws, 0.8mm x 4mm

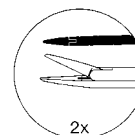

House Alligator Ear Forceps

3/4" (82mm) working length, oval cups 0.9mm x 1mm

Catalog #	Description
385-140	Straight
385-142	Up-angled
385-144	Down-angled
385-146	Left curved angled
385-148	Right curved angled

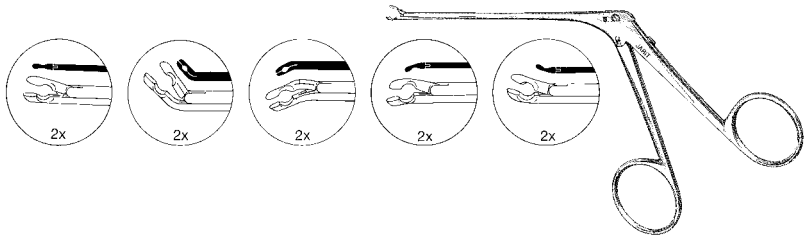

Bellucci Alligator Scissors

3 3/8" (87mm) working length

Catalog #	Description
385-200	Straight, 8mm blades
385-202	Up-angled, 6mm blades
385-204	Left curved, 8mm blades
385-206	Right curved, 8mm blades

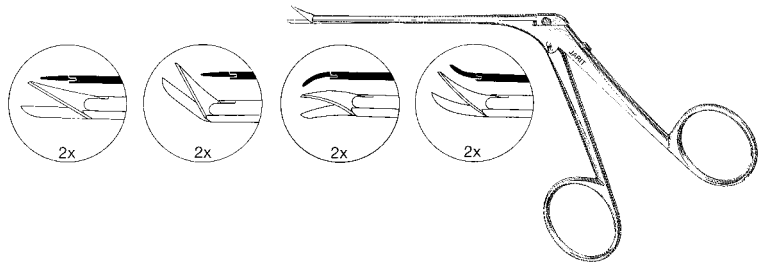

House-Bellucci Alligator Scissors

3 3/8" (87mm) working length, 5mm blades

Catalog #	Description
385-210	Straight
385-211	Left curved
385-212	Right curved

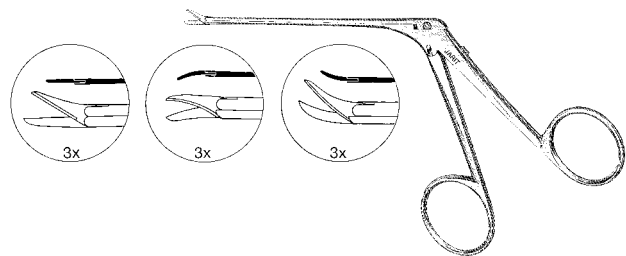

Micro Alligator Ear Forceps

3 1/8" (78mm) shaft

Catalog #	Description
385-220	Serrated jaws 0.6mm wide, ebony finish
385-221	Serrated jaws 0.8mm wide, ebony finish



Micro Alligator Ear Forcep

3 1/8" (78mm), Oval

Catalog #	Description
385-223	Oval cup jaws 0.5mm wide, ebony finish
385-224	Oval cup jaws 0.8mm wide, ebony finish



House-Dieters Malleus Nippers

3 1/4" (82mm) working length

Catalog #	Description
385-240	Large
385-242	Small

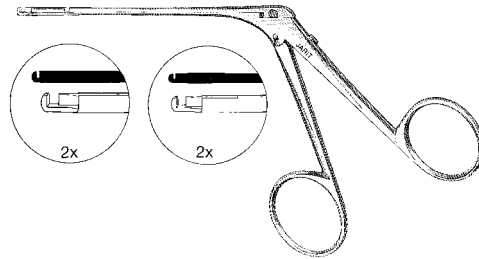

Hough Crura Nippers

3 1/8" (80mm) working length, 3mm jaws, 45° angle

Catalog #	Description
385-245	Left
385-246	Right

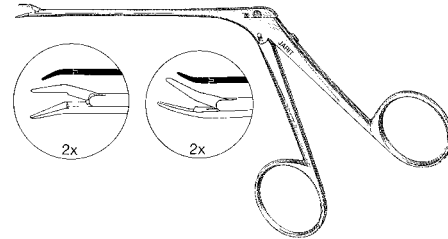

McGee Wire Closure Forceps

Catalog #	Description
385-250	3 1/4" (82mm) working length, .09mm x 3mm jaws

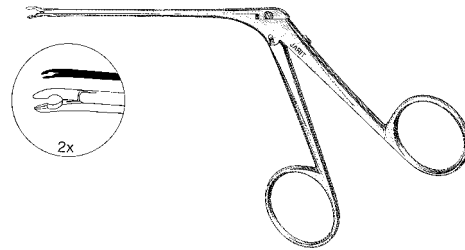

McGee Malleus Crimper or Wire Closure Forceps

Catalog #	Description
385-252	3 1/4" (82mm) working length, .09mm x 3mm jaws

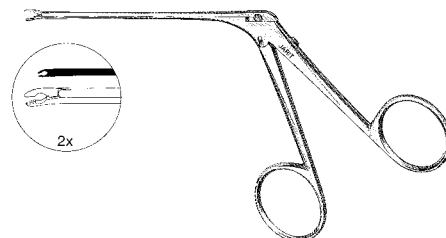

Jansen Retractors

3" (76mm)

Catalog #	Description
290-100	3 x 3 sharp prongs, 13mm deep blades
290-101	3 x 3 blunt prongs, 13mm deep blades

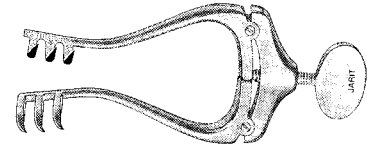

Jansen Retractor

Catalog #	Description
290-102	3 3/4" (94mm), 4 x 4 blunt prongs, 22mm deep blades

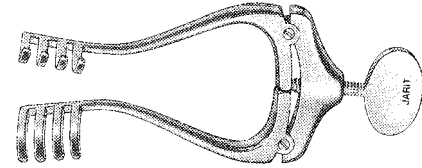

Perkins Retractors

4 7/8" (125mm), curved arms

Catalog #	Description
385-257	3 semi-sharp prongs, 13mm deep, on right, 12.5mm x 25mm solid blade with teeth on left
385-258	3 semi-sharp prongs, 13mm deep, on right, 12.5mm x 25mm solid blade with teeth on right

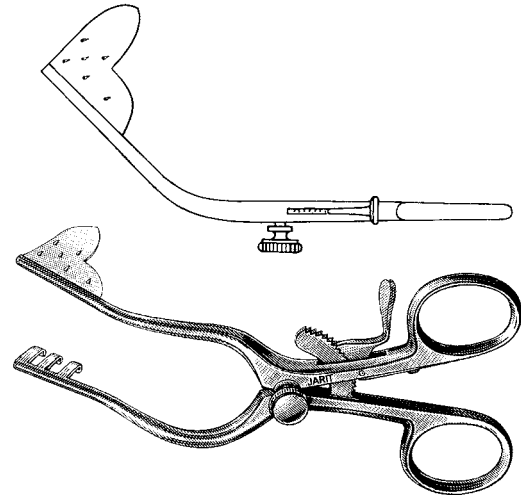

Wullstein Retractor

Catalog #	Description
385-260	5" (127mm), curved arms, 3 x 3 sharp prongs, 13mm wide x 17mm deep

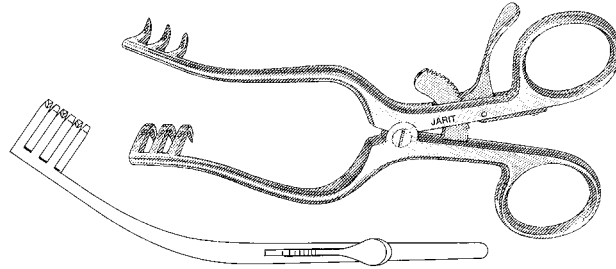

Weitlaner Retractor

Catalog #	Description
385-262	4 1/8" (105mm), curved arms, 3 x 3 blunt prongs, 12mm wide x 16mm deep

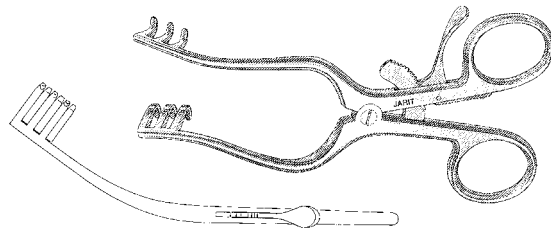

Bellucci-Wullstein Retractors

5 1/8" (130mm) curved arms

Catalog #	Description
385-265	2 semi-sharp prongs, 13mm deep, on right, 10mm x 25mm solid blade on left
385-266	2 blunt prongs, 13mm deep, on left, 10mm x 25mm solid blade on right

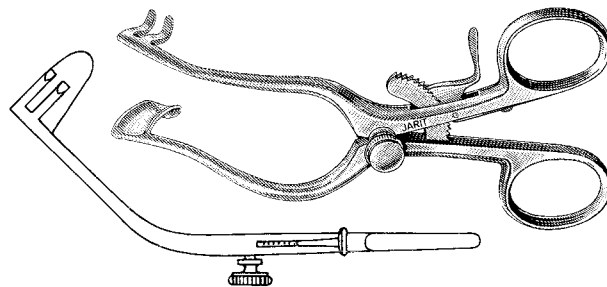

House Hand Retractor

Catalog #	Description
385-270	6" (152mm), double-ended, Small blade: 1/4" x 3/4" (65mm x 20mm), Large blade: 3/8" x 1" (8.75mm x 25mm)

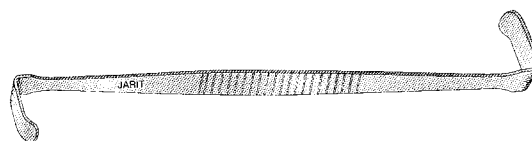

Guilford Scissors

Catalog #	Description
385-280	3¾" (95mm), 12mm blades, one blade serrated

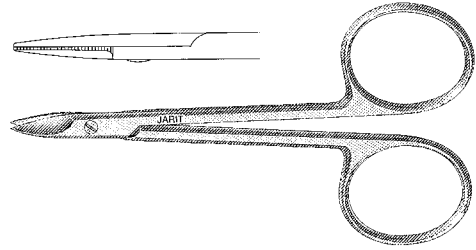

Shea Vein Graft Scissors

Catalog #	Description
385-285	4⅜" (118mm), curved, 9mm flat dissecting tips

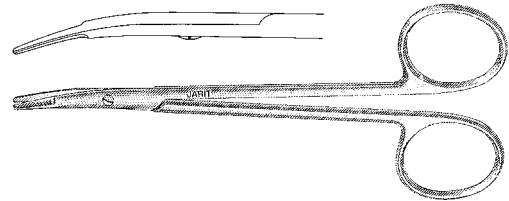

House Middle Ear Mirror

Catalog #	Description
385-305	6¾" (171mm), 2mm diameter, 45° angle

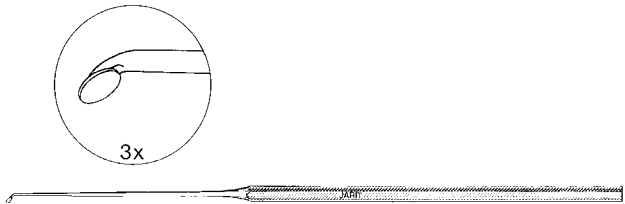

House Obtuse Pick

Catalog #	Description
385-310	6¼" (157mm), malleable shaft, 0.25mm tip, 30° angle

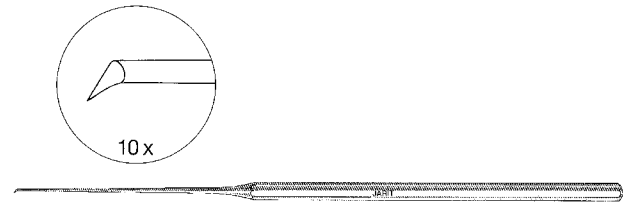

House Hooks

6⅝" (168mm), angled malleable shaft, 1mm tips

Catalog #	Description
385-315	90° left angled
385-316	90° right angled

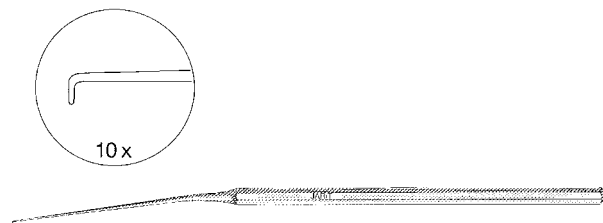

House Needle

Catalog #	Description
385-317	6 ⁵ / ₈ " (168mm), malleable shaft, semi-sharp curved tip

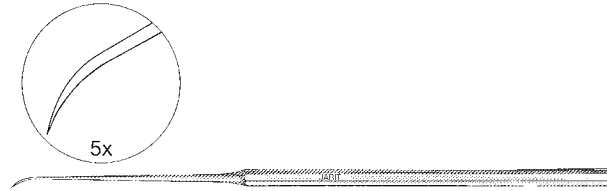

House-Sheehy Knife Curettes

6⁵/₈" (168mm), malleable shaft

Catalog #	Description
385-320	"Small weapon", 2mm semi-sharp blade
385-321	"Large weapon", 2.5mm semi-sharp blade

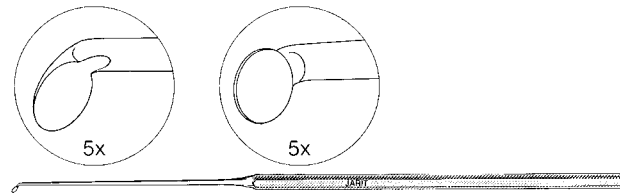

House-Rosen Needle

Catalog #	Description
385-326	6 ¹ / ₄ " (156mm), malleable shaft, semi-sharp tip, 3mm full curve from tip

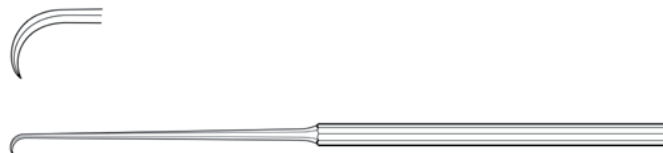

House-Rosen Needle

Catalog #	Description
385-327	6 ¹ / ₄ " (158mm), malleable shaft, 2.9mm semi-sharp curved tip

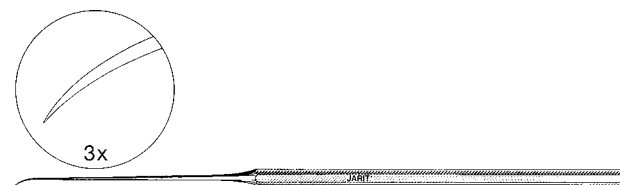

House Footplate Chisel

Catalog #	Description
385-330	6 5/8" (168mm), angled malleable shaft, 0.6mm tip

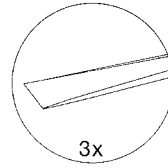

House-Hough Excavator

Catalog #	Description
385-335	6 5/8" (168mm), malleable shaft, 0.25mm tip, 90° angle

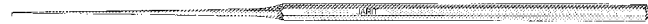
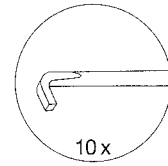

House Wire Strut Guide

Catalog #	Description
385-340	6 1/8" (156mm), angled, malleable shaft, 0.6mm tip with notched end

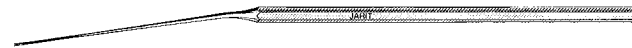
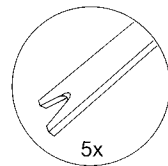

House Strut Calipers

6" (154mm), malleable shaft

Catalog #	Description
385-345	Marker 3.5mm from tip
385-346	Marker 4mm from tip
385-347	Marker 4.5mm from tip
385-348	Marker 5mm from tip

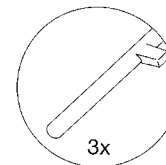
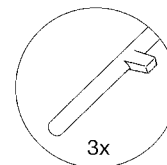
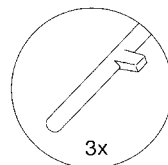
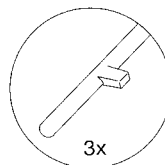

House-Barbara Pick

Catalog #	Description
385-350	6 ⁵ / ₈ " (168mm), malleable shaft, straight tip

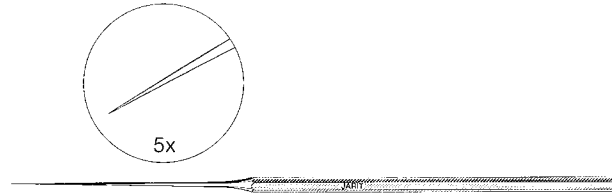

House Oval Window Picks

6⁵/₈" (168mm), malleable shaft

Catalog #	Description
385-351	0.33mm tip, 30° angle
385-352	0.66mm tip, 30° angle
385-353	0.33mm tip, 90° angle, fine shaft
385-354	0.33mm tip, 90° angle, medium shaft

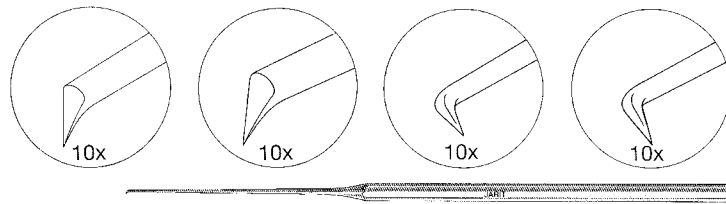

House Strut Picks

6⁵/₈" (168mm), malleable medium shaft, 90° angle

Catalog #	Description
385-355	0.5mm tip
385-356	0.66mm tip

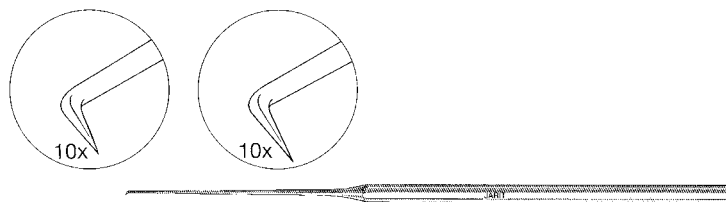

House Picks

6⁵/₈" (168mm), malleable heavy shaft, 90° angle

Catalog #	Description
385-360	1mm tip
385-361	1.5mm tip
385-362	3mm tip

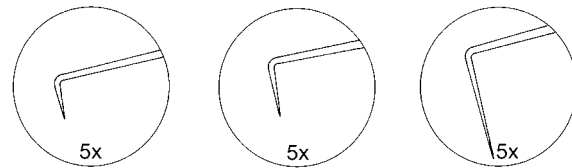

House-Crabtree Dissector Pick "Jimmy"

Catalog #	Description
385-370	6 ⁵ / ₈ " (168mm), 0.5mm x 2.5mm flat tip, 90° angle

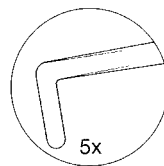

House-Crabtree Dissector

Catalog #	Description
385-371	6 ⁵ / ₈ " (168mm), 0.5mm x 1.5mm flat tip, 90° angle

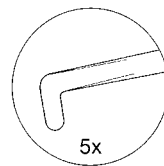

House Elevator "Gimmick"

Catalog #	Description
385-380	6 ⁵ / ₈ " (168mm), 1mm x 12mm blade, 15° angle

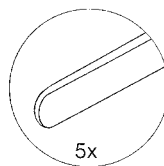

House Tympanoplasty Knife

Catalog #	Description
385-382	6 ⁵ / ₈ " (168mm), 7mm curved blade

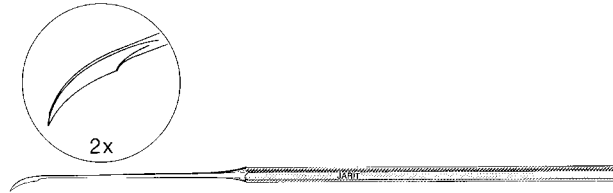

House Lancet Knife "Number Two Knife"

Catalog #	Description
385-384	6 ⁵ / ₈ " (168mm), 2mm x 3mm tapered blade, 45° angle

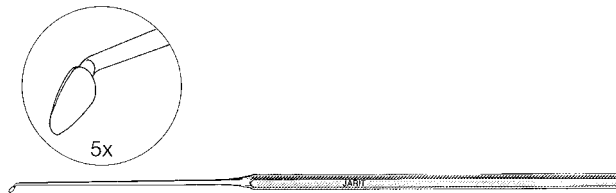

House Incudostapedial Joint Knife

Catalog #	Description
385-386	6 ⁵ / ₈ " (168mm), 0.75mm blade, 60° angle

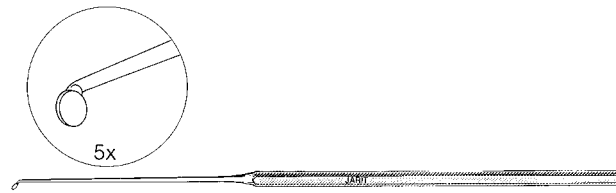

House Incudostapedial Joint Knife

Catalog #	Description
385-388	6 ⁵ / ₈ " (168mm), 0.5mm x 1.5mm blade, 20° angle

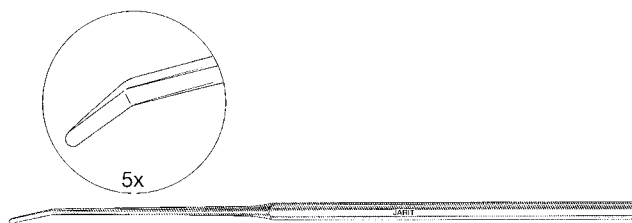

House Sickle Knife "Number One Knife"

Catalog #	Description
385-390	6 ⁵ / ₈ " (168mm), 8mm curved blade

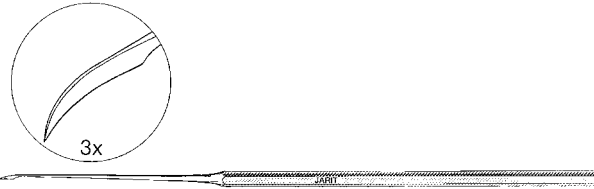

House Myringotomy Knife

Catalog #	Description
385-392	6 ⁵ / ₈ " (168mm), 3.5mm blade

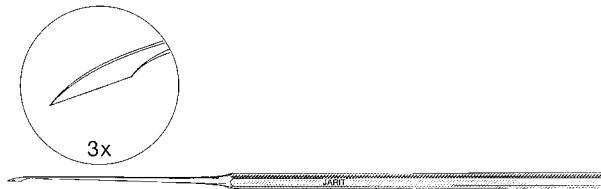

House Curettes

7" (180mm), double-ended, 2mm x 2.5mm and 2.25 x 3mm cups

Catalog #	Description
385-400	Light angle
385-401	Strong angle

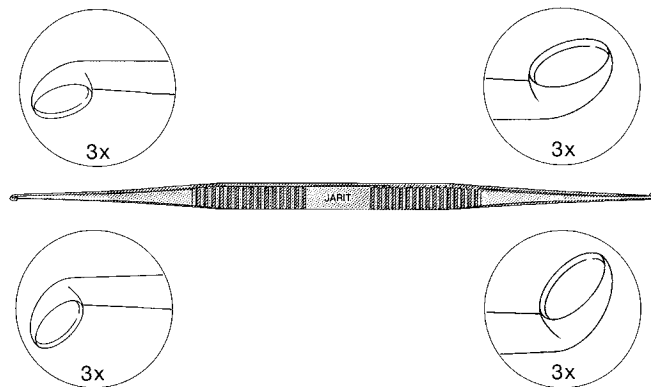

House Stapes Curette

Catalog #	Description
385-402	6" (152mm), double-ended. 2mm x 2.5mm and 2.25 x 3mm cups, 35° angle

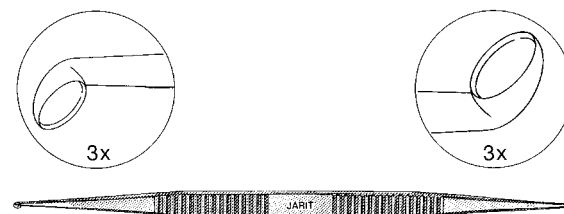

Derlacki Ossicle Holding Clamp

Catalog #	Description
385-430	4 ⁷ / ₈ " (124mm), 1.5mm x 4mm vertical groove and 1.5mm x 2mm horizontal groove

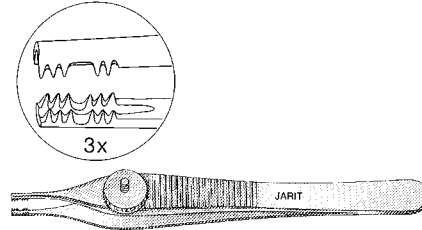

Sheehy Ossicle Holding Clamp

Catalog #	Description
385-440	4 ³ / ₄ " (121mm), 1.5mm x 4mm vertical groove

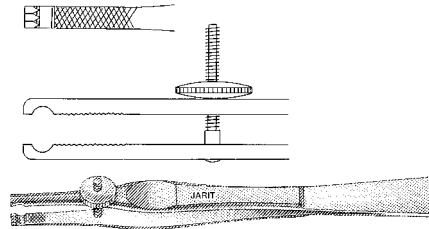

Sheehy Fascia Press

Catalog #	Description
385-500	7 ¹ / ₂ " (192mm), 23mm x 31mm plates

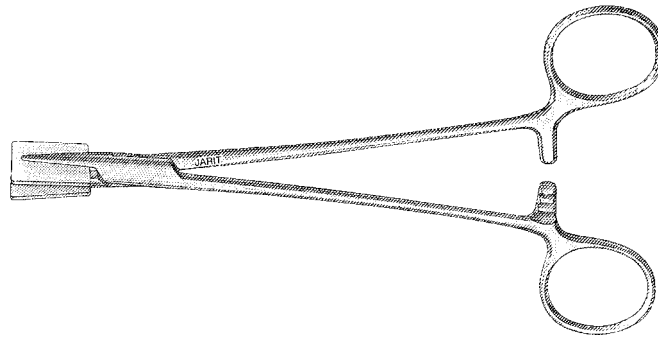

Gel Foam Presses

Catalog #	Description
385-505	5 ¹ / ₈ " (130mm), 12mm x 15mm plates
385-506	7 ¹ / ₂ " (190mm), 12mm x 16mm plates

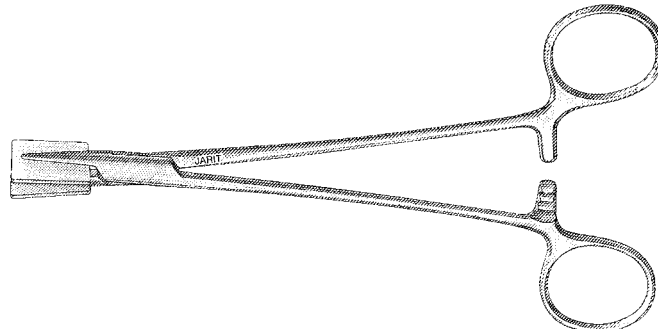

Vienna Nasal Specula

5 3/8" (138mm), original pattern

Catalog #	Description
400-100	Small: 29mm blades
400-101	Medium: 30mm blades
400-102	Large: 33mm blades

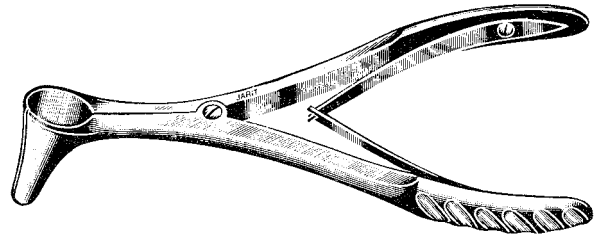

Sonnenschein Nasal Speculum

Catalog #	Description
400-105	6 1/4" (156mm), 29mm blades

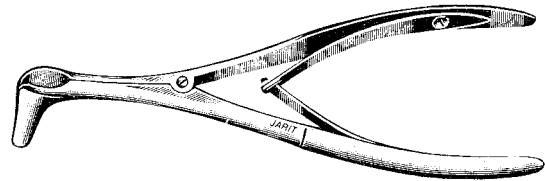

Tiek-Halle Infant Nasal Speculum

Catalog #	Description
400-110	5 1/8" (130mm), 17mm blades

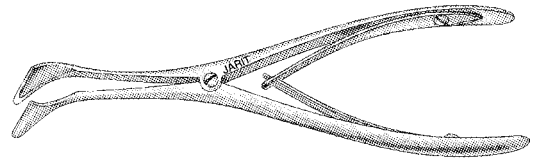

Beckman Nasal (Endaural) Speculum

Catalog #	Description
400-112	5 3/4" (146mm), side curved, 28.5mm blades

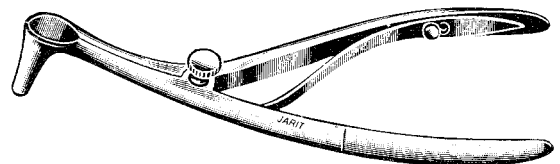

Vienna Nasal Specula

5½" (140mm), conventional blades

Catalog #	Description
400-115	Small: 27.5mm blades
400-116	Medium: 32.5mm blades
400-117	Large: 33mm blades

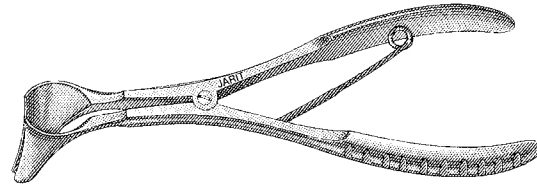

Vienna Nasal Specula

5½" (140mm), modified blades

Catalog #	Description
400-120	Small: 27.5mm blades
400-121	Medium: 32.5mm blades
400-122	Large: 33mm blades

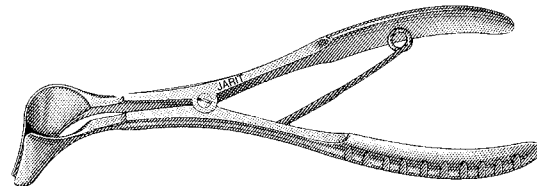

Killian Septum Specula

Catalog #	Description
400-130	5¾" (136mm), 50mm blades
400-131	5¾" (145mm), 65.5mm blades
400-132	5¾" (148mm), 76.5mm blades
400-134	6" (153mm), 91mm blades

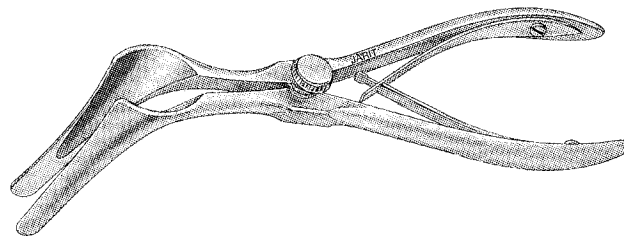

Hartman Nasal Speculum

Catalog #	Description
400-135	6¼" (160mm), 33.5mm blades

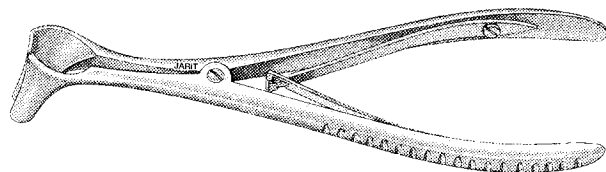

Cottle Septum Speculum

Catalog #	Description
400-136	5½" (140mm), 50mm thin blades, tapered to 3.4mm
400-SPS-136	Replacement Spring

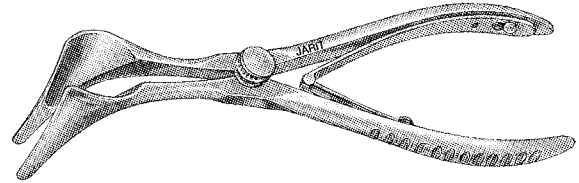

Cottle Septum Speculum

narrow tapered blades

Catalog #	Description
400-140	Size 1: 5¾" (135mm), 32mm blades, tapered 9mm to 4.5mm wide
400-141	Size 2: 5½" (140mm), 35mm blades, tapered 10mm to 8mm wide
400-142	Size 3: 5⅞" (146mm), 55mm blades, tapered 10mm to 6mm wide
400-143	Size 4: 5⅞" (146mm), 55mm blades, tapered 10mm to 7.5mm wide
400-144	Size 5: 6⅛" (155mm), 70mm blades, tapered 10mm to 7mm wide
400-145	Size 6: 6¼" (160mm), 80mm blades, tapered 10mm to 8mm wide
400-146	Size 7: 6½" (165mm), 90mm blades, tapered 10mm to 8mm wide

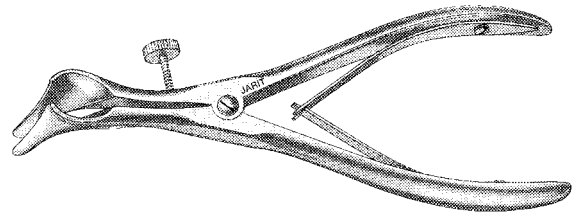

Jansen Nasal Dressing Forceps

Catalog #	Description
400-150	7¾" (195mm), 18mm serrated tip

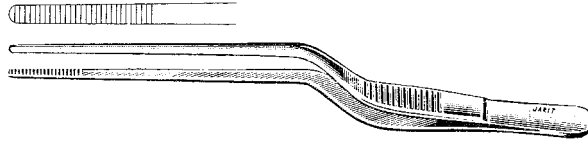

Gruenwald Nasal Dressing Forceps

Catalog #	Description
400-152	8½" (214mm), 20mm serrated tip

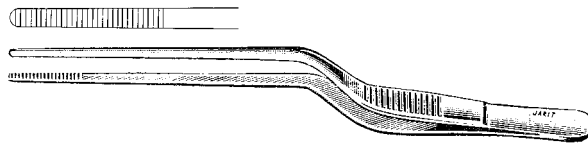

Wilde Nasal Dressing Forceps

Catalog #	Description
400-155	6¼" (158mm), 15.5mm serrated tip

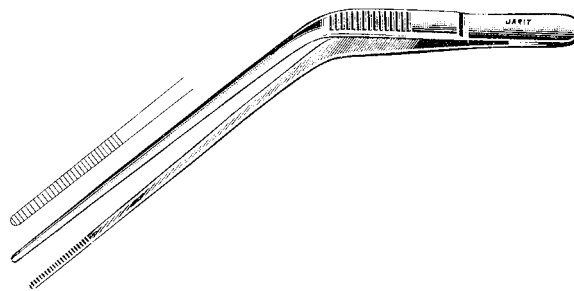

Hartman Nasal Dressing Forceps

3 1/2" (90mm) working length

Catalog #	Description
400-160	Delicate, 3.1mm wide x 13mm length tip
400-161	Regular, 3.7mm wide x 16mm length tip

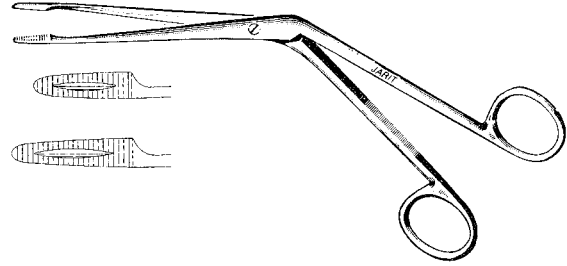

Noyes Nasal Dressing Forceps

5 1/2" (90mm) working length

Catalog #	Description
400-170	Serrated jaws, 2.4mm wide x 16mm length tip
400-171	1 x 2 teeth, 3.5mm wide x 16mm length tip

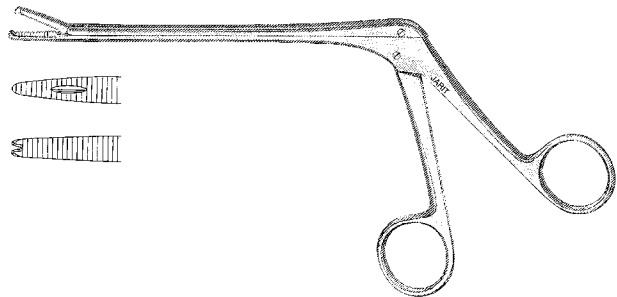

Knight Nasal Dressing Forceps

Catalog #	Description
400-175	2 1/4" (57mm) working length, serrated jaws 4.3mm wide x 15mm length

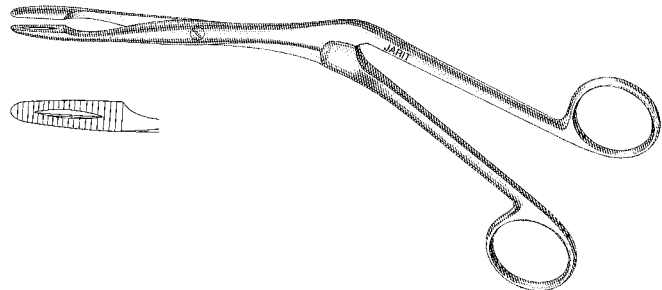

Seiler Turbinate Scissors

Catalog #	Description
400-177	6½" (163mm), 72mm blades

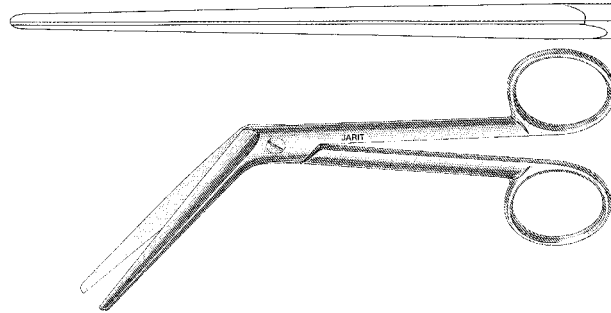

Knight Nasal Scissors

Catalog #	Description
400-180	6¼" (161mm), 33mm blades

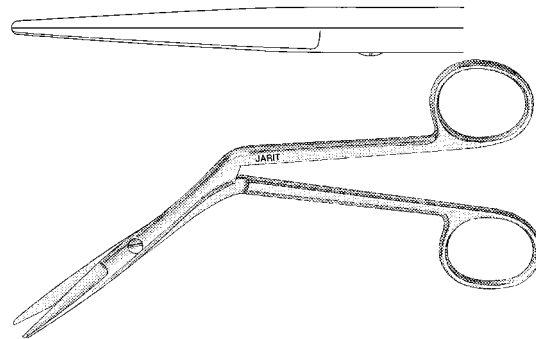

Knight Nasal Scissors, Supercut

Catalog #	Description
102-180	6¼" (161mm), 33mm blades

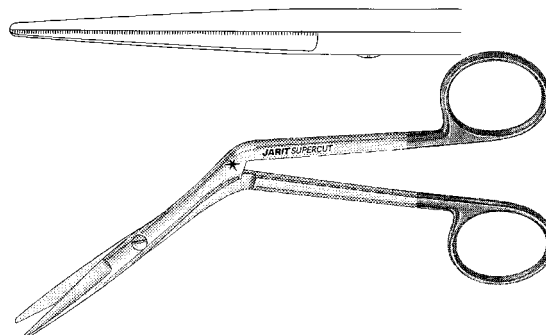

Joseph Scissors

Catalog #	Description
100-278	5⅝" (143mm), straight
100-279	5⅝" (143mm), curved

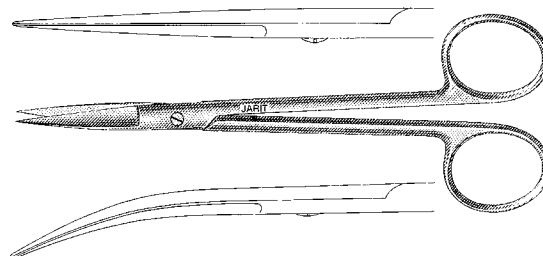

Krause Nasal Snare

Catalog #	Description
400-185	10" (255mm), includes 1 package of 12 snare wires, 28 gauge
400-STY-185	Replacement Stylet pkg/3ea
400-TUB-185	Replacement Tube Only

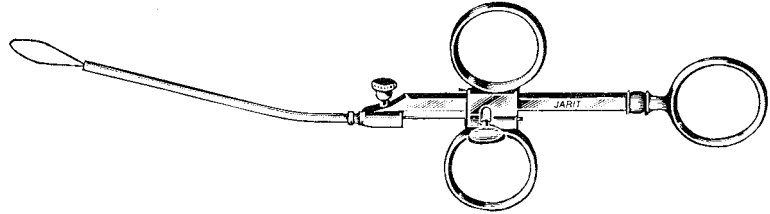

Bruening Nasal Snare

Catalog #	Description
400-187	8¾" (223mm), includes 1 package of 12 snare wires, 28 gauge
400-STY-187	Replacement Stylet pkg/3ea

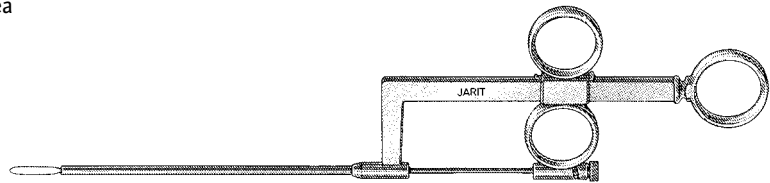

Van Alyea Frontal Sinus Cannula

Catalog #	Description
400-200	6" (151mm), light curve, silver

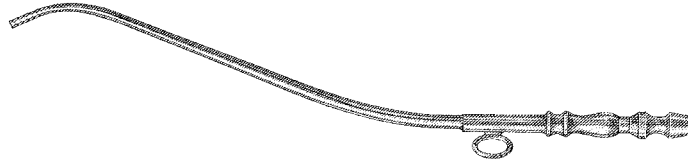

Lichtwicz Antrum Trocar Needle

Catalog #	Description
400-220	4 1/2" (114mm), 16 gauge with crossbar

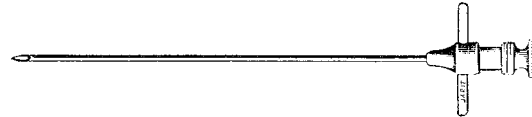

Ruskin Antrum Trocar Needles

4 1/8" (105mm), 14 gauge with crossbar

Catalog #	Description
400-222	Straight
400-223	Curved

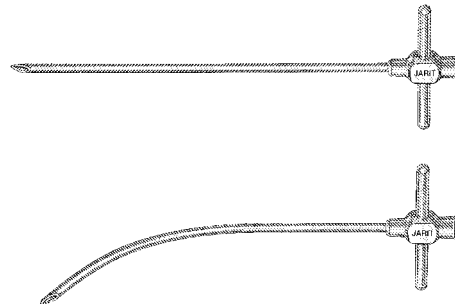

Coakley Antrum Trocars

6 1/4" (159mm), with cannula and irrigating extension

Catalog #	Description
400-225	Light curve
400-226	Strong curve

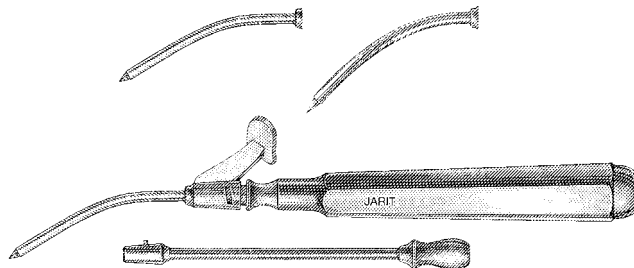

Killian (Von Eicken) Antrum Cannula

Catalog #	Description
440-230	5 1/2" (140mm), 3.8mm

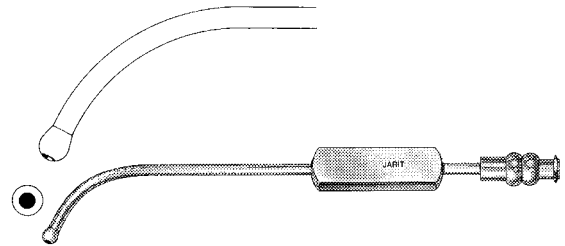

Wiener Antrum Rasps

7 3/4" (196mm)

Catalog #	Description
400-234	Small: trocar tip, 3mm
400-235	Medium: trocar tip, 4mm
400-236	Large: trocar tip, 5mm
400-237	Large: blunt tip, 5mm

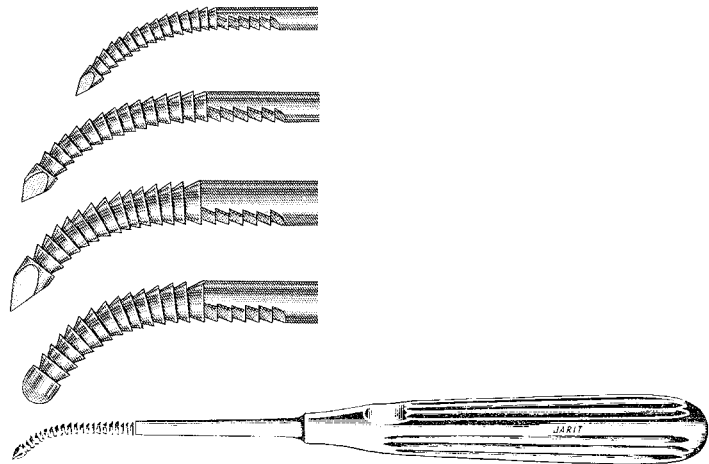

Ballenger V-Shaped Chisels

6¼" (160mm)

Catalog #	Description
400-240	2mm
400-241	4mm
400-242	6mm
400-243	8mm

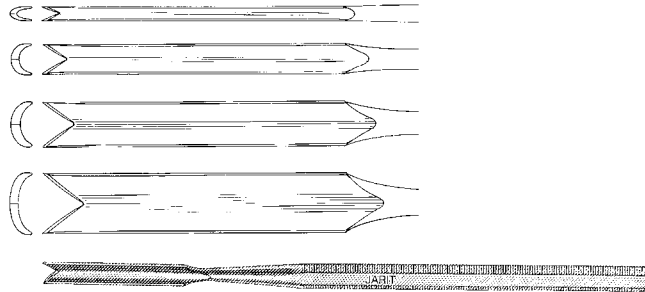

West Lacrimal Sac Chisel

Catalog #	Description
400-245	7½" (190mm), 6mm



West Lacrimal Sac Gouge

Catalog #	Description
400-247	7½" (190mm), 6mm



Freer Septum Knife

Catalog #	Description
400-250	7½" (188mm), 5mm angled blade



Pierce Elevator

Catalog #	Description
400-253	8 1/4" (210mm), double-ended, 5.7mm x 6mm blades

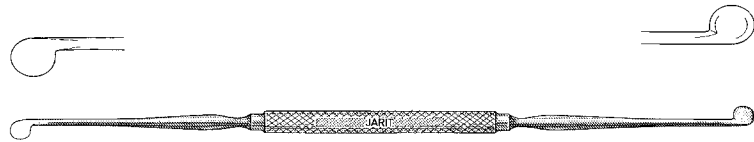

Freer Septum Knife

Catalog #	Description
400-255	6 1/2" (165mm), 5mm x 8mm "D" shaped knife



Freer Chisels

6 1/2" (165mm), 4mm x 10mm wide

Catalog #	Description
400-257	Straight
400-258	Curved



Ballenger Swivel Knives

8 1/4" (212mm), straight

Catalog #	Description
400-260	3mm
400-261	4mm
400-262	5mm

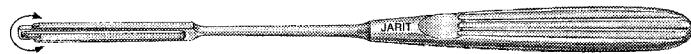

Ballenger Swivel Knives

8" (202mm), bayonet

Catalog #	Description
400-263	3mm
400-264	4mm
400-265	5mm

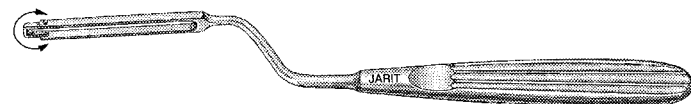

Cottle-McKenty Elevator

Catalog #	Description
400-269	8½" (215mm), double-ended, 3.5mm x 4.5mm wide blades

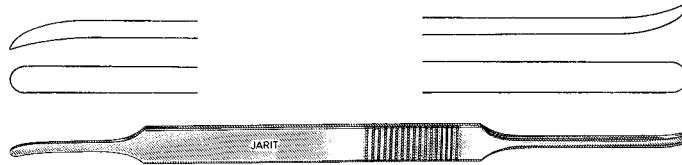

McKenty Septal Elevators

6" (152mm)

Catalog #	Description
400-270	4mm wide blades
400-271	5mm wide blades

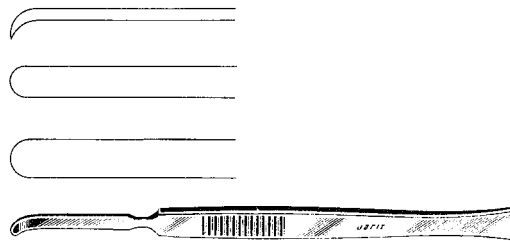

Pennington Septal Elevator

Catalog #	Description
400-272	8¼" (209mm), double-ended, 4.2mm x 4.6mm wide blades

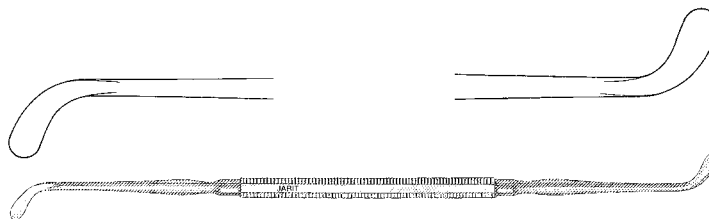

Ostium Seeker Ball End Elevator

Catalog #	Description
400-273	7½" (190mm), double-ended, 2mm x 2.5mm diameter ball tips



Freer Septum Elevator

7½" (190mm), single-ended

Catalog #	Description
400-274	5mm wide blade and 6mm wide round blade

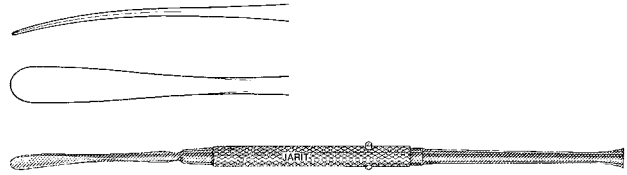

Freer Septum Elevators

7¾" (198mm), double-ended, sharp-blunt blades

Catalog #	Description
285-379	6.5mm wide blades
285-380	4.5mm wide blades

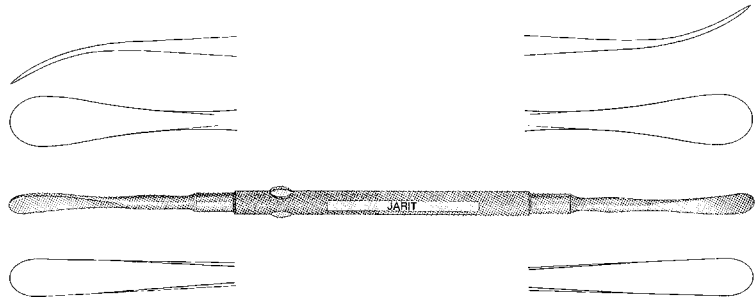

Ballenger Septum Elevator

Catalog #	Description
400-275	8¾" (222mm), double-ended, semi-sharp and blunt blades, 5.5mm wide

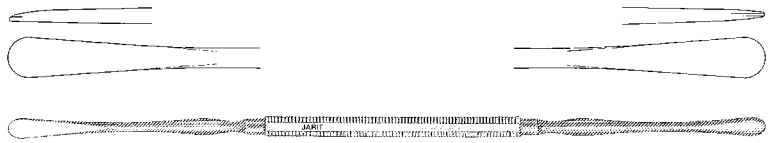

Roger Elevator

Catalog #	Description
400-276	8¼" (210mm), double-ended, 3mm wide

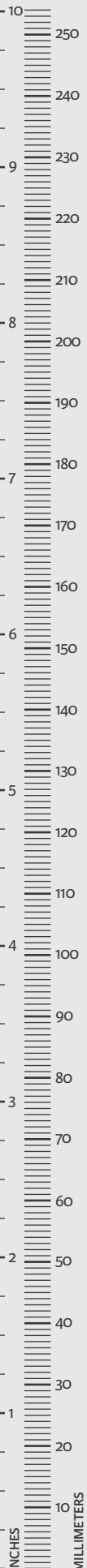
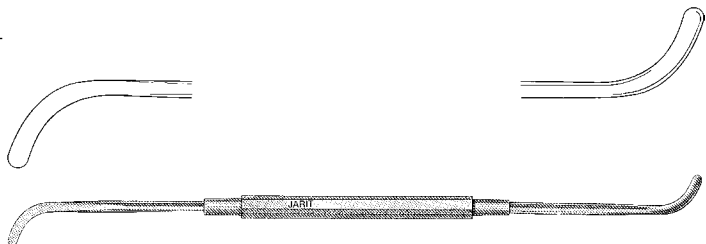

Cottle Septum Elevator

Catalog #	Description
400-277	9" (226mm), double-ended, graduated, 4.6mm wide blade and 4.9mm wide round end

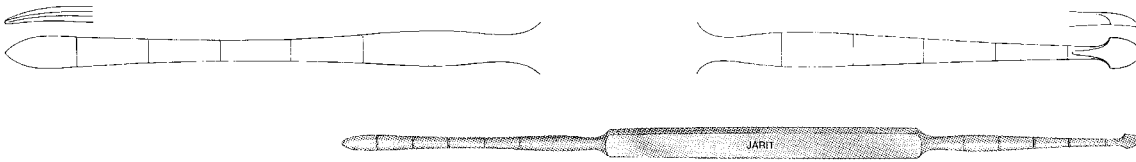

Cottle Elevator

Catalog #	Description
400-278	9" (230mm), double-ended, for tunneling, 4.8mm and 5mm wide blades

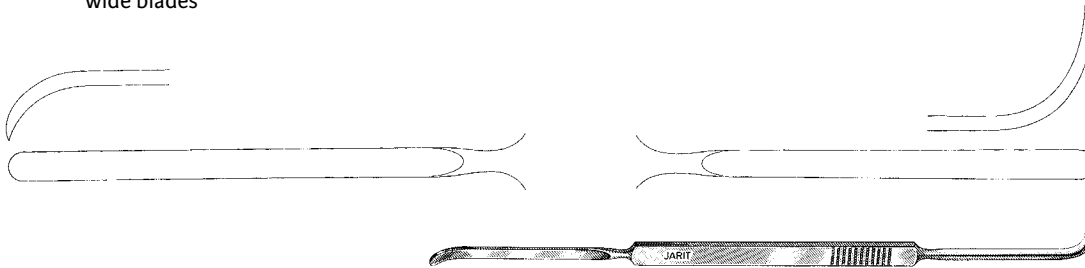

Jarit Periosteal Elevators

6¼" (160mm), 5mm wide blade

Catalog #	Description
285-345	Blunt
285-346	Semi-sharp



Boies Nasal Fracture Elevator

Catalog #	Description
400-279	7½" (190mm), 11mm wide blades

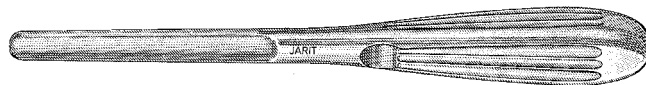

Converse Periosteal Elevator

Catalog #	Description
400-280	7¼" (184mm), 5mm wide blades

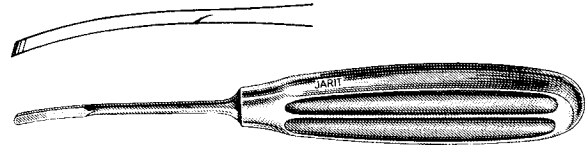

Joseph Periosteal Elevator

Catalog #	Description
400-281	6¾" (173mm), 4.2mm wide blade

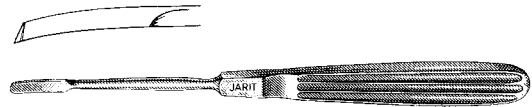

Cottle Skin Elevator

Catalog #	Description
400-282	7½" (190mm), 8mm wide blade

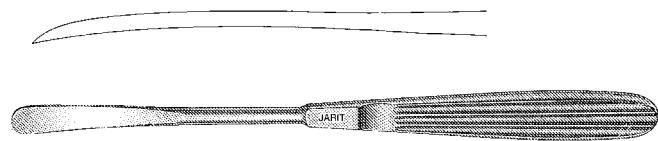

Goldman Displacer Septum Elevator

Catalog #	Description
400-285	7¾" (197mm), 6.7mm wide blade

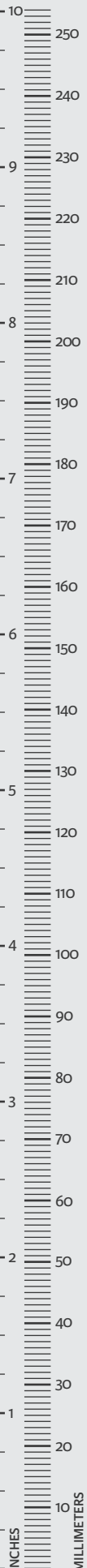
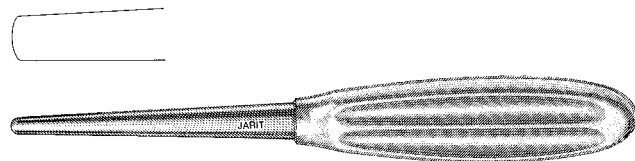

Dingman Zygoma Elevator

Catalog #	Description
400-286	8¾" (225mm), 5.5mm wide, curved rounded blade

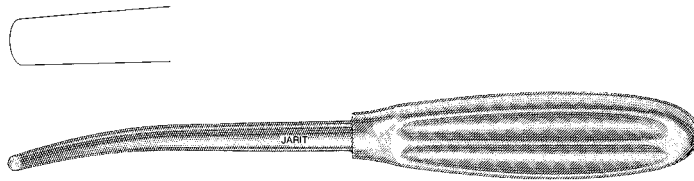

Halle Elevators

7" (178mm)

Catalog #	Description
400-287	3mm blade
400-288	5mm blade

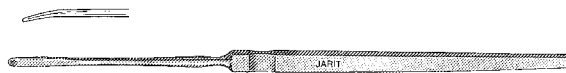

Kleinert-Kutz Elevator and Dissector

Catalog #	Description
400-290	7½" (193mm), double-ended, 2mm and 3mm wide round blades

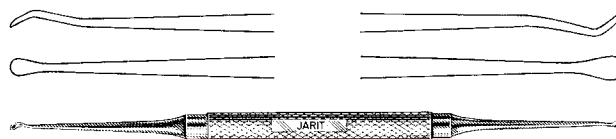

Kleinert-Kutz Elevator and Dissector

Catalog #	Description
400-292	7" (178mm), double-ended, 2.5mm wide long blade and 4.2mm wide round blades

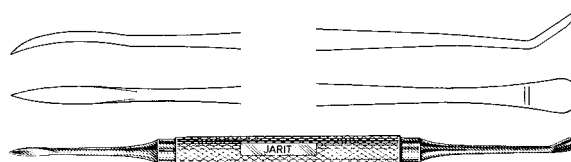

Gillies Bone and Zygoma Hook

Catalog #	Description
400-293	7" (178mm), 9mm hook

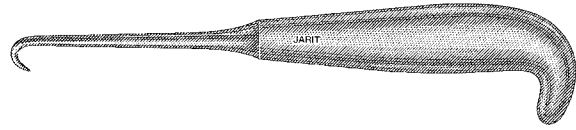

Gillies Zygoma Elevator

Catalog #	Description
400-294	8¾" (225mm), 9mm wide blade

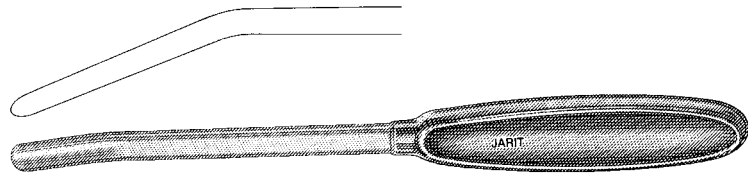

Dunning Elevator and Curette

Catalog #	Description
400-296	8" (201mm), double-ended, 3mm wide blade and 4mm x 6mm curette



Gorney Septum Suction Elevator

Catalog #	Description
400-297	7½" (190mm), 3.2mm wide tip
400-OBT-297	Replacement Obturator

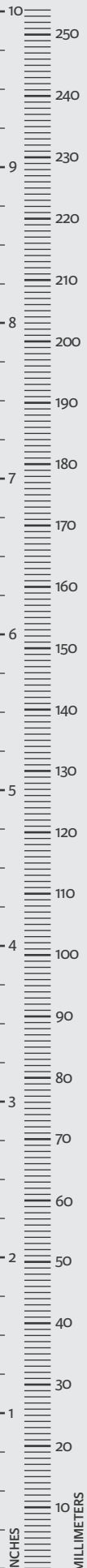

Faulkner Antrum Curette

Catalog #	Description
400-298	8¾" (220mm), double-ended, 7mm x 9.8mm rings, with cutting edges on both sides

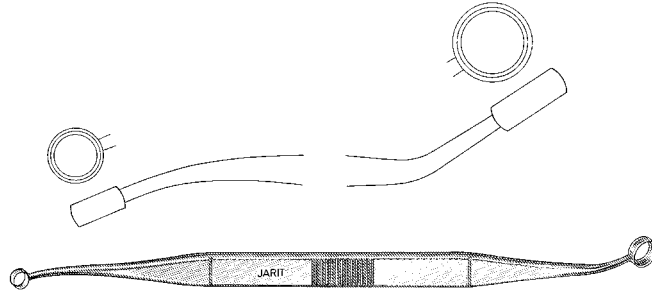

Pratt Ethmoid Curette

Catalog #	Description
400-299	9¼" (235mm), double-ended, 5mm solid cup straight shaft, 5mm fenestrated cup angled shaft



Coakley Antrum Currettes

8" (230mm), single-ended

Catalog #	Description
400-300	Set of 6
400-301	No. 1: 30° angle, 7.5mm x 9.5mm oval tip
400-302	No. 2: 60° angle, 7.5mm x 9.5mm oval tip
400-303	No. 3: 100° angle, 7.5mm x 9.5mm oval tip
400-304	No. 4: 30° angle, 6.5mm x 7.5mm oval tip
400-305	No. 5: 60° angle, 6.5mm x 7.5mm oval tip
400-306	No. 6: 30° angle, 7.5mm x 7.5mm triangular tip

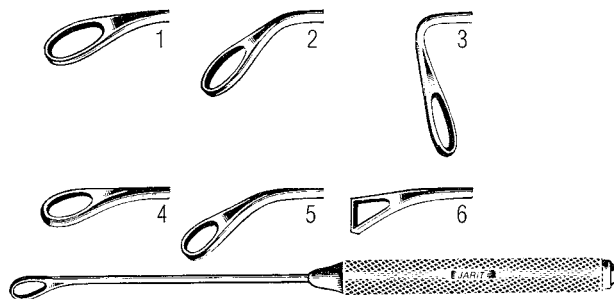

Coakley Sinus Currettes

7½" (190mm), 7mm x 10mm tip

Catalog #	Description
400-307	Backward cutting
400-308	Forward cutting

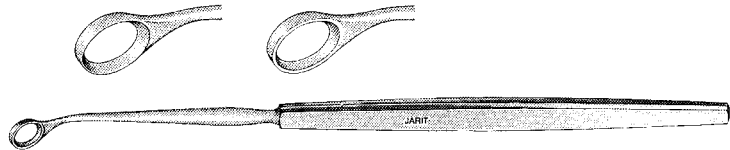

Coakley Sinus Currettes

9½" (241mm), double-ended

Catalog #	Description
400-320	One slightly angled oval tip and one 45° angled oval tip, 5.8mm x 6.9mm
400-321	One slightly angled oval tip and one 45° angled oval tip, 7.7mm x 9.7mm
400-322	One 90° angled oval tip and one slightly angled triangular tip, 7.7mm x 9.7mm

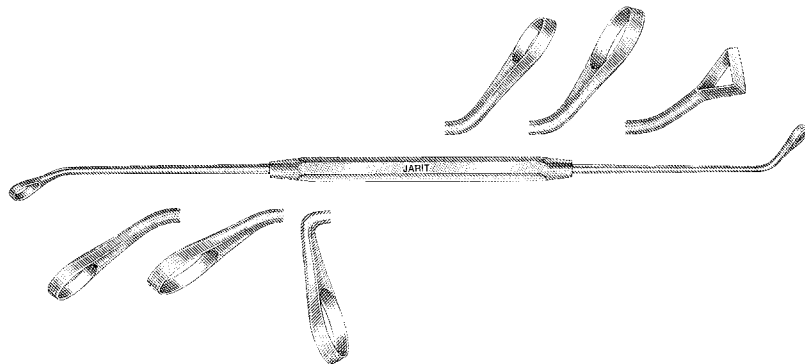

Knight Polypus and Turbinate Forceps

2 1/4" (56mm) working length, 7" (175mm) overall length

Catalog #	Description
405-100	5mm x 14mm cup jaws

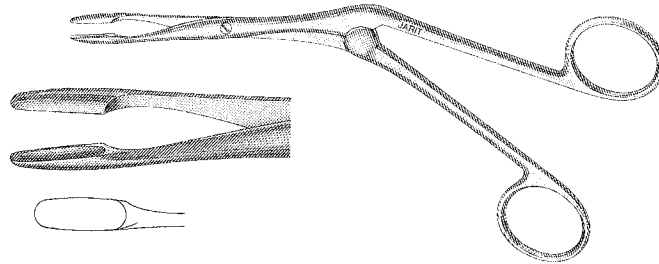

Watson-Williams Polypus Forceps

4 1/2" (115mm) working length, 7 1/8" (180mm) overall length

Catalog #	Description
405-105	No. 1: 6.5mm x 10mm cup jaws
405-106	No. 2: 9.5mm x 13mm cup jaws

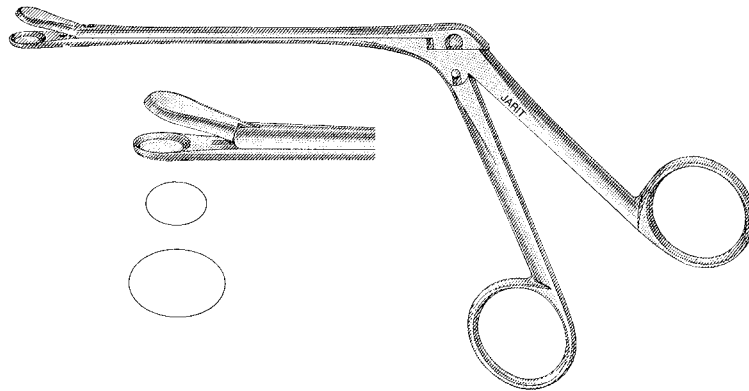

Knight Polypus and Turbinate Forceps

4 3/8" (112mm) working length, 7 1/2" (190mm) overall length

Catalog #	Description
405-108	5.4mm x 17mm cup jaws

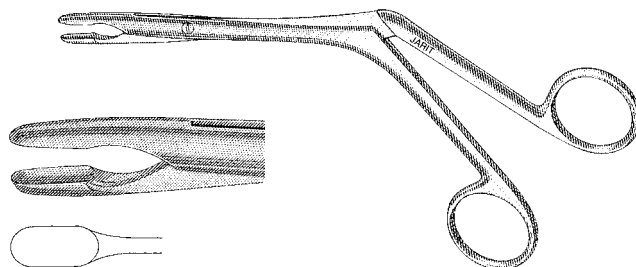

Gruenwald Nasal Forceps

4 1/2" (115mm) working length, 7 1/2" (190mm) overall length, thru-cutting jaws

Catalog #	Description
405-110	No. 1: 3mm x 10mm cup jaws
405-111	No. 2: 3.5mm x 11.3mm cup jaws
405-112	No. 3: 4mm x 12mm cup jaws

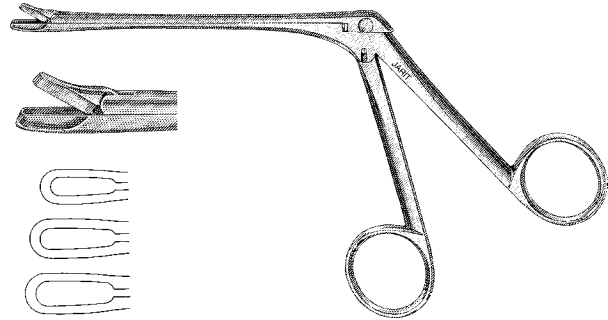

Wilde Nasal Forceps

5 1/2" (140mm) working length, 7 1/2" (190mm) overall length, straight, fenestrated

Catalog #	Description
280-450	No. 1: 4mm x 11mm cup jaws
280-451	No. 2: 5mm x 12mm cup jaws
280-452	No. 3: 6mm x 13mm cup jaws

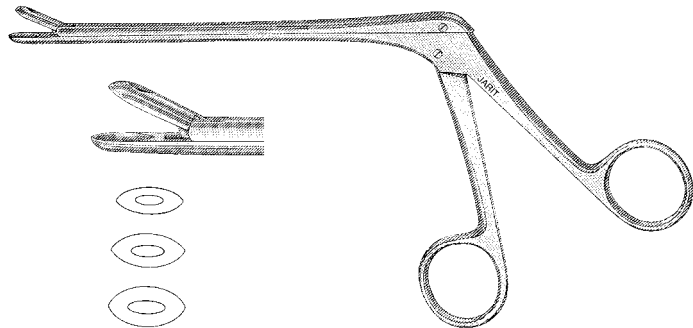

Wilde Nasal Forceps

4 1/2" (115mm) working length, 6 7/8" (175mm) overall length

Catalog #	Description
280-454	5mm x 10mm cup jaws

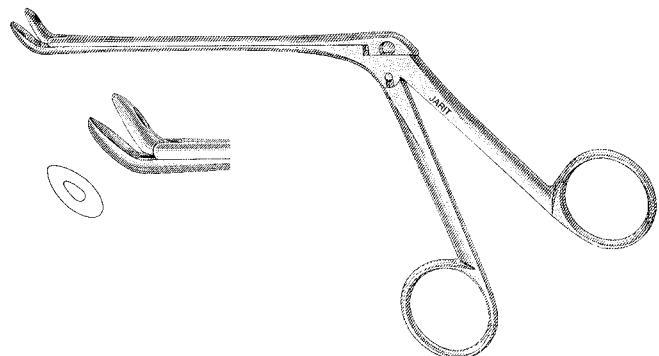

Weil Nasal Forceps

4 1/2" (115mm) working length, 7 1/2" (190mm) overall length,
5mm x 8.5mm cup jaws

Catalog #	Description
405-115	Straight
405-116	Up-angled

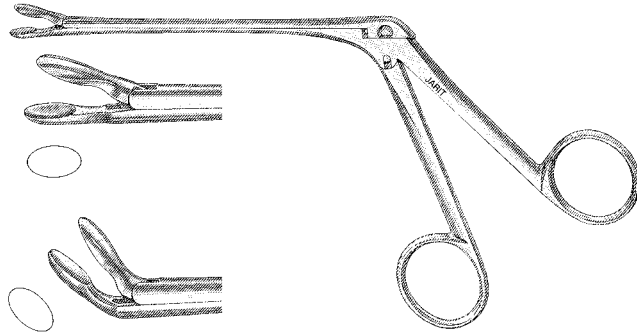

Struempel-Voss Nasal Forceps

4 1/4" (115mm) working length, 7 1/2" (190mm) overall length

Catalog #	Description
405-118	3mm x 5mm cup jaws

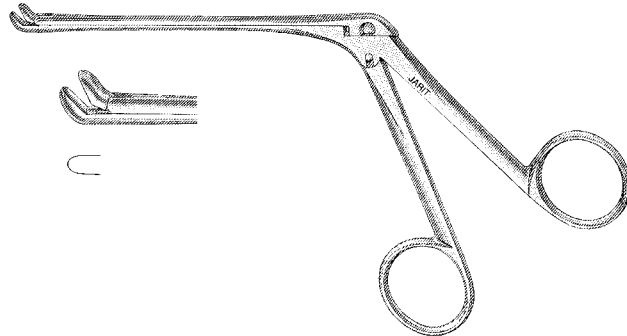

Blakesley Septum Forceps

4 1/2" (115mm) working length, 7 1/2" (190mm) overall length)

Catalog #	Description
405-120	6.6mm x 12mm serrated jaws

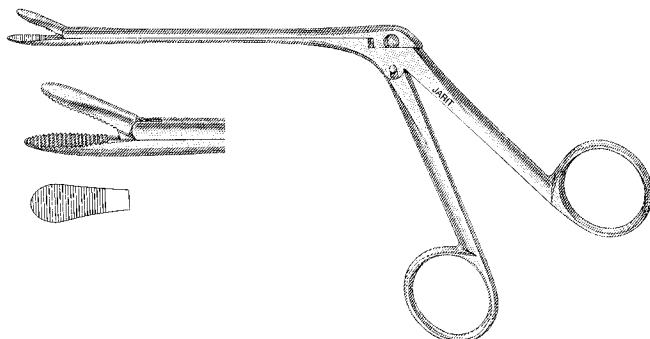

Lewis Septum Forceps

4 1/4" (110mm) working length, 7 1/2" (190mm) overall length

Catalog #	Description
405-122	11.5mm round grooved jaws, left side opening

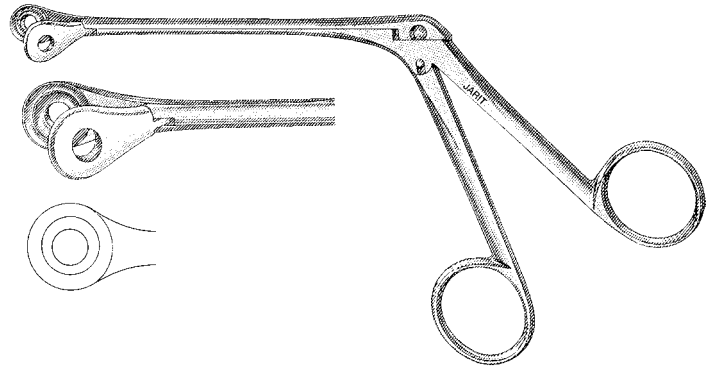

Killian Septum Forceps

2 5/8" (67mm) working length, 6 3/4" (170mm) overall length

Catalog #	Description
405-125	5mm x 30mm serrated jaws

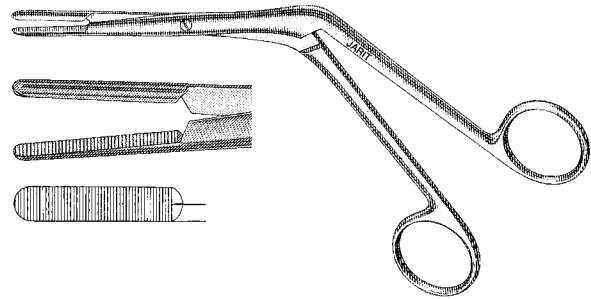

Bruening Septum Forceps

4 1/4" (108mm) working length, 7 3/8" (187mm) overall length

Catalog #	Description
405-130	No. 1: 7mm x 9mm jaws
405-131	No. 2: 9mm x 11mm jaws

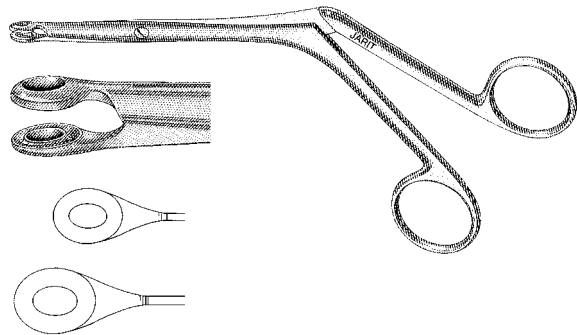

Jansen-Middleton Septum Forceps

7¾" (197mm)

Catalog #	Description
405-150	Cup jaws, 5mm x 12.5mm
405-152	Thru-cutting jaws, 3.6mm x 16mm
405-153	Thru-cutting jaws, 4.6mm x 16mm

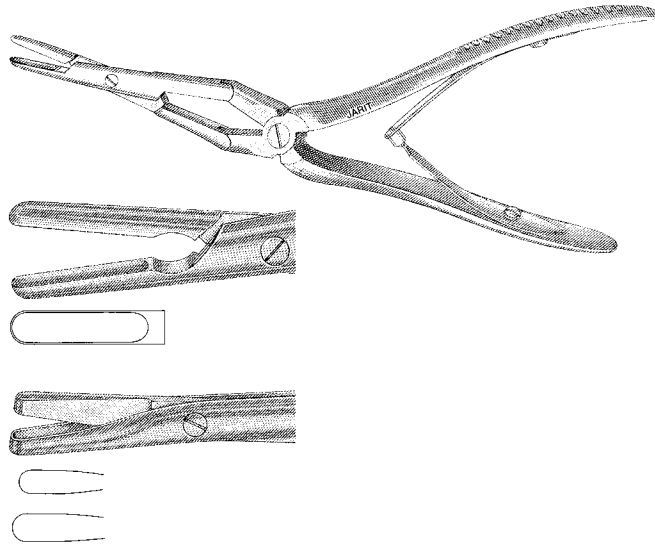

Ferris-Smith Fragment Forceps

4½" (115mm) working length, 7½" (190mm) overall length

Catalog #	Description
405-155	5.5mm x 9mm serrated jaws

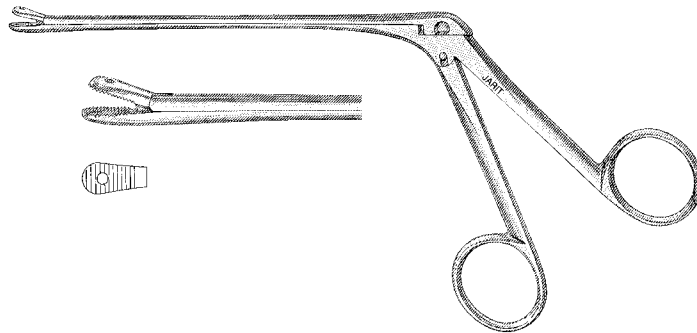

Asch Septum Straightening Forceps

Catalog #	Description
405-180	8¾" (225mm), angled on flat, 7mm x 44mm jaws

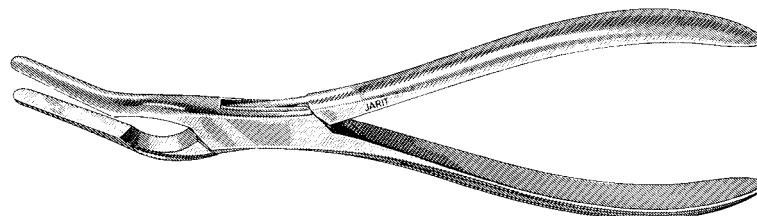

Walsham Septum Straightening Forceps

9" (230mm)

Catalog #	Description
405-181	Straight: 7mm x 33mm jaws
405-182	Right: 7mm x 33mm jaw with flat inner surface and 9.5mm x 33mm jaw with concave inner surface
405-183	Left: 7mm x 33mm jaw with flat inner surface and 9.5mm x 33mm jaw with concave inner surface
405-184	Universal: bayonet shape, 10.5mm x 33mm jaws

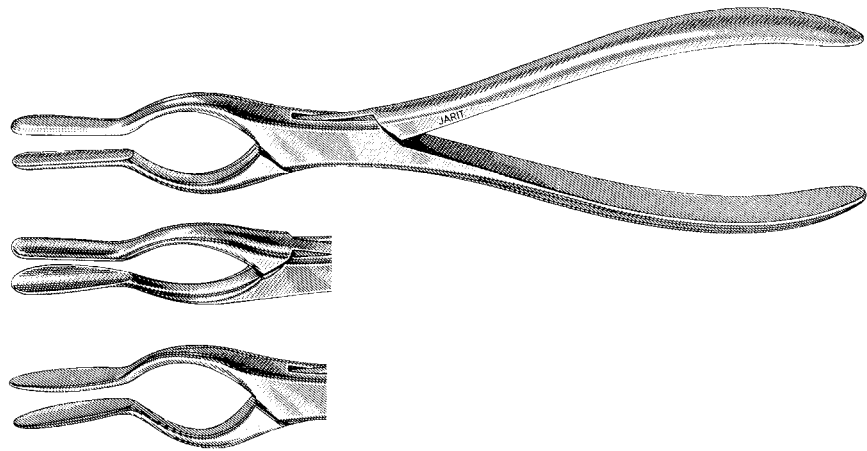

Takahashi Nasal Forceps

4 1/2" (115mm) working length, 7 1/2" (190mm) overall length

Catalog #	Description
405-186	2.5mm x 10mm jaws

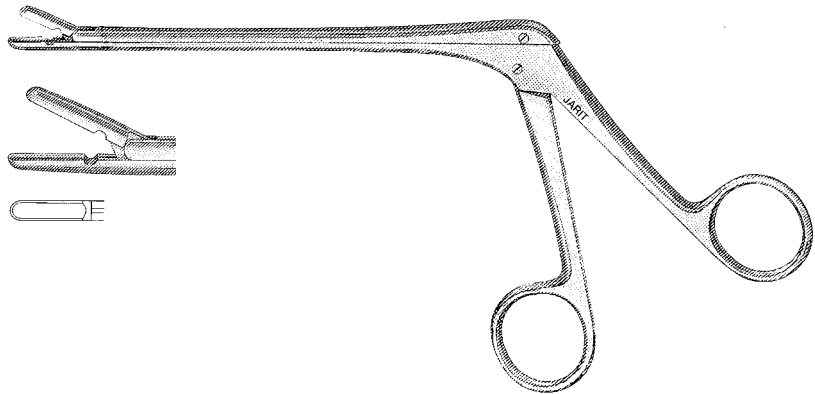

Cottle-Kazanjian Nasal Cutting Forceps

Catalog #	Description
405-190	7½" (190mm) overall length, straight 30mm jaws

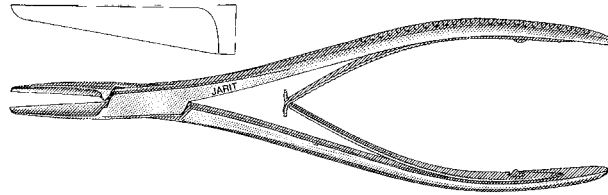

Cottle Biting Forceps

Catalog #	Description
405-192	7" (180mm) overall length, angular 30mm jaws

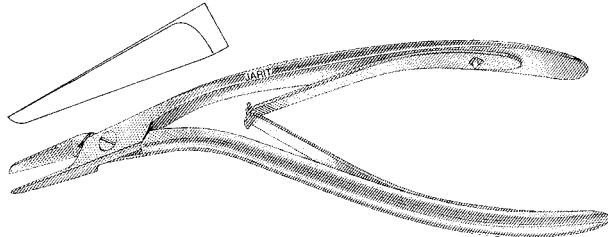

Rowland (Ruskin-Liston) Bone Splitting Forceps

Catalog #	Description
230-310	7¼" (182mm), straight, 20mm jaws

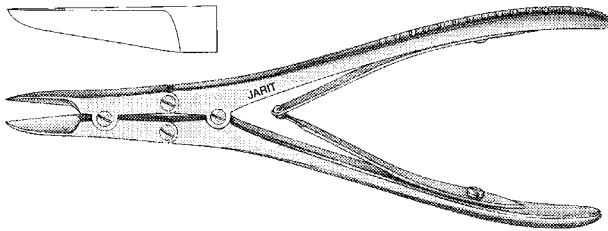

Rubin Septum Morselizer

Catalog #	Description
405-200	7 1/2" (190mm), 6mm x 11mm jaws
405-201	Rubin Morselizer Guard

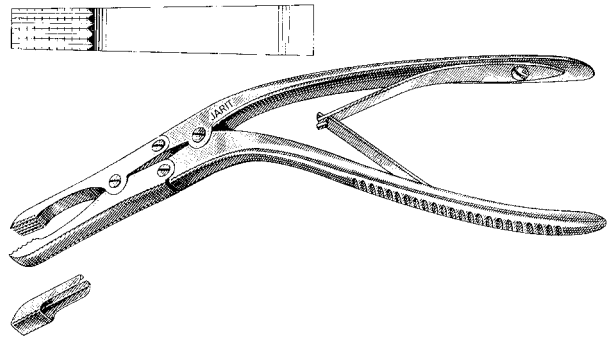

Wright-Rubin Septum Morselizer

Catalog #	Description
405-210	8" (205mm), 6mm x 11mm jaws

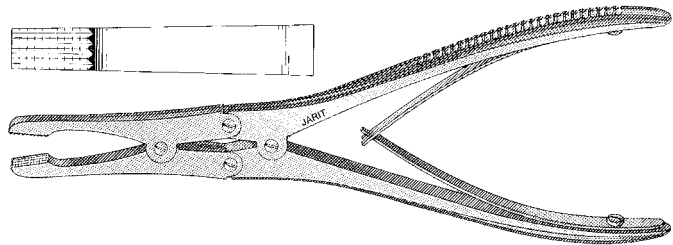

Cottle Cartilage Crusher

Catalog #	Description
405-225	2 3/4" (16mm x 70mm) crushing area

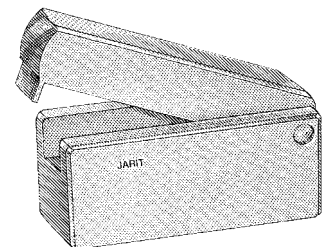

Integra™
Plastic and
Reconstructive
Instruments and
General Surgical
Instruments

Joseph Nasal Knives

6" (152mm), double-edged, sharp

Catalog #	Description
410-100	Straight, 4mm x 23mm blade
410-101	Straight, 6mm x 23mm blade
410-105	Curved, 4mm x 23mm blade
410-106	Curved, 6mm x 23mm blade

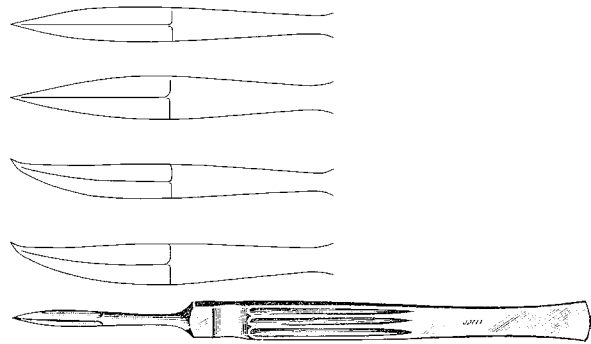

Joseph Nasal Knives

6" (152mm), double-edged, blunt

Catalog #	Description
410-110	Straight, 4mm x 23mm blade
410-111	Straight, 6mm x 23mm blade
410-115	Curved, 4mm x 23mm blade
410-116	Curved, 6mm x 23mm blade

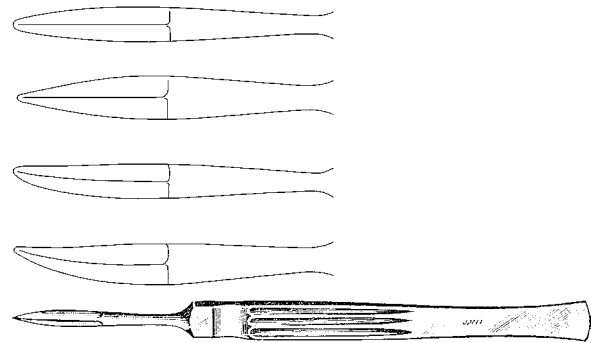

Joseph Button End Knife

6" (155mm)

Catalog #	Description
410-120	Straight, 29mm blade

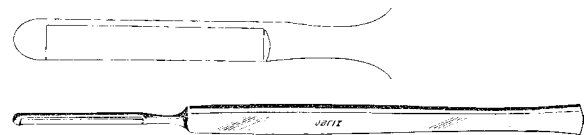

Joseph Button End Knife

6 3/4" (170mm)

Catalog #	Description
410-121	Angled, 9.5mm blade

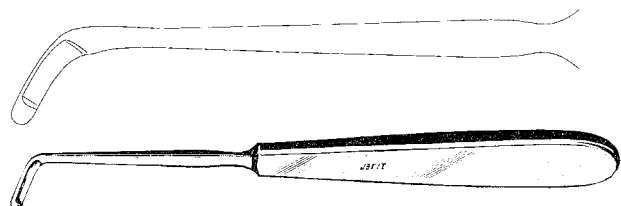

Converse Button End Bistoury

6 1/8" (155mm)

Catalog #	Description
410-123	Curved, 29mm blade

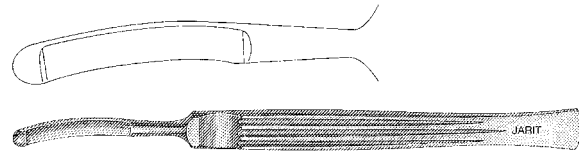

Maltz Button End Knife

6 3/4" (170mm)

Catalog #	Description
410-125	9mm blade

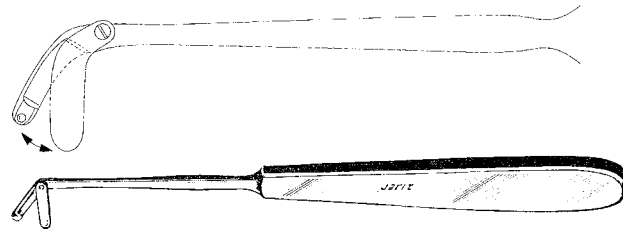

Cottle Nasal Knife

5 3/8" (142mm)

Catalog #	Description
410-128	4mm blade

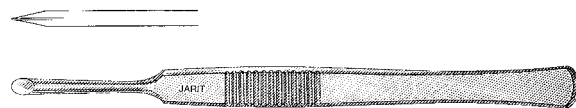

Cottle Double Edged Knife

6" (155mm)

Catalog #	Description
410-130	Straight, 6mm x 24mm blade

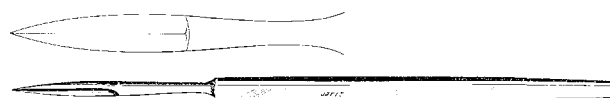

O'Connor Hook

Catalog #	Description
350-360	5" (127mm)

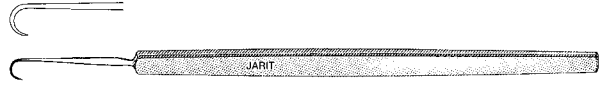

Guthrie Hooks

4³/₄" (121mm)

Catalog #	Description
350-370	Small: 1.5mm wide
350-371	Large: 2.5mm wide

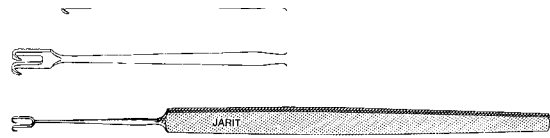

Kleinert-Kutz Skin Hooks

6" (152mm)

Catalog #	Description
410-135	Small: 3mm
410-136	Medium: 5mm
410-137	Large: 7mm

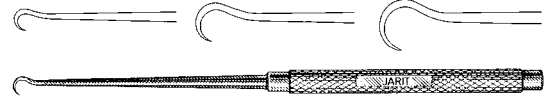

Wiener Skin Hook

5" (127mm)

Catalog #	Description
410-140	4.5mm fine tip

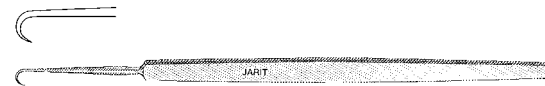

Cottle Skin Hooks

5³/₈" (135mm)

Catalog #	Description
410-145	Shallow curve, small, 3.6mm tip length
410-146	Deep curve, small, 2.8mm tip length
410-147	Deep curve, large, 4mm tip length

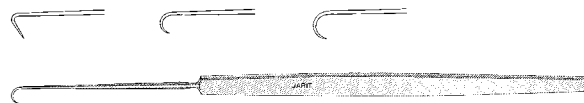

Joseph Skin Hook

6¼" (160mm)

Catalog #	Description
410-150	Single prong

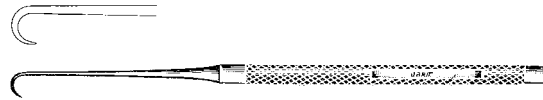

Joseph Skin Hooks

6¼" (159mm), double prong, widths are tip to tip

Catalog #	Description
410-151	2mm wide
410-152	5mm wide
410-153	7mm wide
410-154	10mm wide

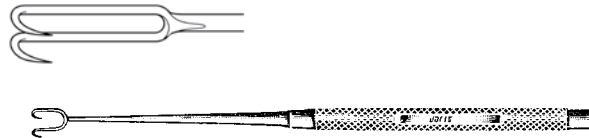

Cottle-Joseph Double Hook

5¾" (146mm)

Catalog #	Description
410-157	Double prong, 12mm wide

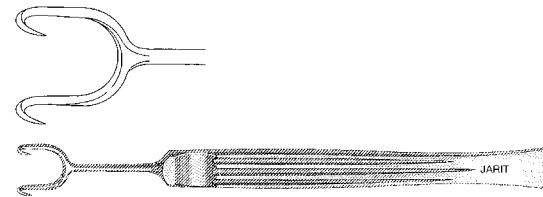

Kilner Skin Hook

5⅛" (130mm)

Catalog #	Description
410-160	2.4mm tip



Kilner Skin Hook

6" (152mm)

Catalog #	Description
410-161	2.5mm detachable hook



Goldman Single Hook

5⅜" (137mm)

Catalog #	Description
410-163	Right angled

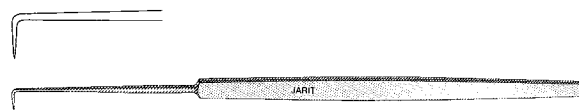

Converse Skin Hook

7¼" (182mm)

Catalog #	Description
410-165	Small: 2.4mm tip
410-166	Large: 4.2mm tip



Johnson Skin Hook

6½" (165mm)

Catalog #	Description
410-167	5mm tip

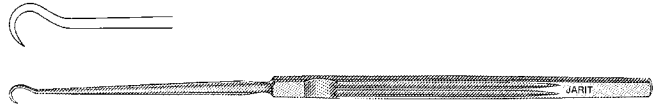

Gilles Skin Hook

7¼" (185mm)

Catalog #	Description
410-170	2.9mm tip



Cottle Single Prong Tenaculum

6½" (167mm)

Catalog #	Description
410-180	10mm tip

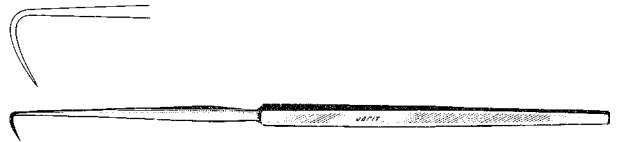

Blair Palate Hook-Sharp

8" (200mm)

Catalog #	Description
410-182	8.8mm tip

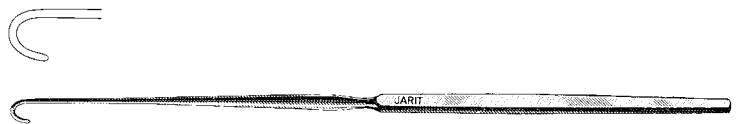

Suraci Zygoma Hook-Elevator

9¼" (233mm)

Catalog #	Description
410-183	21mm wide tip

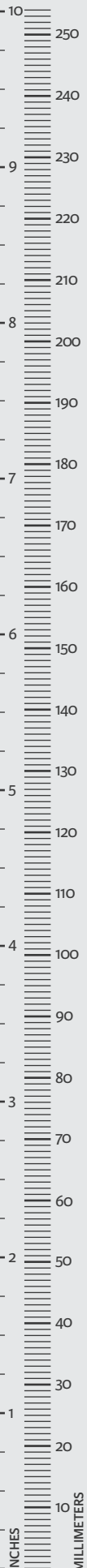
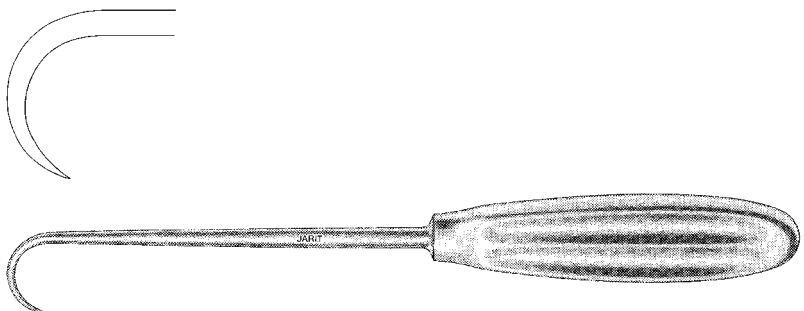

Lahey Retractors

4¾" (121mm), delicate

Catalog #	Description
410-185	1-prong
410-186	2-prongs
410-187	3-prongs

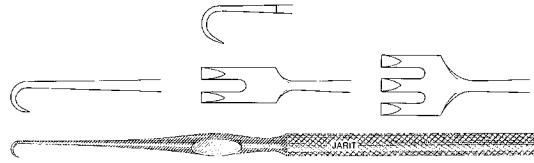

Goldman Knife Guides and Retractors

7" (178mm), double ended,
3mm knife guide and 11mm retractor

Catalog #	Description
410-193	Left angled knife guide
410-194	Right angled knife guide

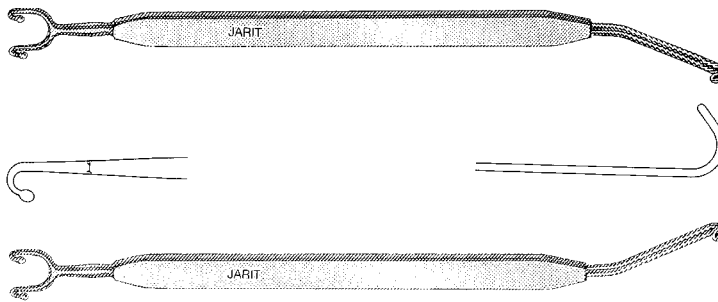

Cottle Knife Guide and Retractor

8" (203mm)

Catalog #	Description
410-195	Double-ended, 3mm knife guide and 13mm retractor

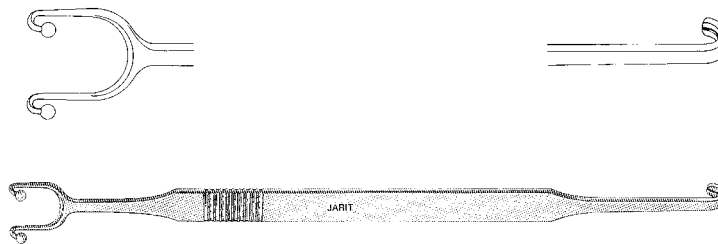

Neivert Knife Guide and Retractor

7¼" (196mm)

Catalog #	Description
410-196	Double-ended, 4mm knife guide and 17.5mm retractor

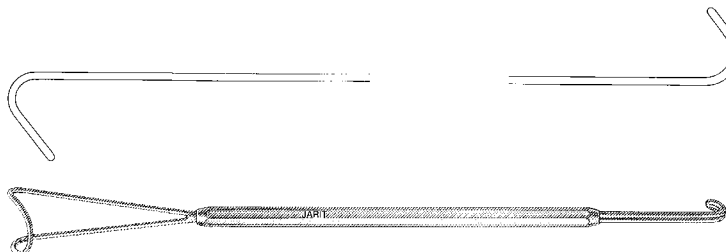

Cottle Retractors

5¾" (145mm), 11mm wide

Catalog #	Description
410-197	Right prong sharp
410-198	Left prong sharp

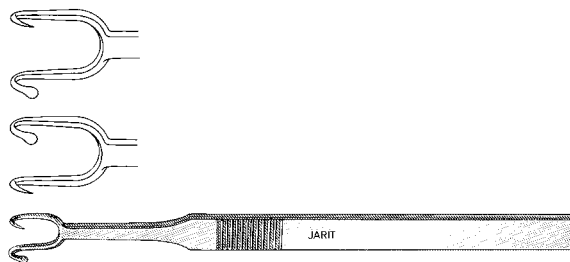

Fomon Retractors

6¼" (160mm)

Catalog #	Description
410-199	1-prong, ball end, 6mm deep tip
410-200	2-prong, ball ends, 10mm wide

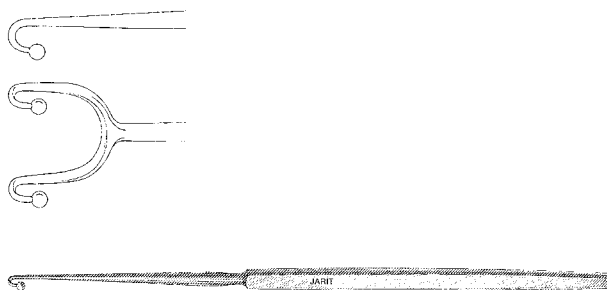

Cottle Retractor

5¾" (145mm)

Catalog #	Description
410-201	2-prong, sharp, 12mm wide

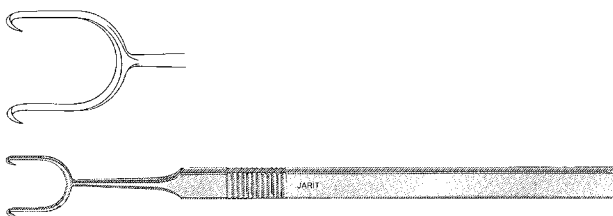

Cottle Retractor

6½" (166mm)

Catalog #	Description
410-202	2-prong, ball ends, 12.5mm wide

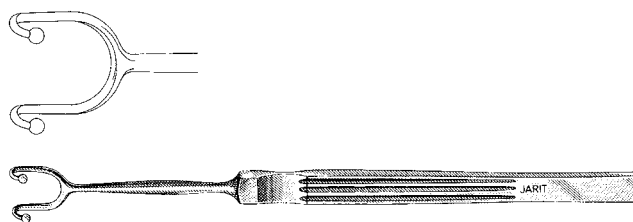

Cottle Retractor

5½" (140mm)

Catalog #	Description
410-203	4-prong, blunt, 8.2mm wide

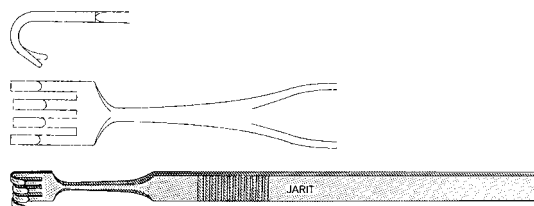

Converse Alar Retractor

4⁵/₈" (117mm)

Catalog #	Description
410-205	Double-ended, 12.5 x 16mm wide

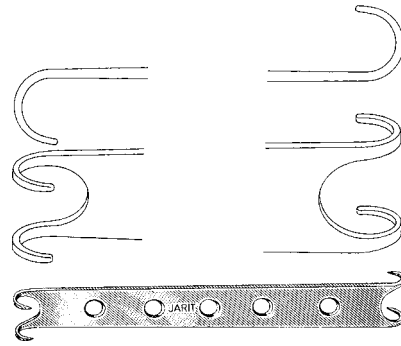

Cottle Alar Retractor

6¹/₄" (160mm)

Catalog #	Description
410-207	12mm wide

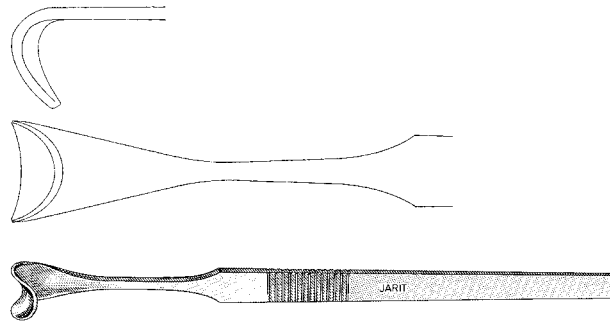

Aufricht Nasal Retractors

7¹/₄" (184mm)

Catalog #	Description
410-210	10mm x 45mm blade
410-211	11mm x 60mm blade

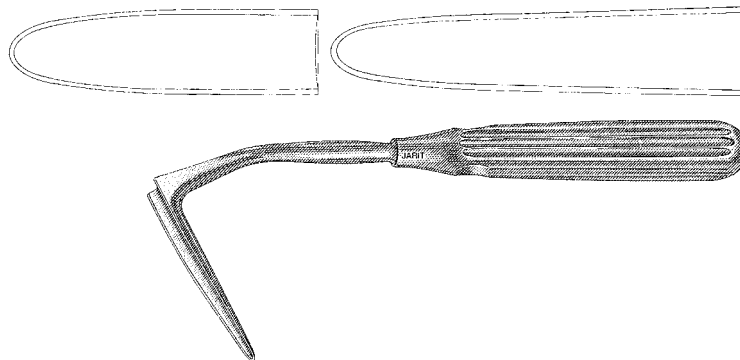

Aufricht Nasal Retractor

6³/₄" (173mm)

Catalog #	Description
410-212	11mm x 47mm fenestrated blade

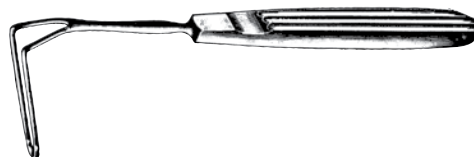

Maliniac Nasal Retractor

4 1/8" (104mm)

Catalog #	Description
410-215	9mm x 45mm blade

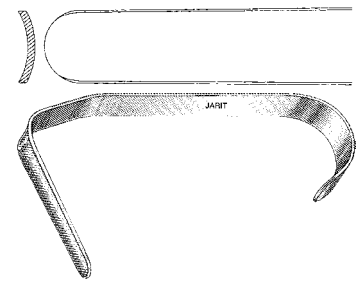

Converse Nasal Retractor

4 1/4" (109mm)

Catalog #	Description
410-218	11mm x 44mm blade

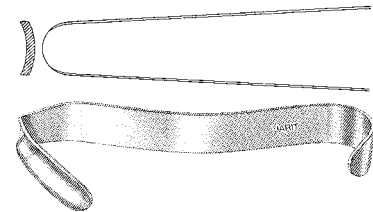

Senn Retractors, (Satin Finish)

6 1/4" (160mm),

double-ended, 8mm wide, solid blade 3/4" x 1/4" (19mm x 6.3mm),

Manufactured from high grade German surgical stainless steel which is ground and polished to a satin finish

Catalog #	Description
190-110	3-prong, sharp
190-112	3-prong, blunt

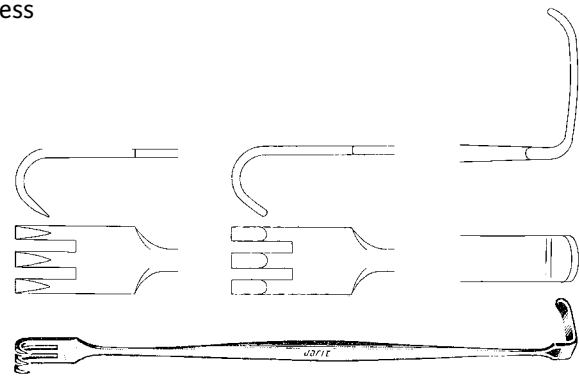

Senn Retractors, (Matte Finish)

6 1/4" (160mm),

double-ended, 8mm wide, solid blade 3/4" x 1/4" (19mm x 6.3mm),

Manufactured from high grade German surgical stainless steel which is glass beaded to a matte finish

Catalog #	Description
189-110	3-prong, sharp
189-112	3-prong, blunt

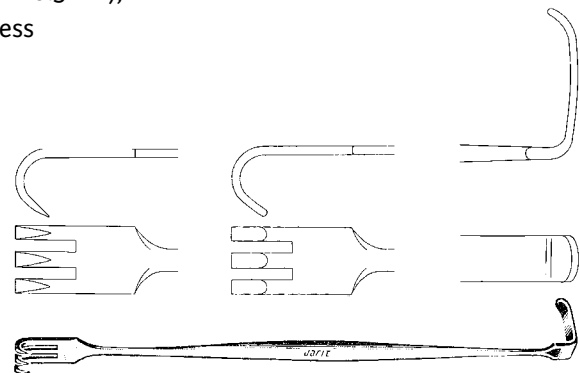

Mathieu Retractors

6¼" (160mm), double-ended, 8mm wide,
solid blade ¾" x ¼" (19mm x 6.3mm)

Catalog #	Description
190-115	6¼" (160mm), 3-prong, sharp
190-116	6¼" (160mm), 3-prong, blunt

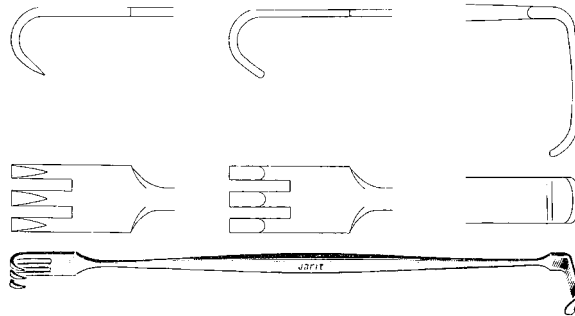

Rollet Retractor

5¼" (132mm)

Catalog #	Description
190-118	4 sharp prongs, 6mm blade

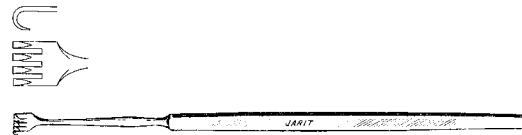

Knapp Retractor

5¼" (132mm)

Catalog #	Description
190-120	4 blunt prongs, 6mm blade

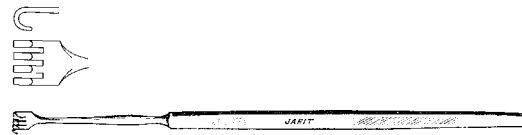

Meyerding Skin Hook and Retractor

6" (155mm)

Catalog #	Description
190-129	Solid blade, ⅝" x ⅜" wide (16mm x 5mm)

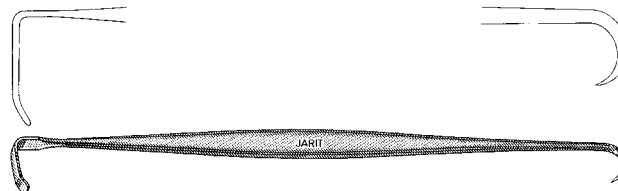

Meyerding Finger Retractors

7" (175mm)

Catalog #	Description
190-130	Style 1, 1 ³ / ₁₆ " x 9 ⁹ / ₃₂ " wide (21mm x 7.1mm)
190-131	Style 2, 5 ⁵ / ₈ " x 3 ³ / ₁₆ " wide (16mm x 5mm)
190-132	Style 3, 1 ¹ / ₄ " x 5 ⁵ / ₃₂ " wide (6.3mm x 4mm)
190-133	Style 4, 3 ³ / ₈ " x 1 ¹ / ₈ " wide (10mm x 3.2mm)
190-134	Style 5, 5 ⁵ / ₁₆ " x 5 ⁵ / ₃₂ " wide (8mm x 4mm)
190-135	Style 6, 1 ¹ / ₄ " x 5 ⁵ / ₁₆ " wide (6.3mm x 8mm)

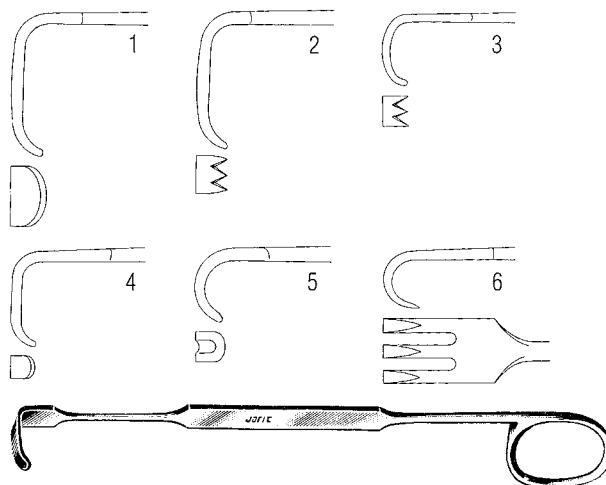

Finger Rake Retractors

6 1/2" (165mm)

Catalog #	Description
190-150	1 prong, sharp
190-151	2 prongs, sharp, 5mm wide
190-152	3 prongs, sharp, 9mm wide
190-153	4 prongs, sharp, 12mm wide
190-154	1 prong, blunt
190-155	2 prongs, blunt, 5mm wide
190-156	3 prongs, blunt, 9mm wide
190-157	4 prongs, blunt, 12mm wide

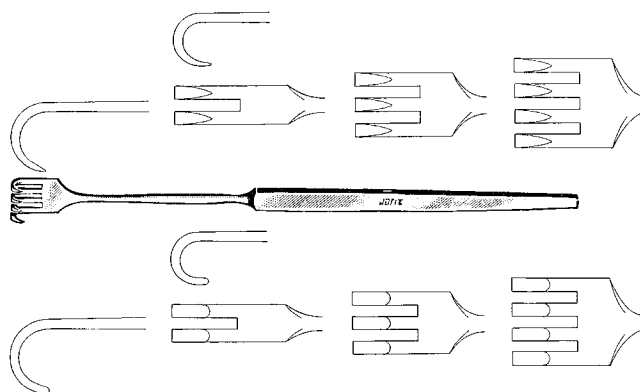

Ragnell Retractor

5" (152mm)

Catalog #	Description
410-220	Double-ended, 2.85mm x 8.2mm and 5.6mm x 14.75mm blades

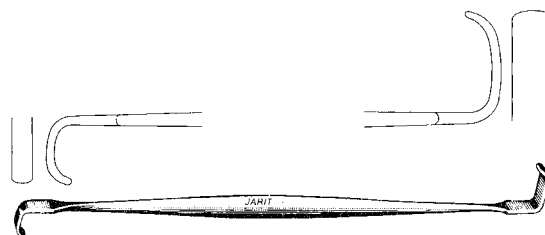

Miller Retractors

5¼" (133mm), 9 prongs, 16mm wide

Catalog #	Description
410-225	Blunt
410-226	Sharp

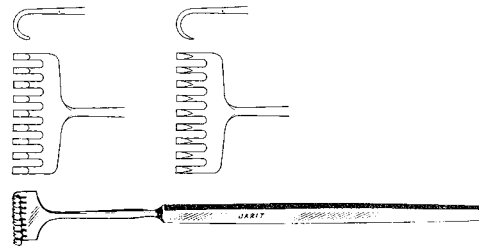

Davis Retractor

5¾" (145mm)

Catalog #	Description
410-230	Double-ended, Small blade ¾" x ¼" (20mm x 5.8mm) and Large blade 1" x ⅜" (25mm x 8.75mm)

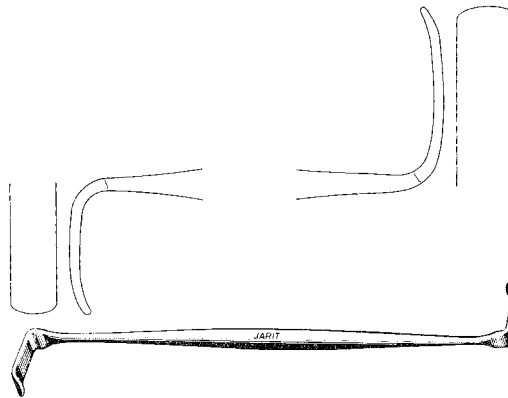

Converse Blade Retractors

3⅝" (93mm)

Catalog #	Description
410-235	Size 1: 9mm x 18mm blade
410-236	Size 2: 13mm x 28mm blade
410-237	Size 3: 13mm x 41mm blade
410-238	Size 4: 13mm x 55mm blade

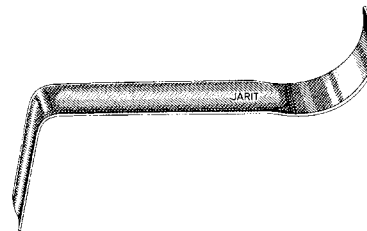

Alm Retractor

Catalog #	Description
205-100	2¾" (70mm), 2" (50mm) spread

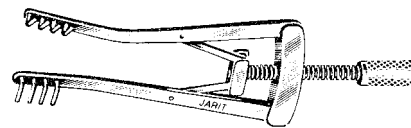

Alm Retractor

Catalog #	Description
205-105	3⅞" (100mm), 2½" (64mm) spread

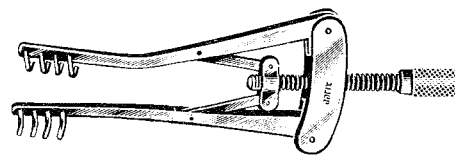

Heiss Automatic Skin Retractors

3 7/8" (100mm), 1" (25mm) spread

Catalog #	Description
205-110	Sharp prongs
205-111	Blunt prongs

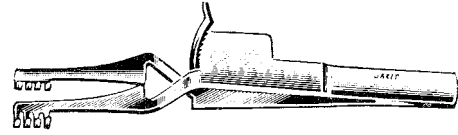

Gelpi Perineal Retractors, (Satin Finish)

Manufactured from high grade German surgical stainless steel which is ground and polished to a satin finish

Catalog #	Description
205-123	3 7/8" (97mm)
205-124	4 5/8" (117mm)
205-125	5 1/8" (130mm)

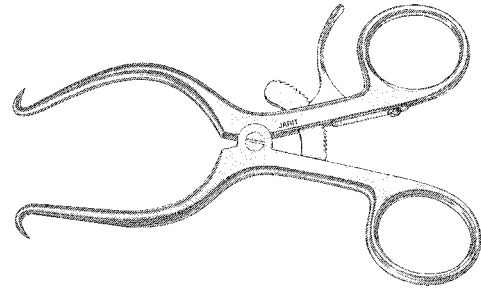

Gelpi Perineal Retractors, (Matte Finish)

Manufactured from high grade German surgical stainless steel which is glass beaded to a matte finish

Catalog #	Description
204-123	3 3/4" (95mm)
204-124	4 3/4" (120mm)
204-125	5 1/4" (133mm)

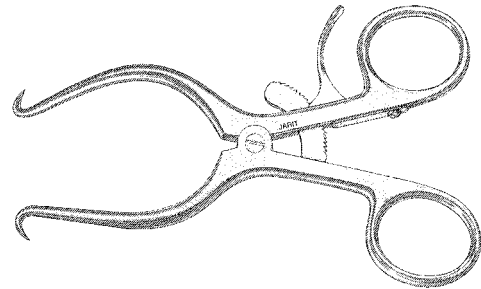

Gelpi Perineal Retractor Parts

Catalog #	Description
205-SPS-123	Replacement Spring and Screw
205-SPS-124	Replacement Spring and Screw

Spring Wire Retractors

Catalog #	Description
205-136	Style 1: 3" (75mm)
205-137	Style 2: 3 1/2" (90mm)
205-138	Style 3: 4 1/2" (115mm)

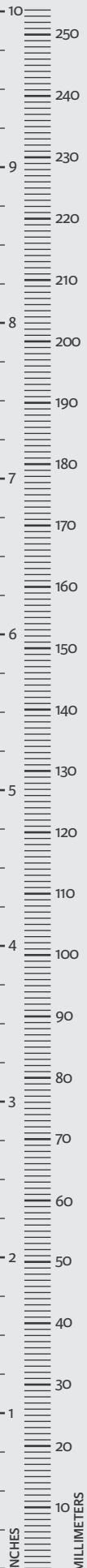
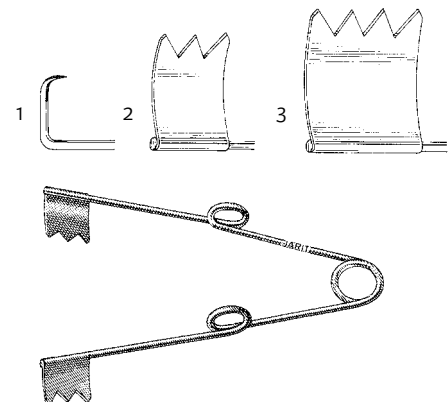

Weitlaner Retractors, (Satin Finish)

Manufactured from high grade German surgical stainless steel which is ground and polished to a satin finish

Catalog #	Description
205-140	4 ³ / ₈ " (110mm), 2 x 3 sharp prongs, 15mm deep
205-141	4 ³ / ₈ " (110mm), 2 x 3 blunt prongs, 15mm deep
205-150	5 ³ / ₈ " (135mm), 3 x 4 sharp prongs, 17mm deep
205-151	5 ³ / ₈ " (135mm), 3 x 4 blunt prongs, 17mm deep
205-155	6 ¹ / ₂ " (165mm), 3 x 4 sharp prongs, 18mm deep
205-156	6 ¹ / ₂ " (165mm), 3 x 4 blunt prongs, 18mm deep

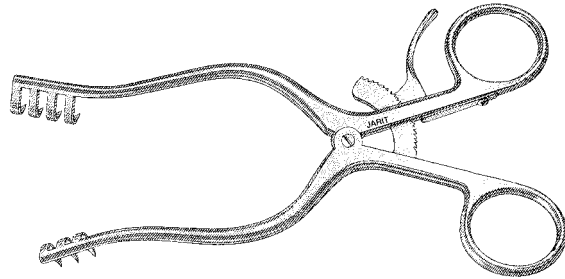

Weitlaner Retractors, (Matte Finish)

Manufactured from high grade German surgical stainless steel which is glass beaded to a matte finish

Catalog #	Description
204-140	4 ³ / ₈ " (110mm), 2 x 3 sharp prongs, 15mm deep
204-141	4 ³ / ₈ " (110mm), 2 x 3 blunt prongs, 15mm deep
204-150	5 ³ / ₈ " (135mm), 3 x 4 sharp prongs, 17mm deep
204-151	5 ³ / ₈ " (135mm), 3 x 4 blunt prongs, 17mm deep
204-155	6 ¹ / ₂ " (165mm), 3 x 4 sharp prongs, 18mm deep
204-156	6 ¹ / ₂ " (165mm), 3 x 4 blunt prongs, 18mm deep

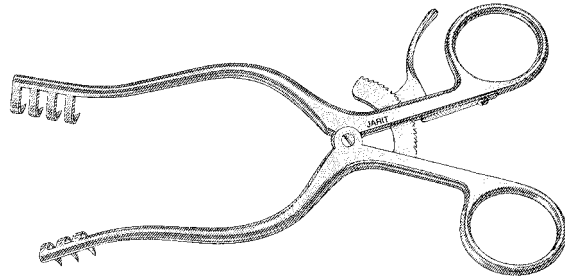

Weitlaner Retractor Replacement Parts

Catalog #	Description
205-SPS-140	Replacement Spring and Screw
205-SPS-141	Replacement Spring and Screw
205-SPS-150	Replacement Spring and Screw
205-SPS-151	Replacement Spring and Screw
205-SPS-155	Replacement Spring and Screw
205-SPS-156	Replacement Spring and Screw
205-SPS-160	Replacement Spring and Screw
205-SPS-161	Replacement Spring and Screw

Weitlaner Retractors

hinged blades

Catalog #	Description
205-175	5 ¹ / ₂ " (140mm), 3 x 4 sharp prongs, 18mm deep
205-176	5 ¹ / ₂ " (140mm), 3 x 4 blunt prongs, 18mm deep
205-180	6 ¹ / ₂ " (162mm), 3 x 4 sharp prongs, 18mm deep
205-181	6 ¹ / ₂ " (162mm), 3 x 4 blunt prongs, 18mm deep

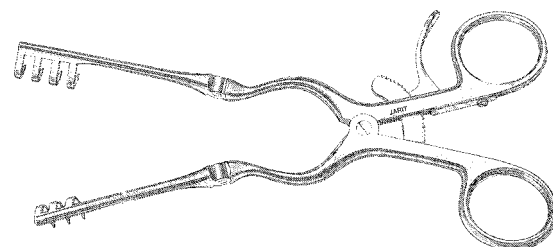

Deschamps Ligature Carriers

Catalog #	Description
125-150	8" (203mm), sharp, left
125-152	8" (203mm), sharp, right
125-154	8" (203mm), blunt, left
125-155	8" (203mm), blunt, right

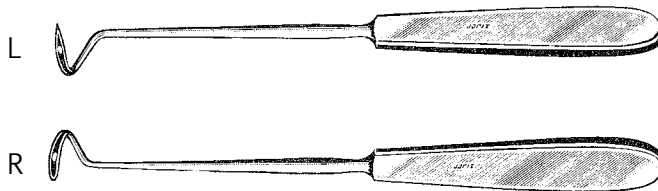

Dingman Wire Passer

Catalog #	Description
410 -265	6¾" (170mm), curved, 2.5mm OD



Dingman Mouth Gag

Catalog #	Description
450 -090	Complete with 3 tongue blades

Dingman Tongue Blades

Catalog #	Description
450-091	Small blade: 25mm wide x 62mm deep x 136mm long
450-092	Medium blade: 29mm wide x 65mm deep x 136mm long
450-093	Large blade: 32mm wide x 75mm deep x 136mm long
450-FRM-090	Replacement Frame (70mm x 144mm)
450-WSR-090	Replacement Washer for Side Blade
450-BLD-090	Replacement Side Blade
450-SBA-090	Replacement Side Blade Attachment
450-SRW-090	Replacement Screws Pkg/8ea

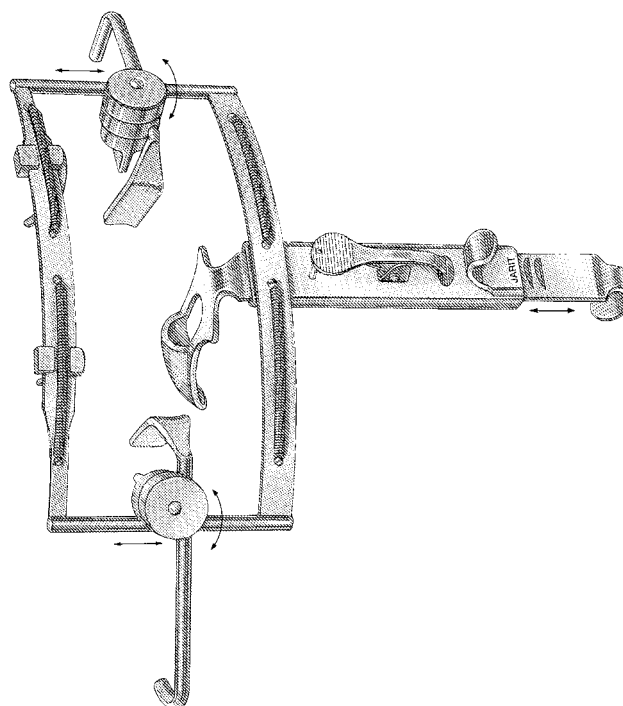

Anderson-Neivert Osteotomes

with guard, 8" (205mm), 4mm wide

Catalog #	Description
410-275	Curved left
410-276	Curved right

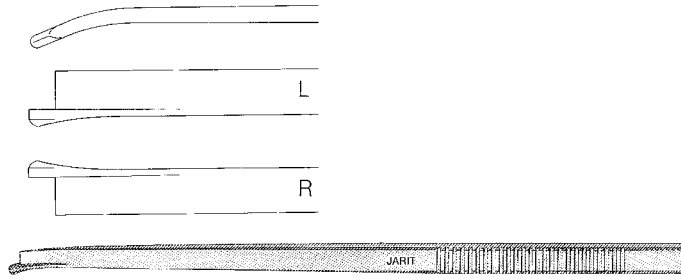

Converse Osteotomes

7" (180mm)

Catalog #	Description
410-280	2mm wide
410-281	4mm wide
410-282	6mm wide
410-283	8mm wide
410-284	10mm wide
410-286	12mm wide
410-288	14mm wide

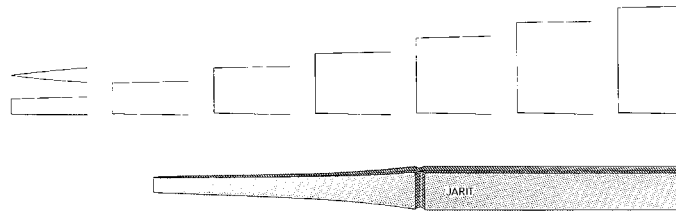

Cottle Chisels

7¼" (184mm), depth marking at 20mm, 30mm, 40mm and 50mm

Catalog #	Description
410-290	4mm wide
410-291	7mm wide
410-292	9mm wide
410-293	12mm wide

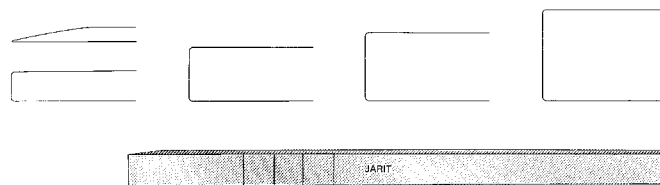

Cottle Chisel

7¼" (185mm)

Catalog #	Description
410-295	Curved, 6mm wide, depth markings at 36, 46, 56 and 66 millimeters

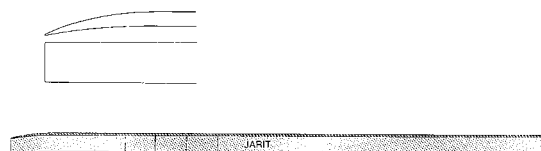

Fomon Chisel

with guard, 6½" (165mm), 7mm wide

Catalog #	Description
410-296	Straight

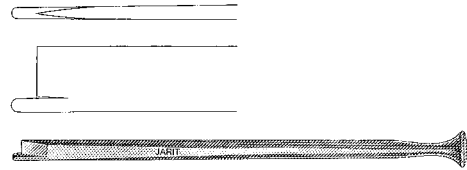

Converse Chisels

with guard, 7¾" (195mm), 6mm wide

Catalog #	Description
410-297	Curved right
410-298	Curved left



Silver Osteotomes

with guard, 6¾" (172mm), 4mm wide

Catalog #	Description
410-300	Straight
410-301	Curved right
410-302	Curved left

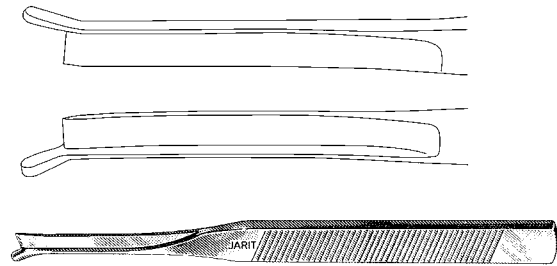

Cinelli Osteotomes

double-guarded, 6¼" (160mm), 4mm wide

Catalog #	Description
410-305	10mm wide, straight
410-306	12mm wide, straight
410-307	14mm wide, straight
410-308	16mm wide, straight
410-310	10mm wide, curved

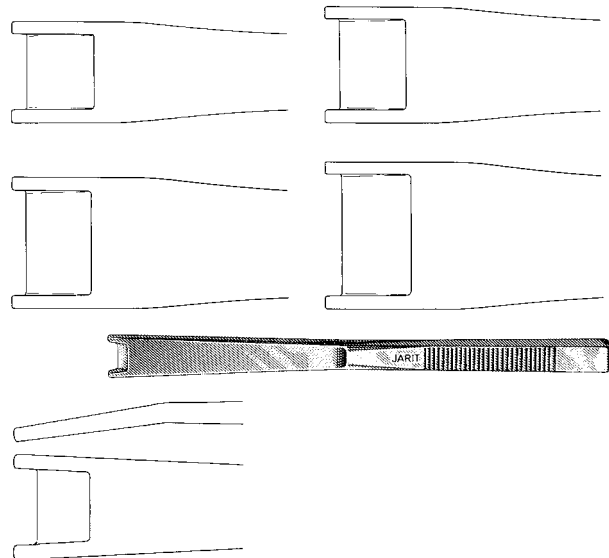

Parkes Osteotome

with guard, 6¼" (160mm), 4mm wide

Catalog #	Description
410-312	Straight

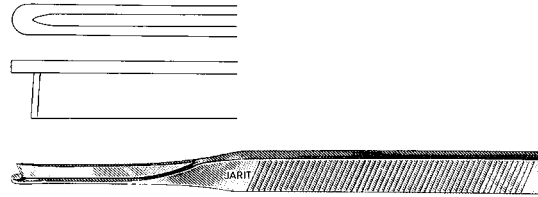

Parkes Hump Gouge

with guard, 7" (177mm), 6mm wide

Catalog #	Description
410-313	Double-guarded, straight

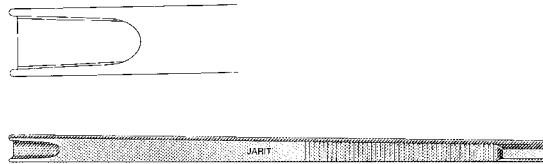

Neivert Osteotome

with guard, 8" (203mm), 5mm wide

Catalog #	Description
410-314	Straight



Rubin Osteotomes

6½" (165mm), with finger grip, rounded corners

Catalog #	Description
410-316	16mm wide
410-317	14mm wide
410-318	11mm wide

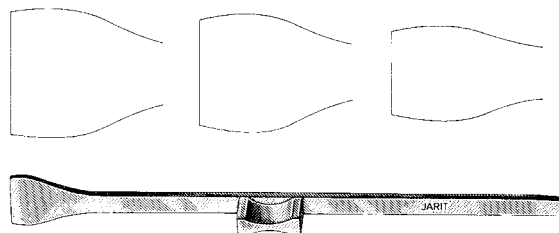

Hexagonal Handle Osteotomes

5 7/8" (150mm)

Catalog #	Description
410-319	2mm wide
410-320	3mm wide
410-321	4mm wide
410-322	5mm wide
410-323	6mm wide
410-324	7mm wide
410-325	8mm wide
410-326	9mm wide
410-327	10mm wide
410-328	11mm wide
410-329	12mm wide

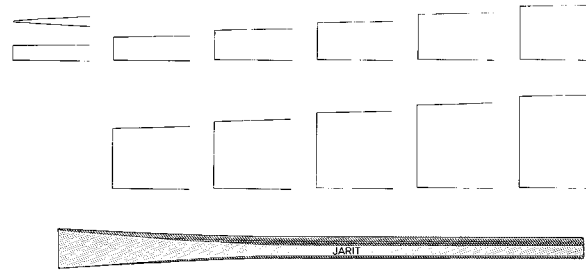

Copper Head Mallet

7 1/4" (182mm)

Catalog #	Description
410-330	Copper head: weight 2.5 oz., diameter 3/4" (20mm)

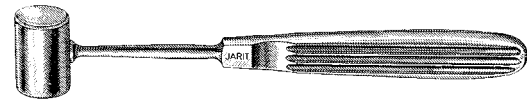

Mallet w/Nylon Head

7 1/4" (187mm), 2 replaceable nylon caps

Catalog #	Description
250-398	Anodized aluminum handle, head: weight 4 oz., diameter 1" (25mm)

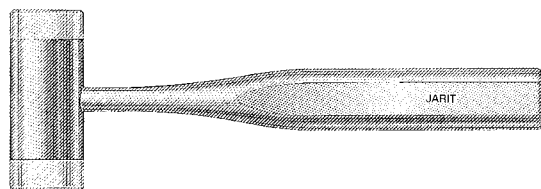

Mallet w/Nylon Head

7 1/4" (187mm), 1 replaceable nylon cap, 1 stainless steel facing

Catalog #	Description
250-399	Anodized aluminum handle, head: weight 5 oz., diameter 1" (25mm)

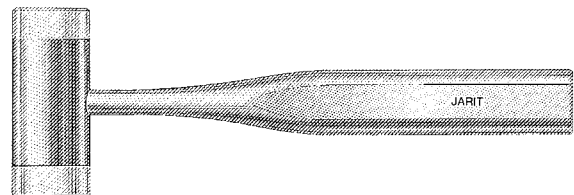

Nylon Cap

Catalog #	Description
250-410	For 250-398 and 250-399

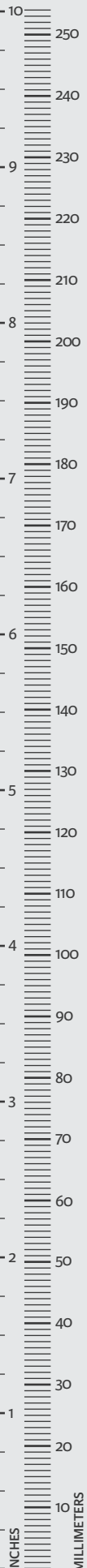

Converse Osteotomes

with guard, 7¾" (195mm), straight

Catalog #	Description
410-332	4mm wide
410-333	5mm wide

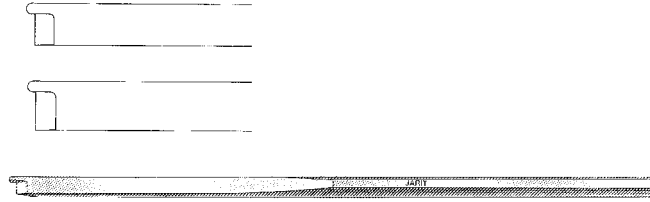

Cottle Osteotomes

7" (180mm), with mm depth marking, in 10mm increments up to 80mm

Catalog #	Description
410-345	4mm wide
410-346	6mm wide
410-347	8mm wide
410-348	10mm wide
410-349	12mm wide

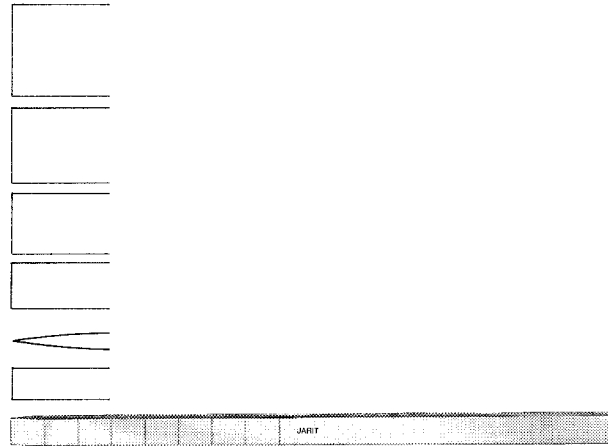

Cottle Mallet

7" (178mm)

Catalog #	Description
410-335	Black aluminum handle, one flat face and one round face, head: weight 7 oz., diameter 1⅞" (30mm)

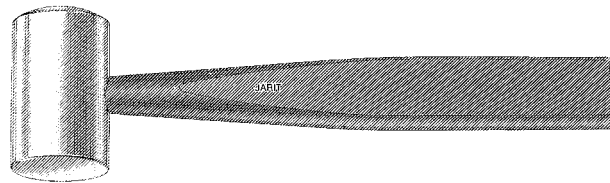

Quisling Intra-nasal Hammer

7" (180mm)

Catalog #	Description
410-340	7.5mm head

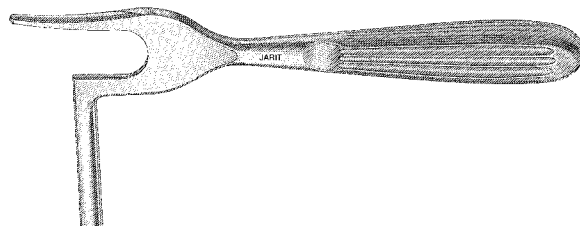

Ragnell Undermining Scissors

5¼" (133mm), 17mm flat tip blades

Catalog #	Description
415-100	Straight
415-101	Half curve
415-102	Full curve

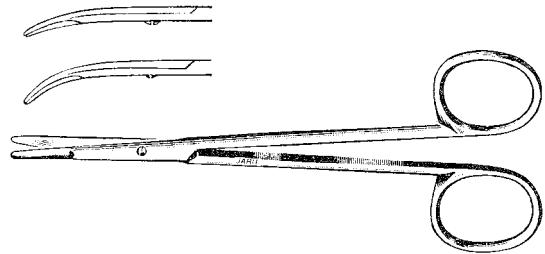

Cinelli Lower Lateral Scissors

4⅝" (116mm), 22mm blades

Catalog #	Description
415-105	Full curve

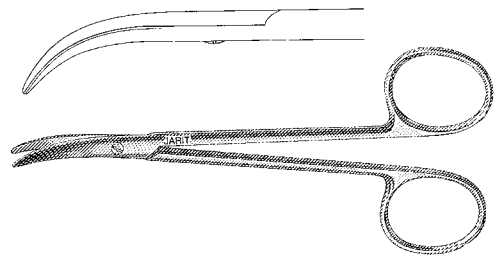

Fomon Lower Lateral Scissors

4½" (114mm), 24mm blades

Catalog #	Description
415-110	Full curve

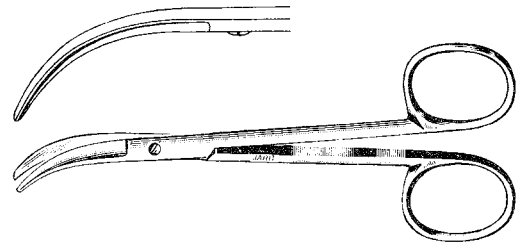

Lower Lateral Scissors

6½" (168mm), 19mm blades

Catalog #	Description
415-112	Full curve

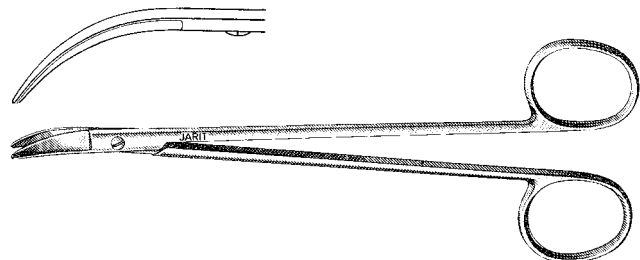

Dorsal Scissors

4⁵/₈" (119mm)

Catalog #	Description
415-114	Straight, 30mm blades

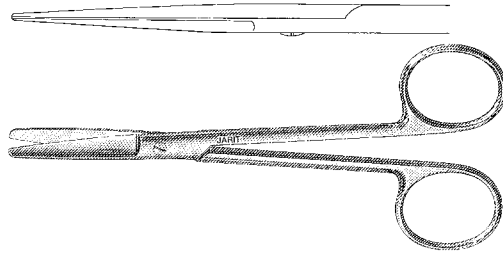

Fomon Dorsal Scissors

5³/₄" (146mm)

Catalog #	Description
415-115	Angled handles, 35mm blades

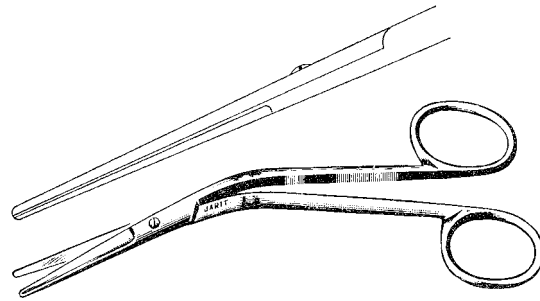

Goldman Dorsal or Septum Scissors

5³/₄" (146mm)

Catalog #	Description
415-116	Angled handles, 40mm serrated blades

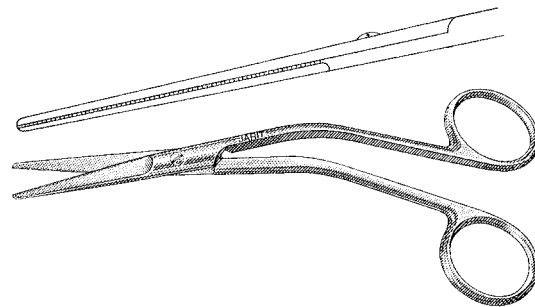

Cottle Dorsal Scissors

5³/₄" (146mm)

Catalog #	Description
415-117	Heavy, angled handles, 55mm length blades

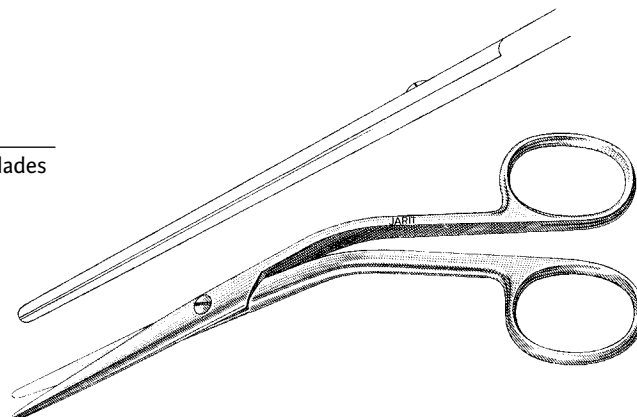

Caplan Nasal Bone Scissors

8" (203mm)

Catalog #	Description
415-118	Double action, 22mm serrated blades

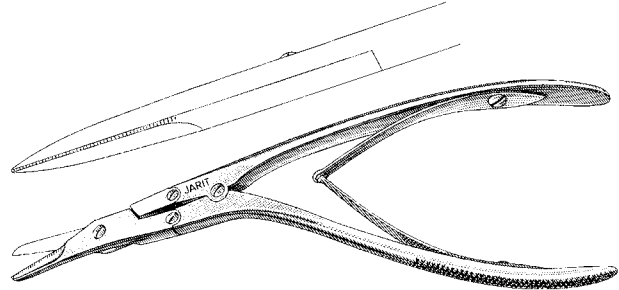

Cottle Septum Scissors

7¼" (187mm)

Catalog #	Description
415-119	Angled handles, 44mm serrated blades

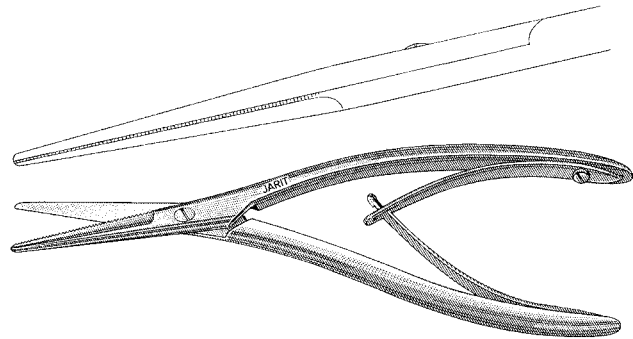

Miller Dissecting Scissors

5" (128mm)

Catalog #	Description
415-120	32mm semi-sharp outer edge blades

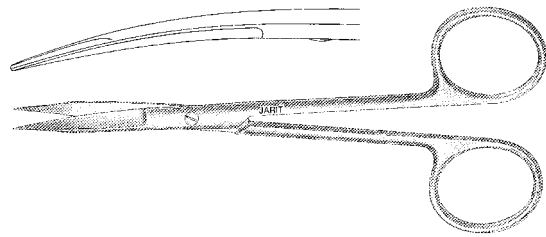

Kaye Dissecting Scissors

4⅛" (106mm)

Catalog #	Description
415-121	Curved, 22mm serrated blades

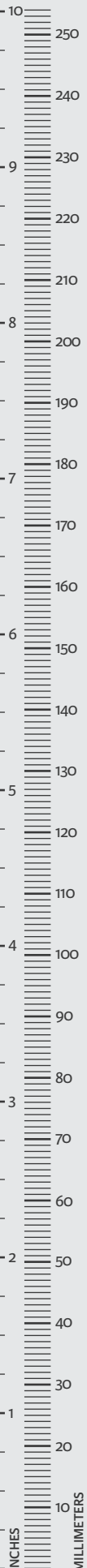
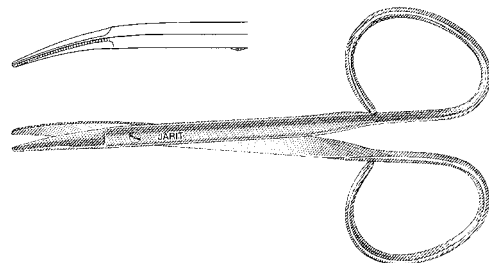

Fomon Saber Back Scissors

5³/₈" (136mm)

Catalog #	Description
415-123	Curved, 29mm semi-sharp outer edge blades

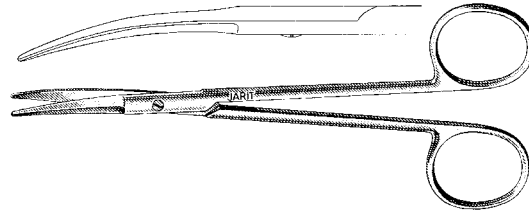

Goldman Nasal Scissors

5⁵/₈" (143mm)

Catalog #	Description
415-124	Curved, 29mm semi-sharp outer edge blades

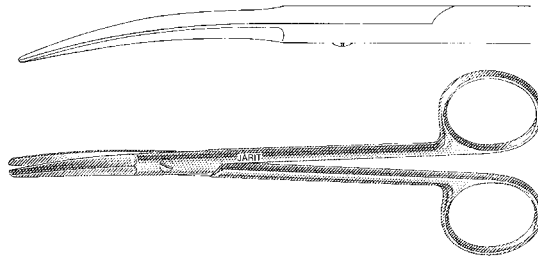

Aufricht Nasal Scissors

5³/₄" (146mm)

Catalog #	Description
415-125	Curved, 43mm semi-sharp outer edge blades

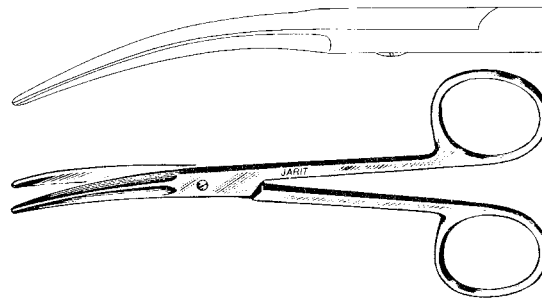

Jackson Nasal Bone Scissors

7³/₄" (200mm)

Catalog #	Description
415-127	Angled, heavy pattern

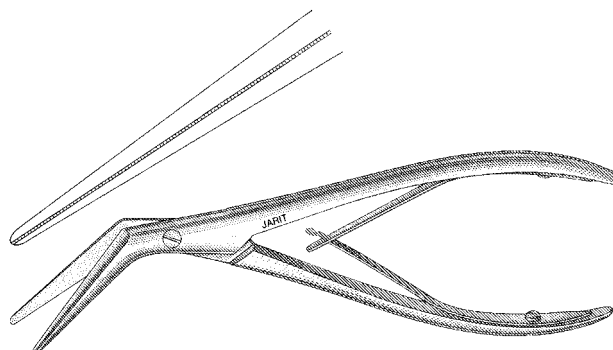

Becker Septum Scissors

7¼" (183mm)

Catalog #	Description
415-130	22mm serrated blades

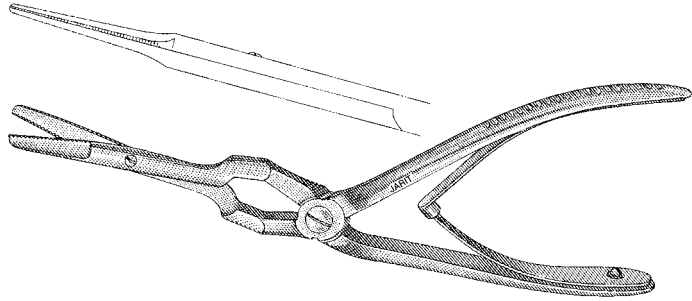

Gorney Turbinate Scissors

8¼" (210mm)

Catalog #	Description
415-133	Double action, 35mm serrated blades

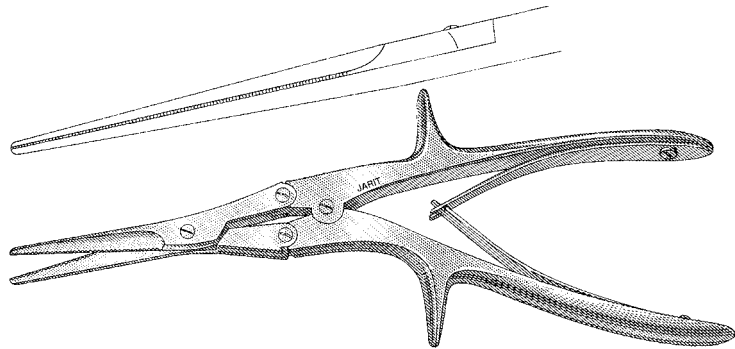

Brophy Gum and Suture Scissors

5¾" (146mm), 35mm sharp blades

Catalog #	Description
415-140	Straight
415-141	Curved

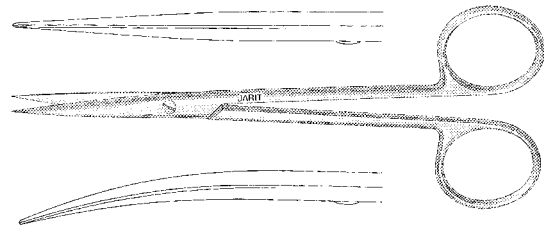

Littler Suture Carrying Scissors

4¾" (120mm)

Catalog #	Description
415-145	22mm curved blades

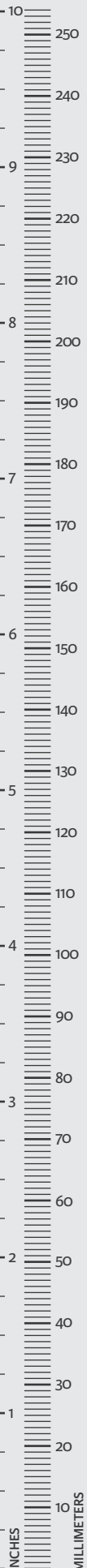
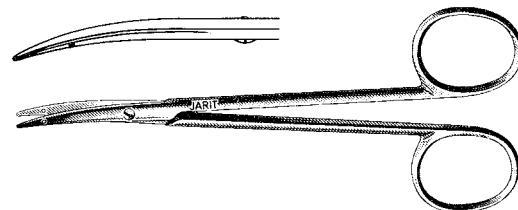

Brown Dissecting Scissors

5¾" (146mm), heavy handles, 42.5mm narrow blades

Catalog #	Description
415-150	Straight
415-152	Curved

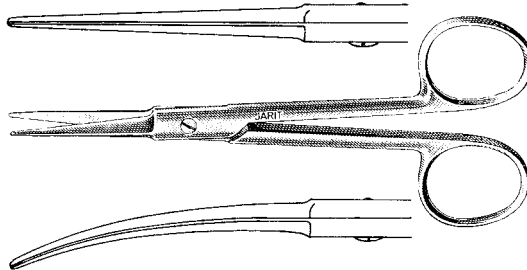

Brown Dissecting Scissors

5½" (139mm), 35mm length blades

Catalog #	Description
415-170	Straight
415-172	Curved

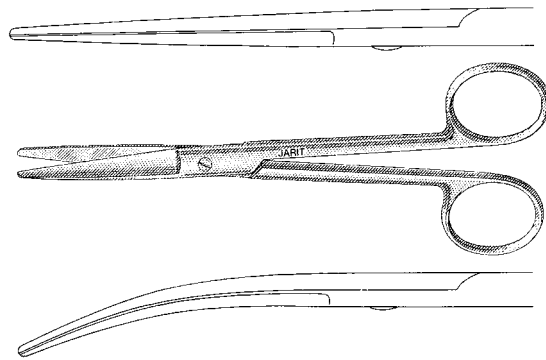

Metzenbaum-Lahey Scissors, (Mirror Finish)

Manufactured from high grade German surgical stainless steel which is ground and polished to a mirror finish

Catalog #	Description
100-250	5⅞" (149mm), straight
100-251	5⅞" (149mm), curved

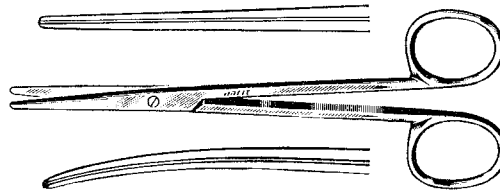

Metzenbaum-Lahey Scissors, (Matte Finish)

Manufactured from high grade German surgical stainless steel which is glass beaded to a matte finish

Catalog #	Description
099-250	5⅞" (149mm), straight
099-251	5⅞" (149mm), curved

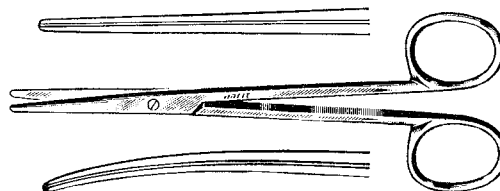

Metzenbaum Scissors

7" (178mm), (Mirror Finish)

Catalog #	Description
100-261	Curved, slender, delicate

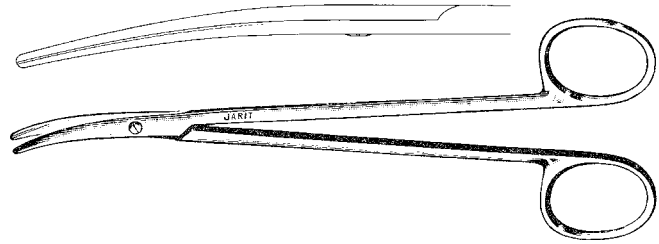

Metzenbaum-Baby Scissors

5 1/4" (135mm), delicate, (Mirror Finish)
dissecting tips

Catalog #	Description
100-269	Straight
100-270	Curved

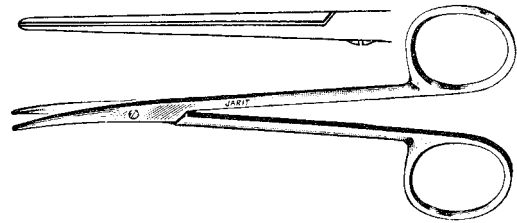

Metzenbaum-Lahey Scissors

5 5/8" (143mm), (Mirror Finish)

Catalog #	Description
100-272	Curved, delicate

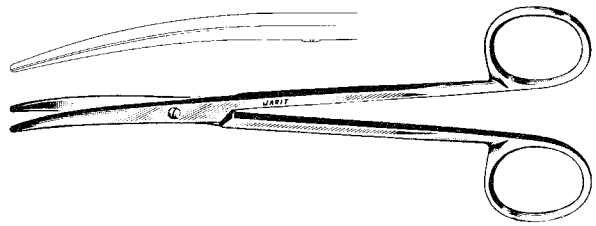

Joseph Scissors

5 5/8" (143mm)

Catalog #	Description
100-278	Straight
100-279	Curved

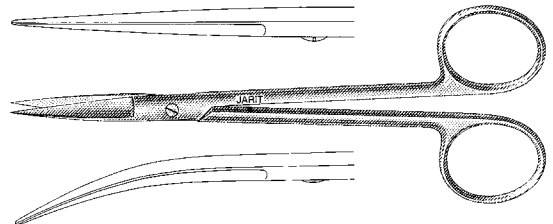

Flat Tip Scissors

curved

Catalog #	Description
100-290	5 3/8" (137mm)
100-291	7" (178mm)

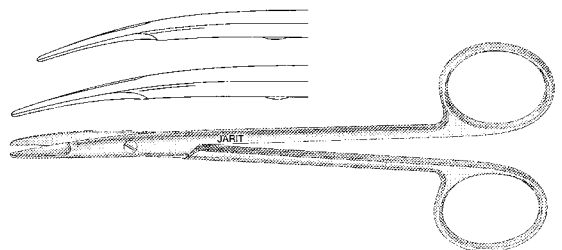

Plastic Surgery Scissors

4⁷/₈" (124mm), 33mm blades, sharp-blunt

Catalog #	Description
100-320	Straight
100-322	Curved

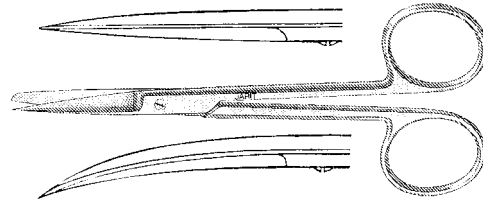

Plastic Surgery Scissors

4⁷/₈" (124mm), 33mm blades, sharp-sharp

Catalog #	Description
100-325	Straight
100-327	Curved

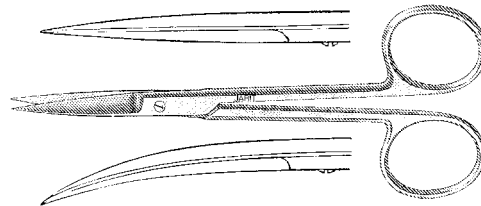

Plastic Surgery Scissors

4⁷/₈" (124mm), 33mm blades, blunt-blunt

Catalog #	Description
100-330	Straight
100-332	Curved

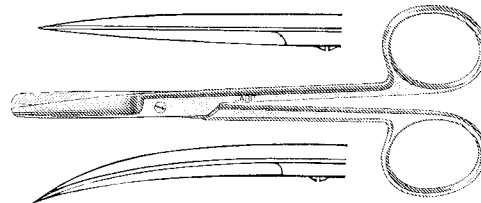

O'Brien Suture Scissors

3⁷/₈" (100mm)

Catalog #	Description
125-195	Angled

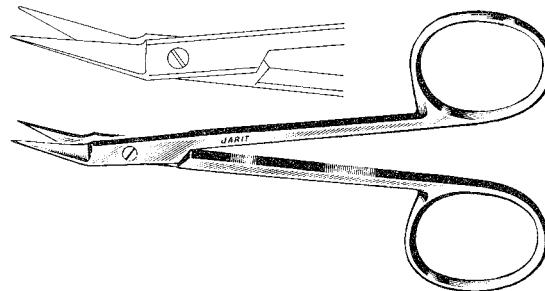

Knapp Iris Scissors, Sharp-Sharp

4" (103mm), 25mm blades

Catalog #	Description
360-090	Straight
360-093	Curved

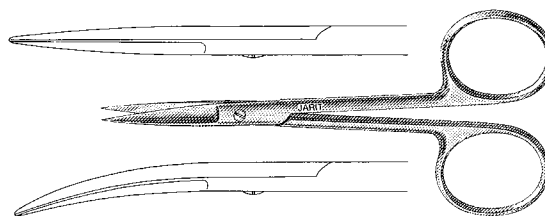

Knapp Iris Scissors, Sharp-Blunt

4" (103mm), 25mm blades

Catalog #	Description
360-091	Straight
360-094	Curved

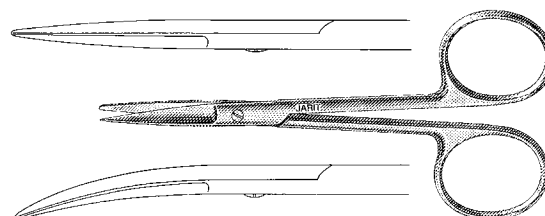

Knapp Iris Scissors, Blunt-Blunt

4" (103mm), 25mm blades

Catalog #	Description
360-092	Straight
360-095	Curved

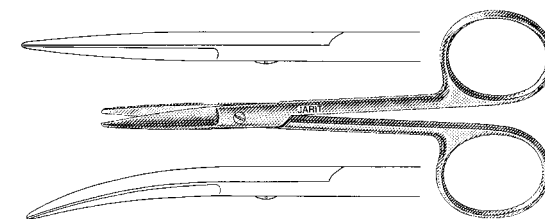

Iris Scissors, Sharp-Sharp, (Mirror Finish)

Manufactured from high grade German surgical stainless steel which is ground and polished to a mirror finish

Catalog #	Description
360-100	4 5/8" (116mm), 25mm blades, straight
360-101	4 5/8" (116mm), 25mm blades, curved

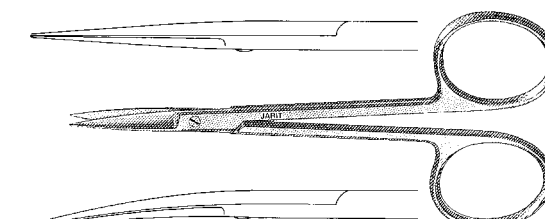

Iris Scissors, Sharp-Sharp, (Matte Finish)

Manufactured from high grade German surgical stainless steel which is glass beaded to a matte finish

Catalog #	Description
359-100	4 5/8" (116mm), 25mm blades, straight
359-101	4 5/8" (116mm), 25mm blades, curved

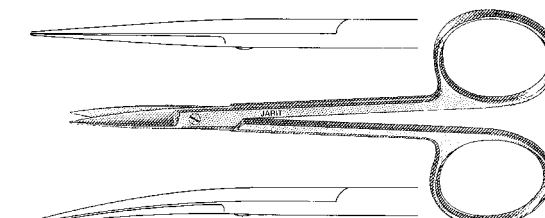

Iris Scissors, Angled on the Side

4 1/2" (115mm), (Mirror Finish)

Catalog #	Description
360-102	27mm blades

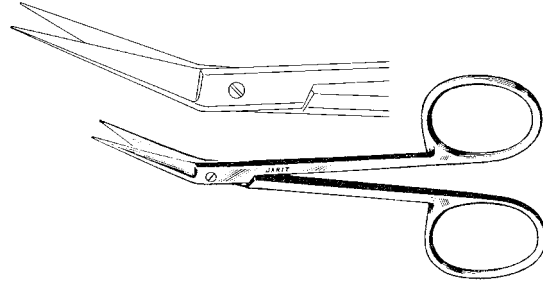

Iris Scissors, Angled on the Side, Probe Point

4 1/2" (115mm), (Mirror Finish)

Catalog #	Description
360-103	27mm blades

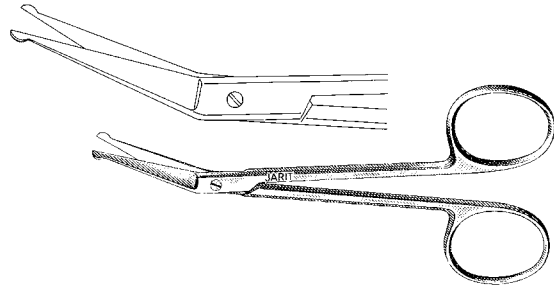

Iris Scissors, Sharp-Sharp

25mm blades, (Mirror Finish)

Catalog #	Description
360-104	3 1/2" (94mm), straight
360-105	3 1/2" (94mm), curved
360-110	4 1/8" (105mm), extra delicate, straight
360-111	4 1/8" (105mm), extra delicate, curved

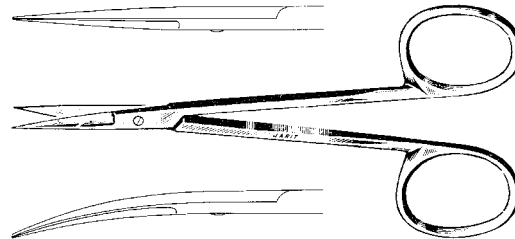

Wilmer Conjunctival Scissors, Angled on the Flat

4 1/8" (104mm)

Catalog #	Description
360-115	Delicate, 15mm blades

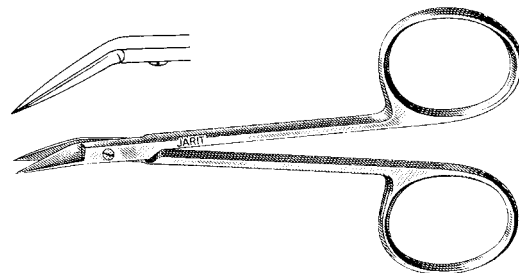

Iris Scissors, Large Finger Rings

3 7/8" (98mm), 22mm blades, (Satin Finish)

Catalog #	Description
360-117	Straight
360-118	Curved

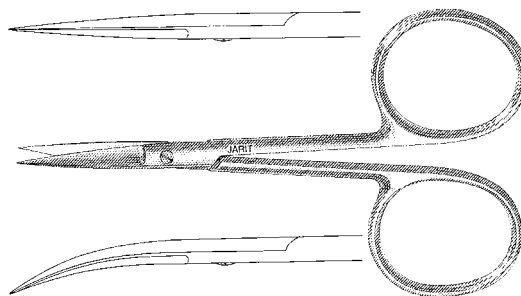

Iris Scissors, Sharp-Sharp

4" (103mm), delicate, 26mm blades, (Mirror Finish)

Catalog #	Description
360-120	Straight
360-121	Curved

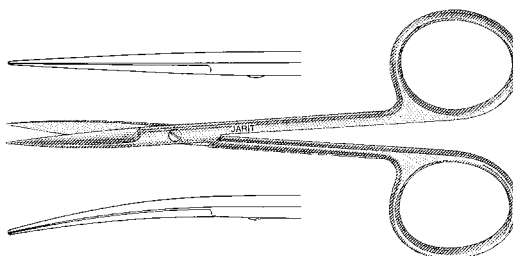

Iris Scissors, Flat Shanks, Sharp-Sharp

4 1/8" (104mm), 22mm blades, (Mirror Finish)

Catalog #	Description
360-122	Straight
360-123	Curved

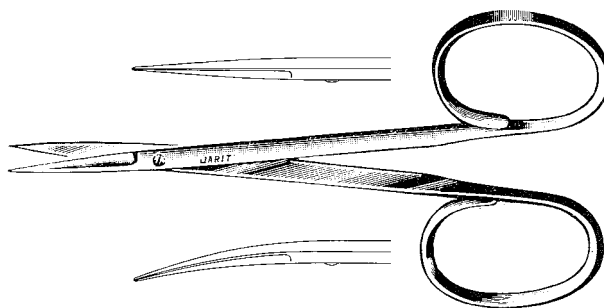

Iris Scissors, Flat Shanks, Sharp-Sharp

3 1/2" (96mm), delicate, 13.5mm blades, (Mirror Finish)

Catalog #	Description
360-125	Straight
360-126	Curved

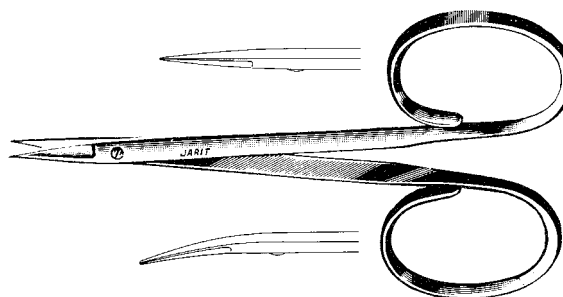

Eye Utility Scissors, Flat Shanks, Blunt-Blunt

37/8" (97mm), 16mm blades

Catalog #	Description
360-127	Straight
360-128	Curved

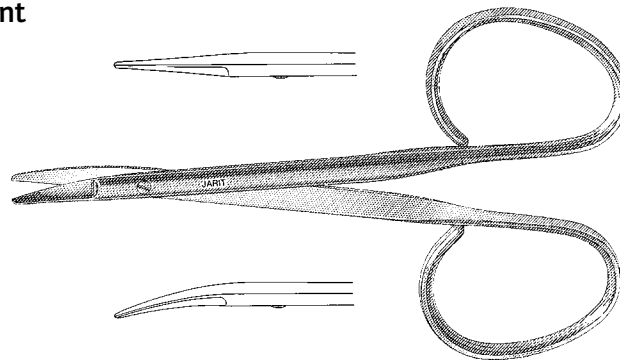

Strabismus Scissors

4 1/2" (114mm), 15mm blades

Catalog #	Description
360-130	Straight
360-131	Curved

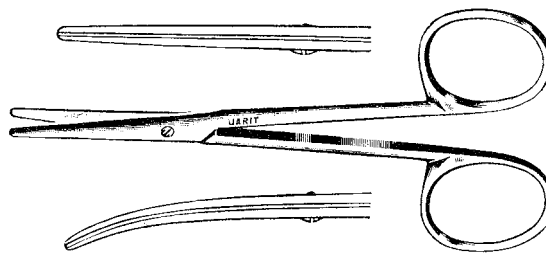

Strabismus Scissors, Flat Shanks

4 1/8" (106mm), 30mm blades

Catalog #	Description
360-134	Straight
360-135	Curved

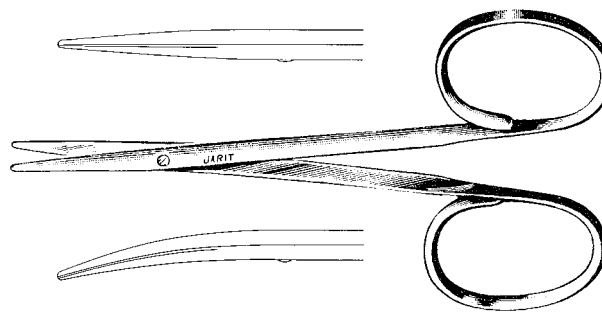

Stevens Tenotomy Scissors, Blunt-Blunt

Catalog #	Description
360-138	4 1/2" (115mm), 13mm blades, straight, slender pattern
360-139	4 1/2" (115mm), 13mm blades, curved, slender pattern
360-140	4 1/8" (115mm), 12mm blades, straight, standard pattern
360-141	4 1/8" (115mm), 12mm blades, curved, standard pattern

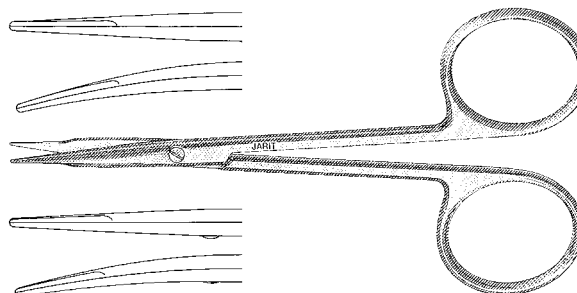

Stevens Tenotomy Scissors, Blunt-Blunt

3 7/8" (98mm), 13mm blades, flat shanks

Catalog #	Description
360-142	Straight
360-143	Curved

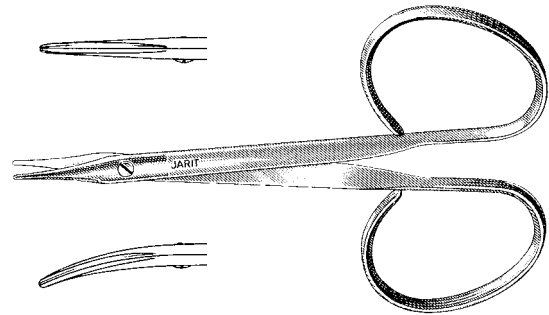

Stevens Stitch Scissors, Curved Sharp Tips

Catalog #	Description
360-148	4 1/8" (105mm), 14mm blades

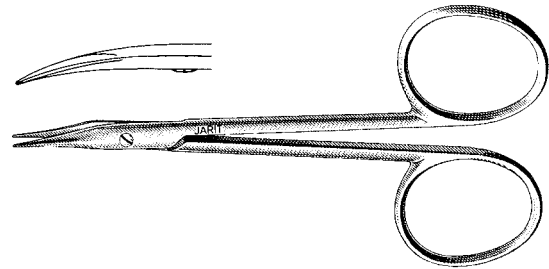

Stevens Stitch Scissors, Flat Shanks, Curved, Sharp Tips

Catalog #	Description
360-149	3 7/8" (98mm), 12mm blades

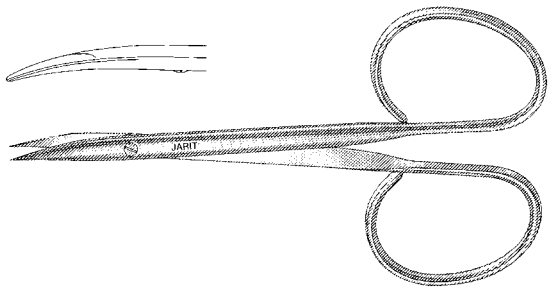

Stitch Scissors, Semi-Sharp Tips

3 7/8" (100mm), 16.5mm blades

Catalog #	Description
360-154	Straight
360-155	Curved

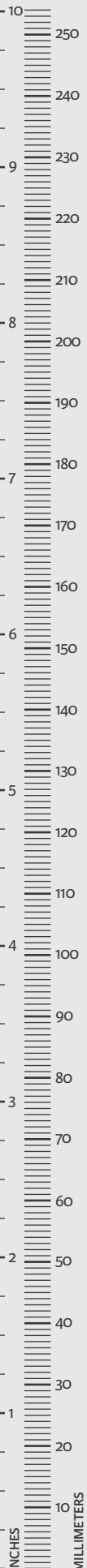
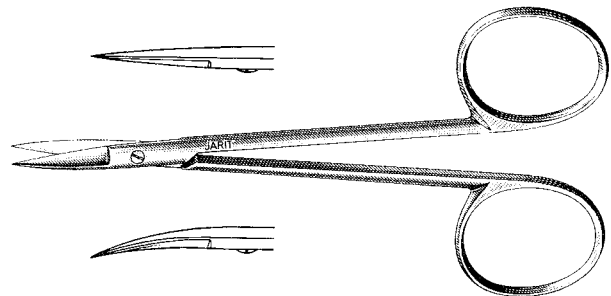

Metzenbaum-Lahey Scissors, Carb-Edge™, (Satin Finish)

Manufactured from high grade German surgical stainless steel which is ground and polished to a satin finish

Catalog #	Description
101-250	5¾" (145mm), straight
101-251	5¾" (145mm), curved

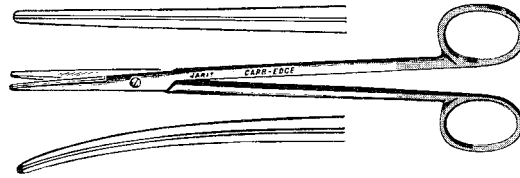

Metzenbaum-Lahey Scissors, Carb-Edge, (Matte Finish)

Manufactured from high grade German surgical stainless steel which is glass beaded to a matte finish

Catalog #	Description
103-250	5⅞" (149mm), straight
103-251	5⅞" (149mm), curved

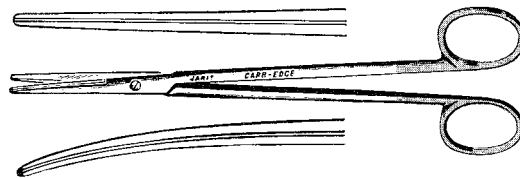

Metzenbaum-Lahey Scissors, Carb-Edge

delicate, sharp-sharp

Catalog #	Description
101-252	5¾" (145mm), straight
101-253	5¾" (145mm), curved

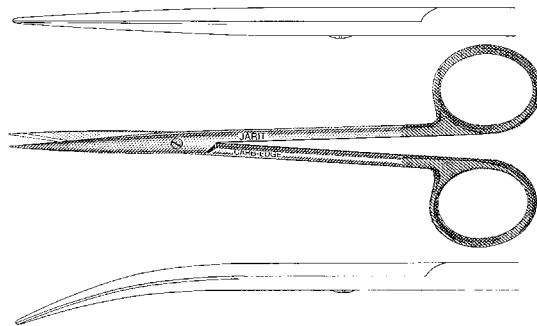

Petit-Point® Reynolds Scissors, Carb-Edge

5 1/8" (130mm)

Catalog #	Description
101-255	Curved, one blade serrated

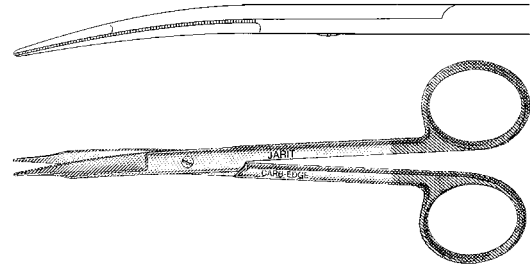

Metzenbaum Scissors, Carb-Edge

7" (179mm), sharp-sharp

Catalog #	Description
101-257	Straight
101-259	Delicate, curved

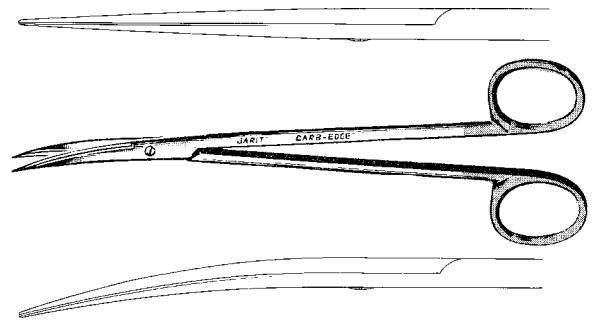

Metzenbaum Scissors, Carb-Edge

7" (179mm)

Catalog #	Description
101-260	Delicate, straight

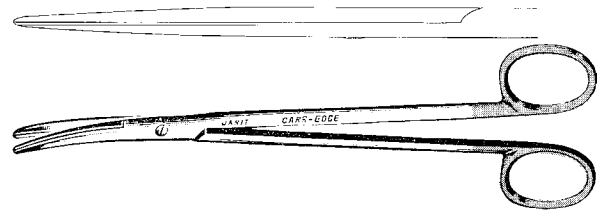

Metzenbaum Scissors, Carb-Edge, (Satin Finish)

7" (179mm)

Manufactured from high grade German surgical stainless steel which is ground and polished to a satin finish

Catalog #	Description
101-261	Delicate, curved

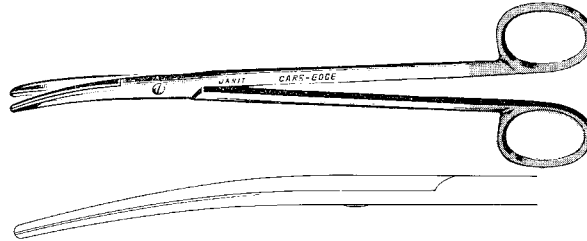

Metzenbaum Scissors, Carb-Edge, (Matte Finish)

7" (179mm)

Manufactured from high grade German surgical stainless steel which is glass beaded to a matte finish

Catalog #	Description
103-261	Delicate, curved

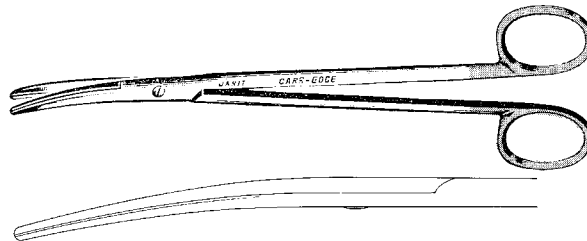

Iris Scissors, Carb-Edge

4 1/2" (114mm)

Catalog #	Description
101-300	Straight
101-301	Curved

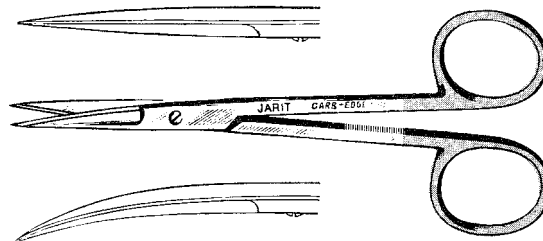

Strabismus Scissors, Carb-Edge

4 1/2" (114mm)

Catalog #	Description
101-310	Straight
101-311	Curved

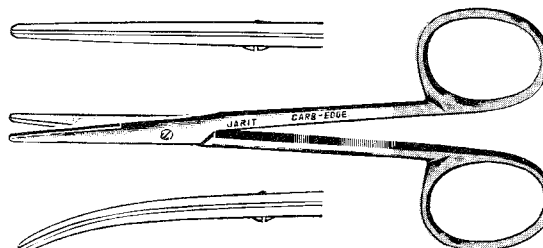

Metzenbaum-Lahey Scissors, Supercut

5⁵/₈" (143mm)

Catalog #	Description
102-119	Straight
102-120	Curved

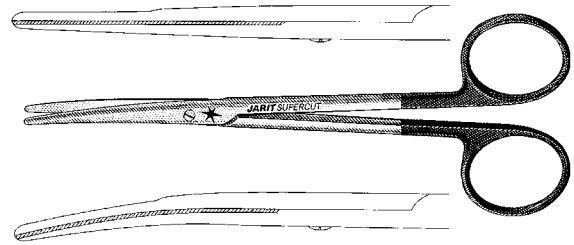

Metzenbaum Scissors, Supercut

Catalog #	Description
102-122	7" (180mm), curved
102-125	9 ¹ / ₄ " (232mm), curved

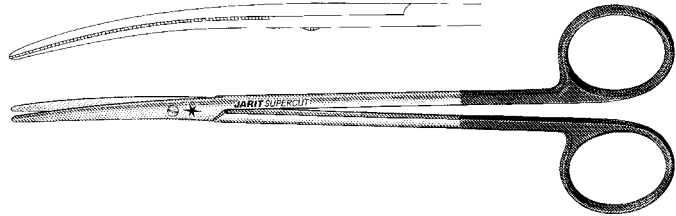

Iris Scissors, Supercut

4⁵/₈" (116mm)

Catalog #	Description
102-130	Straight
102-131	Curved

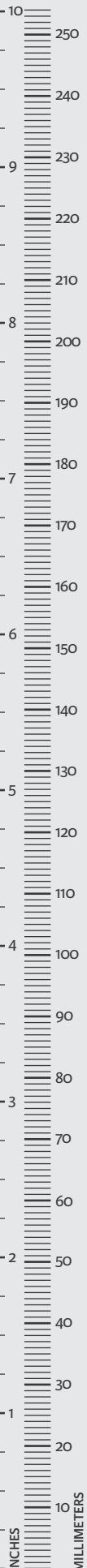
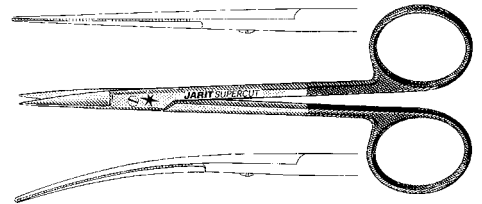

Stevens Tenotomy Scissors, Supercut

blunt tips

Catalog #	Description
102-138	4 ³ / ₈ " (112mm), 13mm blades, straight, slender pattern
102-139	4 ³ / ₈ " (112mm), 13mm blades, curved, slender pattern
102-140	4 ¹ / ₄ " (107mm), 12mm blades, straight, standard pattern
102-141	4 ¹ / ₄ " (107mm), 12mm blades, curved, standard pattern

Standard shown below. Supercut available.

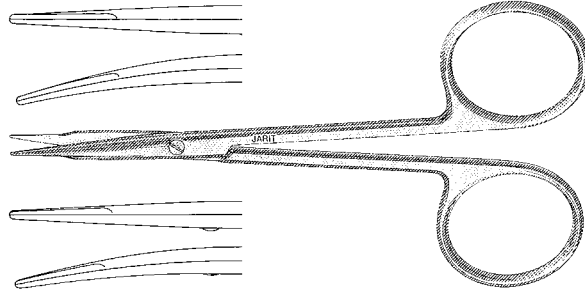

Knight Nasal Scissors, Supercut

6³/₄" (171mm)

Catalog #	Description
102-180	30mm blades

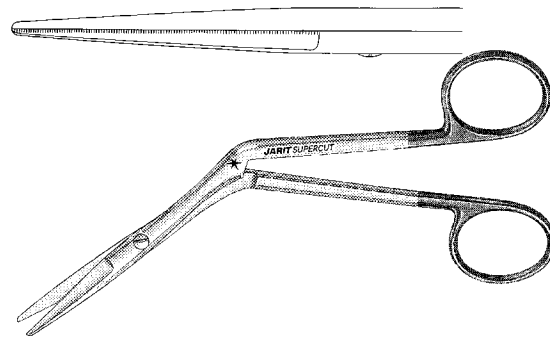

Plastic Surgery Scissors, Supercut

4³/₄" (121mm)

Catalog #	Description
102-200	Straight
102-202	Curved

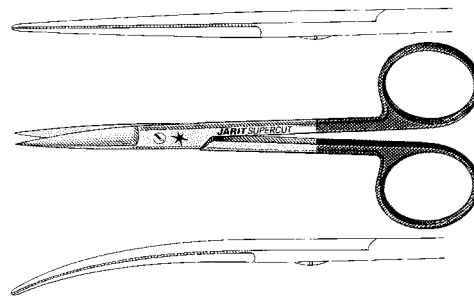

Castanares Face Lift Scissors, Supercut

6¹/₄" (157mm)

Catalog #	Description
102-205	Straight

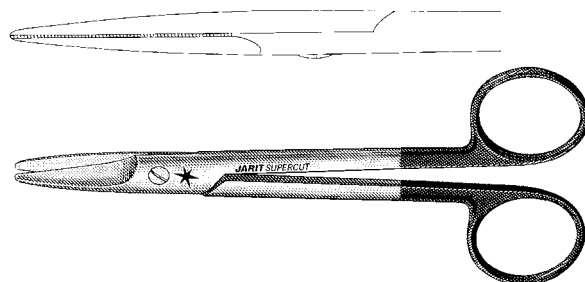

Gorney Plastic Surgery Scissors, Supercut

7¼" (185mm)

Catalog #	Description
102-210	Straight
102-211	Curved

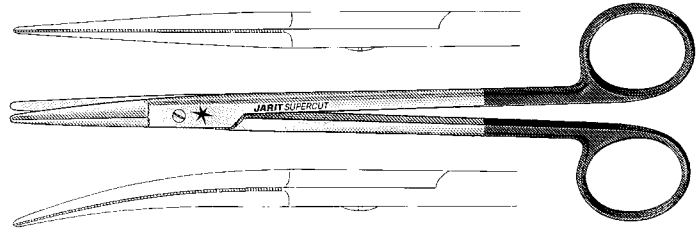

Kaye Face Lift Scissors, Supercut

curved beveled blades have semi-sharp outer edges

Catalog #	Description
102-215	5⅝" (142mm)
102-216	7¾" (194mm)

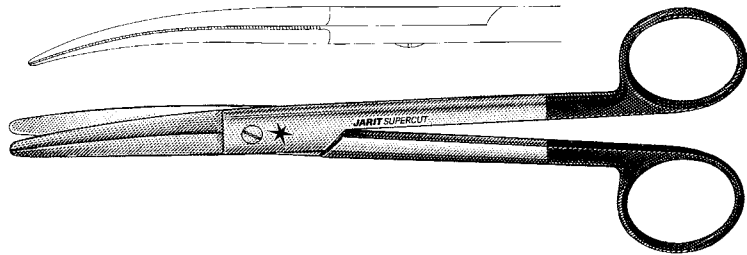

Freeman-Gorney Face Lift Scissors, Supercut

7¼" (184mm)

beveled blades have semi-sharp outer edges and flat, tapered tips; flared shanks

Catalog #	Description
102-220	Straight
102-221	Curved

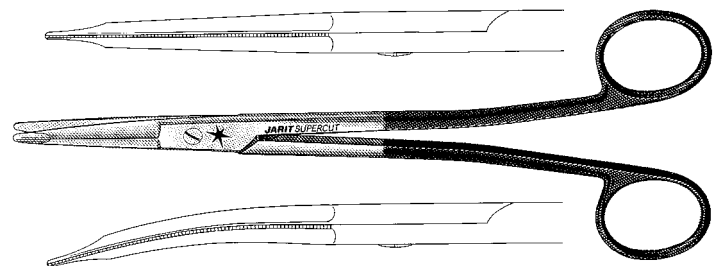

Freeman-Kaye Face Lift Scissors, Supercut

7¼" (184mm)

beveled blades have semi-sharp outer edges and flat, tapered tips;
flared shanks

Catalog #	Description
102-225	Straight
102-226	Curved

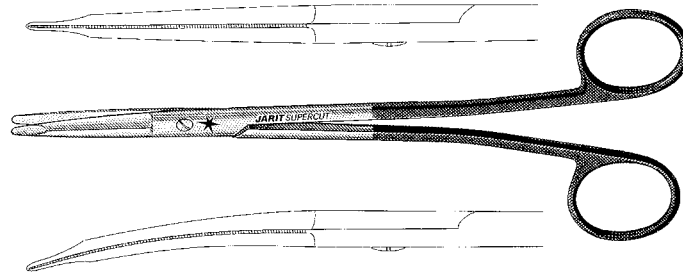

Freeman Rhytidectomy Scissors, Supercut

7" (178mm)

with flat tips; flared shanks

Catalog #	Description
102-229	Curved

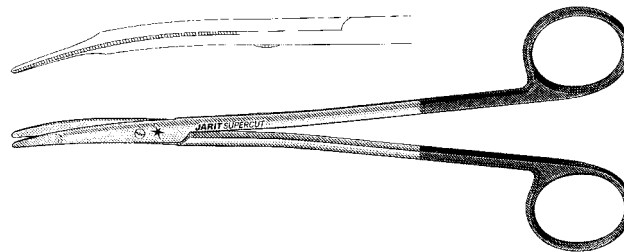

Gorney Platysma Scissors, Supercut

9¼" (232mm)

beveled blades have semi-sharp outer edges and flat,
tapered tips; flared shanks

Catalog #	Description
102-230	Straight
102-231	Curved

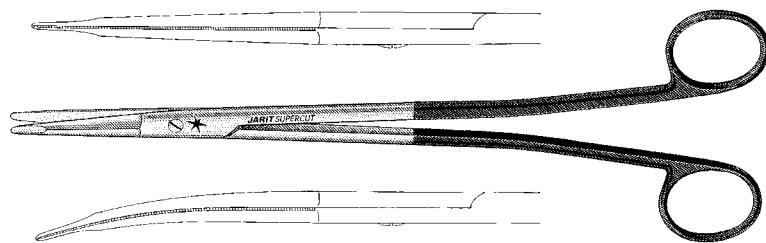

Fomon Lateral Scissors, Supercut

4½" (114mm)

Catalog #	Description
102-235	Full curved

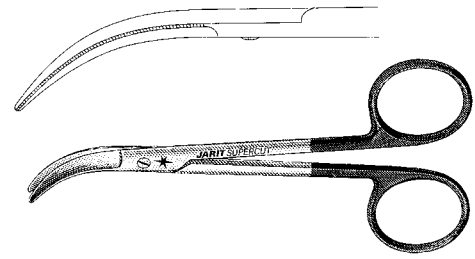

Fomon Dorsal Scissors, Supercut

5½" (140mm)

Catalog #	Description
102-236	Angled on flat

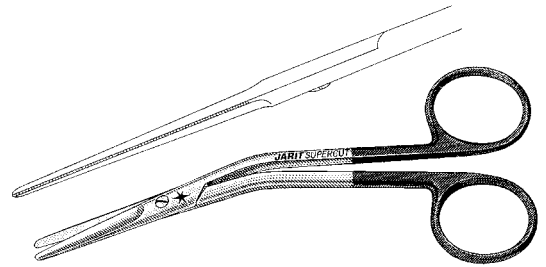

Cottle Dorsal Scissors, Supercut

6" (155mm)

Catalog #	Description
102-238	Angled on flat

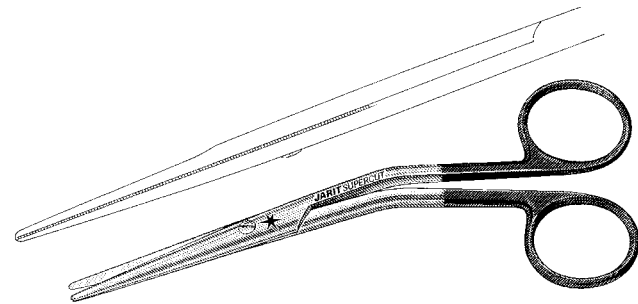

Par Style Plastic and Recon Scissors, Supercut
curved

Catalog #	Description
102-240	4½" (113mm)
102-242	5⅝" (144mm)

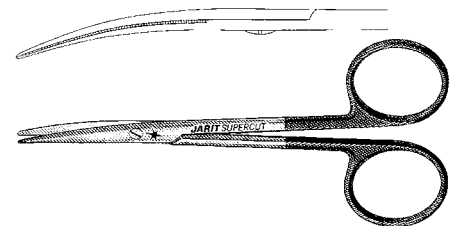

Reynolds Petit-Point Scissors, Supercut

5⅛" (129mm)

Catalog #	Description
102-245	Curved

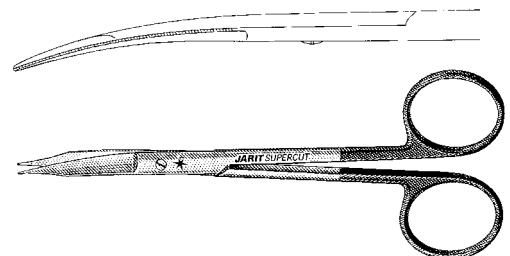

Converse Needle Holder

Catalog #	Description
120-090	4 ³ / ₈ " (112mm), large finger rings

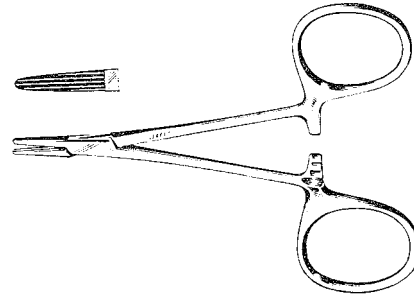

Brown Needle Holder

Catalog #	Description
120-095	5 ¹ / ₄ " (133mm), rounded jaws

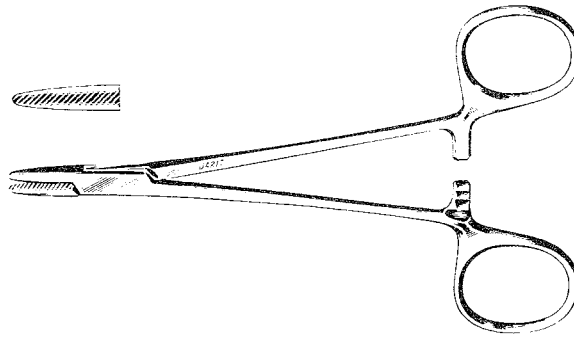

Neivert Needle Holder

Catalog #	Description
120-097	4 ⁷ / ₈ " (123mm), thumb ring turned up

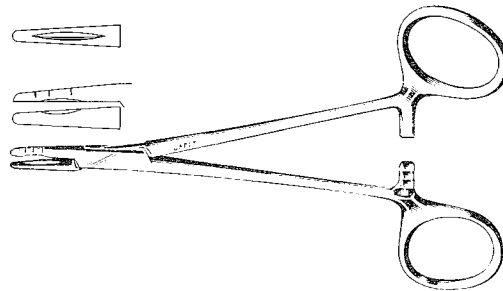

Derf Needle Holder

Catalog #	Description
120-100	4 ³ / ₄ " (120mm), grooved jaws

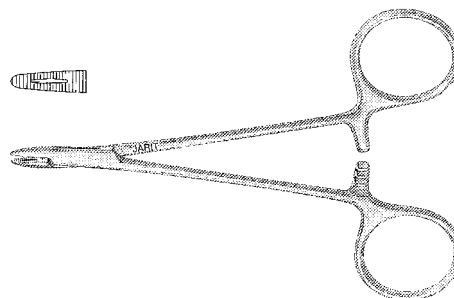

Baumgartner Needle Holder

Catalog #	Description
120-105	5 1/4" (133mm), solid jaws

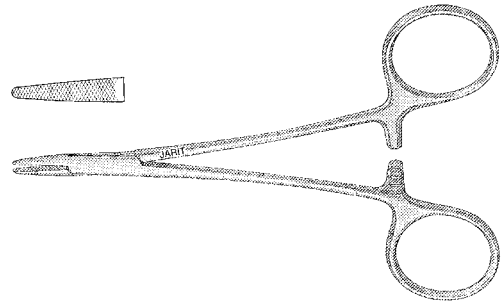

Baumgartner Needle Holder

Catalog #	Description
120-110	5 1/4" (133mm), grooved jaws

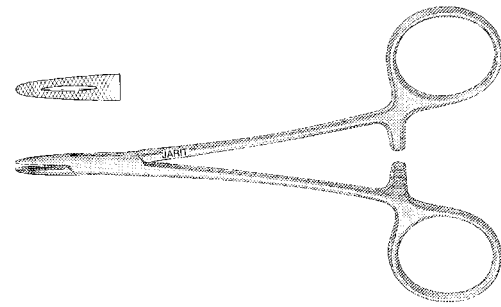

Hegar-Baumgartner Needle Holder

Catalog #	Description
120-112	5 3/4" (146mm), solid jaws

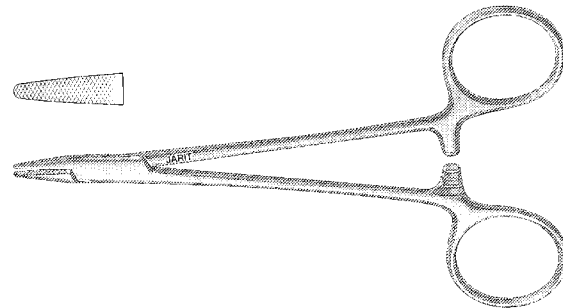

Collier Needle Holder

Catalog #	Description
120-115	5 3/8" (135mm), grooved jaws

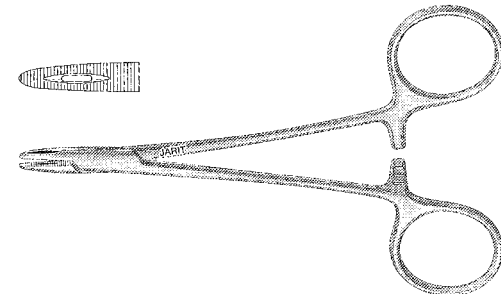

Webster Needle Holder

Catalog #	Description
120-118	4½" (115mm), smooth jaws

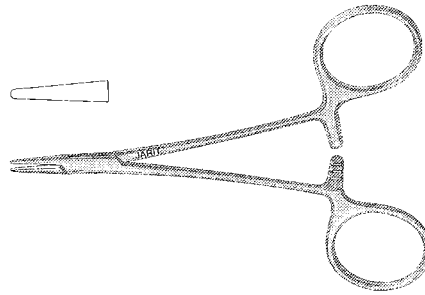

Halsey Needle Holder

Catalog #	Description
120-120	5⅜" (135mm), smooth jaws

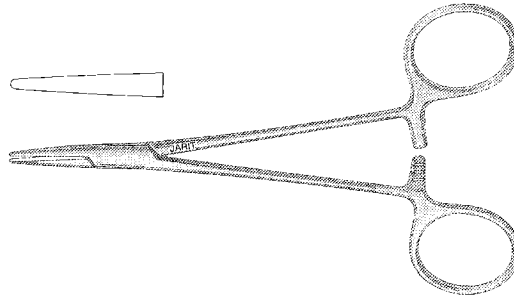

Crile-Wood Needle Holders
grooved jaws

Catalog #	Description
120-130	6" (152mm)
120-131	7¼" (183mm)

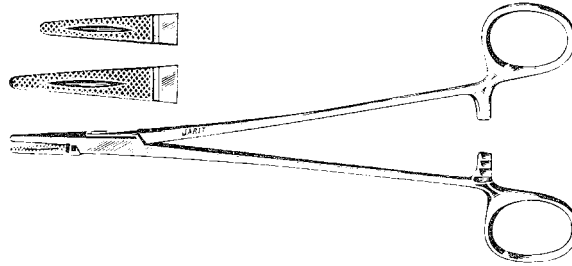

Petit-Point Olsen-Hegar Needle Holders
4¾" (120mm)

Catalog #	Description
120-148	Serrated
120-149	Smooth

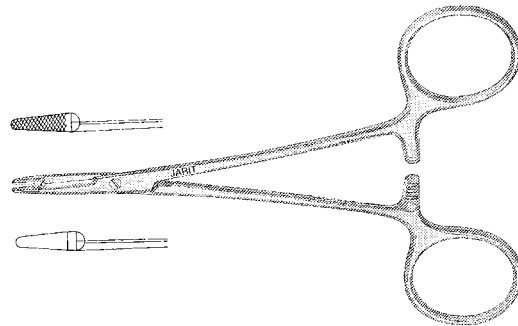

Bayonet Needle Holder

Catalog #	Description
120-215	6½" (168mm), rounded fine tapered jaws

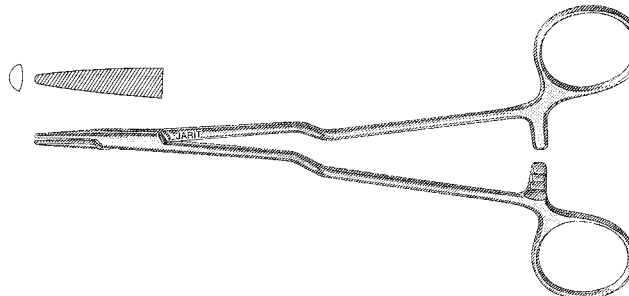

Neivert Needle Holder, Carb-Bite

4000 teeth per square inch, for use with 4.0 and 5.0 suture

Catalog #	Description
121-097	5" (126mm), thumb ring turned up

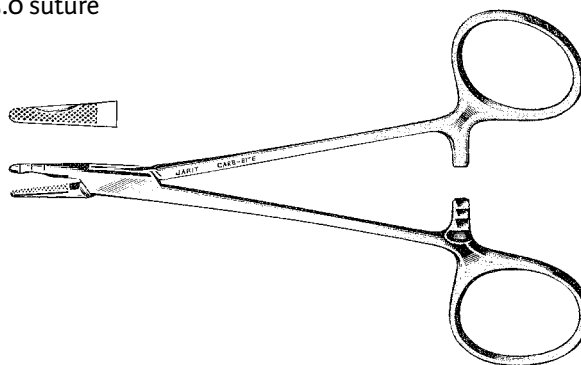

Derf Needle Holder, Carb-Bite

4000 teeth per square inch, for use with 4.0, 5.0, 6.0 suture

Catalog #	Description
121-100	4 3/4" (120mm)

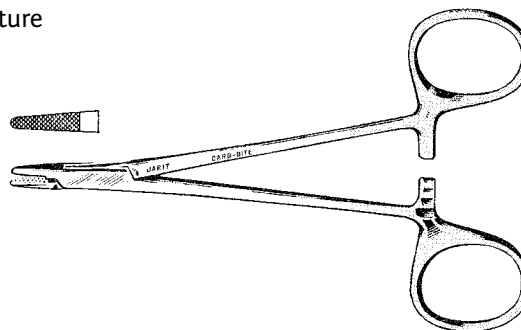

Baumgartner Needle Holder, Carb-Bite, (Satin Finish)

4000 teeth per square inch, for use with 2.0, 3.0, 4.0 suture

Manufactured from high grade German surgical stainless steel which is ground and polished to a satin finish

Catalog #	Description
121-105	5 1/4" (132mm)

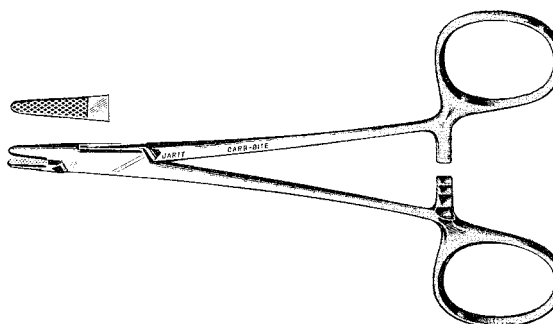

Baumgartner Needle Holder, Carb-Bite, (Matte Finish)

4000 teeth per square inch, for use with 2.0, 3.0, 4.0 suture
 Manufactured from high grade German surgical stainless steel which is glass beaded to a matte finish

Catalog #	Description
123-105	5 1/4" (132mm)

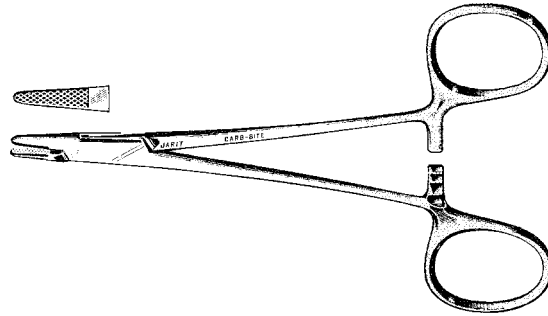

Hegar-Baumgartner Needle Holder, Carb-Bite, (Satin Finish)

2500 teeth per square inch, for use with 2.0, 3.0, 4.0 suture
 Manufactured from high grade German surgical stainless steel which is ground and polished to a satin finish

Catalog #	Description
121-106	5 3/4" (147mm)

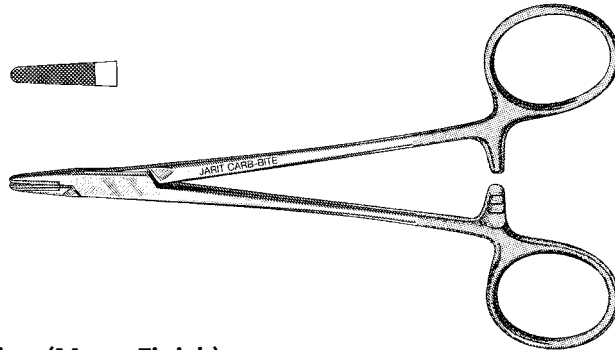

Hegar-Baumgartner Needle Holder, Carb-Bite, (Matte Finish)

2500 teeth per square inch, for use with 2.0, 3.0, 4.0 suture
 Manufactured from high grade German surgical stainless steel which is glass beaded to a matte finish

Catalog #	Description
123-106	5 3/4" (147mm)

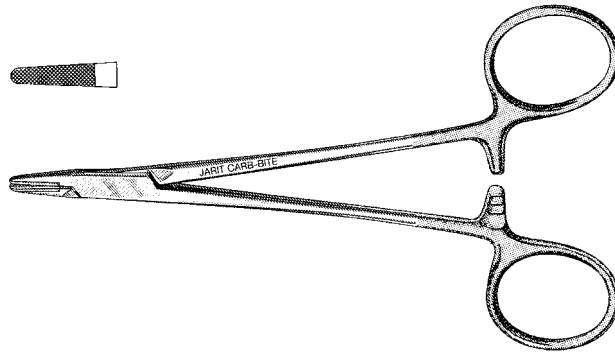

Par Style Plastic and Recon Needle Holder, Carb-Bite

7000 teeth per square inch, for use with 6.0, 7.0, 8.0 suture

Catalog #	Description
121-115	4 5/8" (117mm), serrated
121-116	4 5/8" (117mm), smooth

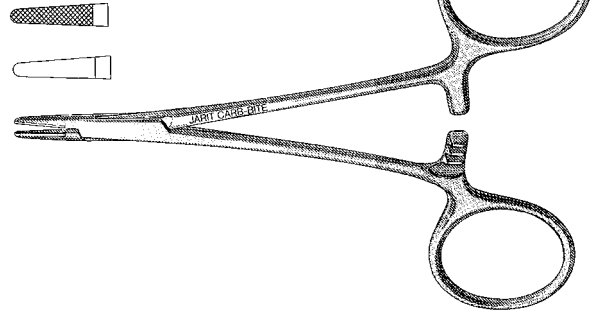

Webster Needle Holder, Carb-Bite

3600 teeth per square inch, for use with 5.0 and 6.0 suture

Catalog #	Description
121-118	4 5/8" (118mm), smooth
121-119	4 5/8" (118mm), serrated

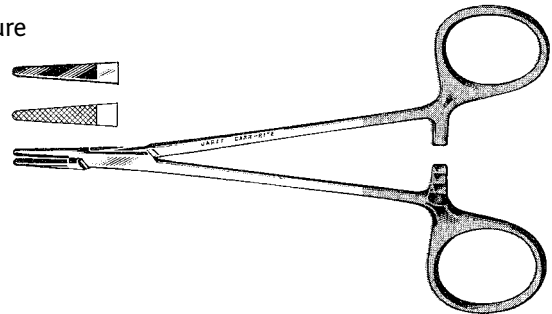

Halsey Needle Holder, Carb-Bite

for use with 4.0 and 5.0 suture

Catalog #	Description
121-120	5 1/4" (133mm), smooth

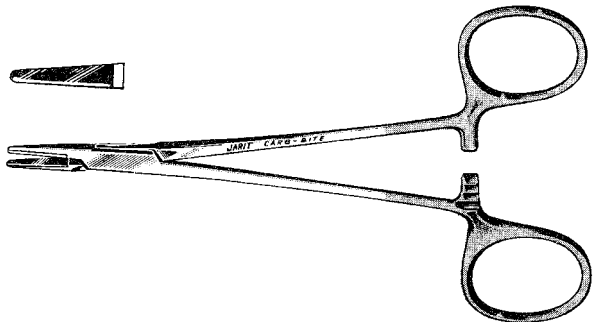

Halsey Needle Holder, Carb-Bite

4000 teeth per square inch, for use with 4.0 and 5.0 suture

Catalog #	Description
121-121	5 1/4" (133mm), serrated

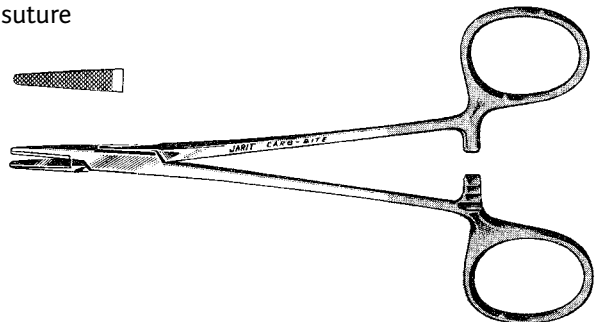

Crile-Wood Needle Holder, Carb-Bite, (Satin Finish)

4000 teeth per square inch, for use with 4.0, 5.0 and 6.0 suture
Manufactured from high grade German surgical stainless steel which is ground and polished to a satin finish

Catalog #	Description
121-130	6" (152mm)
121-131	7" (180mm)

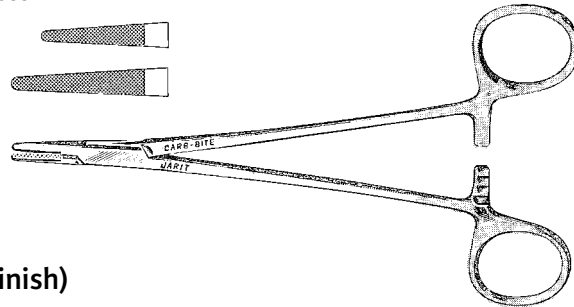

Crile-Wood Needle Holder, Carb-Bite, (Matte Finish)

4000 teeth per square inch, for use with 4.0, 5.0 and 6.0 suture
Manufactured from high grade German surgical stainless steel which is glass beaded to a matte finish

Catalog #	Description
123-130	6" (152mm)
123-131	7" (180mm)

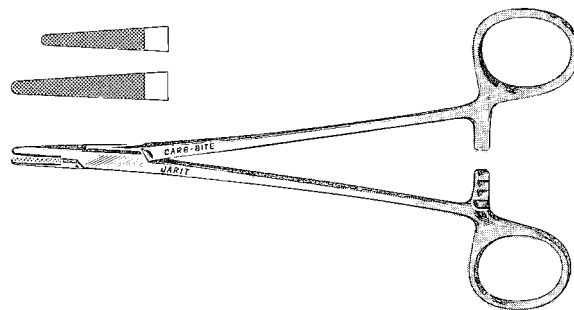

Petit-Point® Olsen-Hegar Needle Holder/Scissors, Carb-Bite

7000 teeth per square inch, for use with 6.0, 7.0, 8.0 suture

Catalog #	Description
121-148	4¾" (120mm), serrated
121-149	4¾" (120mm), smooth

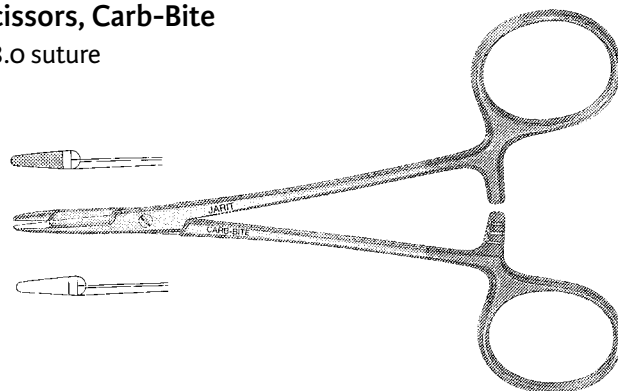

Petit-Point Ryder Needle Holders

7000 teeth per square inch, for use with 4.0, 5.0 and 6.0 suture
1mm serrated and smooth jaws

Catalog #	Description
121-170	4⅞" (124mm), serrated
121-171	4⅞" (124mm), smooth
121-172	6¼" (156mm), serrated
121-173	6¼" (156mm), smooth

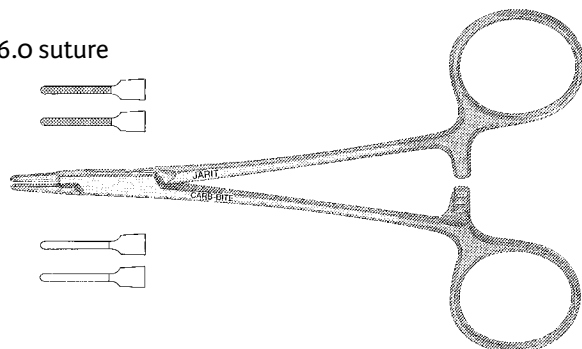

Castroviejo Needle Holders, Flat Serrated Handles

for use with 5.0 and 6.0 suture
5½" (140mm), 11.5mm smooth jaws,
delicate tips 1.5mm

Catalog #	Description
355-404	Curved, locking
355-404NL	Curved, non-locking
355-405	Straight, locking
355-405NL	Straight, non-locking

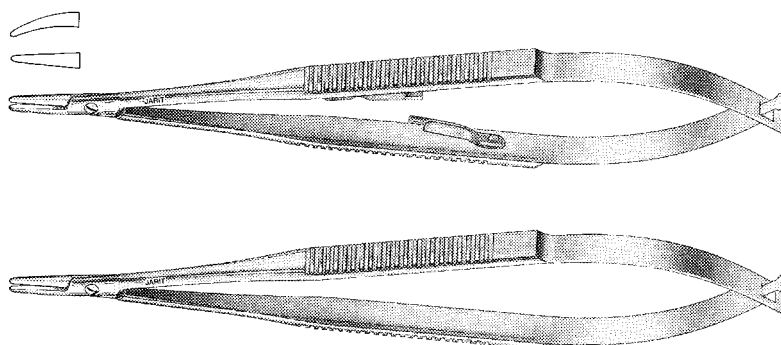

Castroviejo Needle Holders, Flat Serrated Handles

for use with 6.0, 7.0 and 8.0 suture
5½" (140mm), 10.5mm smooth jaws,
extra delicate tips 1.2mm

Catalog #	Description
355-406	Straight, locking
355-406NL	Straight, non-locking
355-407	Curved, locking
355-407NL	Curved, non-locking

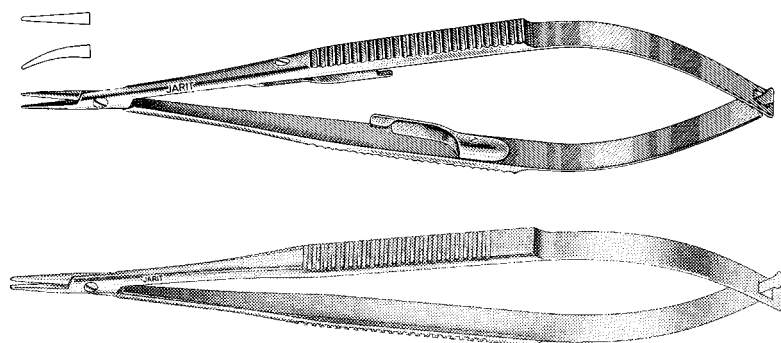

Castroviejo Needle Holders, Wide Serrated Handles

for use with 6.0, 7.0 and 8.0 suture
5" (127mm), 9mm smooth jaws,
microsurgery tips 0.6mm

Catalog #	Description
355-408	Straight, non-locking
355-409	Curved, non-locking
355-410	Straight, locking
355-411	Curved, locking

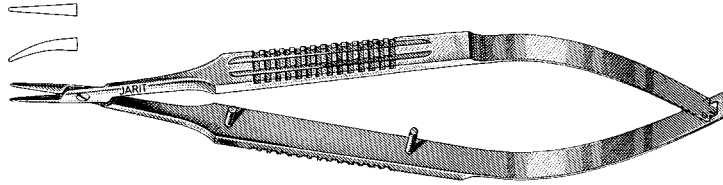

Castroviejo Needle Holders, Carb-Bite

flat serrated handles, for use with 6.0 and 7.0 suture
5½" (140mm), 11mm straight jaws,
extra delicate tips 1.2mm

Catalog #	Description
355-412	Smooth, locking
355-412NL	Smooth, non-locking
355-413	Serrated, locking
355-413NL	Serrated, non-locking

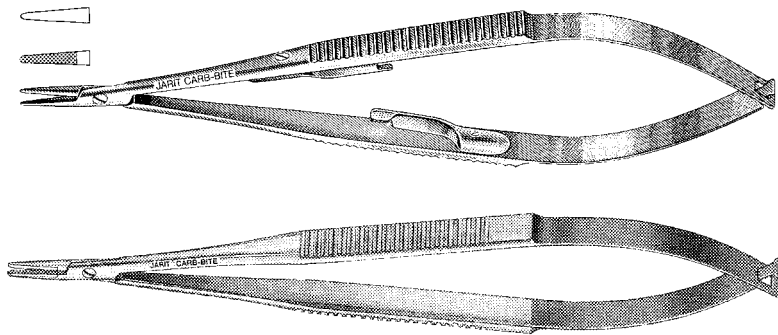

Petit-Point Jacobson Mosquito Forceps

Catalog #	Description
105-088	4 ⁷ / ₈ " (124mm), straight
105-089	4 ⁷ / ₈ " (124mm), curved

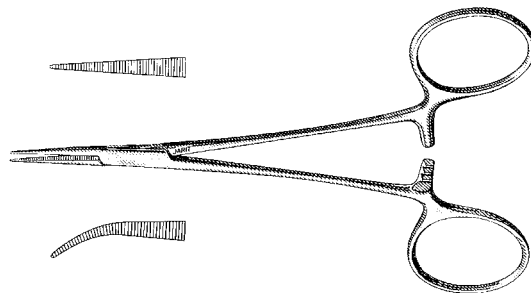

Petit-Point Mosquito Forceps

Catalog #	Description
105-090	3 ⁷ / ₈ " (100mm), straight
105-091	3 ⁷ / ₈ " (100mm), curved
105-095	4 ³ / ₄ " (120mm), straight
105-096	4 ³ / ₄ " (120mm), curved

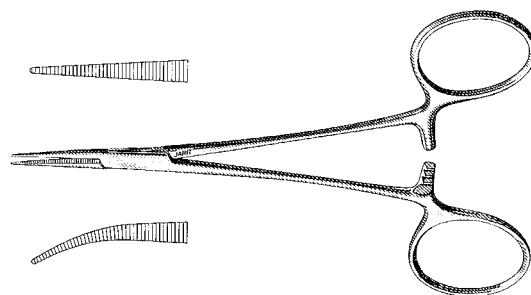

Petit-Point Mosquito Forceps

Catalog #	Description
105-098	6" (152mm), straight
105-099	6" (152mm), curved

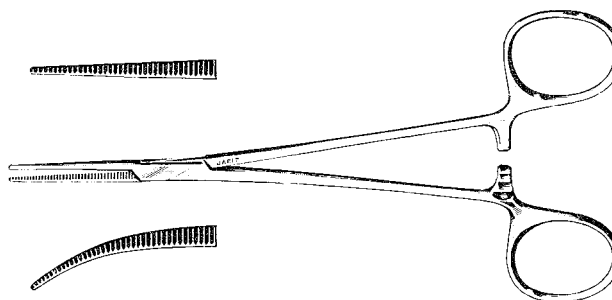

Petit-Point Crile Forceps

Catalog #	Description
105-118	5 ⁵ / ₈ " (143mm), straight
105-119	5 ⁵ / ₈ " (143mm), curved

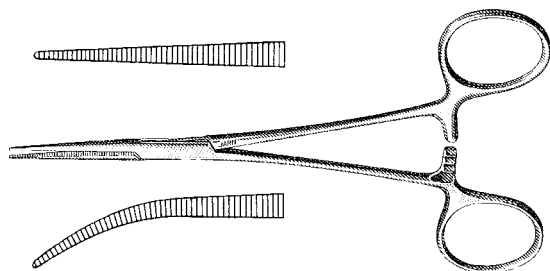

Petit-Point Pean Forceps

Catalog #	Description
105-163	5½" (140mm), straight
105-164	5½" (140mm), curved

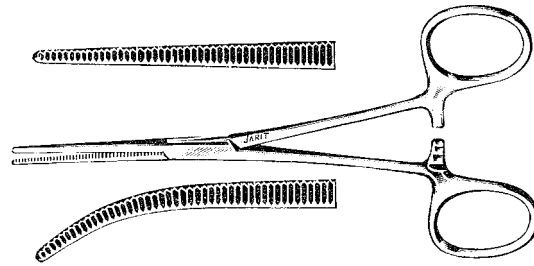

Petit-Point Ochsner Forceps

Catalog #	Description
105-233	5½" (140mm), straight
105-234	5½" (140mm), curved

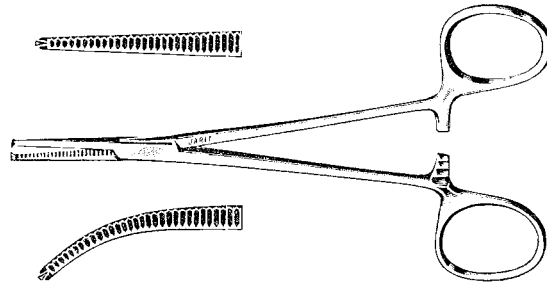

Halstead Mosquito Forceps, (Mirror Finish)

Manufactured from high grade German surgical stainless steel which is ground and polished to a mirror finish

Catalog #	Description
105-100	5" (127mm), straight
105-102	5" (127mm), curved

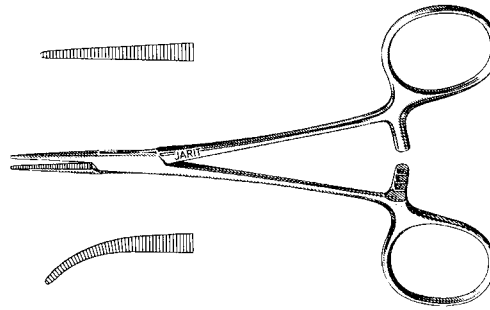

Halstead Mosquito Forceps, (Satin Finish)

Manufactured from high grade German surgical stainless steel which is ground and polished to a satin finish

Catalog #	Description
106-100	5" (127mm), straight
106-102	5" (127mm), curved

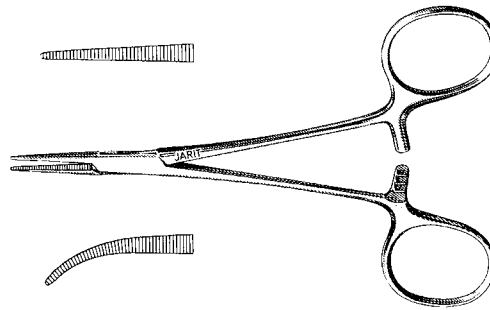

Halstead Mosquito Forceps, (Matte Finish)

Manufactured from high grade German surgical stainless steel which is glass beaded to a matte finish

Catalog #	Description
107-100	5" (127mm), straight
107-102	5" (127mm), curved

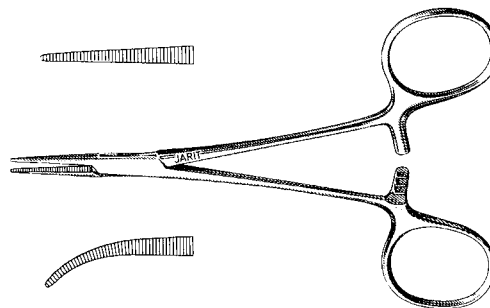

Halstead Mosquito Forceps

4⁷/₈" (124mm), 1 x 2 teeth, mirror finish

Catalog #	Description
105-110	Straight
105-112	Curved

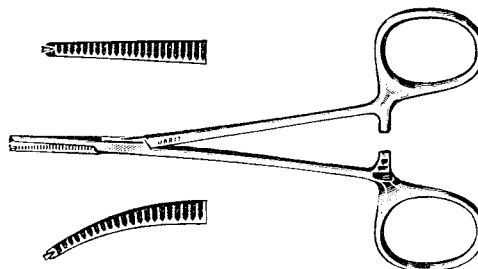

Hartman Mosquito Forceps, (Mirror Finish)

Manufactured from high grade German surgical stainless steel which is ground and polished to a mirror finish

Catalog #	Description
105-114	3 ⁷ / ₈ " (100mm), straight
105-115	3 ⁷ / ₈ " (100mm), curved

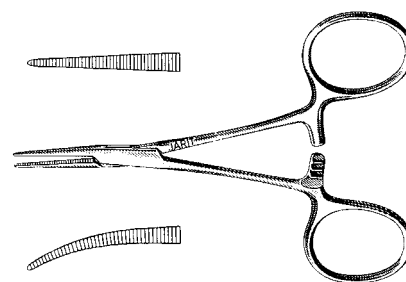

Hartman Mosquito Forceps, (Matte Finish)

Manufactured from high grade German surgical stainless steel which is glass beaded to a matte finish

Catalog #	Description
107-114	3 ⁷ / ₈ " (100mm), straight
107-115	3 ⁷ / ₈ " (100mm), curved

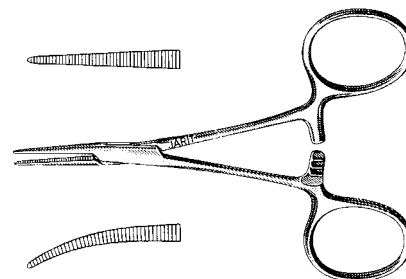

Coller-Crile Forceps

fine tapered tips

Catalog #	Description
105-142	5 ⁵ / ₈ " (143mm), straight
105-143	6 ¹ / ₄ " (160mm), straight, mirror finish
105-144	5 ⁵ / ₈ " (143mm), curved, mirror finish
105-145	6 ¹ / ₄ " (160mm), curved, mirror finish

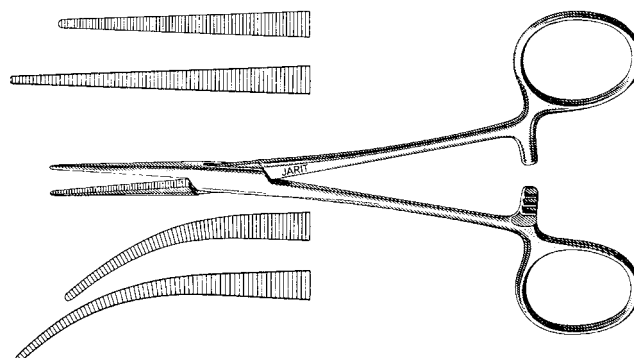

Providence Hospital Forceps

Catalog #	Description
105-160	5 5/8" (144mm), straight
105-161	5 5/8" (144mm), curved

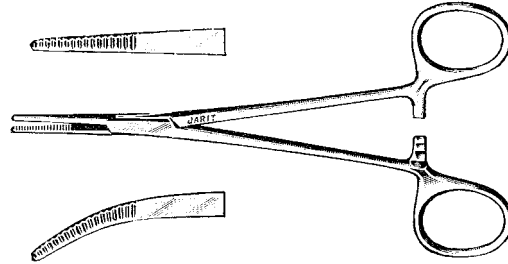

Kocher Artery Forceps, (Mirror Finish)

Manufactured from high grade German surgical stainless steel which is ground and polished to a mirror finish

Catalog #	Description
105-230	5 1/2" (140mm), straight
105-232	5 1/2" (140mm), curved

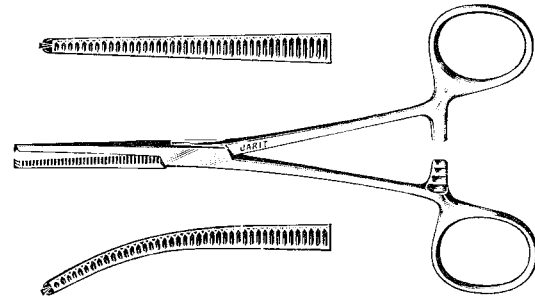

Kocher Artery Forceps, (Satin Finish)

Manufactured from high grade German surgical stainless steel which is ground and polished to a satin finish

Catalog #	Description
106-230	5 1/2" (140mm), straight
106-232	5 1/2" (140mm), curved

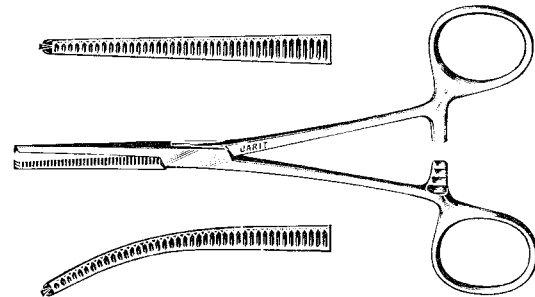

Petit-Point Allis Tissue Forceps

Catalog #	Description
135-095	5 1/8" (130mm), 3mm wide jaws, 4 x 5 teeth

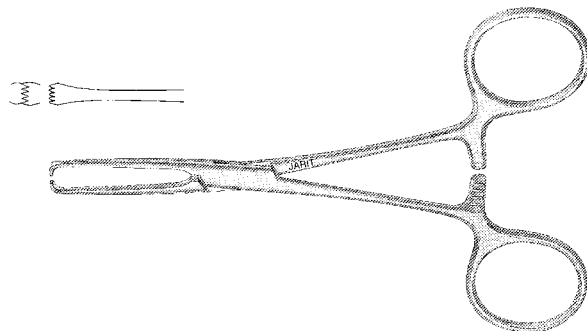

Petit-Point Babcock Forceps

Catalog #	Description
135-179	5 ⁷ / ₈ " (148mm), jaw width 5.6mm
135-180	6" (155mm), jaw width 7.5mm

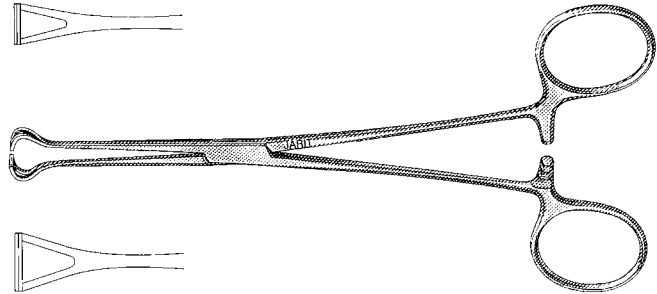

Petit-Point Mixer Forceps

Catalog #	Description
140-218	5 ³ / ₈ " (137mm)

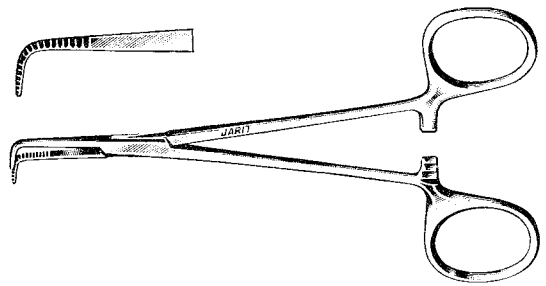

Petit-Point Mixer Forceps

Catalog #	Description
140-223	7 ¹ / ₄ " (185mm)

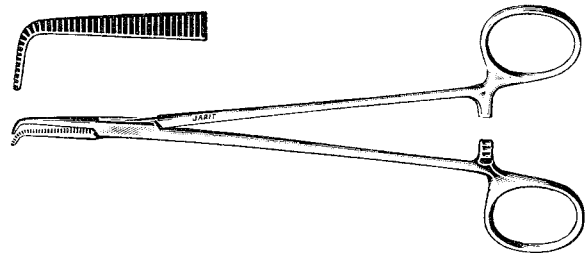

Adson Dressing Forceps, Serrated, (Matte Finish)

Manufactured from high grade German surgical stainless steel which is glass beaded to a matte finish

Catalog #	Description
130-230	4¾" (120mm)
130-231	4¾" (120mm), extra delicate, 0.8mm wide tip

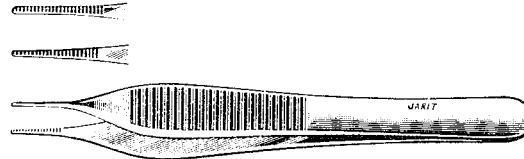

Adson Dressing Forceps, Serrated, (Mirror Finish)

Manufactured from high grade German surgical stainless steel which is ground and polished to a mirror finish

Catalog #	Description
129-230	4¾" (120mm)

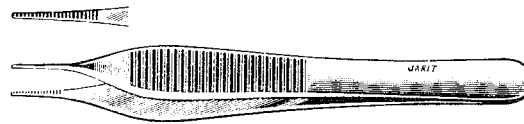

Adson Dressing Forceps, (Satin Finish)

Catalog #	Description
130-232	4¾" (120mm), cross-serrated



Adson Tissue Forceps, 1 x 2 teeth, (Matte Finish)

Manufactured from high grade German surgical stainless steel which is glass beaded to a matte finish

Catalog #	Description
130-234	4¾" (120mm)
130-235	4¾" (120mm), extra delicate, 0.8mm wide tip
130-237	4⅝" (117mm), angled jaw
130-238	4¾" (120mm), with tying platform

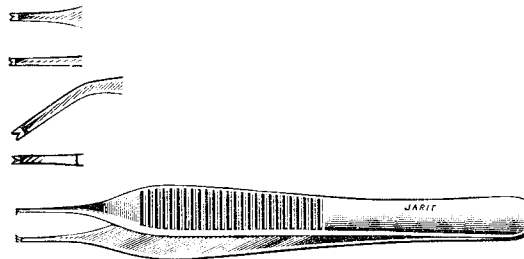

Adson Tissue Forceps, 1 x 2 teeth, (Mirror Finish)

Manufactured from high grade German surgical stainless steel which is ground and polished to a mirror finish

Catalog #	Description
129-234	4¾" (120mm)

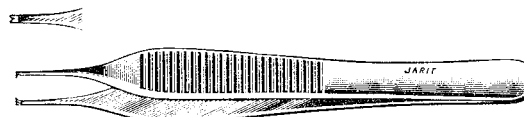

Adson Tissue Forceps, Carb-Bite, (Mirror Finish)

Catalog #	Description
130-236	4¾" (120mm)

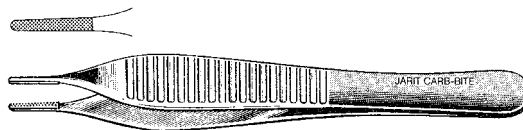

Adson Tissue Forceps, (Satin Finish)

Catalog #	Description
130-240	4¾" (120mm), 2 x 3 teeth

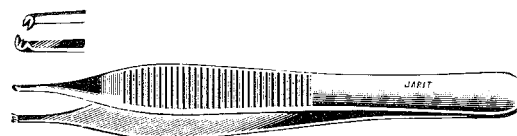

Adson Dressing Forceps, (Satin Finish)

Catalog #	Description
130-243	4¾" (120mm), cross serrated handle, matte



Adson Tissue Forceps, (Satin Finish)

Catalog #	Description
130-244	4¾" (120mm), 1 x 2 teeth, cross serrated handle, matte



Adson Tissue Forceps, (Matte Finish)

Manufactured from high grade German surgical stainless steel which is glass beaded to a matte finish

Catalog #	Description
130-245	4¾" (120mm), 1 x 2 teeth, serrated

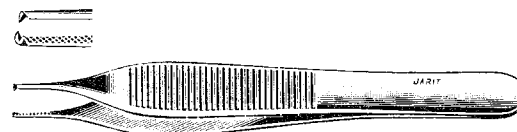

Brown-Adson Tissue Forceps, 9 x 9 teeth, (Satin Finish)

Manufactured from high grade German surgical stainless steel which is ground and polished to a satin finish

Catalog #	Description
130-260	4 ⁷ / ₈ " (124mm)

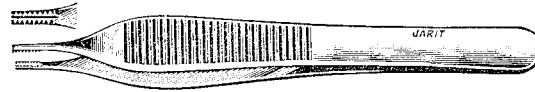

Brown-Adson Tissue Forceps, 9 x 9 teeth, (Mirror Finish)

Manufactured from high grade German surgical stainless steel which is ground and polished to a mirror finish

Catalog #	Description
129-260	4 ⁷ / ₈ " (124mm)

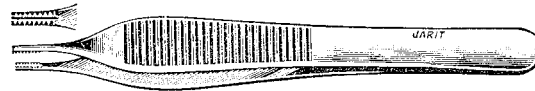

Beasley-Babcock Tissue Forceps

6 x 7 teeth

Catalog #	Description
130-262	4 ⁷ / ₈ " (124mm)

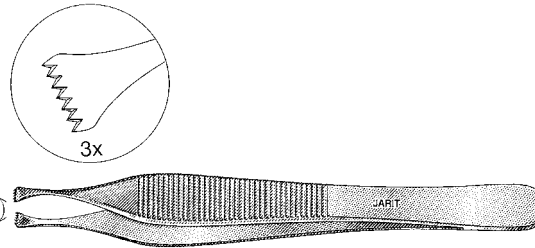

Brown Tissue Forceps

8 x 8 teeth

Catalog #	Description
130-265	6" (151mm)
130-266	8" (202mm)
130-267	10" (251mm)



Brown-Adson Tissue Forceps, (Satin Finish)

9 x 9 teeth, angled

Catalog #	Description
130-270	4 ⁷ / ₈ " (124mm)

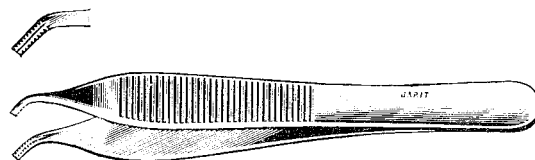

Semken Dressing Forceps
serrated

Catalog #	Description
130-275	5" (126mm)
130-276	6" (152mm)



Semken Tissue Forceps

Catalog #	Description
130-280	5" (126mm), 1 x 2 teeth
130-281	6" (154mm), 1 x 2 teeth
130-282	5" (126mm), 2 x 3 teeth

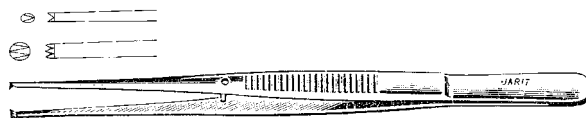

McIndoe Dressing Forceps

Catalog #	Description
130-284	6" (153mm), serrated

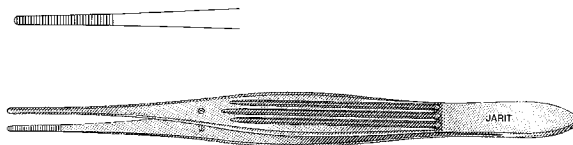

Gillies Tissue Forceps

Catalog #	Description
130-286	6" (152mm), 1 x 2 teeth, cross-serrated

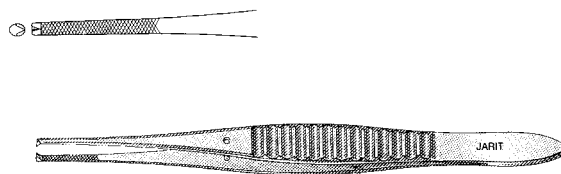

Ferris-Smith Tissue Forceps

Catalog #	Description
130-289	6 3/4" (174mm), 1 x 2 teeth
130-290	6 3/4" (174mm), 2 x 3 teeth

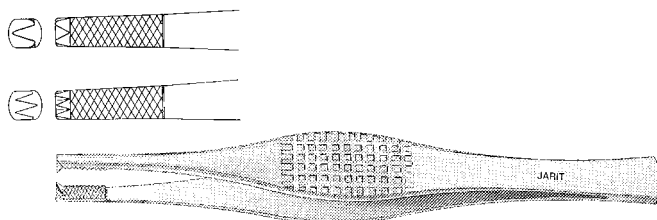

Bonney Tissue Forceps

3.4mm wide x 26mm length serrated jaws

Catalog #	Description
130-293	6¾" (173mm), 1 x 2 teeth
130-294	6¾" (173mm), 2 x 3 teeth

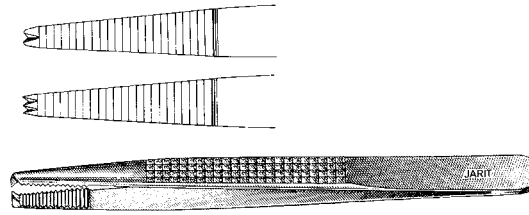

Nelson Tissue Forceps

6 x 7 teeth

Catalog #	Description
130-370	6" (152mm)

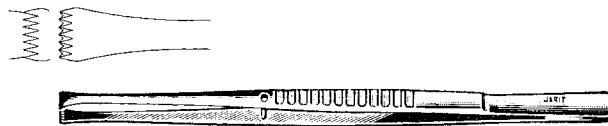

Cushing Tissue Forceps

straight, 1 x 2 teeth, scraper end

Catalog #	Description
130-405	6¾" (171mm), 1.5mm tips



Cushing Tissue Forceps

bayonet, 1 x 2 teeth, scraper end

Catalog #	Description
130-415	7¼" (181mm), 1.7mm tips

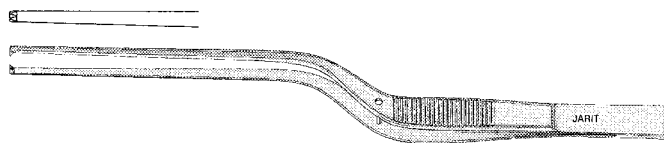

Cushing-Brown Tissue Forceps

straight, double row of 9 x 9 delicate teeth, scraper end

Catalog #	Description
130-440	6¾" (174mm)

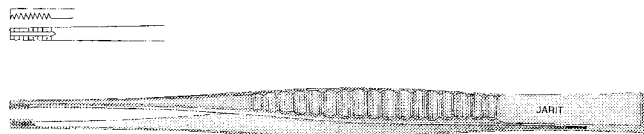

Cushing-Brown Tissue Forceps

bayonet, double row of 9 x 9 delicate teeth, scraper end

Catalog #	Description
130-442	7" (180mm)

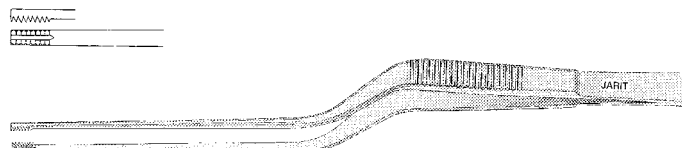

Adson Needle and Tissue Pulling Forceps, Carb-Bite

1 x 2 teeth

Catalog #	Description
122-500	4 ⁷ / ₈ " (123mm)
122-501	4 ⁵ / ₈ " (119mm), delicate
122-502	5 ⁷ / ₈ " (150mm)
122-503	5 ⁷ / ₈ " (150mm), delicate

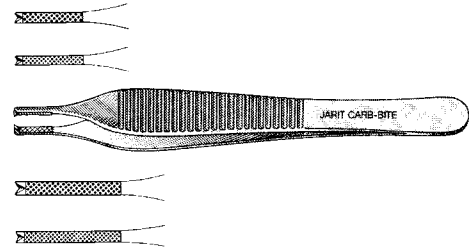

Brown-Adson Needle and Tissue Pulling Forceps, Carb-Bite

3 x 4 teeth

Catalog #	Description
122-510	4 ⁷ / ₈ " (124mm)

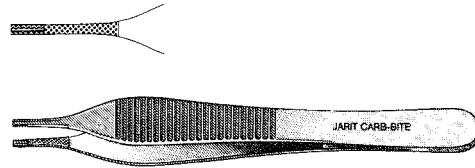

Cushing Needle and Tissue Pulling Forceps, Carb-Bite

Catalog #	Description
122-530	7" (176mm), Gutsch handle, scraper end, 1.8mm wide x 12mm length
122-535	7" (176mm), Delicate, 1.6mm wide x 8mm length

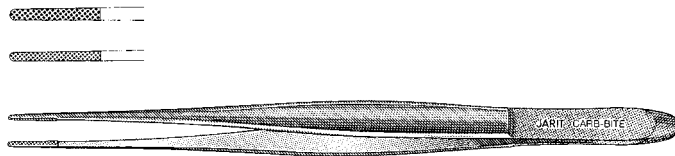

Semken Needle and Tissue Pulling Forceps, Carb-Bite

1 x 2 teeth

Catalog #	Description
122-590	6" (153mm), 1.7mm x 12mm tips
122-591	6" (153mm), 1mm x 12mm tips, delicate

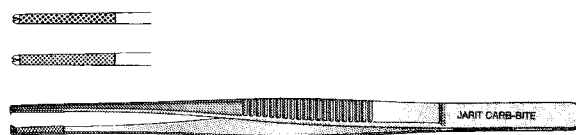

Joseph Nasal Saws

7½" (190mm), 1.3mm x 36mm saw blades

Catalog #	Description
420-100	Bayonet blade angled left
420-101	Bayonet blade angled right

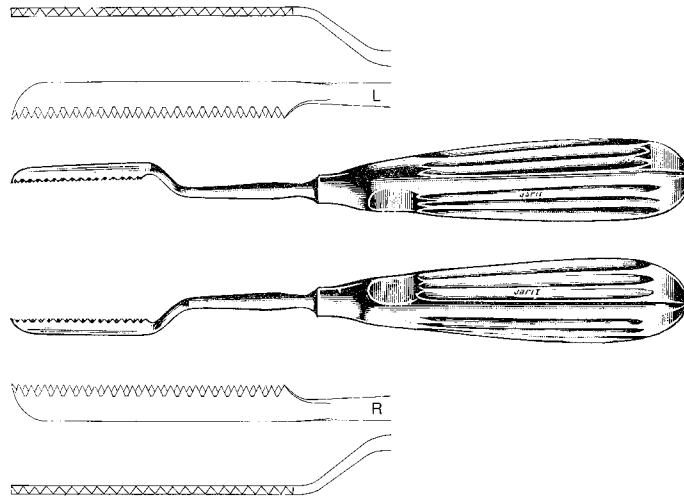

Joseph Nasal Saw

7¼" (183mm), 1.3mm x 36mm saw blades

Catalog #	Description
420-102	Straight

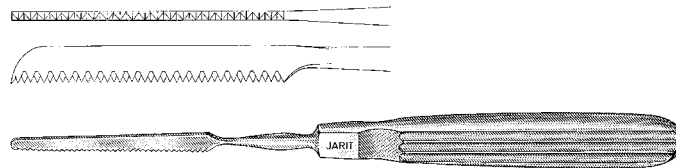

Stardust Diamond Rasps

7½" (190mm), 7mm x 25mm blade

Catalog #	Description
420-110	Straight
420-111	Curved

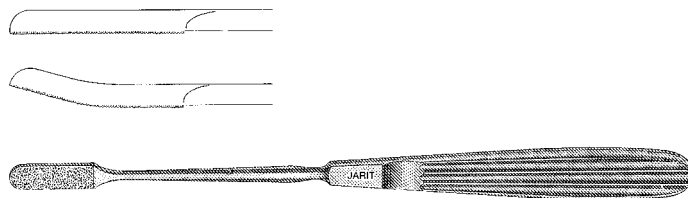

Converse Rasp

7" (178mm), double-ended, 11mm x 53mm, cuts on the down stroke

Catalog #	Description
420-120	Fine and coarse ends

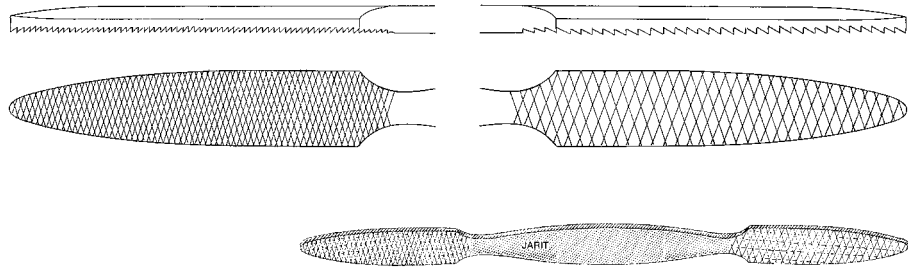

Fomon Rasps

8 1/2" (216mm), double-ended, convex and flat sides, 7mm x 35mm, cuts on down stroke

Catalog #	Description
420-125	Fine
420-126	Coarse

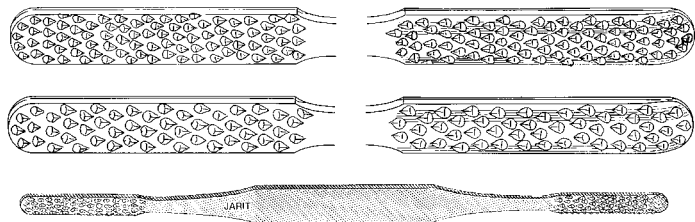

Cottle Rasp

8" (204mm), 7.5mm x 36mm, cuts on down stroke

Catalog #	Description
420-130	Fine

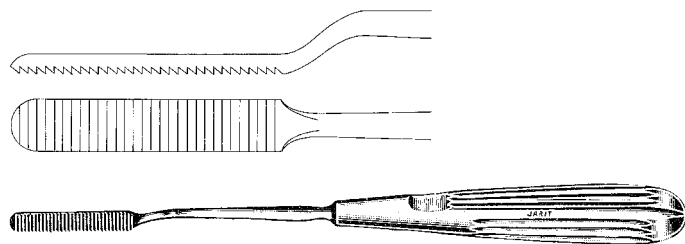

Fomon Rasp

8½" (216mm), 7mm x 42mm, double-ended, cuts on down stroke

Catalog #	Description
420-132	Fine and course ends

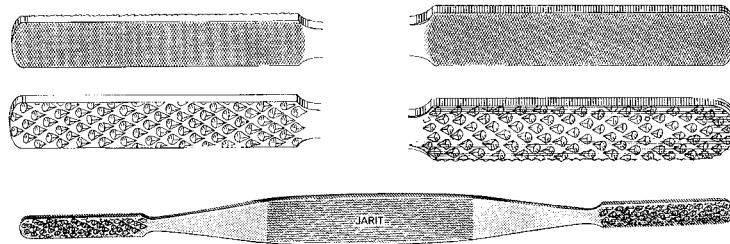

Maltz Rasp

6½" (165mm), 8mm x 35mm

Catalog #	Description
420-135	Cuts on down stroke

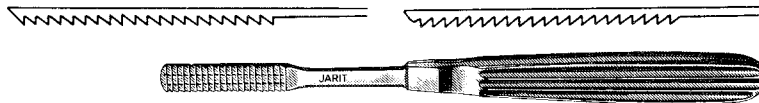

Maltz-Anderson Rasp

6½" (165mm), 8mm x 36mm

Catalog #	Description
420-136	Cuts on up stroke

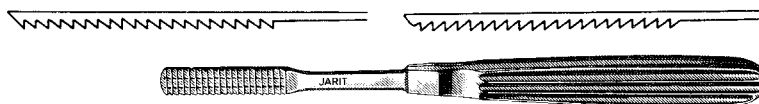

Parkes Rasps

8" (203mm), 8.7mm x 32mm, cuts on down stroke

Catalog #	Description
420-138	20 fine concave teeth
420-139	11 extra coarse concave teeth

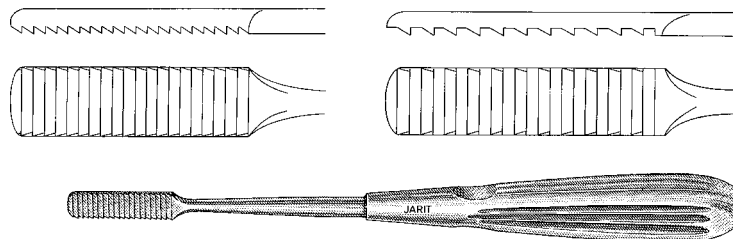

Aufricht Rasps

8 1/4" (210mm), 8.5mm x 30mm

Catalog #	Description
420-140	Cuts on up stroke
420-141	Cuts on down stroke

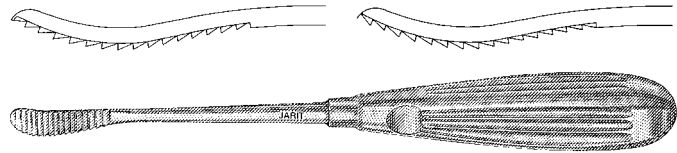

Lewis Rasp

7" (180mm), 7.5mm x 15mm

Catalog #	Description
420-145	Cuts on down stroke

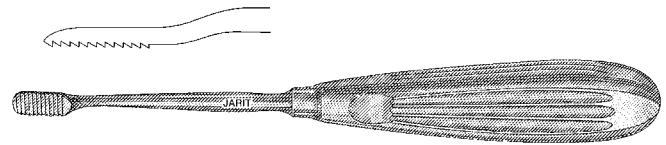

Joseph Rasp

cuts on the upstroke, 7" (180mm), 8mm x 40mm

Catalog #	Description
420-147	Coarse teeth

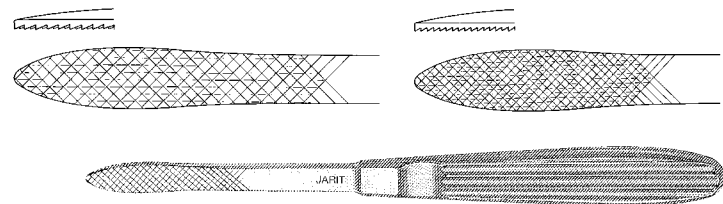

Joseph Rasp

cuts on the upstroke, 7 1/4" (184mm), 7.5mm x 40mm

Catalog #	Description
420-148	Fine teeth

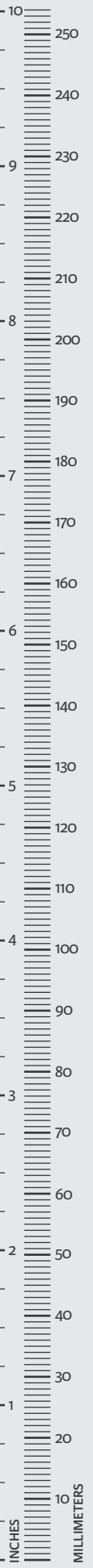
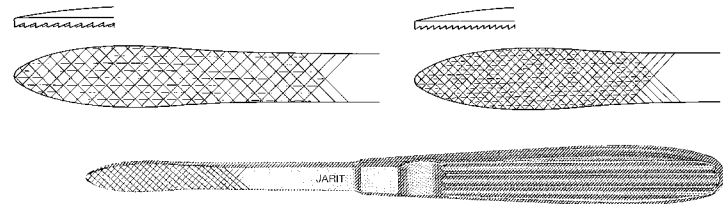

Kleinert-Kutz Rasp

8¼" (210mm), double-ended,
8mm x 47mm convex coarse side and flat fine side

Catalog #	Description
420-150	Cuts on down stroke

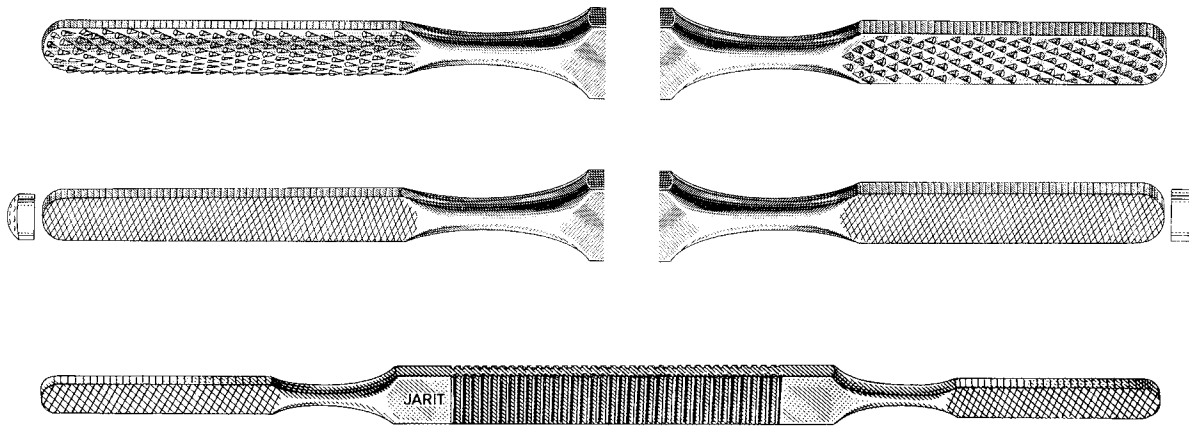

Wire Brush

6¼" (160mm), stainless

Catalog #	Description
420-155	For cleaning rasps and files

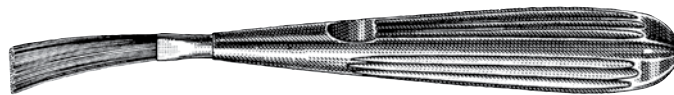

Dingman Otoabradors

6⅞" (156mm), double row of 10 fine teeth, 6.3mm long

Catalog #	Description
420-160	Curved left
420-161	Curved right

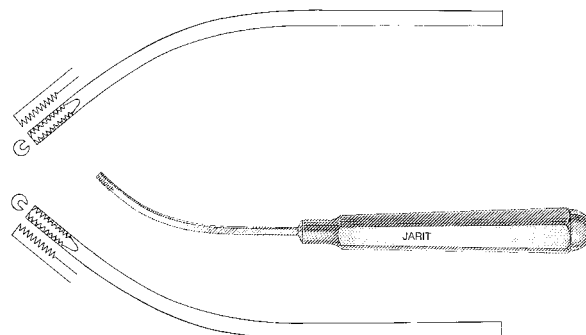

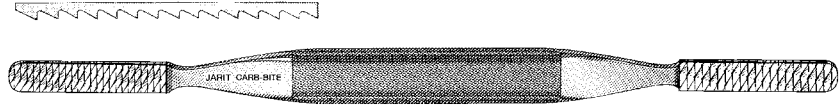

Nasal Rasps, Double-Ended, Carb-Bite

8 1/4" (210mm), double-ended, 7mm x 40mm, cuts on down stroke

Catalog #	Description		Description	
420-170	No. 1: very fine grit		No. 2: fine grit	
420-171	No. 3: fine grit		No. 4: coarse grit	
420-172	No. 5: coarse grit		No. 6: coarse grit	
420-173	No. 7: coarse grit		No. 8: very coarse grit	



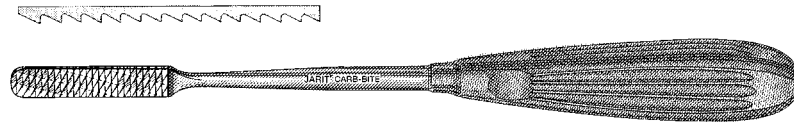

Nasal Rasps, Single-Ended, Carb-Bite

8¼" (210mm), single-ended, 7mm x 40mm, cuts on down stroke

Catalog #	Description	
420-175	No. 1: very fine grit	
420-176	No. 2: fine grit	
420-177	No. 3: fine grit	
420-178	No. 4: coarse grit	
420-179	No. 5: coarse grit	
420-180	No. 6: coarse grit	
420-181	No. 7: coarse grit	
420-182	No. 8: very coarse grit	

Glabella Rasp, Carb-Bite

8¼" (210mm), 5.5mm x 10mm

Catalog #	Description
420-184	Cuts on down stroke

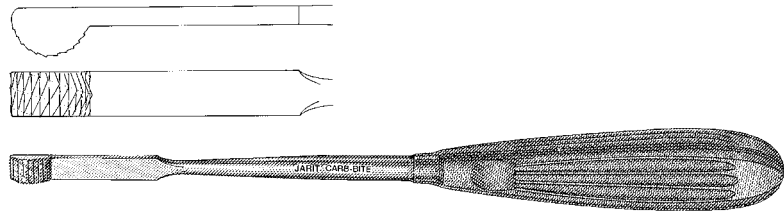

Cottle Columella Clamp

4¾" (110mm)

Catalog #	Description
420-210	Jaw width 12mm

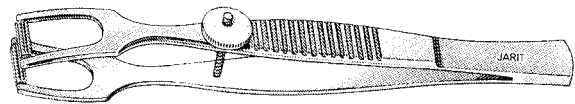

Integra[™]
Post Nasal &
Sinus Endoscopy
Instruments and
General Surgical
Instruments

La Force Adenotomes

8⁷/₈" (225mm)

Catalog #	Description
430-102	Small size 1: 12mm cut
430-103	Medium size 2: 16mm cut
430-104	Large size 3: 18mm cut

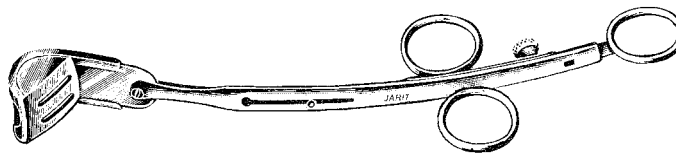

La Force Adenotome Blades

Catalog #	Description
430-105	Size 0: 11mm wide blade to fit 0 size Adenotome
430-107	Size 1: 12mm wide blade to fit 430-102
430-108	Size 2: 16mm wide blade to fit 430-103
430-109	Size 3: 18mm wide blade to fit 430-104

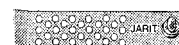

Shambaugh Adenotomes

8¹/₂" (215mm)

Catalog #	Description
430-120	Small size 1: 12mm cut
430-121	Medium size 2: 16mm cut
430-122	Large size 3: 18mm cut

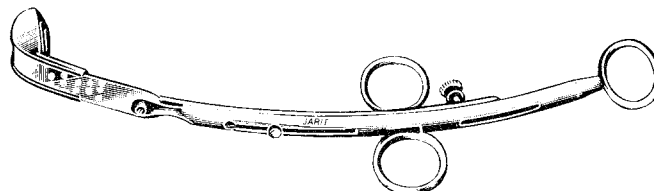

Shambaugh Adenotome Blades

Catalog #	Description
430-126	Size 1: 12mm wide blade to fit 430-120
430-127	Size 2: 16mm wide blade to fit 430-121
430-128	Size 3: 18mm wide blade to fit 430-122



Jones Adenoid Curettes

Catalog #	Description
430-135	Infant size: 4mm cutting edge, 8 ³ / ₈ " (213mm)
430-136	Child size: 6mm cutting edge, 8 ³ / ₄ " (225mm)
430-137	Adult size: 8mm cutting edge, 8 ³ / ₄ " (225mm)

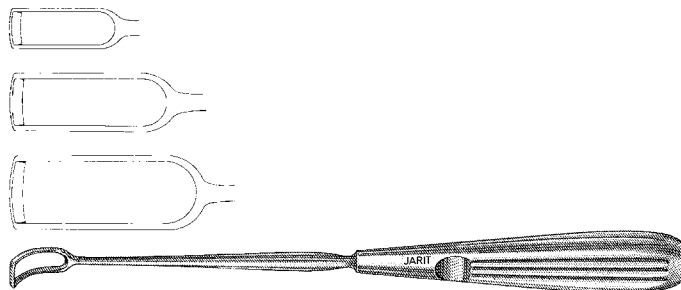

Vogel Adenoid Curette

8 3/8" (213mm)

Catalog #	Description
430-140	7mm cutting edge

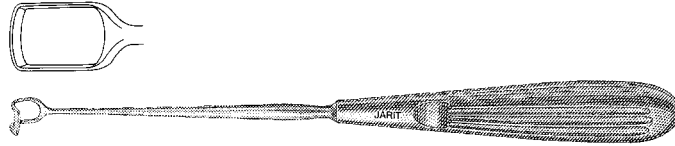

Barnhill Adenoid Currettes

8 1/2" (216mm)

Catalog #	Description
430-145	Size 0: 10.5mm cutting edge
430-146	Size 1: 12.5mm cutting edge
430-147	Size 2: 14.5mm cutting edge
430-148	Size 3: 16.5mm cutting edge
430-149	Size 4: 18.5mm cutting edge

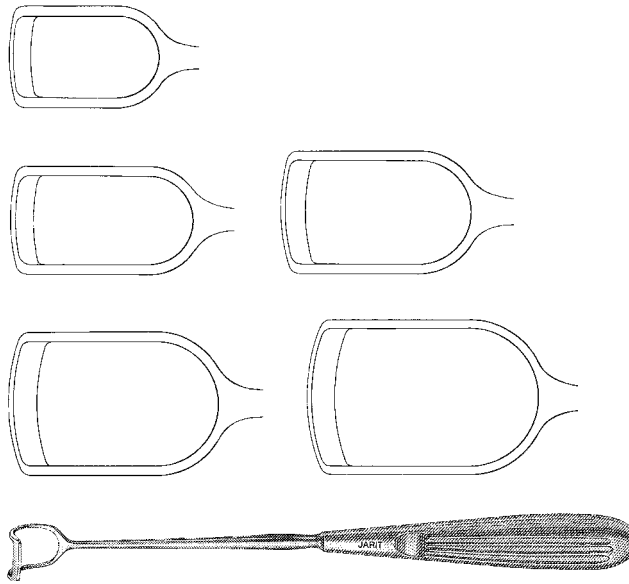

Middleton Adenoid Curette

9" (228mm)

Catalog #	Description
430-150	7.5mm cutting edge

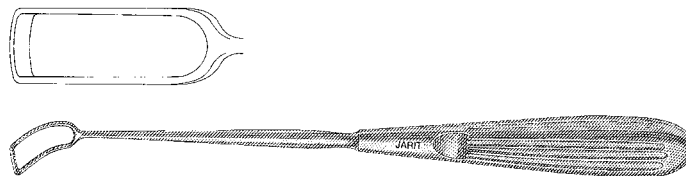

Stubbs Adenoid Currettes

8 1/2" (219mm)

Catalog #	Description
430-155	Size 0: 10mm cutting edge
430-156	Size 1: 12mm cutting edge
430-157	Size 2: 14mm cutting edge

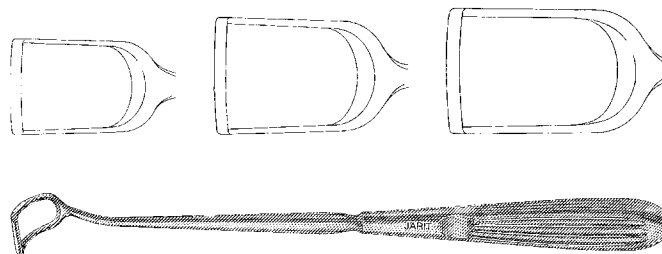

Reverse Curve Adenoid Curettes
8 1/2" (216mm)

Catalog #	Description
430-160	Size 0: 10.5mm cutting edge
430-161	Size 1: 12.5mm cutting edge
430-162	Size 2: 14.5mm cutting edge
430-163	Size 3: 16.5mm cutting edge
430-164	Size 4: 18.5mm cutting edge

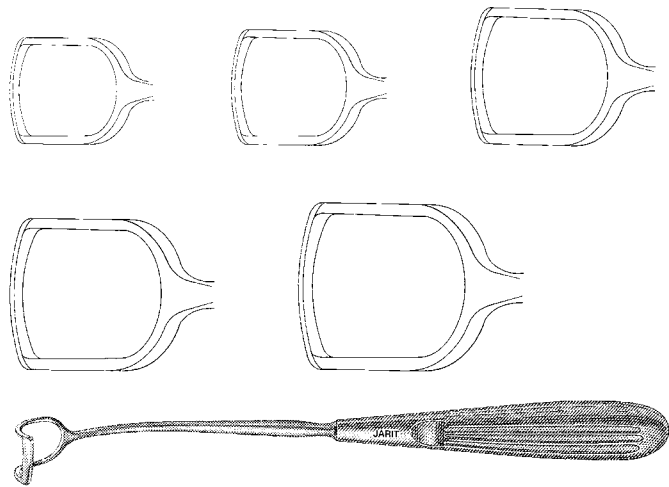

Hartman (Meltzer) Adenoid Punches
5 1/2" (140mm) working length, round

Catalog #	Description
430-200	No. 0: 7mm bite
430-201	No. 1: 8mm bite
430-202	No. 2: 9mm bite

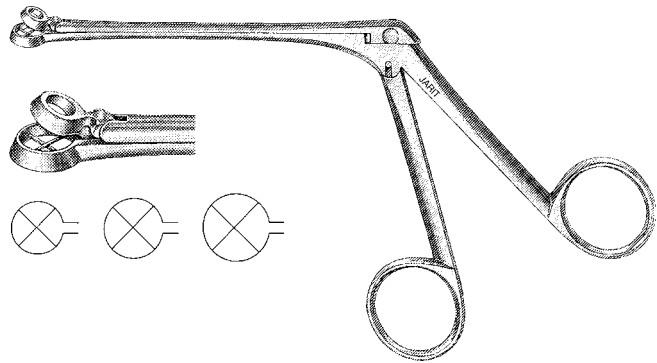

Schmeden (Meltzer) Adenoid Punches
5 1/2" (140mm) working length, triangular

Catalog #	Description
430-210	No. 0: 6mm bite
430-211	No. 1: 7mm bite
430-212	No. 2: 8mm bite

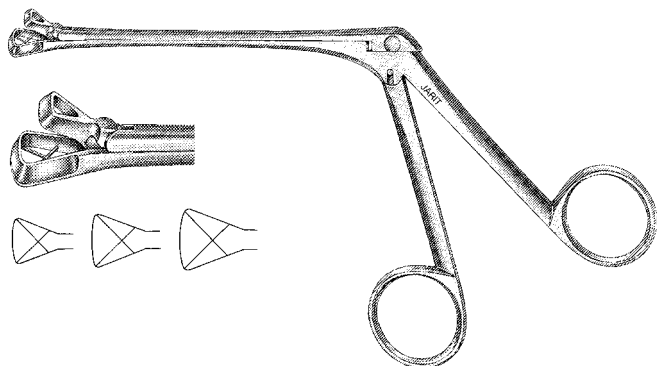

Ronis Adenoid Punches

5 1/8" (130mm) working length, up-curved, triangular

Catalog #	Description
430-220	No. 0: 6mm bite
430-221	No. 1: 7mm bite
430-222	No. 2: 8mm bite

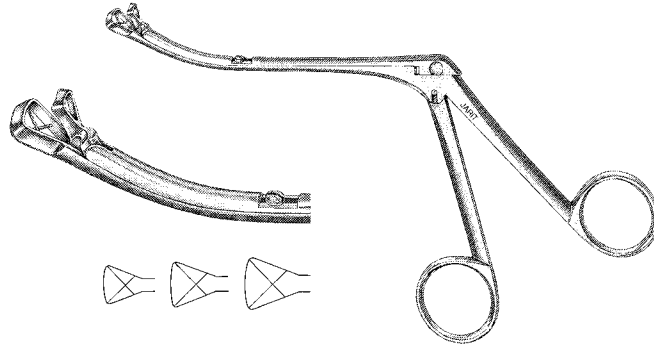

King Adenoid Punch

4 1/2" (115mm) working length, down-curved, triangular

Catalog #	Description
430-225	No. 1: 7mm bite

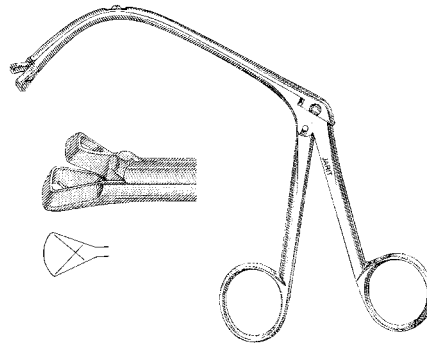

Love Uvula Retractors

4 1/8" (104mm) handle, 3 7/8" (97mm) working length

Catalog #	Description
430-240	18mm wide blade
430-241	20mm wide blade
430-242	22mm wide blade

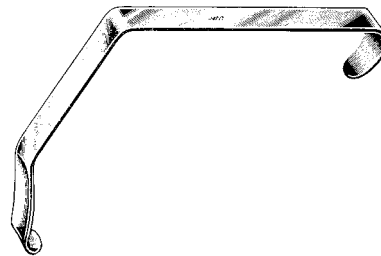

Lothrop Uvula Retractor

5 1/4" (133mm) working length

Catalog #	Description
430-245	17mm x 20mm blade

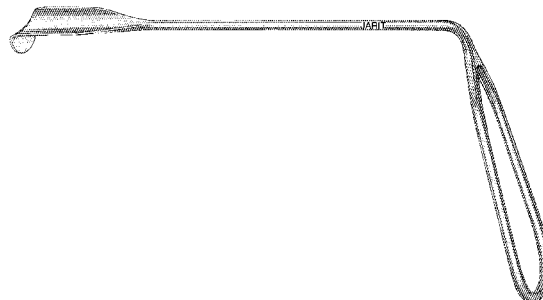

Freer Double-ended Elevators

7¾" (198mm), sharp-blunt blades

Catalog #	Description
285-379	6.5mm wide blades
285-380	4.5mm wide blades

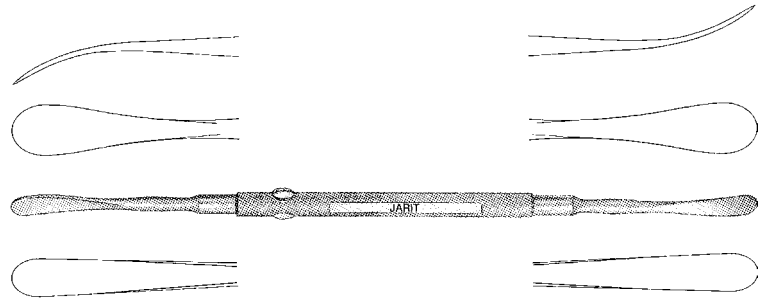

Frazier Suction Tubes

7½" (193mm), angular,
working length 4" (102mm)

Catalog #	Description
285-449	5 French
285-450	6 French
285-451	7 French
285-452	8 French
285-453	9 French
285-454	10 French
285-455	11 French
285-456	12 French
285-457	14 French
285-458	15 French

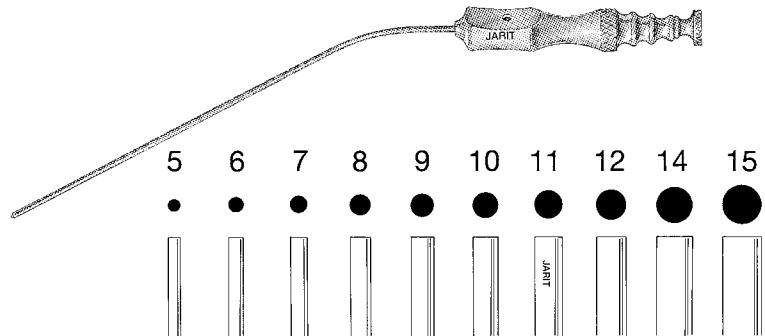

*For stylets (angled Frazier Suction Tube only)
add the letter "S" to catalog number.

Tiek-Halle Infant Nasal Speculum

Catalog #	Description
400-110	5 $\frac{1}{8}$ " (130mm), 17mm blades

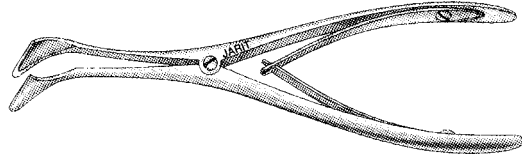

Killian Septum Specula

Catalog #	Description
400-130	5 $\frac{3}{8}$ " (136mm), 50mm blades
400-131	5 $\frac{3}{4}$ " (145mm), 65.5mm blades
400-132	5 $\frac{7}{8}$ " (148mm), 76.5mm blades
400-134	6" (153mm), 91mm blades

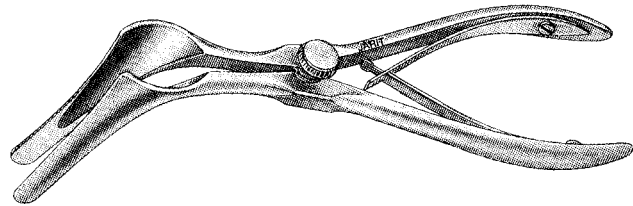

Hartman Nasal Speculum

Catalog #	Description
400-135	6 $\frac{1}{4}$ " (160mm), 33.5mm blades

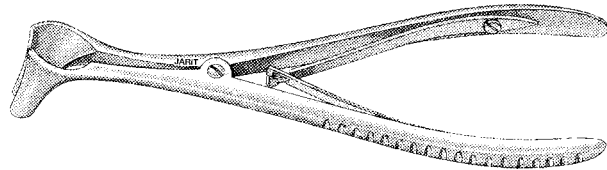

Cottle Septum Speculum

Catalog #	Description
400-136	5 $\frac{1}{2}$ " (140mm), 50mm thin blades, tapered to 3.4mm wide

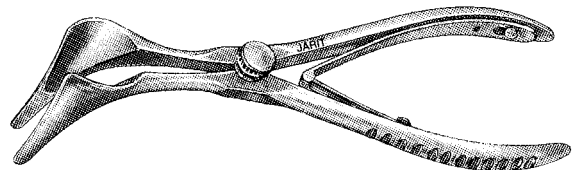

Knight Nasal Scissors

Catalog #	Description
400-180	6 $\frac{3}{4}$ " (171mm), 30mm blades

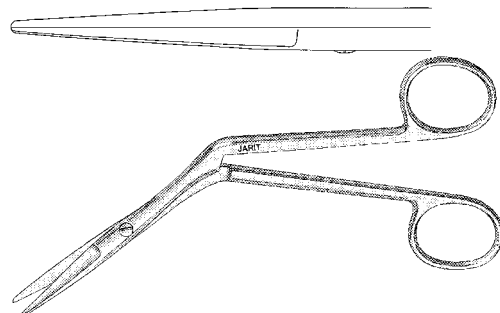

Knight Nasal Scissors, Supercut

Catalog #	Description
102-180	6 3/4" (171mm), 30mm blades

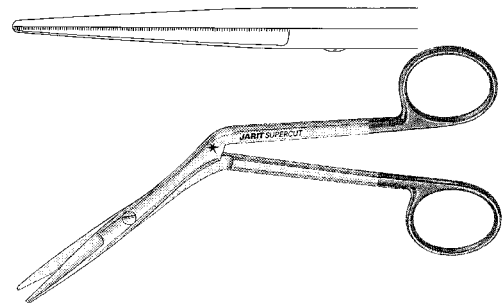

Ostium Seeker Ball End Elevator

Catalog #	Description
400-273	7 1/2" (190mm), double-ended, 2.0mm and 2.5mm diameter ball tips

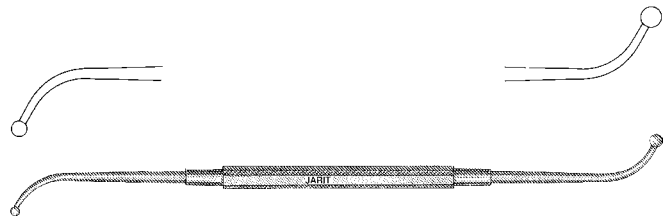

Cottle Septum Elevator

Catalog #	Description
400-277	9" (229mm), double-ended, graduated, 4.9mm wide blade and 4.6mm wide round end

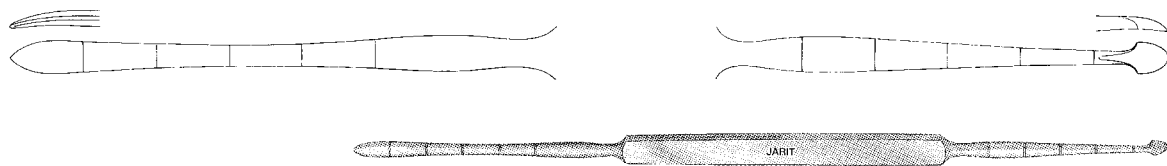

Coakley Curettes

7 1/2" (190mm), 7mm x 10mm

Catalog #	Description
400-307	Backward cutting
400-308	Forward cutting

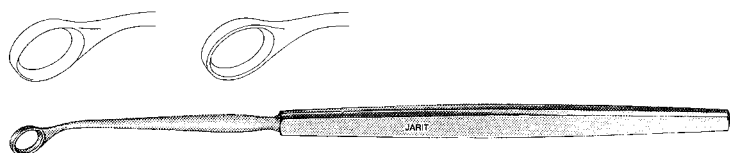

Blakesley Forceps

4½" (115mm) working length, fenestrated jaws

Catalog #	Description
440-110	Straight, size 0, 3.5mm jaw width
440-114	Straight, size 1, 4mm jaw width
440-118	Straight, size 2, 5mm jaw width

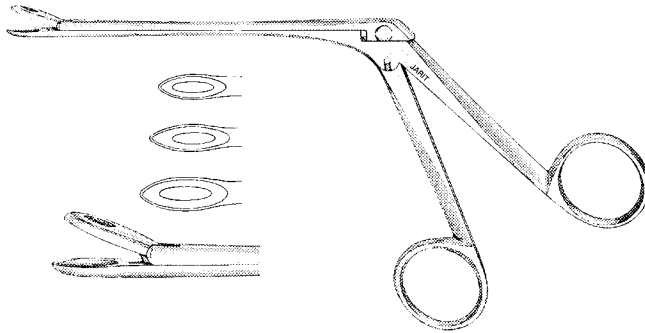

Blakesley Forceps

4½" (115mm) working length, fenestrated jaws

Catalog #	Description
440-130	Up-angled, 45°, size 0, 3.5mm jaw width
440-134	Up-angled, 45°, size 1, 4mm jaw width
440-138	Up-angled, 90°, size 0, 3.5mm jaw width
440-140	Up-angled, 90°, size 1, 4mm jaw width

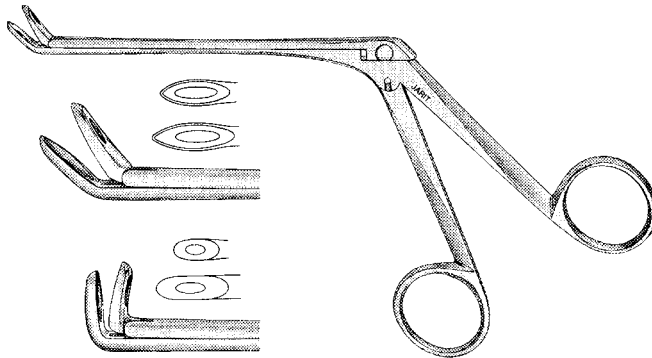

Struempel Pediatric Forceps

4⅞" (105mm) working length, fenestrated jaws, 2.4mm jaw width

Catalog #	Description
440-150	Straight
440-154	Up-angled 45°
440-158	Up-angled 90°

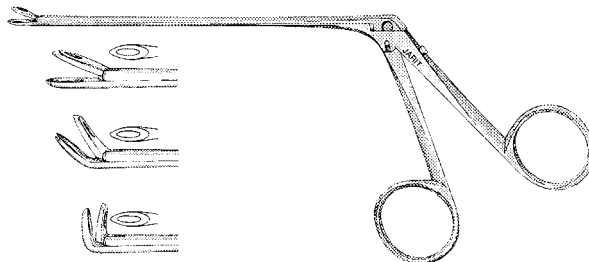

Blakesley Thru-Cutting Forceps

4 1/2" (115mm) working length

Catalog #	Description
440-160	Straight, size 0, 3.5mm jaw width
440-161	Straight, size 1, 4mm jaw width
440-162	Up-angled 45°, size 0, 3.5mm jaw width
440-163	Up-angled 45°, size 1, 4mm jaw width
440-164	Angled right, size 0, 3.5mm jaw width
440-165	Angled left, size 0, 3.5mm jaw width

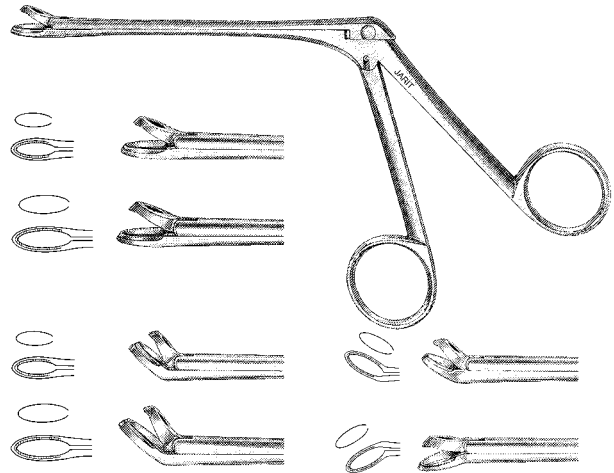

Blakesley Pediatric Thru-Cutting Forceps

4 1/2" (115mm) working length,
size 00, 2.5mm jaw width

Catalog #	Description
440-166	Straight
440-167	Up-angled 45°

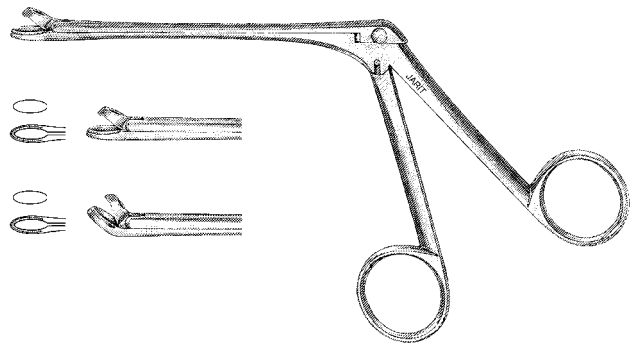

Blakesley Suction Forceps

4" (100mm) working length,
fenestrated jaws

Catalog #	Description
440-174	Straight, size 0, 3.5mm jaw width
440-178	Straight, size 1, 4mm jaw width
440-184	Up-angled, size 0, 3.5mm jaw width
440-186	Up-angled, size 1, 4mm jaw width
440-532	Cleaning Brush 8" (205mm), 27mm x 3.5mm, package of 6

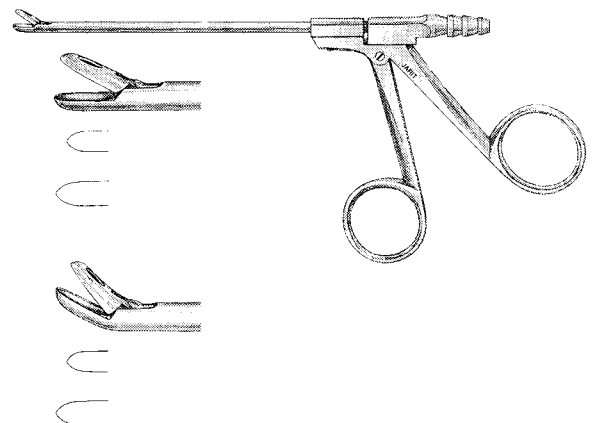

Blakesley Pediatric Suction Forceps

4" (100mm) working length,
size 00, 2.5mm wide fenestrated jaws

Catalog #	Description
440-170	Straight
440-182	Up-angled
440-532	Cleaning Brush 8" (205mm), 27mm x 3.5mm, package of 6

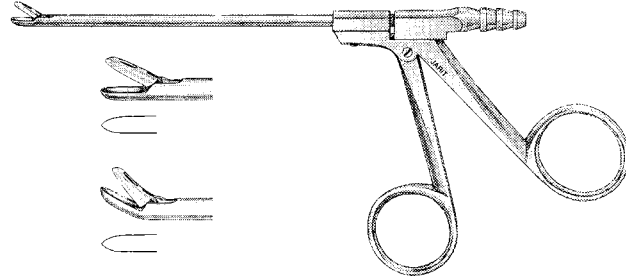

Nasal Alligator Scissors

4½" (115mm) working length,
tapered 11mm blades

Catalog #	Description
440-200	Straight
440-202	Right
440-204	Left

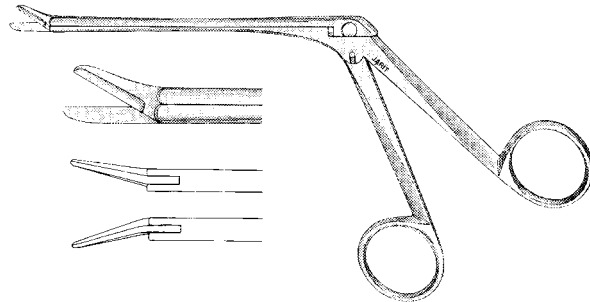

Struycken Nasal Cutting Forceps

Catalog #	Description
440-208	4½" (115mm) working length, 1mm bite

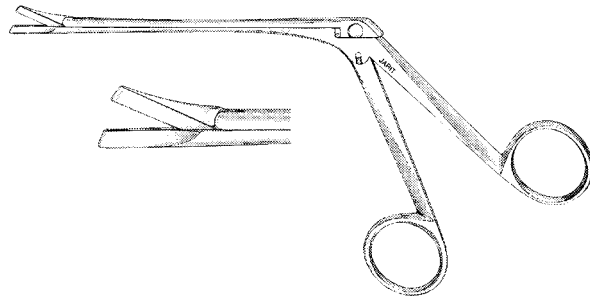

Takahashi Forceps

4½" (115mm) working length

Catalog #	Description
440-300	Straight, 2.5mm bite
440-304	Straight, 4mm bite
440-306	Up-angled, 2.5mm bite

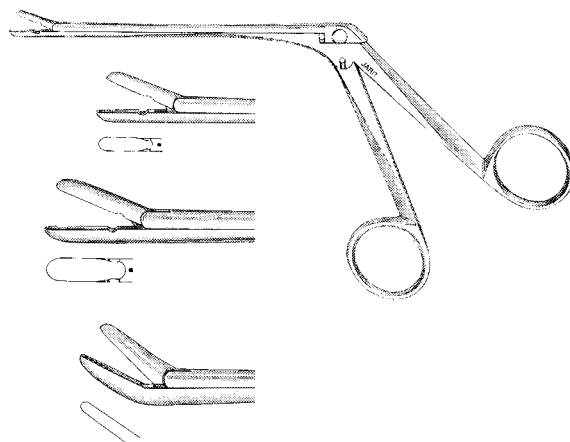

Takahashi Suction Forceps

Catalog #	Description
440-308	4" (100mm) working length, straight 3.5mm jaw width
440-532	Cleaning Brush, 8" (205mm), 27mm x 3.5mm, package of 6

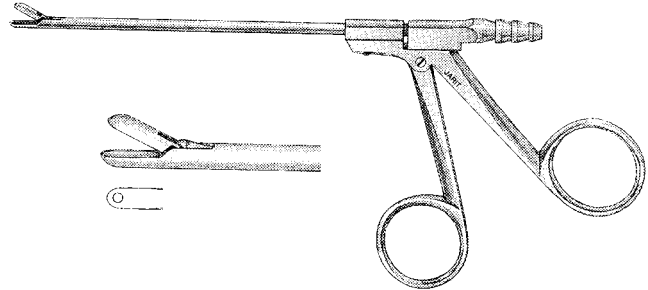

Giraffe Frontal Sinus Forceps w/luer lock port
5 1/8" (130mm) working length, double-action 3mm jaw width

Catalog #	Description
440-310	Straight
440-312	70°, vertical
440-314	70°, horizontal
440-316	110°, vertical
440-318	110°, horizontal

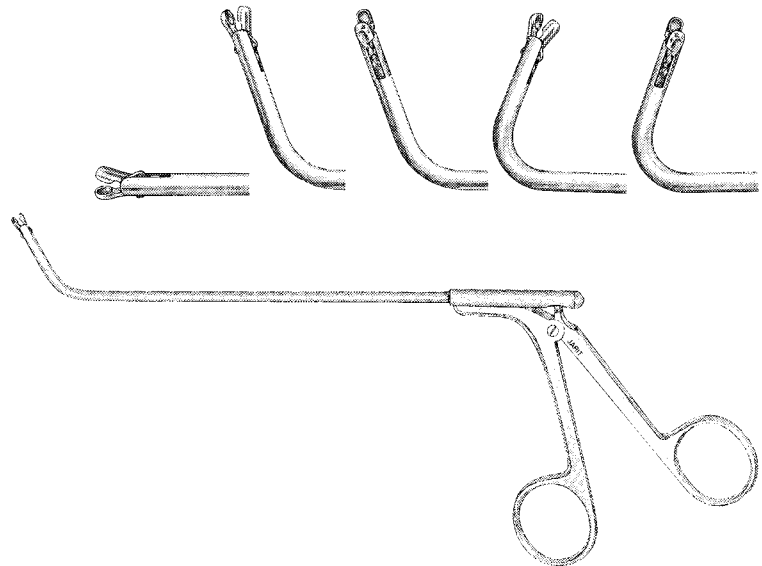

Hajek-Koffler Punches

5½" (140mm) working length, 4mm bite, 8.5mm opening

Catalog #	Description
440-340	Upward cutting, 90°
440-342	Downward cutting, 90°
440-344	Forward cutting, 45°
440-346	Backward cutting, 45°

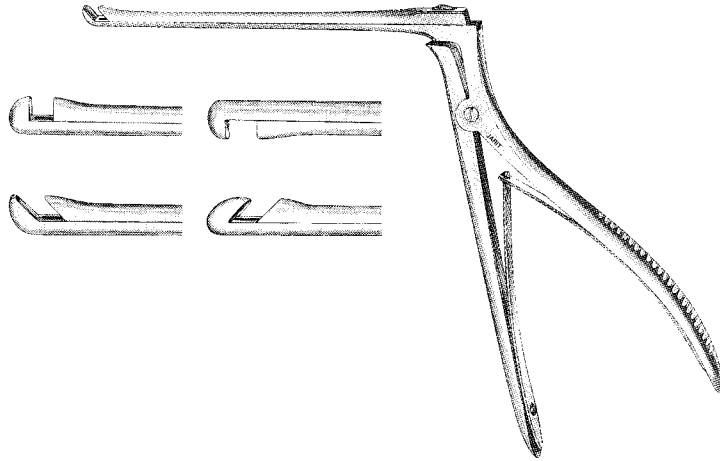

Hajek-Koffler Punch

Catalog #	Description
440-348	4⅞" (106mm) working length, rotatable, 3mm bite, 6.5mm opening

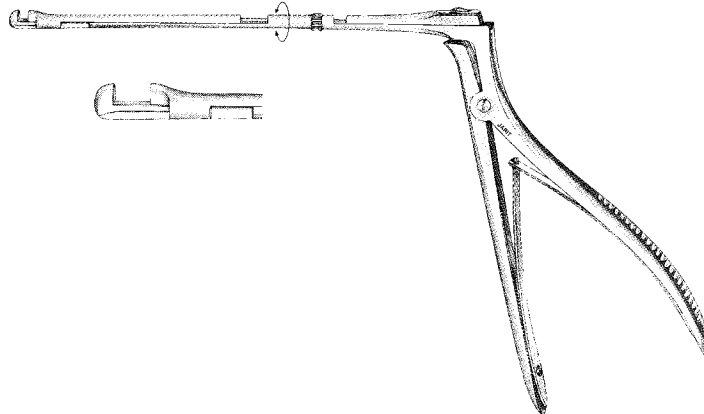

McKenty Punch

Catalog #	Description
440-350	3⅜" (85mm) working length, rotatable, 2mm bite, 5.5mm opening

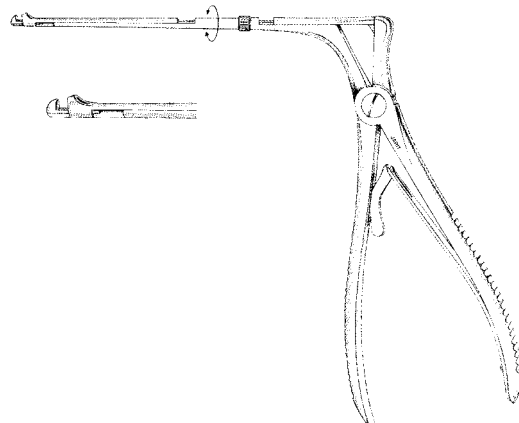

Ostrum Antrum Suction Punches

4" (102mm) working length, 2.5mm bite, backward cutting

Catalog #	Description
440-360	Straight
440-364	Right
440-368	Left
440-532	Cleaning Brush, 8" (205mm), 27mm x 3.5mm, package of 6

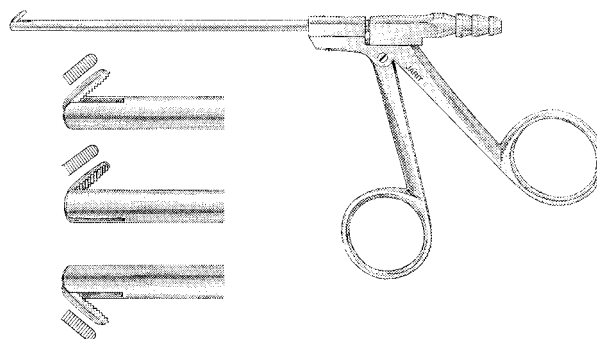

Ostrum Antrum Punch

Catalog #	Description
440-370	4½" (115mm) working length, rotatable, adult, 2.5mm bite, backward cutting

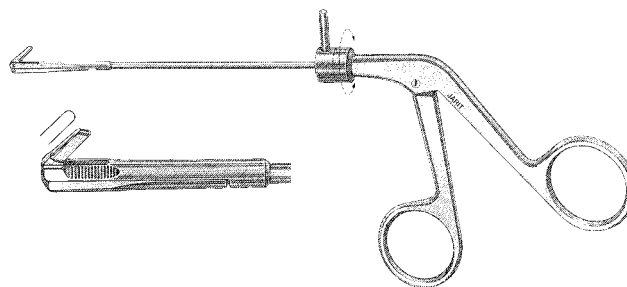

Ostrum Antrum Pediatric Suction Punches

4" (102mm) working length, 2mm bite, backward cutting

Catalog #	Description
440-372	Straight
440-376	Right
440-378	Left
440-532	Cleaning Brush, 8" (205mm), 27mm x 3.5mm, package of 6

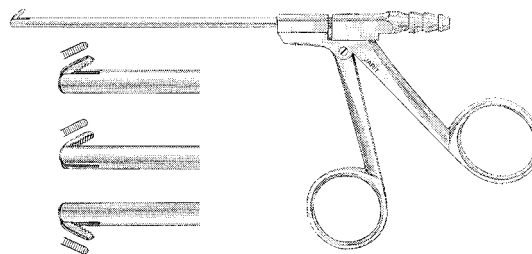

Ostrum Antrum Pediatric Punch

Catalog #	Description
440-380	4½" (115mm) working length, rotatable, 1.5mm bite, backward cutting

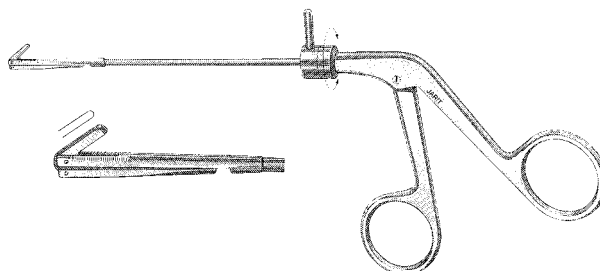

Von Eicken Suction Cannulas

5³/₄" (146mm)

Catalog #	Description
440-390	Curved long, 3mm
440-394	Curved short, 3mm
440-398	Curved short, 4mm
440-530	Cleaning Brush, 8" (205mm), 27mm x 3.5mm, package of 6

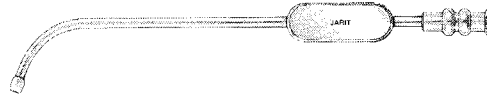

Antrum Curettes

oblong

Catalog #	Description
440-400	7 ¹ / ₂ " (190mm), 2mm x 5mm cup
440-402	7 ¹ / ₂ " (190mm), 3.7mm x 9.5mm cup
440-404	7 ¹ / ₂ " (190mm), 7mm x 11mm cup
440-406	7 ¹ / ₂ " (190mm), 8mm x 11mm cup
440-407	7 ¹ / ₂ " (190mm), 2mm x 5mm cup, 45°
440-408	7" (180mm), 2.5mm x 5mm cup, 90°

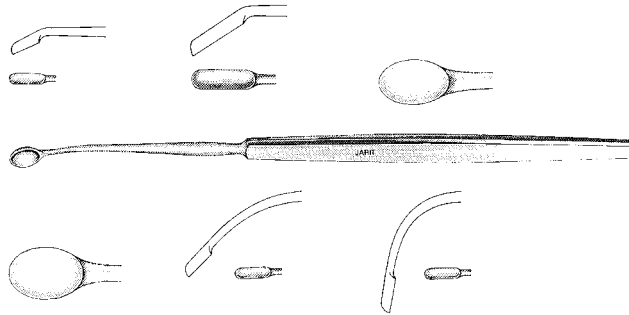

Sinus Sickle Knives

7¹/₂" (193mm)

Catalog #	Description
440-410	Pointed tip: 11mm blade
440-412	Blunt tip: 10.5mm blade



Sinus Septum Needle

Catalog #	Description
440-416	5 ¹ / ₈ " (130mm) overall length, angled, 23 gauge, 1/2" (14mm) needle length

440-CAP-416 Replacement Protective Cap

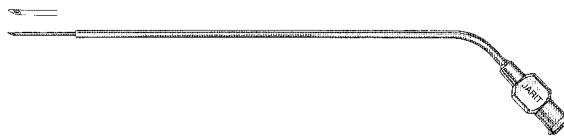

Frontal Ostium Seeker

Catalog #	Description
440-420	8" (203mm), double-ended, one end 90° to shaft

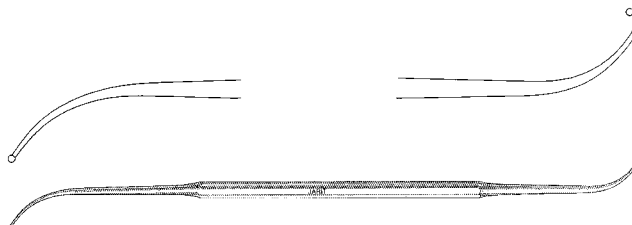

Sinoscopy Trocar and Cannula

Catalog #	Description
440-430	Cannula 3 ¹ / ₄ " (83mm), Trocar 6 ¹ / ₂ " (165mm), 5mm wide

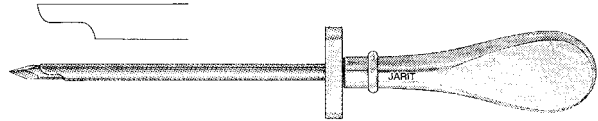

Tray for Sinuscope

Catalog #	Description
440-510	6" x 15 ¹ / ₄ " x 3 ¹ / ₂ " (152mm x 390mm x 90mm), holds two sinuscopes

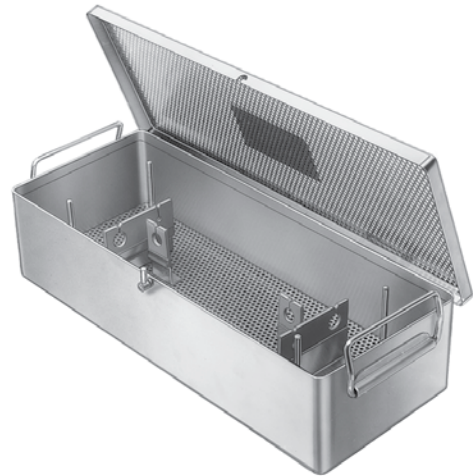

Sinuscopes, Autoclavable

6⁷/₈" (175mm) working length

Catalog #	Description
440-700	4mm, 0°
440-730	4mm, 30°
440-770	4mm, 70°
440-720	2.7mm, 0°
440-740	2.7mm, 30°

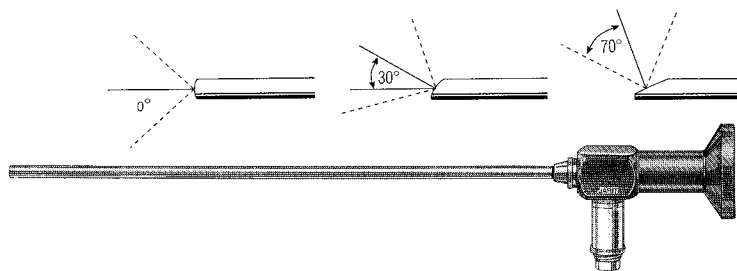

Integra[™]
Throat & Laryngeal
Instruments and
General Surgical
Instruments

Dingman Mouth Gag

Catalog #	Description
450-090	Complete with 3 tongue blades

Dingman Tongue Blades

Catalog #	Description
450-091	Small blade: 25mm wide x 62mm deep x 136mm long
450-092	Medium blade: 29mm wide x 65mm deep x 136mm long
450-093	Large blade: 32mm wide x 75mm deep x 136mm long
450-FRM-090	Replacement Frame (70mm x 144mm)
450-WSR-090	Replacement Washer for Side Blade
450-BLD-090	Replacement Side Blade
450-SBA-090	Replacement Side Blade Attachment
450-SRW-090	Replacement Screws Pkg/8ea

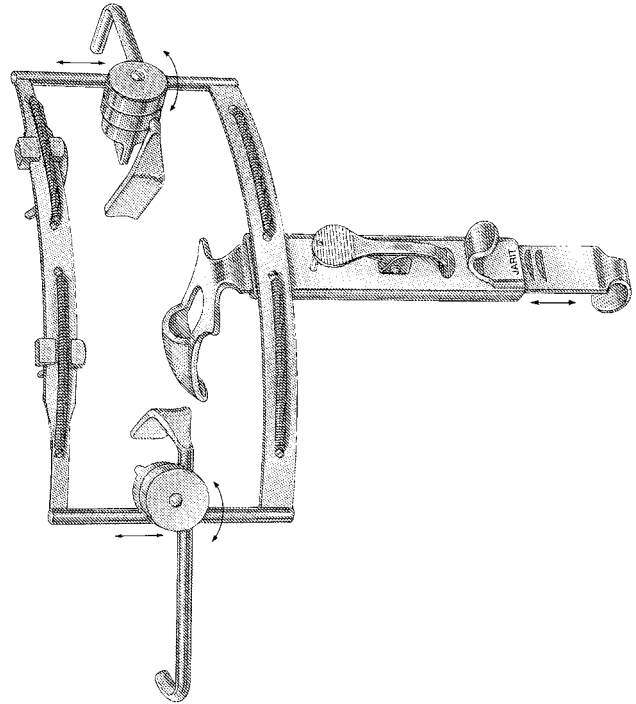

Jennings Mouth Gags

Catalog #	Description
450-100	Infant size: 3½" (90mm), 41mm spread
450-101	Small size: 4¾" (110mm), 38mm spread
450-102	Medium size: 5⅛" (130mm), 46mm spread
450-103	Large size: 5½" (140mm), 50mm spread

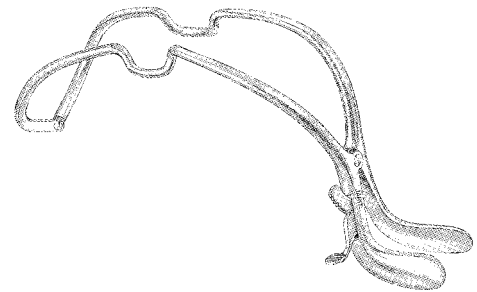

Sluder-Jansen Mouth Gags

Catalog #	Description
450-105	Child size: 4¾" (110mm), 35mm spread
450-106	Adult size: 5¾" (135mm), 50mm spread
450-SC-105	Replacement Silicone Blade Guard (Latex Free) pkg/6ea
450-SC-106	Replacement Silicone Blade Guard (Latex Free) pkg/6ea

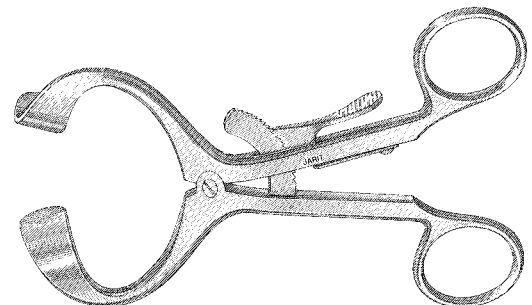

Davis Mouth Gag Frames

6" (151mm) overall length

Catalog #	Description
450-110	Double bite left side
450-111	Double bit right side
450-112	Single bite left side
450-113	Single bite right side
450-110RI	Replacement insert (Latex Free) pkg/12ea

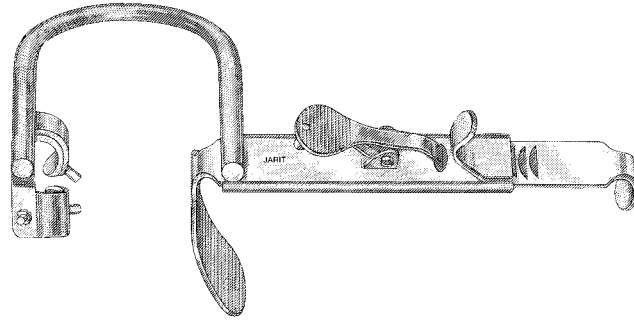

Davis Mouth Gag Blades

5 3/8" (136mm)

Catalog #	Description
450-120	Size 1: 1" x 3/4" (25mm x 19mm)
450-121	Size 1 1/2: 1 1/2" x 7/8" (38mm x 21mm)
450-122	Size 2: 2 1/4" x 7/8" (57mm x 22mm)
450-123	Size 2 1/2: 2 1/2" x 7/8" (65mm x 23mm)
450-124	Size 3: 2 3/4" x 7/8" (70mm x 23mm)
450-125	Size 3 1/2: 3" x 1" (76mm x 24mm)
450-126	Size 4: 3 1/4" x 1" (83mm x 24mm)
450-127	Size 4 1/2: 3 1/2" x 1" (90mm x 25mm)
450-128	Size 5: 4" x 1" (101mm x 26mm)

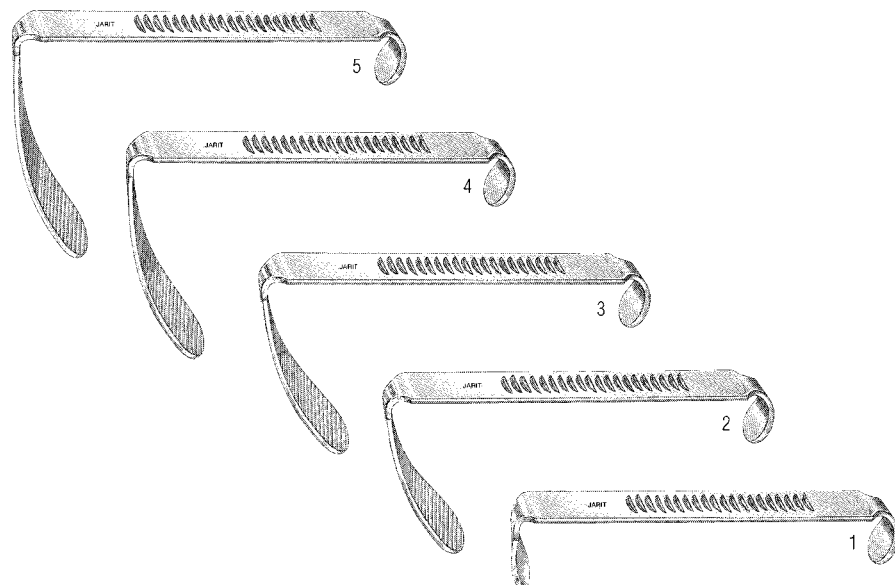

Mclvor Mouth Gag

Catalog #	Description
450-140	Complete with 3 blades
450-141	Frame only, 5 ³ / ₄ " (145mm) x 2 ³ / ₈ " x 4" (60mm x 100mm)
450-142	Blade only, size 1: 7 ⁷ / ₈ " x 2 ³ / ₄ " (23mm x 70mm)
450-143	Blade only, size 2: 1" x 3 ³ / ₈ " (25mm x 86mm)
450-144	Blade only, size 3: 1" x 4" (26mm x 100mm)
450-RS-140	Replacement Shod (Latex Free) pkg/12ea
450-FRS-140	Replacement Frame Release Screw pkg/6ea
450-WLP-141	Replacement Wire Loop

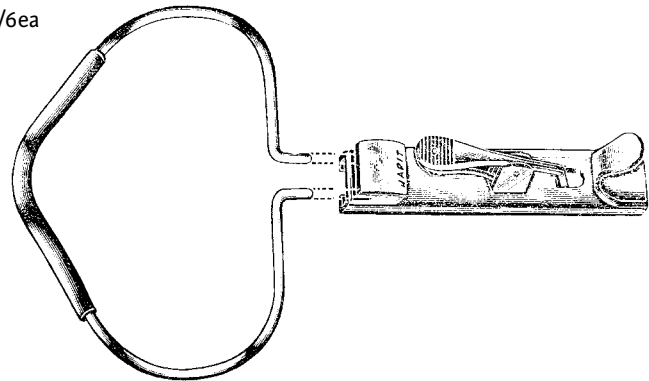

Cheek Retractor

Catalog #	Description
450-145	8" (201mm), 31.5mm swivel blade

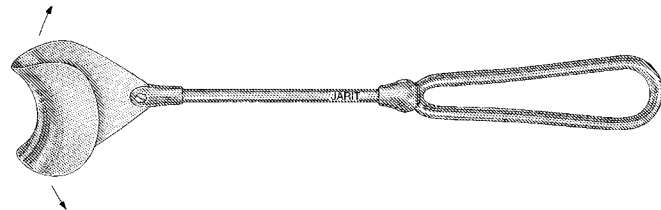

Sewall Orbital Retractors

6¹/₄" (160mm)

Catalog #	Description
450-146	7mm x 52mm blade
450-147	9mm x 51mm blade
450-148	11mm x 50mm blade
450-149	13mm x 67mm blade

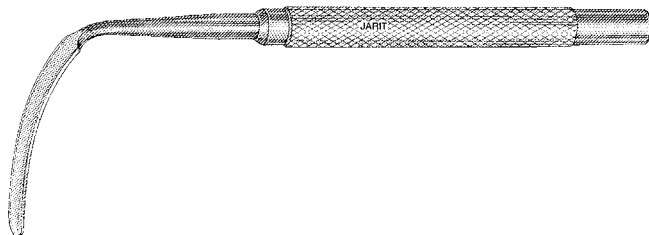

Wieder Tongue Depressors

5" (126mm)

Catalog #	Description
450-150	Small: 28mm blade, serrated
450-151	Large: 36mm blade, serrated

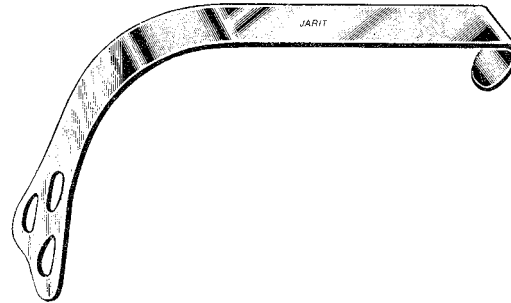

Andrew Tongue Depressor

4 1/8" (105mm)

Catalog #	Description
450-155	20mm blade, serrated

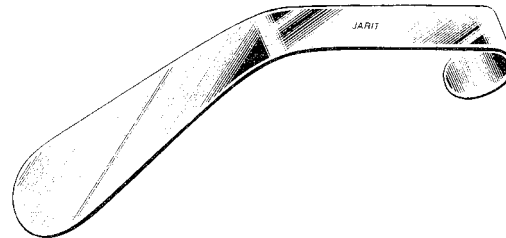

Ring Retractor Blades

6" (155mm)

for Davis or McIvor frames

Catalog #	Description
450-160	Size 2: right, 7/8" x 2 1/4" (23mm x 57mm)
450-161	Size 3: right, 1 1/8" x 2 7/8" (27mm x 72mm)
450-162	Size 4: right, 1 1/4" x 3 1/2" (33mm x 88mm)
450-166	Size 5: right, 1 1/2" x 3 3/4" (38mm x 95mm)
450-163	Size 2: left, 7/8" x 2 1/4" (23mm x 57mm)
450-164	Size 3: left, 1 1/8" x 2 7/8" (27mm x 72mm)
450-165	Size 4: left, 1 1/4" x 3 1/2" (33mm x 88mm)
450-167	Size 5: left, 1 1/2" x 3 3/4" (38mm x 95mm)

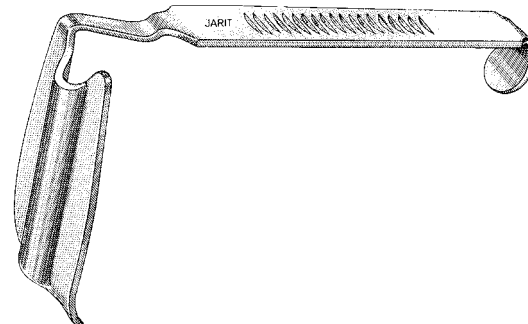

Colver Tonsil Seizing Forceps

7½" (190mm)

Catalog #	Description
450-200	Straight, 5.6mm jaws
450-201	Curved, 6mm jaws

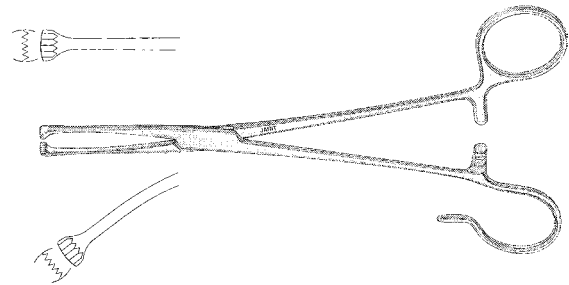

White Tonsil Seizing Forceps

curved

Catalog #	Description
450-205	9½" (240mm), 7.5mm jaws
450-210	7¼" (182mm), 6mm jaws

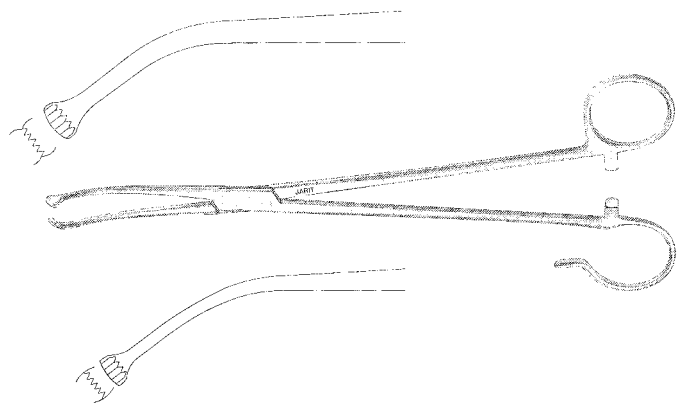

Ballenger Tonsil Seizing Forceps

8½" (217mm)

Catalog #	Description
450-220	3 x 3 teeth, (9mm wide)

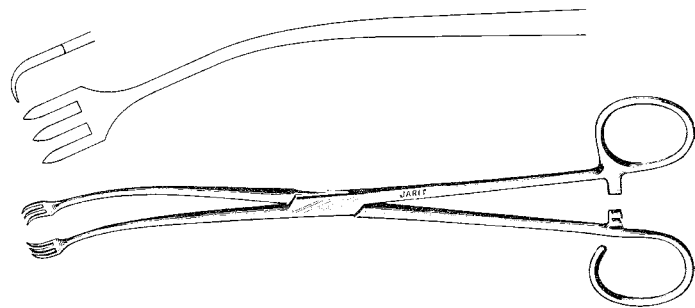

Tivnen Tonsil Seizing Forceps

7¾" (200mm)

Catalog #	Description
450-222	3 x 3 teeth, (7mm wide)

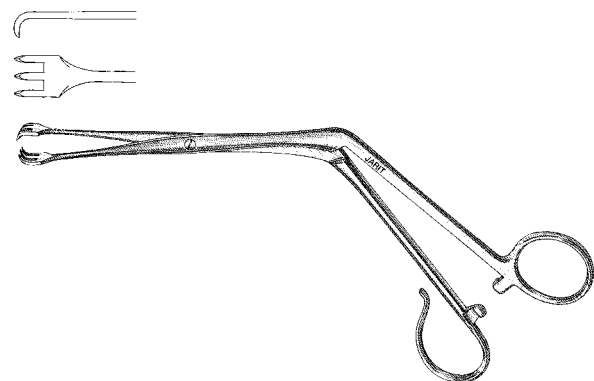

Schmidt Tonsil Forceps, (Mirror Finish)

7½" (190mm)

Manufactured from high grade German surgical stainless steel which is ground and polished to a mirror finish

Catalog #	Description
450-300	Half curved, one open ring
450-301	Full curved, one open ring
450-310	Half curved, closed rings
450-311	Full curved, closed rings



Schmidt Tonsil Forceps, (Matte Finish)

7½" (190mm)

Manufactured from high grade German surgical stainless steel which is glass beaded to a matte finish

Catalog #	Description
449-310	Half curved, closed rings

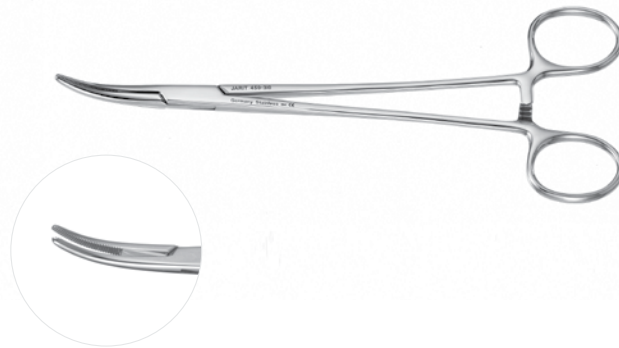

Hurd Dissector and Pillar Retractors

8¾" (224mm)

Catalog #	Description
450-399	Small: 7mm dissector, 12mm retractor
450-400	Large: 9mm dissector, 13mm retractor
450-401	Large: 9.6mm dissector, 13.3mm retractor, serrated edge

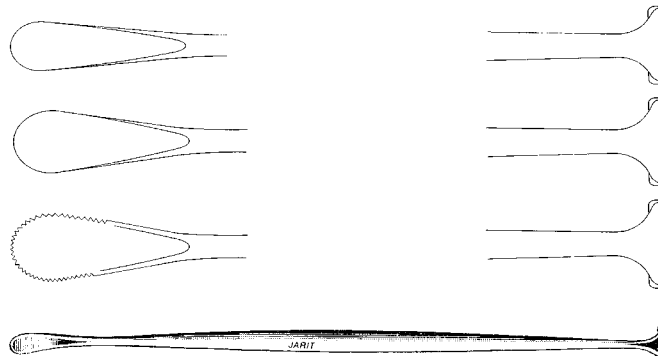

Dean Tonsil Knife

8 1/4" (210mm)

Catalog #	Description
450-407	Straight, 25mm blunt double-edged blade



Lothrop Tonsil Knife and Dissector

8 3/4" (222mm)

Catalog #	Description
450-412	Double-ended, 25mm bayonet shaped blade and 10mm curved blade

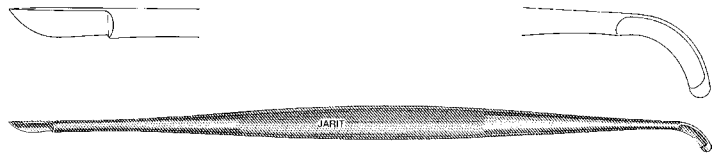

Fisher Tonsil Knife

8 1/4" (210mm)

Catalog #	Description
450-415	15mm curved blade, serrated on top, straight distal tip

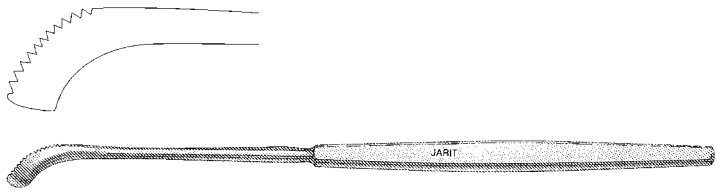

Colver Tonsil Knife

8 1/4" (210mm)

Catalog #	Description
450-417	15mm curved blade, serrated on top, rounded distal tip

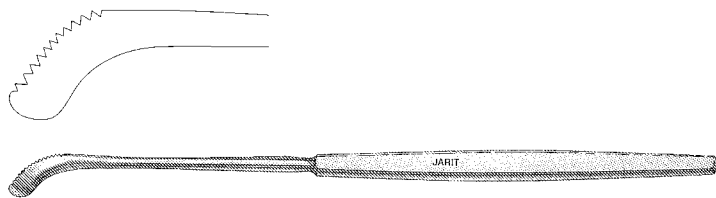

Robb Tonsil Knife

8 1/2" (215mm)

Catalog #	Description
450-420	6.5mm x 30mm sickle shaped blade

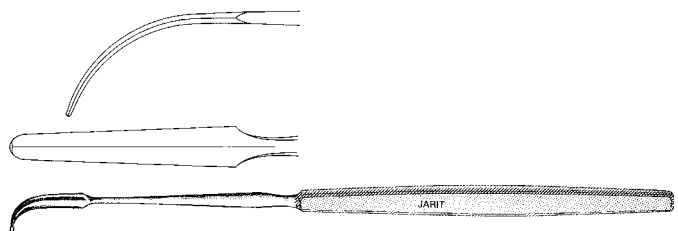

Dean Tonsil Scissors

7" (175mm)

Catalog #	Description
450-450	Angled, 20mm blades, bottom blade serrated

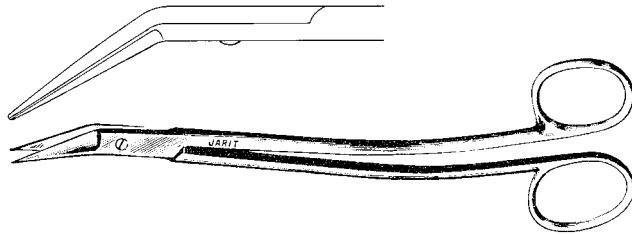

Boettcher Tonsil Scissors

7¼" (184mm)

Catalog #	Description
450-455	Curved, 37mm blades, sharp outer edges

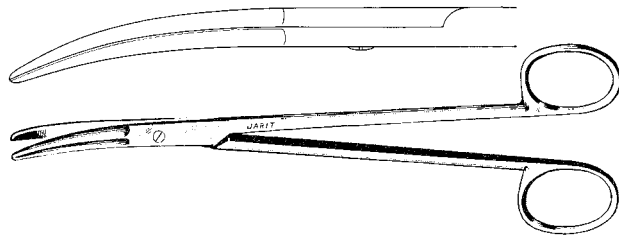

Lillie Tonsil Scissors

8" (205mm)

Catalog #	Description
450-457	Curved, 40mm blades

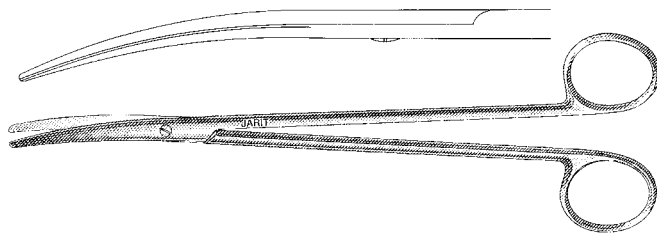

Boyd Tonsil Scissors

7" (177mm)

Catalog #	Description
450-460	Double curved, 30mm blades

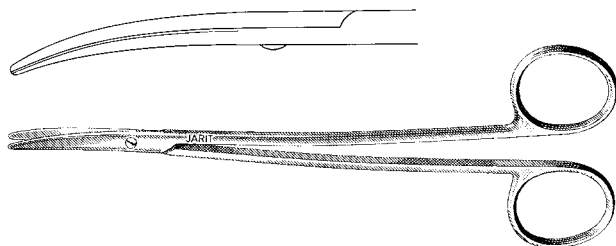

Metzenbaum Scissors, Curved, (Mirror Finish)

Manufactured from high grade German surgical stainless steel which is ground and polished to a mirror finish

Catalog #	Description
100-262	7" (178mm), 33mm blades
100-266	8" (206mm), 42mm blades

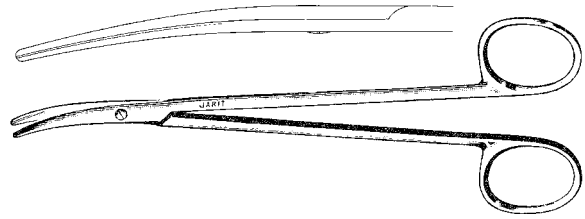

Metzenbaum Scissors, Curved, (Matte Finish)

Manufactured from high grade German surgical stainless steel which is glass beaded to a matte finish

Catalog #	Description
099-262	7" (176mm), 33mm blades

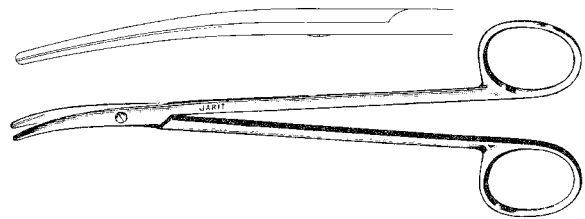

Metzenbaum Scissors, Carb-Edge, (Satin Finish)

Manufactured from high grade German surgical stainless steel which is ground and polished to a satin finish

Catalog #	Description
101-258	7" (179mm), curved, 33mm blades
101-265	8" (206mm), curved, 42mm blades

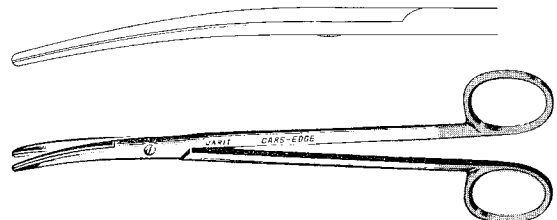

Metzenbaum Scissors, Carb-Edge, (Matte Finish)

Manufactured from high grade German surgical stainless steel which is glass beaded to a matte finish

Catalog #	Description
103-258	7" (179mm), curved, 33mm blades

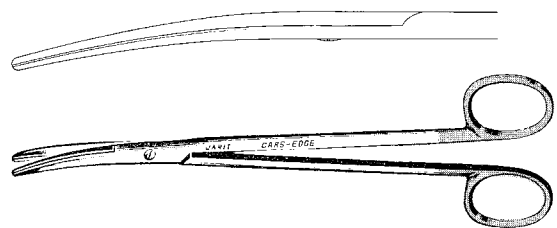

Metzenbaum Scissors, Supercut curved

Catalog #	Description
102-122	7" (180mm), 33mm blades

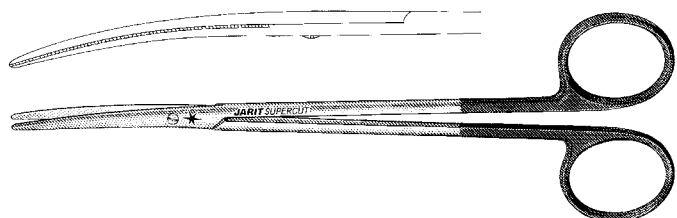

Eve Tonsil Snare

11¼" (285mm)

Catalog #	Description
450-500	Plain, includes 1 package of 12 snare wires, 25 gauge

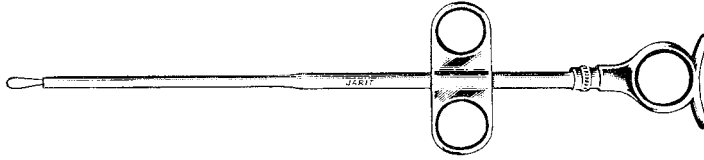

Eve Tonsil Snare

11¼" (285mm)

Catalog #	Description
450-501	with Ratchet, includes 1 package of 12 snare wires, 25 gauge

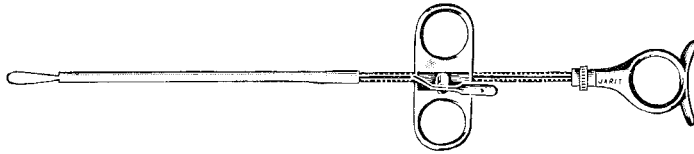

Sage Tonsil Snare

9" (230mm)

Catalog #	Description
450-505	Includes 1 package of 12 snare wires, 25 gauge

- 450-DTN-505 Replacement Detachable Nozzle
- 450-STY-505 Replacement Stylet
- 450-SPS-505 Replacement Spring and Screw

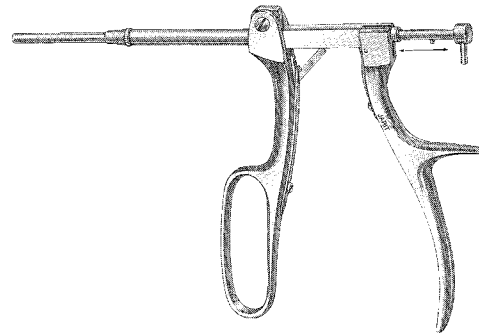

Tydings Tonsil Snare

7½" (188mm)

Catalog #	Description
450-510	Includes 1 package of 12 snare wires, 25 gauge

- 450-DTN-505 Replacement Detachable Nozzle
- 450-STY-505 Replacement Stylet
- 450-HTS-510 Replacement Handle Thumb Screw
- 450-ESC-510 Replacement End Screw
- 450-WRD-510 Replacement Carrier

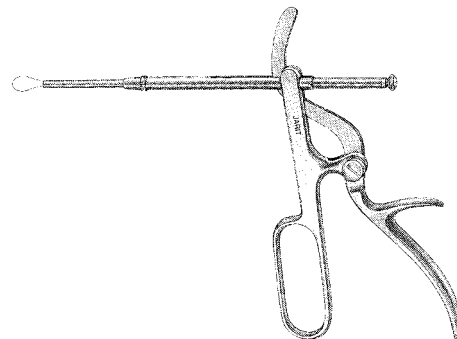

Cut Snare Wires

4½" (114mm), package of 12

Catalog #	Description
450-524	30 gauge (0.30mm)
450-525	28 gauge (0.35mm)
450-526	27 gauge (0.40mm)
450-527	26 gauge (0.45mm)
450-528	25 gauge (0.50mm)
450-529	24 gauge (0.55mm)



Andrews-Pynchon Suction Tube

Catalog #	Description
170-115	9 1/4" (234mm)

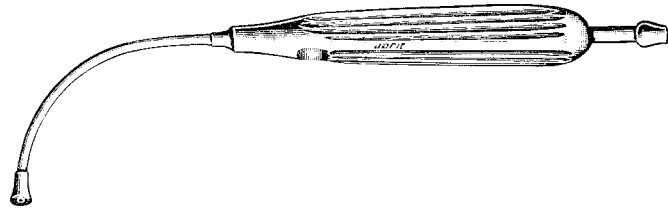

Yankauer Suction Tube

Catalog #	Description
170-118	8 1/4" (208mm), pediatric size

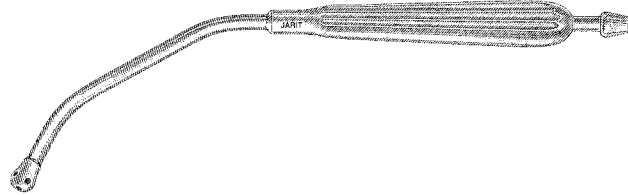

Yankauer Suction Tube Parts

Catalog #	Description
170-119	Tip for pediatric suction tube pkg/12ea

Yankauer Suction Tube

Catalog #	Description
170-120	11 1/4" (284mm), pediatric size

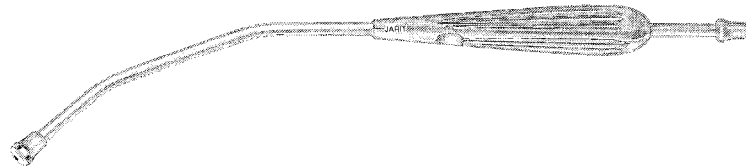

Yankauer Suction Tube Parts

Catalog #	Description
170-121	Tip for suction tube pkg/12ea

Yankauer Suction Tube w/Control Valve

Catalog #	Description
170-122	13" (330mm), stainless steel

Yankauer Suction Tube Parts

Catalog #	Description
170-121	Tip for suction tube pkg/12ea
170-SLV-122	Sleeve for suction tube

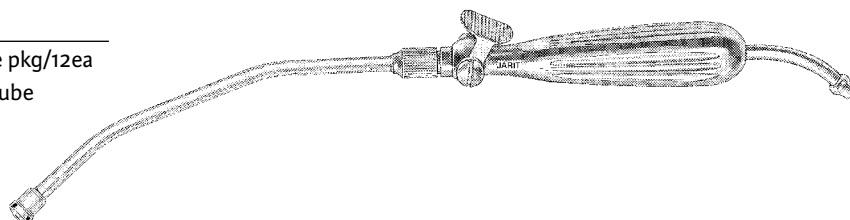

Laryngeal Mirrors

threaded handle

Catalog #	Description
460-100	#00: 7 ³ / ₄ ", 12mm diameter
460-101	#0: 7 ³ / ₄ ", 14mm diameter
460-102	#1: 7 ³ / ₄ ", 16mm diameter
460-103	#2: 7 ⁷ / ₈ ", 18mm diameter
460-104	#3: 8", 20mm diameter
460-105	#4: 8", 22mm diameter
460-106	#5: 8 ¹ / ₄ ", 24mm diameter
460-107	#6: 8 ¹ / ₄ ", 26mm diameter
460-108	#7: 8 ⁵ / ₈ ", 28mm diameter
460-109	#8: 8 ⁵ / ₈ ", 30mm diameter

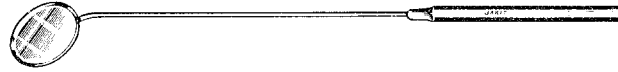

Jackson Laryngeal Dressing Forceps

9¹/₂" (240mm)

Catalog #	Description
460-130	4mm x 2 teeth, 18mm serrated jaws

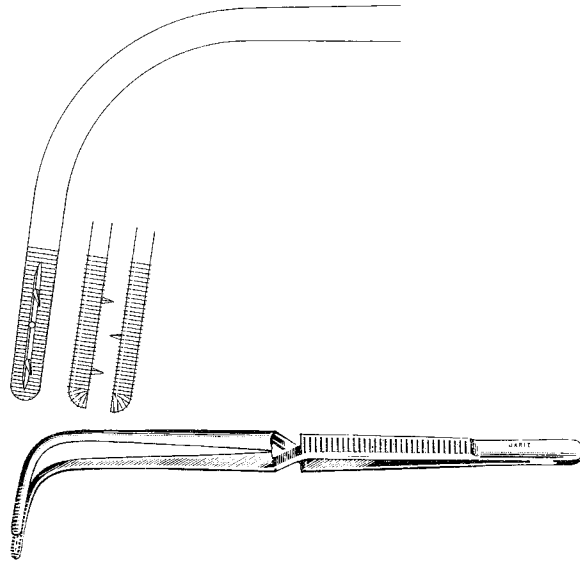

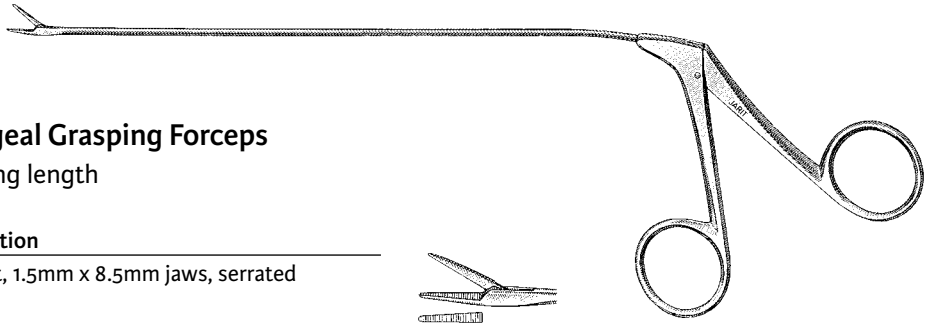

Jako Micro-Laryngeal Grasping Forceps

9³/₄" (245mm) working length

Catalog #	Description
460-230	Straight, 1.5mm x 8.5mm jaws, serrated
460-231	Curved left, 1.5mm x 8.5mm jaws, serrated
460-232	Curved right, 1.5mm x 8.5mm jaws, serrated

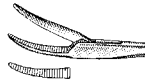
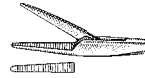

Jako Micro-Laryngeal Cup Forceps

9³/₄" (245mm) working length

Catalog #	Description
460-235	Straight, 2.5mm cups
460-236	Angled left, 2.5mm cups
460-237	Angled right, 2.5mm cups
460-240	Angled up, 2.5mm cups

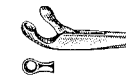
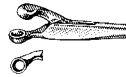
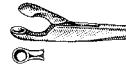

Jako Micro-Laryngeal Scissors

9¾" (245mm) working length

Catalog #	Description
460-245	Straight, vertical, 4.5mm blades
460-246	Angled up, 4.5mm blades
460-247	Curved left, 4.5mm blades
460-248	Curved right, 4.5mm blades
460-249	Straight, horizontal, 4.5mm blades

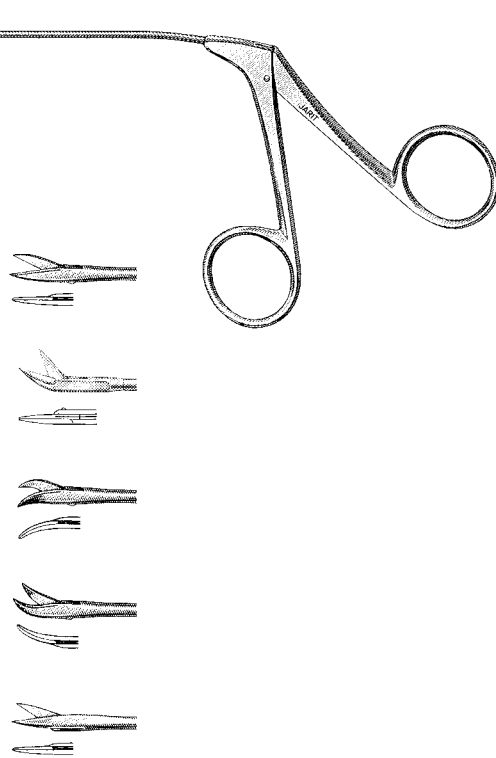

Trousseau Tracheal Dilators

Catalog #	Description
460-400	Adult: 5¾" (145mm), jaw width 5.5mm
460-401	Child: 5⅛" (130mm), jaw width 3.5mm

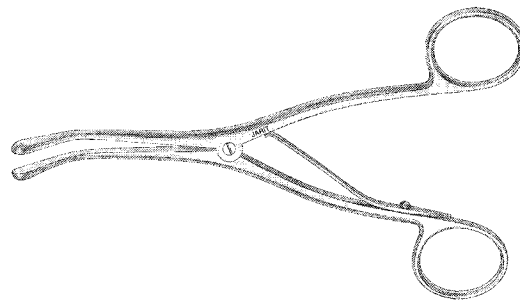

La Borde Tracheal Dilators

Catalog #	Description
460-405	5⅜" (138mm), 5.6mm wide side blades 3⅞" x ¼" (100mm x 6.4mm) center blade

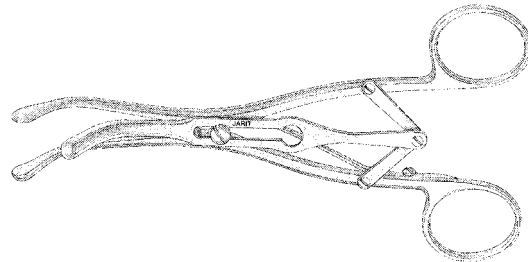

Jackson Tracheal Hook

5 7/8" (150mm)

Catalog #	Description
460-420	9mm hook



Jackson Tracheal Retractor

7" (176mm)

Catalog #	Description
460-425	Double-ended, 8mm wide double-hook, 10mm x 12.5mm retractor blade



News Tracheal Hook

5 7/8" (150mm)

Catalog #	Description
460-430	9.5mm hook



Luer Tracheal Retractor

4 3/8" (112mm)

Catalog #	Description
460-433	Double-ended, 3/8" x 7 1/6" (9.5mm x 11.5mm)

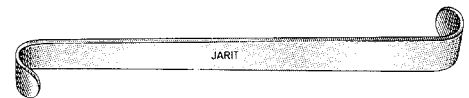

Lukens Thymus Retractor

7" (178mm)

Catalog #	Description
460-435	Double-ended, 3/8" x 1/2" (10mm x 12.5mm), 5/16" x 5/8" (8mm x 16.5mm)

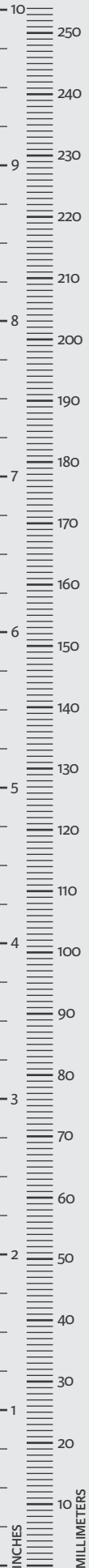

Jackson Tracheal Hemostat

5½" (140mm)

Catalog #	Description
460-440	Curved

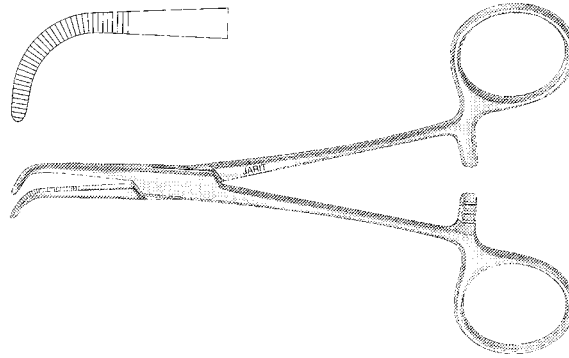

Jackson Tracheal Tubes

original model, stainless steel,
length is measured on inside curve of tube

Catalog #	Description
460-600	Size 2-0: 4.5mm O.D., 37mm length
460-601	Size 0: 5mm O.D., 45mm length
460-602	Size 1: 5.5mm O.D., 51mm length
460-603	Size 2: 6mm O.D., 59mm length
460-604	Size 3: 7mm O.D., 67mm length
460-605	Size 4: 8mm O.D., 71mm length
460-606	Size 5: 9mm O.D., 81mm length
460-607	Size 6: 10mm O.D., 83mm length
460-608	Size 7: 11mm O.D., 84mm length
460-609	Size 8: 12mm O.D., 86mm length
460-610	Size 9: 13mm O.D., 89mm length
460-611	Size 10: 14mm O.D., 91mm length

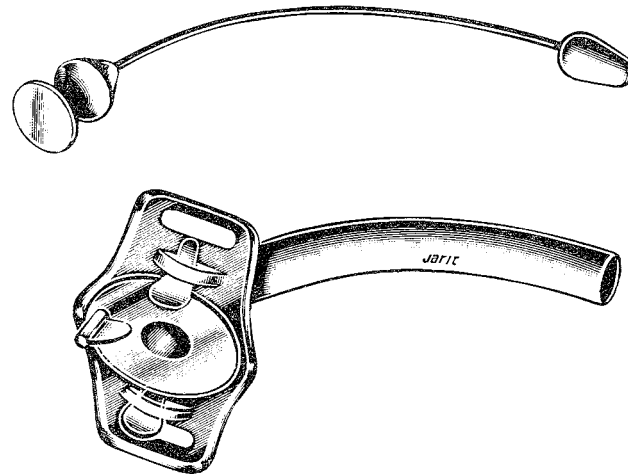

Jackson Tracheal Tubes

improved model, stainless steel,
length is measured on inside curve of tube

Catalog #	Description
460-620	Size 2-0: 4.5mm O.D., 37mm length
460-621	Size 0: 5mm O.D., 45mm length
460-622	Size 1: 5.5mm O.D., 51mm length
460-623	Size 2: 6mm O.D., 59mm length
460-624	Size 3: 7mm O.D., 67mm length
460-625	Size 4: 8mm O.D., 71mm length
460-626	Size 5: 9mm O.D., 81mm length
460-627	Size 6: 10mm O.D., 83mm length
460-628	Size 7: 11mm O.D., 84mm length
460-629	Size 8: 12mm O.D., 86mm length
460-630	Size 9: 13mm O.D., 89mm length
460-631	Size 10: 14mm O.D., 91mm length

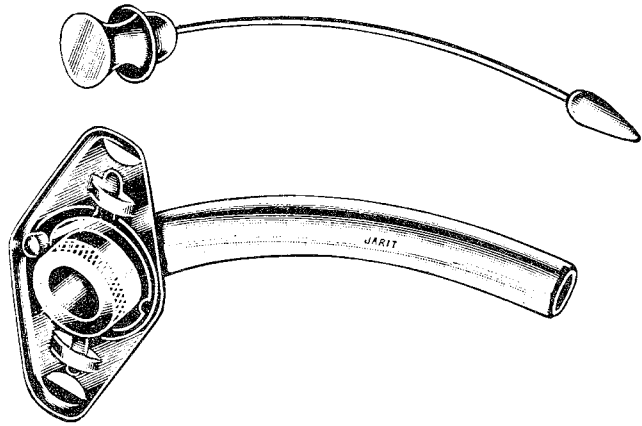

Jackson Tracheal Tubes

short model, stainless steel,
length is measured on inside curve of tube

Catalog #	Description
460-640	Size 2-0: 4.5mm O.D., 30mm length
460-641	Size 0: 5mm O.D., 38mm length
460-642	Size 1: 5.5mm O.D., 44mm length
460-643	Size 2: 6mm O.D., 53mm length
460-644	Size 3: 7mm O.D., 60mm length
460-645	Size 4: 8mm O.D., 65mm length
460-646	Size 5: 9mm O.D., 74mm length
460-647	Size 6: 10mm O.D., 76mm length
460-648	Size 7: 11mm O.D., 78mm length
460-649	Size 8: 12mm O.D., 79mm length
460-650	Size 9: 13mm O.D., 82mm length
460-651	Size 10: 14mm O.D., 84mm length

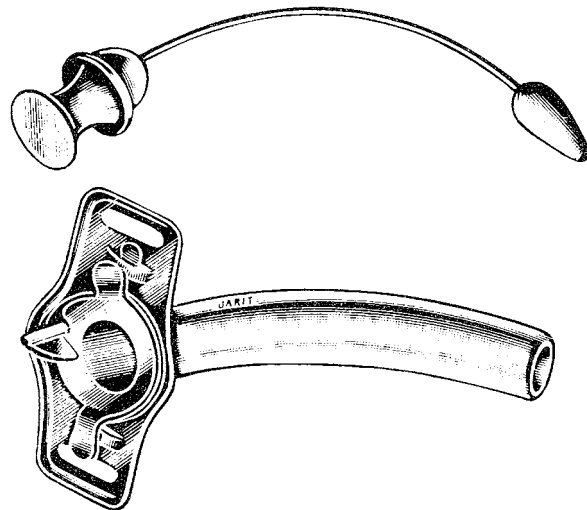



Integra™
Dental & Oral
Instruments

Explorer, Double Ended

Catalog #	Description
835-100	#5



Explorer, Single Ended

Catalog #	Description
835-105	#23



Excavator, Double Ended

Catalog #	Description
835-110	#18



Excavator, Double Ended

Catalog #	Description
835-115	#19



Excavator, Double Ended

Catalog #	Description
835-120	#3/6 cleoid/discoid



Excavator, Double Ended

Catalog #	Description
835-125	#89/92 cleoid/discoid



Hollenbach Plugger, Double Ended

Catalog #	Description
835-130	#1



835-135	#2
---------	----



Ward Wax Carver, Double Ended

Catalog #	Description
835-140	#2



Wall Wax Carver, Double Ended

Catalog #	Description
835-145	#1 ball tip



Burnisher, Double Ended

Catalog #	Description
835-150	#27/29



835-155	#1 Ball tip
---------	-------------



835-160	#28/29
---------	--------



835-165	#21 acorn tip
---------	---------------



Plastic Filling Instrument, Double Ended

Catalog #	Description
835-170	#4



Woodson Plastic Filling Instrument, Double Ended

Catalog #	Description
835-175	#1
835-180	#2



Cement Spatula, Flexible

Catalog #	Description
835-185	#24

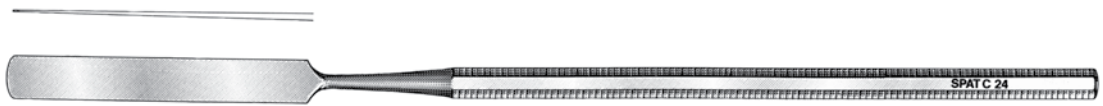

Cement Spatula, Rigid

Catalog #	Description
835-190	#24



Wax Spatula, small end with one flat side

Catalog #	Description
835-195	#7A



Lucas Bone Curette, Double Ended

Catalog #	Description
835-200	#85



835-205	#86
---------	-----



835-210	#87
---------	-----



Molt Bone Curette, Double Ended

Catalog #	Description
835-215	#2/4



Molt Bone Curette, Single Ended

Catalog #	Description
835-220	#1



835-235	#2
---------	----



835-240	#4
---------	----



Howard Bone File, Double Ended

Catalog #	Description
835-300	#12



Bell Pattern Bone File, Double Ended

Catalog #	Description
835-305	#12A

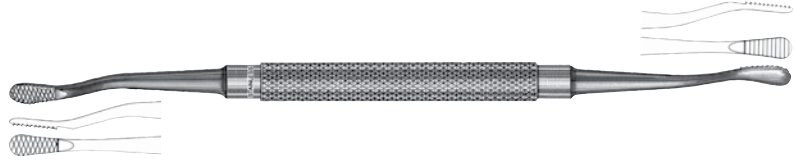

835-310	#12CA
---------	-------

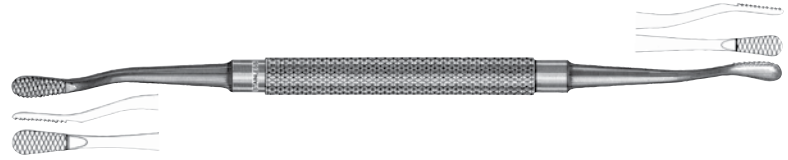

Gardner Bone Chisel

Catalog #	Description
835-400	#1



835-405	#2
---------	----



835-410	#5
---------	----



Apical Dental Elevator

Catalog #	Description
835-500	#301



835-510	#302
---------	------



835-515	#303
---------	------

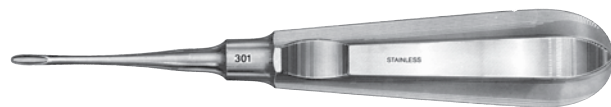

Crane Pick Elevator

Catalog #	Description
835-505	#8



Cogswell A "Spade" Elevator

Catalog #	Description
835-520	A "Spade"



Root Tip Dental Elevator

Catalog #	Description
835-525	#34



835-530	#34S
---------	------



Seldin Elevator

Catalog #	Description
835-540	#1L



835-541	#1R
---------	-----



835-542	#4L
---------	-----



835-543	#4R
---------	-----



Cryer Elevator

Catalog #	Description
835-545	#44



835-546	#45
---------	-----



Heidbrink Root-Tip Picks

Catalog #	Description
835-550	#H1
835-551	#H2
835-555	#H3



Heidbrink Root-Tip Pick

Catalog #	Description
835-552	#H2-3



Potts T-Handle Elevator

Catalog #	Description
835-560	#6X
835-561	#7X

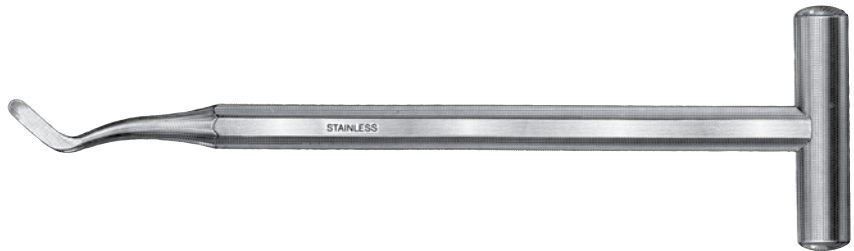

Dental Extraction Forceps

Catalog #	Description
836-145	#53L upper molar: left, 1st and 2nd upper molars

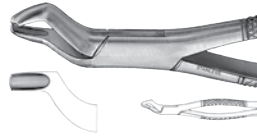

836-146	#53R upper molar: right, 1st and 2nd upper molars
---------	---

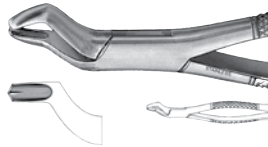

836-155	#88L upper molar: left, 1st and 2nd upper molars
---------	--

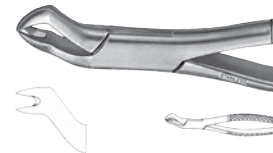

836-160	#88R upper molar: right, 1st and 2nd upper molars
---------	---

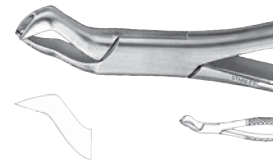

Dental Extraction Forceps

Catalog #	Description
836-165	#89L upper molars: left

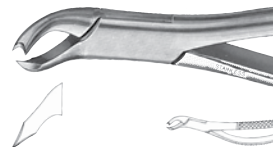

836-170	#90R upper molars: right
---------	--------------------------

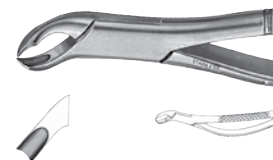

836-100	#23 lower molar: 1st and 2nd upper molars cow horn, universal
---------	---

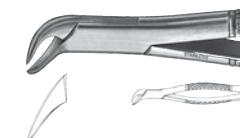

Dental Extraction Forceps

Catalog #	Description
836-105	#150 upper anteriors, upper incisor and cuspids, bicuspid and roots, universal
836-110	#150AS upper anteriors, split breaks, serrated
836-120	#151 lower anteriors, lower incisor and cuspids, bicuspid and roots, universal
836-125	#151AS lower anteriors, split breaks, serrated

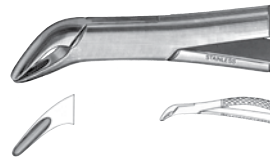
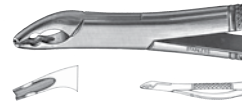
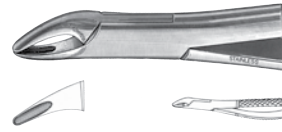

Dental Extraction Forceps

Catalog #	Description
836-175	#99C upper anteriors, upper incisors, cuspids and bicuspid
836-180	#MD1, mead pattern, upper incisors, cuspids and bicuspid, mead, universal
836-205	#101 anteriors and splitting upper and lower bicuspid and deciduous, universal
836-210	#286 upper anteriors upper bicuspid, incisors and roots

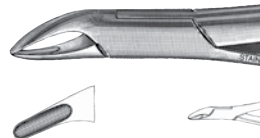
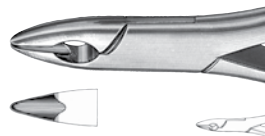

Dental Extraction Forceps, Pedodontic

Catalog #	Description
836-115	#150S pedo-extracting forceps, pedo upper incisors, bicuspid and roots, universal
836-130	#151S pedo-extracting forceps, pedo lower incisors, bicuspid and roots, universal
836-135	#150XAS pedo-extracting forceps, pedo upper anteriors, split breaks, serrated
836-140	#16S pedo-extracting forceps, pedo lower molars, cow horn

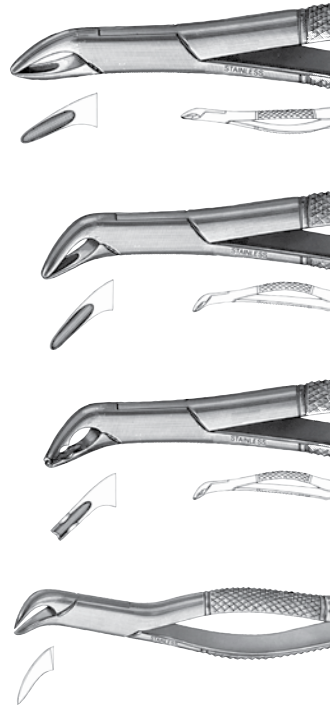

Dental Extraction Forceps, English Pattern

Catalog #	Description
836-195	#A pedo-extracting forceps, English pattern, pedo upper molars, mini, universal
836-200	#C pedo-extracting forceps, English pattern, pedo lower molars, mini, universal
836-150	#74 extracting forceps, English pattern, lower roots
836-185	#73 extracting forceps, English pattern, lower molars, universal

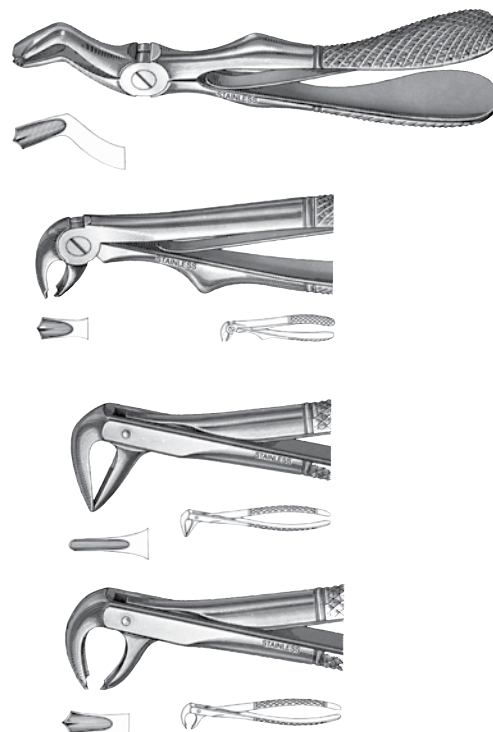

Hanahan Extraction Forceps

Catalog #	Description
836-190	#1, upper incisor

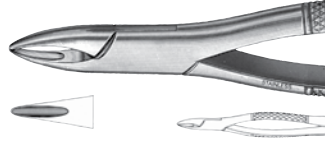

Oral Surgery Rongeurs

Catalog #	Description
837-100	#5, 6¾" (172mm)

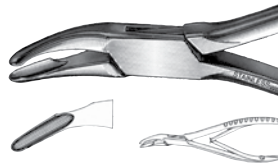

837-105	#4, 5½" (140mm)
---------	-----------------



Mini-Blumenthal Rongeur

Catalog #	Description
837-110	4½" (115mm), 30 deg curved jaw

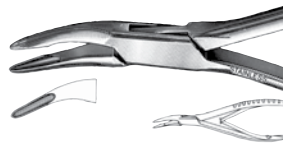

Micro-Friedman Rongeur

Catalog #	Description
837-115	5½" (140mm), 15 deg curved jaw

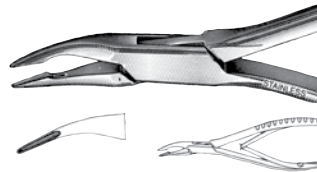

Mead Rongeur, #1A

Catalog #	Description
837-120	6½" (165mm)

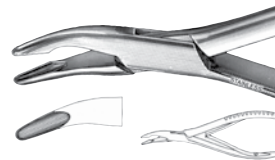

Amalgam Carrier, w/Stainless Barrels, double ended

Catalog #	Description
838-200	Medium/Large



Toffmire Type Matrix Retainer-Universal

Catalog #	Description
838-210	Universal

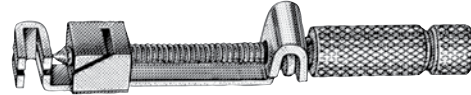

Aspirating Syringe

Catalog #	Description
838-215	C-W type, 1.8cc



300X One Piece Construction Band Pusher

Catalog #	Description
838-220	Construction Band Pusher

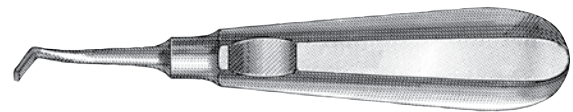
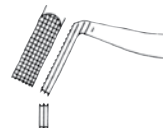

Denhardt Mouth Gag, with Grip Lock

Catalog #	Description
838-250	with Grip Lock

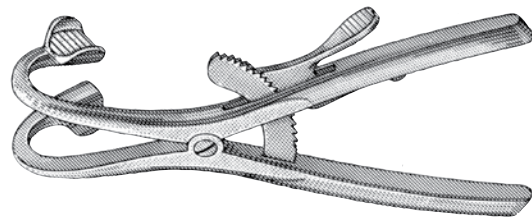

University of Minnesota Cheek Retractor

Catalog #	Description
838-270	5 1/2" (140mm)



Quimby Gum Scissors

Catalog #	Description
838-500	5" (127mm), full curve

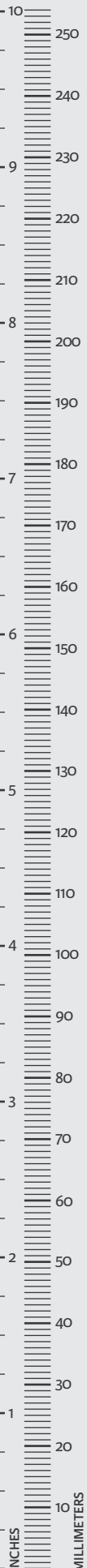
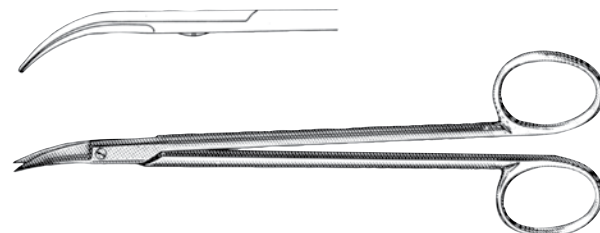

Integra™
Rectal &
Genito-Urinary
Instruments and
General Surgical
Instruments

Pratt Rectal Speculum

7½" (190mm)

Catalog #	Description
475-100	Blades 3¾" deep x 1" wide (87mm x 25mm), diameter at opening 1⅞" (47mm)

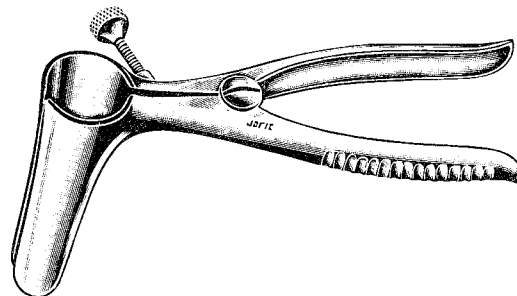

Bodenhammer Rectal Speculum

5⅞" (150mm)

Catalog #	Description
475-105	Blades 3½" deep x ¾" wide (90mm x 18mm), diameter at opening 1" (25mm)

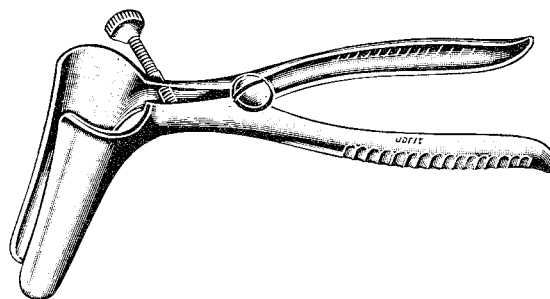

Sims Rectal Speculum

5⅞" (150mm)

Catalog #	Description
475-110	Blades 3½" deep x ⅝" wide (90mm x 17mm), diameter at opening 1" (25mm)

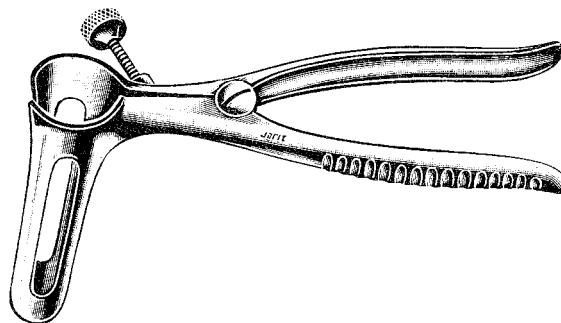

Barr Anal Retractor

7½" (190mm)

Catalog #	Description
475-120	Self-retaining blades 2¾" deep x ⅞" wide (70mm x 22mm)

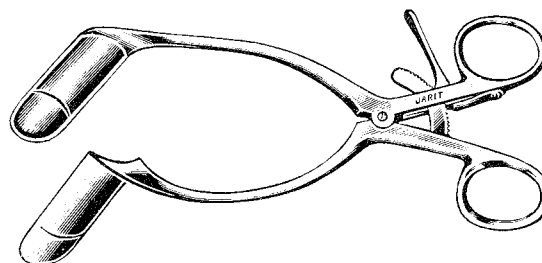

Smith Anal Retractor

Catalog #	Description
475-125	Maximum opening 4" (102mm), swivel blades 2¾" deep x 7/8" wide (70mm x 22mm)
475-ESC-125	Replacement End Screw Pkg/3ea

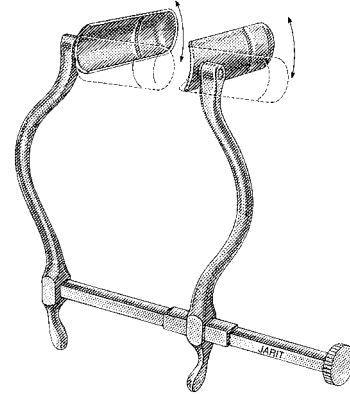

Fansler Operating Speculum

7¾" (198mm)

Catalog #	Description
475-127	Slotted tube 2¾" long x 1¾" diameter (60mm x 35mm)
475-OBT-127	Replacement Obturator

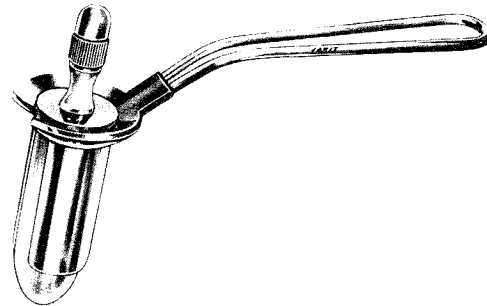

Fansler (Ives) Rectal Speculum

Catalog #	Description
475-130	3¼" long x 1½" diameter (83mm x 28mm)
475-131	Replacement Plastic Obturator

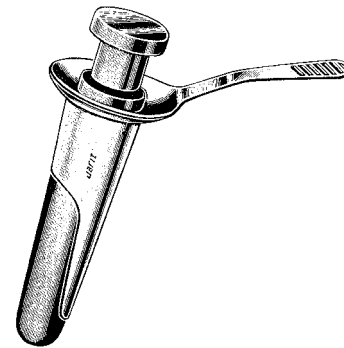

Chelsea-Eaton Anal Specula

Catalog #	Description
475-140	Small: 2¾" long x 7/8" diameter (70mm x 22mm)
475-142	Large: 2¾" long x 1½" diameter (70mm x 30mm)
475-OBT-140	Replacement Obturator
475-OBT-142	Replacement Obturator

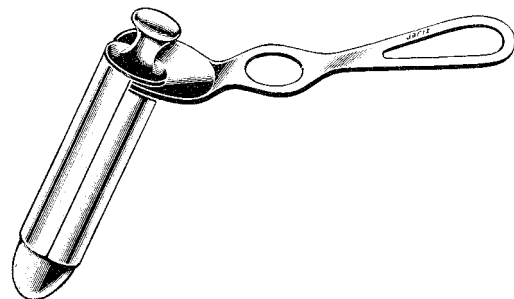

Hirschman Anoscopes

Catalog #	Description
475-150	Small: 2 ³ / ₈ " long x ⁵ / ₈ " diameter (60mm x 16mm)
475-152	Medium: 2 ³ / ₄ " long x ³ / ₄ " diameter (70mm x 19mm)
475-155	Large: 3 ¹ / ₂ " long x 1" diameter (90mm x 24mm)
475-OBT-150	Replacement Obturator
475-OBT-152	Replacement Obturator
475-OBT-155	Replacement Obturator

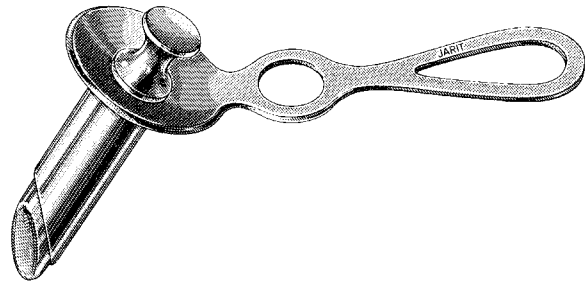

Brinkerhoff Rectal Specula

Catalog #	Description
475-160	Small: 3 ¹ / ₂ " long x 1" diameter (90mm x 25mm), tapering to ¹ / ₂ " (12mm)
475-162	Medium: 4" long x 1" diameter (100mm x 25mm), tapering to ¹ / ₂ " (12mm)
475-165	Large: 4 ³ / ₄ " long x 1 ¹ / ₄ " diameter (120mm x 32mm), tapering to ³ / ₄ " (14mm)
475-SLD-160	Replacement Slide Bar

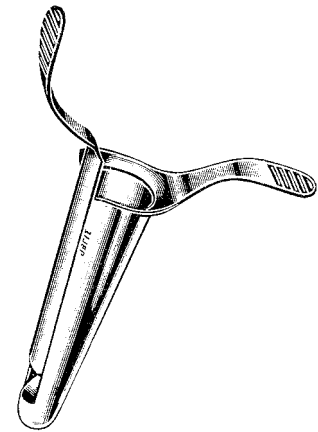

Kelly Proctoscopes

⁷/₈" diameter (22mm)

Catalog #	Description
475-175	Small: 2" long (51mm)
475-176	Medium: 4" long (100mm)
475-177	Large: 5 ¹ / ₂ " long (140mm)
475-SLD-160	Replacement Slide Bar

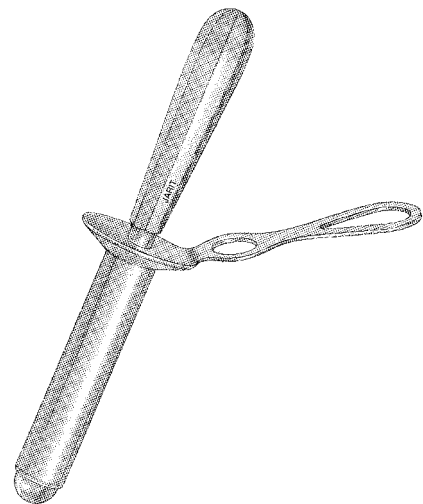

Hill-Ferguson Rectal Retractors

Catalog #	Description
475-180	Small: 2½" x 1" wide (64mm x 25mm) blade, angled 20 deg
475-181	Medium: 2¾" x 1⅛" wide (70mm x 29mm) blade, angled 20 deg
475-182	Large: 3¼" x 1⅝" wide (81mm x 40mm) blade, straight

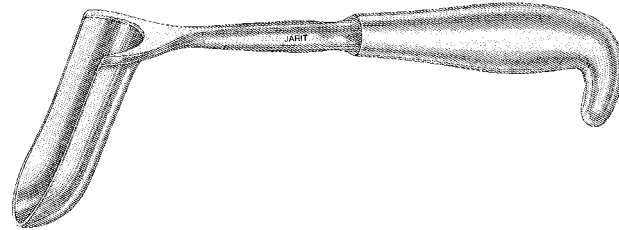

Sawyer Rectal Retractors

Catalog #	Description
475-185	Small: 2¼" x 7⁄8" (56mm x 22mm) blade
475-186	Medium: 2¾" x 1⅛" (69mm x 29mm) blade
475-187	Large: 3¼" x 1½" (84mm x 38mm) blade

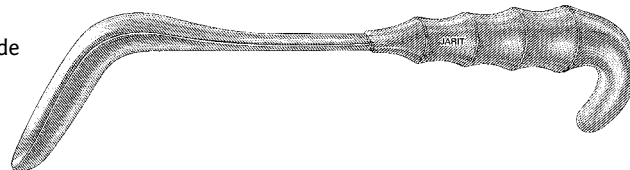

Yeoman Biopsy Forceps

rotating shaft, 4mm x 12mm straight jaws

Catalog #	Description
475-212	13" (330mm)
475-214	16¼" (410mm)

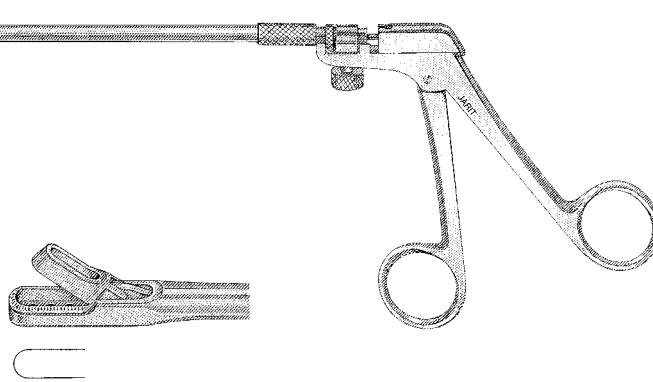

Turrell Biopsy Forceps

rotating shaft, 4mm x 11mm angled jaws

Catalog #	Description
475-222	13" (330mm)
475-224	16¼" (410mm)

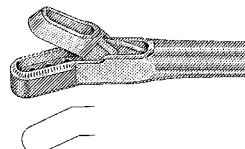

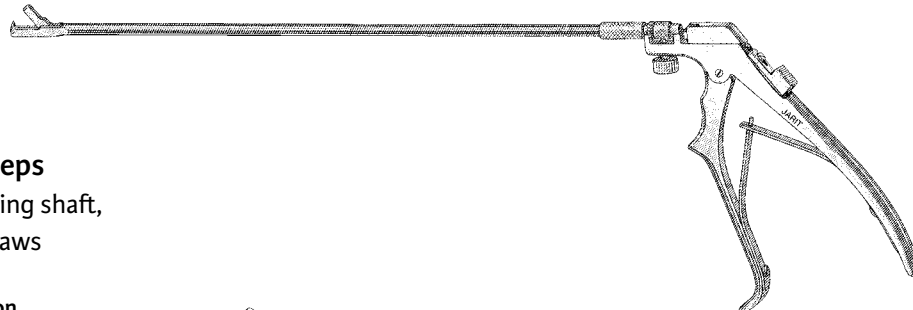

Yeoman Biopsy Forceps
improved handle, rotating shaft,
6mm x 12mm straight jaws

Catalog #	Description
475-232	13" (330mm)
475-234	16 1/4" (410mm)

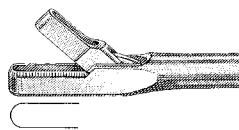

Turrell Biopsy Forceps
improved handle, rotating shaft,
6mm x 12mm angled jaws

Catalog #	Description
475-242	13 1/4" (335mm)
475-244	16" (406mm)

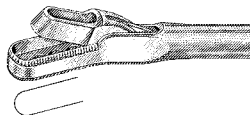

Yeoman Biopsy Forceps
improved handle, rotating shaft,
6mm x 12mm straight jaws with teeth

Catalog #	Description
475-252	13 1/4" (335mm)
475-254	16" (406mm)

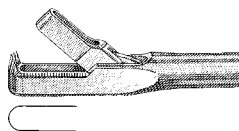

Turrell Biopsy Forceps
improved handle, rotating shaft,
6mm x 12mm angled jaws with teeth

Catalog #	Description
475-262	13 1/4" (335mm)
475-264	16 1/4" (410mm)

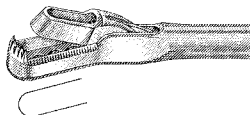

McGivney Hemorrhoidal Ligator

Catalog #	Description
475-305	7¼" (182mm), improved model, with offset handle



McGivney Hemorrhoidal Grasping Forceps

Catalog #	Description
475-306	7½" (190mm), angled shanks, for use with McGivney ligator

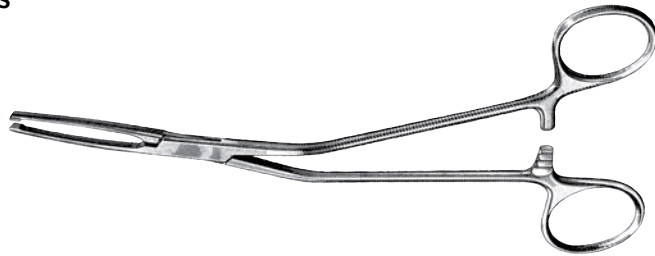

McGivney Ligator Set

Catalog #	Description
475-307	Includes 475-305 hemorrhoidal ligator, 475-LC-305 drum loading cone, 475-OR-305 100 latex o-rings
475-OR-305	Replacement O-Rings 100/per
475-LC-305	Replacement Loading Cone

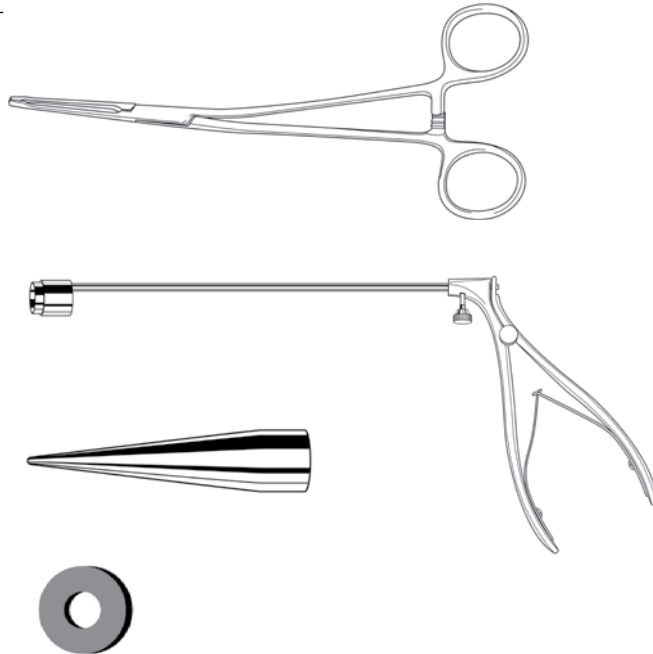

Buie Rectal Suction Tube

Catalog #	Description
475-310	16½" (420mm) working length, 12 French, with finger valve

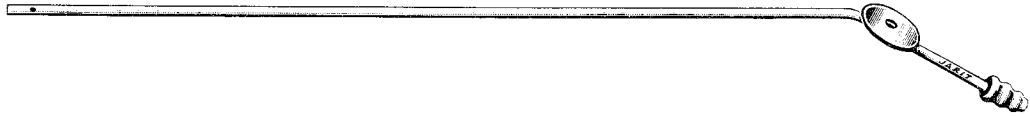

Buie Pile Clamp

Catalog #	Description
475-320	8¼" (207mm) curved

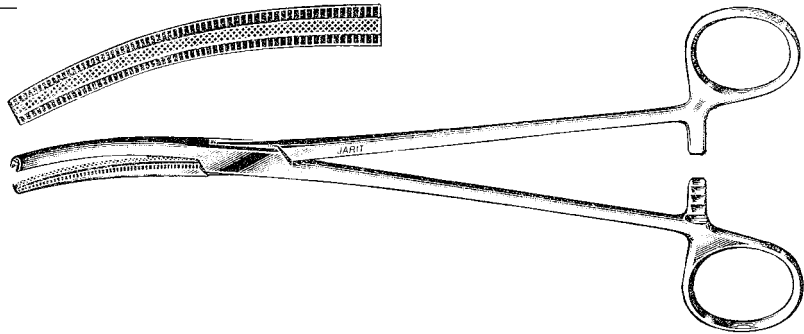

Buie Fistula Probes

5³/₈" (137mm)

Catalog #	Description
475-330	Light model, 1.5mm probe tip
475-331	Heavy model, 2mm probe tip



Barr Fistula Probes

Catalog #	Description
475-333	5 ¹ / ₂ " (140mm), 1.5mm double-ended



Pratt Rectal Probe

Catalog #	Description
475-335	7 ³ / ₄ " (200mm), 1.8mm probe tip, malleable, silver



Larry Rectal Probe and Grooved Director

Catalog #	Description
475-337	6 ¹ / ₂ " (164mm) working length, 2mm probe tip



Rosser Crypt Hook

Catalog #	Description
475-340	7" (177mm), 10.5mm hook x 2.85mm probe tip



Stewart Crypt Hook

Catalog #	Description
475-342	9" (230mm), hook ³ / ₄ " (20mm)



Kelly Fistula Scissors

6¼" (158mm)

Catalog #	Description
100-280	Straight
100-281	Curved

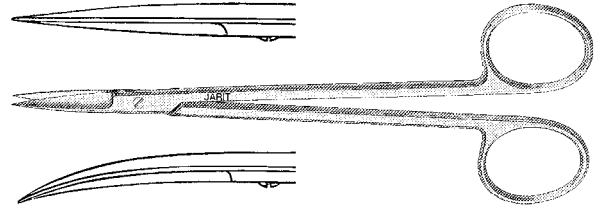

Pratt Smith T-Clamp

5⅞" (150mm)

Catalog #	Description
105-255	16mm wide jaws

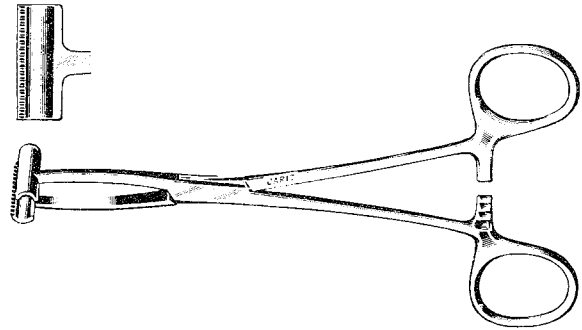

Pennington Forceps

6¼" (156mm)

Catalog #	Description
105-320	11mm wide triangular jaws

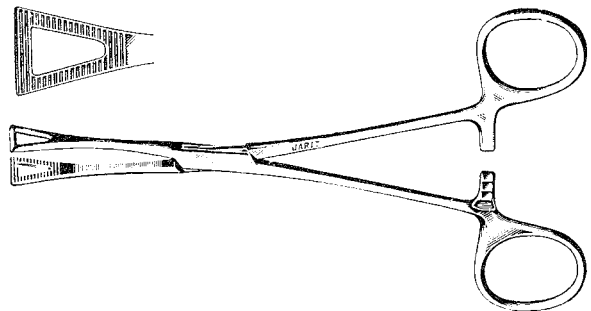

Otis Urethrotome

Catalog #	Description
475-415	11¾" (301mm), in wood case

Otis Urethrotome, Blade only

Catalog #	Description
475-416	10¼" (260mm), 3.5mm x 12mm blade
475-STP-415	Replacement Small Tip
475-LTP-415	Replacement Large Tip
475-CTP-415	Replacement Curved Tip

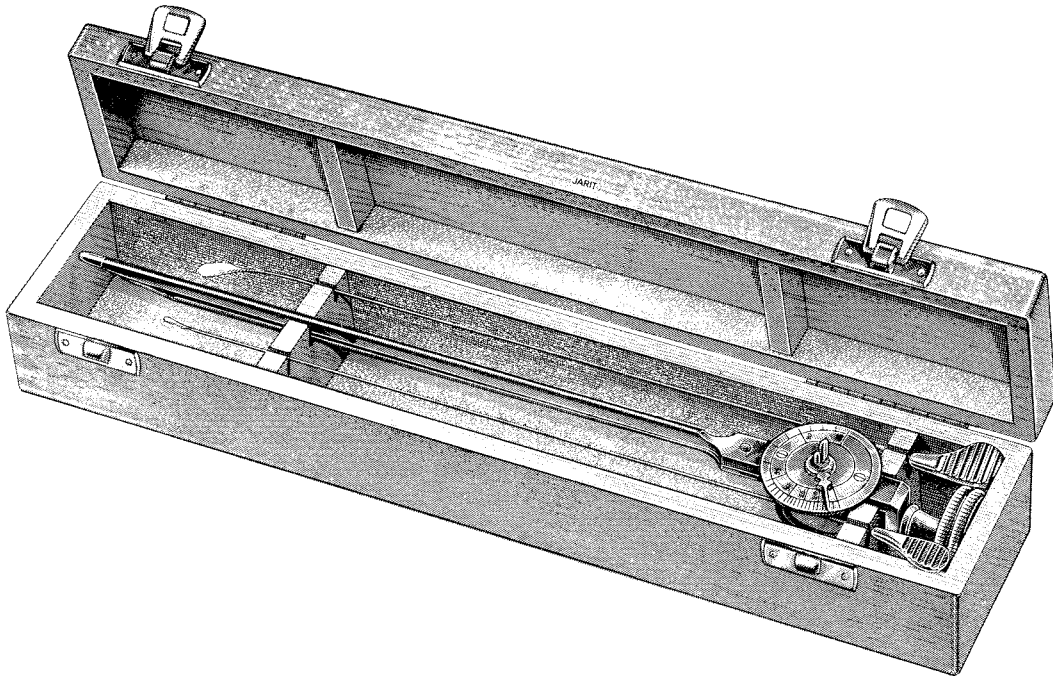

Young Prostatic Retractor

8½" (216mm)

Catalog #	Description
475-425	Notched blade, 1" x 1⅛" long (25mm x 27mm)

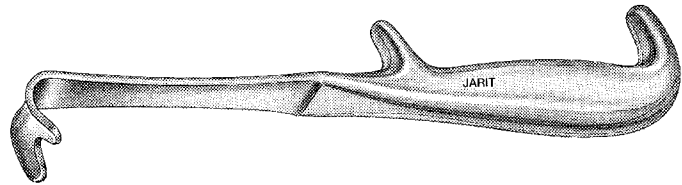

Young Prostatic Retractor

8½" (216mm)

Catalog #	Description
475-426	Anterior blade, 1⅝" x 2⅜" long (41mm x 61mm)

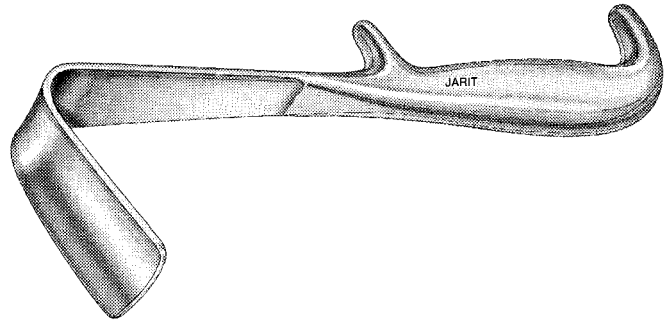

Young Prostatic Retractor

8¾" (220mm)

Catalog #	Description
475-427	Lateral blade, ½" x 2¼" long (12.5mm x 56mm)

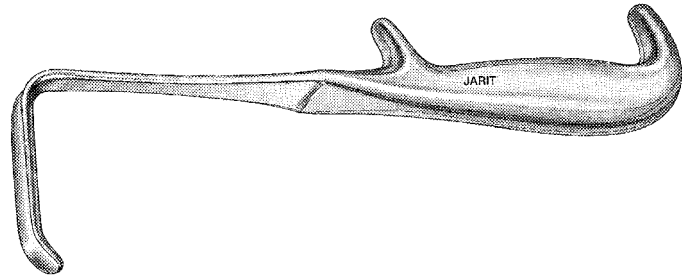

Young Prostatic Retractor

9" (229mm)

Catalog #	Description
475-428	Divided blade, 1⅝" x 1½" long (40mm x 39mm)

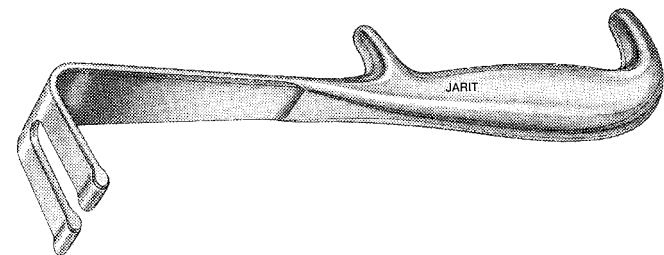

Judd-Masson Blade Retractor

Catalog #	Description
475-440	Maximum opening: 4¾" (121mm), Swivel blades: 1" x 2¾" deep (25mm x 70mm) Center blade: 1" x 2¾" deep (25mm x 70mm)

- 475-CBL-440 Replacement Center Blade
- 475-WNA-440 Replacement Wing Nut Assembly

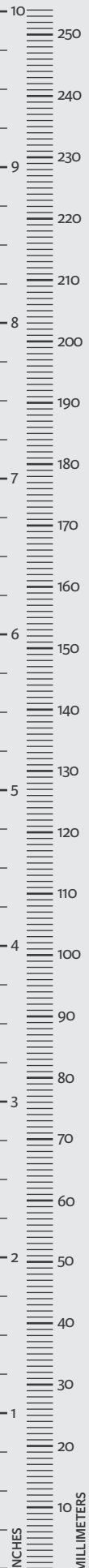
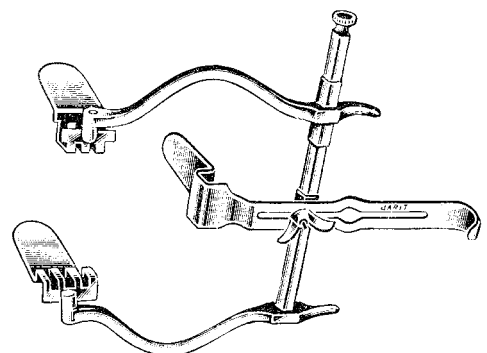

Randall Kidney Stone Forceps

Catalog #	Description
475-470	1/4 curve, 9 1/4" (237mm)
475-471	1/2 curve, 8 1/2" (219mm)
475-472	3/4 curve, 7 3/4" (198mm)
475-473	Full curve, 7 1/2" (190mm)

Details shown at 1/2 size

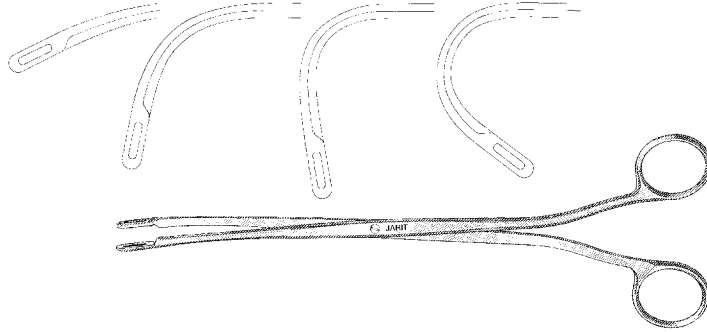

Gil-Vernet Renal Sinus Retractors

9 1/4" (238mm)

Catalog #	Description
475-490	9mm wide blade
475-491	11mm wide blade
475-492	13mm wide blade
475-493	15mm wide blade
475-494	18mm wide blade

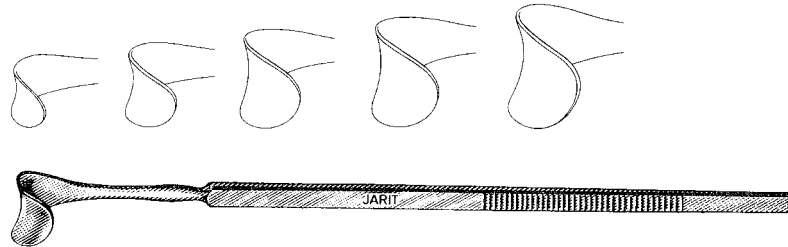

No Scalpel Vasectomy Ring Clamp

Catalog #	Description
475-480	5 1/2" (140mm), 5mm ring



No Scalpel Vasectomy Hemostat

Catalog #	Description
475-485	5 1/8" (130mm), curved smooth pointed tips



Stille Vessel Clamp

8¾" (225mm) overall length

Catalog #	Description
475-500	3" (75mm) jaw working length

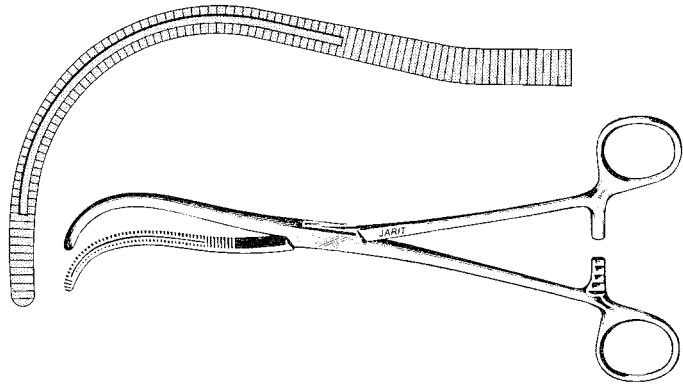

Mayo (Guyon Vessel Clamp)

10½" (265mm) overall length

Catalog #	Description
475-505	2" (52mm) jaw working length

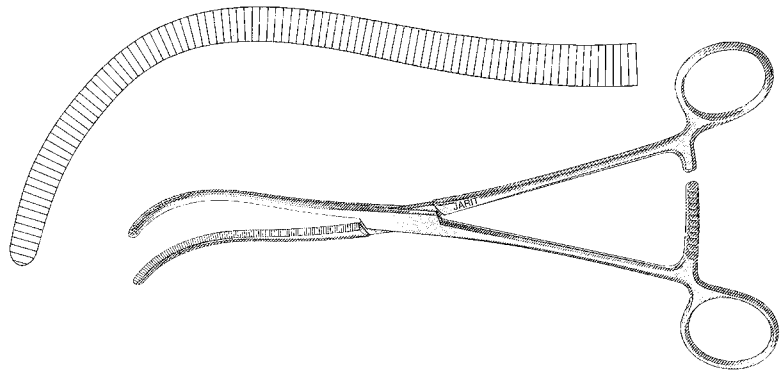

Herrick Kidney Clamp

9" (228mm) overall length

Catalog #	Description
475-510	2" (52mm) jaw working length

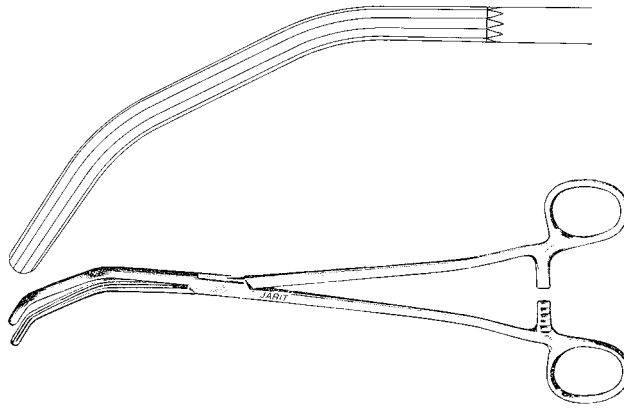

Wertheim Pedicle Clamp

10½" (265mm) overall length

Catalog #	Description
475-520	2" (52mm) jaw working length

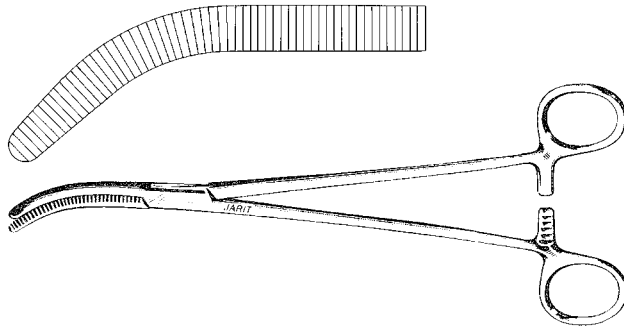

Wertheim-Cullen Pedicle Clamp

18¼" (211mm) overall length

Catalog #	Description
475-525	2¾" (60mm) jaw working length

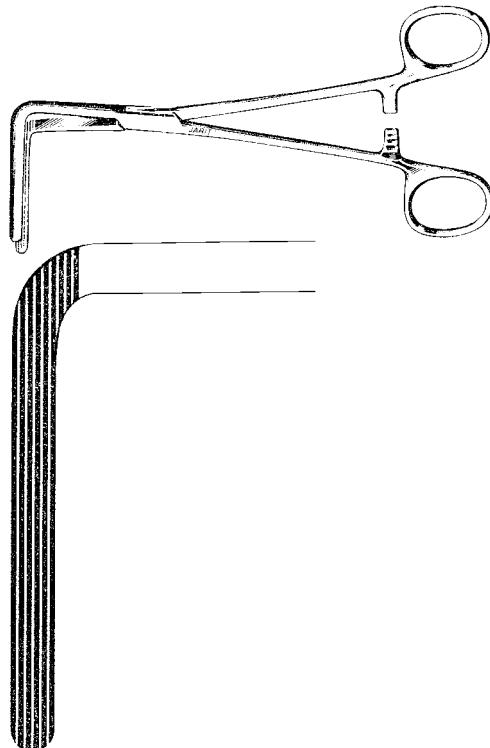

Van Buren Urethral Sounds

10³/₄" (270mm)

Catalog #	Description
475-550	8 French
475-551	10 French
475-552	12 French
475-553	14 French
475-554	16 French
475-555	18 French
475-556	20 French
475-557	22 French
475-558	24 French
475-559	26 French
475-560	28 French
475-561	30 French
475-562	32 French
475-563	34 French
475-564	36 French

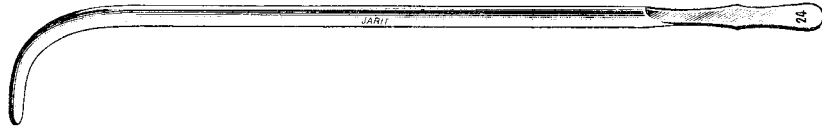

Mcree Infant Urethral Sounds

7¹/₄" (185mm)

Catalog #	Description
475-535	8 French
475-536	10 French
475-537	12 French
475-538	14 French
475-539	16 French
475-540	18 French
475-541	20 French
475-542	22 French
475-543	24 French
475-544	26 French
475-545	28 French
475-546	30 French
475-547	32 French
475-548	34 French
475-549	36 French



Female Catheter

5⁷/₈" (150mm)

Catalog #	Description
475-634	12 French
475-635	14 French
475-636	16 French
475-637	18 French

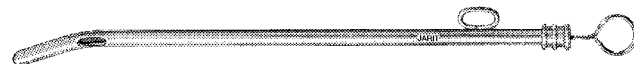

Integra™
Obstetrics &
Gynecology
Instruments and
General Surgical
Instruments

Graves Vaginal Specula

Catalog #	Description
500-100	Small blade: 3/4" x 3 1/4" (20mm x 83mm)
500-105	Medium blade: 1 3/8" x 4 3/8" (35mm x 110mm)
500-110	Large blade: 1 1/2" x 5" (37mm x 126mm)
500-KNT-100	Replacement Knurled Nut Pkg/12ea for 500-100, 05, 110

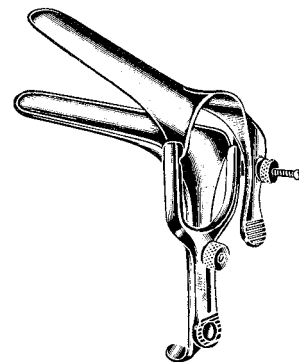

Pederson Vaginal Specula

Catalog #	Description
500-115	Small blade: 1/2" x 3 3/8" (14mm x 85mm)
500-120	Medium blade: 1" x 4 5/8" (24mm x 117mm)
500-125	Large blade: 1" x 5 1/8" (26mm x 129mm)
500-KNT-100	Replacement Knurled Nut Pkg/12ea for 500-100, 05, 110
500-TSC-115	Replacement Thumb Screw for 500-115, 120, 125
500-TSA-115	Replacement Thumbscrew Assembly

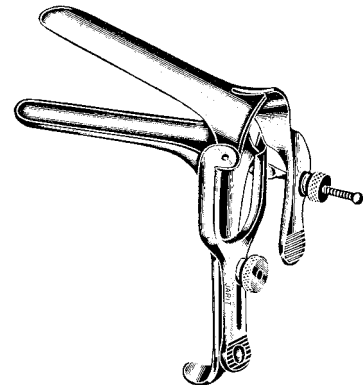

Pederson Vaginal Speculum

Catalog #	Description
500-130	Blade 5/8" x 4 1/2" (17mm x 113mm)
500-TSC-115	Replacement Thumb Screw

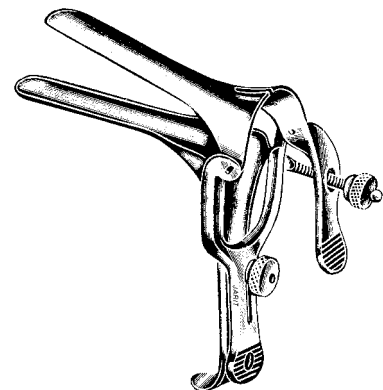

Graves Open-Side Vaginal Speculum

Catalog #	Description
500-135	Blade 1 3/8" x 4 1/8" (34mm x 104mm), 45° angle, one open side
500-TSC-115	Replacement Thumb Screw

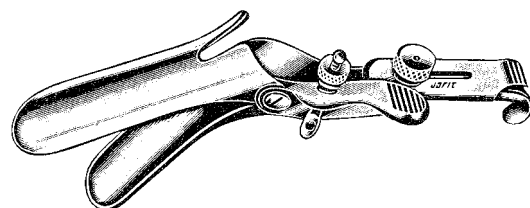

Cusco Vaginal Specula

swiss pattern

Catalog #	Description
500-137	Small blade: 7/8" x 3 5/8" (22mm x 90mm)
500-138	Medium blade: 1" x 4" (25mm x 100mm)
500-139	Large blade: 1 1/8" x 4 1/8" (27mm x 105mm)

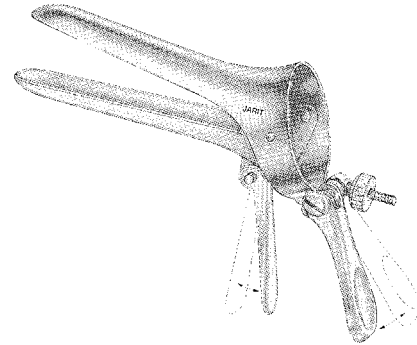

Cusco Vaginal Specula

Catalog #	Description
500-141	Small blade: 1 1/4" x 3" (32mm x 75mm)
500-142	Medium blade: 1 3/8" x 3 3/8" (35mm x 85mm)
500-143	Large blade: 1 3/8" x 4" (35mm x 100mm)

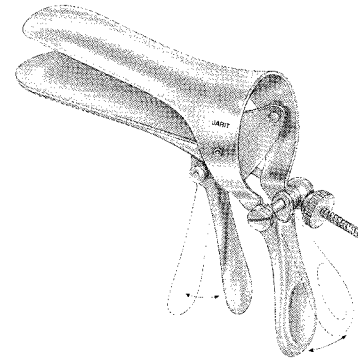

Auvard Vaginal Specula

2 1/2 lbs.

Catalog #	Description
500-145	Blade: 1 5/8" x 2 3/4" (41mm x 75mm), 45 degree angled blade
500-146	Blade: 1 3/4" x 3 1/4" (44mm x 83mm), 45 degree angled blade
500-147	Blade: 1 3/4" x 4" (46mm x 101mm), 45 degree angled blade

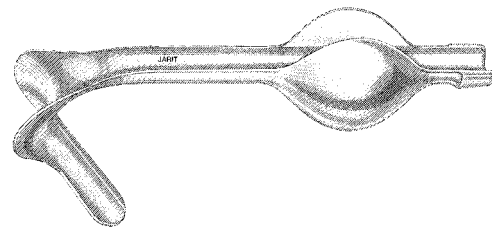

Steiner-Auvard Vaginal Speculum

2 1/2 lbs.

Catalog #	Description
500-148	Blade 1 3/8" x 5 7/8" (34mm x 150mm), 60 degree angled blade



O'Sullivan-O'Connor Vaginal Retractor

Catalog #	Description
500-160	Set includes: 1 retractor ring with 2 fixed blades 3 removable blades
	Removable blades: 500-SBL-160 500-MBL-160 500-LBL-160
500-WGN-160	Replacement Wing Nut pkg/3ea
500-BLD-160	Replacement Set of 3 Blades

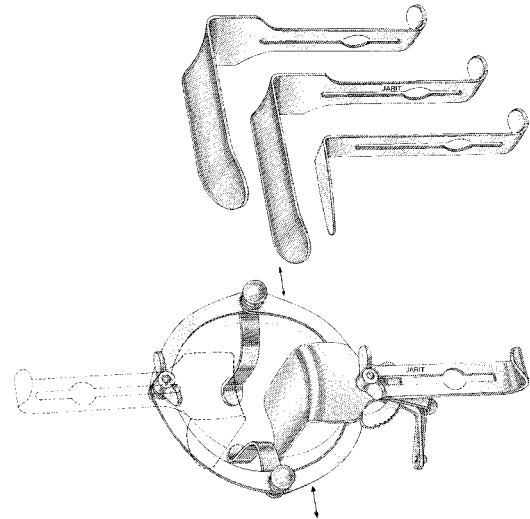

Jackson Vaginal Retractors

6 3/4" (172mm)

Catalog #	Description
500-162	Blade: 1 1/2" x 3" deep (39mm x 76mm)
500-163	Blade: 1 1/2" x 3 1/2" deep (39mm x 90mm)
500-164	Blade: 1 1/2" x 4" deep (39mm x 101mm)

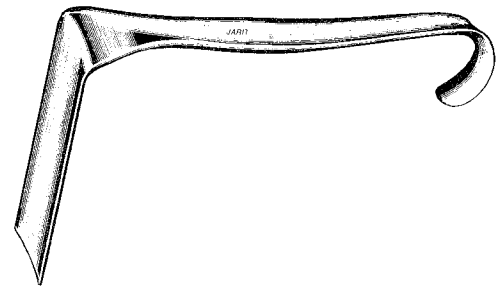

Eastman Vaginal Retractors

7" (178mm)

Catalog #	Description
500-166	Blade: 1 1/2" x 3 1/8" deep (39mm x 80mm)
500-167	Blade: 1 1/2" x 3 1/2" deep (39mm x 90mm)
500-168	Blade: 1 1/2" x 4" deep (39mm x 101mm)

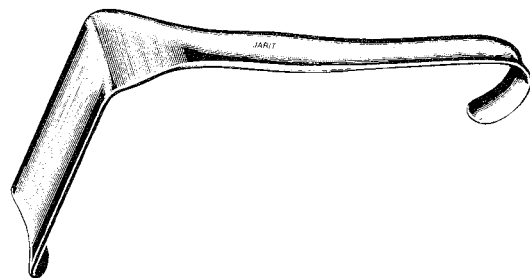

Murphy Gall Bladder Retractor

Catalog #	Description
475-429	10" (254mm), blade 2" wide (50mm)

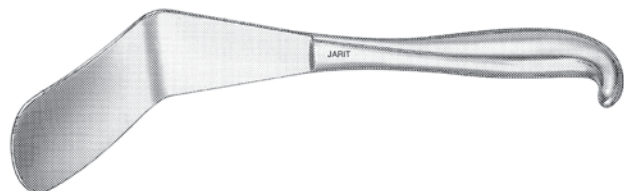

Doyen Vaginal Retractors

8⁷/₈" (225mm)

Catalog #	Description
200-145	Blade: 1 ³ / ₄ " x 2 ¹ / ₂ " deep (44mm x 64mm)
200-147	Blade: 2 ¹ / ₈ " x 3" deep (54mm x 76mm)
200-149	Blade: 2 ¹ / ₄ " x 3 ¹ / ₂ " deep (57mm x 89mm)

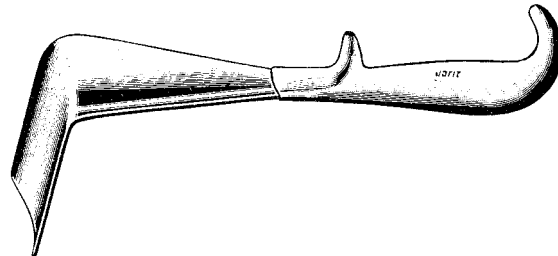

Sims Vaginal Retractors

double-ended

Catalog #	Description
500-170	6 ¹ / ₂ " (165mm), blades 7 ⁷ / ₈ " x 2 ¹ / ₂ " deep (22mm x 64mm) and 1" x 3" deep (25mm x 76mm)
500-171	6 ¹ / ₂ " (165mm), blades 1" x 2 ¹ / ₂ " deep (25mm x 64mm) and 1 ¹ / ₈ " x 3" deep (30mm x 76mm)
500-172	6 ¹ / ₂ " (167mm), blades 1" x 3 ¹ / ₈ " deep (25mm x 80mm) and 1 ¹ / ₄ " x 3 ³ / ₈ " deep (32mm x 87mm)
500-173	7 1 ¹ / ₂ " (190mm), blades 1 ¹ / ₈ " x 3" deep (29mm x 76mm) and 1 ³ / ₈ " x 3 ¹ / ₄ " deep (34mm x 82mm)
500-174	7 ³ / ₄ " (200mm), blades 1 ¹ / ₄ " x 3 ¹ / ₄ " deep (32mm x 82mm) and 1 ¹ / ₂ " x 4" deep (38mm x 102mm)
500-175	7 ¹ / ₂ " (190mm), blades 1 ³ / ₈ " x 3 ¹ / ₈ " deep (35mm x 80mm) and 1 ⁵ / ₈ " x 3 ⁷ / ₈ " deep (41mm x 100mm)

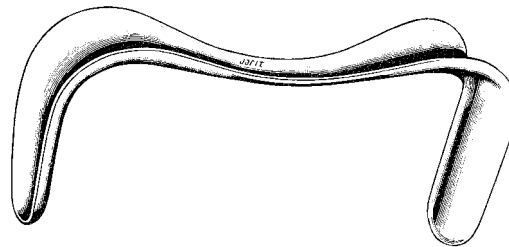

Sims Vaginal Retractors

single-ended

Catalog #	Description
500-180	7 ¹ / ₂ " (190mm), blade 1 ¹ / ₈ " x 2 ³ / ₄ " deep (30mm x 70mm)
500-181	8 ¹ / ₄ " (210mm), blade 1 ¹ / ₄ " x 3" deep (32mm x 75mm)
500-182	8 ³ / ₄ " (220mm), blade 1 ¹ / ₂ " x 3 ¹ / ₂ " deep (37mm x 88mm)

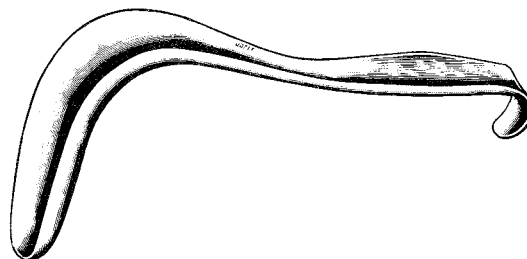

Sims Vaginal Retractors

hollow grip handle

Catalog #	Description
500-184	8 3/4" (220mm), blade 1" x 2 7/8" deep (25mm x 72mm)
500-185	8 3/4" (225mm), blade 1 1/8" x 3" deep (30mm x 77mm)
500-186	9" (230mm), blade 1 3/8" x 3 1/2" deep (36mm x 89mm)

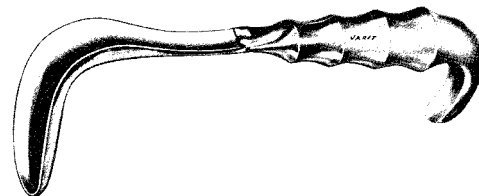

Heaney Hysterectomy Retractors

10 1/2" (267mm)

Catalog #	Description
500-190	blade 1 1/8" x 1 7/8" deep (29mm x 47mm)
500-191	blade 1 1/8" x 3" deep (29mm x 75mm)
500-192	blade 1 1/8" x 3 3/8" deep (29mm x 85mm)

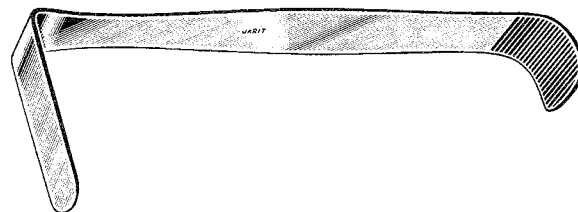

Heaney-Simon Hysterectomy Retractor

10 3/4" (273mm)

Catalog #	Description
500-195	blade 1 1/8" x 4 5/8" (28mm x 117mm)

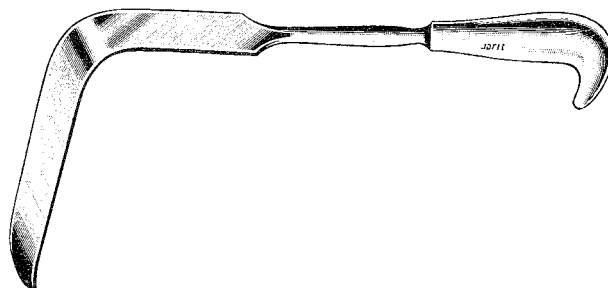

Delee Universal Retractor

9 1/2" (241mm)

Catalog #	Description
500-197	blade 3" x 2 1/8" (75mm x 54mm)

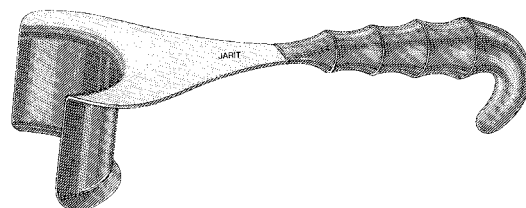

Hegar Uterine Dilators

double-ended, 8" (203mm)

Catalog #	Description
500-200	Set of 8, sizes 3mm through 18mm, in canvas roll
500-201	Sizes 1-2mm
500-202	Sizes 3-4mm
500-203	Sizes 5-6mm
500-204	Sizes 7-8mm
500-205	Sizes 9-10mm
500-206	Sizes 11-12mm
500-207	Sizes 13-14mm
500-208	Sizes 15-16mm
500-209	Sizes 17-18mm

500-CVB-200 Canvas Roll for Dilator Set



Hegar Uterine Dilators

single-ended, 7½" (185mm), 1mm to 26mm, 26 sizes

Catalog #	Description
500-215	Set of 26, sizes 1mm through 26mm, (whole sizes only) in canvas roll
500-400	1mm
500-401	1.5mm
500-402	2mm
500-403	2.5mm
500-404	3mm
500-405	3.5mm
500-406	4mm
500-407	4.5mm
500-408	5mm
500-409	5.5mm
500-410	6mm
500-411	6.5mm
500-412	7mm
500-413	7.5mm
500-414	8mm
500-415	8.5mm
500-416	9mm
500-417	9.5mm
500-418	10mm
500-419	10.5mm
500-420	11mm
500-421	11.5mm
500-422	12mm
500-423	12.5mm
500-424	13mm
500-425	13.5mm
500-426	14mm
500-427	14.5mm
500-428	15mm
500-429	15.5mm
500-430	16mm
500-431	16.5mm
500-432	17mm
500-433	17.5mm
500-434	18mm
500-435	18.5mm
500-436	19mm
500-437	20mm
500-438	21mm
500-439	22mm
500-440	23mm
500-441	24mm
500-442	25mm
500-443	26mm

500-CVB-215 Canvas Roll for Dilator Set

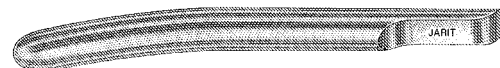

Hank Uterine Dilators

double-ended, 10³/₄" (270mm)

Catalog #	Description
500-230	Set of 6, sizes 9 French (4.5mm) through 20 French (10mm), in canvas roll
500-232	Sizes 9-10 French (4.5mm-5mm)
500-233	Sizes 11-12 French (5.5mm-6mm)
500-234	Sizes 13-14 French (6.5mm-7mm)
500-235	Sizes 15-16 French (7.5mm-8mm)
500-236	Sizes 17-18 French (8.5mm-9mm)
500-237	Sizes 19-20 French (9.5mm-10mm)

500-CVB-230 Canvas Roll for Hank Dilator Set



Pratt Uterine Dilators

double-ended, 10" (255mm)

Catalog #	Description
500-240	Set of 8, sizes 13 French (4.3mm) through 43 French (14.2mm), in canvas roll
500-241	Sizes 13-15 French (4.3mm-4.6mm)
500-242	Sizes 17-19 French (5.6mm-6.3mm)
500-243	Sizes 21-23 French (7mm-7.6mm)
500-244	Sizes 25-27 French (8.3mm-9mm)
500-245	Sizes 29-31 French (9.6mm-10.2mm)
500-246	Sizes 33-35 French (10.9mm-11.6mm)
500-247	Sizes 37-39 French (12.2mm-12.9mm)
500-248	Sizes 41-43 French (13.5mm-14.2mm)

500-CVB-240 Canvas Roll for Dilator Set



Sims Uterine Sounds

13¹/₂" (343mm), silver plated

Catalog #	Description
500-250	Graduated in inches
500-252	Graduated in centimeters



Simpson Uterine Sounds

13½" (343mm), silver plated

Catalog #	Description
500-256	Graduated in inches
500-258	Graduated in centimeters

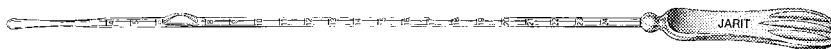

Kogan Endocervical Speculum

9⅝" (245mm)

Catalog #	Description
500-265	5.5mm x 24mm ring tips, with gauge and set screws

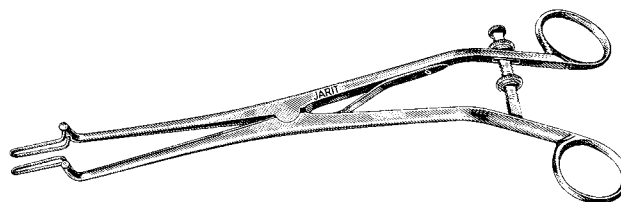

Somers Uterine Elevating Forceps

8¾" (223mm)

Catalog #	Description
500-270	32mm wide curved jaws, 32mm long serrations

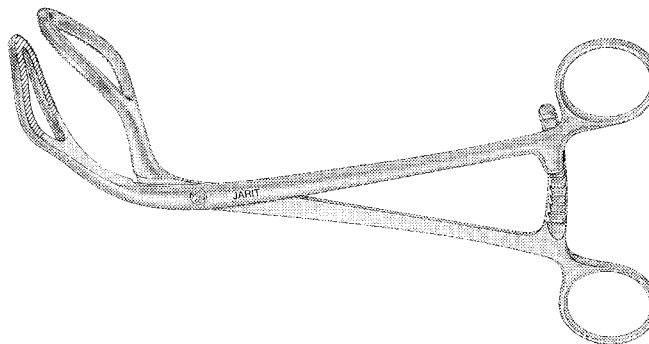



Hunter Uterine Curette

Catalog #	Description
500-295	12 1/4" (314mm), 30mm wide loop

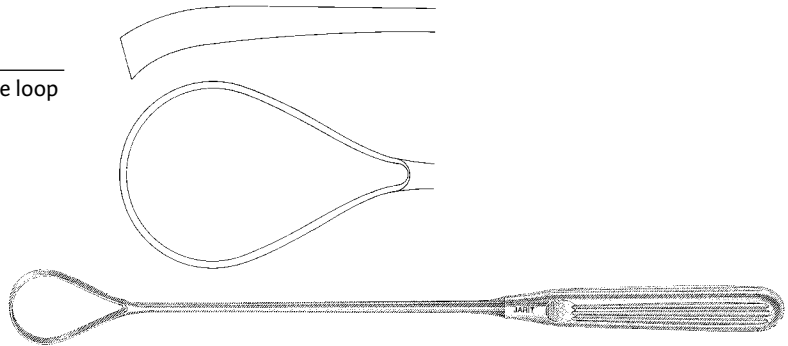

Sims Uterine Curettes

11" (280mm), sharp blade, malleable shaft

Catalog #	Description
500-298	Size 000: 4mm wide loop
500-299	Size 00: 5mm wide loop
500-300	Size 0: 6mm wide loop
500-301	Size 1: 7mm wide loop
500-302	Size 2: 8mm wide loop
500-303	Size 3: 9mm wide loop
500-304	Size 4: 10mm wide loop
500-305	Size 5: 11mm wide loop
500-306	Size 6: 12mm wide loop

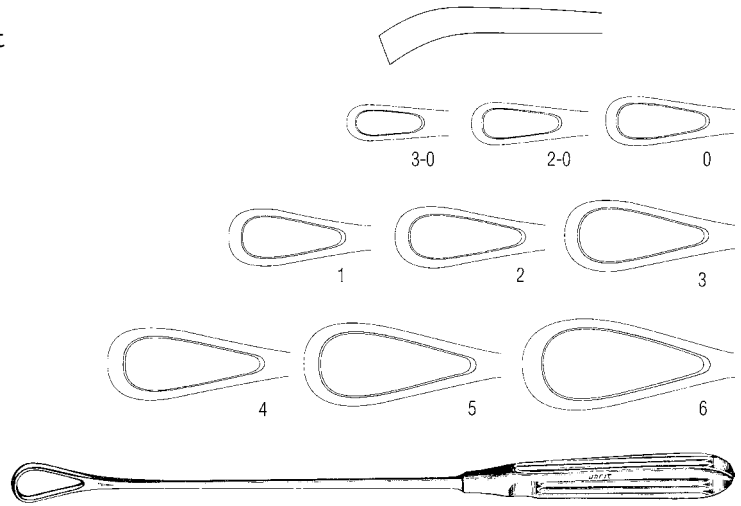

Thomas Uterine Curettes

11" (280mm), blunt blade, malleable shaft

Catalog #	Description
500-310	Size 0: 6mm wide loop
500-311	Size 1: 7mm wide loop
500-312	Size 2: 8mm wide loop
500-313	Size 3: 9mm wide loop
500-314	Size 4: 10mm wide loop
500-315	Size 5: 11mm wide loop
500-316	Size 6: 12mm wide loop

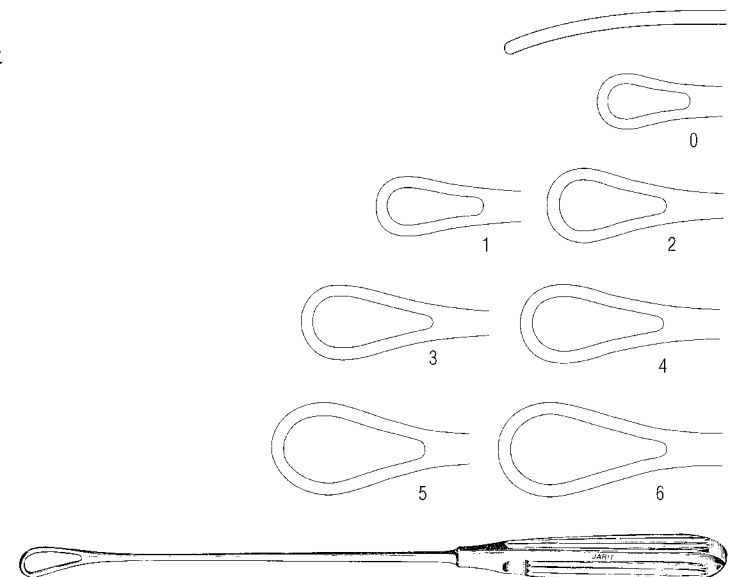

Heaney Uterine Biopsy Curette

9¾" (247mm)

Catalog #	Description
500-320	Serrated loop, 6mm wide x 10mm long



Randall Endometrial Biopsy Suction Curette

9¾" (247mm)

Catalog #	Description
500-325	4mm diameter, with Luer hub



Novak Endometrial Biopsy Suction Curettes

9¼" (235mm) working length, with luer hub

Catalog #	Description
500-330	4mm diameter
500-331	2mm diameter

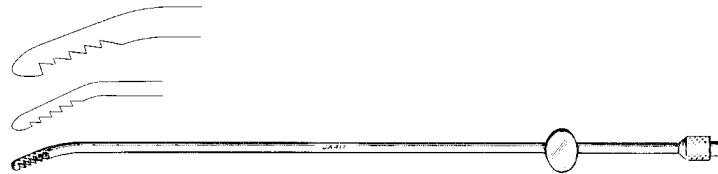

Kevorkian-Younger Endocervical Biopsy Curettes

12¼" (310mm), 2mm x 12mm loop

Catalog #	Description
500-335	without specimen basket
500-336	with specimen basket

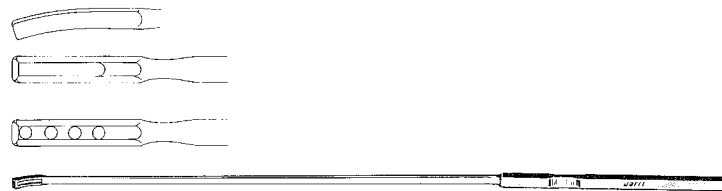

Duncan Endometrial Biopsy Curettes

11½" (290mm)

Catalog #	Description
500-337	2.5mm x 10mm loop



Townsend Endocervical Biopsy Curette

12 3/4" (310mm)

Catalog #	Description
500-340	1.5mm x 7mm loop



Thomas-Gaylor Biopsy Forceps

9 1/4" (234mm), S-shaped, screw lock

Catalog #	Description
505-100	5.5mm interfitted cups

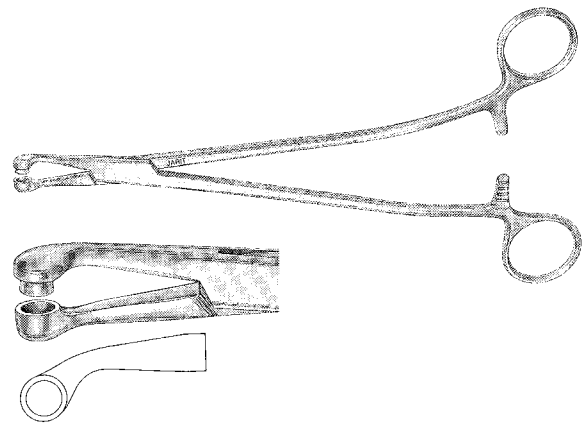

Thomas-Gaylor Biopsy Forceps

8 1/2" (215mm), curved jaws, straight handle

Catalog #	Description
505-105	5.5mm interfitted cups

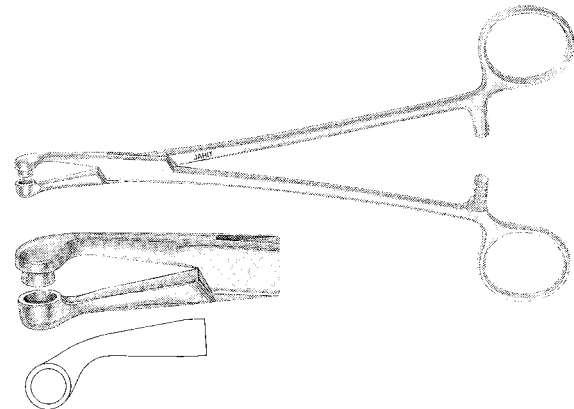

Wittner Biopsy Forceps

9" (230mm) working length, 4mm x 8mm bite

Catalog #	Description
505-110	Curved jaws with teeth
505-115	Straight jaws with teeth

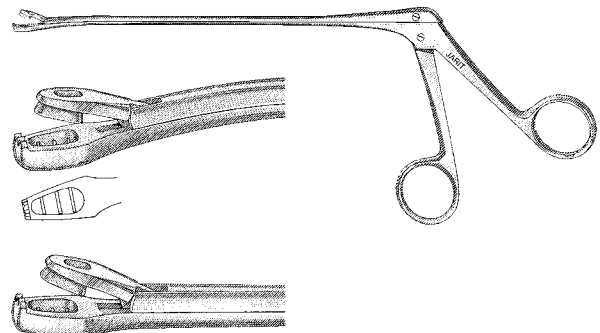

Eppendorfer Biopsy Forceps

8 1/4" (210mm) working length

Catalog #	Description
505-116	4.4mm x 8.5mm bite

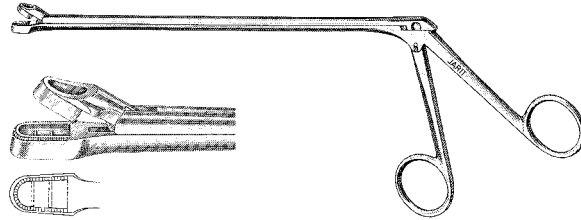

Schubert Biopsy Forceps

11" (279mm), straight shanks

Catalog #	Description
505-120	5mm x 8.6mm bite

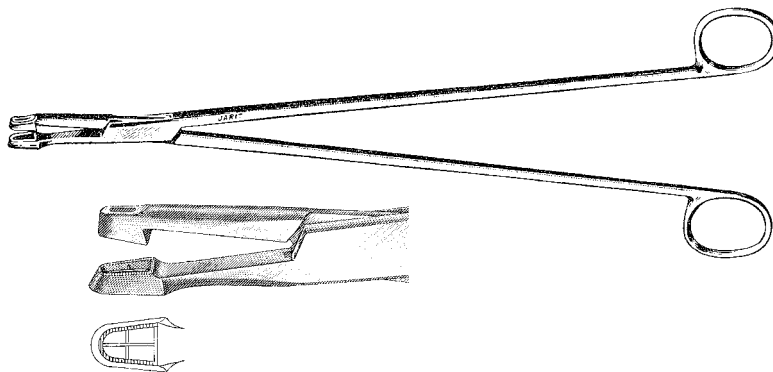

Schubert Biopsy Forceps

11" (279mm), angled shanks

Catalog #	Description
505-125	5mm x 8.6mm bite

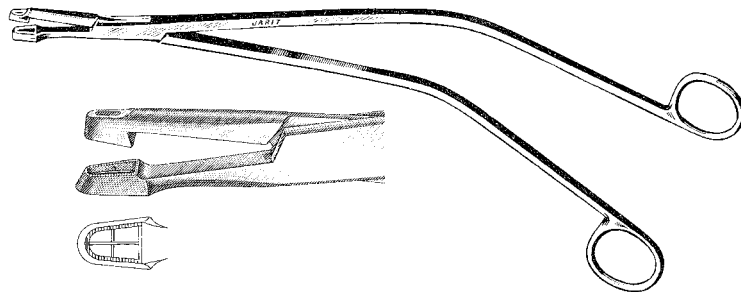

Hartman Biopsy Forceps

7" (178mm) working length

Catalog #	Description
505-135	7mm round blade

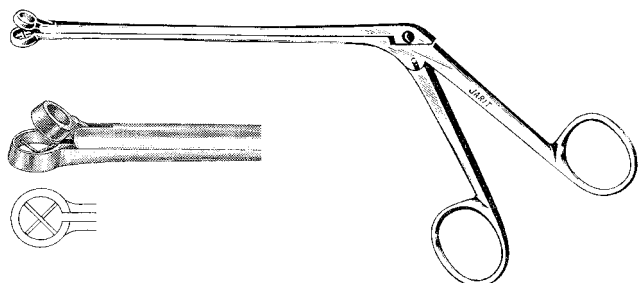

Kevorkian-Younger Biopsy Forceps

9¾" (245mm) working length

Catalog #	Description
505-140	3mm x 10mm bite

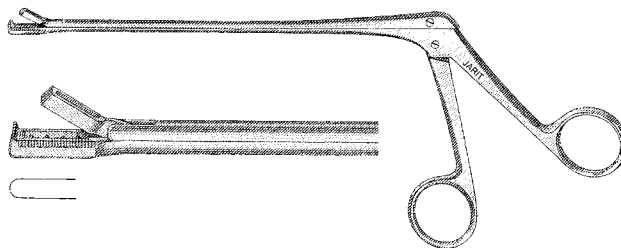

Burke Cervical Biopsy Punch

7¾" (195mm) working length

Catalog #	Description
505-144	3mm x 4.8mm bite



Tischler Biopsy Forceps

Catalog #	Description
505-145	9" (230mm) working length, pointed jaws, 3mm x 8mm bite

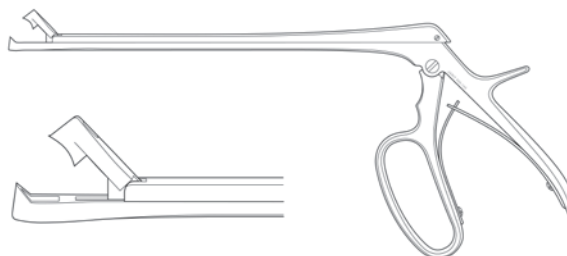

505-146	8½" (215mm) working length, improved model, rounded jaws, controls thickness of specimen, 3mm x 7mm bite
---------	--



Tischler Biopsy Forceps

11" (280mm), pointed jaws

Catalog #	Description
505-150	4mm x 8mm bite

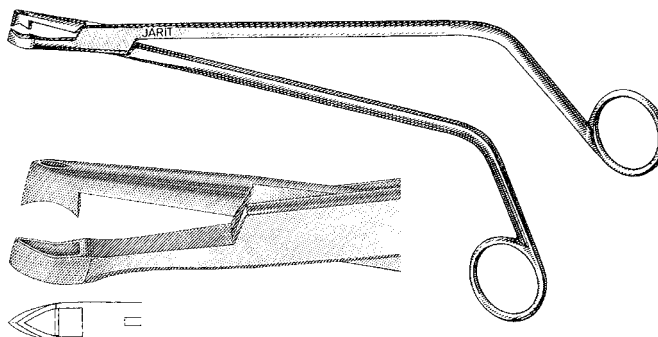

Bozeman Uterine Dressing Forceps

10" (254mm)

Catalog #	Description
505-160	S-shaped
505-162	S-shaped, 1 large ring
505-163	Straight

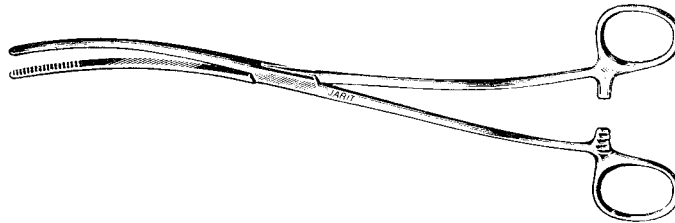

Laufe Uterine Polyp Forceps

8" (205mm)

Catalog #	Description
505-170	5mm x 15mm curved serrated jaw

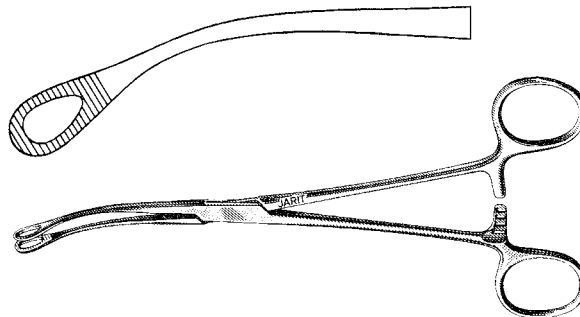

Overstreet Endometrial Polyp Forceps

9¼" (235mm)

Catalog #	Description
505-175	7mm x 35mm hollow fenestrated jaw

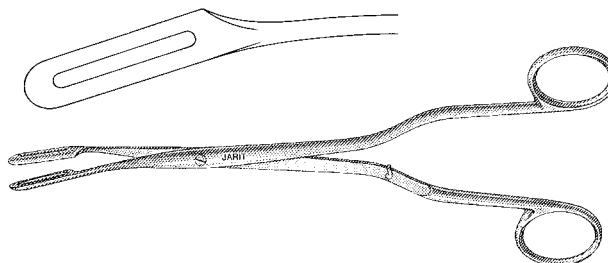

Fletcher Polyp Forceps

9¾" (245mm)

Catalog #	Description
115-119	Straight
115-120	Curved

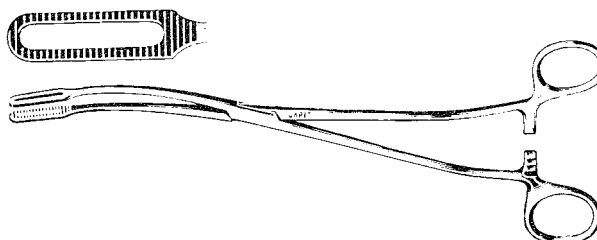

Schroeder Tenaculum Forceps

Catalog #	Description
505-200	10" (252mm)

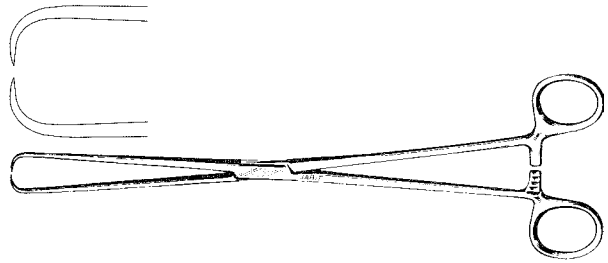

Braun Tenaculum Forceps

Catalog #	Description
505-205	10" (254mm)

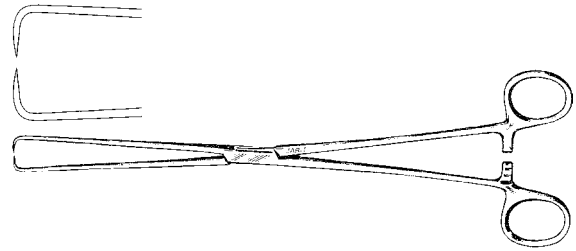

Duplay Tenaculum Forceps

Catalog #	Description
505-206	10 ³ / ₄ " (275mm), double curved

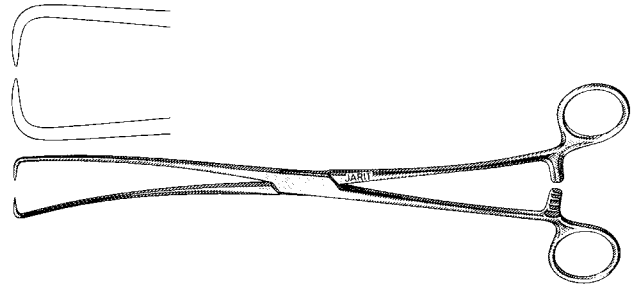

Barrett Tenaculum Forceps

Catalog #	Description
505-210	7 ¹ / ₄ " (185mm)

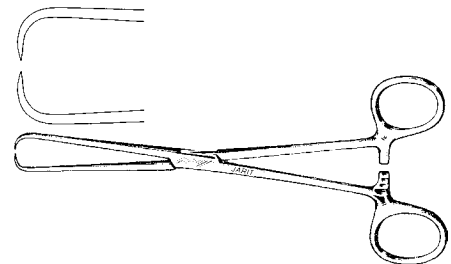

Staud-Moore Tenaculum Forceps

Catalog #	Description
505-215	6 ¹ / ₂ " (165mm)

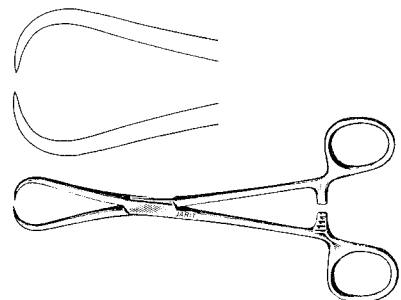

Skene Tenaculum Forceps

9 1/4" (236mm)

Catalog #	Description
505-220	Curved to one side

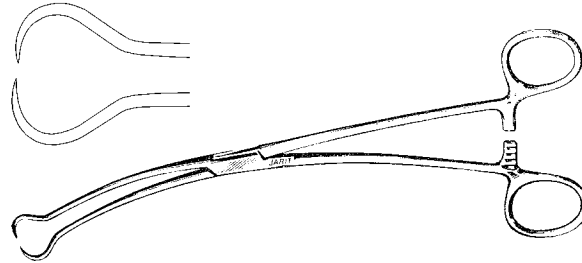

Hulka Tenaculum Forceps

11" (278mm)

Catalog #	Description
505-225	3.5mm probe tip and single tooth

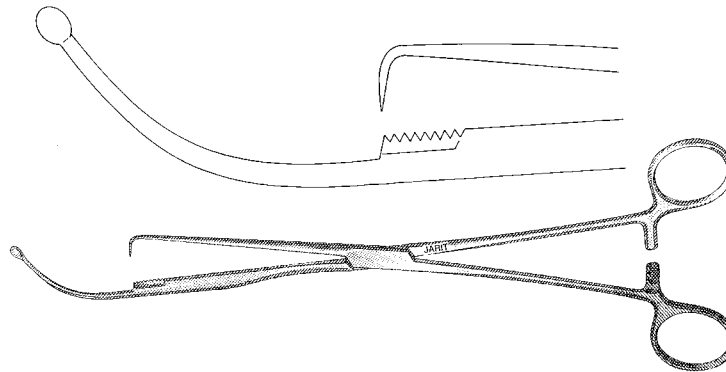

Cohen Acorn Cannula

Catalog #	Description
505-230	10 1/4" (260mm) intrauterine probe, spring mounted forceps holder with small and large cervical cones
505-231	Small cervical cone 3.2mm x 18.7mm x 55mm for 505-230
505-232	Large cervical cone 3.2mm x 25mm x 55mm for 505-230
505-SPR-230	Replacement Spring

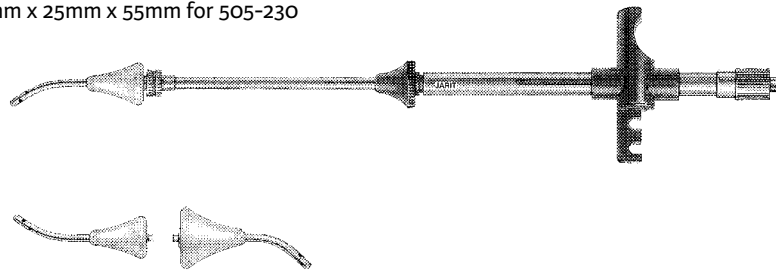

Schroeder Uterine Vulsellum Forceps

9 1/2" (250mm), 10mm wide x 18mm long, 2 x 2 teeth

Catalog #	Description
505-240	Straight

505-241	Curved on flat
---------	----------------

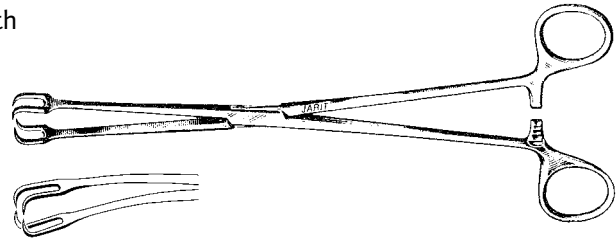

Teale Uterine Vulsellum Forceps

11 1/4" (245mm)

Catalog #	Description
505-245	6.2mm 3 x 4 teeth, curved to side

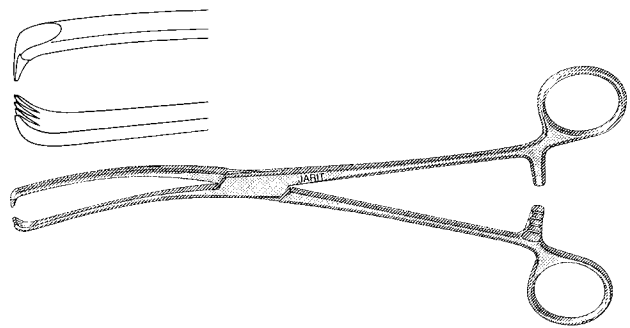

Gordon Uterine Vulsellum Forceps

8 3/4" (220mm)

Catalog #	Description
505-246	9.3mm 3 x 3 teeth, straight

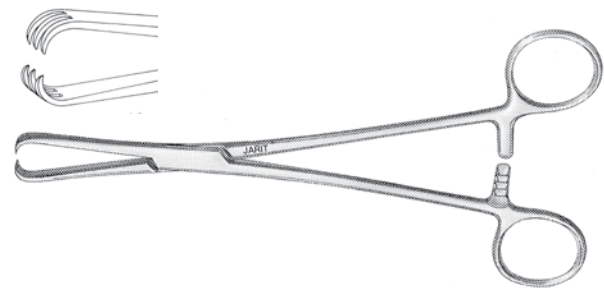

Jacobs Uterine Vulsellum Forceps

8 1/2" (215mm), 7mm 2 x 2 teeth

Catalog #	Description
505-250	Straight

505-252	Curved to side
---------	----------------

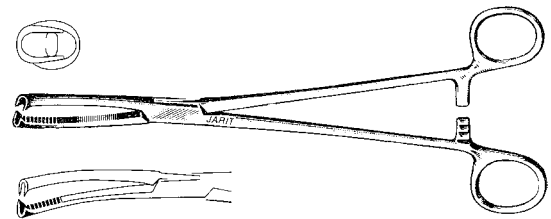

Henrotin Uterine Vulsellum Forceps

8 1/2" (215mm)

Catalog #	Description
505-255	7mm 2 x 3 teeth

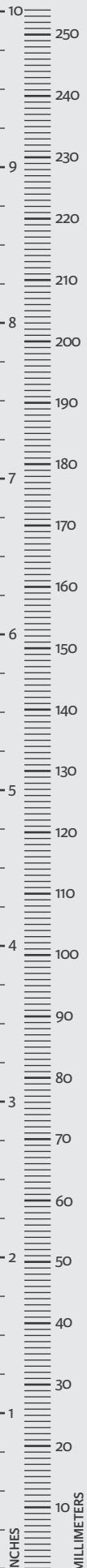
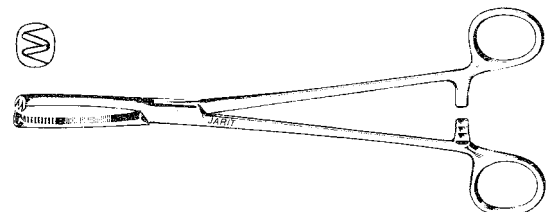

Emmett Uterine Tenaculum Hooks

8⁵/₈" (220mm)

Catalog #	Description
505-260	Style 1: 1/2 curved
505-261	Style 2: 3/4 curved
505-262	Style 3: right angled
505-263	Style 4: acute angled
505-264	Style 5: double angled

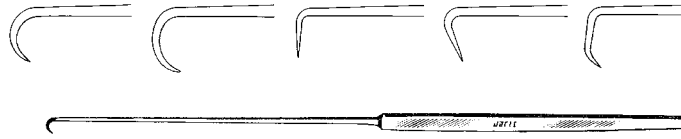

Parametrium Scissors, Carb-Edge

Catalog #	Description
505-265	9" (226mm), slight curve, 81mm blades
505-266	8 ³ / ₄ " (224mm), curve, 78mm blades
505-267	8 ¹ / ₂ " (219mm), full curve, 76mm blades
505-268	10 ¹ / ₂ " (267mm), slight curve, 81mm blades
505-269	10 ¹ / ₄ " (260mm), curve, 78mm blades
505-270	10" (255mm), full curve, 76mm blades
505-271	12" (305mm), slight curve, 81mm blades
505-272	11 ³ / ₄ " (300mm), curve, 78mm blades
505-273	11 ¹ / ₂ " (295mm), full curve, 76mm blades

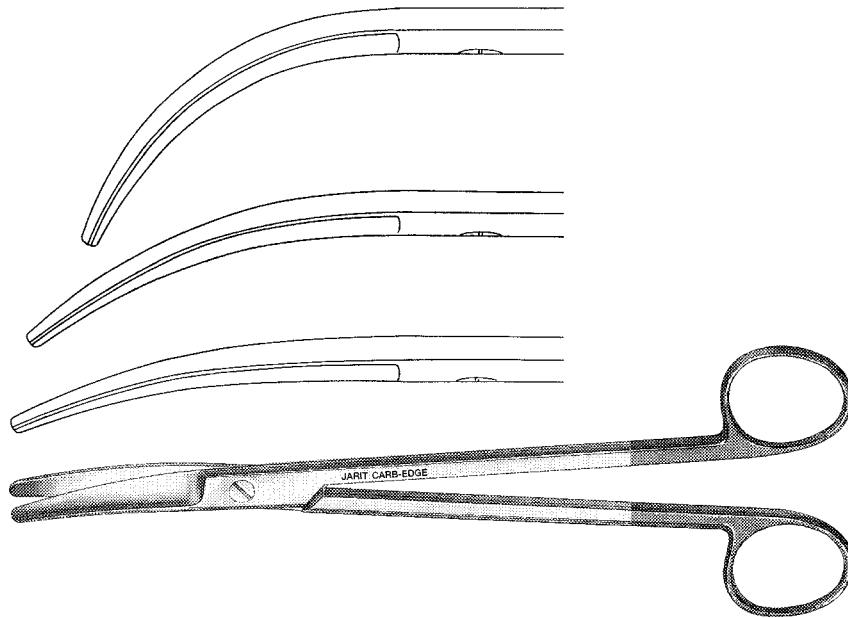

Z-Hysterectomy Forceps

Flared Shanks

Catalog #	Description
505-280	8½" (219mm), straight
505-281	8½" (219mm), slight curve
505-282	8½" (219mm), curved
505-283	8¼" (207mm), angle
505-284	10" (251mm), straight
505-285	10" (252mm), slight curve
505-286	9¾" (246mm), curved
505-287	9½" (239mm), angle
505-288	12¼" (310mm), straight
505-289	12¼" (309mm), slight curve
505-290	11¾" (301mm), curved
505-291	11¾" (297mm), angle
505-292	14¼" (363mm), straight
505-293	14½" (365mm), slight curve
505-294	14½" (367mm), curved
505-295	13¾" (352mm), angle

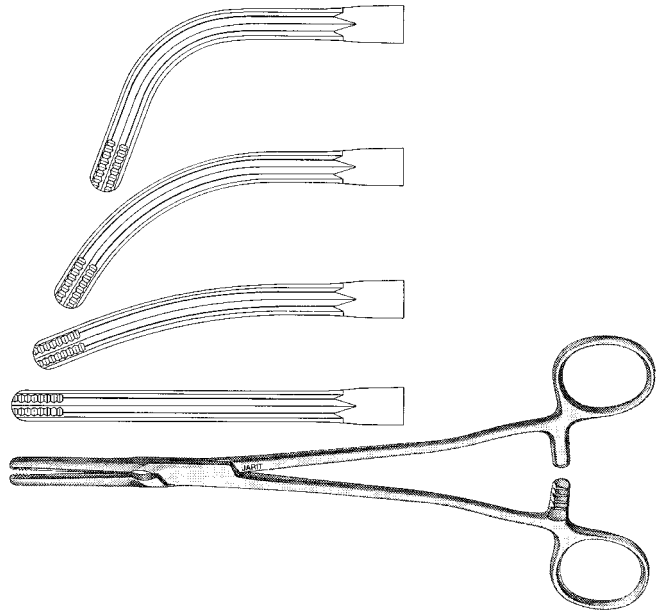

Heaney Hysterectomy Forceps

8¼" (210mm), curved, single tooth

Catalog #	Description
505-300	Light pattern
505-305	Heavy pattern

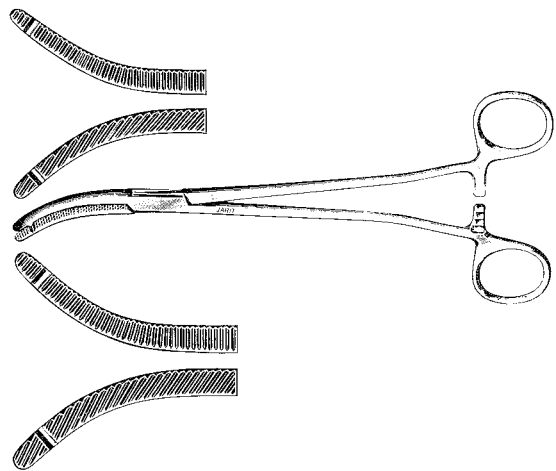

Heaney Hysterectomy Forceps

8½" (215mm)

Catalog #	Description
505-310	Curved, double tooth, heavy pattern

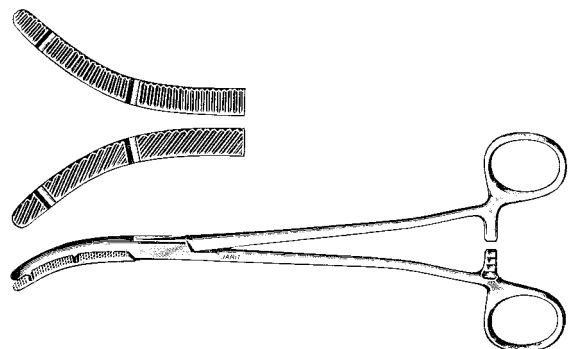

Heaney-Rezek Hysterectomy Forceps

8½" (215mm)

Catalog #	Description
505-315	8½" (213mm), straight, single tooth, cross-serrated

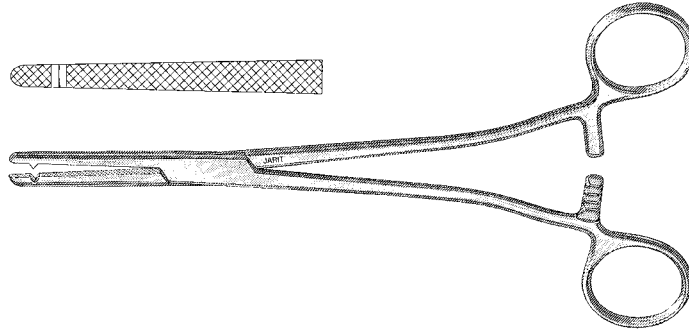

Heaney-Ballentine Hysterectomy Forceps

longitudinal grooves

Catalog #	Description
505-319	8½" (213mm), straight
505-320	8¼" (210mm), curved
505-312	10½" (270mm), curved
505-313	10½" (270mm), straight
505-314	11¾" (300mm), curved
505-316	11¾" (300mm), straight
505-317	13¾" (350mm), curved
505-318	13¾" (350mm), straight

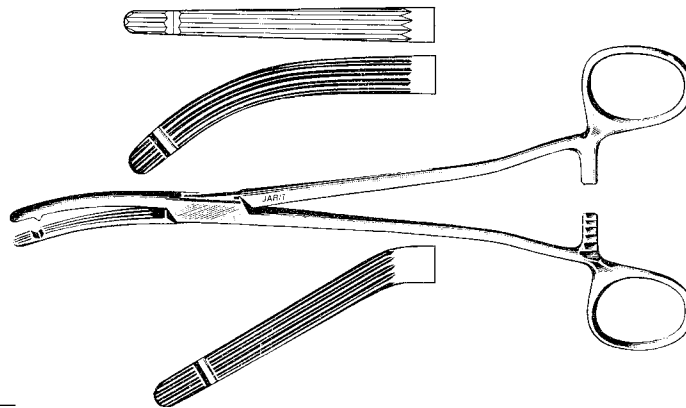

Garland Hysterectomy Forceps

8¼" (207mm)

Catalog #	Description
505-330	Angled on flat, longitudinal grooves

Heaney Hysterectomy Forceps
Cardio-Grip serrations

Catalog #	Description
505-321	9" (229mm), straight
505-322	8¾" (222mm), Curved

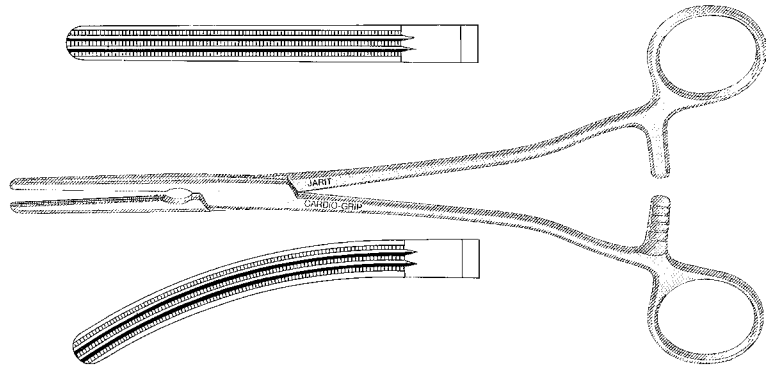

Masterson Hysterectomy Forceps
8½" (215mm), Cardio-Grip serrations

Catalog #	Description
505-325	Straight
505-326	Curved

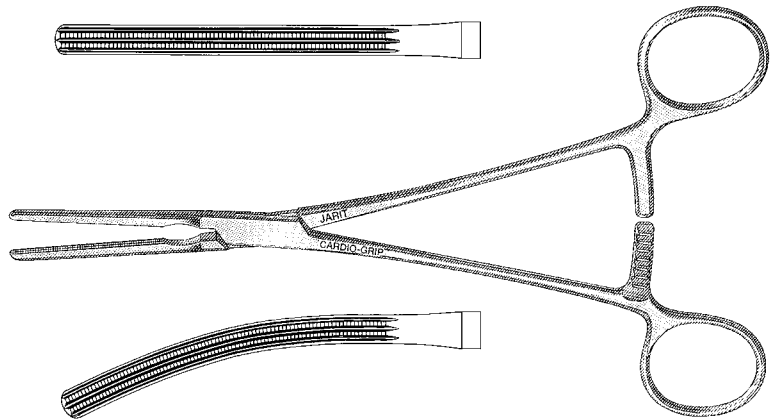

Rogers Hysterectomy Clamps

10½" (268mm), Cardio-Grip serrations

Catalog #	Description
505-327	Straight
505-328	Curved

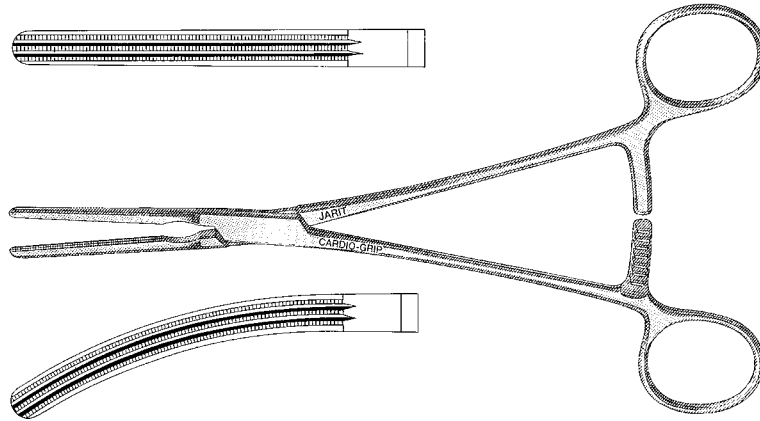

Long Hysterectomy Forceps

8" (201mm)

Catalog #	Description
505-335	1 x 2 teeth, longitudinal grooves

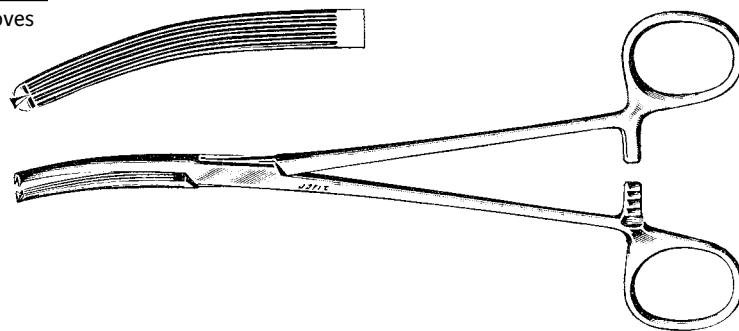

Phaneuf Uterine Artery Forceps

8" (203mm)

Catalog #	Description
505-340	Straight
505-345	Angled on flat

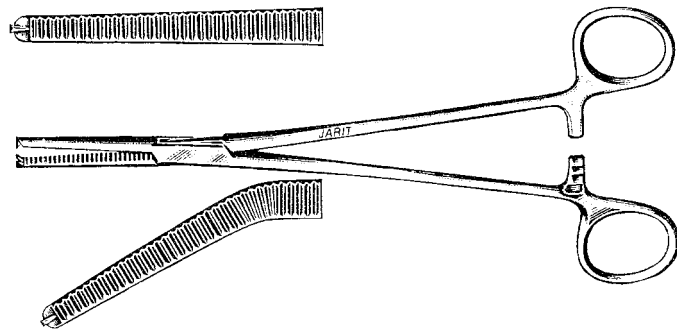

Billroth Tumor Forceps

11" (280mm)

Catalog #	Description
505-360	4-sharp prongs, 20mm wide x 23mm length

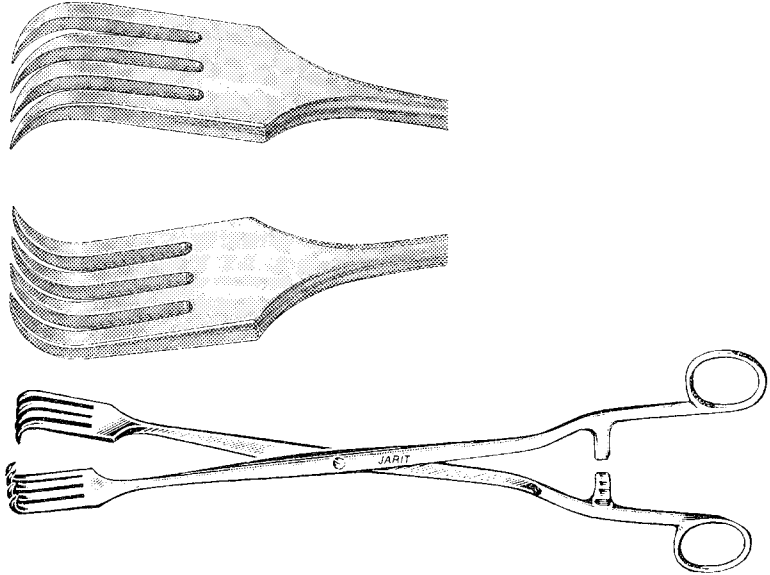

Doyen Tumor Screw

6¾" (170mm)

Catalog #	Description
505-365	24mm diameter

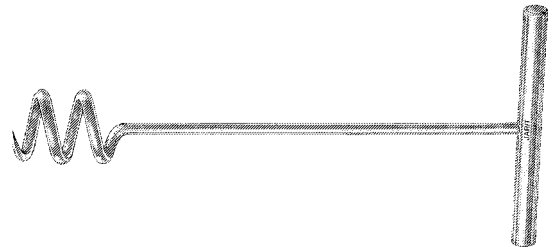

Rochester-Pean Artery Forceps, (Mirror Finish)

Manufactured from high grade German surgical stainless steel which is ground and polished to a mirror finish

Catalog #	Description
105-190	8" (203mm), straight
105-191	8" (203mm), curved
105-195	8¾" (221mm), straight
105-196	8¾" (221mm), curved
105-197	10" (254mm), straight
105-198	11" (279mm), straight
105-199	12" (305mm), straight

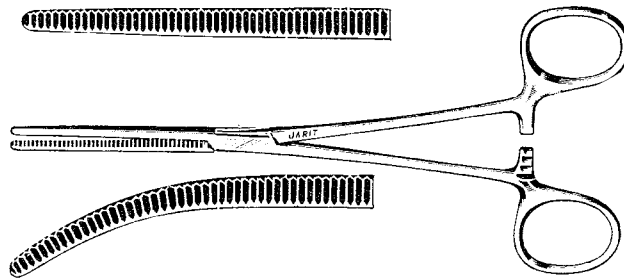

Rochester-Pean Artery Forceps, (Satin Finish)

Manufactured from high grade German surgical stainless steel which is ground and polished to a satin finish

Catalog #	Description
106-190	8" (203mm), straight
106-191	8" (203mm), curved
106-195	8¾" (221mm), straight
106-196	8¾" (221mm), curved

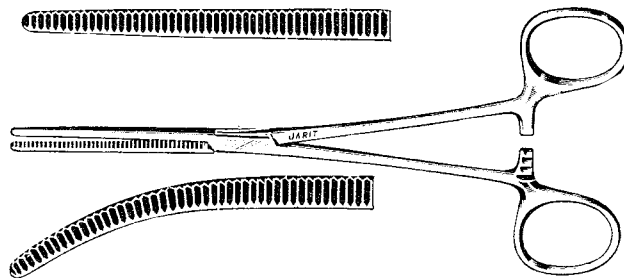

Rochester-Pean Artery Forceps, (Matte Finish)

Manufactured from high grade German surgical stainless steel which is glass beaded to a matte finish

Catalog #	Description
107-190	8" (203mm), straight
107-191	8" (203mm), curved

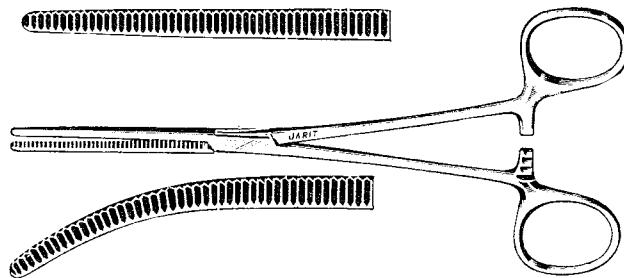

Rochester-Ochsner Artery Forceps, (Mirror Finish)

Manufactured from high grade German surgical stainless steel which is ground and polished to a mirror finish

Catalog #	Description
105-210	7¼" (184mm), straight
105-212	7¼" (184mm), curved
105-220	7¾" (200mm), straight
105-222	7¾" (200mm), curved
105-223	8¾" (225mm), straight
105-224	8¾" (225mm), curved
105-225	10½" (265mm), straight
105-226	10½" (265mm), curved
105-227	11" (279mm), straight
105-229	12" (305mm), straight
105-228	14" (356mm), straight

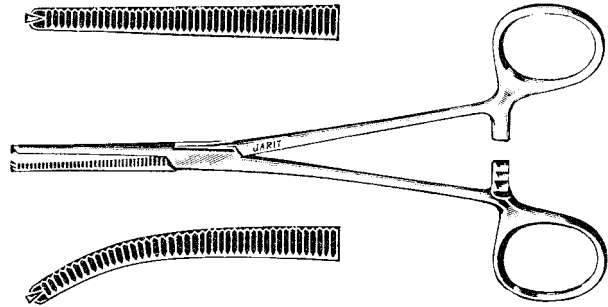

Rochester-Ochsner Artery Forceps, (Satin Finish)

Manufactured from high grade German surgical stainless steel which is ground and polished to a satin finish

Catalog #	Description
106-210	7¼" (184mm), straight
106-212	7¼" (184mm), curved
106-220	7¾" (200mm), straight
106-222	7¾" (200mm), curved

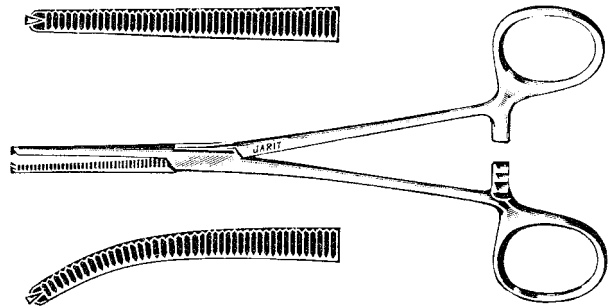

Rochester-Ochsner Artery Forceps, (Matte Finish)

Manufactured from high grade German surgical stainless steel which is glass beaded to a matte finish

Catalog #	Description
107-210	7¼" (184mm), straight
107-220	7¾" (200mm), straight

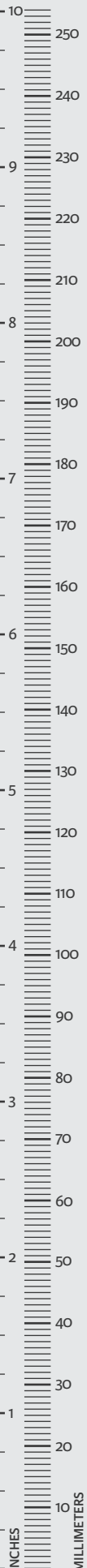
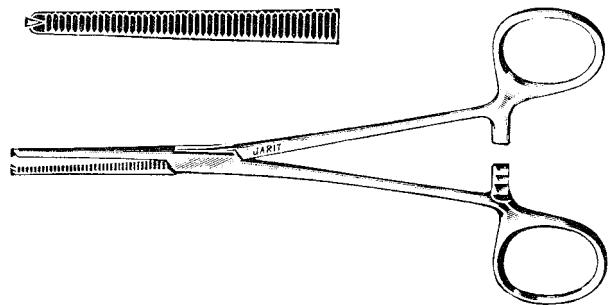

Sims Uterine Scissors

8" (203mm), straight

Catalog #	Description
505-400	Sharp-sharp
505-401	Sharp-blunt
505-402	Blunt-blunt

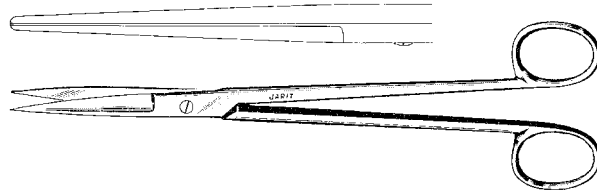

Sims Uterine Scissors

7¾" (200mm), curved

Catalog #	Description
505-405	Sharp-sharp
505-406	Sharp-blunt
505-407	Blunt-blunt

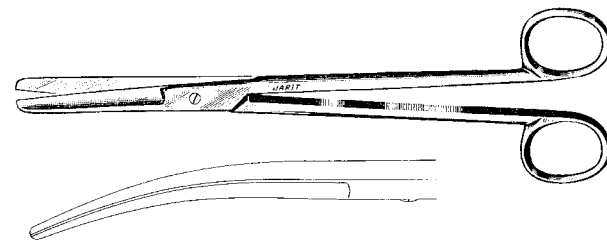

Kelly Uterine Scissors

6¼" (158mm)

Catalog #	Description
100-280	Straight
100-281	Curved

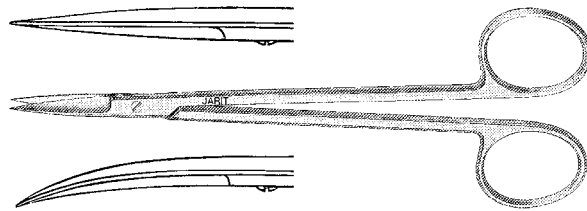

Mayo Uterine Scissors

9" (230mm)

Catalog #	Description
305-140	Straight
305-141	Curved

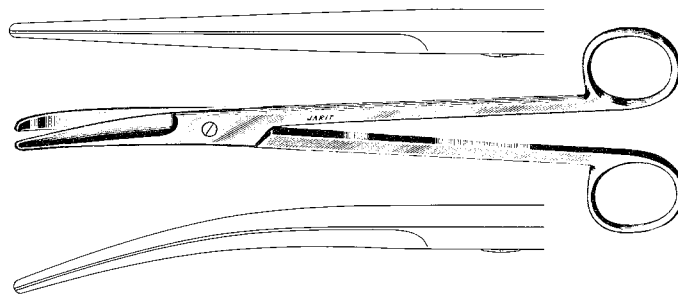

Mayo-Harrington Scissors, Carb-Edge

Catalog #	Description
101-225	9" (230mm), straight
101-226	9" (230mm), curved
101-230	14 1/4" (361mm), straight
101-232	14 1/4" (361mm), curved

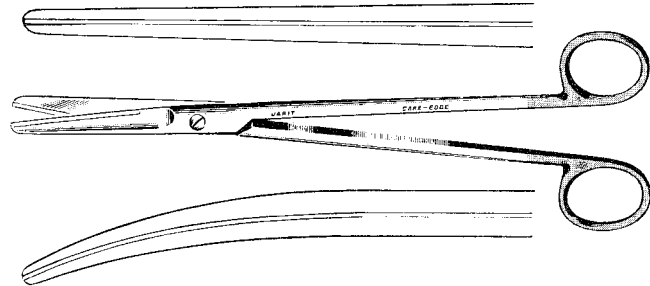

Mayo Scissors, Supercut™

Catalog #	Description
102-115	9" (230mm), straight
102-116	9" (230mm), curved
102-118	11" (280mm), curved
102-114	12" (305mm), curved

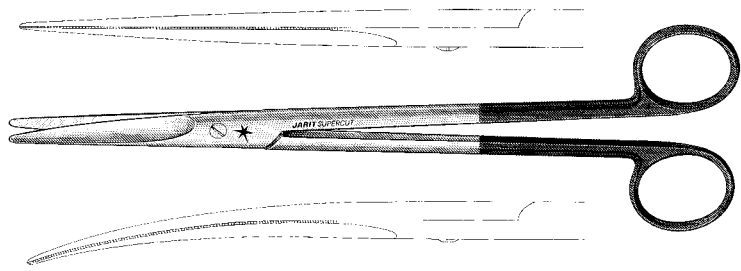

Ferguson Scissors

7 1/4" (184mm)

Catalog #	Description
100-233	Angled on flat

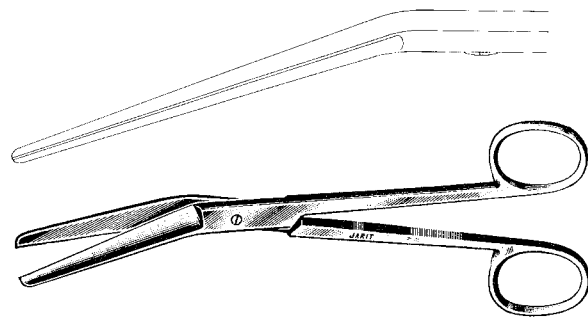

Braun Episiotomy Scissors

Catalog #	Description
505-435	5 3/4" (146mm)
505-436	8 3/4" (222mm)

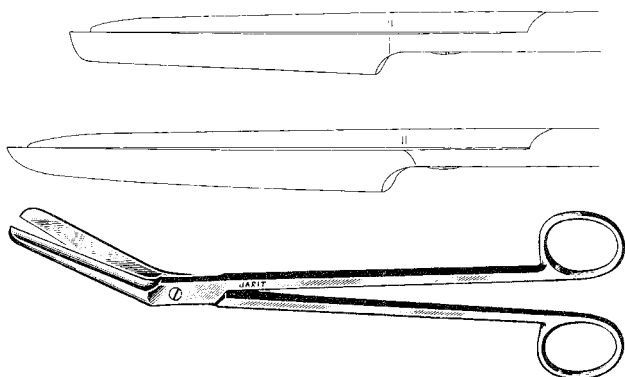

Iowa Trumpet Pudendal Needle Guide

5½" (140mm)

Catalog #	Description
510-100	Uses 6" (152mm), 28 gauge needle

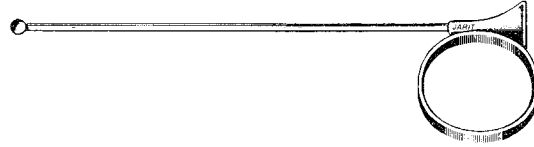

Iowa Membrane Puncturing Forceps

10½" (264mm)

Catalog #	Description
510-120	7mm wide, 5mm x 6mm teeth

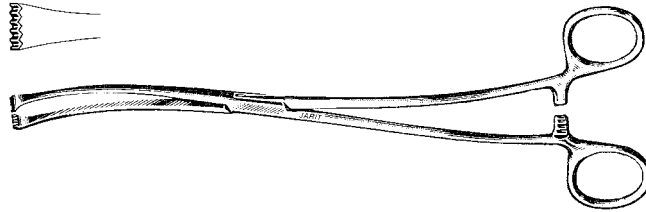

Martin Pelvimeter

13½" (340mm)

Catalog #	Description
510-130	Graduated in centimeters and inches

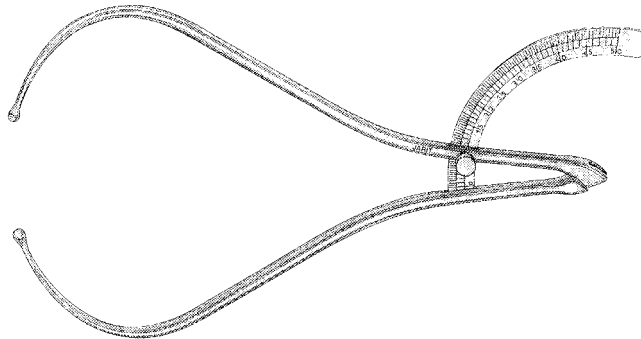

Kelly Placenta Forceps

Catalog #	Description
510-140	12½" (318mm)

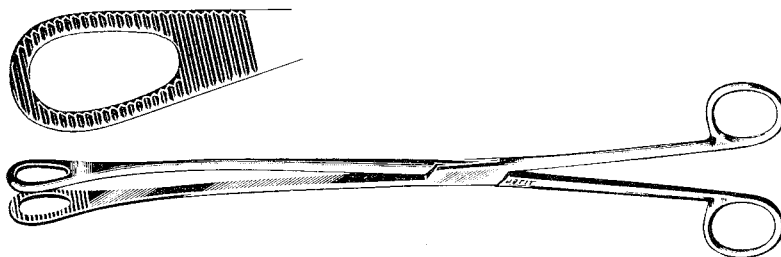

Barrett Placenta Forceps

Catalog #	Description
510-145	10¾" (273mm)

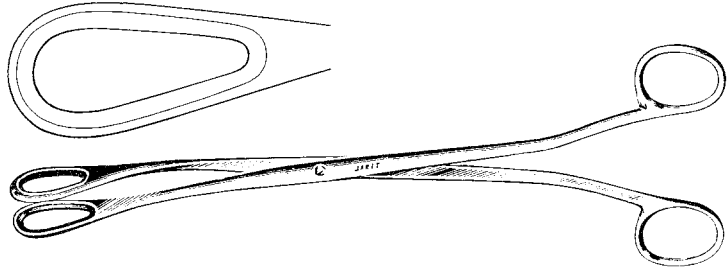

Umbilical Cord Scissors

Catalog #	Description
510-155	4⅞" (105mm)

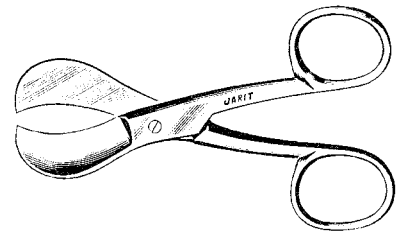

Zipser Penis Clamp

Catalog #	Description
510-165	4⅞" (105mm) overall length, 3mm opening for infants

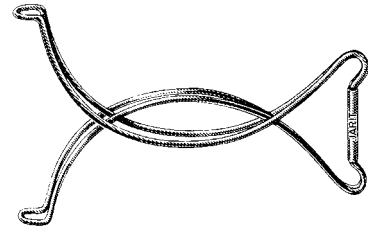

Delee Obstetrical Forceps

Catalog #	Description
510-200	12" (305mm)
510-205	14" (355mm)

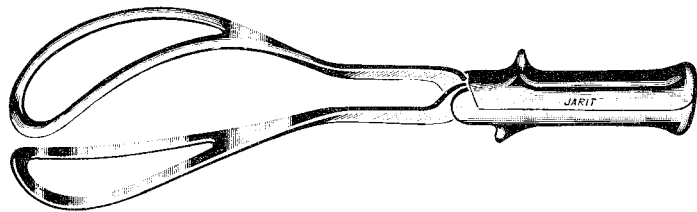

Simpson Obstetrical Forceps

Catalog #	Description
510-220	12¼" (313mm)

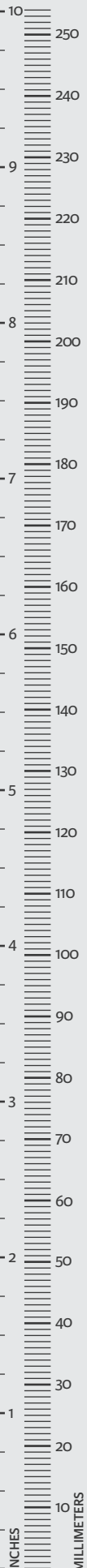
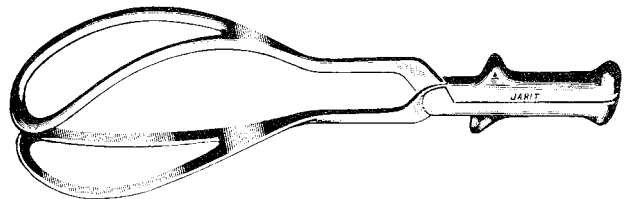

Simpson Obstetrical Forceps

Catalog #	Description
510-225	14¼" (365mm)

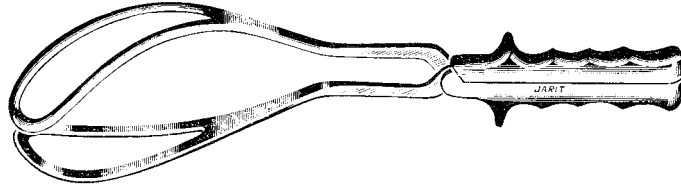

McLane-Tucker Obstetrical Forceps

Catalog #	Description
510-235	15¼" (390mm)

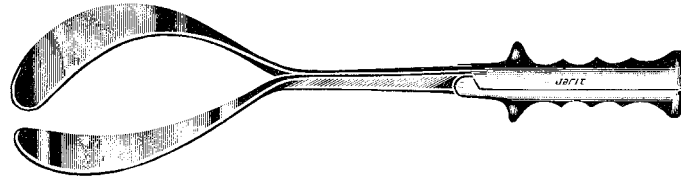

Elliott Obstetrical Forceps

Catalog #	Description
510-245	15½" (395mm)

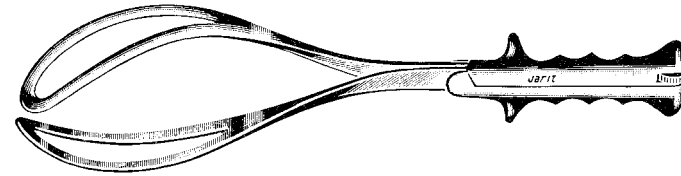

Kieland Obstetrical Forceps

Catalog #	Description
510-260	16" (405mm)

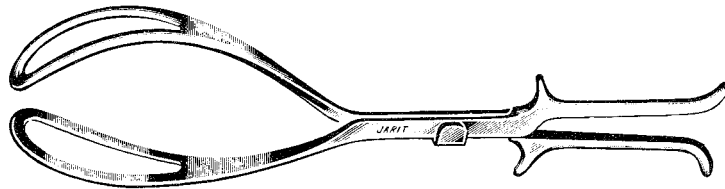

Luikhart Obstetrical Forceps

Catalog #	Description
510-265	16" (405mm)

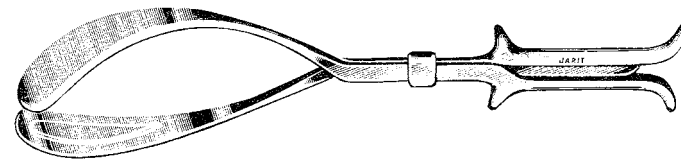

McLane-Tucker-Luikhart Obstetrical Forceps

Catalog #	Description
510-275	15¾" (400mm)

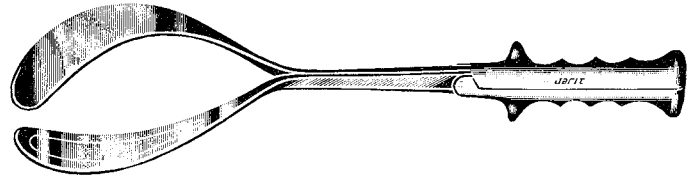

Simpson-Luikhart Obstetrical Forceps

Catalog #	Description
510-290	14¼" (360mm)

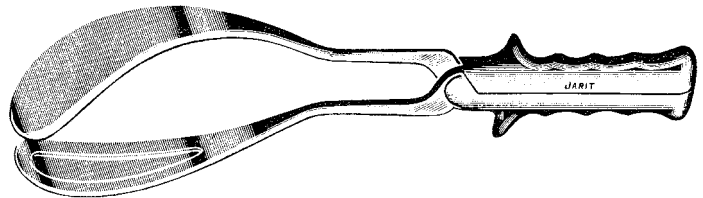

Piper Obstetrical Forceps

Catalog #	Description
510-300	18¼" (465mm)

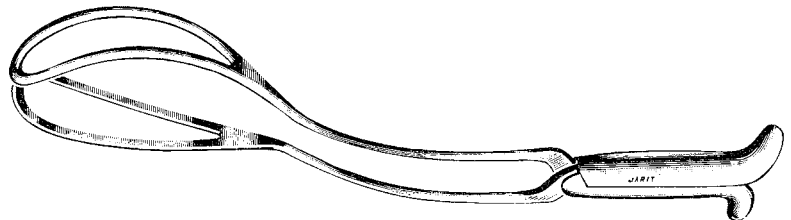

Bill Traction Handle

Catalog #	Description
510-330	For use with all O.B. Forceps having standad type handle

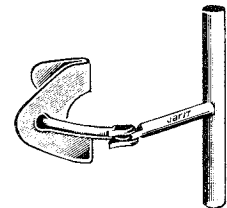

Integra™ Bariatric Instruments and General Surgical Instruments

Integra Jarit offers a comprehensive line of high quality surgical instruments for Bariatric Surgery. As the demand continues to grow for surgical instruments for both open and laparoscopic surgical approaches, Jarit includes instruments to support the techniques involved in these challenging surgical procedures.

For open surgery, 12" and 14" long instruments: full line of forceps, clamps, scissors, needle holders, and retractors.

Mayo Scissors, Carb-Edge

14 1/4" (361mm)

Catalog #	Description
101-230	Straight
101-232	Curved

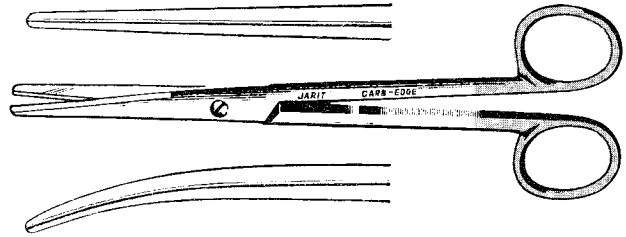

Metzenbaum Scissors, Carb-Edge

Catalog #	Description
101-272	12 1/4" (310mm), curved
101-256	14 1/4" (364mm), curved

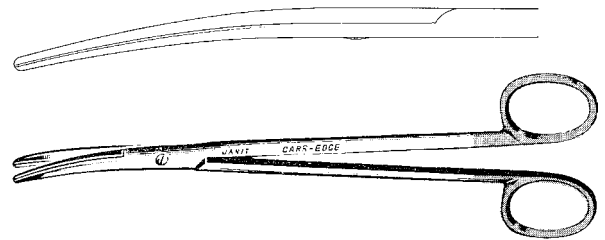

Metzenbaum Scissors, Supercut

Catalog #	Description
102-129	12" (302mm), curved
102-127	14" (356mm), curved

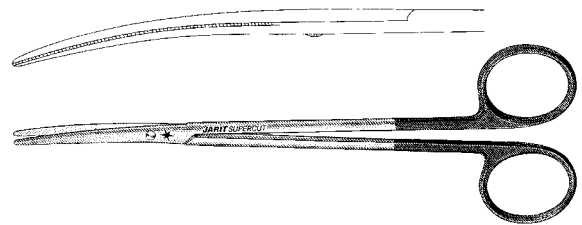

Pean Forceps

horizontal serrations

Catalog #	Description
135-262	11" (280mm), straight, jaw length 3 1/2" (89mm)
135-265	11" (280mm), curved, jaw length 3 1/2" (89mm)
135-263	12" (305mm), straight, jaw length 3 1/2" (89mm)
135-266	12" (305mm), curved, jaw length 3 1/2" (89mm)
135-264	14" (356mm), straight, jaw length 3 1/2" (89mm)
135-267	14" (356mm), curved, jaw length 3 1/2" (89mm)

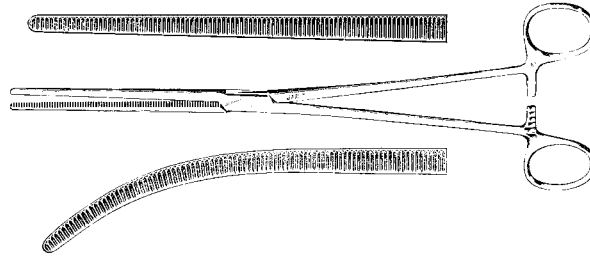

Rochester-Ochsner Forceps

Catalog #	Description
105-229	12" (305mm), straight
105-228	14" (356mm), straight

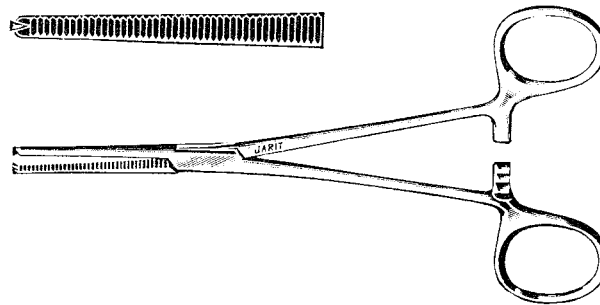

Foerster Sponge Forceps, (Matte Finish)

Manufactured from high grade German surgical stainless steel which is glass beaded to a matte finish

Catalog #	Description
114-124	14" (357mm), straight, serrated

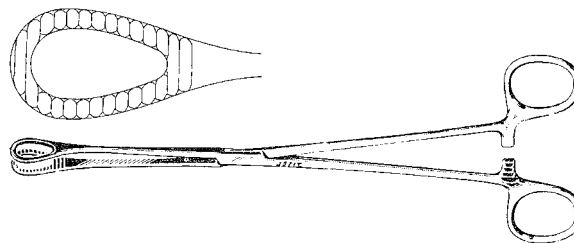

Dressing Forceps

serrated

Catalog #	Description
130-130	11 3/4" (300mm)
130-132	14" (355mm)



Tissue Forceps

1 x 2 teeth

Catalog #	Description
130-180	12" (303mm)
130-182	14" (355mm)



Russian Tissue Forceps

Catalog #	Description
130-194	12" (305mm)
130-196	14" (355mm)



Singly Tissue Forceps

Catalog #	Description
135-248	14" (356mm)



Babcock Tissue Forceps

Catalog #	Description
135-196	11¾" (300mm), jaw width 11.3mm
135-194	13¾" (350mm), jaw width 12mm

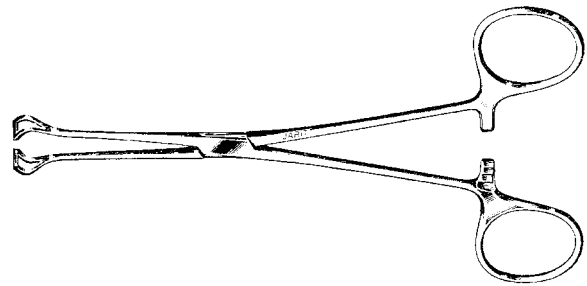

Gemini Artery Clamp

Catalog #	Description
140-335	14¼" (360mm)

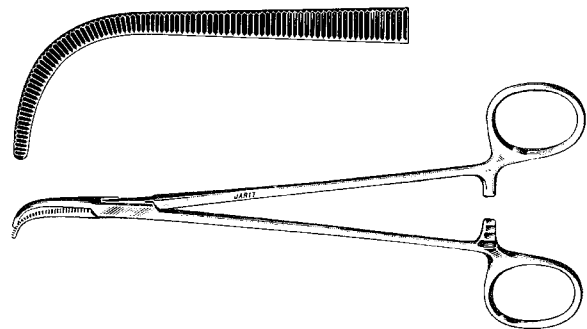

Allis-Willauer Tissue Forceps

5 x 6 teeth

Catalog #	Description
305-231	11" (282mm), 5.7mm jaw width
305-233	13¾" (350mm), 5.7mm jaw width

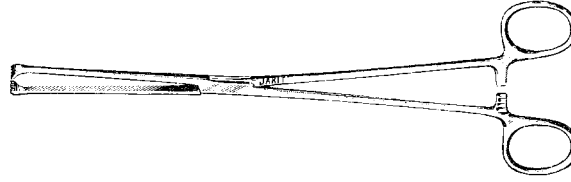

Sarot Artery Forceps

13¾" (350mm)

Catalog #	Description
305-366	3" (75mm) jaw length

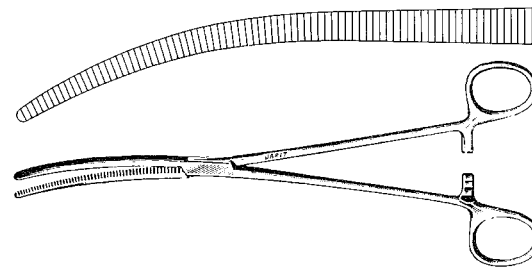

DeBakey-Collier Artery Forceps

14" (356mm)

Catalog #	Description
305-369	1¾" (44mm) jaw length

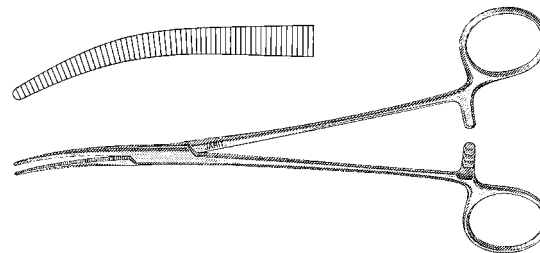

DeBakey Vascular Tissue Forceps, Cardio-Grip™

Straight, 2mm tips

Catalog #	Description
320-109	12" (300mm)
320-108	14" (360mm)

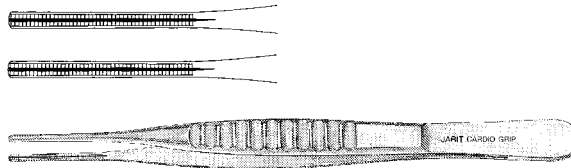

Harrington (Mixer) Forceps
right angled, light

Catalog #	Description
305-395	12 1/4" (311mm)
305-396	14 1/4" (360mm)

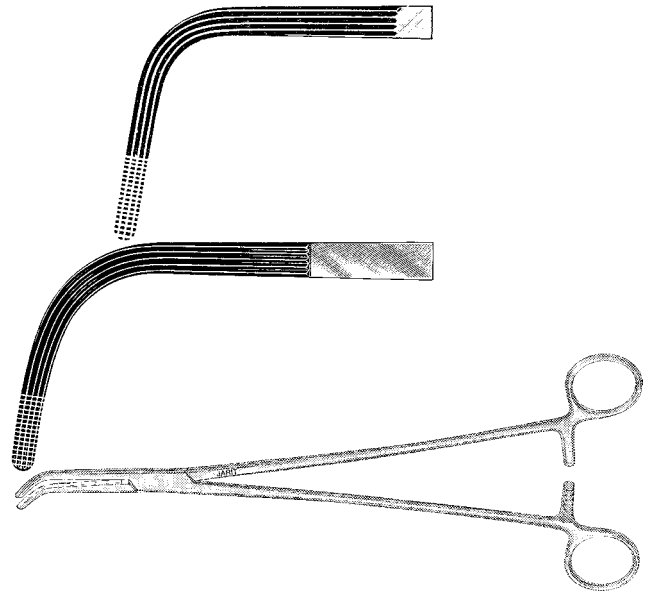

Rochester-Pean Forceps
12" (305mm)

Catalog #	Description
105-199	straight, 3 1/2" (90mm) jaw length

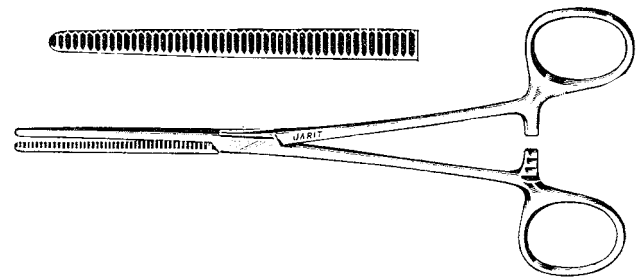

Rochester-Pean Forceps
curved, Longitudinal serrations

Catalog #	Description
305-398	11 3/4" (300mm), 3 7/8" (99mm) jaw length
305-399	14" (354mm), 4 3/8" (111mm) jaw length

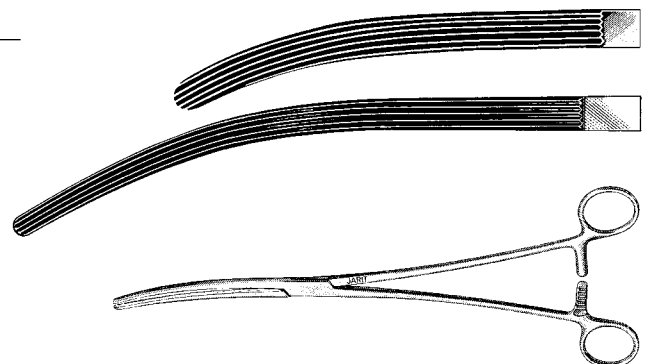

Crile-Wood Needle Holder, Carb-Bite

4000 teeth per square inch, for use with 4.0 and 5.0 suture

Catalog #	Description
121-129	12 1/4" (311mm), 18.5mm jaw length
121-128	14" (356mm), 19mm jaw length

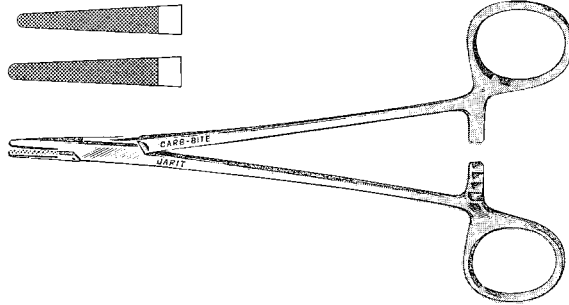

Mayo-Hegar Needle Holder, Carb-Bite

2500 teeth per square inch, for use with 2.0 and 3.0 suture

Catalog #	Description
121-147	11 3/4" (300mm), 19mm jaw length
121-144	13 3/4" (350mm), 19mm jaw length

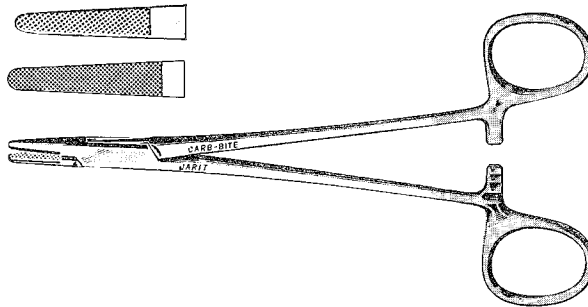

Heaney Needle Holder, Carb-Bite

2500 teeth per square inch, for use with 2.0 and 3.0 suture

Catalog #	Description
121-204	11 3/4" (300mm), 20mm jaw length

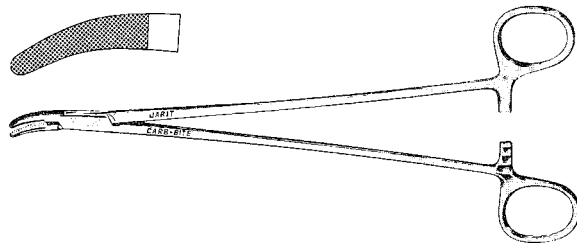

Poole Suction Tubes

straight, 32 French

Catalog #	Description
170-103	12" (305mm)
170-104	15" (378mm)
170-ITB-103	Replacement Inner Tube



Yankaur Suction Tube

Catalog #	Description
170-117	15" (378mm)

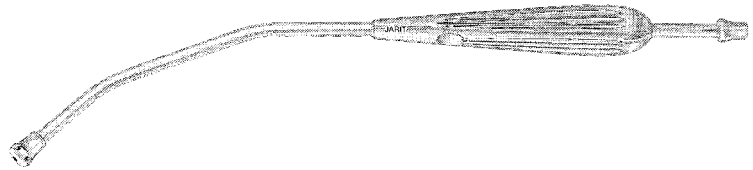

Cushing Vein Retractor

blade 3/8" x 3/8" (95mm x 95mm)

Catalog #	Description
200-136	11" (279mm)
200-137	14" (356mm)



Deaver Retractor

Catalog #	Description
200-204	1" x 14" (25mm x 356mm)

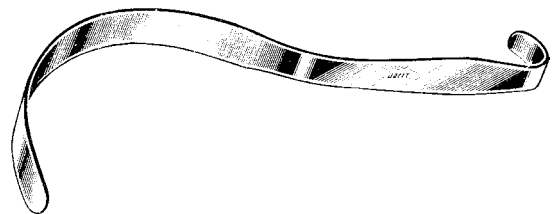

Deaver Retractor

Hollow Grip Handle

Catalog #	Description
201-203	2 1/2" x 14 1/2" (63mm x 368mm)

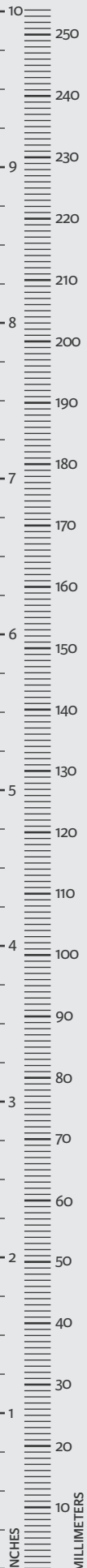
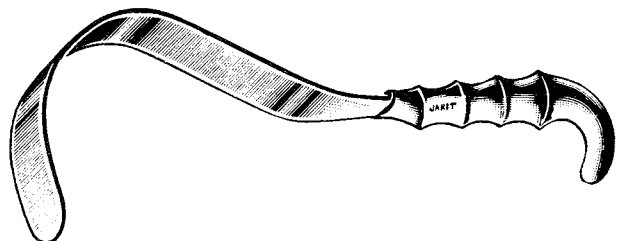

Integra[™] Containers, Trays and Accessories

Integra Sterilization Containers feature a broad range of sizes to support your instrument storage requirements.

One-Half Size Container with Lid

11 1/4" x 11" (286mm x 280mm)

Solid Bottom Container with Lid

Catalog #	Description
730-100	4" (102mm)
730-101	5 1/3" (136mm)
730-102	6" (152mm)
730-103	8" (203mm)



Perforated Bottom Container with Lid

Catalog #	Description
730-110	4" (102mm)
730-111	5 1/3" (136mm)
730-112	6" (152mm)
730-113	8" (203mm)

**Color Lids Available,
Lids and Bottoms Must Be Ordered Separately**

Color Lids Only for Half-Size Containers

Catalog #	Description
730-120	Silver
730-121	Blue
730-122	Red
730-123	Gold
730-124	Green
730-125	Black



Solid Bottom only Container without Lid

Catalog #	Description
730-100B	4" (102mm)
730-101B	5 1/3" (136mm)
730-102B	6" (152mm)
730-103B	8" (203mm)



Perforated Bottom only Container without Lid

Catalog #	Description
730-110B	4" (102mm)
730-111B	5 1/3" (136mm)
730-112B	6" (152mm)
730-113B	8" (203mm)

One-Half Size Wire/Perforated Baskets

10" x 9 1/2" (252mm x 242mm)

Wire Baskets

Catalog #	Description
740-100	2 3/8" (59mm)
740-101	3 1/8" (78mm)
740-102	4 1/4" (108mm)



Perforated Baskets

Catalog #	Description
750-100	2 3/8" (59mm)
750-101	3 1/8" (78mm)
750-102	4 1/4" (108mm)

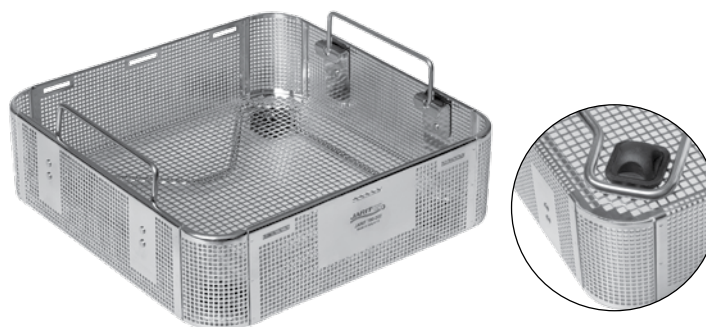

One-Half Size Container Lid Only—Silver

Catalog #	Description
730-120	One-half size



Three-Quarter Size Container with Lid

18 1/4" x 11" (465mm x 280mm)

Solid Bottom Container with Lid

Catalog #	Description
730-200	4" (102mm)
730-201	5 1/3" (136mm)
730-202	6" (152mm)



Perforated Bottom Container with Lid

Catalog #	Description
730-210	4" (102mm)
730-211	5 1/3" (136mm)
730-212	6" (152mm)

**Color Lids Available,
Lids and Bottoms Must Be Ordered Separately**

Color Lids Only for Three-Quarter Size Containers

Catalog #	Description
730-220	Silver
730-221	Blue
730-222	Red
730-223	Gold
730-224	Green
730-225	Black



Solid Bottom only Container without Lid

Catalog #	Description
730-200B	4" (102mm)
730-201B	5 1/3" (136mm)
730-202B	6" (152mm)



Perforated Bottom only Container without Lid

Catalog #	Description
730-210B	4" (102mm)
730-211B	5 1/3" (136mm)
730-212B	6" (152mm)

Three-Quarter Size Wire/Perforated Baskets

15 3/4" x 10" (402mm x 252mm)

Wire Baskets

Catalog #	Description
740-200	2 3/8" (59mm)
740-201	3 1/8" (78mm)
740-202	4 1/4" (108mm)



Perforated Baskets

Catalog #	Description
750-200	2 3/8" (59mm)
750-201	3 1/8" (78mm)
750-202	4 1/4" (108mm)

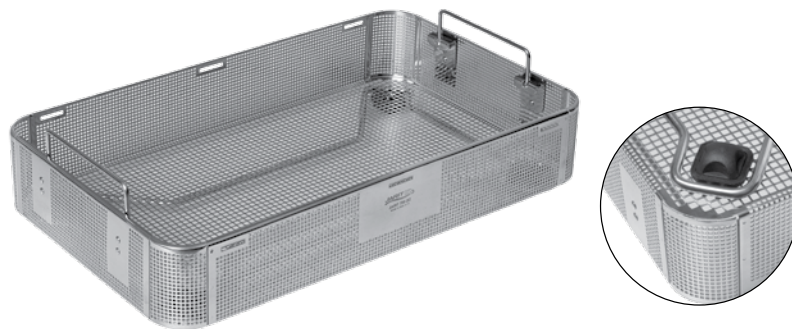

Three-Quarter Size Container Lid Only

Catalog #	Description
730-220	Three-quarter size



Full-Size Container with Lid—Silver

23" x 11" (585mm x 280mm)

Solid Bottom Container with Lid

Catalog #	Description
730-300	4" (102mm)
730-301	5 1/3" (136mm)
730-302	6" (152mm)
730-303	8" (203mm)



Perforated Bottom Container with Lid

Catalog #	Description
730-310	4" (102mm)
730-311	5 1/3" (136mm)
730-312	6" (152mm)
730-313	8" (203mm)

**Color Lids Available,
Lids and Bottoms Must Be Ordered Separately**

Color Lids Only for Three-Quarter Size Containers

Catalog #	Description
730-320	Silver
730-321	Blue
730-322	Red
730-323	Gold
730-324	Green
730-325	Black



Solid Bottom only Container without Lid

Catalog #	Description
730-300B	4" (102mm)
730-301B	5 1/3" (136mm)
730-302B	6" (152mm)
730-303B	8" (203mm)



Perforated Bottom only Container without Lid

Catalog #	Description
730-310B	4" (102mm)
730-311B	5 1/3" (136mm)
730-312B	6" (152mm)
730-313B	8" (203mm)

Full-Size Wire/Perforated Baskets

21 1/4" x 10" (538mm x 252mm)

Wire Baskets

Catalog #	Description
740-300	2 3/8" (59mm)
740-301	3 1/8" (78mm)
740-302	4 1/4" (108mm)



Perforated Baskets

Catalog #	Description
750-300	2" (50mm)
750-301	3" (76mm)
750-302	4" (102mm)



Full-Size Container Lid Only—Silver

Catalog #	Description
730-320	Full-size



Instrument Holding Rack

Catalog #	Description
790-010	Instrument rack

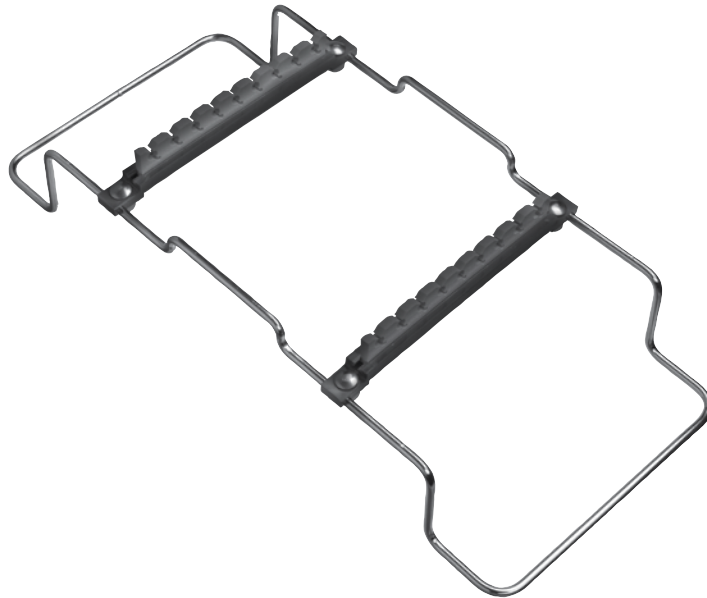

Sterilization Filters

Catalog #	Description
775-200	Single use, round 7½", box of 1,000



Sterile Indicator Cards

Catalog #	Description
775-300	Indicates for use in gas or steam, box of 250

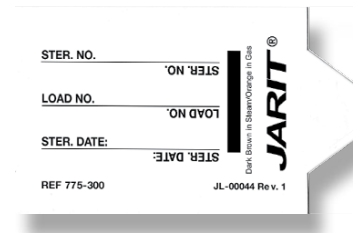

Tamper Evident Locks

Catalog #	Description
775-400	Blue, box of 1,000

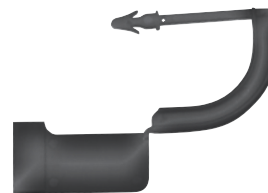

Container Lids Only

Catalog #	Description
730-120	One-half size
730-220	Three-quarter size
730-320	Full-size



Identification Tags

Catalog #	Description
775-100	ID Tag, silver
775-101	ID Tag, blue
775-102	ID Tag, red
775-103	ID Tag, gold
775-104	ID Tag, green
775-105	ID Tag, black



Contents/Delivery Address—custom laser etching available with order.
Each tag allows up to 14 characters.

Small Snap-On Basket Tags (with Key Ring)

Two Sizes Available, 2³/₈" x 1/2" or 2³/₈" x 1¹/₈"

Catalog #	Description
775-120	Silver
775-121	Blue
775-122	Red
775-123	Gold
775-124	Green
775-125	Black



Large Snap-On Basket Tags (with Key Ring)

2³/₈" x 1¹/₄"

Catalog #	Description
775-130	Silver
775-131	Blue
775-132	Red
775-133	Gold
775-134	Green
775-135	Black

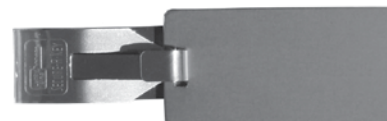

Instrument Trays

Catalog #	Description
117-100	5" x 15½" x 3" (127mm x 394mm x 76mm)
117-102	6" x 24" x 3½" (152mm x 610mm x 89mm)
117-106	8" x 25¼" x 3½" (203mm x 642mm x 89mm)
117-108	10" x 6½" x 2½" (254mm x 165mm x 64mm)
117-110	10½" x 10" x 3½" (267mm x 254mm x 89mm)
117-112	10½" x 15" x 3½" (267mm x 394mm x 89mm)
117-114	10½" x 20" x 3½" (267mm x 508mm x 89mm)
117-116	13" x 20¼" x 3½" (330mm x 514mm x 89mm)
117-118	13" x 20¼" x 3½" (330mm x 514mm x 89mm)



Lifting Handles

Catalog #	Description
117-120	For lifting and carrying instrument trays, set of 2

(Not Pictured)

Covered Instrument Trays

with positive locking latch,
removable cover can be stored under tray during use

Catalog #	Description
117-130	5" x 15½" x 3" (127mm x 394mm x 76mm)
117-132	6" x 24" x 3½" (152mm x 610mm x 89mm)
117-136	8" x 25¼" x 3½" (203mm x 641mm x 89mm)
117-138	10" x 6½" x 2½" (254mm x 165mm x 64mm)
117-140	10½" x 10" x 3½" (267mm x 254mm x 89mm)
117-142	10½" x 15" x 3½" (267mm x 394mm x 89mm)
117-144	10½" x 20" x 3½" (267mm x 508mm x 89mm)
117-148	13" x 20¼" x 3½" (330mm x 514mm x 89mm)



Mayo Trays, Perforated

Catalog #	Description
117-160	10" x 6½" x ¾" (254mm x 165mm x 19mm)
117-162	13½" x 9¾" x ¾" (343mm x 248mm x 19mm)
117-164	15" x 10⅝" x ¾" (384mm x 270mm x 19mm)
117-166	17" x 11⅝" x ¾" (432mm x 295mm x 19mm)
117-168	19" x 12⅝" x ¾" (486mm x 321mm x 19mm)
117-170	21¼" x 16¼" x ¾" (540mm x 413mm x 22mm)



Flash Autoclaving Pans, Tray and Safety Handle

Catalog #	Description
117-180	Pan, 9" x 5" x 2" (225mm x 127mm x 50mm)
117-182	Pan, 10" x 6½" x 2½" (254mm x 165mm x 50mm)
117-184	Tray, 10" x 6½" x 2½" (254mm x 165mm x 63mm)
117-188	Safety handle

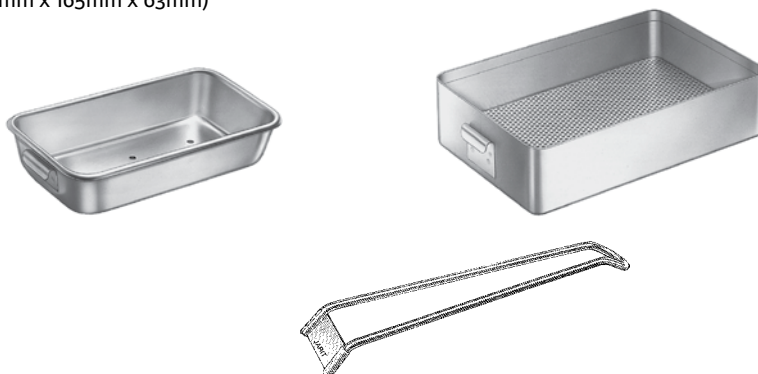

Deep Perforated Instrument Pans

Catalog #	Description
117-190	9" x 5" x 2" (229mm x 129mm x 51mm)
117-192	10" x 6½" x 2" (255mm x 165mm x 51mm)
117-194	12½" x 7¾" x 2½" (310mm x 199mm x 56mm)
117-196	12¾" x 10½" x 2½" (321mm x 262mm x 64mm)
117-198	16" x 10" x 2½" (420mm x 255mm x 64mm)
117-199	20¾" x 12¾" x 2½" (531mm x 326mm x 64mm)



Weinstein Instrument Holders

2¾" (71mm) wide

Catalog #	Description
117-240	6" (152mm)
117-242	8" (203mm)
117-244	10" (254mm)
117-246	12" (305mm)
117-247	14" (356mm)
117-248	16" (406mm)
117-249	18" (457mm)

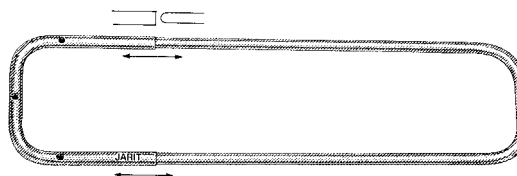

Posilock Instrument Holders

2¾" (71mm) wide

Catalog #	Description
117-250	6" (152mm)
117-252	8" (203mm)
117-254	10" (254mm)
117-256	12" (305mm)
117-258	14" (356mm)
117-260	16" (406mm)
117-262	18" (457mm)

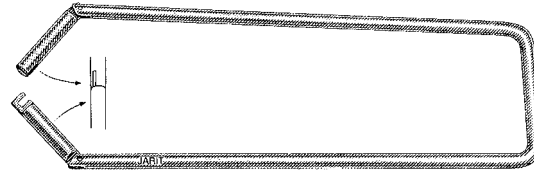

Instrument Stringers

2¾" (71mm) wide

Catalog #	Description
117-270	8" (203mm)
117-272	10" (254mm)
117-274	12" (305mm)
117-276	14" (356mm)
117-278	16" (406mm)
117-280	18" (457mm)



Instrument Holding Racks

Catalog #	Description
117-330	with four vertical pins, keeps box locks open during sterilization
117-340	Tray Pins, box of 10

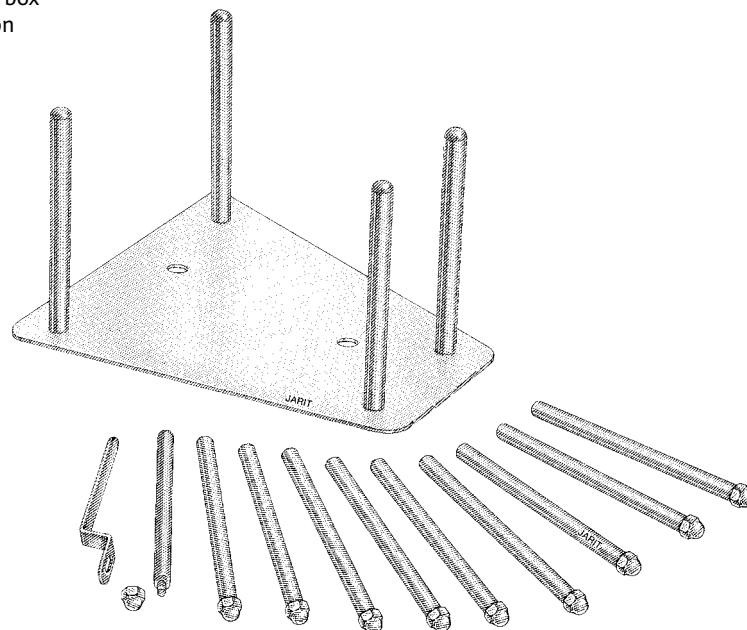

Bunt Forceps Holder

Catalog #	Description
118-116	4 1/4" (108mm)

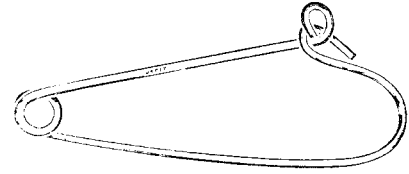

Weisenbach Forcep Holder

Catalog #	Description
118-118	6 1/4" (158mm)
118-119	12 1/4" (310mm)

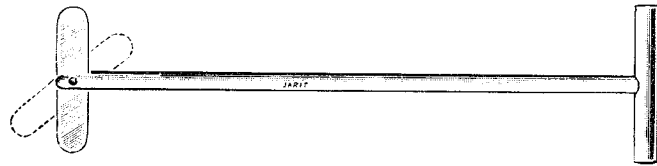

Graduated Measure

Catalog #	Description
117-370	4 ³ / ₄ " x 5 ¹ / ₄ " (121mm x 133mm), 32 oz (1000cc)



Solutions Basin

Catalog #	Description
117-380	13 ⁵ / ₈ " x 4 ⁵ / ₈ " (346mm x 117mm), 7 qt
117-381	14 ¹ / ₂ " x 5" (368mm x 127mm), 9 ¹ / ₂ qt



Iodine Cup

Catalog #	Description
117-360	3 ³ / ₈ " x 2" (86mm x 51mm), 6 oz



Medicine Cup

Catalog #	Description
117-365	2 ¹ / ₈ " x 2" (54mm x 51mm), 2 oz, graduated



Emesis Basin

Catalog #	Description
117-390	6 ⁵ / ₈ " x 3 ¹ / ₂ " x 1 ¹ / ₂ " (168mm x 89mm x 38mm)
117-391	8 ¹ / ₈ " x 3 ⁵ / ₈ " x 1 ⁵ / ₈ " (206mm x 92mm x 41mm)
117-392	9 ⁷ / ₈ " x 4 ¹ / ₂ " x 2 ¹ / ₈ " (251mm x 114mm x 54mm)



Lambotte Rack

Catalog #	Description
250-090	Stainless steel, holds 12 Jarit Lambotte 9" osteotomes, rack size: 3" x 7 ³ / ₈ " x 11 ¹ / ₈ " (76mm x 187mm x 283mm)

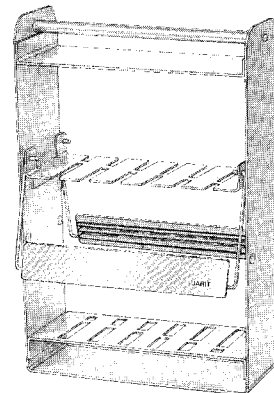

Hibbs-Bruns Curette Rack

Catalog #	Description
250-092	Stainless steel, holds 12 Jarit 6 ³ / ₄ ", 8" and 9" Bruns, curettes, rack size: 2 ¹ / ₂ " x 7 ³ / ₈ " x 11 ¹ / ₈ " (64mm x 187mm x 283mm)

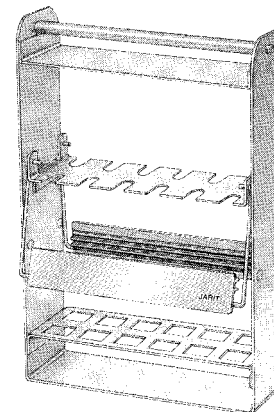

Hibbs-Bruns Curette Rack

Catalog #	Description
250-084	Stainless steel, holds 12 Jarit Bruns 6 ³ / ₄ ", 8" and 9" Bruns, curettes, rack size: 2 ¹ / ₂ " x 9" x 12 ¹ / ₂ " (64mm x 231mm x 305mm)

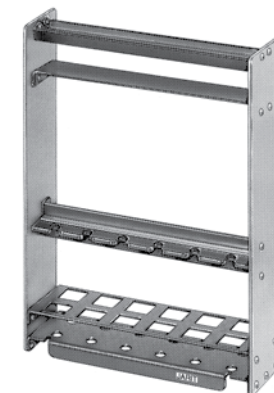

Bruns Curette Rack

Catalog #	Description
250-093	Stainless steel, holds 12 Jarit Bruns 6 ³ / ₄ " curettes, rack size: 2 ¹ / ₂ " x 7 ³ / ₈ " x 9 ¹ / ₄ " (64mm x 187mm x 235mm)

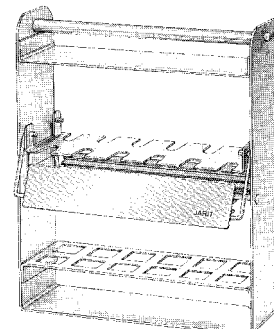

Smith-Petersen Osteotome Rack

Catalog #	Description
250-095	Stainless steel, holds 7 Jarit Smith-Petersen 8" gouges, osteotomes, rack size: 2" x 10 ⁵ / ₈ " x 9 ⁷ / ₈ " (51mm x 270mm x 251mm)

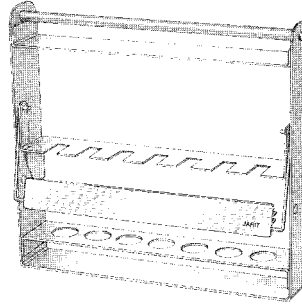

Cobb Type Instrument Rack

Catalog #	Description
250-097	Stainless steel, holds 9 Jarit Cobb-Type 11" instruments, rack size: 1 ³ / ₄ " x 14" x 13 ¹ / ₄ " (44mm x 356mm x 337mm)

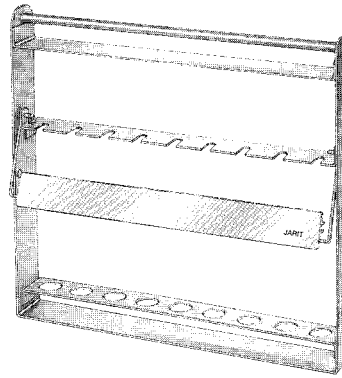

Hoke Osteotome Rack

Catalog #	Description
250-099	Stainless steel, holds 6 Jarit Hoke 5" osteotomes, rack size: 1 ¹ / ₂ " x 5 ³ / ₄ " x 7" (38mm x 146mm x 178mm)

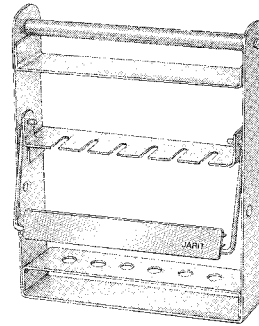

Lambotte Mini Osteotome Rack (Metal)

Catalog #	Description
250-380	Holds up to 9 assorted mini osteotomes 2mm x 20mm, 5 ¹ / ₂ " x 6 ¹ / ₂ " x 1 ¹ / ₂ " (140mm x 165mm x 13mm)



Rhoton-Type Instrument Rack

10" x 8" (253mm x 201mm)

Catalog #	Description
277-275	For storing 15 stainless steel or titanium instruments

Catalog #	Description
277-275TI	10" x 8 3/4" x 1" (253mm x 223mm x 25mm), for storing 19 stainless steel or titanium instruments

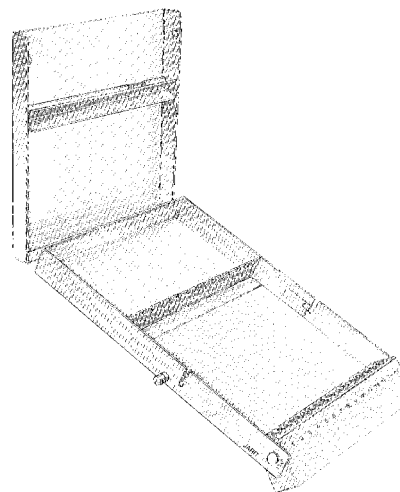

Instrument Rack (Craig Biopsy)

Catalog #	Description
280-559	1 Instrument Rack

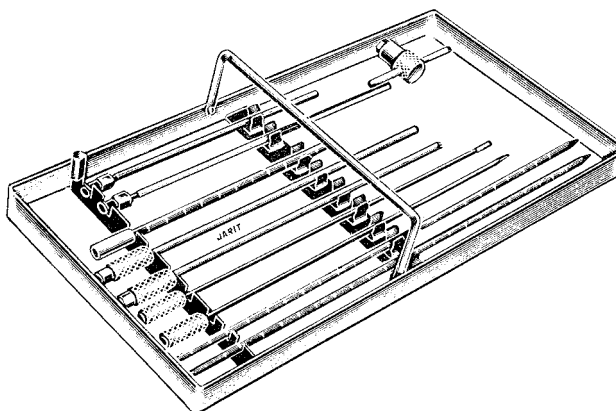

Instrument Holding Rack

9 slot, 5-10mm diameter silicone bars

Catalog #	Description
790-010	Fits into a full size 8" container and a 2" or 3" basket, 10" x 19 3/4" x 4 3/8" (220mm x 500mm x 110mm)

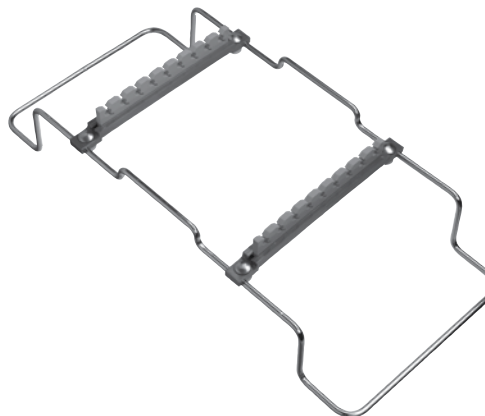

Nabatoff Vein Stripper (Case Only)

Catalog #	Description
160-CAS-120	Stainless Steel Case for Nabatoff Stripper



Diethrich Coronary Artery Bypass Case Only

Catalog #	Description
310-381	1ea Instrument Case

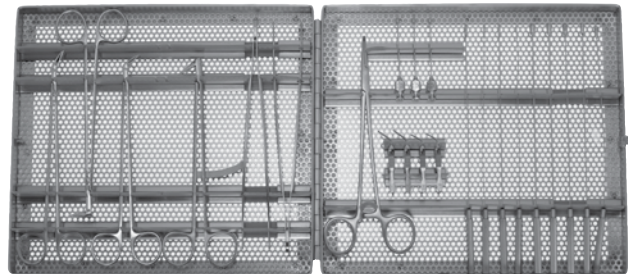

Garrett Dilator Case

Catalog #	Description
310-405	9" x 5 1/8" x 3/4" (230mm x 130mm x 20mm)

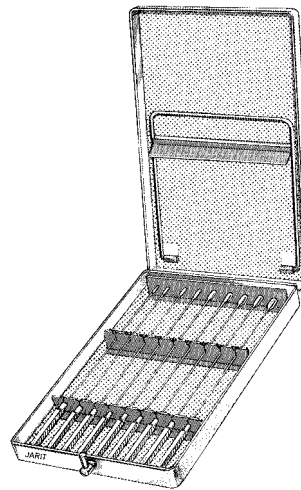

DeBakey Dilator Case

Catalog #	Description
310-465	9 1/4" x 5 3/4" x 1/2" (232mm x 146mm x 13mm)



Eye and Plastic Surgery Cases

for eye, plastic surgery, and microsurgical instruments, scissors, knives, and forceps, etc., are held securely on bed of silicone rubber, cover is removable.

Catalog #	Description
360-502	10 1/2" x 10" (267mm x 254mm)
360-504	10 1/2" x 15" (267mm x 381mm)

Eye and Plastic Surgery Cases

same as shown above, but stainless steel mesh is coated with autoclavable plastic for better protection of microsurgical instruments

Catalog #	Description
360-512	10 1/2" x 10" (267mm x 254mm)
360-514	10 1/2" x 15" (267mm x 381mm)



Laparoscopic Instrument Case

Catalog #	Description
600-618	22¾" x 11" x 8" (579mm x 282mm x 203mm)

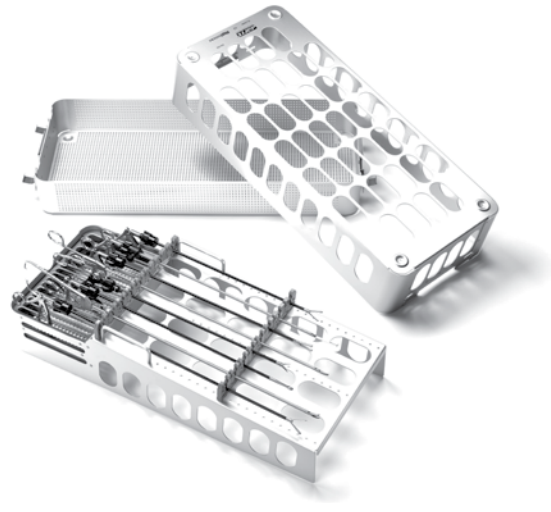

Bariatric Instrument Case

Catalog #	Description
600-620	26¾" x 11" x 8" (681mm x 282mm x 203mm)

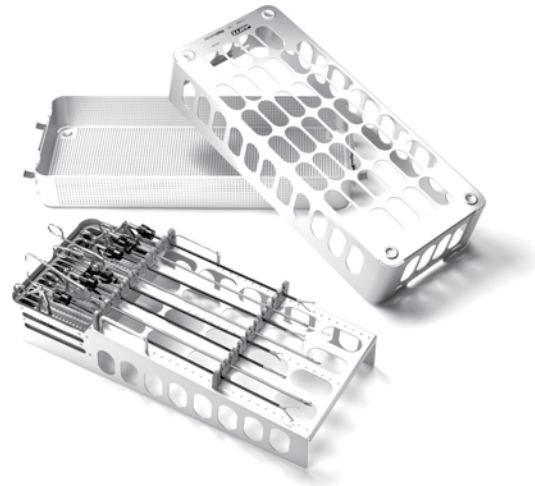

Garrett Dilator Holders

Catalog #	Description
310-406	7¾" (200mm)
310-407	5½" (140mm)



Tray for Sinuscope

Catalog #	Description
440-510	6" x 15 ¹ / ₄ " x 3 ¹ / ₂ " (152mm x 390mm x 90mm), holds two sinuscope

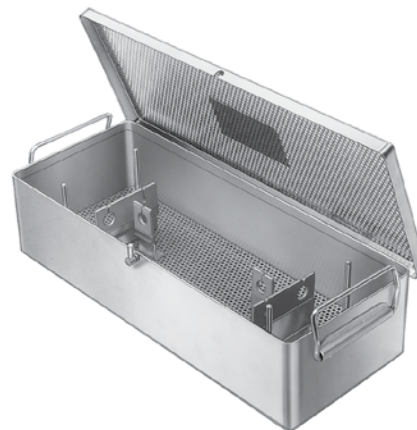

Instrument Tip-It™ Protectors

Catalog #	Description
760-400	Tip-It Protectors size 1 white vent, 1/16" x 3/4" (1.6mm x 19mm), 50/pkg
760-405	Tip-It Protectors size 2 blue vent, 5/64" x 3/4" (2mm x 19mm), 50/pkg
760-410	Tip-It Protectors size 3 green vent, 7/64" x 3/4" (2.8mm x 19mm), 50/pkg
760-415	Tip-It Protectors size 4 red vent, 1/8" x 1" (3.2mm x 25.4mm), 50/pkg
760-420	Tip-It Protectors size 5 yellow vent, 3/16" x 1" (4.8mm x 25.4mm) 50/pkg
760-425	Tip-It Protectors size 6 maroon vent, 13/32" x 3/4" (10.3mm x 19mm) 50/pkg
760-430	Tip-It Protectors size 7 orange vent, 1/16" x 3/8" x 1" (1.6mm x 9.5mm x 25.4mm) 50/pkg
760-435	Tip-It Protectors size 8 brown vent, 5/64" x 5/8" x 1" (2mm x 16mm x 25.4mm) 50/pkg
760-440	Tip-It Protectors size 9 black vent, 1/8" x 1" x 1" (3.2mm x 25.4mm x 25.4mm) 50/pkg
760-445	Tip-It Protectors assorted vent, 9ea color plus 5 extra, 50/pkg

Instrument Tip-It™ Protectors

Catalog #	Description
760-450	Tip-It Protectors size 1 white, 1/16" x 3/4" (1.6mm x 19mm), 50/pkg
760-455	Tip-It Protectors size 2 blue, 5/64" x 3/4" (2mm x 19mm), 50/pkg
760-460	Tip-It Protectors size 3 green, 7/64" x 3/4" (2.8mm x 19mm), 50/pkg
760-465	Tip-It Protectors size 4 red, 1/8" x 1" (3.2mm x 25.4mm), 50/pkg
760-470	Tip-It Protectors size 5 yellow 3/16" x 1" (4.8mm x 25.4mm) 50/pkg
760-475	Tip-It Protectors size 6 maroon, 13/32" x 3/4" (10.3mm x 19mm) 50/pkg
760-480	Tip-It Protectors size 7 orange, 1/16" x 3/8" x 1" (1.6mm x 9.5mm x 25.4mm) 50/pkg
760-485	Tip-It Protectors size 8 brown, 5/64" x 5/8" x 1" (2mm x 16mm x 25.4mm) 50/pkg
760-490	Tip-It Protectors size 9 black, 1/8" x 1" x 1" (3.2mm x 25.4mm x 25.4mm) 50/pkg
760-495	Tip-It Protectors assorted vent, 9ea color plus 5 extra, 50/pkg



Integra™ Suture Guide & Conversion Tables



Product	Suture Size		0	2-0	3-0	4-0	5-0	6-0	7-0	8-0	9-0	10-0
	Insert	Teeth Per Square Inch Tip Width										
121-097	TC	4000				•	•					
121-100	TC	4000				•	•	•				
121-105	TC	4000		•	•	•						
121-106	TC	2500		•	•	•						
121-115	TC	7000						•	•	•		
121-116	TC	Smooth						•	•	•		
121-118	TC	Smooth					•	•				
121-119	TC	3600					•	•				
121-120	TC	Smooth				•	•					
121-121	TC	4000				•	•					
121-125	TC	4000		•	•	•						
121-126	TC	4000				•	•	•				
121-127	TC	4000				•	•	•				
121-128	TC	4000				•	•					
121-129	TC	4000				•	•					
121-130	TC	4000				•	•	•				
121-131	TC	4000				•	•	•				
121-132	TC	4000				•	•	•				
121-133	TC	4000				•	•	•				
121-134	TC	4000				•	•	•				
121-135	TC	2500		•	•	•						
121-140	TC	2500		•	•	•						
121-142	TC	2500		•	•	•						
121-143	TC	2500		•	•	•						
121-144	TC	2500		•	•	•						
121-145	TC	2500		•	•	•						
121-146	TC	2500		•	•	•						
121-147	TC	2500		•	•	•						
121-148	TC	7000						•	•			
121-149	TC	Smooth						•	•			
121-150	TC	4000				•	•	•				
121-155	TC	4000				•	•	•				
121-160	TC	4000	1.65mm			•	•	•				
121-161	TC	4000	1.65mm			•	•	•				
121-161TI	TC											
121-162	TC	4000	1.65mm			•	•	•				
121-162TI	TC											
121-163	TC	4000	1.65mm			•	•	•				
121-163TI	TC											
121-164	TC	4000	1.65mm			•	•	•				
121-165	TC	4000	1.65mm			•	•	•				
121-166	TC	4000	1.65mm			•	•	•				
121-170	TC	7000	1mm				•	•	•			
121-171	TC	Smooth	1mm				•	•	•			
121-172	TC	7000	1mm				•	•	•			
121-173	TC	Smooth	1mm				•	•	•			

Product	Suture Size		Teeth Per Square Inch Tip Width									
	Insert	Teeth Per Square Inch	0	2-0	3-0	4-0	5-0	6-0	7-0	8-0	9-0	10-0
121-174	TC	7000	1mm					•	•	•		
121-175	TC	Smooth	1mm					•	•	•		
121-176	TC	7000	1mm					•	•	•		
121-177	TC	7000	1mm					•	•	•		
121-178	TC	Smooth	1mm					•	•	•		
121-179	TC	Smooth	1mm					•	•	•		
121-180	TC	2500		•	•	•						
121-181	TC	7000							•	•		
121-182	TC	7000							•	•		
121-183	TC	7000							•	•		
121-184	TC	7000						•	•	•		
121-185	TC	7000						•	•	•		
121-186	TC	7000						•	•	•		
121-187	TC	7000						•	•	•		
121-188	TC	7000						•	•	•		
121-189	TC	7000						•	•	•		
121-192	TC	2500		•	•	•						
121-193	TC	4000				•	•	•				
121-195	TC	2500		•	•	•						
121-196	TC	2500			•	•	•					
121-197	TC	4000					•	•				
121-198	TC	4000					•	•				
121-200	TC	2500				•	•	•				
121-205	TC	2500				•	•	•				
121-206	TC	4000				•	•	•				
121-207	TC	4000				•	•	•				
121-209	TC	2500		•	•							
121-210	TC	2500		•	•	•						
121-211	TC	4000				•	•	•				
121-212	TC	4000				•	•	•				
121-213	TC	4000				•	•	•				
121-214	TC	4000				•	•	•				
121-215	TC	4000				•	•	•				
121-216	TC	4000	2mm	•	•	•						
121-217	TC	4000	2mm	•	•	•						
121-218	TC	4000	2mm	•	•	•						
121-219	TC	4000	2mm	•	•	•						
121-220	TC	2500		•	•							
121-228	TC	Smooth	1.3mm					•	•			
121-228NL	TC	Smooth	1.3mm					•	•			
121-229	TC	7000	1.3mm					•	•			
121-229NL	TC	7000	1.3mm					•	•			
121-230	TC	Smooth	1.5mm			•	•	•				
121-230NL	TC	Smooth	1.5mm			•	•	•				
121-231	TC	7000	1.5mm			•	•	•				
121-231NL	TC	7000	1.5mm			•	•	•				



Product	Suture Size Insert	Teeth Per Square Inch	Tip Width	0	2-0	3-0	4-0	5-0	6-0	7-0	8-0	9-0	10-0
121-250	TC			•	•								
121-255	TC			•	•								
121-257	TC			•	•								
121-258	TC			•	•								
121-260	TC			•	•								
121-265	TC			•	•								
121-270	TC	4000	2mm		•	•	•						
121-271	TC	4000	2mm		•	•	•						
121-272	TC	4000	2mm		•	•	•						
121-273	TC	4000	2mm		•	•	•						
121-274	TC	4000	2mm		•	•	•						
124-100TI	Stardust					•	•	•					
124-101TI	Stardust					•	•	•					
124-102TI	Stardust					•	•	•					
124-105TI	Stardust		1mm					•	•	•			
124-106TI	Stardust		1mm					•	•	•			
124-108TI	Stardust		1.65mm					•	•				
124-109TI	Stardust		1.65mm					•	•				
124-110TI	Stardust		1.65mm					•	•				
277-070	Smooth		1mm					•	•	•			
277-071	Smooth		1mm					•	•	•			
277-072	Smooth		1mm					•	•	•			
277-073	Smooth		1mm					•	•	•			
277-075	Smooth		.5mm								•	•	
277-076	Smooth		.5mm								•	•	
277-090	Smooth		.7mm							•	•		
277-091	Smooth		.7mm							•	•		
277-092	Smooth		.9mm						•	•			
277-093	Smooth		.9mm						•	•			
277-094	Smooth		.7mm							•	•		
277-095	Smooth		.7mm							•	•		
277-096	Smooth		.9mm						•	•			
277-097	Smooth		.9mm						•	•			
277-140	Smooth		.8mm							•	•		
277-141	Smooth		.8mm							•	•		
277-400	Stardust		1.2mm					•	•				
277-401	Stardust		1.2mm					•	•				
277-402	Stardust		1.2mm					•	•				
277-403	Stardust		1.2mm					•	•				
277-404	Stardust		1.2mm					•	•				
277-405	Stardust		1.2mm					•	•	•			
277-406	Stardust		1.2mm					•	•				
277-407	Stardust		1.2mm					•	•				
277-408	Stardust		1.2mm					•	•	•			
277-409	Stardust		1.2mm					•	•				
277-410	Stardust		1.2mm					•	•				

Product	Suture Size		0	2-0	3-0	4-0	5-0	6-0	7-0	8-0	9-0	10-0
	Insert	Teeth Per Square Inch Tip Width										
277-411	Stardust	1.2mm					•	•				
277-412	Stardust	1.2mm					•	•	•			
277-413	Stardust	1.2mm					•	•				
277-414	Stardust	1.2mm					•	•				
277-415	Stardust	1.2mm					•	•				
278-040	Stardust	1.3mm					•	•				
278-050	Stardust	1.3mm					•	•				
278-060	Stardust	1.2mm					•	•				
278-061	Stardust	1.2mm					•	•				
278-062	Stardust	1.2mm					•	•				
278-063	Stardust	1.2mm					•	•				
278-069TI	Stardust	.8mm					•	•				
279-069TI	Stardust	1.3mm					•	•				
278-070TI	Stardust	1.3mm					•	•				
278-071TI	Stardust	1.3mm					•	•				
278-072TI	Stardust	1.3mm					•	•				
278-077TI	Stardust	1.3mm					•	•				
278-078TI	Stardust	1.3mm					•	•				
278-079TI	Stardust	1.3mm					•	•				
278-080TI	Stardust	1mm					•	•	•			
278-082TI	Stardust	1mm					•	•	•			
278-092	Stardust	1.3mm					•	•				
278-093	Stardust	1.3mm					•	•				
278-093TI	Stardust	.8mm					•	•	•	•		
278-093TI	Stardust	1.3mm					•	•				
278-094	Stardust	1.3mm					•	•				
278-095	Stardust	1.3mm					•	•				
278-095TI	Stardust	.8mm					•	•	•	•		
278-095TI	Stardust	1.3mm					•	•				
278-096	Stardust	1.3mm					•	•				
278-097	Stardust	1.3mm					•	•				
278-097TI	Stardust	.8mm					•	•	•	•		
278-100	Stardust	1.3mm					•	•				
278-101	Stardust	1.3mm					•	•				
278-102	Stardust	1.3mm					•	•				
278-103	Stardust	1.3mm					•	•				
278-104	Stardust	1.3mm					•	•				
278-105	Stardust	1.3mm					•	•				
278-108TI	Stardust	.8mm					•	•	•	•		
278-110	Stardust	1mm					•	•	•	•		
278-111	Stardust	1mm					•	•	•	•		
278-111TI	Stardust	.8mm					•	•	•	•		
278-112	Stardust	1mm					•	•	•	•		
278-113	Stardust	1mm					•	•	•	•		
278-113TI	Stardust	.8mm					•	•	•	•		
278-114	Stardust	1mm					•	•	•	•		



Product	Suture Size		0	2-0	3-0	4-0	5-0	6-0	7-0	8-0	9-0	10-0
	Insert	Teeth Per Square Inch Tip Width										
278-115	Stardust	1mm						•	•			
278-116	Stardust	1mm						•	•			
278-117	Stardust	1mm						•	•			
278-118	Stardust	1mm						•	•			
278-119	Stardust	1mm						•	•			
278-120	Stardust	1mm						•	•			
278-121	Stardust	1mm						•	•			
278-125	Stardust	2mm		•	•	•						
278-125NL	Stardust	2mm		•	•	•						
278-126	Stardust	2mm		•	•	•						
278-126NL	Stardust	2mm		•	•	•						
278-130	Stardust	2mm		•	•	•						
278-130NL	Stardust	2mm		•	•	•						
278-131	Stardust	2mm		•	•	•						
278-131NL	Stardust	2mm		•	•	•						
278-132	Stardust	2mm		•	•	•						
278-132NL	Stardust	2mm		•	•	•						
278-133	Stardust	2mm		•	•	•						
278-133NL	Stardust	2mm		•	•	•						
278-134	Stardust	2mm		•	•	•						
278-134NL	Stardust	2mm		•	•	•						
278-135	Stardust	2mm		•	•	•						
278-135NL	Stardust	2mm		•	•	•						
278-140TI	Stardust	.8mm							•	•		
278-141TI	Stardust	.8mm							•	•		
278-142TI	Stardust	.8mm							•	•		
278-143TI	Stardust	.8mm							•	•		
278-144TI	Stardust	1.3mm					•	•				
278-145TI	Stardust	1.3mm					•	•				
278-146TI	Stardust	1.3mm					•	•				
278-147TI	Stardust	1.3mm					•	•				
278-171TI	Stardust	2mm		•	•	•						
278-172TI	Stardust	2mm		•	•	•						
278-173TI	Stardust	2mm		•	•	•						
278-174TI	Stardust	2mm		•	•	•						
278-180	Stardust	1.3mm					•	•				
278-181	Stardust	1.3mm					•	•				
278-182	Stardust	1.3mm					•	•				
278-183	Stardust	1.3mm					•	•				
278-184	Stardust	1.3mm					•	•				
278-185	Stardust	1.3mm					•	•				
278-186	Stardust	1.3mm					•	•				
278-220	Stardust	.7mm							•	•	•	
278-221	Stardust	.7mm							•	•	•	
278-222	Stardust	.7mm							•	•	•	
278-223	Stardust	.7mm							•	•	•	

Product	Suture Size		0	2-0	3-0	4-0	5-0	6-0	7-0	8-0	9-0	10-0
	Insert	Teeth Per Square Inch Tip Width										
355-404		Smooth					•	•				
355-404NL		Smooth					•	•				
355-405		Smooth					•	•				
355-405NL		Smooth					•	•				
355-406		Smooth						•	•	•		
355-406NL		Smooth						•	•	•		
355-407		Smooth						•	•	•		
355-407NL		Smooth						•	•	•		
355-412	TC	Smooth						•	•			
355-412NL	TC	Smooth					•	•				
355-413	TC	7000						•	•			
355-413NL	TC	7000						•	•			

Standard French Gauge

The standard French is used to measure diameters of all bougies, catheters, sounds, suction tubes and uterine dilators.

French Catheter Scale		
*sizes are Outside Diameter		
French	Inch	mm
3	0.039	1.0
4	0.053	1.35
5	0.066	1.67
6	0.079	2.0
7	0.092	2.3
8	0.105	2.7
9	0.118	3.0
10	0.131	3.3
11	0.144	3.7
12	0.158	4.0
13	0.170	4.3
14	0.184	4.7
15	0.197	5.0

French Catheter Scale		
*sizes are Outside Diameter		
French	Inch	mm
16	0.210	5.3
17	0.223	5.7
18	0.236	6.0
19	0.249	6.3
20	0.263	6.7
22	0.288	7.3
24	0.315	8.0
26	0.341	8.7
28	0.367	9.3
30	0.393	10.0
32	0.419	10.7
34	0.445	11.3

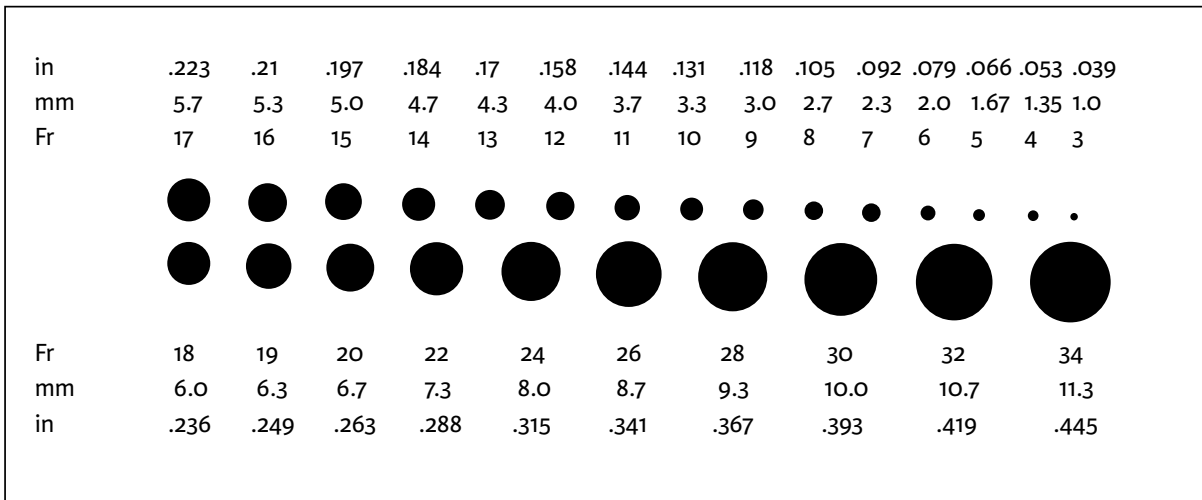

Syringe Needle Gauge Chart

Needle Gauge	Nominal O.D.			Nominal I.D.		
	mm	inches	tol. (in.)	mm	inches	tol. (in.)
10	3.404	0.1340	±0.0010	2.692	.1060	±0.0020
11	3.048	0.1200	"	2.388	.0940	"
12	2.769	0.1090	"	2.159	.0850	"
13	2.413	0.0950	"	1.803	.0710	"
14	2.108	0.0830	"	1.600	.0630	"
15	1.829	0.0720	±0.0005	1.372	.0540	±0.0015
16	1.651	0.0650	"	1.194	.0470	"
17	1.473	0.0580	"	1.067	.0420	"
18	1.270	0.0500	"	0.838	.0330	"
19	1.067	0.0420	"	0.686	.0270	"
20	0.902	0.0355	±0.0005 -0.0000	0.584	.0230	±0.0015 -0.0000
21	0.813	0.0320	"	0.495	.0195	"
22	0.711	0.0280	"	0.394	.0155	"
22s	0.711	0.0280	"	0.140	.0055	"
23	0.635	0.0250	"	0.318	.0125	"
24	0.559	0.0220	"	0.292	.0115	"
25	0.508	0.0200	"	0.241	.0095	"
25s	0.508	0.0200	"	0.140	.0055	"
26	0.457	0.0180	"	0.241	.0095	"
26s	0.467	0.0184	"	0.114	.0045	"
27	0.406	0.0160	"	0.191	.0075	"
28	0.356	0.0140	"	0.165	.0065	"
29	0.330	0.0130	"	0.165	.0065	"
30	0.305	0.0120	"	0.140	.0055	"
31	0.254	0.0100	"	0.114	.0045	"
32	0.229	0.0090	"	0.089	.0035	"
33	0.203	0.0080	"	0.089	.0035	"

Length Conversions

Multiply	By	To Obtain
Millimeters (mm)	0.1	Centimeters (cm)
Millimeters (mm)	0.03937	Inches (")
Centimeters (cm)	0.3937	Inches (")
Centimeters (cm)	10	Millimeters (mm)
Inches (")	25.4	Millimeters (mm)
Inches (")	2.540	Centimeters (cm)

How to Measure a Cardiovascular Instrument

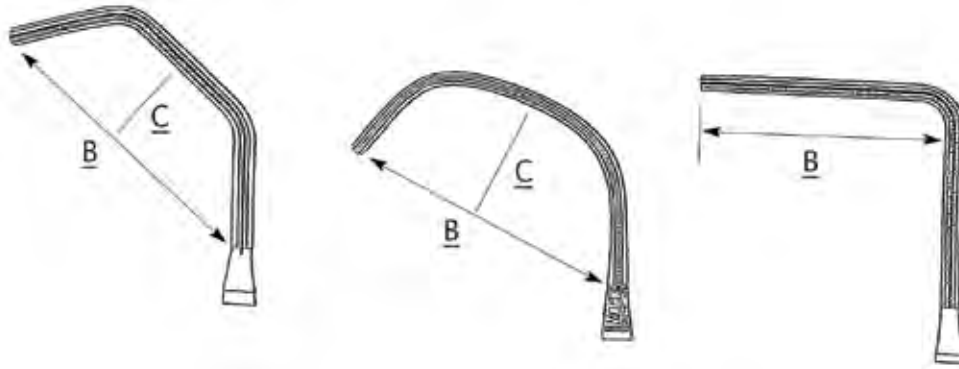

Jaw Dimensions

A=Overall length is measured in a straight line from the bottom of the ring handles to the farthest tip (see below)

B=jaw working length is measured in a straight line from the tip of the clamp to the end of the serrations

C=jaw depth, on an occlusion clamp is measured by drawing a straight line from the jaw tip to the end of the serrations, then finding the approximate center of the jaw and measure to the inside of the jaw

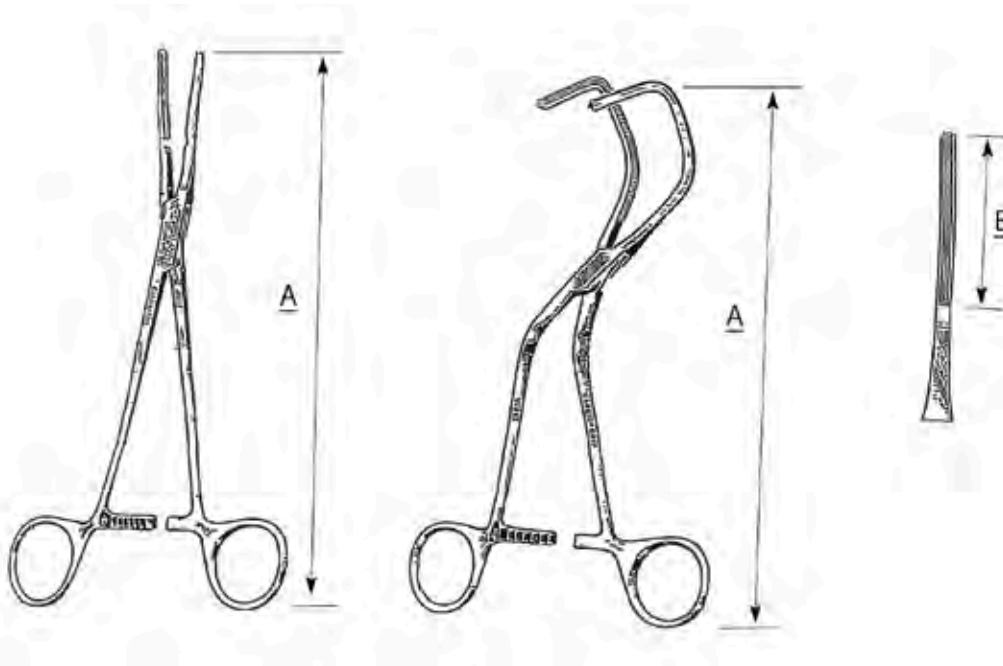

Length

Overall length is measured in a straight line from the bottom of the ring handles to the farthest tip (see above)

Length

Curved and angled instruments, the length is determined by a line drawn from the bottom of the instrument to the farthest point (see above)

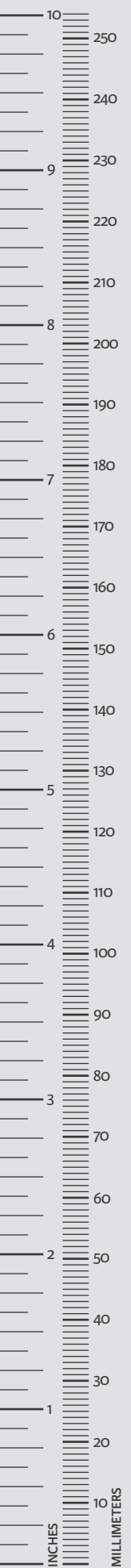

Vascular Jaw Configurations

DeBakey Atraugrip Jaws 1 x 2 Teeth (Fig 1)

The most commonly used jaw design. Available in three sizes, Standard, Small and extra small. A single row of serrated teeth opposing a double row. Proven throughout the world for adult peripheral vascular, aortic occlusion, partial occlusion, bulldogs, pediatric clamps and vascular tissue forceps.

DeBakey Atraugrip Jaws 2 x 3 Teeth (Fig 2)

A double row of serrated teeth opposing a triple row. A broader clamping surface for aortic cross clamping on diseased and calcified arteries. Clamps with 2 x 3 serrations are also used frequently in general surgery as bowel clamps.

Cooley Type Teeth, 2 x 2 Teeth (Fig 3)

Two opposing rows of fine atraumatic teeth. Designed for infants and children. The jaws grasp vessels firmly with less danger of crushing. Available on a limited group of adult vascular clamps.

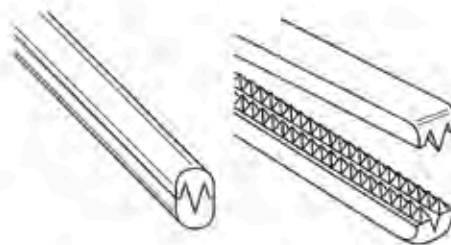

(Fig 1)

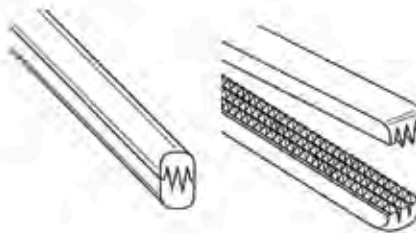

(Fig 2)

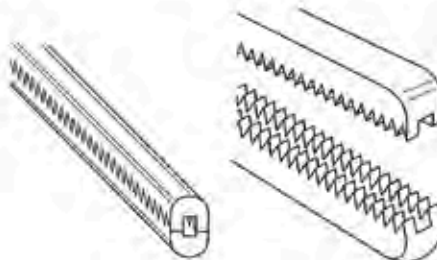

(Fig 3)



Integra™
Numerical Index



099-110 2
 099-130 3
 099-200 5
 099-202 5
 099-210 5
 099-212 5
 099-250 7, 653
 099-251 7, 653
 099-262 8, 722
 099-522 11
 099-526 11
 099-528 11
 100-105 2
 100-109 2
 100-110 2
 100-111 2
 100-115 2
 100-116 3
 100-117 2
 100-120 2
 100-122 2
 100-125 3
 100-126 4
 100-127 3
 100-128 4
 100-129 4
 100-130 3
 100-131 4
 100-132 3
 100-133 4
 100-134 3
 100-135 3
 100-136 4
 100-137 3
 100-138 4
 100-139 4
 100-140 4
 100-175 4
 100-180 4
 100-185 5
 100-190 5
 100-195 5
 100-200 5
 100-202 5
 100-210 5
 100-212 5
 100-215 6
 100-217 6
 100-220 6
 100-222 6
 100-224 6
 100-225 6
 100-226 6
 100-227 6
 100-230 6

100-231 6
 100-233 7, 788
 100-240 7, 372
 100-241 7, 372
 100-242 7, 372
 100-243 7, 372
 100-244 7, 372
 100-245 7, 372
 100-250 7, 653
 100-251 7, 653
 100-260 8
 100-261 8, 373, 654
 100-262 8, 722
 100-265 8
 100-266 8, 722
 100-269 8, 654
 100-270 8, 654
 100-272 9, 654
 100-278 9, 605, 654
 100-279 9, 605, 654
 100-280 9, 754, 787
 100-281 9, 754, 787
 100-290 9, 654
 100-291 9, 654
 100-292 9
 100-295 10, 373
 100-296 10, 373
 100-297 10, 373
 100-298 10, 373
 100-300 10, 373
 100-302 10, 373
 100-304 10, 373
 100-306 10, 373
 100-320 10, 655
 100-322 10, 655
 100-325 10, 655
 100-327 10, 655
 100-330 10, 655
 100-332 10, 655
 100-502 11
 100-512 11
 100-522 11
 100-526 11
 100-527 11
 100-528 11
 100-530 11
 100-531 11
 100-532 11
 100-539 12, 200
 100-540 12, 201
 100-541 12, 201
 100-542 12, 201
 100-543 12, 201
 100-544 12, 201
 100-545 12, 201

100-546 12, 201
 101-110 37
 101-112 37
 101-130 37
 101-132 37
 101-215 37
 101-217 37
 101-218 37
 101-219 37
 101-220 37
 101-222 37
 101-225 37, 371, 788
 101-226 37, 371, 788
 101-230 37, 371, 788,
 794
 101-232 37, 371, 788,
 794
 101-250 38, 661
 101-251 38, 373, 661
 101-252 38, 661
 101-253 38, 661
 101-255 38, 52, 374,
 662
 101-256 39, 369,
 794
 101-257 39, 662
 101-258 39, 374, 722
 101-259 39, 374, 662
 101-260 39, 374, 662
 101-261 39, 344,
 374, 663
 101-265 39, 374, 722
 101-266 39, 369
 101-267 39, 369
 101-269 39, 369
 101-270 39, 369
 101-272 39, 369,
 794
 101-275 39, 369
 101-276 39, 369
 101-278 39, 369
 101-279 39, 369
 101-300 40, 550,
 663
 101-301 40, 550,
 663
 101-310 40, 552,
 663
 101-311 40, 552,
 663
 101-350 12, 40, 98
 102-100 42
 102-102 42
 102-110 42
 102-112 42

102-113.....	42, 371	102-311.....	47, 374	105-145.....	58, 680
102-114.....	42, 371, 788	102-313.....	48, 375	105-150.....	59
102-115.....	42, 371, 788	102-315.....	48, 376	105-151.....	59
102-116.....	42, 371, 788	102-320.....	48, 378	105-160.....	59, 681
102-118.....	42, 371, 788	102-321.....	48, 378	105-161.....	59, 681
102-119.....	42, 664	102-322.....	48, 378	105-163.....	51, 679
102-120.....	42, 374,	102-350.....	49, 380	105-164.....	51, 679
.....	664	102-351.....	49, 380	105-168.....	60
102-122.....	42, 369,	102-352.....	49, 380	105-169.....	60
.....	374, 664,	102-353.....	49, 380	105-170.....	60
.....	722	102-354.....	49, 380	105-171.....	60
102-125.....	42, 369,	102-360.....	49, 380	105-180.....	60
.....	374, 664	102-374.....	49, 381	105-181.....	60
102-126.....	42, 369, 374	103-220.....	37	105-190.....	60, 785
102-127.....	42, 369,	103-222.....	37	105-191.....	60, 785
.....	374, 794	103-250.....	38, 661	105-195.....	60, 785
102-128.....	42, 369, 374	103-251.....	38, 661	105-196.....	60, 785
102-129.....	42, 369,	103-258.....	39, 722	105-197.....	60, 785
.....	374, 794	103-261.....	39, 663	105-198.....	60, 785
102-130.....	43, 550,	105-088.....	50, 301, 678	105-199.....	60, 785,
.....	664	105-089.....	50, 301, 678	798
102-131.....	43, 550,	105-090.....	50, 476,	105-200.....	61
.....	664	678	105-202.....	61
102-138.....	43, 665	105-091.....	50, 476,	105-210.....	61, 786
102-139.....	43, 665	678	105-212.....	61, 786
102-140.....	43, 665	105-092.....	50, 301,	105-220.....	61, 786
102-141.....	43, 665	402, 476	105-222.....	61, 786
102-180.....	43, 605,	105-093.....	50, 301,	105-223.....	61, 786
.....	665, 704	402, 476	105-224.....	61, 786
102-200.....	43, 665	105-095.....	50, 476,	105-225.....	61, 786
102-202.....	43, 665	678	105-226.....	61, 786
102-205.....	44, 665	105-096.....	50, 476,	105-227.....	61, 786
102-210.....	44, 666	678	105-228.....	61, 786, 795
102-211.....	44, 666	105-098.....	50, 301,	105-229.....	61, 786, 795
102-215.....	44, 666	476, 678	105-230.....	62, 681
102-216.....	44, 666	105-099.....	50, 301,	105-232.....	62, 681
102-220.....	44, 666	476, 678	105-233.....	51, 679
102-221.....	44, 666	105-100.....	55, 679	105-234.....	51, 679
102-225.....	45, 667	105-102.....	55, 679	105-235.....	402, 456,
102-226.....	45, 667	105-105.....	55	476
102-229.....	45, 667	105-110.....	56, 680	105-240.....	62
102-230.....	45, 667	105-112.....	56, 680	105-242.....	62
102-231.....	45, 667	105-114.....	56, 680	105-243.....	62
102-235.....	46, 668	105-115.....	56, 680	105-245.....	62
102-236.....	46, 668	105-118.....	51, 678	105-250.....	62
102-238.....	46, 668	105-119.....	51, 678	105-251.....	62
102-240.....	46, 668	105-120.....	57	105-255.....	63, 754
102-242.....	46, 668	105-121.....	57	105-260.....	63, 427
102-245.....	47, 375, 668	105-130.....	58	105-261.....	63, 427
102-300.....	47, 373	105-131.....	58	105-262.....	63, 427
102-302.....	47, 373	105-140.....	57	105-263.....	63, 427
102-305.....	47, 372	105-141.....	57	105-270.....	63
102-306.....	47, 372	105-142.....	58, 680	105-271.....	63
102-307.....	372	105-143.....	58, 680	105-300.....	63, 403,
102-310.....	47, 344, 374	105-144.....	58, 680	447, 456

105-302	63, 403,	107-190.....	60, 785	115-110	74
.....	447, 456	107-191.....	60, 785	115-112.....	74
105-304	63, 403,	107-200.....	61	115-115.....	74
.....	447	107-210.....	61, 786	115-117.....	74
105-306.....	63, 403,	107-220	61, 786	115-119.....	75, 775
.....	447	109-100	65	115-120.....	75, 775
105-320	64, 754	109-102	65	116-100	74
105-330	64, 404	109-119	67	116-102.....	74
105-331	64, 404	109-120	67	116-105.....	74
105-332.....	64, 404	110-100.....	65	116-107.....	74
105-340.....	64, 404	110-102.....	65	116-110.....	74
105-341.....	64, 404	110-105.....	65	116-112.....	74
105-342	64, 404	110-110.....	66	116-115.....	74
106-100.....	55, 679	110-111.....	66	116-117.....	74
106-102.....	55, 679	110-117.....	66	117-100.....	811
106-120.....	57	110-118.....	66	117-102.....	811
106-121.....	57	110-119.....	67	117-106.....	811
106-130.....	58	110-120.....	67	117-108.....	811
106-131.....	58	110-121.....	67	117-110.....	811
106-140	57	110-150	68, 481	117-112.....	811
106-141	57	110-154.....	68, 481	117-114.....	811
106-150.....	59	110-155.....	68, 481	117-116.....	811
106-151.....	59	110-157.....	68, 481	117-118.....	811
106-168.....	60	110-159.....	68, 481	117-120.....	811
106-169.....	60	110-160.....	69, 482	117-130.....	811
106-170.....	60	110-161.....	69, 482	117-132.....	811
106-171.....	60	110-162.....	69, 482	117-136.....	811
106-180	60	110-164.....	69	117-138.....	811
106-181	60	110-165.....	70	117-140.....	811
106-190	60, 785	110-167.....	70	117-142.....	811
106-191	60, 785	110-169.....	71	117-144.....	811
106-195.....	60, 785	110-170.....	71	117-148.....	811
106-196	60, 785	110-171.....	72	117-160.....	811
106-200.....	61	110-173.....	72	117-162.....	811
106-202.....	61	110-174.....	72	117-164.....	811
106-210	61, 786	110-175.....	70	117-166.....	811
106-212.....	61, 786	110-176.....	70	117-168.....	811
106-220.....	61, 786	110-177.....	71	117-170.....	811
106-222.....	61, 786	110-178.....	71	117-180.....	812
106-230.....	62, 681	110-180.....	72	117-182.....	812
106-232	62, 681	110-182.....	73	117-184.....	812
107-100.....	55, 679	110-190.....	73	117-188.....	812
107-102.....	55, 679	110-191.....	73	117-190.....	812
107-114.....	56, 680	110-194.....	73	117-192.....	812
107-115.....	56, 680	110-195.....	73	117-194.....	812
107-120.....	57	110-198.....	73	117-196.....	812
107-121.....	57	111-100.....	65	117-198.....	812
107-130.....	58	111-102.....	65	117-199.....	812
107-131.....	58	114-102.....	75	117-240.....	812
107-140.....	57	114-107.....	75	117-242.....	812
107-141.....	57	114-124.....	75, 795	117-244.....	812
107-170	60	115-100.....	74	117-246.....	812
107-171	60	115-102.....	74	117-247.....	812
107-180.....	60	115-105.....	74	117-248.....	812
107-181.....	60	115-107.....	74	117-249.....	812



117-250.....	813	121-106	83, 673	121-181.....	89, 416
117-252.....	813	121-115	83, 674	121-182	89, 416
117-254.....	813	121-116.....	83, 674	121-183	89, 416
117-256.....	813	121-118.....	84, 412, 674	121-184	89, 416
117-258.....	813	121-119	84, 412, 674	121-185	89, 416
117-260	813	121-120.....	84, 674	121-186.....	89, 416
117-262.....	813	121-121	84, 674	121-187	89, 416
117-270.....	813	121-125	84	121-188	89, 416
117-272	813	121-126	85, 412	121-189	89, 416
117-274	813	121-127	85, 412	121-192	89, 416
117-276	813	121-128	85, 413, 799	121-193	89, 416
117-278	813	121-129	85, 413, 799	121-195	90, 417
117-280	813	121-130.....	85, 413, 675	121-196.....	90, 417
117-330.....	813	121-131.....	85, 413, 675	121-197	53, 90, 417
117-340	813	121-132	85, 413	121-198.....	53, 90, 417
117-360	815	121-133	85, 413	121-200.....	90, 417
117-365.....	815	121-134	85, 413	121-204	91, 799
117-370.....	815	121-135	86, 413	121-205	90, 417
117-380	815	121-140.....	86, 413	121-206.....	90, 418
117-381	815	121-142	86, 413	121-207	90, 418
117-390	815	121-143	86, 413	121-209.....	91
117-391	815	121-144.....	86, 413, 799	121-210.....	91
117-392	815	121-145.....	86, 413	121-211.....	91, 418
118-116.....	814	121-146.....	86, 413	121-212	91, 418
118-118.....	814	121-147	86, 413, 799	121-213	91, 418
118-119.....	814	121-148.....	52, 87, 675	121-214.....	91, 418
120-090	76, 669	121-149.....	52, 87, 675	121-215.....	91, 418
120-095	76, 669	121-150.....	87	121-216.....	91, 415
120-097	76, 669	121-155	87	121-217	91, 415
120-100	76, 669	121-160.....	87, 414	121-218.....	91, 415
120-105.....	77, 670	121-161.....	87, 414	121-219.....	91, 415
120-110	77, 670	121-161TI	494	121-220	92
120-112.....	77, 670	121-162	87, 414	121-228	92, 270,
120-115.....	77, 670	121-162TI	494	419
120-118.....	78, 671	121-163	87, 414	121-228NL	92, 270,
120-120.....	78, 671	121-163TI.....	494	419
120-125	78	121-164	87, 414	121-229	92, 270,
120-130	78, 671	121-165	87, 414	419
120-131.....	78, 671	121-166.....	88, 415	121-229NL.....	92, 270,
120-132	78	121-170	53, 88, 414,	419
120-135	79	675	121-230	92, 270,
120-140.....	79	121-171.....	53, 88, 415,	419
120-145	79	675	121-230NL.....	92, 270,
120-147	79	121-172	53, 88, 414,	419
120-148	52, 79, 671	675	121-231	92, 270,
120-149	52, 79, 671	121-173	53, 86, 88,	419
120-150.....	79	415, 675	121-231NL.....	92, 270,
120-155	79	121-174	53, 86, 88,	419
120-180.....	79	414	121-250	93, 256, 419
120-200.....	80	121-175	53, 88, 415	121-255.....	93, 256,
120-210.....	80	121-176	53, 88, 414	420
120-215	80, 671	121-177	53, 88, 414	121-257.....	93, 256,
121-097.....	82, 672	121-178	53, 88, 415	420
121-100	82, 672	121-179	53, 88, 415	121-258	93, 256,
121-105.....	82, 672	121-180.....	88, 415	420

121-260.....	93, 256,	125-117.....	97	130-166	101
.....	420	125-120	97	130-167.....	101
121-265	93, 256,	125-122.....	97	130-170	101
.....	420	125-125.....	97	130-175.....	101
121-270	86, 412	125-130	97	130-180	101, 796
121-271	86, 412	125-132.....	97	130-182	101, 796
121-272.....	86, 412	125-150	97, 642	130-185	100
121-273.....	412	125-152.....	97, 642	130-200	101
121-274.....	412	125-154.....	97, 642	130-201	101
122-500	95, 688	125-155.....	97, 642	130-210	101
122-501	95, 688	125-165.....	12, 98	130-211	101
122-502	95, 688	125-170.....	12, 98	130-216	101
122-503.....	95, 688	125-175	13, 98	130-217	101
122-510	95, 688	125-180	13, 98	130-220	101
122-520	95, 393	125-182.....	13, 98	130-225.....	101
122-530.....	95, 113, 307,	125-184.....	13, 99	130-230.....	104, 304,
.....	390, 688	125-185.....	13, 99	683
122-535	95, 113, 307,	125-190	13, 99	130-231	104, 304,
.....	390, 688	125-192	14, 99	683
122-540	95, 393	125-193.....	14, 99	130-232	104, 304,
122-541	95, 394	125-194	14, 99	683
122-542.....	95, 393	125-195.....	14, 99, 555,	130-234.....	104, 304,
122-543.....	95, 394	655	683
122-544.....	95, 393	129-110.....	100	130-235.....	104, 304,
122-545.....	95, 394	129-115	100	683
122-550	96, 394	129-160.....	101	130-236.....	105, 305,
122-560	96	129-165	101	684
122-570.....	96, 393	129-230.....	104, 304,	130-237	104, 304,
122-590	96, 394,	683	683
.....	688	129-234.....	104, 304,	130-238	104, 304,
122-591	96, 394,	683	683
.....	688	129-260	106, 685	130-240	105, 684
122-600.....	96, 395	129-390	111, 386	130-241	105
122-601.....	96, 395	129-392.....	111, 386	130-243.....	105, 305,
122-602.....	96, 395	129-395.....	111, 386	684
123-105	82, 673	130-099.....	100	130-244.....	105, 305,
123-106	83, 673	130-100.....	100	684
123-130.....	85, 413, 675	130-101.....	100	130-245.....	105, 305,
123-131	85, 413, 675	130-105.....	100	684
123-132.....	85, 413	130-110.....	100	130-246.....	106, 264,
123-135.....	86, 414	130-111.....	100	305, 385
123-140	86, 414	130-115	100	130-247	106, 264,
123-145.....	86, 414	130-116	100	305, 385
124-100TI	493	130-117	100	130-248.....	106, 264,
124-101TI	493	130-120	100	305, 385
124-102TI.....	493	130-125	100	130-249.....	106, 264,
124-105TI.....	493	130-130	100, 795	305, 385
124-106TI	493	130-132	100, 795	130-250	106
124-108TI.....	494	130-145	100	130-255	106
124-109TI	494	130-150	101	130-260	106, 685
124-110TI	494	130-151	101	130-262.....	107, 685
125-100.....	97	130-155	101	130-265.....	107, 385,
125-110.....	97	130-160	101	685
125-114	97	130-161	101	130-266	107, 385,
125-115	97	130-165	101	685



130-267.....	107, 385, 685	130-410.....	112, 307, 389	135-182.....	130
130-270.....	107, 685	130-415.....	112, 307, 390, 687	135-185.....	130
130-275.....	107, 305, 686	130-417.....	113, 308, 391	135-190.....	130
130-276.....	107, 305, 686	130-418.....	113, 308, 391	135-191.....	130
130-280.....	108, 306, 385, 686	130-420.....	112, 307, 389	135-194.....	130, 796
130-281.....	108, 306, 686	130-421.....	112, 307, 390	135-195.....	130
130-282.....	108, 306, 686	130-425.....	112, 307, 390	135-196.....	130, 796
130-284.....	108, 686	130-425TI.....	495, 504	135-197.....	131
130-286.....	108, 686	130-430.....	112, 307, 390	135-248.....	115, 386, 796
130-287.....	108	130-435.....	112, 307, 390	135-250.....	115, 386
130-289.....	108, 686	130-437.....	114, 387	135-252.....	115, 386
130-290.....	108, 686	130-440.....	114, 308, 391, 687	135-253.....	115, 386
130-293.....	109, 687	130-442.....	114, 308, 391, 687	135-254.....	115, 386
130-294.....	109, 687	130-445.....	111, 306, 389	135-256.....	115, 387
130-296.....	109, 387	130-446.....	112, 306, 389	135-257.....	115, 387
130-297.....	109, 387	130-500.....	125	135-258.....	115, 387
130-298.....	109, 387	130-505.....	125	135-260.....	132
130-300.....	109	130-510.....	125	135-261.....	132
130-350.....	109, 388	130-515.....	125	135-262.....	132, 795
130-352.....	110, 388	130-520.....	125	135-263.....	132, 795
130-353.....	110, 388	130-525.....	125	135-264.....	132, 795
130-355.....	109, 388	130-530.....	125	135-265.....	132, 795
130-357.....	110, 388	130-535.....	125	135-266.....	132, 795
130-358.....	110, 388	135-095.....	54, 126, 681	135-267.....	132, 795
130-360.....	109, 388	135-100.....	126	135-270.....	132
130-362.....	110, 388	135-105.....	126	135-271.....	132
130-363.....	110, 388	135-107.....	127	135-275.....	132
130-365.....	109, 388	135-109.....	126	135-276.....	132
130-366.....	110, 388	135-110.....	127	135-280.....	132
130-367.....	109, 388	135-111.....	127	135-281.....	132
130-368.....	110, 388	135-115.....	127	135-300.....	133
130-369.....	110, 388	135-120.....	127	135-301.....	133
130-370.....	110, 385, 687	135-125.....	128	135-305.....	133
130-375.....	110, 385	135-127.....	128	135-340.....	133
130-380.....	110	135-130.....	128	135-345.....	133
130-383.....	110, 388	135-135.....	128	135-350.....	133
130-390.....	111, 386	135-150.....	129	135-355.....	133
130-392.....	111, 386	135-155.....	129	135-370.....	134
130-394.....	111, 386, 796	135-175.....	129	135-375.....	134
130-395.....	111, 386	135-179.....	54, 129, 682	135-400.....	135
130-396.....	111, 386, 796	135-180.....	54, 129, 682	135-430.....	135
130-397.....	111	135-181.....	130	135-435.....	135
130-400.....	111, 306, 389			135-440.....	135
130-405.....	112, 306, 389, 687			135-445.....	135
				135-450.....	136
				135-451.....	136
				135-500.....	136
				135-502.....	136
				135-504.....	136
				135-505.....	137
				135-506.....	137
				135-507.....	137
				135-598.....	137
				135-600.....	137



135-605	137	140-333.....	145, 403	180-233.....	152
135-615.....	131	140-335.....	145, 403,	180-234.....	152
136-100.....	126	796	180-235.....	152
136-105.....	126	150-160.....	146	180-236.....	152
136-110.....	127	150-165.....	146	180-238.....	152
136-181.....	130	150-175.....	146	180-250.....	153
136-190.....	130	150-180.....	146	180-251.....	153
140-100.....	141	150-190.....	146	180-252.....	153
140-101.....	141	160-120.....	146, 430	180-253.....	153
140-102.....	141	170-100.....	147	180-255.....	153
140-103.....	141	170-101.....	147	180-260.....	153
140-104.....	141	170-102.....	147	180-261.....	153
140-105.....	141	170-103.....	147, 800	180-262.....	153
140-106.....	141	170-104.....	147, 800	180-263.....	153
140-107.....	141	170-105.....	148	180-265.....	153
140-108.....	141	170-115.....	148, 724	185-100.....	154
140-109.....	141	170-117.....	148, 800	185-105.....	154
140-154.....	141	170-118.....	148, 724	185-110.....	154
140-155.....	141	170-120.....	148, 724	185-115.....	154
140-156.....	141	170-122.....	149, 724	185-120.....	154
140-175.....	142	170-125.....	149	185-135.....	154
140-190.....	142	170-175.....	149	185-136.....	154
140-192.....	142	175-100.....	150	185-150.....	155
140-205.....	142, 407	175-105.....	150	185-152.....	155
140-206.....	142, 407	175-110.....	150	185-153.....	155
140-210.....	142	175-111.....	150	185-154.....	155
140-216.....	143, 407,	175-120.....	150	185-155.....	155
.....	456	175-121.....	150	185-156.....	155
140-217.....	143, 407,	180-100.....	151	185-157.....	155
.....	456	180-105.....	151	185-170.....	155
140-218.....	54, 143,	180-110.....	151	185-171.....	155
407,	456, 682	180-115.....	151	185-172.....	155
140-223.....	54, 143,	180-130.....	151	185-173.....	155
.....	408, 682	180-175.....	151	185-174.....	155
140-224.....	143, 408	180-176.....	151	185-175.....	155
140-225.....	143, 408	180-180.....	152	185-176.....	155
140-226.....	143, 408	180-182.....	152	185-179.....	155
140-228.....	142, 407	180-184.....	152	185-180.....	155
140-230.....	143, 408	180-188.....	152	185-181.....	155
140-231.....	144, 404	180-200.....	152	185-182.....	155
140-232.....	144, 403	180-201.....	152	185-183.....	155
140-233.....	144, 403	180-202.....	152	185-185.....	155
140-234.....	144, 403	180-203.....	152	185-186.....	155
140-240.....	144	180-204.....	152	185-187.....	155
140-245.....	144	180-205.....	152	185-191.....	155
140-320.....	14, 145	180-207.....	152	185-193.....	155
140-322.....	14, 145	180-222.....	152	185-196.....	156
140-329.....	145, 403,	180-223.....	152	185-201.....	156
.....	457	180-224.....	152	185-206.....	156
140-330.....	145, 302,	180-225.....	152	185-210.....	156
.....	403, 422	180-226.....	152	185-231.....	156
140-331.....	145, 302,	180-227.....	152	185-250.....	156
.....	403	180-228.....	152	185-260.....	156
140-332.....	145, 302,	180-231.....	152	189-110.....	157, 636
.....	403	180-232.....	152	189-112.....	157, 636

190-100	157
190-101	157
190-102	157
190-103	157
190-104	157
190-105	157
190-110	157, 636
190-112	157, 636
190-115	158, 637
190-116	158, 637
190-118	158, 637
190-120	158, 637
190-129	158, 637
190-130	159, 638
190-131	159, 638
190-132	159, 638
190-133	159, 638
190-134	159, 638
190-135	159, 638
190-150	160, 638
190-151	160, 638
190-152	160, 638
190-153	160, 638
190-154	160, 638
190-155	160, 638
190-156	160, 638
190-157	160, 638
190-170	160
190-171	160
190-172	160
190-173	160
190-175	160
190-176	160
190-177	160
190-178	160
199-105	161
199-135	164
199-272	175
199-282	175
199-292	176
199-297	176
200-100	161
200-105	161
200-106	161
200-107	161
200-108	161
200-109	161
200-110	162
200-115	162
200-116	173
200-119	162
200-120	162
200-122	162
200-125	162
200-126	163
200-127	163
200-128	163
200-130	163
200-131	163
200-132	163
200-133	163
200-134	164
200-135	164
200-136	164, 800
200-137	164, 800
200-138	164
200-140	165
200-142	165
200-143	165
200-145	165, 765
200-147	165, 765
200-149	165, 765
200-150	165
200-151	165
200-152	165
200-155	166
200-156	166
200-157	166
200-160	167
200-165	168
200-166	168
200-167	168
200-168	168
200-170	169
200-172	169
200-173	169
200-175	169
200-176	169
200-178	169
200-180	170
200-181	170
200-182	170
200-190	170
200-191	170
200-192	170
200-194	170
200-195	170
200-196	170
200-197	170
200-198	171
200-200	171
200-201	171
200-202	171
200-203	171
200-204	171, 800
200-205	172
200-206	172
200-207	172
200-208	171
200-210	172
200-217	173
200-218	173
200-219	173
200-220	173
200-221	173
200-222	173
200-223	173
200-225	173
200-226	173
200-227	173
200-228	173
200-235	174
200-237	174
200-255	174
200-261	167, 348
200-270	175
200-271	175
200-272	175
200-273	175
200-280	175
200-281	175
200-282	175
200-283	175
200-290	176
200-291	176
200-292	176
200-293	176
200-295	176
200-296	176
200-297	176
200-298	176
200-300	177
200-301	177
200-302	177
200-303	177
200-310	177
200-311	177
200-312	177
200-313	177
200-315	177
200-318	177
201-155	166
201-156	166
201-157	166
201-160	167
201-165	168
201-166	168
201-167	168
201-168	168
201-200	172
201-201	172
201-202	172
201-203	172, 800
201-204	172
201-205	172



201-206.....	172	641	205-296.....	186
201-220.....	173	205-141.....	181, 330,	205-298.....	187
201-221.....	173	641	205-299.....	187
201-222.....	173	205-150.....	181, 330,	205-300.....	188
201-223.....	173	641	205-305.....	188
201-225.....	173	205-151.....	181, 330,	205-310.....	188
202-155.....	166	641	205-312.....	191
202-156.....	166	205-155.....	181, 330,	205-313.....	191
202-157.....	166	641	205-315.....	189
202-160.....	167	205-156.....	181, 330,	205-316.....	189
202-165.....	168	641	205-320.....	190
202-166.....	168	205-160.....	181, 330	205-321.....	190
202-167.....	168	205-161.....	181, 330	205-322.....	190
202-168.....	168	205-165.....	181, 330	205-323.....	190
204-120.....	178	205-166.....	181, 330	205-324.....	190
204-123.....	179, 640	205-175.....	182, 331,	205-325.....	191
204-124.....	179, 640	641	205-330.....	189
204-125.....	179, 640	205-176.....	182, 331,	205-331.....	189
204-140.....	181, 330,	641	205-332.....	189
.....	641	205-180.....	182, 331,	205-335.....	186
204-141.....	181, 330,	641	205-336.....	186
.....	641	205-181.....	182, 331,	205-337.....	186
204-150.....	181, 330,	641	205-500.....	192
.....	641	205-190.....	182, 331	205-502.....	192
204-151.....	181, 330,	205-200.....	182, 331	205-504.....	193
.....	641	205-201.....	182, 331	205-506.....	193
204-155.....	181, 330,	205-205.....	182, 331	205-508.....	193
.....	641	205-206.....	182, 331	205-510.....	193
204-156.....	181, 330,	205-209.....	182, 332	205-512.....	193
.....	641	205-210.....	182, 332	205-514.....	193
204-160.....	181, 330	205-220.....	183, 332	205-530.....	194, 348
204-161.....	181, 330	205-221.....	183, 332	205-532.....	194, 348
204-165.....	181, 330	205-225.....	183, 332	205-534.....	194, 348
204-166.....	181, 330	205-226.....	183, 332	205-536.....	194, 348
205-100.....	178, 639	205-230.....	183, 332	205-540.....	194, 195,
205-105.....	178, 639	205-235.....	183	348
205-110.....	178, 640	205-237.....	183	205-542.....	194, 195,
205-111.....	178, 640	205-240.....	184, 333	348
205-120.....	178	205-242.....	184, 333	205-544.....	194, 195,
205-121.....	179	205-244.....	184, 333	348
205-123.....	179, 640	205-245.....	184, 333	205-550.....	195, 348
205-124.....	179, 640	205-251.....	184	205-560.....	195, 349
205-125.....	179, 640	205-255.....	184, 333	205-561.....	349
205-127.....	180	205-256.....	184, 333	205-562.....	195, 349
205-128.....	180	205-260.....	195, 349	205-563.....	195, 349
205-130.....	180	205-261.....	195, 349	205-564.....	195, 349
205-131.....	180	205-270.....	185	205-570.....	196, 349
205-132.....	180	205-275.....	185	220-100.....	200
205-133.....	180	205-280.....	185	220-105.....	200
205-134.....	180	205-290.....	186	220-110.....	200
205-135.....	180	205-291.....	186	220-115.....	200
205-136.....	180, 640	205-292.....	187	220-130.....	201
205-137.....	180, 640	205-293.....	187	220-155.....	201
205-138.....	180, 640	205-294.....	187	220-175.....	201
205-140.....	181, 330,	205-295.....	186	220-180.....	201

225-105.....	202	225-449.....	209	230-160.....	215
225-115.....	202	225-450.....	209	230-161.....	215
225-121.....	202	225-452.....	209	230-195.....	215, 364
225-126.....	202	225-453.....	209	230-196.....	215, 364
225-131.....	202	225-454.....	209	230-197.....	215, 364
225-135.....	202	225-456.....	209	230-200.....	215, 364
225-136.....	202	225-470.....	209	230-205.....	216, 579
225-137.....	203	225-471.....	209	230-207.....	216
225-138.....	203	225-472.....	209	230-210.....	216, 365, 579
225-139.....	203	225-480.....	210	230-211.....	216, 365, 579
225-162.....	204	225-481.....	210	230-214.....	216, 365, 579
225-170.....	204	225-482.....	210	230-215.....	216, 365, 579
225-175.....	204	225-483.....	210	230-216.....	216, 365
225-176.....	205	225-499.....	210	230-218.....	217, 365
225-177.....	205	225-500.....	210	230-230.....	217, 365
225-178.....	205	225-501.....	210	230-231.....	217, 365
225-179.....	205	225-502.....	210	230-235.....	217, 365
225-180.....	205	225-503.....	210	230-236.....	217, 365
225-185.....	205	225-504.....	210	230-240.....	217, 365
225-186.....	205	225-505.....	210	230-245.....	218, 366
225-187.....	205	225-506.....	210	230-246.....	218, 366
225-188.....	205	225-507.....	210	230-247.....	218, 366
225-190.....	206	225-508.....	210	230-250.....	218, 366
225-191.....	206	225-509.....	210	230-260.....	218, 366
225-192.....	206	225-510.....	211	230-261.....	218, 366
225-193.....	206	225-512.....	211	230-262.....	218, 366
225-194.....	206	225-520.....	211	230-265.....	218
225-200.....	206	225-525.....	211	230-266.....	218
225-205.....	206	230-093.....	212, 576	230-267.....	218
225-210.....	206	230-095.....	212	230-270.....	219
225-215.....	206	230-096.....	212	230-271.....	219
225-220.....	206	230-097.....	212, 576	230-272.....	219
225-225.....	206	230-098.....	212, 576	230-275.....	219, 366
225-230.....	206	230-099.....	212, 576	230-276.....	219, 366
225-235.....	206	230-100.....	212, 576	230-280.....	219, 366
225-400.....	207	230-102.....	212, 576	230-300.....	220
225-402.....	207	230-105.....	213, 576	230-301.....	220
225-405.....	207	230-106.....	213, 576	230-302.....	220
225-407.....	207	230-110.....	213, 577	230-305.....	220
225-408.....	207	230-111.....	213, 577	230-306.....	220
225-412.....	207	230-112.....	213, 577	230-310.....	220, 364, 625
225-413.....	207	230-120.....	213, 577	230-311.....	220, 364
225-420.....	208	230-121.....	213, 577	230-315.....	220
225-425.....	208	230-122.....	213, 577	230-320.....	221, 364
225-430.....	208	230-124.....	214, 577	230-321.....	221, 364
225-431.....	208	230-125.....	214, 577	230-325.....	221, 364
225-432.....	208	230-130.....	214, 578	230-330.....	221
225-433.....	208	230-131.....	214, 578	230-331.....	221
225-434.....	208	230-135.....	214, 578	230-332.....	221
225-436.....	208	230-136.....	214, 578	230-340.....	221
225-438.....	208	230-138.....	214, 578		
225-440.....	209	230-142.....	214, 578		
225-441.....	209	230-145.....	215, 578		
225-443.....	209	230-150.....	215		
225-444.....	209	230-151.....	215		



230-341..... 221
 230-342 221
 240-070 222
 240-071 222
 240-072 222
 240-073 222
 240-074 222
 240-075 222
 240-076 222
 240-077 222
 240-078 222
 240-079 222
 240-080 222
 240-085 223
 240-086 223
 240-087 223
 240-088 223
 240-089 223
 240-090 223
 240-091 223
 240-092 223
 240-093 223
 240-094 223
 240-095 223
 240-098 222
 240-099 222
 240-100 222
 240-101 222
 240-102 222
 240-103 222
 240-104 222
 240-105 222
 240-106 222
 240-107 222
 240-108 222
 240-118 222
 240-119 222
 240-120 222
 240-121 222
 240-122 222
 240-123 222
 240-124 222
 240-125 222
 240-126 222
 240-127 222
 240-128 222
 240-138 223
 240-139 223
 240-140 223
 240-141 223
 240-142 223
 240-143 223
 240-144 223
 240-145 223
 240-146 223

240-147 223
 240-148 223
 240-149 223
 240-150 223
 240-151 223
 240-152 223
 240-153 223
 240-154 223
 240-155 223
 240-156 223
 240-157 223
 240-158 223
 240-159 223
 240-160 224
 240-161 224
 240-162 224
 240-163 224
 240-164 224
 240-165 224
 240-166 224
 240-167 224
 240-168 224
 240-170 224
 240-171 224
 240-172 224
 240-175 224
 240-176 224
 240-177 224
 240-178 224
 240-179 224
 240-180 224
 240-181 224
 240-182 224
 240-183 224
 240-185 224
 240-186 224
 240-187 224
 240-188 224
 240-189 224
 240-190 224
 240-191 224
 240-192 224
 240-193 224
 240-195 225
 240-196 225
 240-197 225
 240-198 225
 240-200 225
 240-202 225
 240-203 225
 240-205 225
 240-207 225
 240-208 225
 240-209 225
 240-210 226

240-211 226
 240-212 226
 240-214 226
 240-215 226
 240-216 226
 240-220 226
 240-221 226
 240-230 226
 240-231 226
 240-232 226
 250-084 227, 816
 250-090 227, 816
 250-092 227, 816
 250-093 227, 816
 250-095 228, 817
 250-097 228, 817
 250-099 228, 817
 250-100 229
 250-101 229
 250-102 229
 250-103 229
 250-104 229
 250-105 229
 250-106 229
 250-107 229
 250-108 229
 250-109 229
 250-120 229
 250-121 229
 250-122 229
 250-123 229
 250-124 229
 250-125 229
 250-126 229
 250-127 229
 250-128 229
 250-129 229
 250-140 229
 250-141 229
 250-142 229
 250-143 229
 250-144 229
 250-145 229
 250-146 229
 250-147 229
 250-148 229
 250-149 229
 250-160 230
 250-161 230
 250-162 230
 250-163 230
 250-164 230
 250-165 230
 250-166 230
 250-167 230

250-168.....	230
250-169.....	230
250-180.....	230
250-181.....	230
250-182.....	230
250-183.....	230
250-184.....	230
250-185.....	230
250-186.....	230
250-187.....	230
250-188.....	230
250-189.....	230
250-190.....	230
250-191.....	230
250-192.....	230
250-193.....	230
250-194.....	230
250-195.....	230
250-196.....	230
250-197.....	230
250-198.....	230
250-199.....	230
250-200.....	231
250-201.....	231
250-202.....	231
250-203.....	231
250-204.....	231
250-205.....	231
250-206.....	231
250-210.....	231
250-211.....	231
250-212.....	231
250-213.....	231
250-214.....	231
250-215.....	231
250-216.....	231
250-220.....	231
250-221.....	231
250-222.....	231
250-223.....	231
250-224.....	231
250-225.....	231
250-226.....	231
250-230.....	231
250-231.....	231
250-232.....	231
250-233.....	231
250-234.....	231
250-235.....	231
250-236.....	231
250-240.....	232
250-241.....	232
250-242.....	232
250-243.....	232
250-244.....	233
250-245.....	233
250-246.....	233
250-247.....	233
250-248.....	233
250-250.....	234
250-251.....	234
250-252.....	234
250-253.....	234
250-254.....	234
250-255.....	234
250-260.....	234
250-261.....	234
250-262.....	234
250-263.....	234
250-264.....	234
250-265.....	234
250-280.....	234
250-281.....	234
250-282.....	234
250-283.....	234
250-284.....	234
250-285.....	234
250-286.....	234
250-290.....	234
250-291.....	234
250-292.....	234
250-293.....	234
250-294.....	234
250-295.....	234
250-296.....	234
250-320.....	235
250-321.....	235
250-322.....	235
250-323.....	235
250-330.....	235
250-331.....	235
250-332.....	235
250-333.....	235
250-335.....	235
250-336.....	235
250-337.....	235
250-338.....	235
250-380.....	236, 817
250-381.....	236
250-382.....	236
250-383.....	236
250-384.....	236
250-385.....	236
250-386.....	236
250-387.....	236
250-390.....	236
250-391.....	237
250-392.....	237
250-393.....	237
250-394.....	237
250-395.....	237
250-396.....	237
250-397.....	237
250-398.....	237, 646
250-399.....	237, 646
250-400.....	238
250-403.....	238
250-404.....	238
250-405.....	238
250-406.....	238
250-408.....	238
250-410.....	237, 646
250-411.....	239
250-412.....	239
250-415.....	239
250-416.....	239
250-418.....	239
250-420.....	240
250-421.....	240
250-422.....	240
250-423.....	240
250-424.....	240
250-425.....	240
250-426.....	240
250-430.....	239
250-431.....	239
250-432.....	239
250-433.....	239
250-434.....	239
250-435.....	239
250-436.....	239
250-470.....	240
250-471.....	240
250-472.....	240
250-480.....	240
250-481.....	240
250-482.....	240
250-483.....	240
250-490.....	241
250-492.....	241
250-495.....	241
250-496.....	241
250-500.....	242
250-502.....	242
250-503.....	242
250-504.....	242
250-505.....	242
250-506.....	242
250-509.....	242, 580
250-510.....	242
251-240.....	232
251-241.....	232
251-242.....	232
251-243.....	232
251-244.....	233



251-245.....	233	275-503.....	257	277-092.....	266
251-246.....	233	275-504.....	257	277-093.....	266
255-100.....	243	275-505.....	257	277-094.....	266
255-110.....	243	275-510.....	258	277-095.....	266
255-111.....	243	275-515.....	258	277-096.....	266
255-112.....	243	275-525.....	258	277-097.....	266
260-104.....	244	275-530.....	258	277-100.....	267
260-105.....	244	275-540.....	259	277-101.....	267
260-106.....	244	275-550.....	259	277-103.....	267
260-109.....	244	275-555.....	260	277-104.....	267
260-110.....	244	275-560.....	260	277-110.....	267
260-112.....	244	275-561.....	260	277-111.....	267
260-116.....	343	275-563.....	235	277-115.....	267
260-117.....	343	275-565.....	260	277-116.....	267
260-118.....	343	275-570.....	261	277-120.....	268, 382
260-120.....	244	275-580.....	261	277-121.....	268, 382
260-121.....	244	275-589.....	261	277-122.....	268, 382
260-135.....	245	275-590.....	261	277-123.....	268, 382
260-160.....	245	275-591.....	261	277-124.....	268, 382
260-200.....	245	275-594.....	262	277-130.....	268, 383
260-201.....	245	275-595.....	262	277-131.....	268, 383
260-205.....	245	275-596.....	262	277-132.....	268, 383
260-210.....	245	275-600.....	262	277-135.....	268, 383
270-120.....	246	277-040.....	264, 398	277-136.....	268, 383
270-121.....	246	277-041.....	264, 398	277-140.....	269
270-122.....	246	277-042.....	264, 398	277-141.....	269
270-150.....	14, 246	277-043.....	264, 398	277-145.....	269
270-157.....	246	277-044.....	264, 398	277-147.....	269
270-165.....	247	277-045.....	264, 398	277-159.....	116, 270
270-170.....	247	277-046.....	264, 398	277-160.....	116, 270
270-175.....	247	277-047.....	264, 398	277-161.....	116, 270
270-176.....	247	277-049.....	264, 398	277-162.....	116, 270
270-180.....	247	277-050.....	265	277-200.....	271
270-182.....	248	277-051.....	265	277-202.....	271
270-183.....	248	277-053.....	265	277-204.....	271
270-185.....	248	277-054.....	265	277-206.....	271
270-186.....	248	277-056.....	265	277-210.....	271
270-187.....	249	277-057.....	265	277-211.....	271
270-188.....	249	277-058.....	265, 382	277-212.....	271
270-189.....	249	277-059.....	265, 382	277-213.....	271
270-195.....	249	277-060.....	265	277-215.....	271
270-196.....	249	277-061.....	265	277-217.....	272
270-197.....	249	277-062.....	265	277-220.....	272
270-198.....	249	277-065.....	265	277-221.....	272
270-200.....	249	277-066.....	265	277-222.....	272
270-225.....	249	277-070.....	266	277-225.....	272
275-125.....	255	277-071.....	266	277-235.....	273
275-126.....	255	277-072.....	266	277-236.....	273
275-135.....	255	277-073.....	266	277-237.....	273
275-140.....	256	277-075.....	266	277-238.....	273
275-145.....	256	277-076.....	266	277-240.....	274
275-155.....	257	277-080.....	264, 398	277-241.....	274
275-500.....	257	277-081.....	264, 398	277-244.....	274
275-501.....	257	277-090.....	266	277-245.....	274
275-502.....	257	277-091.....	266	277-250.....	274

277-251.....	274	277-401.....	418	502
277-252.....	274	277-402.....	418	278-112.....	280
277-253.....	274	277-403.....	418	278-113.....	280
277-260.....	275	277-404.....	418	278-113TI.....	282, 496,
277-260TI.....	275, 500	277-405.....	419	502
277-261.....	275	277-406.....	418	278-114.....	280
277-261TI.....	275, 500	277-407.....	418	278-115.....	280
277-262.....	275	277-408.....	419	278-116.....	280
277-262TI.....	275, 500	277-409.....	418	278-117.....	280
277-263.....	275	277-410.....	418	278-118.....	280
277-263TI.....	275, 500	277-411.....	418	278-119.....	280
277-264.....	275	277-412.....	419	278-120.....	280
277-264TI.....	275, 500	277-413.....	418	278-121.....	280
277-265.....	275	277-414.....	418	278-125.....	282
277-265TI.....	276, 500	277-415.....	418	278-125NL.....	282
277-266.....	275	278-040.....	281	278-126.....	282
277-266TI.....	276, 500	278-050.....	281	278-126NL.....	282
277-267.....	275	278-060.....	281	278-130.....	283
277-267TI.....	276, 500	278-061.....	281	278-130NL.....	283
277-268.....	276	278-062.....	281	278-131.....	283
277-268TI.....	276, 500	278-063.....	281	278-131NL.....	283
277-269.....	276	278-069TI.....	497	278-132.....	283
277-269TI.....	276, 500	278-070TI.....	497	278-132NL.....	283
277-270.....	276	278-071TI.....	497	278-133.....	283
277-270TI.....	276, 500	278-072TI.....	497	278-133NL.....	283
277-271.....	276	278-077TI.....	497	278-134.....	283
277-271TI.....	276, 500	278-078TI.....	497	278-134NL.....	283
277-272.....	277	278-079TI.....	497	278-135.....	283
277-272TI.....	277, 501	278-080TI.....	282, 496,	278-135NL.....	283
277-273.....	277	502	278-140TI.....	496
277-273TI.....	277, 501	278-082TI.....	282, 496,	278-141TI.....	496
277-274.....	277	502	278-142TI.....	496
277-274TI.....	278, 501	278-092.....	279	278-143TI.....	497
277-275.....	278, 818	278-093.....	279	278-144TI.....	497
277-275TI.....	278, 501,	278-093TI.....	282, 496,	278-145TI.....	497
.....	818	502	278-146TI.....	497
277-276TI.....	278, 501	278-094.....	279	278-147TI.....	497
277-277TI.....	278, 501	278-095.....	279	278-171TI.....	497
277-278TI.....	278, 501	278-095TI.....	282, 496,	278-172TI.....	497
277-279TI.....	278, 501	502	278-173TI.....	497
277-290.....	278	278-096.....	279	278-174TI.....	497
277-291.....	278	278-097.....	279	278-180.....	281
277-292.....	278	278-097TI.....	282, 496,	278-181.....	281
277-295.....	278	502	278-182.....	281
277-330.....	269, 384	278-100.....	279	278-183.....	281
277-331.....	269, 384	278-101.....	279	278-184.....	281
277-332.....	269, 384	278-102.....	279	278-185.....	281
277-333.....	269, 384	278-103.....	279	278-186.....	281
277-334.....	269, 384	278-104.....	279	278-220.....	547
277-335.....	269, 383	278-105.....	279	278-221.....	547
277-336.....	269, 383	278-108TI.....	282, 496,	278-222.....	547
277-337.....	269, 383	502	278-223.....	547
277-338.....	269, 383	278-110.....	280	279-083TI.....	503
277-339.....	269, 383	278-111.....	280	279-084TI.....	503
277-400.....	418	278-111TI.....	282, 496,	279-088TI.....	503

279-089TI	503	280-059	288	280-297	293
279-093TI	503	280-060	289	280-298	293
279-094TI	503	280-060DT	291	280-380	294
279-097TI	503	280-060TF	290	280-381	294
279-098TI	503	280-061	289	280-382	294
279-100	284, 285,	280-061DT	291	280-383	294
.....	399	280-061TF	290	280-384	294
279-100TI	286, 505	280-062	289	280-385	294
279-101	284, 399	280-062DT	291	280-386	295
279-101TI	286, 505	280-062TF	290	280-387	295
279-102	284, 399	280-063	289	280-388	295
279-102TI	286, 505	280-063DT	291	280-400	294
279-105	284, 399	280-063TF	290	280-401	294
279-106	284, 399	280-064	289	280-402	294
279-107	284, 399	280-160	291	280-405	294
279-110	400	280-161	291	280-406	294
279-110TI	286, 498,	280-162	291	280-407	294
.....	505	280-163	291	280-410	294
279-111	285, 400	280-164	291	280-411	294
279-111TI	286, 498,	280-199	291	280-412	294
.....	505	280-200	291	280-415	294
279-112	285, 400	280-201	291	280-416	294
279-112TI	286, 498,	280-202	291	280-417	294
.....	505	280-203	291	280-420	295
279-113	285, 400	280-209	292	280-421	295
279-114	285, 400	280-210	292	280-422	295
279-115	285, 400	280-211	292	280-425	295
279-116	285, 400	280-212	292	280-426	295
279-117	285, 400	280-213	292	280-427	295
279-118	285, 400	280-219	292	280-430	296
279-119	285, 400	280-220	292	280-431	296
279-120	285, 400	280-221	292	280-432	296
279-121	285, 400	280-222	292	280-440	296
279-122	285, 400	280-223	292	280-441	296
279-125	285, 399	280-229	292	280-442	296
279-130	285, 400	280-230	292	280-450	297, 620
279-131	285, 400	280-231	292	280-451	297, 620
279-149	284, 399	280-232	292	280-452	297, 620
279-150	284, 399	280-233	292	280-454	297, 620
279-150TI	504	280-234	293	280-460	298
279-151TI	504	280-235	293	280-465	298
279-158	285, 399	280-236	293	280-466	298
279-159	285, 399	280-237	293	280-467	298
280-040	288	280-238	293	280-470	298
280-040DT	291	280-239	292	280-500	299
280-041	289	280-240	292	280-501	299
280-050	288	280-241	292	280-502	299
280-051	288	280-242	292	280-503	299
280-052	288	280-243	292	280-504	299
280-053	288	280-286	293	280-505	299
280-054	288	280-288	293	280-510	299
280-055	288	280-290	293	280-511	299
280-056	288	280-292	293	280-512	299
280-057	288	280-295	293	280-514	299
280-058	288	280-296	293	280-515	299



280-516	299	281-452.....	297	392
280-517.....	299	282-060	289	285-126	117, 309,
280-530.....	299	282-061	289	392
280-550.....	300	282-062.....	289	285-127	117, 309,
280-551	300	282-063.....	289	392
280-552	300	282-064.....	289	285-128	116, 309,
280-553	300	282-405.....	294	392
280-554	300	282-406.....	294	285-129	117, 309,
280-555.....	300	282-407	294	392
280-556.....	300	282-415.....	294	285-130.....	117, 309,
280-557.....	300	282-416.....	294	392
280-558.....	300	282-417.....	294	285-131TI	504
280-559.....	300, 818	282-425	295	285-132	309, 392
281-040.....	288	282-426	295	285-132TI.....	504
281-040DT.....	291	282-427	295	285-135	309, 392
281-041.....	289	282-450.....	297	285-140.....	117, 309
281-050	288	282-451.....	297	285-147	117, 310
281-051.....	288	282-452.....	297	285-148	117, 310
281-052	288	283-060	289	285-170.....	117, 310
281-053.....	288	283-061	289	285-171.....	117, 310
281-054	288	283-062.....	289	285-172	117, 310
281-055	288	283-063.....	289	285-185	311
281-056	288	283-064.....	289	285-186	311
281-057.....	288	283-239	292	285-187	311
281-058	288	283-240	292	285-188	311
281-059	288	283-241.....	292	285-189.....	311
281-060.....	289	283-242	292	285-190	312
281-060DT.....	291	283-243.....	292	285-191	312
281-060TF	290	284-060	289	285-192.....	312
281-061.....	289	284-061.....	289	285-193	312
281-061DT	291	284-062.....	289	285-199.....	312
281-061TF	290	284-063.....	289	285-200.....	315
281-062	289	284-064.....	289	285-202	315
281-062DT	291	285-100	301	285-205.....	315
281-062TF.....	290	285-101	301	285-210.....	315
281-063	289	285-103.....	302, 479	285-215.....	315
281-063DT	291	285-104.....	302, 479	285-219.....	315
281-063TF.....	290	285-105.....	302, 479	285-220	315
281-064	289	285-106	302, 479	285-221.....	315
281-239.....	292	285-107.....	51, 302, 476	285-225.....	316, 368
281-240.....	292	285-108.....	51, 302, 476	285-227.....	316, 368
281-241	292	285-110	303	285-230	316, 368
281-242	292	285-111	303	285-233.....	316
281-243	292	285-112.....	303	285-235.....	316
281-405	294	285-114.....	303	285-236	316
281-406	294	285-115.....	303	285-240	316
281-407.....	294	285-116.....	116, 306	285-315	317, 368
281-415	294	285-117.....	116, 306	285-318.....	317
281-416	294	285-118.....	116, 306	285-320	317
281-417.....	294	285-119	116, 306	285-325.....	317
281-425.....	295	285-120.....	116, 309,	285-327.....	317
281-426.....	295	392	285-330	317
281-427.....	295	285-121.....	116, 309	285-331	317
281-450	297	285-122	116, 309	285-340.....	318
281-451	297	285-125	117, 309,	285-342	318



285-345	318, 613	702	286-106	122, 313
285-346	318, 613	285-452	326, 702	286-107	123, 314
285-350	318	285-453	326, 702	286-108	123, 314
285-351	318	285-454	326, 702	286-109	123, 314
285-352	318	285-455	326, 702	286-110	124, 314
285-353	318	285-456	326, 702	286-111	124, 314
285-355	318	285-457	326, 702	286-112	124, 314
285-357	318	285-458	326, 702	290-100	329, 590
285-360	319	285-460	326	290-101	329, 590
285-361	319	285-461	326	290-102	329, 590
285-362	319	285-462	326	290-120	329
285-365	319	285-463	326	290-122	329
285-366	319	285-464	326	290-125	329
285-367	319	285-465	326	290-145	333
285-368	319, 368	285-466	326	290-150	334
285-369	319	285-470	326	290-152	334
285-370	320	285-471	326	290-153	334
285-375	320	285-472	326	290-166	334
285-376	320	285-473	326	290-175	334
285-379	320, 368,	285-474	326	290-176	334
.....	612, 702	285-475	326	290-177	334
285-380	320, 368,	285-476	326	290-180	335
.....	612, 702	285-477	327	290-181	335
285-381	320	285-478	327	290-190	335
285-382	320	285-479	327	290-200	335
285-383	321	285-480	327, 586	290-210	336
285-384	321	285-482	327, 586	290-211	336
285-385	322	285-484	327, 586	290-212	336
285-386	322	285-490	327	290-213	336
285-388	322	285-492	327	290-214	336
285-389	322	285-495	327	290-215	337
285-390	322	285-496	327	290-216	337
285-391	323	285-497	327	290-217	337
285-394	323	285-498	327	290-218	337
285-395	323	285-499	327	290-220	336
285-396	323	285-530	328	290-221	337
285-397	323	285-531	328	290-222	337
285-398	324	285-533	328	290-225	337
285-405	324	285-534	328	290-226	337
285-411	324	285-540	328	290-227	337
285-412	324	285-541	328	290-230	337
285-420	324	285-542	328	290-231	337
285-421	324	285-543	328	290-232	337
285-422	324	285-544	328	290-233	337
285-425	325	285-545	328	290-234	337
285-430	325	285-546	328	290-235	337
285-431	325	285-547	328	290-236	337
285-433	325	285-550	328	290-237	337
285-434	325	285-551	328	290-238	337
285-435	325	286-100	121, 313	290-240	338
285-449	326, 586,	286-101	121, 313	290-241	338
.....	702	286-102	121, 313	290-242	338
285-450	326, 586,	286-103	121, 313	290-244	338
.....	702	286-104	121, 313	290-245	338
285-451	326, 586,	286-105	122, 313	290-246	338

290-251	338	295-220	15, 344	305-101	16, 369
290-260	339	295-221	15, 344	305-105	16, 369
290-261	339	295-295	432	305-106	16, 369
290-262	339	295-296	432	305-110	16, 369
290-263	339	300-100	350	305-120	16, 370
290-264	339	300-105	350	305-125	16, 370
290-265	339	300-115	350	305-130	16, 370
290-266	339	300-150	353	305-131	16, 370
290-267	339	300-151	353	305-135	16, 370
290-268	339	300-160	355	305-136	16, 370
290-280	339	300-165	355	305-140	16, 370, 787
290-281	339	300-166	355	305-141	16, 370, 787
290-282	339	300-175	353	305-145	16, 370
290-283	339	300-180	354	305-146	16, 370
290-284	339	300-183	354	305-200	401
290-285	339	300-185	355	305-205	401
290-286	339	300-190	358	305-210	401
290-287	339	300-192	358	305-215	401
290-288	339	300-194	358	305-220	401
290-300	340	300-200	350	305-230	402
290-305	340	300-202	350	305-231	402, 797
290-310	341	300-205	356	305-233	402, 797
290-315	341	300-210	352	305-294	402
290-320	341	300-211	352	305-295	402
290-321	341	300-213	352	305-296	402
290-322	341	300-225	351	305-297	402
290-323	341	300-230	359	305-300	404
290-324	341	300-231	359	305-305	404
290-325	341	300-235	359	305-306	404
290-330	341	300-238	359	305-308	405
290-331	341	300-250	356	305-309	405
290-332	341	300-251	356	305-310	405
290-333	341	300-253	357	305-320	405
290-334	341	300-260	357	305-325	405
290-335	341	300-261	357	305-330	405
295-110	342	300-262	357	305-332	405
295-111	342	300-300	362	305-337	405
295-112	342	300-302	362	305-350	405
295-113	342	300-304	362	305-351	405
295-114	342	300-305	362	305-352	405
295-115	342	300-310	362	305-355	406
295-116	342	300-315	363	305-359	406
295-117	342	300-316	363	305-360	406
295-130	343	300-400	367	305-362	406
295-131	343	300-402	367	305-363	406
295-132	343	300-405	367	305-365	406
295-140	343	300-407	367	305-366	406, 797
295-145	343	300-410	367	305-367	406
295-150	343	300-411	367	305-368	406
295-175	343	300-415	367	305-369	406, 797
295-200	15, 344	300-416	367	305-370	407
295-205	15, 344	300-425	367	305-372	407
295-210	15, 344	300-450	346	305-373	407
295-211	15, 344	300-451	346	305-380	408
295-215	15, 344	305-100	16, 369	305-385	409

305-386.....	409	310-305.....	377	310-392.....	424
305-388.....	409	310-306.....	377	310-393.....	424
305-389.....	409	310-307.....	377	310-394.....	424
305-390.....	409	310-308.....	377	310-395.....	424
305-395.....	409, 798	310-309.....	377	310-396.....	424
305-396.....	409, 798	310-310.....	19, 378	310-397.....	424
305-397.....	409	310-315.....	19, 378	310-398.....	424
305-398.....	410, 798	310-320.....	19, 378	310-399.....	424
305-399.....	410, 798	310-330.....	18, 376	310-400.....	424
305-400.....	410	310-332.....	19, 378	310-401.....	424
305-401.....	410	310-333.....	19, 378	310-402.....	424
305-402.....	410	310-334.....	19, 378	310-403.....	424
305-403.....	410	310-340.....	19, 379	310-404.....	424
305-405.....	410	310-341.....	19, 379	310-405.....	425, 819
305-406.....	410	310-342.....	19, 379	310-406.....	425, 821
305-407.....	410	310-343.....	19, 379	310-407.....	425, 821
305-408.....	410	310-344.....	19, 379	310-410.....	425
305-431.....	410	310-345.....	19, 379	310-411.....	425
305-441.....	411	310-349.....	18, 376	310-412.....	425
305-450.....	411, 453	310-350.....	20, 379,	310-413.....	425
305-451.....	411, 453	422	310-414.....	425
305-498.....	411	310-351.....	20, 379	310-415.....	425
305-499.....	411	310-352.....	20, 379,	310-416.....	425
305-500.....	411	422	310-420.....	346
305-501.....	411	310-353.....	20, 379,	310-424.....	346
310-103.....	421	422	310-430.....	427
310-105.....	421	310-354.....	20, 379	310-431.....	427
310-108.....	421	310-355.....	21, 381	310-432.....	427
310-110.....	421	310-356.....	21, 381	310-433.....	427
310-112.....	421	310-357.....	21, 381	310-436.....	427
310-140.....	347	310-358.....	21, 381	310-440.....	427
310-141.....	347	310-360.....	20, 380,	310-441.....	427
310-142.....	347	482	310-442.....	427
310-143.....	347	310-367.....	18, 376	310-445.....	427
310-144.....	347	310-368.....	18, 376	310-450.....	426
310-145.....	347	310-369.....	18, 376	310-451.....	426
310-150.....	346	310-370.....	18, 376	310-452.....	426
310-151.....	346	310-374.....	21, 381	310-453.....	426
310-152.....	346	310-375.....	18, 377	310-454.....	426
310-155.....	346	310-376.....	18, 377	310-455.....	426
310-190.....	453	310-377.....	422	310-456.....	426
310-191.....	453	310-378.....	423	310-457.....	426
310-192.....	453	310-379.....	423	310-458.....	426
310-193.....	453	310-380.....	422	310-459.....	426
310-200.....	442	310-381.....	422, 819	310-460.....	426
310-202.....	442	310-382.....	423	310-461.....	426
310-204.....	442	310-383.....	422, 423	310-462.....	426
310-214.....	449	310-384.....	423	310-465.....	426, 820
310-290.....	17, 375	310-385.....	422, 424	310-480.....	427
310-291.....	17, 375	310-386.....	424	310-481.....	427
310-292.....	17, 375	310-387.....	424	310-482.....	427
310-300.....	17, 375	310-388.....	424	310-485.....	428
310-302.....	17, 375	310-389.....	424	310-486.....	428
310-303.....	17, 375	310-390.....	424	310-487.....	428
310-304.....	18, 377	310-391.....	424	310-488.....	428



310-490.....	346	320-100.....	103, 397	320-171.....	486
310-491.....	346	320-101.....	103, 397	320-172.....	422, 486
310-492.....	346	320-102.....	103, 397	320-172ST.....	486
310-493.....	346	320-103.....	103, 397	320-173.....	486
310-494.....	346	320-104.....	103, 397	320-174.....	486
310-495.....	346	320-105.....	102, 396	320-175.....	486
310-500.....	347	320-106.....	102, 396	320-175ST.....	486
310-502.....	347	320-107.....	102, 396	320-177.....	486
310-505.....	347	320-108.....	102, 396,	320-178.....	486
310-506.....	347	797	320-179.....	485
310-507.....	347	320-109.....	102, 396,	320-180.....	448
310-508.....	347	797	320-182.....	448
310-520.....	428	320-110.....	102, 396	320-185.....	448
310-522.....	428	320-111.....	102, 396	320-187.....	448
310-528.....	387	320-111TI.....	495	320-190.....	448
310-530.....	429	320-112.....	102, 396	320-192.....	458
310-532.....	429	320-113.....	102, 396	320-193.....	458
310-533.....	429	320-113TI.....	498	320-194.....	458
310-535.....	21, 381	320-114.....	102, 396,	320-195.....	458
310-540.....	382	422	320-196.....	458
310-542.....	382	320-114TI.....	498	320-197.....	458
310-544.....	429	320-115.....	102, 396	320-198.....	458
310-545.....	429	320-115TI.....	498	320-199.....	465
310-547.....	429	320-116.....	103, 397	320-200.....	452
310-549.....	430	320-117.....	103, 397	320-205.....	452
310-550.....	430	320-118.....	103, 397	320-209.....	446
310-551.....	430	320-119.....	103, 397	320-210.....	446
310-570.....	430	320-120.....	482	320-211.....	446
310-575.....	431	320-122.....	483	320-212.....	446
310-576.....	431	320-125.....	482	320-213.....	446
310-580.....	431	320-127.....	483	320-214.....	446
311-350.....	20, 379	320-130.....	482	320-215.....	445
311-351.....	20, 379	320-132.....	483	320-216.....	445
311-352.....	20, 379	320-135.....	482	320-217.....	445
311-353.....	20, 379	320-137.....	483	320-218.....	451, 471
311-354.....	20, 379	320-140.....	483	320-220.....	451
320-050.....	102, 396	320-141.....	484	320-221.....	451
320-051.....	102, 396	320-142.....	483	320-222.....	451
320-052.....	102, 396	320-143.....	484	320-223.....	452
320-065.....	485	320-144.....	483	320-225.....	451
320-066.....	485	320-145.....	484	320-226.....	451
320-067.....	485	320-146.....	483	320-227.....	451
320-068.....	485	320-147.....	484	320-228.....	64, 403,
320-070.....	103, 397	320-148.....	483	447, 478
320-071.....	103, 397	320-150.....	484	320-229.....	64, 403,
320-072.....	103, 397	320-152.....	484	447, 478
320-073.....	103, 397	320-155.....	484	320-230.....	448
320-074.....	103, 397	320-157.....	484	320-231.....	448
320-080TI.....	498	320-160.....	484	320-233.....	450
320-081TI.....	498	320-162.....	484	320-234.....	450
320-082TI.....	498	320-165.....	484	320-235.....	450
320-083TI.....	495	320-167.....	484	320-236.....	450
320-084TI.....	495	320-168.....	485	320-238.....	449
320-085TI.....	495	320-169.....	485	320-239.....	449
320-099.....	102, 396	320-170.....	422, 486	320-240.....	449



320-241..... 449
 320-242 438
 320-243 438
 320-244 438
 320-245 437
 320-246 438
 320-247 439
 320-248 439
 320-249 439
 320-250 446
 320-255 446
 320-257 436
 320-258 436
 320-259 437
 320-260 447
 320-261 470
 320-262 452
 320-263 436
 320-264 437
 320-265 447, 467
 320-266 436
 320-267 437
 320-268 437
 320-269 437
 320-270 444
 320-272 444
 320-274 411
 320-275 444
 320-276 444
 320-277 444
 320-280 434
 320-282 434
 320-284 434
 320-286 434
 320-287 435
 320-288 434
 320-289 435
 320-290 435
 320-291 435
 320-292 435
 320-293 435
 320-294 435
 320-296 441
 320-297 441
 320-298 441
 320-300 445
 320-302 445
 320-304 445
 320-306 445
 320-310 452
 320-312 452
 320-314 452
 320-316 452
 320-320 440
 320-322 440

320-324 440
 320-326 440
 320-328 440
 320-335 441
 320-336 441
 320-337 441
 320-338 441
 320-339 441
 320-340 139
 320-341 139
 320-342 139
 320-343 139
 320-344 139
 320-345 139
 320-346 139
 320-347 139
 320-350 140
 320-351 140
 320-352 140
 320-353 140
 320-354 140
 320-355 140
 320-357 437
 320-360 443
 320-361 443
 320-362 443
 320-363 443
 320-370 443
 320-372 443
 320-375 442
 320-380 443
 320-381 443
 320-382 443
 320-383 443
 320-390 441
 320-391 441
 320-392 441
 320-395 450
 320-396 450
 320-397 449
 320-398 449
 320-399 449
 320-400 465
 320-401 465
 320-403 466
 320-405 466
 320-406 466
 320-410 466
 320-411 466
 320-412 466
 320-413 466
 320-414 466
 320-415 471
 320-416 459
 320-417 459

320-418 459
 320-420 473
 320-422 473
 320-425 473
 320-430 474
 320-431 474
 320-432 474
 320-433 475
 320-435 474
 320-436 474
 320-437 474
 320-438 434
 320-440 472
 320-441 472
 320-445 472
 320-446 472
 320-447 440
 320-448 440
 320-449 440
 320-450 459
 320-451 459
 320-452 459
 320-453 465
 320-454 465
 320-455 465
 320-456 465
 320-457 465
 320-460 458
 320-461 458
 320-462 458
 320-463 475
 320-464 475
 320-465 475
 320-466 475
 320-467 475
 320-470 467
 320-471 467
 320-472 444
 320-473 444
 320-474 467
 320-475 467
 320-476 467
 320-480 451
 320-481 451
 320-482 451
 320-483 442
 320-484 442
 320-485 442, 473
 320-486 442, 473
 320-487 471
 320-490 471
 320-494 438
 320-495 438
 320-500 469
 320-501 469

320-502.....	469	320-637.....	477	350-112.....	509
320-503.....	469	320-638.....	477	350-118.....	510
320-504.....	469	320-639.....	477	350-119.....	510
320-505.....	469	320-640.....	477	350-120.....	510
320-506.....	472	320-641.....	477	350-121.....	510
320-507.....	472	320-642.....	477	350-125.....	510
320-508.....	472	320-643.....	477	350-126.....	510
320-510.....	358	320-644.....	477	350-140.....	511
320-514.....	358	320-650.....	457, 477	350-142.....	511
320-515.....	358	320-651.....	457, 477	350-144.....	511
320-516.....	358	320-652.....	457, 477	350-149.....	511
320-517TI.....	351, 499	320-700TI.....	461, 488	350-150.....	511
320-518.....	351	320-701TI.....	461, 488	350-151.....	511
320-520.....	470	320-702TI.....	461, 488	350-152.....	511
320-525.....	470	320-703TI.....	462, 489	350-153.....	511
320-530.....	470	320-704TI.....	462, 489	350-155.....	512
320-535.....	470	320-705TI.....	463, 490	350-160.....	512
320-540.....	468	320-706TI.....	463, 490	350-210.....	512
320-540TI.....	468, 492	320-707TI.....	464, 491	350-250.....	512
320-542.....	468	320-708TI.....	461, 488	350-255.....	512
320-542TI.....	468, 492	320-709TI.....	462, 489	350-256.....	512
320-550.....	480	320-710TI.....	462, 489	350-260.....	512
320-555.....	480	320-711TI.....	463, 490	350-290.....	513
320-560.....	481	320-712TI.....	464, 491	350-292.....	513
320-562.....	481	320-713TI.....	464, 491	350-294.....	513
320-564.....	481	320-728TI.....	439, 492	350-300.....	514
320-566.....	481	320-800.....	460	350-301.....	514
320-568.....	481	320-801.....	460	350-302.....	514
320-570.....	481	320-802.....	460	350-303.....	514
320-572.....	481	320-803.....	460	350-304.....	514
320-600.....	459	320-804.....	460	350-305.....	514
320-601.....	459	320-810.....	460	350-310.....	514
320-602.....	459	320-811.....	460	350-320.....	514
320-603.....	459	320-812.....	460	350-321.....	514
320-604.....	475	320-813.....	460	350-322.....	515
320-610.....	474	320-814.....	460	350-325.....	515
320-611.....	474	325-140.....	137	350-330.....	515
320-612.....	474	325-141.....	137	350-340.....	516
320-615.....	479	325-142.....	138	350-341.....	516
320-616.....	479	325-143.....	138	350-344.....	516
320-617.....	479	325-144.....	138	350-345.....	516
320-618.....	479	325-150.....	134	350-347.....	516
320-620.....	478	325-151.....	134	350-348.....	516
320-621.....	478	350-090.....	508	350-349.....	516
320-622.....	478	350-092.....	508	350-350.....	517
320-625.....	479	350-093.....	508	350-351.....	422, 517
320-626.....	479	350-094.....	508	350-352.....	517
320-627.....	479	350-095.....	508	350-353.....	517
320-630.....	457, 477	350-096.....	508	350-354.....	517
320-631.....	457, 477	350-097.....	508	350-355.....	517
320-632.....	457, 477	350-098.....	509	350-357.....	517
320-633.....	457, 477	350-100.....	509	350-360.....	518, 630
320-634.....	457, 477	350-101.....	509	350-362.....	518
320-635.....	477	350-105.....	509	350-363.....	518
320-636.....	477	350-110.....	509	350-365.....	518

350-366	518	355-132	528	355-206	538
350-368	519	355-135	528	355-210	538
350-369	519	355-137	529	355-212	538
350-370	519, 630	355-138	529	355-214	539
350-371	519, 630	355-140	529	355-215	539
350-372	519	355-141	529	355-218	539
350-377	520	355-142	530	355-220	539
350-380	520	355-143	530	355-225	540
350-381	520	355-144	530	355-226	540
350-383	520	355-145	530	355-230	540
350-384	520	355-146	530	355-235	540
350-385	521	355-147	530	355-250	541
350-387	521	355-148	531	355-255	541
350-390	521	355-150	531	355-260	541
350-392	521	355-151	531	355-263	541
350-395	521	355-152	531	355-265	541
350-397	522	355-155	531	355-280	542
350-398	522	355-156	531	355-285	542
350-400	522	355-159	532	355-300	543
350-405	522	355-160	532	355-303	543
350-410	522	355-161	532	355-305	543
350-415	523	355-162	532	355-310	543
350-420	523	355-163	532	355-311	543
350-425	523	355-165	532	355-312	543
350-430	523	355-166	532	355-315	544
350-435	523	355-168	532	355-320	544
350-440	524	355-169	532	355-340	544
350-441	524	355-170	533	355-341	544
350-445	524	355-170TI	506, 534	355-350	545
355-090	118, 525	355-171	533	355-360	545
355-091	118, 525	355-171TI	506, 534	355-370	545
355-092	118, 525	355-172	533	355-375	545
355-095	118, 526	355-173	533	355-376	545
355-096	118, 526	355-174	533	355-377	545
355-097	118, 526	355-175	533	355-378	545
355-100	118, 525	355-175TI	506, 534	355-380	545
355-101	118, 525	355-177	535	355-400	546
355-102	118, 525	355-178	535	355-404	546, 676
355-110	118, 526	355-179	535	355-404NL	546, 676
355-111	118, 526	355-180	535	355-405	546, 676
355-112	118, 526	355-181	535	355-405NL	546, 676
355-115	526	355-182	535	355-406	546, 676
355-116	526	355-183	536	355-406NL	546, 676
355-117	527	355-184	535	355-407	546, 676
355-118	527	355-185	536	355-407NL	546, 676
355-119	527	355-187	536	355-408	546, 677
355-120	527	355-188	536	355-409	546, 677
355-121	527	355-189	536	355-410	546, 677
355-122	527	355-191	536	355-411	546, 677
355-123	527	355-192	536	355-412	547, 677
355-125	527	355-193	537	355-412NL	547, 677
355-126	527	355-200	537	355-413	547, 677
355-128	527	355-202	537	355-413NL	547, 677
355-130	528	355-203	537	355-415	547
355-131	528	355-205	538	355-416	547



355-430	547	360-126	24, 551, 658	360-199	557
355-432	547	360-127	24, 552,	360-200	557
355-434	547	659	360-201	557
355-436	547	360-128	24, 552,	360-202	557
355-450	548	659	360-203	557
355-451	548	360-130	25, 552,	360-205	558
355-452	548	659	360-206	558
355-453	548	360-131	25, 552,	360-215	558
355-460	548	659	360-220	558
355-462	548	360-134	25, 552,	360-225	558
355-464	548	659	360-234	558
355-466	548	360-135	25, 552,	360-250	558
355-470	548	659	360-251	559
355-472	548	360-138	25, 553, 659	360-253	559
355-475	548	360-139	25, 553, 659	360-255	559
359-100	22, 549,	360-140	25, 553, 659	360-260	559
.....	656	360-141	25, 553, 659	360-262	559
359-101	22, 549,	360-142	25, 553,	360-270	560
.....	656	660	360-271	560
360-090	22, 549,	360-143	25, 553,	360-272	560
.....	656	660	360-273	560
360-091	22, 549,	360-144	553	360-274	560
.....	656	360-145	553	360-275	560
360-092	22, 549,	360-146	553	360-276	560
.....	656	360-147	553	360-280	560
360-093	22, 549,	360-148	26, 554,	360-281	560
.....	656	660	360-282	560
360-094	22, 549,	360-149	26, 554,	360-283	560
.....	656	660	360-284	560
360-095	22, 549,	360-150	554	360-285	560
.....	656	360-151	26, 554	360-286	560
360-100	22, 549,	360-153	26, 554	360-287	560
.....	656	360-154	27, 555,	360-288	560
360-101	22, 549,	660	360-289	560
.....	656	360-155	27, 555,	360-290	560
360-102	23, 550,	660	360-291	560
.....	657	360-156	27, 555	360-300	560
360-103	23, 550,	360-157	26, 554	360-301	560
.....	657	360-158	555	360-302	560
360-104	23, 550,	360-159	555	360-305	561
.....	657	360-160	555	360-307	561
360-105	23, 550,	360-161	555	360-310	561
.....	657	360-165	556	360-315	561
360-110	23, 550,	360-170	556	360-316	561
.....	657	360-172	556	360-325	561
360-111	23, 550,	360-175	556	360-326	561
.....	657	360-180	556	360-330	562
360-115	23, 551, 657	360-181	556	360-331	562
360-117	23, 551, 658	360-190	556	360-502	562, 820
360-118	23, 551, 658	360-191	556	360-504	562, 820
360-120	24, 551, 658	360-192	557	360-512	562, 820
360-121	24, 551, 658	360-193	557	360-514	562, 820
360-122	24, 551, 658	360-195	27, 557	375-020	564
360-123	24, 551, 658	360-196	557	375-022	564
360-125	24, 551, 658	360-198	557	375-024	564



375-026	564	380-150	567	380-271	574
375-028	564	380-153	568	380-272	574
375-030	564	380-155	568	380-273	574
375-032	564	380-156	568	380-275	574
375-034	564	380-157	568	380-276	574
375-036	564	380-165	569	380-277	574
375-040	564	380-166	569	380-300	575
375-042	564	380-167	569	380-301	575
375-044	564	380-168	569	380-302	575
375-046	564	380-169	569	380-303	575
375-048	564	380-175	570	380-305	575
375-050	564	380-180	570	380-307	575
375-052	564	380-181	570	380-315	580
375-054	564	380-182	570	380-320	580
375-056	564	380-183	570	380-321	580
375-100	564	380-184	570	380-323	580
375-101	564	380-190	570	380-325	581
375-102	564	380-191	570	380-330	581
375-103	564	380-192	570	380-335	582
375-104	564	380-193	570	380-336	582
375-110	564	380-194	570	380-340	582
375-111	564	380-200	570	380-350	582
375-112	564	380-201	570	380-355	583
375-113	564	380-202	570	380-356	583
375-114	564	380-203	570	380-360	583
375-130	565	380-204	570	380-362	583
375-131	565	380-210	570	380-365	583
375-132	565	380-211	570	380-366	583
375-133	565	380-212	570	380-367	583
375-134	565	380-213	570	385-025	584
375-140	565	380-214	570	385-030	584
375-141	565	380-215	571	385-031	584
375-142	565	380-216	571	385-032	584
375-143	565	380-217	571	385-033	584
375-144	565	380-218	571	385-034	584
375-150	565	380-219	571	385-035	584
375-151	565	380-220	571	385-036	584
375-152	565	380-221	571	385-037	584
375-153	565	380-223	571	385-038	584
375-154	565	380-224	571	385-039	584
375-160	565	380-225	571	385-040	584
375-161	565	380-226	571	385-041	584
375-162	565	380-227	571	385-042	584
375-163	565	380-230	572	385-043	584
375-164	565	380-231	572	385-044	584
380-100	119, 566	380-232	572	385-045	584
380-105	119, 566	380-233	572	385-046	584
380-110	119, 566	380-235	573	385-047	584
380-140	566	380-236	573	385-048	584
380-141	566	380-237	573	385-049	584
380-143	567	380-238	573	385-050	585
380-145	567	380-239	573	385-051	585
380-146	567	380-242	573	385-052	585
380-147	567	380-244	574	385-054	585
380-149	567	380-270	574	385-055	585

385-056.....	585	385-317.....	593	400-135.....	601, 703
385-058.....	585	385-320.....	593	400-136.....	602, 703
385-060.....	585	385-321.....	593	400-140.....	602
385-062.....	585	385-326.....	593	400-141.....	602
385-080.....	586	385-327.....	593	400-142.....	602
385-082.....	586	385-330.....	594	400-143.....	602
385-084.....	586	385-335.....	594	400-144.....	602
385-100.....	587	385-340.....	594	400-145.....	602
385-102.....	587	385-345.....	594	400-146.....	602
385-104.....	587	385-346.....	594	400-150.....	119, 603
385-106.....	587	385-347.....	594	400-152.....	120, 603
385-108.....	587	385-348.....	594	400-155.....	120, 603
385-110.....	587	385-350.....	595	400-160.....	604
385-115.....	587	385-351.....	595	400-161.....	604
385-120.....	587	385-352.....	595	400-170.....	604
385-121.....	587	385-353.....	595	400-171.....	604
385-125.....	587	385-354.....	595	400-175.....	604
385-126.....	587	385-355.....	595	400-177.....	28, 605
385-127.....	587	385-356.....	595	400-180.....	28, 605,
385-130.....	587	385-360.....	596	703
385-140.....	588	385-361.....	596	400-185.....	606
385-142.....	588	385-362.....	596	400-187.....	606
385-144.....	588	385-370.....	596	400-200.....	607
385-146.....	588	385-371.....	596	400-220.....	607
385-148.....	588	385-380.....	596	400-222.....	607
385-200.....	588	385-382.....	597	400-223.....	607
385-202.....	588	385-384.....	597	400-225.....	607
385-204.....	588	385-386.....	597	400-226.....	607
385-206.....	588	385-388.....	597	400-230.....	608
385-210.....	588	385-390.....	598	400-234.....	608
385-211.....	588	385-392.....	598	400-235.....	608
385-212.....	588	385-400.....	598	400-236.....	608
385-220.....	588	385-401.....	598	400-237.....	608
385-221.....	588	385-402.....	598	400-240.....	609
385-223.....	589	385-430.....	599	400-241.....	609
385-224.....	589	385-440.....	599	400-242.....	609
385-240.....	589	385-500.....	599	400-243.....	609
385-242.....	589	385-505.....	599	400-245.....	609
385-245.....	589	385-506.....	599	400-247.....	609
385-246.....	589	400-100.....	600	400-250.....	609
385-250.....	589	400-101.....	600	400-253.....	610
385-252.....	589	400-102.....	600	400-255.....	610
385-257.....	590	400-105.....	600	400-257.....	610
385-258.....	590	400-110.....	600, 703	400-258.....	610
385-260.....	591	400-112.....	600	400-260.....	610
385-262.....	591	400-115.....	601	400-261.....	610
385-265.....	591	400-116.....	601	400-262.....	610
385-266.....	591	400-117.....	601	400-263.....	610
385-270.....	159, 591	400-120.....	601	400-264.....	610
385-280.....	592	400-121.....	601	400-265.....	610
385-285.....	592	400-122.....	601	400-269.....	611
385-305.....	592	400-130.....	601, 703	400-270.....	611
385-310.....	592	400-131.....	601, 703	400-271.....	611
385-315.....	592	400-132.....	601, 703	400-272.....	611
385-316.....	592	400-134.....	601, 703	400-273.....	611, 704



400-274 612
 400-275 612
 400-276 612
 400-277 613, 704
 400-278 613
 400-279 613
 400-280 614
 400-281 614
 400-282 614
 400-285 614
 400-286 615
 400-287 615
 400-288 615
 400-290 615
 400-292 615
 400-293 616
 400-294 616
 400-296 616
 400-297 616
 400-298 617
 400-299 617
 400-300 617
 400-301 617
 400-302 617
 400-303 617
 400-304 617
 400-305 617
 400-306 617
 400-307 618, 704
 400-308 618, 704
 400-320 618
 400-321 618
 400-322 618
 405-100 619
 405-105 619
 405-106 619
 405-108 619
 405-110 620
 405-111 620
 405-112 620
 405-115 621
 405-116 621
 405-118 621
 405-120 621
 405-122 622
 405-125 622
 405-130 622
 405-131 622
 405-150 623
 405-152 623
 405-153 623
 405-155 623
 405-180 623
 405-181 624
 405-182 624

405-183 624
 405-184 624
 405-186 624
 405-190 625
 405-192 625
 405-200 626
 405-201 626
 405-210 626
 405-225 626
 410-100 628
 410-101 628
 410-105 628
 410-106 628
 410-110 628
 410-111 628
 410-115 628
 410-116 628
 410-120 628
 410-121 628
 410-123 629
 410-125 629
 410-128 629
 410-130 629
 410-135 630
 410-136 630
 410-137 630
 410-140 630
 410-145 630
 410-146 630
 410-147 630
 410-150 631
 410-151 631
 410-152 631
 410-153 631
 410-154 631
 410-157 631
 410-160 631
 410-161 631
 410-163 631
 410-165 632
 410-166 632
 410-167 632
 410-170 632
 410-180 632
 410-182 632
 410-183 632
 410-185 633
 410-186 633
 410-187 633
 410-193 633
 410-194 633
 410-195 633
 410-196 633
 410-197 634
 410-198 634

410-199 634
 410-200 634
 410-201 634
 410-202 634
 410-203 634
 410-205 635
 410-207 635
 410-210 635
 410-211 635
 410-212 635
 410-215 636
 410-218 636
 410-220 159, 638
 410-225 158, 639
 410-226 158, 639
 410-230 159, 639
 410-235 639
 410-236 639
 410-237 639
 410-238 639
 410-265 642
 410-275 643
 410-276 643
 410-280 643
 410-281 643
 410-282 643
 410-283 643
 410-284 643
 410-286 643
 410-288 643
 410-290 643
 410-291 643
 410-292 643
 410-293 643
 410-295 643
 410-296 644
 410-297 644
 410-298 644
 410-300 644
 410-301 644
 410-302 644
 410-305 644
 410-306 644
 410-307 644
 410-308 644
 410-310 644
 410-312 645
 410-313 645
 410-314 645
 410-316 645
 410-317 645
 410-318 645
 410-319 646
 410-320 646
 410-321 646

410-322	646	420-135.....	691	430-162.....	700
410-323.....	646	420-136	691	430-163.....	700
410-324	646	420-138.....	691	430-164	700
410-325.....	646	420-139	691	430-200	700
410-326	646	420-140	692	430-201.....	700
410-327.....	646	420-141	692	430-202.....	700
410-328.....	646	420-145	692	430-210	700
410-329	646	420-147.....	692	430-211	700
410-330	646	420-148	692	430-212	700
410-332.....	647	420-150.....	693	430-220.....	701
410-333.....	647	420-155.....	693	430-221	701
410-335.....	647	420-160.....	693	430-222.....	701
410-340	647	420-161.....	693	430-225.....	701
410-345	647	420-170	694	430-240.....	701
410-346	647	420-171	694	430-241.....	701
410-347.....	647	420-172.....	694	430-242	701
410-348	647	420-173.....	694	430-245.....	701
410-349	647	420-175.....	695	440-110.....	705
415-100.....	29, 648	420-176.....	695	440-114	705
415-101.....	29, 648	420-177.....	695	440-118	705
415-102	29, 648	420-178.....	695	440-130	705
415-105	29, 648	420-179.....	695	440-134	705
415-110.....	29, 648	420-180.....	695	440-138.....	705
415-112	29, 648	420-181	695	440-140.....	705
415-114	29, 649	420-182.....	695	440-150.....	705
415-115	30, 649	420-184	696	440-154	705
415-116.....	30, 649	420-210	696	440-158	705
415-117	30, 649	430-102	698	440-160.....	706
415-118	30, 650	430-103	698	440-161	706
415-119.....	31, 650	430-104	698	440-162	706
415-120	31, 650	430-105	698	440-163.....	706
415-121.....	31, 650	430-107	698	440-164	706
415-123.....	31, 651	430-108	698	440-165	706
415-124	31, 651	430-109.....	698	440-166	706
415-125.....	32, 651	430-120.....	698	440-167.....	706
415-127.....	32, 651	430-121	698	440-170	707
415-130	32, 652	430-122.....	698	440-174	706
415-133.....	32, 652	430-126	698	440-178.....	706
415-140	33, 652	430-127.....	698	440-182	707
415-141.....	33, 652	430-128.....	698	440-184	706
415-145	33, 652	430-135.....	698	440-186	706
415-150	33, 653	430-136.....	698	440-200	707
415-152	33, 653	430-137	698	440-202	707
415-170	33, 653	430-140	699	440-204	707
415-172.....	33, 653	430-145.....	699	440-208	707
420-100.....	689	430-146	699	440-300	707
420-101.....	689	430-147.....	699	440-304	707
420-102	689	430-148.....	699	440-306	707
420-110.....	689	430-149	699	440-308	708
420-111.....	689	430-150	699	440-310	708
420-120	690	430-155.....	699	440-312	708
420-125.....	690	430-156	699	440-314	708
420-126	690	430-157.....	699	440-316	708
420-130	690	430-160	700	440-318	708
420-132.....	691	430-161	700	440-340	709



440-342.....	709	450-124.....	715	450-527.....	723
440-344.....	709	450-125.....	715	450-528.....	723
440-346.....	709	450-126.....	715	450-529.....	723
440-348.....	709	450-127.....	715	460-100.....	725
440-350.....	709	450-128.....	715	460-101.....	725
440-360.....	710	450-140.....	716	460-102.....	725
440-364.....	710	450-141.....	716	460-103.....	725
440-368.....	710	450-142.....	716	460-104.....	725
440-370.....	710	450-143.....	716	460-105.....	725
440-372.....	710	450-144.....	716	460-106.....	725
440-376.....	710	450-145.....	716	460-107.....	725
440-378.....	710	450-146.....	716	460-108.....	725
440-380.....	710	450-147.....	716	460-109.....	725
440-390.....	711	450-148.....	716	460-130.....	725
440-394.....	711	450-149.....	716	460-230.....	726
440-398.....	711	450-150.....	717	460-231.....	726
440-400.....	711	450-151.....	717	460-232.....	726
440-402.....	711	450-155.....	717	460-235.....	726
440-404.....	711	450-160.....	717	460-236.....	726
440-406.....	711	450-161.....	717	460-237.....	726
440-407.....	711	450-162.....	717	460-240.....	726
440-408.....	711	450-163.....	717	460-245.....	727
440-410.....	711	450-164.....	717	460-246.....	727
440-412.....	711	450-165.....	717	460-247.....	727
440-416.....	711	450-166.....	717	460-248.....	727
440-420.....	711	450-167.....	717	460-249.....	727
440-430.....	712	450-200.....	718	460-400.....	727
440-510.....	712, 822	450-201.....	718	460-401.....	727
440-530.....	711	450-205.....	718	460-405.....	727
440-532.....	706, 707, 708, 710	450-210.....	718	460-420.....	728
440-700.....	712	450-220.....	718	460-425.....	728
440-720.....	712	450-222.....	718	460-430.....	728
440-730.....	712	450-300.....	719	460-433.....	728
440-740.....	712	450-301.....	719	460-435.....	728
440-770.....	712	450-310.....	480, 719	460-440.....	729
449-310.....	480, 719	450-311.....	719	460-600.....	729
450-090.....	642, 714	450-399.....	719	460-601.....	729
450-091.....	642, 714	450-400.....	719	460-602.....	729
450-092.....	642, 714	450-401.....	719	460-603.....	729
450-093.....	642, 714	450-407.....	720	460-604.....	729
450-100.....	714	450-412.....	720	460-605.....	729
450-101.....	714	450-415.....	720	460-606.....	729
450-102.....	714	450-417.....	720	460-607.....	729
450-103.....	714	450-420.....	720	460-608.....	729
450-105.....	714	450-450.....	34, 721	460-609.....	729
450-106.....	714	450-455.....	34, 721	460-610.....	729
450-110.....	715	450-457.....	34, 721	460-611.....	729
450-111.....	715	450-460.....	34, 721	460-620.....	730
450-112.....	715	450-500.....	723	460-621.....	730
450-113.....	715	450-501.....	723	460-622.....	730
450-120.....	715	450-505.....	723	460-623.....	730
450-121.....	715	450-510.....	723	460-624.....	730
450-122.....	715	450-524.....	723	460-625.....	730
450-123.....	715	450-525.....	723	460-626.....	730
		450-526.....	723	460-627.....	730

460-628	730	475-310.....	752	475-557	760
460-629	730	475-320	752	475-558	760
460-630	730	475-330	753	475-559	760
460-631	730	475-331	753	475-560.....	760
460-640.....	730	475-333.....	753	475-561.....	760
460-641.....	730	475-335.....	753	475-562.....	760
460-642.....	730	475-337.....	753	475-563.....	760
460-643.....	730	475-340.....	753	475-564.....	760
460-644.....	730	475-342.....	753	475-634.....	760
460-645.....	730	475-415.....	755	475-635.....	760
460-646.....	730	475-416.....	755	475-636.....	760
460-647.....	730	475-425.....	756	475-637.....	760
460-648.....	730	475-426.....	756	500-100.....	762
460-649.....	730	475-427.....	756	500-105.....	762
460-650.....	730	475-428.....	756	500-110.....	762
460-651.....	730	475-429.....	167, 764	500-115.....	762
475-100.....	746	475-440.....	756	500-120.....	762
475-105.....	746	475-470.....	757	500-125.....	762
475-110.....	746	475-471.....	757	500-130.....	762
475-120.....	746	475-472.....	757	500-135.....	762
475-125.....	747	475-473.....	757	500-137.....	763
475-127.....	747	475-480.....	757	500-138.....	763
475-130.....	747	475-485.....	757	500-139.....	763
475-140.....	747	475-490.....	757	500-141.....	763
475-142.....	747	475-491.....	757	500-142.....	763
475-150.....	748	475-492.....	757	500-143.....	763
475-152.....	748	475-493.....	757	500-145.....	763
475-155.....	748	475-494.....	757	500-146.....	763
475-160.....	748	475-500.....	453, 758	500-147.....	763
475-162.....	748	475-505.....	454, 758	500-148.....	763
475-165.....	748	475-510.....	454, 759	500-160.....	764
475-175.....	748	475-520.....	454, 759	500-162.....	764
475-176.....	748	475-525.....	454, 759	500-163.....	764
475-177.....	748	475-535.....	760	500-164.....	764
475-180.....	749	475-536.....	760	500-166.....	764
475-181.....	749	475-537.....	760	500-167.....	764
475-182.....	749	475-538.....	760	500-168.....	764
475-185.....	749	475-539.....	760	500-170.....	765
475-186.....	749	475-540.....	760	500-171.....	765
475-187.....	749	475-541.....	760	500-172.....	765
475-212.....	749	475-542.....	760	500-173.....	765
475-214.....	749	475-543.....	760	500-174.....	765
475-222.....	749	475-544.....	760	500-175.....	765
475-224.....	749	475-545.....	760	500-180.....	765
475-232.....	750	475-546.....	760	500-181.....	765
475-234.....	750	475-547.....	760	500-182.....	765
475-242.....	750	475-548.....	760	500-184.....	766
475-244.....	750	475-549.....	760	500-185.....	766
475-252.....	750	475-550.....	760	500-186.....	766
475-254.....	750	475-551.....	760	500-190.....	766
475-262.....	750	475-552.....	760	500-191.....	766
475-264.....	750	475-553.....	760	500-192.....	766
475-305.....	751	475-554.....	760	500-195.....	766
475-306.....	751	475-555.....	760	500-197.....	766
475-307.....	751	475-556.....	760	500-200.....	767



500-201.....	767	500-337.....	771	505-144.....	774
500-202.....	767	500-340.....	772	505-145.....	774
500-203.....	767	500-400.....	767	505-146.....	774
500-204.....	767	500-401.....	767	505-150.....	774
500-205.....	767	500-402.....	767	505-160.....	775
500-206.....	767	500-403.....	767	505-162.....	775
500-207.....	767	500-404.....	767	505-163.....	775
500-208.....	767	500-405.....	767	505-170.....	775
500-209.....	767	500-406.....	767	505-175.....	775
500-215.....	767	500-407.....	767	505-200.....	776
500-230.....	768	500-408.....	767	505-205.....	776
500-232.....	768	500-409.....	767	505-206.....	776
500-233.....	768	500-410.....	767	505-210.....	776
500-234.....	768	500-411.....	767	505-215.....	776
500-235.....	768	500-412.....	767	505-220.....	777
500-236.....	768	500-413.....	767	505-225.....	777
500-237.....	768	500-414.....	767	505-230.....	777
500-240.....	768	500-415.....	767	505-231.....	777
500-241.....	768	500-416.....	767	505-232.....	777
500-242.....	768	500-417.....	767	505-240.....	778
500-243.....	768	500-418.....	767	505-241.....	778
500-244.....	768	500-419.....	767	505-245.....	778
500-245.....	768	500-420.....	767	505-246.....	778
500-246.....	768	500-421.....	767	505-250.....	778
500-247.....	768	500-422.....	767	505-252.....	778
500-248.....	768	500-423.....	767	505-255.....	778
500-250.....	768	500-424.....	767	505-260.....	779
500-252.....	768	500-425.....	767	505-261.....	779
500-256.....	769	500-426.....	767	505-262.....	779
500-258.....	769	500-427.....	767	505-263.....	779
500-265.....	769	500-428.....	767	505-264.....	779
500-270.....	769	500-429.....	767	505-265.....	40, 779
500-295.....	770	500-430.....	767	505-266.....	40, 779
500-298.....	770	500-431.....	767	505-267.....	40, 779
500-299.....	770	500-432.....	767	505-268.....	40, 779
500-300.....	770	500-433.....	767	505-269.....	40, 779
500-301.....	770	500-434.....	767	505-270.....	40, 779
500-302.....	770	500-435.....	767	505-271.....	40, 779
500-303.....	770	500-436.....	767	505-272.....	40, 779
500-304.....	770	500-437.....	767	505-273.....	40, 779
500-305.....	770	500-438.....	767	505-280.....	780
500-306.....	770	500-439.....	767	505-281.....	780
500-310.....	770	500-440.....	767	505-282.....	780
500-311.....	770	500-441.....	767	505-283.....	780
500-312.....	770	500-442.....	767	505-284.....	780
500-313.....	770	500-443.....	767	505-285.....	780
500-314.....	770	505-100.....	772	505-286.....	780
500-315.....	770	505-105.....	772	505-287.....	780
500-316.....	770	505-110.....	772	505-288.....	780
500-320.....	771	505-115.....	772	505-289.....	780
500-325.....	771	505-116.....	773	505-290.....	780
500-330.....	771	505-120.....	773	505-291.....	780
500-331.....	771	505-125.....	773	505-292.....	780
500-335.....	771	505-135.....	773	505-293.....	780
500-336.....	771	505-140.....	774	505-294.....	780

505-295.....	780	730-100B.....	803	730-313.....	806
505-300.....	780	730-101.....	802	730-313B.....	807
505-305.....	780	730-101B.....	803	730-320.....	806, 808,
505-310.....	780	730-102.....	802	809
505-312.....	781	730-102B.....	803	730-321.....	806
505-313.....	781	730-103.....	802	730-322.....	806
505-314.....	781	730-103B.....	803	730-323.....	806
505-315.....	781	730-110.....	802	730-324.....	806
505-316.....	781	730-110B.....	803	730-325.....	806
505-317.....	781	730-111.....	802	740-100.....	803
505-318.....	781	730-111B.....	803	740-101.....	803
505-319.....	781	730-112.....	802	740-102.....	803
505-320.....	781	730-112B.....	803	740-200.....	805
505-321.....	782	730-113.....	802	740-201.....	805
505-322.....	782	730-113B.....	803	740-202.....	805
505-325.....	782	730-120.....	802, 804,		
505-326.....	782	809	740-300.....	807
505-327.....	783	730-121.....	802	740-301.....	807
505-328.....	783	730-122.....	802	740-302.....	807
505-330.....	781	730-123.....	802	750-100.....	803
505-335.....	783	730-124.....	802	750-101.....	803
505-340.....	783	730-125.....	802	750-102.....	803
505-345.....	783	730-200.....	804	750-200.....	805
505-360.....	784	730-200B.....	805	750-201.....	805
505-365.....	784	730-201.....	804	750-202.....	805
505-400.....	35, 787	730-201B.....	805	750-300.....	807
505-401.....	35, 787	730-202.....	804	750-301.....	807
505-402.....	35, 787	730-202B.....	805	750-302.....	807
505-405.....	35, 787	730-210.....	804	760-400.....	822
505-406.....	35, 787	730-210B.....	805	760-405.....	822
505-407.....	35, 787	730-211.....	804	760-410.....	822
505-435.....	35, 788	730-211B.....	805	760-415.....	822
505-436.....	35, 788	730-212.....	804	760-420.....	822
510-100.....	789	730-212B.....	805	760-425.....	822
510-120.....	789	730-220.....	804, 806,		
510-130.....	789	809	760-430.....	822
510-140.....	789	730-221.....	804	760-435.....	822
510-145.....	790	730-222.....	804	760-440.....	822
510-155.....	790	730-223.....	804	760-445.....	822
510-165.....	790	730-224.....	804	760-450.....	822
510-200.....	790	730-225.....	804	760-455.....	822
510-205.....	790	730-300.....	806	760-460.....	822
510-220.....	790	730-300B.....	807	760-465.....	822
510-225.....	791	730-301.....	806	760-470.....	822
510-235.....	791	730-301B.....	807	760-475.....	822
510-245.....	791	730-302.....	806	760-480.....	822
510-260.....	791	730-302B.....	807	760-485.....	822
510-265.....	791	730-303.....	806	760-490.....	822
510-275.....	792	730-303B.....	807	760-495.....	822
510-290.....	792	730-310.....	806	775-100.....	810
510-300.....	792	730-310B.....	807	775-101.....	810
510-330.....	792	730-311.....	806	775-102.....	810
600-618.....	821	730-311B.....	807	775-103.....	810
600-620.....	821	730-312.....	806	775-104.....	810
730-100.....	802	730-312B.....	807	775-105.....	810
				775-120.....	810
				775-121.....	810



775-122	810	835-541	737	840-215	250
775-123	810	835-542	737	840-220	250
775-124	810	835-543	737	840-225	250
775-125	810	835-545	737	840-230	251
775-130	810	835-546	737	840-300	251
775-131	810	835-550	738	840-305	251
775-132	810	835-551	738	840-310	251
775-133	810	835-552	738	840-315	251
775-134	810	835-555	738	840-320	252
775-135	810	835-560	738	840-325	252
775-200	809	835-561	738	840-330	252
775-300	809	836-100	739	840-335	252
775-400	809	836-105	740	840-340	252
790-010	808, 818	836-110	740	840-345	253
835-100	732	836-115	741	840-350	253
835-105	732	836-120	740	840-355	253
835-110	732	836-125	740	840-360	253
835-115	732	836-130	741	840-365	253
835-120	732	836-135	741	840-370	253
835-125	732	836-140	741	841-110	253
835-130	733	836-145	739	842-100	253
835-135	733	836-146	739	842-105	253
835-140	733	836-150	741	842-110	253
835-145	733	836-155	739	842-500	254
835-150	733	836-160	739	842-505	254
835-155	733	836-165	739	842-600	254
835-160	733	836-170	739	842-605	254
835-165	733	836-175	740	842-610	254
835-170	734	836-180	740	842-615	254
835-175	734	836-185	741	842-620	254
835-180	734	836-190	742		
835-185	734	836-195	741		
835-190	734	836-200	741		
835-195	734	836-205	740		
835-200	735	836-210	740		
835-205	735	837-100	743		
835-210	735	837-105	743		
835-215	735	837-110	743		
835-220	735	837-115	743		
835-235	735	837-120	743		
835-240	735	838-200	743		
835-300	735	838-210	744		
835-305	736	838-215	744		
835-310	736	838-220	744		
835-400	736	838-250	744		
835-405	736	838-270	744		
835-410	736	838-500	744		
835-500	736	840-100	250		
835-505	737	840-110	250		
835-510	736	840-120	250		
835-515	736	840-130	250		
835-520	737	840-140	250		
835-525	737	840-200	250		
835-530	737	840-205	250		
835-540	737	840-210	250		

Integra™
Alphabetical
Index

300X Band Pusher 744

Abdominal

Retractor 169, 185-191
Scissors 6-7, 788
Adair Breast Clamp 131

Adapters

Vascular 423
Adenoid Curette 699-700
Adenoid Punch 700-701
Adson Bipolar Forceps 121, 313
Adson Cannula, Open End 327
Adson Cerebellar Retractor 182, 331
Adson Dressing Forceps 104-105, 117,
..... 304-305, 309,
..... 683-684
Adson Drill Guide 343
Adson Dura Hook 316, 368
Adson Ganglion Scissors 15, 344
Adson Hemostatic Forceps 302, 479
Adson Hypophyseal Forceps 117, 310
Adson Needle Pulling Forceps 95, 688
Adson Periosteal Elevator 318
Adson Rongeur 215
Adson Suction Tube 327
Adson Tissue Forceps 104-105,
..... 304-305,
..... 683-684
Agricola Lacrimal Sac Retractor 511
Air Injection Cannula 562
Alderdyce Elevator and Dissector 320
Alderkreutz Tissue Forceps 109
Alexander Periosteotome 367
Alfonso Eye Speculum 509
Allen Intestinal Clamp 133

Alligators

Cup Forceps 587
Forceps 567-568,
..... 587-588
Allis Atraumatic Tissue Forceps 127
Allis Tissue Forceps 54, 126-127
Allis-Adair Tissue Forceps 128
Allison Lung Retractor 346
Allis-Willauer Tissue Forceps 402, 797
Allport Incus Hook 572
Alm Retractor 178, 639
Aluminum Hand Immobilizer, 4/Box 211
Amalgam Carrier 743
Anastomosis Clamp 473
Anastomosis Partial Occlusion Clamp 469
Anderson-Adson Retractor 329
Anderson-Neivert Osteotome 643
Andrew Mastoid Chisel 574

Andrew Mastoid Gouge 574
Andrew Tongue Depressor 717
Andrews-Pynchon Suction Tube 148, 724
Anis Needle Holder 548
Ankeney Sternal Retractor 355

Anoscopes

Rectal 748
Anthony Suction Tube 585

Antrum

Cannula 608
Curette 617, 704, 711
Needle 607
Trocar 607
Apical Dental Elevator 736

Applicators

Cotton 592

Approximators

Sternal 359
Arruga Capsule Forceps 545

Artery

Clamp 145, 302, 403,
..... 404, 457, 796
Forceps 51, 57-62, 64,
..... 404-406, 410,
..... 678, 681,
..... 785-786, 795,
..... 797-798
Scissors 20, 49, 380
Asch Septum Forceps 623
Aspirating Syringe 744
Aufranc Cobra Retractor 209
Aufricht Nasal Retractor 635
Aufricht Nasal Scissors 32, 651
Aufricht Rasp 692
Auvard Vaginal Specula 763
Babcock Tissue Forceps 54, 130, 796
Baby Doyen Intestinal Clamp 133
Backhaus Towel Forceps 65
Badgley Retractor 338
Bahnon Aortic Clamp 436
Bailey Aortic Valve Rongeur 428
Bailey Forceps 457, 477
Bailey Gigli Saw Guide 244
Bailey Rib Contractor 359
Bailey-Finochietto Rib Spreader 351, 499
Bailey-Gibbon Rib Contractor 359
Bainbridge Forceps 63-64, 403, 447,
..... 456, 478
Bakes Common Duct Dilator 141
Balfour Abdominal Retractor 185-191

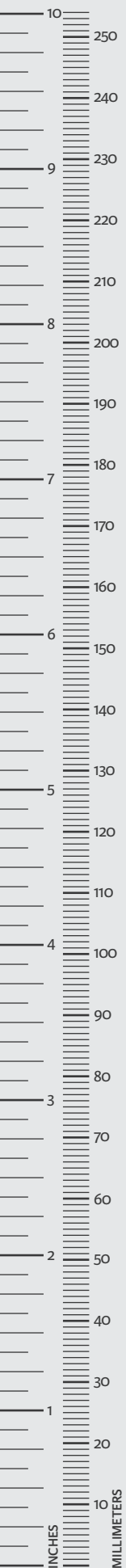

Balfour Center Blade 187, 190
 Balfour Fourth Blade Attachment..... 191
 Balfour Wire Lateral Blade 186, 189
 Ball Nerve Hook 429
 Ballenger Septum Elevator 612
 Ballenger Swivel Knife..... 610
 Ballenger Tonsil Seizing Forceps 718
 Ballenger V-Shaped Chisel 609
 Bane Rongeur 214, 577
 Bariatric Instrument Case..... 821

Bariatrics

Clamp 796
 Forceps 795-798
 Needle Holders 799
 Scissors 794
 Suction Tubes 800
 Retractors 800
 Barnhill Adenoid Curette 699
 Baron Suction Tube 327, 586
 Barr Anal Retractor 746
 Barr Fistula Probe..... 753
 Barraquer Blade Breaker 513
 Barraquer Cilia Forceps 541
 Barraquer Cyclodialysis Spatula 522
 Barraquer Eye Speculua 508
 Barraquer Iris Spatula..... 520, 522
 Barraquer Needle Holder..... 547
 Barraquer-Dewecker Iris Scissors 558
 Barrett Placenta Forceps 790
 Barrett Tenaculum Forceps..... 776
 Barron Knife Handle 72
 Baumgarten Needle Holder 77, 82, 670,
 672-673
 Bayonet Needle Holder..... 80, 671
 Beall-Morris Aorta Clamp..... 437
 Beasley-Babcock Tissue Forceps 107, 685
 Bechert Nucleus Rotator 522
 Beck Aorta Clamp 441
 Beck Miniature Aorta Clamp 471
 Beck Vessel Clamp 467
 Becker Septum Scissors..... 32, 652
 Beckman Nasal Speculum..... 600
 Beckman Thyroid Retractor 182, 332
 Beckman-Adson Retractor 183, 332
 Beckman-Eaton Retractor 183, 332
 Bell Pattern Bone File 736
 Bellucci Alligator Scissors..... 588
 Bellucci Cannula only..... 585
 Bellucci Micro Ear Scissors..... 568
 Bellucci Suction Tube..... 585
 Bellucci Tip Only 585
 Bellucci-Wullstein Retractor 591
 Bengolea Forceps..... 406

Bennett Tibia Retractors 207
 Benson Pylorus Spreader..... 131
 Berke Ptosis Clamp..... 545
 Berry Sternal Needle Holder 93, 420
 Bethune Rib Shears 362
 Bethune-Coryllos Rib Shears 363
 Beyer Rongeur 216, 579
 Bill Traction Handle 792
 Billeau Ear Loop 571
 Billroth Tumor Forceps 784

Biopsy

Forceps 749-750,
 772-774
 Needle 151

Bipolar

Forceps 121-124, 311-314
 Cord 124, 312, 314
 Bipolar Forceps (Reusable) 311-312
 Bipolar Forceps (Disposable)..... 124, 313-314
 Bishop-Harmon Iris Forceps 527

Blade

Breaker 513
 Remover 69

Blades

Balfour Retractor 186-187, 189-190
 Center 187, 190
 Cloward Cervical..... 339
 Hibbs 337
 Laminectomy 338
 Meyerding 337
 Mouth Gag 642, 714-715,
 717
 Neuro/Spine 336-339
 Scoville..... 336-337
 Taylor 338
 Tongue 642, 714-715,
 717
 Wire Lateral 186, 189
 Wire Saw 244
 Urethrotome 755
 Blair Palate Hook..... 632
 Blake Gall Stone Forceps..... 142
 Blakesley Forceps..... 705
 Blakesley Septum Forceps 621
 Blakesley Suction Forceps 706-707
 Blakesley Thru-Cutting Forceps 706
 Blount Knee Retractor..... 207
 Blount Retractor 207
 Blumenthal Rongeur 212, 576
 Bodenhammer Rectal Speculum..... 746

Boettcher Tonsil Scissors..... 34, 721
 Boies Nasal Fracture Elevator..... 613
 Bonaccolto Utility Forceps 536

Bone

Awl..... 235
 Caliper..... 262
 Chisel 229, 235, 254,
 736
 Clamp..... 202, 204-206
 Curette 224-225, 735
 Elevator 240
 File 245, 736
 Forceps..... 205-206,
 220-221, 364,
 458, 566
 Gouge..... 230-231, 235,
 250
 Hook..... 225
 Mallet 238-239
 Osteotome 229-230,
 234-237
 Racks 228, 817
 Raspatory..... 243, 245
 Reduction Forceps..... 202-203
 Retractor 208-209,
 211, 245
 Rongeur 212-219, 221,
 364-366,
 576-579
 Saw 244
 Skid..... 208
 Splitting Forceps..... 625
 Tamp..... 239

Bonn Iris Forceps 530
 Bonn Iris Hook 516
 Bonn Suture Forceps 530
 Bonney Needle Pulling Forceps..... 95, 393
 Bonney Tissue Forceps..... 109, 687
 Botvin Iris Forceps 527
 Boucheron Ear Specula..... 564
 Bowman Lacrimal Probe..... 560
 Boyd Tonsil Scissors 34, 721
 Boyes-Goodfellow Hook 225
 Boys-Allis Tissue Forceps..... 128
 Bozeman Uterine Dressing Forceps 775
 Bracken Fixation Forceps..... 529
 Brain Dressing and Tissue Forceps..... 116, 306
 Brand Tendon Pulling Forceps 249
 Braun Episiotomy Scissors 35, 788
 Braun Tenaculum Forceps 776
 Bridge Forceps..... 405
 Brigham Tissue Forceps 108
 Brinkerhoff Rectal Specula..... 748
 Broli-Adson Forceps 106, 264, 305,

..... 385
 Brophy Gum and Suture Scissors 33, 652
 Brown Applicator..... 582
 Brown Dissecting Scissors 33, 653
 Brown Needle Holder 76, 669
 Brown Tissue Forceps 106-107, 385,
 685
 Brown-Adson Needle Pulling Forceps 95, 688
 Brown-Adson Tissue Forceps..... 107, 685
 Bruening Nasal Snare..... 606
 Bruening Septum Forceps 622
 Bruns Bone Curette 222-224
 Bruns Curette Rack..... 227, 816
 Bruns Plaster Shears..... 200
 Buck Applicator..... 582
 Buck Ear Curettes 570
 Buck Myringotomy Knife..... 574
 Buck Neurological Hammer..... 151
 Buie Fistula Probe 753
 Buie Pile Clamp 752
 Buie Rectal Suction Tube..... 752

Bulldog

Clamp..... 482-486
 Bulldog Clamp Applying Forceps 427
 Bunge Evisceration Spoon 524
 Bunnell Hand Drill 255
 Bunnell Tendon Passer..... 249
 Bunt Forceps Holder..... 814
 Burch Fixation Pick..... 520
 Burford Rib Spreader 353-354
 Burford-Finochietto Rib Spreader 354
 Burke Cervical Biopsy Punch..... 774
 Burnisher, Double Ended..... 733

Burrs

Enlarging..... 343

Cables See Cords

Calipers

Eye 558-559
 Femur 262
 Marking 559
 Calman Carotid Closure Clamp 470
 Campbell Nerve Retractor..... 325

Cannulas

Acorn..... 777
 Antrum..... 608
 Closed end..... 327
 Eye 561
 Heparin 423
 Injection..... 562
 Sinus..... 607



- Suction..... 711
 Trocar and Cannula 712
 Cannulated Pin Cutter 259
 Caplan Nasal Bone Scissors 30, 650
 Capsule Fragment and Clot Forceps 545
- Carb-Bite**
 Needle Holders..... 52-53, 81-93,
 256, 413-420,
 547, 672-675,
 677, 799
 Pulling Forceps..... 94-96,
 393-395, 688
 Rasp..... 694-695
- Carb-Edge**
 Scissors 36-40, 52, 344,
 369, 371,
 373-374, 550,
 552, 661-663,
 722, 772, 779,
 788, 794
- Cardio-Grip**
 Bulldog Clamps..... 482-486
 Intestinal Clamps..... 137-138
 Hysterectomy Forceps 782-783
 Tissue Forceps..... 104-105, 309,
 387, 392,
 396-397,
 Vascular Clamps..... 434-486
 Carmalt Forceps..... 409
 Carmalt Splinter Forceps 125
 Carotid Clamp 469
 Carroll Small Bone Holding Clamp 248
 Carroll Tendon Retriever..... 248
- Cartilage**
 Clamp 246-248
 Crusher 626
 Goniometer 249
 Scissors 14, 246
- Cases** Also See Trays
 Coronary Bypass 819
 Dilator 425-426,
 819-820
 Eye 562, 820
 Instrument..... 821
 Vein Stripper..... 819
 Castanares Face Lift Scissors 44, 665
 Castaneda Anastomosis Clamp 474
 Castaneda Multi-Purpose Clamp 459
 Castaneda Partial Occlusion Clamp..... 475
 Castaneda Sternal Retractor 358
- Castaneda Suture Tag Forceps..... 479
- Castroviejo**
 Blade Breaker 513
 Caliper 558-559
 Corneal Scissors 556-557
 Corneo-Scleral Suture Forceps 531
 Dilator 561
 Colibri Forceps 531
 Cyclodialysis Spatula..... 521
 Fixation Forceps..... 532
 Forceps..... 531-532, 536
 Iris Scissors..... 556
 Lacrimal Dilator 561
 Marking Caliper 559
 Micro Stardust Needle Holder..... 281
 Needle Holder..... 92, 270, 281,
 419, 546-547,
 676-677
 Scissors 556-557
 Spatula 521
 Specula 510
 Suture Tying Forceps..... 532, 536
 Synechia Spatula 522
- Catheter**
 Female..... 760
 Forceps..... 150
 Guide (Wire Mandrin) 149
 Cement Spatula 734
- Cervical**
 Retractor..... 339
 Rongeur 290-291
 Spreader..... 334, 340
 Chandler Elevator 240
 Chandler Iris Forceps..... 537
 Cheek Retractor 716
 Chelsea-Eaton Anal Specula 747
 Cherry Supreceliac Clamp 435
 Children's Hospital Retractor 173
 Children's Hospital Spatula 328
- Chisels**
 Bone 229-230, 235,
 254
 Dental..... 736
 Footplate..... 594
 Lacrimal Sac 609
 Mastoid..... 574
 Plastic Surgery 610, 643-644
 V-Shaped 609
 Church Vascular Scissors..... 18, 377
 Cicherelli Rongeur 215, 578
 Cinelli Lower Lateral Scissors 29, 648

Cinelli Osteotome 644
 Citelli Rongeur 575

Clamps

Anastomosis..... 133, 473-474
 Aortic Aneurysm..... 434-439, 441,
 444, 471
 Appendage..... 442
 Artery 145, 302,
 403-404, 452,
 457, 480, 796
 Auricle..... 443, 453
 AV Fistula 458
 Bone Holding 202, 204-206,
 248
 Breast 131
 Bronchus..... 411, 453
 Bulldog 448, 482-486
 Carotid 470
 Cartilage 246, 248
 Closure..... 469-470
 Coarctation..... 448-449,
 465-466
 Columella 696
 Femoral-Popiteal 451
 Hypogastric..... 435
 Hysterectomy..... 783
 Iliac 438
 Internal Carotid..... 470
 Intestinal..... 133-137, 139-140
 Kidney 454, 759
 Meniscus 247
 Microsurgery..... 270
 Minature 458
 Multi-Purpose..... 444-445, 452,
 458-460, 467
 Muscle 146
 Neonatal..... 469
 Ossicle Holding 599
 Partial Occlusion..... 441, 469, 475
 Patent Ductus 450, 465
 Pediatric..... 459, 461-462,
 466, 472,
 488-491
 Pedicle..... 454, 759
 Penis..... 790
 Pile..... 752
 Profunda 451, 471
 Ptosis..... 545
 Pylorus 137
 Right Angle..... 144, 403, 452
 Suture..... 479
 Tangential Occlusion 440
 Thoracic..... 144, 406, 410
 Vascular..... 435, 439,

..... 442-447,
 467-468,
 471-473, 492
 Vasectomy Ring 757
 Vena Cava 441-442, 481
 Vessel 453-454, 467,
 758
 Clayman Iris Hook 518
 Clayman Lens Forceps..... 542

Clip

Forceps..... 97
 Skin..... 97
 Snap-On 810
 Cloward Blade Retractor 334
 Cloward Cervical Retractor 339
 Cloward Cervical Spreader 334
 Cloward Interbody Spreader..... 341
 Cloward Lamina Spreader 341
 Cloward Style Ball Pean Hammer 239
 Cloward Style Elevator 323
 Cloward Style Rongeur 296
 Cloward Vertebra Spreader 340
 Coakley Antrum Curette 617
 Coakley Antrum Trocar 607
 Coakley Curette 704
 Coakley Sinus Curette..... 618
 Cobb Bone Curette 224
 Cobb Type Instrument Rack..... 228, 817
 Cobb-Type Spinal Elevator 233
 Cobb-Type Spinal Gouge..... 232
 Cogswell A "Spade" Elevator 737
 Cohan Miniature Needle Holder 548
 Cohen Acorn Cannula..... 777
 Collar and Crown Scissors..... 253
 College Pliers..... 101
 Coller Artery Forceps..... 64, 404
 Coller-Crile Forceps..... 58, 680
 Collier Needle Holder 77, 670
 Collins Tissue Forceps..... 129, 401
 Collins Tongue Seizing Forceps 150
 Colver Tonsil Knife..... 720
 Colver Tonsil Seizing Forceps..... 718
 Comedone Extractor 154
 Cone Ring Curette 226

Containers

Accessories..... 808-810
 Full Size 806-808
 Lid..... 809
 One Half Size..... 802-804
 Three-Quarter Size..... 804-806
 Converse Alar Retractor 635
 Converse Blade Retractor 639
 Converse Button End Bistoury..... 629

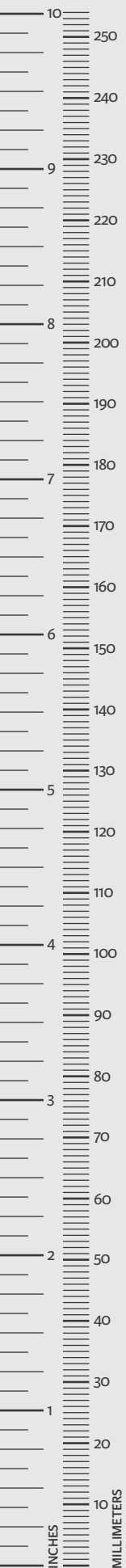

- Converse Chisel 644
 Converse Nasal Retractor 636
 Converse Needle Holder 76, 669
 Converse Osteotome 643, 647
 Converse Periosteal Elevator 614
 Converse Rasp 690
 Converse Skin Hook 632
 Cook Eye Speculum 509
 Cooley Aorta Clamp 438
 Cooley Aortic Aneurysm Clamp 434
 Cooley Bulldog Clamp 483-484
 Cooley Coarctation Clamp 449, 466
 Cooley Iliac Clamp 438
 Cooley Intracardiac Needle Holder 91, 415
 Cooley Multi-Purpose Clamp 444, 459, 467
 Cooley Needle Holder 91
 Cooley Neonatal Vascular Clamp 469
 Cooley Partial Occlusion Clamp 441
 Cooley Patent Ductus Clamp 450, 465
 Cooley Pediatric Clamp 466
 Cooley Pediatric Multi-Purpose Clamp .. 459
 Cooley Pediatric Vascular Clamp 472
 Cooley Peripheral Vascular Clamp 446
 Cooley Scissors 16, 370
 Cooley Sternal Retractor 357-358
 Cooley Suction Tube 421
 Cooley Tangential Occlusion Clamp 440
 Cooley Tissue Forceps 103, 397
 Cooley Valve Retractors 346
 Cooley Vascular Clamp 472
 Cooley Vascular Dilator 425
 Cooley Vena Cava Catheter Clamp 481
 Cooley-Baumgarten Sternal Wire Twister
 93, 256, 420
 Cooley-Derra Anastomosis Clamp 474
 Cooley-Satinsky Clamp 471
 Copper Head Mallet 646
- Cords**
 Bipolar 124, 312, 314
- Coronary Artery**
 Bypass Hook 429
 Bypass Kit 422
 Forceps 406
 Nerve Hook 429
 Scissors 20-21, 49,
 379-381
 Spring Retractor 429
 Corwin Knife Handle 73
 Corwin Wire Twister 256
 Cottle Alar Retractor 635
 Cottle Biting Forceps 625
 Cottle Cartilage Crusher 626
 Cottle Chisel 643
 Cottle Columella Clamp 696
 Cottle Dorsal Scissors 30, 46, 649, 668
 Cottle Elevator 613
 Cottle Knife 629
 Cottle Knife Guide and Retractor 633
 Cottle Mallet 647
 Cottle Osteotome 647
 Cottle Rasp 690
 Cottle Retractor 634
 Cottle Septum Elevator 613, 704
 Cottle Septum Scissors 31, 650
 Cottle Septum Speculum 602, 703
 Cottle Single Prong Tenaculum 632
 Cottle Skin Elevator 614
 Cottle Skin Hook 630
 Cottle-Joseph Double Hook 631
 Cottle-Kazanjian Nasal Cutting Forceps 625
 Cottle-McKenty Elevator 611
 Coupland Suction Tube 149
 Covered Instrument Trays 811
 Crafoord (Coller) Artery Forceps 406
 Crafoord Coarctation Clamps 449
 Craig Vertebral Biopsy Set 300
 Crane Pick Elevator 737
 Crawford Aortic Retractor 347
 Crawford-Cooley Graft Tunneler 430
 Crego Elevator 240
 Crile Artery Forceps 57
 Crile Ganglion Knife and Dissector 321
 Crile Retractor 164
 Crile-Wood Needle Holder 78, 85, 412-413,
 671, 675, 799
 Cryer Elevator 737
 Culler Iris Spatula 522
- Cups**
 Iodine 815
 Measure 815
- Curettes**
 Adenoid 698-701
 Antrum 617, 704, 711
 Bone 222-225, 251,
 735, 816
 Capsule Polisher 514
 Chalazion 514
 Dental 250, 735
 Dermal 155
 Disc 225
 Ear 570-571
 Elevator 616
 Endaural 571
 Endocervical Biopsy 771, 772
 Endometrial Biopsy 771
 Ethmoid 617

Middle Ear	593, 598	Day Ear Hook.....	572
Rhoton-Type.....	277, 501	Dean Rongeur	214, 578
Ring	226	Dean Tonsil Knife.....	720
Sinus.....	618	Dean Tonsil Scissors.....	34, 721
Spinal	224	Deaver Pediatric Retractor	170
Spinal Fusion.....	223, 226	Deaver Retractor	171-172, 800
Uterine	770	Deaver Scissors.....	4-5
Uterine Biopsy	771	DeBakey Aorta Clamp	437
Curette Excavator	250	DeBakey Aortic Aneurysm Clamp	434
Cusco Vaginal Specula.....	763	DeBakey Aortic Exclusion Clamp	447
Cushing Bipolar Forceps.....	122, 311-313	DeBakey Bulldog Clamp	448, 484
Cushing Decompression Retractor	324	DeBakey Coarctation Clamp	448, 465
Cushing Dressing Forceps	111-112,	DeBakey Dilator Case.....	426, 820
.....	306-307, 389,	DeBakey Dissecting Forceps	410
.....	391	DeBakey Endarterectomy Scissors.....	18, 376
Cushing Dura Hook.....	315	DeBakey Femoral Bypass Tunneler	431
Cushing Elevator.....	320-322, 324	DeBakey Forceps.....	495, 498
Cushing Gasserian Ganglion Hook	316	DeBakey Heparin Cannula.....	423
Cushing Needle Pulling Forceps.....	95, 113, 307,	DeBakey Multi-Purpose Clamp	445, 452, 458
.....	390, 688	DeBakey Needle Holder.....	89, 416
Cushing Perforator Drill.....	343	DeBakey Needle Pulling Forceps	95, 393-394
Cushing Pituitary Rongeur	294	DeBakey Patent Ductus Clamp	450, 465
Cushing Rongeur	215	DeBakey Peripheral Vascular Clamp	446-447, 467
Cushing Spatula.....	328	DeBakey Tangential Occlusion Clamp....	440
Cushing Tissue Forceps	112-113,	DeBakey Tissue Forceps.....	102-103,
.....	306-308,	396-397, 797
.....	389-391, 495,	DeBakey Vascular Dilator.....	426
.....	504, 687	DeBakey Vascular Scissors	19, 379
Cushing Vein Retractor	164, 800	DeBakey-Bahnson Clamp.....	444
Cushing-Brown Tissue Forceps	114, 308, 391,	DeBakey-Bainbridge Clamp	64,447, 478
.....	687	DeBakey-Collier Artery Forceps.....	406, 797
Cut Snare Wire	723	DeBakey-Diethrich Tissue Forceps	102, 396
		DeBakey-Dietrich Artery Forceps	498
		DeBakey-Potts Vascular Scissors.....	19, 378
Cuticle		DeBakey-Semb Ligature Carrier	411
Nipper	156	DeBakey-Vascular Clamp.....	444
Scissors	156	Decker Rongeur	303
		Decker Scissors.....	303
Cutters		Deep Arteriotomy Spring Retractor	429
Bone	220	Deep Perforated Pan.....	812
Nail	252	Deep Rake Retractor.....	210
Pin.....	257, 259	Delee Obstetrical Forceps	790
Ring	154	Delee Universal Retractor.....	766
Wire	258	DeMartel Vascular Scissors	17, 375
Dale Femoral-Popliteal Clamp	451	Demartel-Wolfson Clamp Holder	136
Dale Thoracic Rongeur	219, 366	Demartel-Wolfson Clamp	137
Dandy Nerve Hook	316, 368	Demartel-Wolfson Closing Forceps	136
Dandy Scalp Forceps	301	Demos Tibial Artery Clamp	452
Dandy Trigeminal Scissors	15, 344	Denhardt Mouth Gag.....	744
Dardik Multi-Purpose Clamp	460	Dennis Anastomosis Clamp	133
Dardik Vascular Tunneler	431	Dennis Carotid Clamp.....	470
Darling Popliteal Retractor	195, 349	Dennis Micro Forceps	285, 399
Davidson Scalpula Retractor	346	Dennis Micro Ring Forceps	285, 400, 498
Davis Mouth Gag.....	715	Dennis Micro Scissors.....	265, 382
Davis Retractor.....	159, 639		
Davis Spatula.....	328		

Dental

Amalgam Carrier.....	743
Band Pusher	744
Bone File	735
Curette	251, 735
Elevator	737-738
Excavator	250, 254
Extraction Forceps.....	739-742
Filling Instrument.....	734
Picks	405
Plastic Filling	734
Plugger.....	733
Retainer.....	744
Retractor	744
Rongeur	743
Scissors	253
Wax Carver	733
Wax Spatula.....	734
Derf Needle Holder.....	76, 82, 669, 672
Derlacki Ossicle Holding Clamp.....	599

Dermal

Extractor	154
Nipper	155-156, 253
Punch	155
Scissors	156
Splitter	156
Derra Anastomosis Clamp.....	474
Derra Partial Occlusion Clamp.....	475
D'Errico Dressing Forceps.....	117, 310
D'Errico Nerve Retractor.....	325
D'Errico Perforator Drill	343
Deschamps Ligature Carrier	97, 642
Desjardin Gall Stone Forceps	142
Desmarres Chalazion Forceps.....	543
Desmarres Lid Retractor	511
Desmarres Valve Retractor	346

Diagnostic

Hammer	151
Pin Wheel	151
Diamond Pin Cutter.....	257
Diethrich Aorta Clamp.....	438
Diethrich Bulldog Clamp	486
Diethrich Circumflex Artery Scissors.....	20, 380
Diethrich Coronary Artery Bypass Kit	422
Diethrich Coronary Artery Scissors.....	20, 49, 379-380
Diethrich Coronary Bypass (Case Only)..	819
Diethrich Needle Holder	89, 416
Diethrich Right Angle Clamp	144, 403
Diethrich-Potts Peripheral Vascular Scissors	21, 381
Diffenbach Serrefines Forceps.....	63

Dilators

Common Duct	141
Lacrimal	560-561
Mitral Valve.....	428
Tracheal.....	727
Uterine.....	767-768
Vascular.....	424-426
Dingman Cartilage Clamp.....	247
Dingman Mouth Gag	642, 714
Dingman Otoabrader	693
Dingman Tongue Blade	642, 714
Dingman Wire Passer	642
Dingman Zygoma Elevator.....	615

Dissecting

Scissors	6, 17, 31, 33, 375,
.....	650, 653

Dissectors

Elevator	615
Endarterectomy	428
Intima	427
Knife	321
Neuro/Spine.....	317-320, 368
Rhoton-Type.....	275, 500
Tonsil Knife.....	720
Dix Foreign Body Spud.....	514
Dorsal Scissors.....	29, 649
Dorsey Dura Separator.....	317
Double Action Wire Cutter.....	258
Douglass Cilia Forceps	541
Doyen Abdominal Scissors.....	6
Doyen Intestinal Clamp	133-134
Doyen Rasp.....	367
Doyen Retractor.....	165
Doyen Tumor Screw	784
Doyen Vaginal Retractor	765

Dressing

Forceps.....	100, 104-108,
.....	111-112, 116-120,
.....	304-307,
.....	309-310,
.....	388-389,
.....	391, 525,
.....	683-684, 686,
.....	723, 725, 775,
.....	795

Drills

Hand.....	255
Neurosurgical.....	342
Perforated	343
Duncan Endometrial Biopsy Curette	771
Dunning Elevator and Curette	616



Duplay Tenaculum Forceps 776
 Dura Hook 315
 Duval Lung Forceps 401

Ear

Applicator 582
 Caliper 594
 Chisel 594, 609
 Curette 571, 598
 Elevator 581, 596,
 610-611, 615
 Forceps 119, 537,
 566-567,
 588-589,
 619, 621
 Gouge 609
 Hook 572, 592
 Knife 573, 597-598
 Loop 571
 Mirror 592
 Needle 593
 Pick 592, 595-596
 Retractor 159, 591
 Rongeur 212, 576
 Snare 570
 Speculum 565
 Syringe 583
 Eastman Vaginal Retractor 764
 Echlin Rongeur 218, 366
 Edna Towel Forceps 67
 Elliott Obstetrical Forceps 791

Elevators

Ball End 611, 704
 Bone 240-241
 Curette 616
 Dental 736-737
 Dissector 615
 Ear and Nose 580-581,
 610-612, 615
 Hook 632
 Middle Ear 596
 Nasal Fracture 613
 Neuro 320-324, 368,
 702
 Neuro/Spine 320, 322
 Periosteal 240, 242,
 318-319, 580,
 613-614
 Plastic Surgery 613
 Podiatry 251
 Rhoton-Type 275, 500
 Septal 611
 Septum 612-614, 704
 Septum Suction 616

Skin 614
 Spinal 233
 T-Handle 738
 Zygoma 615-616
 Elsberg Cannula, 3-Hole Closed End 327
 Elsching Fixation Forceps 528
 Emesis Basin 815
 Emmett Uterine Tenaculum Hook 779
 Endarterectomy Scissors 18, 48, 376

Endural

Retractor 591
 Enucleation Scissors 26, 554
 Eppendorfer Biopsy Forceps 773
 Epstein Spinal Fusion Curette 226
 Esmarch Plaster Shears 200
 Evans Tissue Forceps 110, 388
 Eve Tonsil Snare 723
 Ewald (Hudson) Dressing Forceps 106
 Example Clamp 470

Excavator

Dental 250, 254
 Double Ended 732

Explorer

Double Ended 732
 Single Ended 732

Extractors

Comedone 154

Eye

Caliper 559
 Cannula 561
 Curette 514
 Dilator 560
 Forceps 118, 312, 506,
 525-530,
 533-536,
 538-539,
 541-542,
 544-545
 Hook 516-517
 Knife 512
 Loop 523
 Needle Holder 546
 Nucleus Rotator 522
 Probe 515, 506-561
 Scissors 22-25, 40, 549,
 551-554,
 557-558,
 656-657, 659,
 663
 Utility Scissors 24, 552, 659

- Spatula 521
 Speculum..... 508-510
 Spoon 524
 Trabeculotome..... 561
 Eye and Plastic Surgery Case..... 562, 820
 Fansler (Ives) Rectal Speculum 747
 Fansler Operating Speculum 747
 Farabeuf Raspatory..... 243
 Farabeuf Retractor 162
 Farabeuf-Lambotte Bone Holding Clamp
 204
 Farr Style Spring Retractor 180
 Farrell Applicator..... 582
 Farrior Ear Specula..... 564
 Faulkner Antrum Curette 617
 Favaloro Coronary Scissors 21, 49, 381
 Favaloro-Morse Sternal Retractor 357
 Fehland Intestinal Clamp..... 135
 Feilchenfeld Splinter Forceps..... 125
 Fell Needle Holder 86, 412
 Female Catheter..... 760
 Ferguson Abdominal Scissors..... 7, 788
 Ferguson Angiotribe..... 63
 Ferguson Gall Stone Scoop 141
 Ferris-Smith Fragment Forceps..... 623
 Ferris-Smith Needle Pulling Forceps..... 96, 394
 Ferris-Smith Rongeur..... 293, 299
 Ferris-Smith Tissue Forceps 108, 686
 Fine Tying Forceps 540
 Finger Goniometer 249
 Finger Rake Retractor..... 160, 638
 Finger Ring Cutter 154
 Finochietto Needle Holder..... 89, 416
 Finochietto Rib Spreader 350-351
 Fisher Tonsil Knife..... 720
 Fixation Hook..... 516
 Flash Autoclaving Pan 812
 Flat Nose Plier 261
 Flat Tip Scissors 9, 375, 654
 Fletcher Polyp Forceps 775
 Fletcher Sponge Forceps 75
 Flexible Shaft Retractor 157
 Flush Wire Cutter..... 258
 Foerster Sponge Holding Forceps..... 74-75, 795
 Fomon Chisel 644
 Fomon Dorsal Scissors..... 30, 46, 649, 668
 Fomon Lateral Scissors 46, 668
 Fomon Lower Lateral Scissors 29, 648
 Fomon Rasp 690-691
 Fomon Retractor 634
 Fomon Saber Back Scissors..... 31, 651
- Forceps**
- Alligator Ear..... 567, 587-588
 Applying..... 97, 135, 427
- Artery 51, 57-62, 64,
 404-406, 410,
 678, 681,
 785-786, 795,
 797-798
 Bead Type 298
 Biopsy..... 749-750,
 772-774
 Bipolar 121-124, 311-314
 Biposy..... 773
 Biting..... 625
 Bone 205-206,
 220-221, 364,
 458, 566
 Bone Cutting 220-221, 364
 Bone Holding 206
 Bone Splitting 625
 Braiding..... 249
 Capsule 545
 Cardio-Grip 309, 392
 Catheter 150
 Chalazion..... 543-544
 Cilia..... 541
 Clip 97
 Clip Applying..... 97
 Closing..... 136
 Colibri..... 531-532
 Corneal..... 536, 538
 Corneo-Scleral 531
 Coronary Tissue 387
 Crimper 587
 Cup 726
 Disc..... 298
 Discectomy..... 303
 Dissecting..... 410, 432
 Dressing 100, 104-108,
 111-112, 116-120,
 304-307,
 309-310,
 388-389, 391,
 525, 683-684,
 686, 723, 725,
 775, 795
 Ear..... 119, 537,
 566-567,
 588-589,
 619, 621
 Elevating..... 769
 Entropium..... 544
 Extraction 739-742
 Eye 118, 312, 506,
 526-530,
 533-536,
 538-539,
 541-542,

..... 544-545
 Fixation 528-529, 532
 Foreign Body 537
 Fragment 545
 Frontal Sinus 708
 Gall Duct 142, 407
 Gall Stone 142
 Gallbladder 144
 Grasping 726, 751
 Hemostatic 55-64, 146, 302,
 403, 447,
 456-457, 477,
 479, 680-681,
 754
 Holder 814
 Hypophyseal 117, 310
 Hysterectomy 780-783
 Intestinal 134, 795
 Iris 526-527, 530,
 537
 Kidney Stone 757
 Lens 542
 Ligamentum Flavum 247
 Lung 401
 Micro 265, 285, 382,
 399-400, 503
 Micro Corneal 539
 Micro Ring 285, 498
 Microsurgical 116, 264, 267,
 270, 398-400,
 503, 588-589
 Middle Ear 587-588
 Mixer 54, 143,
 407-409, 456,
 682, 798
 Mosquito 50-51, 55-56,
 301-302, 402,
 476, 678-680
 Muscle Recession 545
 Nasal 119-120,
 603-604,
 620-621,
 624-625, 705,
 707
 Nasal Cutting 625, 707
 Nasal Dressing 119-120,
 603-604
 Obstetrical 790-792
 Occluding 68-69, 481
 Ochsner 51, 679
 Pean 51, 132, 679
 Pediatric 705
 Petit-Point 50-54
 Phalangeal 248
 Placenta 789-790

Plaque 109, 387
 Polyp 619, 775
 Pulling 95-96, 113, 249,
 252, 256, 307,
 390, 393-395,
 688
 Puncturing 789
 Reduction 202-203
 Retrieving 248
 Rhoton-Type 264, 278, 398
 Ring 503
 Scalp 301
 Septum 621-624
 Serrefines 63
 Sinus Endoscopy 707
 Splinter 125
 Sponge Holding 74-75, 795
 Spreading 537
 Stardust 279-286, 493,
 496-497,
 502-505,
 Suction 706-708
 Superior Rectus 545
 Suture 264, 398, 479,
 530-532,
 535-537,
 539-540
 Tenaculum 776-777
 Thoracic 109-110, 387,
 402, 404-405,
 407-409, 456
 Thru-Cutting 706
 Tissue 54, 100-115,
 117-118, 126-130,
 304-309,
 385-391,
 396-397,
 401-402, 495,
 498, 504,
 681-687,
 796-797
 Tongue Seizing 150
 Tonsil 480, 718-719
 Towel 65-67
 Traction 146
 Tube Occluding 68-69
 Tumor 784
 Turbinate 619
 Uterine Artery 783
 Uterine Polyp 775
 Uterine Vulsellum 778
 Utility 530, 535-536
 Vascular 95, 102-103,
 109, 264, 305,
 385, 393-394,

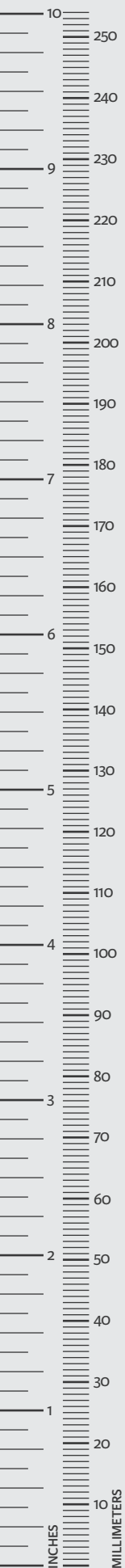

.....	396-397, 402,
.....	406, 410,
.....	456-458,
.....	476-477, 495,
.....	498, 797
Vascular Tissue	102-103,
.....	396-397, 797
Vulsellum	778
Wire Closure.....	589
Ford-Deaver Retractor	170
Foreign Body Spud	515
Fox Dermal Curette.....	155
Frames	
Mouth Gag	715
Retractor	336
Francis Chalazion Forceps	544
Francis Foreign Body Spud	514
Frazier (Schmeden) Dura Scissors.....	15, 344
Frazier Dura Hook.....	315
Frazier Dura Separator	317
Frazier Suction Tube.....	326-327, 586,
.....	702
Freeman Rhytidectomy Scissors.....	45, 667
Freeman-Gorney Face Lift Scissors	44, 666
Freeman-Kaye Face Lift Scissors.....	45, 667
Freer Chisel.....	610
Freer Elevator	320, 368, 702
Freer Septum Elevator.....	612
Freer Septum Knife.....	609-610
Friedman Rongeur	212
Frontal Ostium Seeker	711
Gardner Bone Chisel	736
Garland Hysterectomy Forceps	781
Garrett Dilator Case.....	425, 819
Garrett Dilator Holder	425, 822
Garrett Vascular Dilator	424
Garrett Vascular Retractor	195, 349
Gass Retinal Detachment Hook	519
Gelfoam Press.....	599
Gelpi Perineal Retractor	178-179, 640
Gemini Artery Clamp.....	145, 302, 403,
.....	457, 796
General Needle Pulling Forceps.....	96
Gerald Bipolar Forceps	312
Gerald Dressing Forceps	116-117, 309, 392
Gerald Forceps (Cardio-Grip)	309, 392, 504
Gerald Needle Pulling Forceps.....	96, 393
Gerald Stardust Forceps (Titanium)	504
Gerald Tissue Forceps	117, 309, 392,
.....	504
Gigli Saw Handle	244
Gigli Wire Saw Blade	244
Gill Corneal Knife.....	512

Gill Iris Forceps.....	527
Gillies Bone and Zygoma Hook	616
Gillies Skin Hook.....	632
Gillies Tissue Forceps	108, 686
Gillies Zygoma Elevator	616
Gills-Welsh Curette Capsule Polisher	514
Gills-Welsh Lens Loop	523
Gills-Welsh Vannas Scissors.....	558
Gil-Vernet Renal Sinus Retractor	757
Giraffe Frontal Sinus Forceps	708
Girard Corneo-Scleral Forceps	531
Glabella Rasp.....	696
Glassman Anterior Resection Clamp	138
Glassman Intestinal Clamp	137
Glover Auricular Appendage Clamp	442
Glover Bulldog Clamp.....	482-483
Glover Clamp.....	443
Glover Coarctation Clamp.....	449
Glover Patent Ductus Clamp.....	450
Gluck Rib Shears.....	362
Goelet Retractor	163
Goldman Displacer Septum Elevator.....	614
Goldman Dorsal or Septum Scissors	30, 649
Goldman Knife Guide and Retractors	633
Goldman Nasal Scissors	31, 651
Goldman Single Hook.....	631
Goldstein Lacrimal Sac Retractor.....	511
Gordon Uterine Vulsellum Forceps	778
Gorney Plastic Surgery Scissors	44, 666
Gorney Platysma Scissors.....	45, 667
Gorney Septum Suction Elevator.....	616
Gorney Turbinate Scissors.....	32, 652
Gosset Retractor	184
Gouges	
Bone	231
Hand.....	250
Hump	645
Lacrimal Sac	609
Mastoid.....	574
Spinal	232
Gradle Cilia Forceps.....	541
Gradle Stitch Scissors	27, 555
Graduated Measure.....	815
Graham Dura Hook	315
Grant Aortic Aneurysm Clamp.....	437
Graves Vaginal Specula	762
Green Fixation Forceps	529
Green Strabismus Hook.....	517
Green Thyroid Retractor	163
Gregory Bulldog Clamp	485
Gregory Miniature Vascular Clamp	458
Gregory Profunda Clamp.....	451, 471
Gregory Stay Suture Clamp.....	479
Grooved Director	153

Gross Ear Hook and Spoon 572
 Gruber Ear Specula..... 565
 Gruenwald Nasal Dressing Forceps..... 120, 603
 Gruenwald Nasal Forceps 620

Guides
 Catheter 149
 Drill 343
 Needle..... 789
 Saw 244
 Guilford Scissors..... 592
 Guthrie Fixation Hook 519
 Guthrie Hook 630
 Haight Rib Spreader 352
 Haight-Finocchio Rib Spreader 352
 Hajek-Koffler Punch 709
 Halle Elevator 615
 Halsey Needle Holder 78, 84, 671, 674
 Halstead Mosquito Forceps 55-56, 679-680

Hammers
 Ball Pean..... 239
 Intranasal 647
 Neurological..... 151
 Percussion 151
 Hanahan Extraction Forceps 742

Hand
 Chisel 254
 Drill 255
 Gouge..... 250
 Lead 211
 Osteotome 236
 Retractor 159, 161-174,
 208, 210,
 637-639,
 764, 800

Handles
 Knife 70-73
 Lifting..... 811
 Saw 244
 Traction 792
 Hank Uterine Dilator 768
 Hardy Bipolar Forceps 123-124, 314
 Hardy Sella Punch..... 293
 Harken Auricle Clamp 443, 453
 Harkin Rib Spreader 355
 Harms Suture Tying Forceps 535, 536
 Harms Trabeculotome 561
 Harrington Mixer Forceps 409, 798
 Harrington Splanchnic Retractor 169
 Harrington-Pemberton Retractor 169
 Hartman Alligator Ear Forceps..... 567-568
 Hartman Biopsy Forceps..... 773

Hartman Ear Dressing Forceps 566
 Hartman Ear Specula 565
 Hartman Mosquito Forceps 56, 680
 Hartman Nasal Dressing Forceps 604
 Hartman Nasal Speculum 601, 703
 Hartman Rongeur 213, 577
 Hartman (Meltzer) Adenoid Punch 700
 Hartman-Herzfeld Alligator Ear Forceps 567
 Hartmann Tuning Fork 569
 Hausmann Clamp 139-140
 Haverfield-Scoville Retractor Frame 336
 Hayes Hand Retractor 208
 Heaney Hysterectomy Forceps 780, 782
 Heaney Hysterectomy Retractor 766
 Heaney Needle Holder 80, 91, 799
 Heaney Uterine Biopsy Curette 771
 Heaney-Ballentine Hysterectomy Forceps
 781
 Heaney-Rezek Hysterectomy Forceps 781
 Heaney-Simon Hysterectomy Retractor 766
 Heath Chalazion Forceps..... 543
 Heath Suture Scissors 13, 98
 Heavy Duty Locking Plier 261
 Heavy Duty Needle Nose Locking Plier.. 262
 Hegar Uterine Dilator 767
 Hegar-Baumgartner Needle Holder 77, 83, 670, 673
 Hegenbarth Clip Applying Forceps 97
 Heidbrink Root-Tip Pick 738
 Heiss Artery Forceps..... 405
 Heiss Automatic Skin Retractor..... 178, 640

Hemostats
 Forceps..... 55-64, 146, 302,
 403, 447,
 456-457, 477,
 479, 680-681,
 754
 Halstead Mosquito..... 55-56, 679-680
 Tracheal 729
 Vasesctomy..... 757
 Henly Retractor 194-195, 348
 Henly Vacular Clamp 452
 Henner Elevator 581
 Hennig Cast Spreader 201
 Henrotin Uterine Vulsellum Forceps..... 778
 Heparin Flushing Needle..... 423
 Hercules Plaster Shears 200
 Hercules Supercutter 257
 Herrick Kidney Clamp 454, 759
 Hexagonal Handle Osteotome 646
 Hibbs Blade 337
 Hibbs Chisel 229
 Hibbs Gouge 230
 Hibbs Osteotome 229-230
 Hibbs Retractor 169



Hibbs-Bruns Curette Rack.....	227, 816
Hill-Ferguson Rectal Retractor.....	749
Himmelstein Sternal Retractor.....	356
Hirschman Anoscope.....	748
Hirschman Iris Hook.....	516
Hirschman Iris Lens Spatula.....	521
Hoehn Alligator Forceps.....	303
Hoehn Dressing Forceps.....	116, 306
Hoehn Dura Separator.....	317
Hoehn Nerve Hook.....	316
Hoehn Periosteal Elevator.....	319
Hoehn Retractor.....	335
Hohmann Retractor.....	209
Hoke Osteotome Rack.....	228, 817
Hoke Osteotome.....	234

Holders

Clamp.....	136
Dilator.....	425, 822
Forceps.....	814
Instrument.....	812-814
Needle.....	52-53, 76-93, 256, 266-267, 269-270, 279-283, 412-420, 493-494, 496-497, 502, 546-548, 669-677, 799
Hollenbach Plugger, Double Ended.....	733
Holscher Nerve Retractor.....	325

Hooks

Bone.....	225
Bypass.....	429
Crypt.....	753
Detachment.....	519
Dura.....	274, 315-316, 318, 368
Ear.....	572
Elevator.....	632
Fixation.....	516, 519-520
Gasserian Ganglion.....	316
Incus.....	572
Iris.....	516, 518-519
Muscle.....	517
Nerve.....	273, 316, 368, 429
Palate.....	632
Rhoto-Type.....	276, 500
Single Prong.....	632
Skin.....	518, 630-632
Strabismus.....	517
Sympathectomy.....	317, 368

Tenaculum.....	779
Tenotomy.....	517
Tracheal.....	728
Zygoma.....	616
Horizontal Retractor.....	211
Horsley Dura Separator.....	317
Hough Crura Nipper.....	589
House Alligator Ear Forceps.....	587-588
House Crimper Forceps.....	587
House Curette.....	598
House Elevator.....	596
House Footplate Chisel.....	594
House Hand Retractor.....	159, 591
House Hook.....	592
House Incudostapedial Joint Knife.....	597
House Lancet Knife.....	597
House Middle Ear Mirror.....	592
House Miniature Cup Forceps.....	587
House Myringotomy Knife.....	598
House Needle.....	593
House Obtuse Pick.....	592
House Oval Window Pick.....	595
House Pick.....	596
House Sickle Knife.....	598
House Strut Caliper.....	594
House Strut Forceps.....	587
House Strut Pick.....	595
House Suction Adapter.....	584
House Suction Irrigator.....	584
House Tympanoplasty Knife.....	597
House Wire Strut Guide.....	594
House-Barbara Pick.....	595
House-Bellucci Alligator Scissors.....	588
House-Crabtree Dissector.....	596
House-Crabtree Dissector Pick "Jimmy".....	596
House-Dieters Malleus Nipper.....	589
House-Hough Excavator.....	594
House-Rosen Needle.....	593
House-Sheehy Knife Curette.....	593
Howard Bone File.....	735
Howard-DeBakey Aortic Aneurysm Clamp.....	434
Hudson Brace.....	342
Hudson Cranial Drill Set.....	342
Hufnagel-Ryder Needle Holder.....	88, 415
Hulka Tenaculum Forceps.....	777
Hunt Chalazion Forceps.....	543
Hunter Uterine Curette.....	770
Hurd Dissector and Pillar Retractor.....	719
Identification Tag.....	810
Inge Lamina Spreader.....	334
Ingrown Nail Cutter.....	251
Ingrown Nail Splitting Scissors.....	252
Initial Incision (Charnley) Retractor Set.....	210
In-Situ Bypass Hook.....	429

Instrument Holding Rack 808, 813, 818
 Instrument Stringer..... 813
 Instrument Tray..... 811
 Instrument Tip-It Protectors..... 822

Intestinal

Clamp 133-137, 139-140
 Locking Device 135
 Scissors 14, 145
 Iodine Cup 815
 Iowa Membrane Puncturing Forceps..... 789
 Iowa Trumpet Pudendal Needle Guide... 789
 Iris Forceps..... 118, 526
 Iris Scissors 22-24, 40, 43,
 549-551,
 656-658,
 663-664
 Israel Retractor 177
 Jackson Laryngeal Dressing Forceps..... 725
 Jackson Nasal Bone Scissors 32, 651
 Jackson Rongeur 298
 Jackson Tracheal Hemostat..... 729
 Jackson Tracheal Hook..... 728
 Jackson Tracheal Retractor 728
 Jackson Tracheal Tube..... 729-730
 Jackson Vaginal Retractor 764
 Jacobs Uterine Vulsellum Forceps 778
 Jacobson Bipolar Forceps..... 311
 Jacobson Bulldog Clamp 486
 Jacobson Forceps 116, 270
 Jacobson Instrument..... 271
 Jacobson Micro Scissors..... 268-269,
 382-384
 Jacobson Needle Holder..... 269
 Jacobson Scissors 268
 Jacobson Stardust Needle Holder 281-283, 497
 Jaffe Lid Retractor 512
 Jako Micro-Laryngeal Cup Forceps 726
 Jako Micro-Laryngeal Grasping Forceps. 726
 Jako Micro-Laryngeal Scissors..... 727
 Jameson Caliper 559
 Jameson Muscle Hook 517
 Jameson Muscle Recession Forceps..... 545
 Jamison Scissors 47
 Jamison-Metzenbaum Scissors 10, 373
 Jansen Ear Dressing Forceps..... 119, 566
 Jansen Nasal Dressing Forceps 119, 603
 Jansen Retractor..... 329, 590
 Jansen-Middleton Septum Forceps 623
 Jansen-Zaufel Rongeur 216
 Jarit Aortic Aneurysm Clamp..... 437
 Jarit Micro Forceps..... 503
 Jarit Micro Stardust Needle Holder 496-497, 502
 Jarit Micro Stardust Ring Forceps 503
 Jarit Periosteal Elevator 318, 613

Jarit Stardust Micro Forceps 284
 Jarit Stardust Micro Ring Forceps 285, 503
 Jarit Stardust Micro Suture Forceps 284, 286, 505
 Jarit Stardust Needle Holder 279-280, 282,
 493
 Javid Carotid Artery Clamp 480
 Jennings Mouth Gag 714
 Jewelers Bipolar Forceps 121, 312-313
 Jewelers Style Forceps..... 506, 533-534
 Jeweler-Type Forceps 312
 John Hopkins Bulldog Clamp..... 427
 Johnson Skin Hook..... 632
 Jones Adenoid Curette 698
 Jones Forceps 62
 Jones Thoracic Clamp 410
 Jones Towel Forceps 66
 Jorgenson Scissors 16, 370
 Joseph Button End Knife 628
 Joseph Nasal Knife..... 628
 Joseph Nasal Saw..... 689
 Joseph Periosteal Elevator 614
 Joseph Rasp 692
 Joseph Scissors 9, 605, 654
 Joseph Skin Hook 631
 Judd-Allis Tissue Forceps..... 127
 Judd-Masson Blade Retractor 756
 Juers-Lempert Rongeur 214, 578
 Julian Artery Forceps 405
 Julian Needle Holder 90, 418
 Kalt Needle Holder 546
 Kantrowitz Thoracic Forceps 402
 Karmody In-Situ Valve Scissors 21, 381
 Kartchner Internal Carotid Clamp..... 470
 Katzin Corneal Transplant Scissors 558
 Kay Aorta Clamp 439
 Kaye Dissecting Scissors..... 31, 650
 Kaye Face Lift Scissors 44, 666
 Kelly Artery Forceps..... 58
 Kelly Fistula Scissors 9, 754
 Kelly Placenta Forceps..... 789
 Kelly Proctoscope 748
 Kelly Retractor..... 168
 Kelly Uterine Scissors..... 787
 Kelman-McPherson Micro Corneal Forceps
 539
 Kelman-McPherson Suture Tying Forceps
 539
 Kern Bone Holding Clamp..... 202
 Kerrison Cervical Rongeur..... 290
 Kerrison Cervical Rongeur, Detach 291
 Kerrison Mastoid Rongeur 575
 Kerrison Rongeur..... 288-293
 Kerrison Rongeur, Spurling 291-293
 Kerrison-Costen Rongeur..... 575
 Kevorkian-Young Biopsy Forceps 774

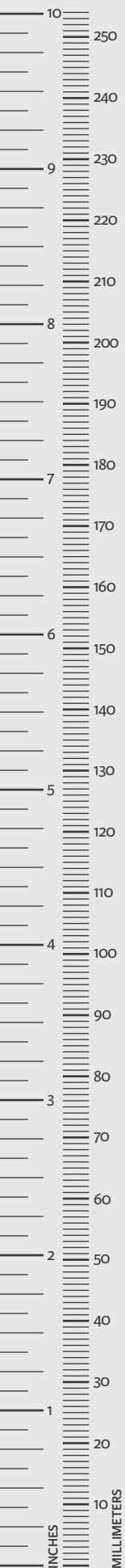

- Kevorkian-Younger Endocervical Biopsy Curette 771
 Key Elevator 240
 Keyes Dermal Punch Set 155
 Keyes Dermal Punch 155
 Kieland Obstetrical Forceps 791
 Kiene Bone Tamp 239
 Killian (Von Eicken) Antrum Cannula 608
 Killian Septum Forceps 622
 Killian Septum Specula 601, 703
 Kilner Skin Hook 631
 Kimura Platinum Spatula 521
 King Adenoid Punch 701
 Kirk Mallet 238
 Kitzmiller Clamp 468, 492
 Kleinert-Kutz Elevator and Dissector 615
 Kleinert-Kutz Rasp 693
 Kleinert-Kutz Skin Hook 630
 Kleinert-Kutz Tendon Retriever 249
 Knapp Iris Scissors 22, 549, 656
 Knapp Retractor 158, 637
 Knife Handles 70-73
 Knife Handle #3 70
 Knife Handle #3L 71
 Knife Handle #3LA 72
 Knife Handle #4 70
 Knife Handle #4L 72
 Knife Handle #7 71
 Knife Handle #9 (7K) 72
 Knight Nasal Dressing Forceps 604
 Knight Nasal Scissors 28, 43, 605,
 665, 703-704
 Knight Polypus and Turbinate Forceps ... 619
- Knives**
- Amputating 207
 Button End 628-629
 Corneal 512
 Discission 512
 Dissector 321
 Ear 573
 Graft 512
 Guide and Retractor 633
 Handles 72-75
 Meniscus 246
 Myringotomy 574
 Nasal 629
 Septum 609-610
 Sickie 711
 Sternum 367
 Swivel 610
 Tonsil 720
 Knolle Iris Hook 519
 Knolle Lens Nucleus Spatula 520
 Knowles Finger Bandage Scissors 11
- Kocher Artery Forceps 62, 681
 Kogan Endocervical Speculum 769
 Kratz-Barraquer Eye Speculum 508
 Krause Ear Snare 570
 Krause Nasal Snare 606
 Krayenbuehl Dura Hook 274
 Krayenbuehl Nerve Hook 273
 Krayenbuehl Twist Hook 274
 Kuglen Iris Hook and Lens Manipulator 519
 La Borde Tracheal Dilator 727
 La Force Adenotome 698
 La Force Foreign Body Spud 515
 Lachrymal Cannula 561
 Lahey Clinic Dura Hook 315
 Lahey Gall Duct Forceps 142, 407
 Lahey Hemostat 146
 Lahey Retractor 633
 Lahey Thoracic Forceps 407
 Lahey Thyroid Retractor 164
 Lahey Traction Forceps 146
 Lambert Aortic Aneurysm Clamp 436
 Lambert Chalazion Forceps 543
 Lambert-Kay Aorta Clamp 439, 492
 Lambert-Lowman Bone Holding Clamp 206
 Lambotte Bone Holding Clamp 204
 Lambotte Mini Osteotome Rack 236, 817
 Lambotte Mini Osteotome Set 236
 Lambotte Mini Osteotome 237
 Lambotte Osteotome Rack 227, 816
 Lambotte Osteotome 234
 Lamina Spreader 333
- Laminectomy**
- Retractor 184, 332, 338
 Rongeur 288-293
 Lancaster Eye Speculum 509
 Lane Bone Holding Clamp 202
 Lane Elevator 241
 Langenbeck Elevator 241
 Langenbeck Metacarpal Saw 245
 Langenbeck Retractor 163
 Laparoscopic Instrument Case 821
 Laparotomy Ring 152
 Large Pin Cutter 259
 Large Snap-On Basket Tag (with Key Ring)
 810
 Larry Rectal Probe and Director 753
- Laryngeal**
- Dilator 727
 Forceps 718, 725
 Mirror 725
 Retractor 744
 Laufe Uterine Polyp Forceps 775
 Lawrence Forceps 404

Lead hand 211
 Lebsche Sternum Knife 367
 Lee Right Angle Clamp 452
 Leksell Rongeur 218, 366
 Leland Jones Peripheral Vascular Clamp 445
 Lemmon Intima Dissector 427
 Lemmon Sternal Approximator 359
 Lemole-Strong Aorta Clamp 436
 Lempert Elevator 580
 Lempert Endaural Curette 571
 Lempert Rongeur 214, 578
 Lester Fixation Forceps 529
 Lewin Bone Holding Clamp 204
 Lewis Lens Loop 523
 Lewis Rasp 692
 Lewis Septum Forceps 622
 Lichtwicz Antrum Trocar Needle 607
 Lifting Handle 811

Ligature

Carrier 97, 274, 411, 642
 Lillehei-Potts Scissors 7, 47, 372
 Lillie Tonsil Scissors 34, 721
 Lincoln Vascular Scissors 18, 376
 Lister Banadage Scissors 11
 Liston Amputating Knife 207
 Liston Bone Cutting Forceps 221
 Littauer Cilia Forceps 541
 Littauer Stitch Scissors 13, 99
 Littauer-Liston Bone Cutting Forceps 220
 Little Retractor 163
 Littler Suture Carrying Scissors 33, 652
 Locke Elevator 251
 Locke Phalangeal Forceps 248
 Locking Plier 261-262
 Lockwood-Allis Tissue Forceps 128
 Long Hysterectomy Forceps 783

Loops

Lens 523
 Nucleus 523
 Shunt 482
 Lordan Chalazion Forceps 544
 Lothrop Tonsil Knife and Dissector 720
 Lothrop Uvula Retractor 701
 Love Gruenwald Pituitary Rongeur 294
 Love Nerve Retractor 324
 Love Uvula Retractor 701
 Love-Adson Periosteal Elevator 318
 Lovelace Lung Forceps 401
 Low Ryder Needle Holder 419
 Lower Gall Duct Forceps 142
 Lower Lateral Scissors 29, 648
 Lowman Bone Holding Clamp 206
 Lucae Ear Dressing Forceps 119, 566

Lucae Mallet 238
 Lucas Bone Curette 735
 Luer Lock Adaptor 423
 Luer Rongeur 212, 576
 Luer Tracheal Retractor 728
 Luikhart Obstetrical Forceps 791
 Lukens Thymus Retractor 728

Lung

Forceps 401
 Retractor 348
 Magill Catheter Forceps 150
 Magnetic Eye Probe 515
 Maliniac Nasal Retractor 636

Mallets

Bone 237-239
 Copper Head 646
 Plastic and Recon 237, 646-647
 Mallet w/Nylon Head 237, 646
 Maltz Button End Knife 629
 Maltz Rasp 691
 Maltz-Anderson Rasp 691
 Markham-Meyerding Hemilaminectomy Retractor 184, 333
 Martin Cartilage Clamp 246
 Martin Cartilage Scissors 14, 246
 Martin Pelvimeter 789
 Martini Bone Curette 251
 Masson Needle Holder 79, 88, 415
 Masterson Hysterectomy Forceps 782
 Mastin Muscle Clamp 146
 Mathieu Needle Holder 92
 Mathieu Raspatory 243
 Mathieu Retractor 158, 637

Mastoid

Rongeur 575
 Matson-Alexander Rib Stripper 367
 Matson Rib Stripper 367
 Mattox-Potts Scissors 18, 377
 Maumenee-Park Eye Speculum 510
 Mayfield Spatula 328
 Mayo (Guyon) Vessel Clamp 454, 758
 Mayo Abdominal Retractor 169
 Mayo Scissors 5-6, 37, 42, 787-788, 794
 Mayo Trays, Perforated 811
 Mayo Uterine Scissors 787
 Mayo-Adams Retractor 183
 Mayo-Collins Retractor 161
 Mayo-Harrington Scissors 16, 37, 370-371, 788
 Mayo-Hegar Needle Holder 79, 86, 413-414, 799



- Mayo-Noble Dissecting Scissors..... 6
 Mayo-Robson Intestinal Forceps..... 134
 Mayo-Russian Tissue Forceps..... 111
 McBurney Thyroid Retractor..... 163
 McClure Iris Scissors 556
 McCrea Infant Urethral Sound 760
 McCullough Utility Forceps 535
 McGee Wire Closure Forceps..... 589
 McGiveny Hemorrhoidal Grasping Forceps
 751
 McGiveny Hemorrhoidal Ligator 751
 McGiveny Ligator Set 751
 McGlamry Elevator..... 242
 McIndoe Dressing Forceps..... 108, 686
 McIvor Mouth Gag..... 716
 McKenty Punch..... 709
 McKenty Septal Elevator 611
 McKenzie Enlarging Burr 343
 McKenzie Perforator Drill 343
 McLane-Tucker Obstetrical Forceps 791
 McLane-Tucker-Luikhart Obstetrical Forceps
 792
 McPherson Eye Speculum..... 508
 McPherson Micro Corneal Forceps..... 538
 McPherson Needle Holder..... 548
 McPherson Suture Tying Forceps..... 538
 McPherson-Vannas Iris Scissors..... 558
 Mead Mallet 239
 Mead Rongeur 743
 Mediastinal Dissecting Forceps..... 432
 Medicine Cup..... 815
 Meeker Artery Clamp..... 144, 404
 Metzenbaum (Baby) Scissors..... 8, 654
 Metzenbaum (Nelson) Scissors..... 16, 39, 369
 Metzenbaum Scissors..... 8, 39, 42, 47,
 344, 369,
 373-374, 654,
 662-664, 722,
 794
 Metzenbaum Lahey Scissors 7, 9, 38, 42, 653,
 373, 654, 661,
 664
 Meyerding Blade..... 337
 Meyerding Finger Retractor 159
 Meyerding Hip and Shoulder Skid 208
 Meyerding Retractor 170, 184, 333,
 637, 638
 Meyerding Skin Hook and Retractor 158
 Meyhoeffer Chalazion Curette 514
 Michel Clip Applying/Removing Forceps..... 97
 Michel Skin Clip..... 97
 Michele Trepine 343
 Micro Alligator Ear Forceps 588, 589
 Micro Clamps, Pediatric..... 461-464,
 488-491
 Micro Forceps..... 399
 Micro Friedman Rongeur..... 212, 576
 Micro Needle Holder..... 418
 Micro Ring Forceps..... 400
 Micro Stitch Scissors..... 555
 Micro Suture Tying Forceps..... 264, 398
- Microlaryngeal**
- Cup Forceps..... 726
 - Grasping Forceps 726
 - Scissors 727
- Microsurgical**
- Clamp 461-462,
 488-491
 - Forceps..... 116, 264, 267,
 270, 398-400,
 503, 588-589
 - Instrument..... 271-272
 - Ligature Carrier..... 274
 - Needle Holder..... 266-267, 418
 - Rongeur 212, 288-289,
 303, 576, 743
 - Scissors 265, 267-269,
 303, 377,
 382-384, 555
 - Microvascular Needle Holder 91, 418, 493
- Middle Ear**
- Adaptor 584
 - Caliper..... 594
 - Chisel 594
 - Curette 593, 598
 - Dissector..... 596
 - Elevator 596
 - Excavator 594
 - Forceps..... 587-588
 - Guide..... 594
 - Hook..... 592
 - Irrigator..... 584
 - Knife 597-598
 - Mirror 592
 - Needle..... 593
 - Nipper 589
 - Pick 592, 595-596
 - Retractor..... 159, 591
 - Scissors 588, 592
 - Middleton Adenoid Curette 699
 - Miller Dissecting Scissors 31, 650
 - Miller Rasp..... 245
 - Miller Retractor..... 158, 639
 - Mills Coronary Tissue Forceps 387
 - Mills Endarterectomy Spatula 429
 - Mini-Blumenthal Rongeur 743
 - Mini-Hohmann Retractor 209

Miskimon Retractor 329
 Mixer Forceps 143, 407-409,
 456
 Mixer Forceps, Pediatric 143, 407, 456
 Molt Bone Curette 735
 Molt Periosteal Elevator 580
 Morse Sternal Retractor 356
 Mosquito Forceps (Thoracic) 405

Mouth Gags

Dental 744
 Throat 714
 Murphy Gall Bladder Retractor 167, 764
 Murphy Retractor 177
 Murphy-Lane Bone Skid 208
 Myringotomy Knife 573
 Nabatoff Vein Stripper 146, 430
 Nabatoff Vein Stripper (Case Only) 819
 Nail Nipper 155-156, 254
 Nail or Bone Rasp 251
 Nail Scissors 156
 Nail Splitter, English Anvill Pattern 156
 Nail Splitter 250
 Nasal Alligator Scissors 707

Nasal

Adenotome 698
 Cutting Forceps 625
 Dressing Forceps 604
 Elevator 581
 Forceps 119-120,
 603-604,
 620-621,
 624-625, 705,
 707
 Knife 628
 Rasp 608, 691-695
 Retractor 636, 701
 Saw 689
 Scissors 28, 31, 43, 605,
 665, 703-704,
 707
 Snare 606
 Speculum 600-601, 703

Needle

Antrum Trocar 607
 Biopsy 151
 Flushing 423
 Holder 52-53, 76-93,
 256, 266-267,
 269-270,
 279-283,
 412-420,
 493-494,

..... 496-497, 502,
 546-548,
 669-677, 799
 Pulling Forceps 95-96, 113, 249,
 252, 256, 307,
 390, 393-395,
 688
 Rhoton-Type 276, 500
 Septum 711
 Needle Nose Pliers 260
 Neivert Knife Guide and Retractor 633
 Neivert Needle Holder 76, 82, 669, 672
 Neivert Osteotome 645
 Nelson Tissue Forceps 110, 385, 687

Nerve

Hook 273, 316, 368
 Retractor 324-325

Neurosurgical

Blade 338
 Drill 342
 Elevator 320, 322, 368,
 702
 Forceps 303
 Retractor 329, 335, 341,
 590
 Rongeur 293, 297-299
 Scissors 15, 344
 Separator 323
 Spatula 328
 Trepine 343
 New Orleans Lens Loop 523
 New Orleans Needle Holder 78, 84
 New's Suture Scissors 12, 98
 News Tracheal Hook 728

Nippers

Crura 589
 Cuticle 156, 253
 Nail 155-156, 254
 Tissue 253
 No Scalpel Vasectomy Hemostat 757
 No Scalpel Vasectomy Ring Clamp 757
 Non-Perforating Towel Clamp 66
 Noon AV Fistula Clamp 458
 Novak Endometrial Biopsy Suction Curette
 771
 Noyes Nasal Dressing Forceps 604
 Nucleus Knife 254
 Nugent Utility Forceps 535
 Nylon Cap 646
 O'Brien Suture Scissors 14, 27, 99,
 555, 655
 Ochsner Aorta Clamp 438

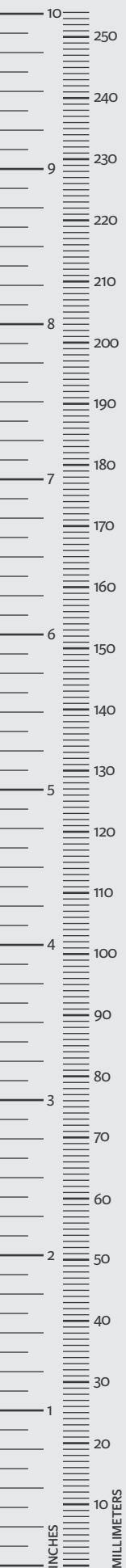

Ochsner Forceps 402, 456, 476
 Ochsner Vascular Retractor..... 196, 349
 O'Connor Hook..... 518, 630
 Oldberg Dissector..... 318
 Olivecrona Dissector 428
 Ollier Retractor..... 177
 Olsen-Hegar Needle Holder/Scissors 79, 87
 Operating Scissors 2-4, 37
 Oral Surgery Rongeur 743
 Orthopedic Mallet..... 238

Osteotomes

Bone 231, 234
 Hand Surgery 236
 Mini 237
 Plastic Surgery 643-647
 Rack..... 227-228, 236,
 817
 Ostium Seeker Ball End Elevator 611, 704
 Ostrum Antrum Punch..... 710
 Ostrum Antrum Suction Punch..... 710
 O'Sullivan-O'Connor Abdominal Retractor
 193
 O'Sullivan-O'Connor Vaginal Retractor.. 764
 Otis Urethrotome 755
 Overstreet Endometrial Polyp Forceps ... 775
 Packer and Excavator 254

Pans

Autoclaving 812
 Par Style Plastic and Recon Needle Holder
 83, 674
 Par Style Plastic and Recon Scissors 46, 668
 Parallel Pliers 260
 Parametrium Scissors..... 40, 779
 Parker Retractor 162
 Parker-Mott Retractor..... 162
 Parkes Hump Gouge 645
 Parkes Osteotome 645
 Parkes Rasp..... 691
 Park-Guyton Eye Speculum..... 510
 Parsonnet Epicardial Retractor 347

Passers

Chest Tube..... 478
 Tendon 248-249
 Wire 642
 Paufigue Garft Knife..... 512
 Payr Pylorus Clamp..... 137
 Pean Forceps..... 132, 795
 Peapod (Bead-Type) Forceps 298
 Pederson Vaginal Specula 762

Pediatric

Clamps 459, 461-462,
 466, 472,
 488-491
 Retractor 170
 Sinus Forceps 705-707
 Peers Towel Forceps 67
 Penfield Dissector..... 319, 368
 Pennington Forceps 64, 754
 Pennington Septal Elevator 611
 Pennington Tissue Forceps 401

Periosteal

Elevator 240, 242, 318,
 580-581,
 613-614

Periosteotome

Rib..... 367
 Perkins Retractor 590
 Petit-Point Allis Tissue Forceps..... 54, 126, 681
 Petit-Point Babcock Forceps 54, 129, 682
 Petit-Point Crile Forceps 51, 678
 Petit-Point Jacobson Mosquito Forceps. 50, 301, 402,
 476, 678
 Petit-Point Mixer Forceps..... 54, 143,
 407-408, 456,
 682
 Petit-Point Mosquito Forceps..... 50-51, 301-302,
 476, 678
 Petit-Point Ochsner Forceps 51, 679
 Petit-Point Olsen-Hegar Needle Holder/Scissors
 52, 79, 87, 671,
 675
 Petit-Point Pean Forceps..... 51, 679
 Petit-Point Reynolds Scissors 38, 52, 374-375,
 662
 Petit-Point Ryder Needle Holder 53, 88, 414-415,
 675
 Petit-Point Sarot Needle Holder..... 53, 90, 417
 Phaneuf Uterine Artery Forceps 783

Picks

Awl 235
 Fixation 520
 Root Tip 738
 Pierce Elevator..... 610
 Pierser Colibri Forceps..... 532
 Piffard Dermal Curette 155
 Piper Obstetrical Forceps 792
 Plain Rib Shears 362
 Plain Splinter Forceps..... 125
 Plaque Retriever..... 430



Plaster

Cast Breaker 201
 Cast Shearer 200
 Cast Spreader 201-202
 Plastic Filling Instrument..... 734

Plastic Surgery

Chisel 643-644
 Clamps 696
 Crusher 626
 Elevator 613-614
 Forceps 625
 Hook..... 630-632
 Knife 628-629
 Needle Holder..... 83, 674
 Osteotome 643-647
 Rasp 690
 Retractor 633-641
 Scissors 10, 30-33,
 43-48, 648-655,
 665-668
 Platypus Nail Pulling Forceps..... 252

Pliers

Flat Nose..... 261
 Locking 261-262
 Needle Nose..... 260
 Pin Removal..... 260
 Utility..... 260

Podiatry

Bone File 254
 Elevator 251
 Forceps 248
 Knife 254
 Nipper 254
 Probe and Packer 252
 Rasp 251
 Splitter 250
 Polack Double Corneal Forceps 536
 Politzer Ear Knife..... 573
 Polokoff Bone File..... 253
 Pomeroy Ear Syringe 583
 Poole Suction Tube..... 147-148, 800
 Posilock Instrument Holder 813
 Potts Arteriotomy Scissors 382
 Potts T-Handle Elevator 738
 Potts-Smith Dissecting Scissors..... 17, 375
 Potts-Smith Dressing Forceps..... 109, 388
 Potts-Smith Tissue Forceps..... 109-110, 388
 Potts-Smith Vascular Scissors..... 19, 48, 378
 Pratt Ethmoid Curette 617
 Pratt Rectal Probe 753
 Pratt Rectal Speculum..... 746
 Pratt Smith T-Clamp..... 63, 754

Pratt Uterine Dilator..... 768
 Presbyterian Hospital Elevator 320
 Presbyterian Hospital Tube Occluding Forceps
 68

Presses

Fascia..... 599
 Preston Ligamentum Flavum Forceps..... 247
 Probe and Packer 252

Probes

Director 153
 Double Ended 152
 Eye 515
 Fistula..... 753
 Lacrimal 560
 Pigtail 561
 Rectal..... 753
 With Eye..... 152
 Providence Hospital Forceps..... 59, 681

Punches

Antrum 710
 Cervical 774
 Dermal 155
 Neurosurgical..... 293
 Sinoscopy 709
 Putti Rasp..... 245
 Quimby Gum Scissors..... 744
 Quisling Intranasal Hammer..... 647
 Rabiner Neurological Hammer..... 151

Racks

Bone 228, 817
 Curette 227-228,
 816-817
 Holding 808, 813, 818
 Lambotte 816
 Osteotome 228, 236, 817
 Rhoton-Type..... 278, 501, 818
 Ragnell Retractor 159, 638
 Ragnell Undermining Scissors..... 29, 648
 Randall Endometrial Biopsy Suction Curette
 771
 Randall Kidney Stone Forceps..... 757
 Rankin Artery Forceps 59

Rasps

Antrum 608
 Bone 243, 245
 Carb-Bite 694-696
 Diamond 689
 Nasal..... 245, 691-693
 Plastic Surgery 690-691

- Podiatry..... 251
Rib..... 367
- Rectal**
Clamp..... 454, 759
Forceps..... 749-750
Hook..... 753
Probe..... 753
Retractor..... 746-747, 749,
..... 756-757
Speculum..... 746-747
Reiner Rongeur..... 213, 577
Renal Artery Clamp..... 451
- Retractors**
Abdominal..... 169, 185-191
Alar..... 635
Anal..... 746-747
Aortic..... 347
Automatic Skin..... 178, 640
Blades..... 186-187,
..... 189-190,
..... 336-339, 642,
..... 714-715, 717
Bone..... 208-209, 211,
..... 245
Cerebellar..... 182, 331
Cervical..... 339
Cheek..... 716, 744
Cobra..... 209
Crile..... 164
Decompression..... 324
Dissectomy..... 341
Endural..... 591
Epicardial..... 347
Finger..... 157-160,
..... 636-638
Flexible Shaft..... 157
Hand..... 159, 161-174,
..... 208, 210,
..... 637-639, 764,
..... 800
Hysterectomy..... 766
Knee..... 207
Knife Guide..... 633
Lacrimal Sac..... 511
Laminectomy..... 184, 332, 338
Lid..... 511-512
Lung..... 346, 348
Nasal..... 635-636, 651
Nerve..... 324-325
Neurosurgery..... 329, 335, 590
Orbital..... 512, 716
Pillar..... 719
Plastic Surgery..... 633-634
- Popliteal..... 195, 349
Prostatic..... 756
Rake..... 158, 160,
..... 175-177, 210,
..... 633, 638-639
Rectal..... 749
Renal Sinus..... 757
Scalp..... 329
Scalpula..... 346
Self Retaining..... 178-179, 181-196,
..... 329-331, 333,
..... 335, 348, 452,
..... 590-591,
..... 639-641
Shallow..... 192
Skin Hook..... 158, 637
Spinal..... 335
Spring..... 180, 429
Sternal..... 355-358
Thymus..... 728
Thyroid..... 163-164, 182,
..... 332
Tibia..... 207
Tracheal..... 728
Universal..... 766
Uvula..... 701
Vaginal..... 764-766
Vagotomy..... 174
Valve..... 346
Vascular..... 195-196, 349
Vein..... 164, 324, 800
Wire..... 180, 640
Reul Coronary Tissue Forceps..... 114, 387
Reverse Curve Adenoid Curette..... 700
Reynolds Clamp..... 442, 473
Reynolds Scissors..... 10, 373
Reynolds, Petit Point Scissors..... 47, 374-375, 668
- Rhoton-Type**
Ball-Dissector..... 277-278, 501
Curette..... 277, 501
Dissector..... 275, 500
Elevator..... 275, 500
Forceps..... 264, 278, 398
Hook..... 276, 500
Instrument Rack..... 278, 501, 818
Needle..... 276, 500
Spatula-Dissector..... 275-276, 500
Suture Tying..... 264, 398
- Rib**
Contractor..... 359
Periosteotome..... 367
Rongeur..... 219, 366
Shears..... 362-363

Spreader.....	353
Stripper	367
Ribbon Retractor.....	173
Richards Micro Needle Holder	493
Richardson Appendectomy Retractor	167
Richardson Retractor	166
Richardson-Eastman Retractor.....	165
Richter-Heath Clip Forceps.....	97
Rigby Retractor	183
Ring	
Curettes.....	226
Cutter	154
Laparotomy	152
Retractor Blade	717
Robb Tonsil Knife.....	720
Rochester-Carmalt Forceps.....	62
Rochester-Ochsner Artery Forceps.....	61, 786, 795
Rochester-Pean Artery Forceps	60, 410, 785,
.....	798
Roeder Towel Forceps	65
Roger Elevator.....	612
Rogers Hysterectomy Clamp	783
Rollet Retractor	158, 637
Rongeurs	
Bone	212-219, 221,
.....	365-366,
.....	576-579
Cervical	290-291
Cranial.....	299
Dental.....	743
Intervertebral Disc.....	296-298
Mastoid.....	575
Microsurgical	288-289, 303
Mini Bone	215, 364
Neuro	293, 296, 299
Pituitary	294-295
Rib.....	219, 366
Spurling	291-293
Thoracic.....	219, 366
Valve	428
Ronis Adenoid Punch.....	701
Root Tip Dental Elevator	737
Rosen Suction Tube.....	584
Ross Aortic Valve Retractor	347
Rosser Crypt Hook.....	753
Roux Retractor	161
Rowland-Ruskin-Liston Bone Splitting Forceps	
.....	625
Rubin Osteotome	645
Rubin Spetum Morselizer	626
Rubio Sternal Needle Holder	93, 419
Ruedemann Lacrimal Dilator	561
Rummel Artery Forceps.....	410

Rummel Tourniquet	411
Ruskin Angular Duckbill Rongeur	217, 365
Ruskin Antrum Trocar Needle.....	607
Ruskin Mini Bone Rongeur.....	215, 364
Ruskin Rongeur.....	216, 365, 579
Ruskin-Jay Rongeur	216, 365
Ruskin-Liston Bone Cutting Forceps	220
Ruskin-Liston Bone Splitting Forceps.....	220, 364
Russian Tissue Forceps	111, 386, 796
Ryder Needle Holder.....	87, 414, 494
Saalfeld Comedone Extractor	154
Sachs Dura Hook	315
Sachs Separator	318
Sachs Vein Retractor	324
Safety Blade Remover	68
Sage Tonsil Snare.....	723
Sarot Artery Forceps	406, 797
Sarot Bronchus Clamp	411, 453
Sarot Needle Holder.....	80, 90, 417
Satinsky Vascular Scissors	17, 375
Satinsky Vena Cava Clamp	441-442
Satterlee Saw.....	244
Sauer Eye Speculum, Infant	508
Sauer Suture Forceps	537
Sauerbruch Retractor	165
Sauerbruch Rib Rongeur	219, 366
Sauerbruch Rib Shears.....	362

Saws

Bone	244
Metacarpal	245
Nasal.....	689
Sawyer Rectal Retractor.....	749
Sayre Elevator.....	242
Scalp Retractor.....	329
Schaaf Foreign Body Forceps	537
Schamberg Comedone Extractor	154
Schepens Orbital Retractor	512
Shink Metatarsal Spreader.....	253
Schlesinger Rongeur	296
Schmeden (Meltzer) Adenoid Punch.....	700
Schmidt Tonsil Forceps	480, 719
Schroeder Tenaculum Forceps.....	776
Schroeder Uterine Vulsellum Forceps	778
Schubert Biopsy Forceps	773

Scissors

Abdominal	6-7, 788
Alligator	588, 707
Arteriotomy	382
Bandage	11-12, 200-201
Bone	30, 164, 650
Capsulotomy	557
Carb-Edge.....	36-40, 52, 344,



- 369, 371,
..... 373-374, 550,
..... 552, 661-663,
..... 722, 772, 779,
..... 788, 794
- Cartilage 14, 246
- Circumflex Artery 20, 380
- Conjunctival 23, 551, 657
- Cord 790
- Corneal 556-557
- Corneal Transplant 558
- Coronary Artery 20-21, 49,
..... 379-381
- Cuticle 156
- Dissecting 6, 17, 31, 33, 375,
..... 650, 653
- Dorsal 29-30, 46, 649,
..... 668
- Dura 15, 344
- Endarterectomy 18, 48, 376
- Enucleation 26, 554
- Episiotomy 35, 788
- Face Lift 44-45, 665-667
- Fistula 9, 754
- Flat Tip 9, 375, 654
- Gall Bladder 14, 145
- Ganglion 15, 344
- Gum 33, 653, 744
- In-Situ Valve 21, 381
- Iris 22-24, 40, 43,
..... 549-551, 556,
..... 558, 656-658,
..... 663-664
- Lateral 46, 668
- Leaflet 382
- Lower Lateral 29, 648
- Micro 268-269,
..... 382-384
- Micro Ear 568
- Microlaryngeal 727
- Microsurgery 265, 267-268,
..... 303, 377
- Middle Ear 588, 592
- Nail 156
- Nail Splitting 252
- Nasal 28, 31, 43, 605,
..... 665, 703-704,
..... 707
- Nasal Bone 28, 32, 43, 651
- Neuro/Spinal 15, 344
- Operating 2-10, 38-40, 42,
..... 47, 344, 369,
..... 373-374, 605,
..... 653-654,
..... 661-664,
- 722, 788, 794
- Ophthalmic 22-27, 40,
..... 549-558,
..... 656-660
- Petit-Point 38, 47, 52,
..... 374-375, 668
- Plastic and Recon 10, 29-33,
..... 45-46, 48,
..... 665-666, 668
- Platysma 45, 667
- Removal 26, 554
- Reynolds 38, 47, 52, 662
- Rhytidectomy 45, 667
- Saber Back 31, 651
- Septum 30-32, 649-650,
..... 652
- Stitch 13, 26-27, 99,
..... 554-555, 660
- Supercut 41-49, 51, 344,
..... 369, 371-376,
..... 378, 380-381,
..... 550, 605,
..... 664-668, 722,
..... 788, 794
- Suture 12-14, 27, 33, 40,
..... 98-99, 553-555,
..... 652, 655,
..... 659-660, 665
- Tenotomy 25, 43, 48, 553,
..... 659, 665
- Thoracic 16, 39, 369-371,
..... 382, 788
- Tonsil 34, 721
- Trigeminal 15, 344
- Turbinate 28, 32, 605, 652
- Undermining 29, 648
- Uterine 35, 779, 787-788
- Utility 24, 552-553,
..... 659
- Vannas 558
- Vascular 7, 16-21, 48-49,
..... 370, 372,
..... 375-379, 381
- Vein Graft 592
- Wire 12, 14, 40, 99
- Scleral Twist Fixation Hook 520
- Scops**
- Gall Stone 141
- Scoville Bipolar Forceps 122-123, 313-314
- Scoville Blade 336-337
- Scoville Disc Curettes 225
- Scoville Nerve Retractor 325
- Scoville Retractor Frame 336
- Scoville Spatulas 328



Sedillot Elevator..... 242
 Seiler Turbinate Scissors..... 28, 605
 Seldin Elevator 737
 Seldin Periosteal Elevator 242, 580
 Seletz-Gelpi Retractor..... 335
 Self-Centering Bone Forceps 205
 Selman Peripheral Forceps 458
 Selman Tissue Forceps..... 115, 386
 Semb Ligature Carrier 411
 Semb Lung Retractor 348
 Semb Retractor 167
 Semken Bipolar Forceps 311
 Semken Dressing Forceps 107, 305, 686
 Semken Needle Pulling Forceps 96, 394, 688
 Semken Tissue Forceps..... 108, 306, 686
 Semmes (Howard) Spinal Curette 224
 Senn Retractor 157, 636

Separators

Dura 317-318, 323

Septum

Elevator 611, 613, 704
 Forceps 621-624
 Morselizer 626
 Needle..... 711
 Scissors 30-32,
 649-650, 652
 Speculum..... 602, 703
 Serrefine Forceps 427
 Sesamoidectomy Clamp..... 248
 Seton Retractor Blade 193
 Seton Shallow Surgical Retractor..... 192

Sets

Coronary Artery Bypass 422
 Cranial Drill..... 342
 Dermal Punch 155
 Initial Incision Retractor 210
 McGiveny Ligator 751
 Mini Osteotome 236
 Stone Intestinal Clamp 136
 Vein Stripper 146, 430
 Vertebral Biopsy..... 300
 Sewall Orbital Retractor 716
 Sexton (Gerzog) Ear Knife..... 573
 Shambaugh Adenotome 698
 Shapleigh Ear Curette 571
 Shea Vein Graft Scissors 592
 Shearer Chicken Bill Rongeur 213, 576

Shears

Plaster 200-201
 Rib..... 362-363
 Utility..... 200

Sheehy Fascia Press 599
 Sheehy Ossicle Holding Clamp 599
 Sheets-McPherson Tying Forceps..... 539
 Shepard Iris Hook 516
 Shepard Tying Forceps 540
 Silver Osteotome..... 644
 Simcoe Nucleus Loop 523
 Simpson Obstetrical Forceps 790-791
 Simpson Uterine Sound 769
 Simpson-Luikhart Obstetrical Forceps... 792
 Sims Rectal Speculum..... 746
 Sims Uterine Curette..... 770
 Sims Uterine Scissors..... 35, 787
 Sims Uterine Sound 768
 Sims Vaginal Retractor 765-766
 Singley Tissue Forceps 115, 386, 796
 Sinoscopy Trocar and Cannula 712

Sinus

Cannula..... 607
 Curette 618
 Forceps..... 707-708
 Ostium Seeker 711
 Punch 709

Sinusscopes

Sinus Endoscopy 712
 Tray 712, 822
 Sinskey Iris Hook 518
 Sinskey Tying Forceps 539
 Sinus Septum Needle 711
 Sinus Sickle Knife 711
 Sinuscope, Autoclavable 712
 Sistrunk Retractor..... 162
 Sistrunk Scissors..... 5
 Skene Tenaculum Forceps 777

Skids

Bone 208
 Hip 208

Skin

Hook..... 518, 630-631
 Skinner Needle Pulling Forceps..... 96, 395
 Slip Joint Utility Pliers 260
 Sluder-Jansen Mouth Gag..... 714
 Small Snap-On Basket Tag (with Key Ring)
 810
 Smillie Meniscus Knife..... 246
 Smillie Retractor 208
 Smith Anal Retractor 747
 Smith Wire Scissors..... 14, 99
 Smith-Petersen Gouge 231
 Smith-Petersen Osteotome Rack..... 228, 817
 Smith-Petersen Osteotome 231

- Smith-Petersen Rongeur 219
 Smithwick Sympathectomy Hook 317, 368
- Snares**
 Ear 570
 Nasal 606
 Tonsil 723
 Snellen Entropium Forceps 544
 Solutions Basin 815
 Somers Uterine Elevating Forceps 769
 Sonnenschein Nasal Speculum 600
- Sounds**
 Urethral 760
 Uterine 769
- Spatulas**
 Cement 734
 Cyclodialysis 521-522
 Endarterectomy 429
 Iris 520-522
 Lens Nucleus 520
 Neuro 328
 Platinum 521
 Rhoton-Type 275-276, 500
 Vaginal 763
- Specula**
 Anal 747
 Ear 564-565
 Endocervical 769
 Eye 508-510
 Nasal 600-601, 703
 Operating 747
 Proctoscope 748
 Rectal 746-748
 Septum 601-602, 703
 Synechia 522
 Vaginal 762-763
 Spencer Suture Scissors 13, 98-99
- Spinal**
 Blades 338
 Curette 223-224
 Retractor 335
 Spinal Fusion Curette 223
- Spreaders**
 Cast 201
 Cervical 334
 Interbody 341
 Lamina 333-334, 341
 Metatarsal 253
 Pylorus 131
 Rib 350-355, 499
- Vertebra 340
 Spring Wire Retractor 180, 640
- Spuds**
 Foreign Body 514-515
 Spurling Pituitary Rongeur 295
- Stardust**
 Forceps 279-286, 493,
 496-497,
 502-505,
 Micro Forceps 284
 Needle Holder 279-280, 282,
 418, 493,
 496-497, 502
 Rasp 689
 Ring Forceps 285, 503
 Suture Forceps 284, 286, 505
 Staude-Moore Tenaculum Forceps 776
 Steel Ruler 559
- Steelware**
 Basin 815
 Steiner-Auvard Vaginal Speculum 763
 Sterile Indicator Card 809
- Sterilization Containers** See Containers
 Sterilization Filter 809
 Sternal Chest Tube Passer 478
- Sternal**
 Needle Holder 93, 256, 420
 Passer 478
 Stevens Removal Scissors 26, 554
 Stevens Stitch Scissors 26, 554, 660
 Stevens Tenotomy Hook 517
 Stevens Tenotomy Scissors 25, 43, 48, 553,
 659-660, 665
 Stevenson Lacrimal Sac Retractor 511
 Stewart Crypt Hook 753
 Stille Plaster Shears 201
 Stille Vessel Clamp 453, 758
 Stille-Giertz Rib Shears 362
 Stille-Horsley Bone Cutting Forceps 221, 364
 Stille-Liston Bone Cutting Forceps 221, 364
 Stille-Luer Rongeur 217, 365
 Stille-Luer-Echlin Rongeur 218, 366
 Stille-Type Chisel 235
 Stille-Type Gouge 235
 Stille-Type Osteotome 235
 Stitch Scissors 27, 555, 660
 Stone Clamp Applying Forceps 135
 Stone Clamp Locking Device 135
 Stone Intestinal Clamp 135
 Stone Intestinal Clamp Set 136

Stoney Heparin Injector 423
 Stookey Cranial Rongeur 299
 Stopcock 422
 Storey Artery Forceps 64, 404
 Strabismus Scissors 25, 40, 552,
 659, 663
 Stratte Needle Holder 90, 417
 Struempel Alligator Ear Forceps 567
 Struempel Pediatric Forceps 705
 Struempel-Voss Nasal Forceps 621
 Strully Dura Twist Hook 316
 Strully Scissors 15, 344
 Struycken Nasal Cutting Forceps 707
 Stubbs Adenoid Curette 699
 Subramanian Miniature Aorta Clamp 471

Suction
 Abdominal 147-149
 Cannula 711
 Dental 149
 Ear 327, 585-586
 General 147-149, 724
 Neuro 327
 Rectal 427
 Tube 147-149, 326,
 584, 586,
 702, 724, 800
 Vascular 421

Supercut
 Scissors 41-49, 51, 344,
 369, 371-376,
 378, 380-381,
 550, 605,
 664-668, 722,
 788, 794
 Suraci Zygoma Hook-Elevator 632

Suture
 Forceps 264, 398, 479,
 530-532,
 535-537,
 539-540
 Scissors 12-14, 27, 33, 40,
 98-99,
 553-555, 652,
 655, 659-660,
 665
 Sweet Amputation Retractor 245

Syringes
 Aspirating 744
 Ear 583
 Takahashi Nasal Forceps 624, 707
 Takahashi Rongeur 298

Takahashi Suction Forceps 708
 Tamper Evident Lock 809
 Taylor Dura Scissors 15, 344
 Taylor Laminectomy Blade 338
 Taylor Percussion Hammer 151
 Taylor Retractor 335
 Taylor Spinal Blade 338
 Teale Uterine Vulsellum Forceps 778

Tenaculum
 Forceps 776-777
 Hook 632
 Tendon Braiding Forceps 249
 Thomas Uterine Curette 770
 Thomas-Gaylor Biopsy Forceps 772
 Thompson Carotid Closure Clamp 470
 Thoms-Allis Tissue Forceps 128

Thoracic
 Clamp 146, 406,
 410-411, 443,
 445, 449, 453
 Dilator 428
 Dissector 427
 Forceps 109-110, 387,
 402, 404-405,
 407-409, 456
 Needle Holder 90, 418
 Rongeur 219, 366
 Scissors 16, 39, 369-371,
 382, 788
 Thorek Gall Bladder Scissors 14, 145
 Thornton Intraocular Lens Forceps 542
 Thorpe Caliper 559
 Thorpe Conjunctival Fixation Forceps 528

Thumb
 Forceps 100-120,
 304-307,
 309-310,
 388-389, 391,
 525, 683-684,
 686, 723, 725,
 775, 795
 Tiek-Halle Nasal Speculum 600, 703
 Tischler Biopsy Forceps 774
 Tissue and Cuticle Nipper 252

Tissue
 Forceps 54, 100-115,
 117-118, 126-130,
 304-309,
 385-391,
 396-397,
 401-402, 495,

..... 498, 504,
 681-687,
 796-797
 Tissue Nipper 253
 Tivnen Tonsil Seizing Forceps 718
 Toffmire Type Matrix Retainer 744

Tongue

Blade 642, 714
 Depressor 717
 Forceps 150

Tonsil

Dissector 720
 Forceps 480, 718-719
 Knife 720
 Scissors 34, 721
 Snare 723
 Tooke Corneal Knife 512
 Townley Femur Caliper 262
 Townsend Endocervical Biopsy Curette 772
 Toynebee Ear Specula 565

Tracheal

Dilator 727
 Hemostat 729
 Retractor 728

Trays

Instrument 811
 Perforated 811-812
 Sinuscope 712, 822

Trocars

Antrum 607
 Trousseau Tracheal Dilator 727
 Troutman Needle Holder 548
 Troutman Superior Rectus Forceps 545
 Troutman-Barraquer Utility Forceps 530, 536
 Troutman-Castroviejo Corneal Section Scissors
 557
 Tubbs Dilator 428
 Tube Occluding Forceps 68, 481
 Tube Occluding Forceps w/U-Shaped Guard
 69

Tubes

Forceps 68-69, 481
 Suction 147-149,
 326-327, 421,
 584-586, 702,
 724, 752, 800
 Tracheal 729-730
 Tuffier Rib Spreader 353

Tumor

Screw 784

Tuning

Fork 569

Tunnelers

Femoral Bypass 431
 Graft 430
 Turrell Biopsy Forceps 749-750
 Tydings Tonsil Snare 723
 Tyrell Hook 516
 U of M Cheek Retractor 744
 Uebe Applicator 583
 Ulrich-Style Bone Holding Forceps 206
 Umbilical Cord Scissors 790
 Universal Bandage Scissors 12, 200-201
 Universal Hand Drill 255
 Universal Wire Suture Scissors 12, 40, 98
 University of Illinois Bone Marrow Biopsy Needle
 151
 Unna Comedone Extractor 154

Urology

Retractors 756
 Urethrotome 755
 US Army Retractor 161

Uterine

Curette 770, 772
 Dilator 767-768
 Forceps 769, 772,
 774-776, 778,
 787
 Scissors 35, 779, 787-788
 Uvula Retractor 701
 Valve Leaflet Scissors 382
 Van Alyea Frontal Sinus Cannula 607
 Van Buren Urethral Sound 760
 Vanderbilt Clamp 406
 Vannas Capsulotomy Scissors 557
 Varco Gallbladder Forceps 144

Vascular

Adaptor 423
 Cannula 423
 Clamp 133, 434-452,
 458-460,
 465-475, 479,
 481-486, 492
 Dilator 425-426, 820
 Forceps 95, 102-103,
 109, 264, 305,
 385, 393-394,
 396-397, 402,

..... 406, 410,
..... 456-458,
..... 476-477, 495,
..... 498, 797
Ligature Carrier 411
Needle Holder 89-95, 256,
..... 415-416, 420
Retractor 196, 346-347,
..... 349, 357-358
Scissors 7, 16-21, 48-49,
..... 370, 372,
..... 375-379, 381
Shunt 482
Suction Tube 421
Tunneler 431

Vein

Retractor 164, 324, 800
Scissors 592
Stripper 146
Verbrugge Bone Holding Clamp 205
Vertical Retractor 211
Vienna Nasal Specula 600-601
Virtus Splinter Forceps 125
Vogel Adenoid Curette 699
Volkman Bone Curette 225
Volkman Retractor 160, 175-176
Von Eicken Suction Cannula 711
Von Graefe Fixation Forceps 528
Von Graefe Iris Forceps 526-527
Von Graefe Strabismus Hook 517
Von Graefe Tissue Forceps 101
Vorse Tube Occluding Forceps 68, 481
Wachtenfeld Clip Forceps 97
Wall Wax Carver, Double Ended 733
Walsham Septum Forceps 624
Walton Cartilage Clamp 247
Walton Cast Spreader 201
Walton Meniscus Clamp 247
Walton-Liston Bone Cutting Forceps 220
Wangensteen Tissue Forceps 115, 387
Ward Wax Carver, Double Ended 733
Wartenberg Pin Wheel 151
Watson-Williams Polypus Forceps 619
Watzke Sleeve Spreading Forceps 537
Wax Spatula, small end with one flat side
..... 734
Webster Needle Holder 78, 84, 412,
..... 671, 674
Wecker Iris Spatula 521
Weil Nasal Forceps 621
Weinberg Vagotomy Retractor 174
Weinstein Instrument Holder 812
Weisenbach Forcep Holder 814
Weitlaner Retractor 181-182,

..... 330-331, 591,
..... 641
Weldon Miniature Bulldog Clamp 485
Wells Enucleation Spoon 524
Wertheim Pedicle Clamp 454, 759
Wertheim-Cullen Pedicle Clamp 454, 759
West Lacrimal Sac Chisel 609
West Lacrimal Sac Gouge 609
Westcott Stitch Scissors 554
Westcott Tenotomy Scissors 553
Westcott Utility Scissors 553
Wheeler Cyclodialysis Spatula 521
Wheeler Discission Knife 512
Wheeler-Type Plaque and Vessel Forceps
..... 109, 387
White Tonsil Seizing Forceps 718
Wieder Tongue Depressor 717
Wiener Antrum Rasp 608
Wiener Eye Speculum 509
Wiener Skin Hook 630
Wilde Ear Dressing Forceps 119, 566
Wilde Nasal Dressing Forceps 120, 603
Wilde Nasal Forceps 620
Wilde Rongeur 297
Wilder Lacrimal Dilator 560
Wilder Lens Loop 523
Willauer Scissors 16, 370
Willauer-Deaver Retractor 174
Williams Discectomy Retractor 341
Williams Eye Specula 509
Williams Lacrimal Probe 560
Williams Splinter Forceps 125
Williams Tissue Forceps 129
Williams-Type Discectomy Forceps 303
Williger Bone Curette 250
Wills Hospital Utility Forceps 535
Wilmer Conjunctival Scissors 23, 551, 657

Wire

Brush 693
Cut Snare 723
Cutter 258
Mandrin 149
Passer 642
Pulling Forceps 256
Retractor 180, 640
Scissors 12, 14, 40, 99
Twister 93, 256, 420
Wittner Biopsy Forceps 772
Wolfe-Boehler Cast Breaker 201
Woodson Dura Separator and Packer 323
Woodson Elevator and Spatula 322
Woodson Plastic Filling Instrument 734
Woodward Artery Forceps 405
Worst "Pigtail" Probe 561



Wright-Rubin Septum Morselizer	626	Yasargil Needle Holder.....	267
Wullstein Retractor.....	591	Yasargil Scissors	267, 377
Wylie “J” Clamp.....	439	Yeoman Biopsy Forceps	749-750
Wylie Abdominal Aorta Clamp	435	Young Prostatic Retractor.....	756
Wylie Hypogastric Clamp.....	435	Young Tongue Seizing Forceps	150
Yankauer Suction Tube	148-149, 724,	You-Potts Scissors	377
.....	800	Zanger Abdominal Aorta Clamp.....	435
Yasargil Forceps.....	267	Ziegler Cilia Forceps.....	541
Yasargil Instrument.....	271-272	Zipser Penis Clamp.....	790
Yasargil Ligature Carrier.....	274	Z-Hysterectomy Forceps	780





Integra™ Surgical Instrument Product Lines

Integra™ Omni-Tract® Table Mounted Retractors

Integra™ Surgical Table Mounted Retractors, formerly known as Omni-Tract®, provides you with both Wishbone® and Ring Retractor Systems.

- Wishbone® Retractor Systems offer a multi-use frame perfect for varied patient, or incision size
- The Integra™ Ring Retractor system is interchangeable with all marketed Ring Retractor Systems

Limit uncertainty with strength and adjustability!

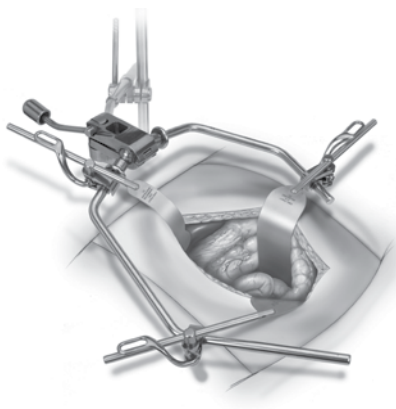

Wishbone® Style



Ring Style

For more information or to place an order, please contact:

Integra ■ 4849 White Bear Parkway, St. Paul, MN 55110

800.367.8657 USA ■ 651.287.4300 outside USA

651.287.4400 fax

integralife.com

Integra™ Padgett® Plastics Instruments

Integra™ Surgical Plastic Surgery Instruments represent one of the broadest offerings of specialty plastic surgery instruments available. Integra's plastic surgery instruments include instruments for a variety of reconstructive and cosmetic plastic procedures.

Limit uncertainty with a broad offering and exceptional quality!

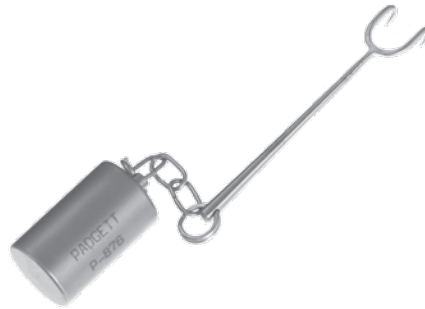

For more information or to place an order, please contact:
Integra ■ 589 Davies Drive, York, PA 17402
877-468-5572 USA ■ 609-750-4259 fax
914-592-9050 outside USA ■ 914-592-8056 outside USA fax
integralife.com

Integra™ Luxtec® Surgical Illumination

Optimized System Performance

- 15% more light with MLX
- Cool running smart fans
- 1000 hour lamp
- Comfort, ease of use
- Maximum light with MLX/UL Pro System

The ProXenon™ Surgical Illuminator and Headlight System

is a durable, user-friendly device that offers superior comfort, rapid lamp change, extended lamp life and superior lux.

Don't forget that Luxtec is the market leader in surgical illumination and can also provide instrument cables in various standard lengths!



**MLX Ultralite® Pro Headlight
& Xenon Light Source**



**ProXenon™ Surgical Illuminator
and Headlight System**

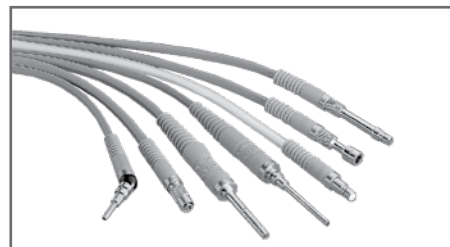

Fiber Optic Instrument Cables

For more information or to place an order, please contact:
Integra ■ 589 Davies Drive, York, PA 17402
877-468-5572 USA ■ 609-750-4259 fax
914-592-9050 outside USA ■ 914-592-8056 outside USA fax
integralife.com

Integra™ Ruggles™-Redmond™ Neuro/Spine Instruments

Integra™ Surgical Neuro/Spine Instruments represent one of the broadest offerings of specialty Neuro/Spine instruments available. Integra's offerings include innovative features including detach Kerrison rongeurs and coating to extend the life of the instruments.

Limit uncertainty with a broad offering and exceptional quality!

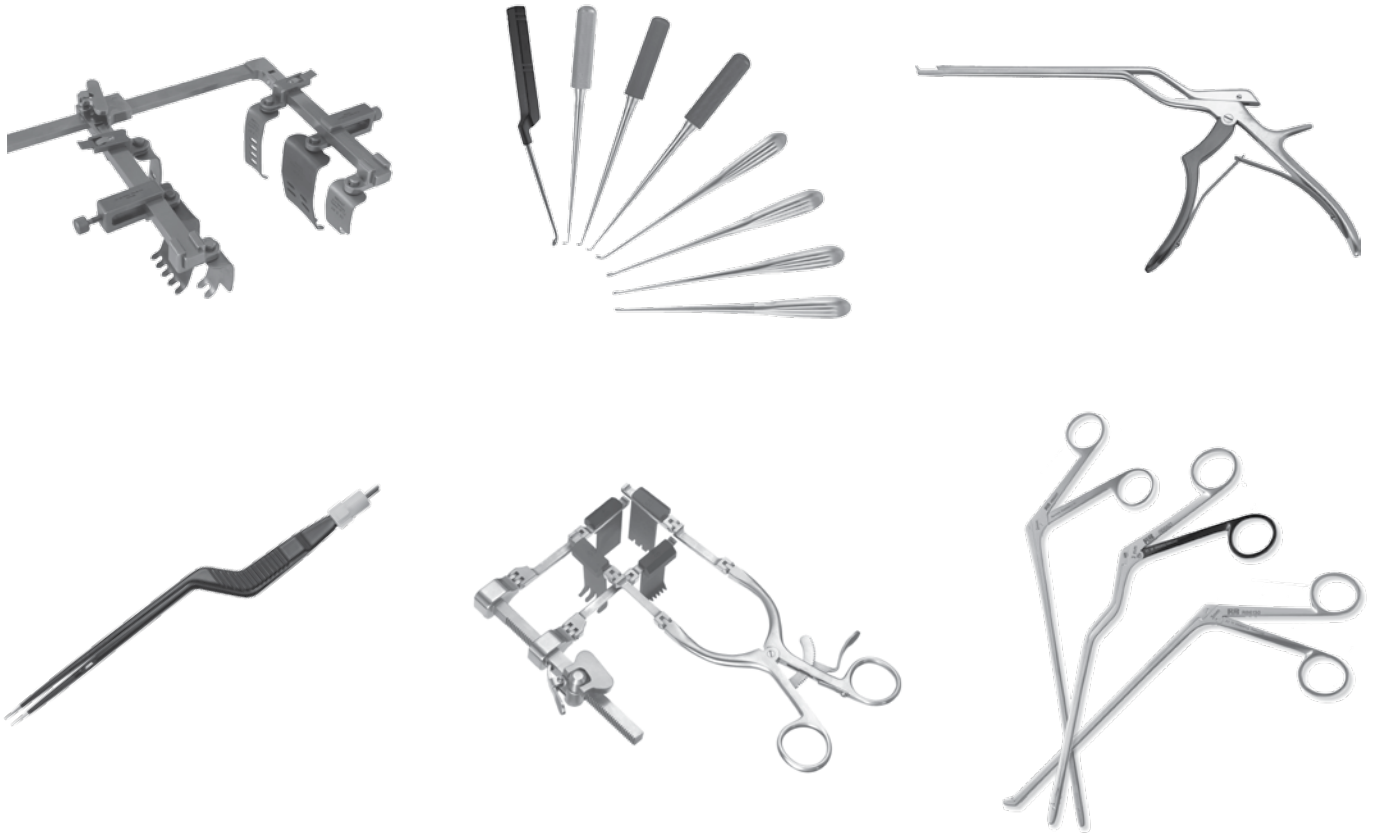

For more information or to place an order, please contact:
Integra ■ 589 Davies Drive, York, PA 17402
877-468-5572 USA ■ 609-750-4259 fax
914-592-9050 outside USA ■ 914-592-8056 outside USA fax
integralife.com

Integra™ Jarit® Laparoscopic Instruments

One-Piece Instruments

Polymer filling and silicone o-rings provide a barrier to bioburden.

Limit uncertainty with confidence and ease of use.



Hunter Bowl Grasper

Fenestrated, 20mm jaws with DeBakey-type teeth for atraumatic manipulation of delicate tissue (e.g. bowel, stomach), double action

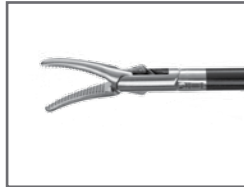

Maryland Dissector

Curved, tapered, serrated jaws with wide spread, double action

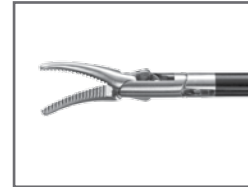

Tapered Maryland Dissector

Curved, finely-tapered, serrated jaws with wide spread, double action



Grasping Forceps

Straight, serrated jaws with proximal recess, double action



Tenaculum Forceps

Single-toothed long jaws designed for grasping of thick tissue, double action



Claw Forceps

2 x 3 interlocking teeth for penetrating hold and extracting tissue

For more information or to place an order, please contact:
Integra ■ 589 Davies Drive, York, PA 17402
877-468-5572 USA ■ 609-750-4259 fax
914-592-9050 outside USA ■ 914-592-8056 outside USA fax
integralife.com

Limit Uncertainty with a smarter instrument management solution.

The Integra™ Instrument Management services provides the highest quality, most up-to-date inventory management program available. Our software makes direct access to complex instrument information as simple as a click of a button. The latest bar coding technology allows the real-time tracking of surgical sets and instruments. Our Integra™ Instrument Management consultants will work with you to facilitate the process and to enhance efficiencies realized with using data wisely. Integra wants to be your long-term source for instrument management.

Our software can provide you with:

- **Electronic maintenance** of count sheet data
- **Cross-referencing** of instruments by various manufacturers
- **Touch screen technology** for easy Tray Assembly with instrument picture display
- **Automation** of sterilization documents and results
- **Scheduled preventative maintenance** and repair documentation
- **On-screen messaging, pictures and videos**
- **Individual Instrument Tracking** capabilities
- Instrument, tray, peel pack and loaner tray **tracking capabilities**
- **Traceability** of items to the patient level
- **Employee productivity** and educational statistics
- **Standard and custom** reports available

Consulting Services:

Physical Inventory

We will perform a physical inventory of your surgical instruments, trays, and equipment, etc., as deemed necessary to assure accurate data at time of installation.

Database Build

Following the inventory, the data is reviewed by our consultants and entered into your new instrument database.

Implementation Services

We will provide software training to customer personnel over the course of several pre-determined visits to cover all aspects of software use and management.

Instrument Expansion/Conversion Product Support

The Integra team will be available to facilities needing assistance with instrument expansion/conversion projects such as physical inventories, set utilization, needs assessments and process flow studies. The Integra team will provide the additional support required to develop standardized trays, process orders, receive/unpack shipments and prepare new trays.

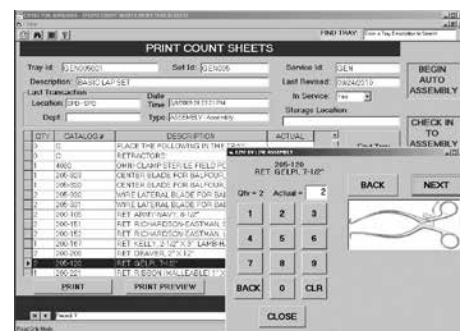

For more information or to place an order, please contact:
 Integra ■ 589 Davies Drive, York, PA 17402
 877-468-5572 USA ■ 609-750-4259 fax
 914-592-9050 outside USA ■ 914-592-8056 outside USA fax
integralife.com

For more information or to place an order, please contact:
Integra ■ 589 Davies Drive, York, PA 17402
877-468-5572 USA ■ 800-275-7192 fax
914-789-7094 outside USA ■ 609-750-4218 outside USA fax
integralife.com

