

MEDICROSS

Tel: +46 31 28 08 00
Fax: +46 31 81 24 24

11

CARDIOVASCULAR
INSTRUMENTS

HERZ- UND GEFÄSS-
CHIRURGISCHE INSTRUMENTE

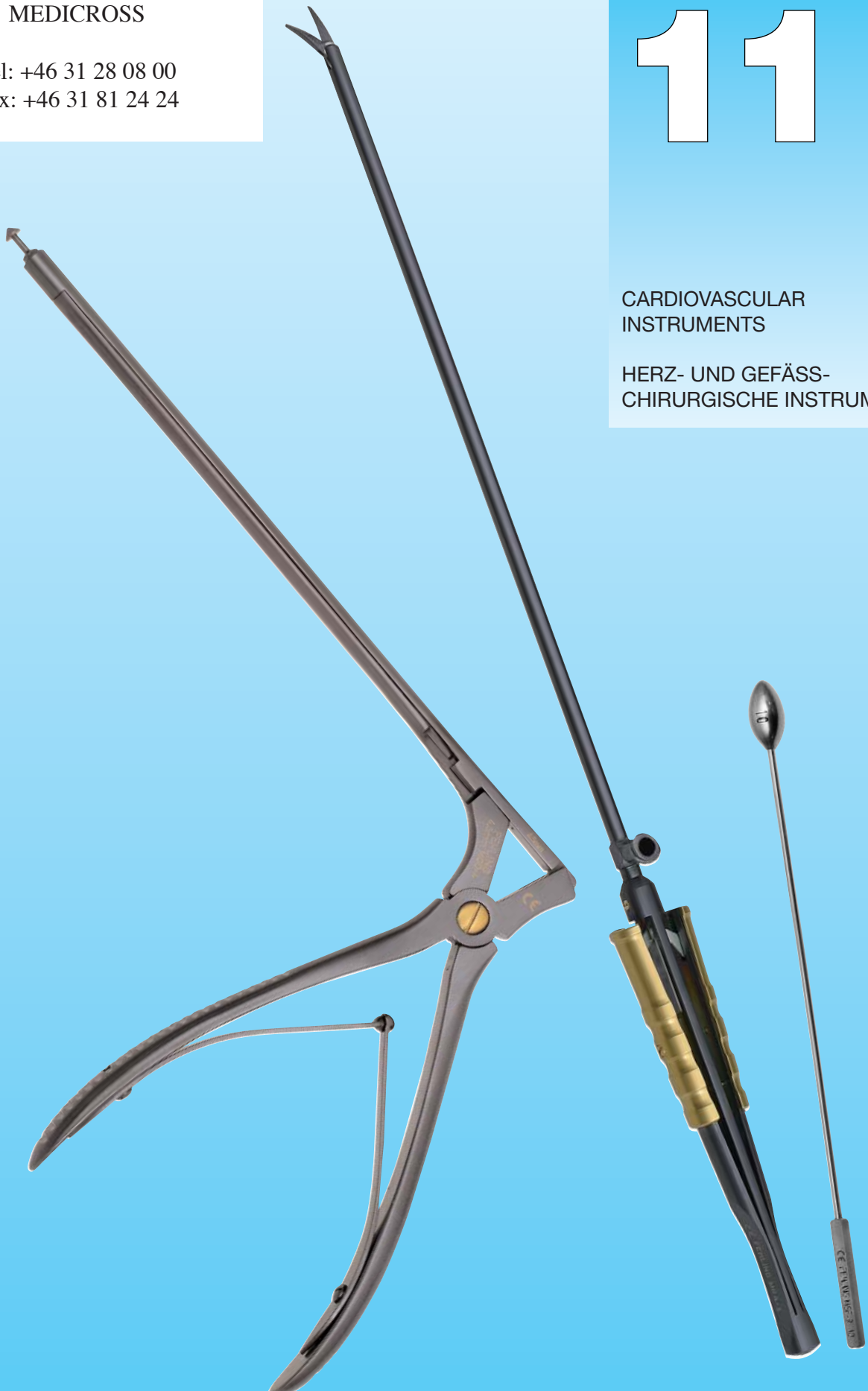

MEDICROSS⁺



LENGTH LÄNGE	
300 mm	MTB-1
400 mm	MTB-2
500 mm	MTB-3
700 mm	MTB-4



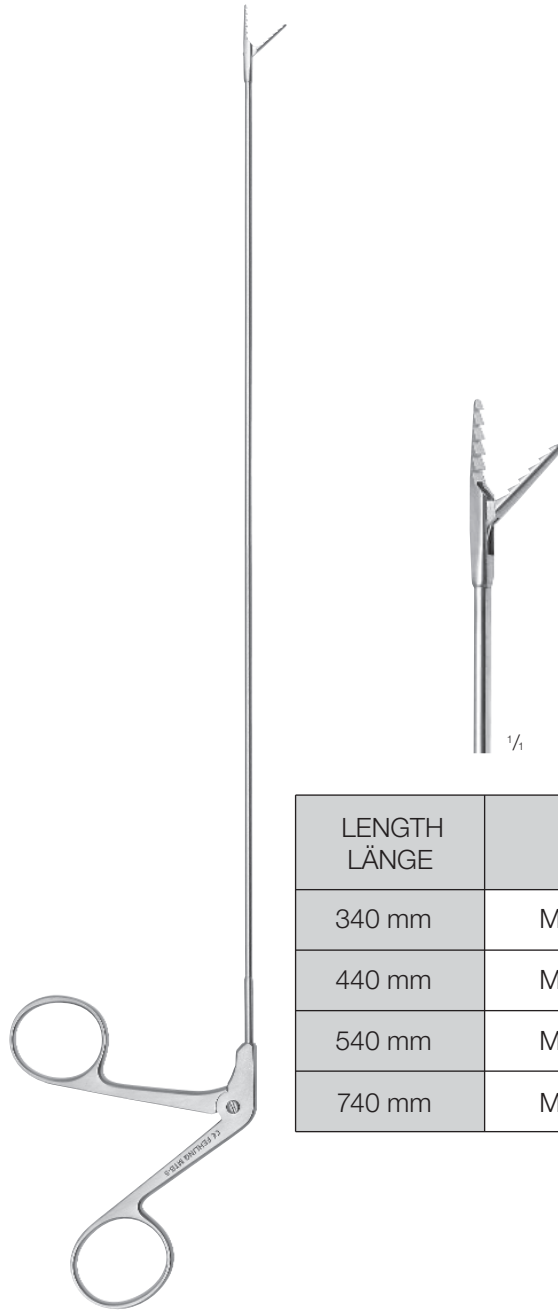

TUNNELING INSTRUMENT
TUNNELIERINSTRUMENT



LENGTH LÄNGE	
340 mm	MTB-5
440 mm	MTB-6
540 mm	MTB-7
740 mm	MTB-8

GRASPING FORCEPS
FASSZANGE



	1,0 mm	1,5 mm	2,5 mm
			
	2,5 mm	2,0 mm	3,0 mm
	MNK-0	MNK-1	MNK-2

SUPERPLAST
OCCLUDER
80 mm



COMB CLAMP
KAMMKLEMME
160 mm
DDA-2



COMPRESSION FORCEPS
KOMPRESSIIONSKLEMMEN
260 mm
MMS-6

Non-traumatic clamps for partial occlusion of the aortic arc
Atraumatische Klemmen für die partielle Okklusion des Aortenbogens



BIRNBAUM

JAW LENGTH MAULLÄNGE	TOTAL LENGTH GESAMTLÄNGE	
50 x 30 mm	310 mm	MNN-2
60 x 30 mm	320 mm	MNN-3
70 x 30 mm	330 mm	MNN-4



CALAFIORE

JAW LENGTH MAULLÄNGE	TOTAL LENGTH GESAMTLÄNGE	
70 mm	270 mm	MMV-0

SUPERPLAST



VASCULAR

Ø OLIVE	LENGTH / LÄNGE	
	140 mm	180 mm
0,5 mm	MNG-0	MNH-0
0,75 mm	-	MNK-7
1,0 mm	MNG-1	MNH-1
1,25 mm	MNK-3	MNK-5
1,5 mm	MNG-2	MNH-2
1,75 mm	MNK-4	MNK-6
2,0 mm	MNG-3	MNH-3
2,25 mm	MNK-8	MNK-9
2,5 mm	MNG-4	MNH-4
3,0 mm	MNG-5	MNH-5
3,5 mm	MNG-6	MNH-6
4,0 mm	MNG-7	MNH-7
4,5 mm	MNG-8	MNH-8
5,0 mm	MNG-9	MNH-9



BOULITO
TUBULAR

Ø OLIVE	LENGTH LÄNGE 180 mm
3,0 mm	MSF-0
4,0 mm	MSF-1
4,5 mm	MSF-2
5,0 mm	MSF-3
5,5 mm	MSF-4
6,0 mm	MSF-5
7,0 mm	MSF-6
8,0 mm	MSF-7
9,0 mm	MSF-8
10,0 mm	MSF-9
11,0 mm	MSG-1
12,0 mm	MSG-2
13,0 mm	MSG-3
14,0 mm	MSG-4
15,0 mm	MSG-5
16,0 mm	MSG-6
17,0 mm	MSG-7
18,0 mm	MSG-8
19,0 mm	MSG-9
20,0 mm	MSH-1
21,0 mm	MSH-2
22,0 mm	MSH-3

SUPERFLEX



VASCULAR

Ø OLIVE	LENGTH / LÄNGE	
	140 mm	180 mm
1,0 mm	MNA-1	MNC-1
1,5 mm	MNA-2	MNC-2
2,0 mm	MNA-3	MNC-3
2,5 mm	MNA-4	MNC-4
3,0 mm	MNA-5	MNC-5



VASCULAR

Ø OLIVE	LENGTH / LÄNGE	
	140 mm	180 mm
1,0 mm	MNB-1	MND-1
1,5 mm	MNB-2	MND-2
2,0 mm	MNB-3	MND-3
2,5 mm	MNB-4	MND-4
3,0 mm	MNB-5	MND-5

ACCESSORIES ZUBEHÖR

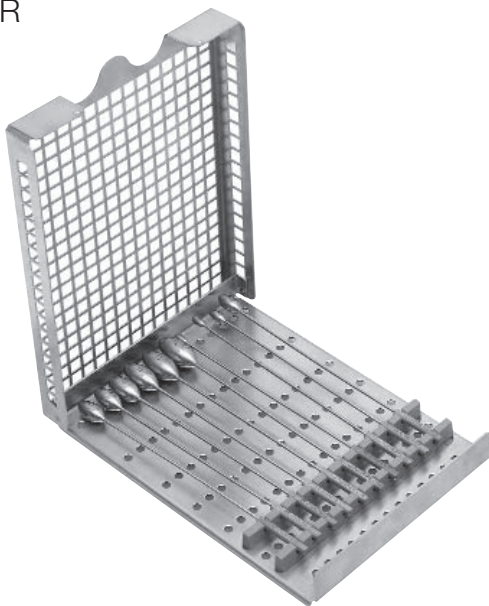

TRAY FOR TUBULAR PROBES
BOX FÜR TUBULARSONDEN



TRAY FOR VASCULAR PROBES
BOX FÜR GEFÄSSSONDEN

max. OLIVE Ø 17 mm 160 x 210 x 26 mm	MSG-0
max. OLIVE Ø 22 mm 160 x 210 x 30 mm	MSH-0

OLIVE Ø max. 5 mm
160 x 210 x 17 mm
MNA-0

SUPERPLAST



AORTIC SIZER
AORTENLEHRE
300 mm



CROSS-SECTION SIZER
QUERSCHNITTSLEHRE
220 mm

Ø A / B	
14 / 16 mm	MNW-7
18 / 20 mm	MNW-1
22 / 24 mm	MNW-2
26 / 28 mm	MNW-3
30 / 32 mm	MNW-4
34 / 36 mm	MNW-5
38 / 40 mm	MNW-6

TRAY FOR SIZERS BOX FÜR AORTENLEHREN 310 x 215 x 45 mm	MNW-0
--	-------

Ø A / B	
18 / 20 mm	MNX-1
19 / 21 mm	MNX-6
22 / 24 mm	MNX-2
23 / 25 mm	MNX-7
26 / 28 mm	MNX-3
27 / 29 mm	MNX-8
30 / 32 mm	MNX-4
31 / 33 mm	MNX-9
34 / 36 mm	MNX-5



CALIBER FOR AORTIC
VALVE CUSP
LEHRE FÜR
AORTENKLAPPENSEGEL
MSS-1



RULER
MESSSTAB
160 mm
MNV-0



LENGTH GAUGE
LÄNGENLEHRE

230 mm	350 mm
MNV-4	MNV-7



CHORDAE / CUSP
RETRACTOR
CHORDAE- /
SEGELRETRACTOR

240 mm	350 mm
MNV-1	MNV-8

CERAMO®

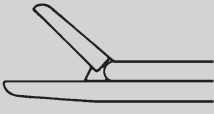
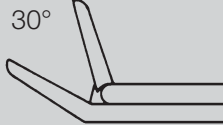

GRUMME

WIDTH BREITE mm	LENGTH LÄNGE mm		30° 
2,0	160	NLT-2	NLT-6
	180	NLU-2	NLU-6
3,0	160	NLT-3	NLT-7
	180	NLU-3	NLU-7
4,0	160	NLT-4	NLT-8
	180	NLU-4	NLU-8
5,0	160	NLT-5	NLT-9
	180	NLU-5	NLU-9

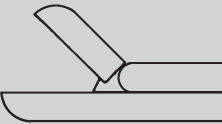
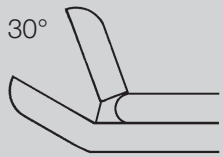

FERRIS-SMITH

WIDTH BREITE mm	LENGTH LÄNGE mm		30° 
3,0	200	TOG-1	TOH-1
4,0	200	TOG-2	TOH-2
5,0	200	TOG-3	TOH-3

STERILE SINGLE USE BIOPSY FORCEPS
STERILE EINMALBIOPTOME



LENGTH OF SHAFT SCHAFTLÄNGE	1,6 mm	1,8 mm	2,2 mm
510 mm	MOA-1	MOA-5	MOA-9
800 mm	MOA-2	MOA-6	-
1000 mm	MOA-3	MOA-7	-
1200 mm	MOA-4	MOA-8	MOB-1

SOFT SHAFT
WEICHER SCHAFT

510 mm	-	MOB-4	-
1200 mm	-	MOB-5	-

REUSABLE BIOPSY FORCEPS
WIEDERVERWENDBARE BIOPTOME

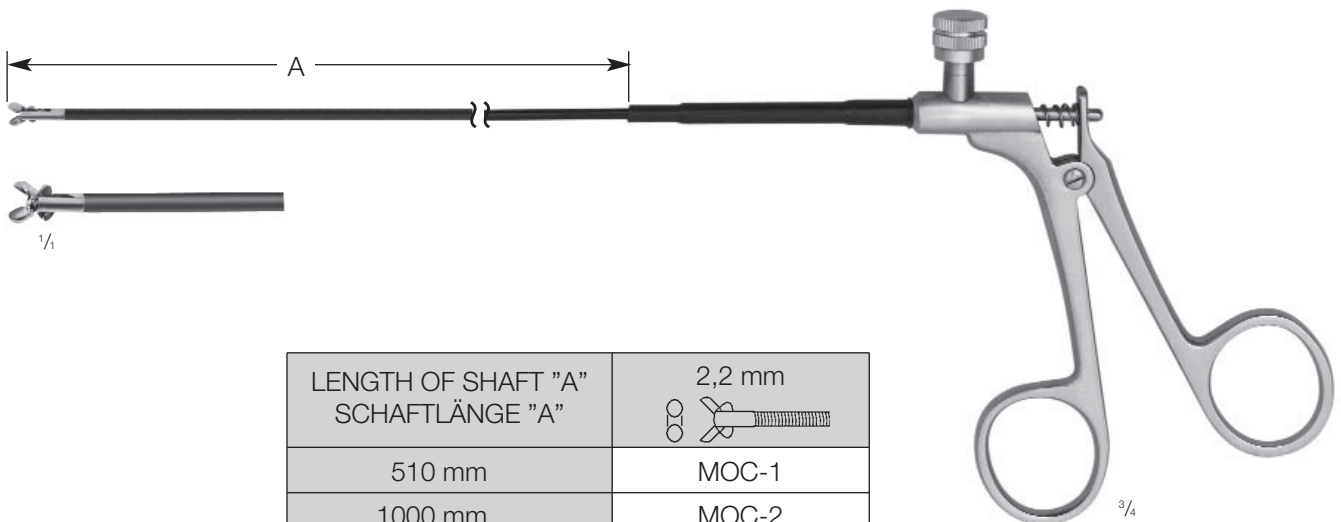

LENGTH OF SHAFT "A" SCHAFTLÄNGE "A"	2,2 mm
510 mm	MOC-1
1000 mm	MOC-2
1200 mm	MOC-3

SUPERPLAST



PETZOLD
250 mm

STRIPPER FOR VARICOSE VEINS
VARIZENSTRIPPER

Ø	
2 mm	MIE-7
3 mm	MIE-8
4 mm	MIE-1
5 mm	MIE-2
6 mm	MIE-3
7 mm	MIE-4
8 mm	MIE-5
10 mm	MIE-6

SUPERFLEX



500 mm

INSTRUMENTS FOR THROMBECTOMY
INSTRUMENTE FÜR THROMBEKTOMIE

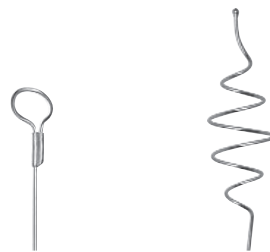

Ø	RING STRIPPER* RINGSTRIPPER*	SPIRAL CURETTE** SPIRALKÜRETTE**
3 mm	MIB-3	-
4 mm	MIB-4	-
5 mm	MIB-5	MID-1
6 mm	MIB-6	MID-2
7 mm	MIB-7	MID-3
8 mm	MIB-8	MID-4
9 mm	MIB-2	MID-5
10 mm	MIB-9	MID-6
12 mm	MIB-0	-
14 mm	MIB-1	-

* FOR NATIVE VESSELS / FÜR NATÜRLICHE GEFÄSSE

** FOR PROSTHESES / FÜR PROTHESEN













HANDLE / GRIFF
105 mm
ABB-5

HCR



				
1 x 10 mm	2,8 x 15 mm	2,8 x 15 mm	3,0 x 15 mm	2,0 x 10 mm
SUTURE FORCEPS NAHTPINZETTE	NON-TRAUMATIC FORCEPS ATRAUMATISCHE PINZETTE		VALVE FORCEPS KLAPPENPINZETTE	NEEDLE HOLDER NADELHALTER
345 mm	350 mm	350 mm	350 mm	340 mm
MRA-5	MRA-4	MRA-3	MRA-0	MRB-2

					
3 x 10 mm	45°	90°			
NEEDLE HOLDER NADELHALTER	VASCULAR SCISSORS GEFÄSS-SCHERE		DISSECTING SCISSORS PRÄPARIERSCHERE	VALVE SCISSORS KLAPPENSCHERE	ORGANFASSZANGE GRASPING FORCEPS
340 mm	345 mm	335 mm	350 mm	350 mm	350 mm
MRB-1	MRA-8	MRA-9	MRA-6	MRA-7	MRL-8

				
1 x 7 mm	25°	10 mm		
NERV HOOK NERVHAKEN	KNOT PUSHER KNOTENSCHIEBER	VALVE INSPECTOR KLAPPENPRÜFINSTR.	SCALPEL HANDLE* SKALPELLGRIFF*	MAGNETIC FINDER MAGNETSTAB
340 mm	340 mm	350 mm	350 mm	350 mm
MRB-4	MRB-6	MRL-2	MRL-4	MRL-5

335-350 mm





SHAFT DIAMETER = 5.0 mm
SCHAFTDURCHMESSER = 5,0 mm





*FOR BEAVER BLADES
FÜR BEAVER MESSER

HCR



280-290 mm

			
1,2 x 8 mm	1,2 x 15 mm	1,2 x 12 mm	1,2 x 12 mm
SUTURE FORCEPS NAHTPINZETTE	NON-TRAUMATIC FORCEPS ARAUMATISCHE PINZETTEN		
280 mm	290 mm	280 mm	280 mm
MRC-1	MRC-2	MRC-3	MRC-0

				
1 x 10 mm	2 x 10 mm		45°	125°
NEEDLE HOLDER NADELHALTER		DISSECTING SCISSORS PRÄPARIERSCHERE	VASCULAR SCISSORS GEFÄSS-SCHERE	
280 mm	280 mm	280 mm	280 mm	280 mm
MRC-5	MRC-4	MRC-6	MRC-7	MRC-8

SHAFT DIAMETER = 3.5 mm
SCHAFTDURCHMESSER = 3,5 mm

HCR

NON-TRAUMATIC CLAMPS
ATRAUMATISCHE KLEMMEN

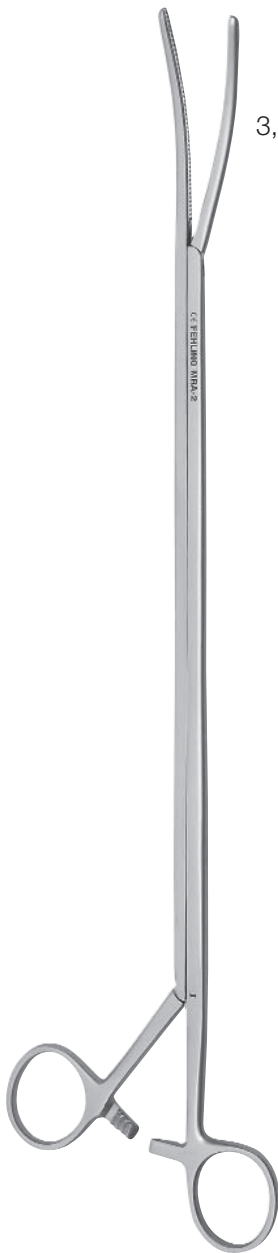

330 mm
MRA-2



290 mm
MRB-0



360 mm
MRA-1



2 mm
1/4

CANNULA FOR CARDIOPLEGIA
KARDIOPLEGIEKANÜLE
270 mm
MRL-1V

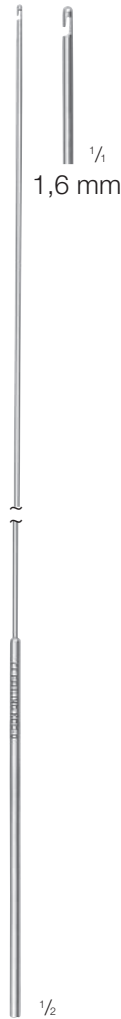

1,6 mm
1/4

SUTURE HOOK
FADENFÄNGER
350 mm
KCC-0



HANDLE FOR KCC-0
GRIFF FÜR KCC-0
110 mm
ABB-1

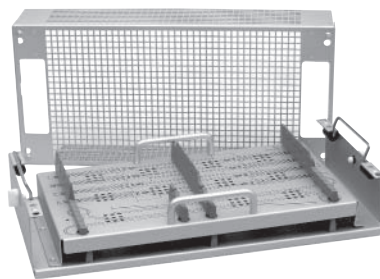

TRAY FOR HCR INSTRUMENTS
CONTAINER FÜR HCR-INSTRUMENTE
550 x 250 x 100 mm

MRC-9