

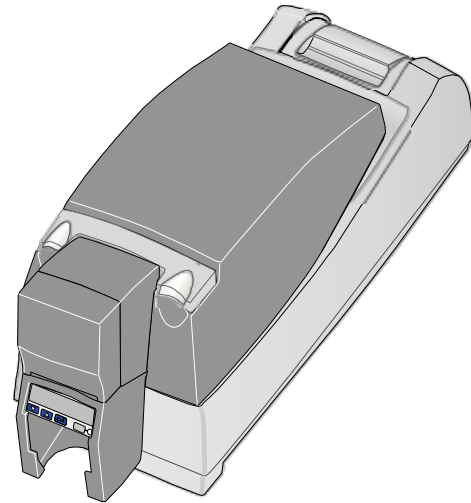





CP60 Printer Guide

558871-201 Rev. E

July 2005

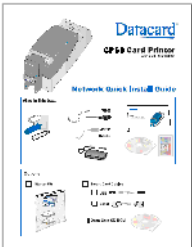

Information resources for the CP60 Card Printer

CP60 Quick Install Guide	The Quick Install Guide, packed at the top of the printer carton, shows you the steps to install the printer. For detailed installation information, see e-Guide/InfoCent.chm on the driver CD-ROM.	
CP60 Printer Guide	The Printer Guide (this document) contains operating information for the printer. It also tells you how to install the printer.	
Info Central	For in-depth information about using the printer, install <i>Info Central</i> on a Windows PC, then click the icon on the desktop. (Insert the Card Printer CD-ROM and choose User Information to install <i>Info Central</i> .)	
Data Formatting Guide	Describes how to set up the printer and your data stream to use the Open Card data format. Find the Guide on the Open Card CD-ROM, shipped only with the Open Card option.	
Dealer	For help with questions not addressed by other CP Series printer information, contact your dealer.	
Customer Care	Contact the Datacard Customer Care Center at 1.800.328.3996 (U.S. & Canada) or 1.952.988.2316 (worldwide).	

About the printer	1	Set up the network printer	30
The outside of the printer	1	Set the Data Format	34
The inside of the printer	3	Set up for your card design	35
Features and options	3	SNMP Support	36
Loading cards	5	Print a card	37
Loading print ribbon	7	From the CP Driver	37
Power on the printer	9	Using the Open Card data format	38
The LCD panel	10	Cleaning the printer	39
Make a printer test card	13	Cleaning the printer rollers	41
Data formats for the CP60 Card Printer	15	Getting the most out of your printer	43
CP Driver data	16	Printer LCD settings	45
Open Card data format	17	LCD menu system	46
Data formats summary	19	View status settings	47
Printer Installation	21	View the Serial Number	47
Site requirements	22	View the Firmware Revision	48
Useful tools	23	View Card Counts	49
Network installation	25	View the Data Format	50
Prepare the printer for installation	26	View the Network Address Mode, IP Addresses, and MAC Address	51
Connect the printer to the network	27	Change settings	53

Set LCD Backlighting	53	SY-01310 Flash Error	73
Set the Data Format	54	SY-01312 Flash error	74
Set the Address Mode	55	SY-01314 Flash Error	75
Set the IP Address, Subnet Mask, and Gateway Address.	57	SY-01317 Memory Error	76
Set the K Power	59	SY-01325 Data Error	77
Troubleshooting	61	SY-01327 Data Error	79
Printer supplies	63	SY-01331 Comm Error	80
Color print ribbon	63	SY-01332 Hardware Error	81
Monochrome and Topcoat ribbon	63	MS-01401, MS-01402, MS-01403 Mag Stripe Data	82
Monochrome print ribbon	63	MS-01404, MS-01405, MS-01406 Mag Stripe Error	83
Cleaning supplies.	64	MS-01407, MS-01408, or MS-01409 Mag Stripe Error	84
Printer messages	65	MS-01410, MS-01411, or MS-01412 Mag Stripe Error	85
DM-00760 Duplex Error	66	MS-01413, MS-01414, or MS-01415 Mag Stripe Error	86
DM-00762 Duplex Jam	67	MS-01417, MS-01418, MS-01419, MS-01420, MS-01421 Card Jam	87
DM-00765 No Duplex.	68	MS-01424 Mag Stripe Error.	89
DM-00767 Duplex Jam	69		
IS-01206 No Card Picked	70		
SY-01305 Data Error	71		
SY-01306 Data Error	72		

MS-01425 Mag Stripe Error	91	PR-01721 EEPROM Error	106
MS-01426 EEPROM Error	92	PR-01723 Hardware Error	107
MS-01427 or MS-01428 Mag Stripe Error	93	PR-01724 Ribbon Break	109
MS-01429 Mag Stripe Data	94	PR-01726 Ribbon Out	111
MS-01430 Mag Stripe Error	95	PR-01730 Printhead Error	112
MS-01435 No Mag Stripe.	96	PR-01737 Ribbon Low.	113
PR-01703 Printhead Error	97	PR-01738 Ribbon Error	114
PR-01705, PR-01706 Card Jam	99	SC-01804 No Smart Card	115
PR-01710 EEPROM Error	101	Safety and compliance (FCC).	124
PR-01715, PR-01716 Cover Open . . .	102	Regulatory compliance	124
PR-01718 Printhead Temp	103	Liability statement	126
PR-01719 Printhead Error	104	Safety.	127
PR-01720 Ribbon Error	105	Acknowledgments	128

About the printer

This guide applies to CP60 Card Printer. The information also applies to the SP60 Card Printer. The printers include the Built-in Ethernet feature and can include the Open Card option.

The outside of the printer

Duplex Module: Optional module at the back of the printer that turns the card to print the other side.

Printer Cover.

Latch: Lift the latch to open the printer cover.

Input Hopper: Open the cover to load blank cards.

LCD Panel: Shows the printer status and any messages. Use the LCD panel to change network settings.

Ready Key: Push to pause or resume the printer.

The Status Light helps you understand printer operation. See ["The LCD panel" on page 10](#) for details.

Output Hopper: Remove completed cards.

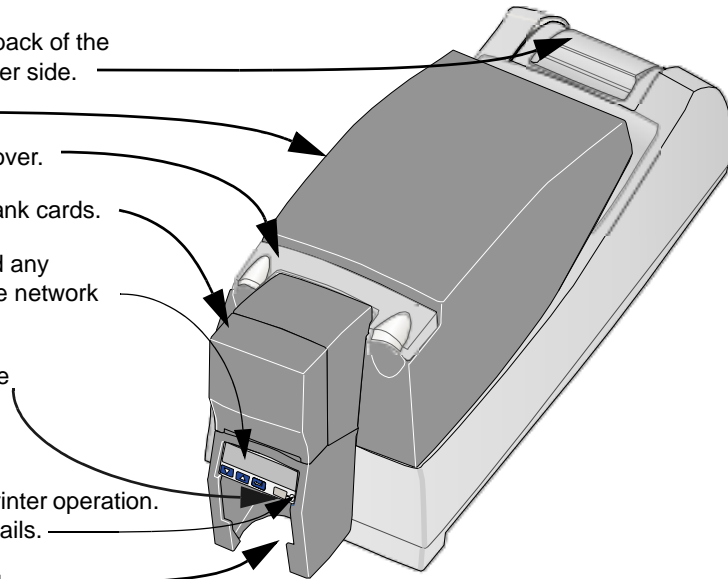

Ports are located on the left side of the printer.

Network Port: Use the Ethernet port to connect a printer with the Built-in Ethernet feature.

USB Data Port: Connect the data cable to the printer. *ALL* printers have this port.

Manual Advance Knob: Use to move a card in the printer or to turn rollers.

Power Receptacle: Plug in the power supply to power on the printer.

Security Lock Receptacle: Connect the optional security lock to the opening under the ledge of the printer (not visible in this drawing).

Cable Guides: Place the data cable in the guides. (You can also place the power cable in the guide.)

Optional Smart Card USB Port: See ["Features and options" on page 3](#).

Optional Smart Card Serial Port: See ["Features and options" on page 3](#).

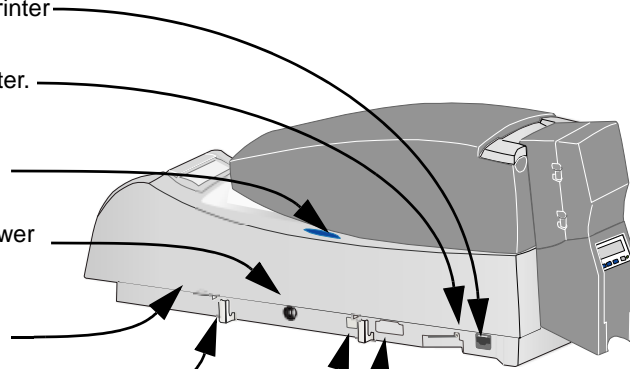

The inside of the printer

Cover Arm: Holds the cover and printhead cartridge in place.

Printhead Cartridge: Applies the image to the card. The label includes "YMC" for color or "K" for monochrome printheads.

Print Ribbon Cartridge (shown with color print ribbon).

Printer Label: Includes the serial number and model information (located on the left side of the printer and not visible in this drawing).

Cleaning Roller (not visible in this drawing): Removes dust and debris from cards.

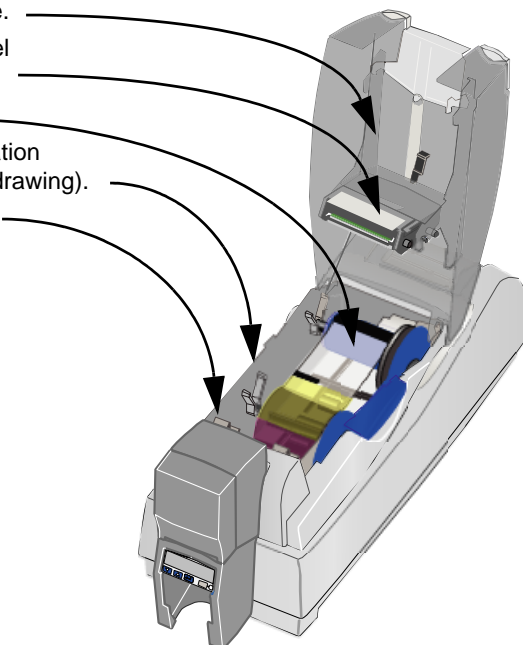

Features and options

Features and options are identified on the printer label:

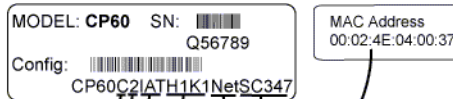

- Printing: C or U
- Duplex: 2
- Magnetic Stripe: IAT
- Hopper: H1 or H2, K1
- Connection: Net or OC
- Smart Card
- MAC Address label

- Printers have a MAC address label.

- Printers with “U” **printing** can print one color (monochrome) only. “C” printing is full-color or monochrome (with specific ribbons).
- All CP60 printers have a USB data **connection**. They also have one of the following:
 - Built-in Ethernet (Net) connection
 - Open Card (OC) data format and Built-in Ethernet
- Printers can include a **duplex** (2) module.
- A **magnetic stripe** module can be a three-track (IAT) module.
- Printers can have a 100-card (H1) or 200-card (H2) **input hopper**. The input hopper can have a **lock** (K1).

- An optional **smart card** module can have:
 - Combination smart card reader (SC347) with contact and contactless reader. Visible inside the printer; includes a USB port on the printer.
 - Contactless iCLASS® (SC205) or HID® (SC202) reader; includes a USB port.
 - Contact station (SC400): Visible inside the printer; includes a serial port.

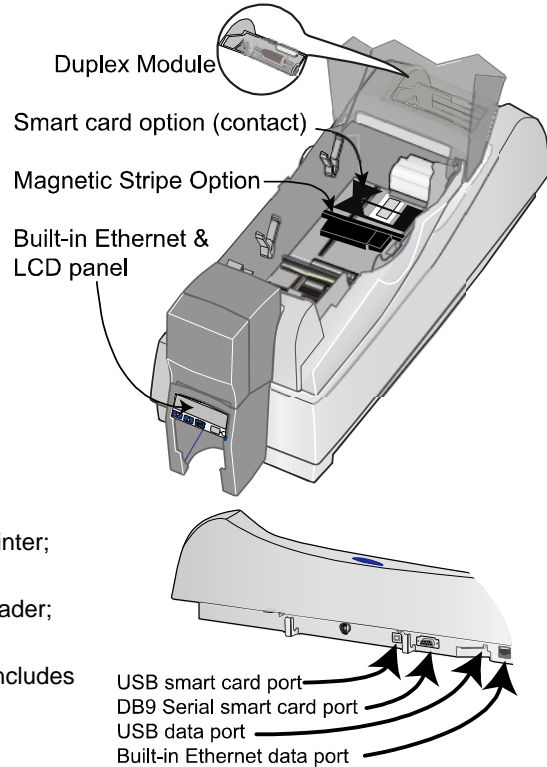

Loading cards

- 1 Open the input hopper cover.
- 2 Remove cards from the original package.

Tips: Handling cards

- Cards can stick together: Slide or fan cards to separate the edges.

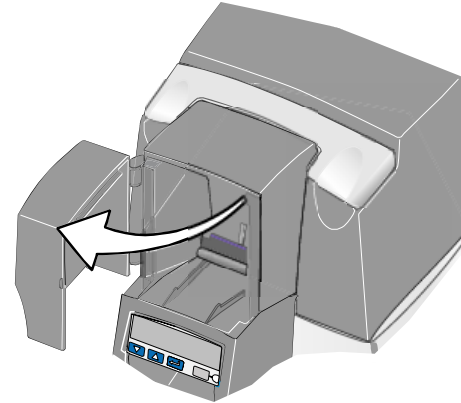
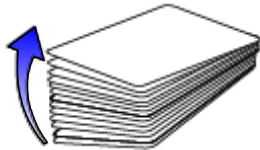

- Do not touch the surface of cards before printing them. (Oils on hands will reduce printing quality.)
- Handle cards by the edges or wear gloves.
- Orient all cards the same way.

- 3 Place the cards in the input hopper.

The diagram shows the typical locations for the magnetic stripe and smart card chip.

- 4 Push the input hopper cover closed until it latches.

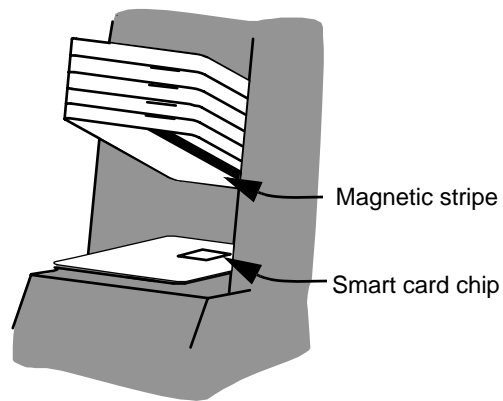

See *Info Central* for current information about cards to use in the printer.

Loading print ribbon

- 1 Open the printer cover.
- 2 Remove the ribbon cartridge.
- 3 Remove both used ribbon spools from the cartridge (if present).

Tips: Handling print ribbon

- Keep unused ribbon in the original package.
 - Don't place ribbon on a dusty or dirty surface—dirt could damage the printhead.
- 4 Run a cleaning card and replace the cleaning sleeve at the same time that you load a new print ribbon. See ["Cleaning the printer" on page 39](#) for the steps to follow.

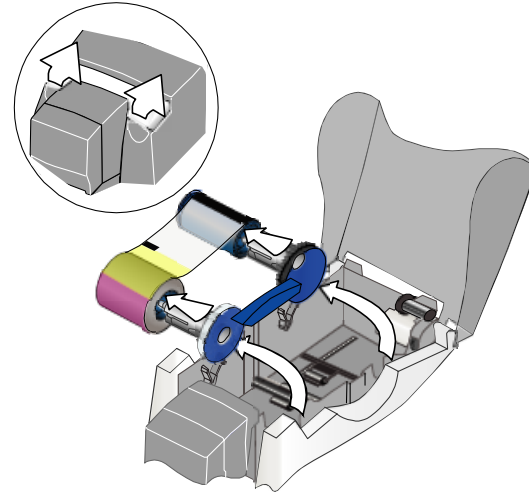

- 5 Load the new roll of print ribbon on the cartridge.
 - Put the full spool of ribbon on the supply spindle of the ribbon cartridge. Push until the spool clicks onto the spindle.
 - Put the empty take-up spool on the spindle with the solid black gear. Push until the spool clicks onto the spindle.
- 6 Replace the loaded ribbon cartridge in the printer.
 - Make sure both spindles rest in the black supports on the left side of the printer.
 - Make sure the ribbon cartridge handle rests in the supports on the right side of the printer.
 - Make sure to install the full, new spool toward the input hopper of the printer.

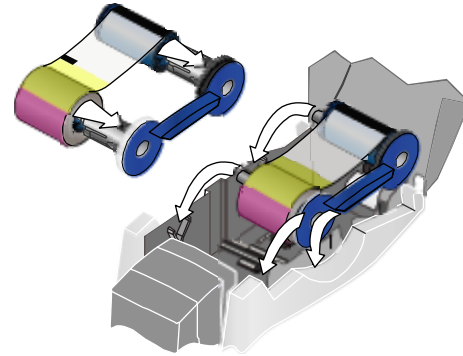

Close the printer cover. Press down firmly to latch it.

Power on the printer

Plug in the printer to power it on. **The printer does not have a power switch.**

- 1 Make sure the power supply cord connects to the printer power receptacle (1).
- 2 Connect the power cord to the power supply (2).
- 3 Connect the power cord to the power outlet (3).
- 4 The printer powers on and the Status Light is amber.
- 5 When the printer is ready to print cards, the Status Light displays steady green.

The printer must be connected to a computer (locally or through a network) to print cards. See "[Printer Installation](#)" on page 21.

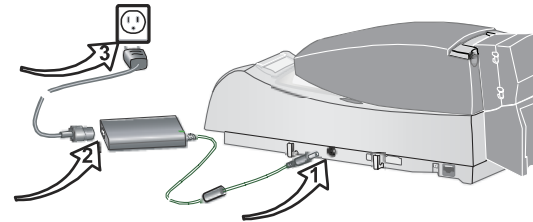

Tips for printer power

- Wait while the printer initializes.
- Follow the guidelines for your organization about when to power the printer on and off.

The LCD panel

The CP60 Card Printer with built-in Ethernet includes an LCD panel. The LCD panel has a 2-line display, four keys, and the Status light.

This section describes what you need to know when printing cards. See "[Printer LCD settings](#)" on page 45 for detailed information about viewing and changing network settings.

The LCD panel provides the following:

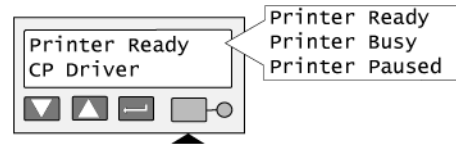
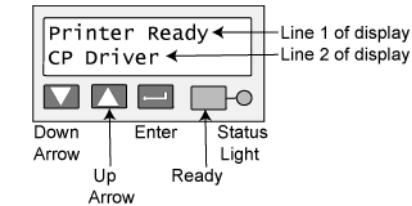

- Current State (line 1): Shows whether the printer is ready to print, is busy, or is paused.
 - Press the Ready key to pause or resume the printer (undo pause).
- Data format (line 2): The type of data the printer is ready to accept.
- Printer messages: The display shows the message number and a short description of the problem.
 - Fix the problem and then press the Ready key to clear the message. Repeat if another message is displayed.



- See "[Printer messages](#)" on page 65 for details about messages.
- Status: Information about the printer, including printer card counts and network settings. To view status details:

— Press the Enter key  to move to the Main Menu.

— Press the Enter key again to enter the Status Menu.

— Press the Up Arrow  or Down Arrow  key to scroll through the Status Menu choices.

— Press the Enter key to view the data.

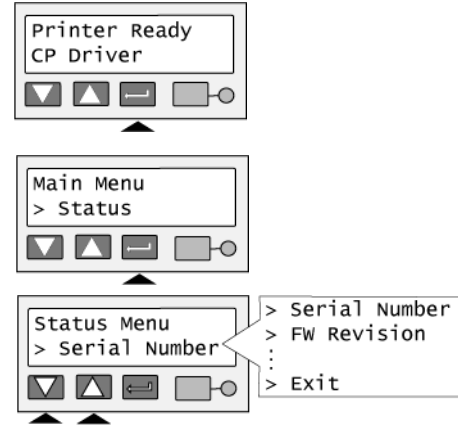

— Press the Enter key again to return to the menu.

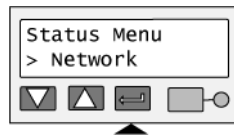

— Scroll to "Exit" and press the Enter key to leave a choice.
Repeat as needed to leave the menus.

See "[Printer LCD settings](#)" on page 45 for details about viewing and changing settings.



Make a printer test card

- 1 Power off the printer.
- 2 Confirm that cards and print ribbon are loaded in the printer.
 - If the printer has a magnetic stripe module, the card for a printer test card must have a magnetic stripe.
 - If it is a three-track module, be sure to use blank cards with the correct coercivity (the default is high coercivity cards, which are shipped in the Starter Kit.)
 - If the printer has been installed previously and has used a custom magnetic stripe format, you might need to set the printer to use the default encoding format for the module. See *Info Central* for information on Magnetic stripe setup.
- 3 Power on the printer (1). Within 5 seconds, press and hold the Ready key (2), as shown in the illustration. Hold the Ready key firmly until the printer sounds three tones and displays "Printer Test Card" on the LCD panel, usually about 15 to 30 seconds.
- 4 Release the Ready key and observe the printer. You hear the internal components initialize and the printer starts processing the card.

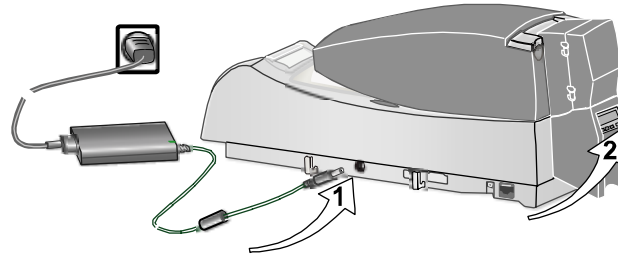

- 5 After it is printed, remove the card from the output hopper.

Tips for success

- Allow 30 to 60 seconds for the printer to begin printing the test card.
- The status light will flash green while the printer is processing the data.
- If the status light is steady amber and the printer beeps, the printer is paused. Press the Ready key once to un-pause the printer.
- If the printer test card did not print successfully, try the procedure again, making sure you follow the instructions. If the test card does not print, or if the printer does not initialize, contact your service provider.

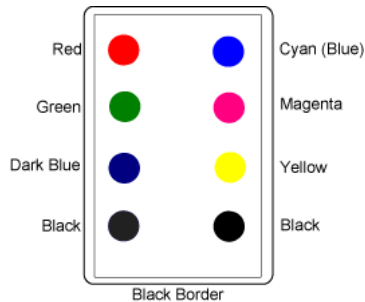

- The test card has the pattern shown. (The pattern will be monochrome dots, not colored dots, if the printer uses a monochrome ribbon.)

Data formats for the CP60 Card Printer

All CP60 printers are shipped with the CP Driver CD-ROM, and can print cards sent by the CP Driver (when the Data Format is set to CP Driver). The printer can also be purchased with the Open Card option. Printers with the Open Card option can also print cards using the Open Card data format (when the Data Format is set to Open Card). This section describes the requirements and functionality of each format.

CP Driver data

The printer can be used with the CP Driver installed on a PC. The CP Driver receives data from your Windows application and formats it for the printer. The printer can print one or both sides of the card (duplex printing), print in landscape or portrait orientation, and print in full color or one color.

The driver formats (renders) the data for each card. It can accept text, photos, backgrounds, logos and other elements such as bar codes if they are supported by the Windows application. With the corresponding options, the printer can encode a magnetic stripe on the front or back of the card and read or program a smart card.

The sample card on this page is printed when you use the “Print Sample Card” button of the Printer Toolbox, which is part of the CP Driver. It shows typical features of a card printed using the CP Driver and the printer (with a full-color ribbon).

When you print from the CP Driver, any errors on the printer cause a message to be displayed on the PC, in addition to being displayed on the printer LCD panel. For best results, use buttons on the message box to clear the message from the printer and driver. (This also clears the message from the LCD panel.) Using the driver provides you with advanced features including retrying the card.



Open Card data format

The Open Card data format uses ASCII data. Any host computer that can generate an ASCII (text) data stream and send it to the printer using TCP/IP (or TCP/IP with LPD/LPR) can send card data using the Open Card data format. Organizations that use operating systems other than Windows can print cards without inserting a PC between the host computer and the printer (provided that the systems can generate an ASCII data stream).

The Open Card feature provides two methods for specifying the format of the data; supported Open Card commands and Card Layout menus in the printer. For organizations that currently send data tagged with Open Card commands to a printer or embosser, the printer can produce printed cards from the same data stream. Or, you can use the Card Layout menus to define card designs that reside in the printer and format the data.

The Open Card feature supports printing text, printing bar codes, printing logos, and encoding magnetic stripe data on a card. For text, you can choose from several fonts and sizes that are printer-resident. For bar codes, you can also choose from several bar code fonts (for different types of bar codes) and sizes. For graphics, you can download up to four black-and-white logo files to the printer and choose where to place the files on the card. The printer does not provide the ability to download a different graphic for each card. Each text or graphic field can be rotated independently. In addition, the entire card design can be rotated to change the relationship of printing to the magnetic stripe.

For magnetic stripe data, you can define encoding formats in the printer (using Printer Diagnostics) and then send up to three tracks of data (with a magnetic stripe option). For some features, you must use a PC running the CP Driver and Printer Diagnostics to configure the printer. After configuring, you can use the host computer to send Open Card data and print cards.

The Open Card format supports printing with one color on one side of the card in landscape mode. If you use a full-color ribbon in a full-color printer when you send Open Card data, the printer will use only the K panel in the

ribbon and ignore the color and topcoat panels. The magnetic stripe (if it is encoded) must be located on the side of the card opposite the printing.

The following card shows some of the features available using the Open Card format.

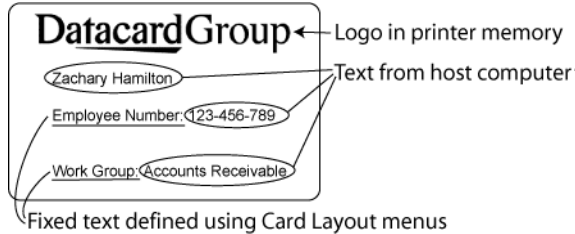

When you use the Open Card format, messages are displayed on the printer LCD panel. This guide provides information for fixing problems. Use the Ready key on the LCD panel to clear the message from the printer.

The Open Card features are typically used with an Ethernet connection and a network. You can also use the Open Card data format through the printer USB port when using a print server. See the *Data Formatting Guide* for details on using the Open Card format.

See ["Network installation" on page 25](#) for details on installing and setting up the printer for the data format you choose.

Data formats summary

The following table summarizes the requirements and features for each data format.

	Open Card	CP Driver
Source of data	Any host computer that produces an ASCII data stream and uses TCP/IP (RAW or LPD/LPR)	Windows application (with the CP Driver running on a Windows PC)
Data formatted by	Open Card commands or Card Layout menus	CP Driver running on a Windows PC
Type of connection	Ethernet port	Ethernet or USB ports
Printer Messages	Displayed on LCD panel	Displayed in Windows message boxes and on LCD panel
Configuration tools	<ul style="list-style-type: none"> • Network configuration utility and LCD panel • Telnet to use Card Layout menus (optional) • Text editor or batch process to insert Open Card commands in data (optional) • Printer Diagnostics (on PC with CP Driver) 	<ul style="list-style-type: none"> • Network configuration utility and LCD panel • Printer Toolbox • Printer Properties and Printing Preferences • Printer Diagnostics (on PC)

	Open Card	CP Driver
--	-----------	-----------

Features:

- | | | |
|-------------------------------------|--------------------------------------|--|
| • Print on both sides | • No | • Yes |
| • Portrait or landscape orientation | • Landscape only | • Both |
| • Rotate card 180 degrees | • Yes | • Yes |
| • Rotate fields | • Yes | • Yes (using an application) |
| • Full-color or monochrome printing | • Monochrome only | • Yes (with full-color printing feature) |
| • Unique graphics on each card | • Up to 4 downloaded logos on a card | • Yes |
| • Different design for each card | • No | • Yes |
| • Magnetic stripe encoding | • Yes | • Yes |
| • Smart Card programming | • No | • Yes |

Example:



Printer Installation

This section describes the following:

- Site requirements
- Useful tools for network installation and setup
- Preparing the printer for installation
- Connecting the printer to the network
- Setting up the printer on the network
- Setting up the printer for your card design
- SNMP (Simple Network Management Protocol) support

Site requirements

Operating environment

- Relative humidity: 20% to 80% non-condensing
- Temperature: 60° F to 95° F (15° C to 35° C)

Electrical requirements

- The power supply is rated at 100-240 VAC, 50-60 Hz, 1.8 amp. (It adjusts to any power within this range.)
- Single phase, 3-wire, grounded receptacle only.

Physical requirements

- The printer weighs less than 11.5 pounds (5.3 kg). The weight depends on the supplies and options installed.
- Printer dimensions are 21.5 inches (546 mm) long, and 7.8 inches (198 mm) wide. The 100-card input hopper is 9.5 inches (241 mm) high and the 200-card hopper is 11.9 inches (302 mm) high.
- The clearances required are 1 inch (25 mm) at the back, 2 inches (51 mm) on the left side, and 10.5 inches (267 mm) above the printer latch to open the cover.

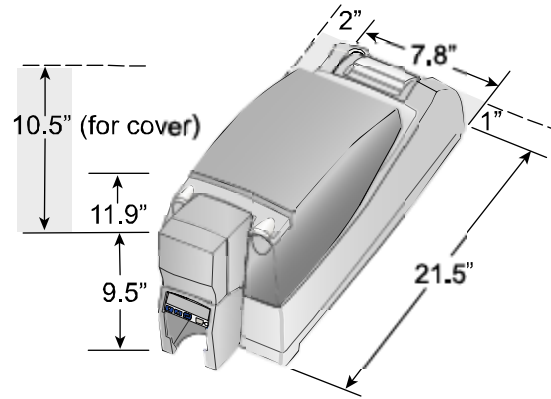

Useful tools

When you set up a CP60 Card Printer with Built-in Ethernet feature, you might use several tools. These tools are part of the network operating system and a computer operating system; they are not provided with the printer.

- Network configuration utility

When the printer is set up on the network where cards are produced, network support personnel use one or more utilities to view and monitor the network. The CP60 printer was tested with HP® Web Jetadmin® on Windows XP (service pack 2).

- Command prompt

If you are not using the CP Driver, you can use a command prompt to type commands and use utilities to set up the printer. You might also find a command prompt helpful for network testing.

- Ping

Ping is a network utility that obtains a response from a device connected to the network. It is a quick way to query an IP address to verify that it is functioning on the network. The printer responds to Ping.

If the printer includes the Open Card option and you plan to send Open Card data, you might use several additional tools, including the following:

- Telnet

Most operating systems include a telnet utility. The CP60 printer with the Open Card option provides Card Layout menus through a telnet interface.

- tiff2opencard

The Open Card CD-ROM includes the tiff2opencard utility, which you use to prepare logos (graphics) before sending them to the printer.

- file2prn

The Open Card CD-ROM includes the file2prn utility, which you use to send files, including logo files or sample card files, to the printer.

See the *Data Formatting Guide* for more information about them.

Network installation

A networked printer is connected to a network without a computer (PC) between the printer and network.

Depending on printer options and your needs, the printer can be connected to a print server and then to the network. A PC can connect to several networked printers at a time, and several PCs can connect to one printer. To connect a printer to a network, you need the following:

- An Ethernet network that uses the TCP/IP protocol and can run at 10 megabits per second (also called 10base-T), or a faster network (such as 100 megabits per second) that automatically switches to the printer speed of 10 megabits per second.
- A CP60 Card Printer with the Built-In Ethernet feature.
- An Ethernet cable to connect the printer or print server to the network. An Ethernet cable is not supplied with the printer.
- Network configuration utility. Network support personnel use utilities to set up and monitor the network and devices on the network.
- PC connected to and communicating with the network.
 - From the PC, you will set up the printer on the network and verify that the printer is connected to and communicating with the network. The printer was tested with PCs running the Windows XP operating systems and the CP Driver. CP60 printers with the Open Card option were also tested with a PC running the Knoppix Linux Boot CD-ROM (version 3.3).
 - When setting up the printer using an operating system with permissions, such as Windows XP, 2000, or NT, make sure you are logged in as the Administrator. If networking is set up on the PC, log into the network.

- When using the printer from an operating system with permissions, such as Windows XP, 2000, or NT, users must have the same permissions as for a locally attached printer.

You can connect a CP60 Card Printer using a print server if you choose. See ["Connect the printer to the network" on page 27](#) for details about supported print servers, additional equipment that might be needed, and how to install the printer using a print server.

Prepare the printer for installation

Make sure you have done the following to prepare the printer:

- 1 Load print ribbon. See ["Loading print ribbon" on page 7](#).
- 2 Load cards. See ["Loading cards" on page 5](#).
- 3 Power on the printer. See ["Power on the printer" on page 9](#).
 - If the printer was previously installed on a network, it might take a few moments for the printer to initialize.
 - If you power on the printer, if the Address Mode is DHCP (dynamic host configuration protocol), and if the printer is not connected to a network, the IP Address will be blank. You can change the Address Mode to Static IP, or you can connect it to a DHCP network after power on and wait a moment while the printer obtains an IP Address.
- 4 View the LCD panel to make sure that the printer has powered on correctly. See ["The LCD panel" on page 10](#).
- 5 Make a printer test card. See ["Make a printer test card" on page 13](#).
- 6 Work with network support personnel to understand whether the network uses DHCP or static IP addressing. If it uses static IP addressing, obtain the IP address, subnet mask, and gateway address from network support personnel. (You can also use the default IP address in the printer.) DHCP is the printer default.

When you have successfully completed these steps, continue with installing the printer on a network.

Connect the printer to the network

To connect the printer to the network, use one of the following methods:

- Connect the printer using the Ethernet port (requires a CP60 Card Printer with the Built-in Ethernet feature).
- Connect the printer using the USB port and a wired print server. The HP Jetdirect® 175x has been tested in this usage.
- Connect the printer using the USB port and a wireless print server. The HP Jetdirect 380x has been tested in this usage.

On operating systems with permissions, such as Windows XP, 2000, or NT, make sure you are logged in as the Administrator during setup. If networking is set up on the PC, log into the network.

Use the Ethernet port

- 1 Attach the Ethernet cable to the Ethernet port on the printer and to the port for the network.
- 2 Continue with ["Set up the network printer" on page 30](#).

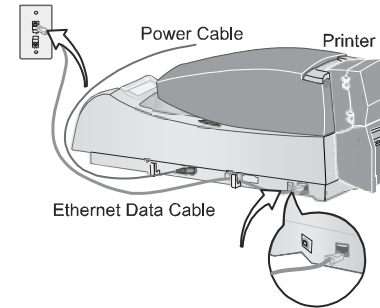

Use the USB port and a wired print server

- 1 Connect the print server to the printer using a USB cable.
- 2 Connect the print server to the network using an Ethernet cable. See the setup information provided with the print server.
- 3 Follow the instructions provided with the print server to set it up on the network, and then see ["Set the Data Format" on page 34.](#)

Tips for Success

- Be sure to record the print server name or IP address, which you need to send print jobs from a PC. Work with your network support personnel if needed to obtain the print server name and IP address.
- You do not need to perform the steps in ["Set up the network printer" on page 30.](#) Instead, set up the print server on the network (step 3 above).

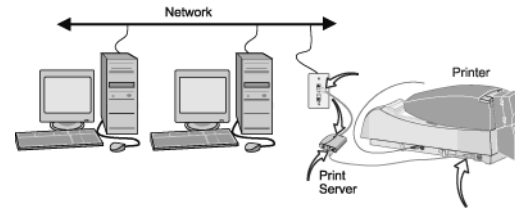

Use the USB port and a wireless print server

- 1 Install the wireless network adapter, including the driver files, to a nearby PC. Follow the instructions provided with the adapter to install it.
- 2 Change settings in the utility for the wireless network adapter (if needed) to match the default settings for the wireless print server. Find the settings in the print server information.
- 3 Power on the wireless print server. Do not connect the print server to the printer at this time.
- 4 Insert the wireless print server CD-ROM in the PC with the wireless network adapter. Follow the instructions provided with the print server to set it up on the network, and then see ["Set the Data Format" on page 34](#).

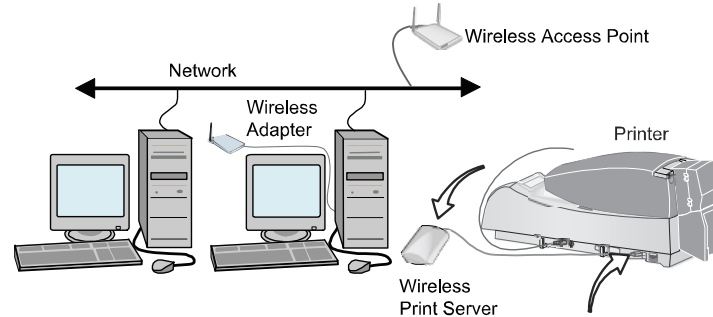

Tips for Success

- Network support personnel can provide the network settings to use.
- Be sure to record the print server name or IP address, which you need to send print jobs from a PC.

You do not need to perform the steps in ["Set up the network printer" on page 30](#). Instead, set up the print server on the network (step 4 above).

Set up the network printer

Set the CP60 Card Printer with the Built-in Ethernet feature for the type of network addressing you plan to use. Do not perform these steps if you use a print server to connect the printer to the network. First, view the current mode of addressing:

- 1 Press the Enter key to enter the menu system.
- 2 Make sure "Status" appears on the second line and press the Enter key.
- 3 Press the Up or Down Arrow key to scroll to "Network," and then press the Enter key.
- 4 Press the Up or Down Arrow key if needed to scroll to "Address Mode," and then press the Enter key.
- 5 The display shows the address mode, which can be DHCP (default) or Static IP.
 - If the address mode setting is the one you want to use, use the Network Status submenus to retrieve the IP address, subnet mask, gateway address, and, if needed, the MAC address values from the printer:

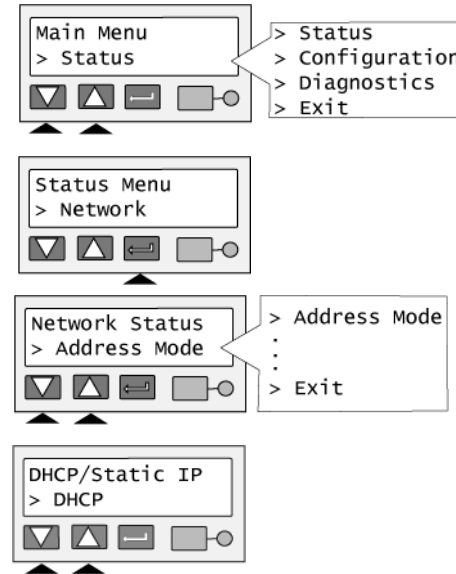

- Press the Enter key to leave the current value.
- Press the Up or Down Arrow key to scroll to a value and press Enter to view the value.
- Exit to the Main Menu and continue with ["Set the Data Format" on page 34.](#)

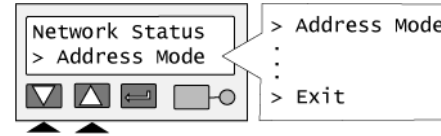

- If you need to change the address mode, continue with these steps.

- 6 Exit from the Network Status menu and from the Status Menu to return to the Main Menu. Press the Up or Down Arrow key to scroll to "Configuration," and then press the Enter key.

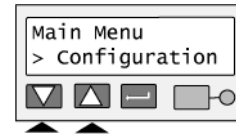

- 7 Press the Up or Down Arrow key to scroll to "DHCP/Static IP" and then press the Enter key.

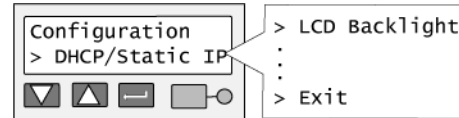

- 8 Press the Up or Down Arrow key to choose the address mode you want and then press the Enter key.

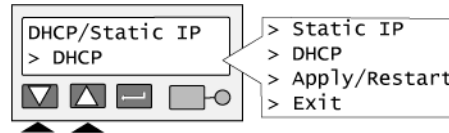

- If you choose DHCP, the display shows "Apply/Restart" on line 2. If you are not connected to a DHCP network, the IP address will be blank until you connect the printer to the network. Continue with step 9.

- If you choose Static IP, the second line of the LCD panel shows “IP Address.”
- Work with your network personnel to obtain the IP address, subnet mask, and gateway address. Enter these as described next.
- Press the Enter key to choose “IP Address.” The printer shows the current IP address and a cursor appears under the first byte of the address. (The address byte shows 3 digits when it can be changed and the cursor appears under the right-most digit.)
- Press the Up or Down Arrow key to change the address. (Press and hold the Up or Down Arrow key to change the value quickly.)
- When the first byte is correct, press the Enter key to move to the second byte.
- Repeat for the third and fourth byte of the IP address. When you press the Enter key after the fourth byte of the address, “Subnet Mask” appears on the second line of the LCD panel.

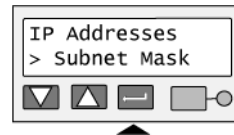
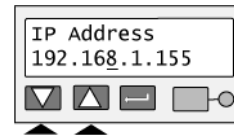
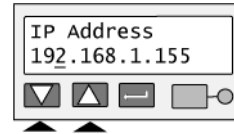
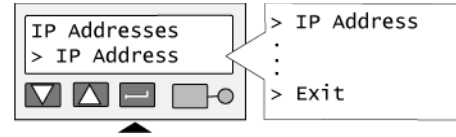

- Press the Enter key. The current value appears with the cursor under the first byte. Use the same process as for the IP address to set the subnet mask. When you press the Enter key after the fourth byte, “Gateway Addr” appears.
 - Press the Enter key. The current value appears with the cursor under the first byte. Use the same process as for the IP address to set the gateway address. When you press the Enter key after the fourth byte of the gateway address, “Apply/Restart” appears.
- 9** Press the Enter key to apply the value(s) and restart the printer. The Status light shows amber (yellow) and then blinks green. Internal printer components move and the LCD panel changes to show “Printer Ready” on the first line.

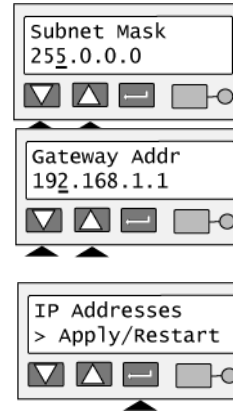

Set the Data Format

This section applies only to the CP60 printer with the Built-in Ethernet and Open Card features. Before you send any data to the printer, set the data format so the printer can receive the data you send.

- 1 Press the Enter key to enter the menu system.
- 2 Press the Up or Down Arrow key to scroll to "Configuration" and press the Enter key.
- 3 Press the Up or Down Arrow key to scroll to "Data Format" and press the Enter key.
- 4 Press the Up or Down Arrow key to display the data format you want on the second line of the display and press the Enter key.
- 5 The "Apply/Restart" prompt appears on the second line of the display. Press the Enter key to confirm the data format choice and restart the printer.
- 6 You can choose Exit to leave without changing the data format. Press the Enter key repeatedly to leave the menu system.

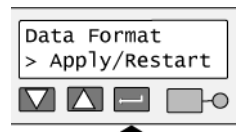
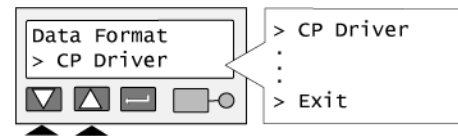
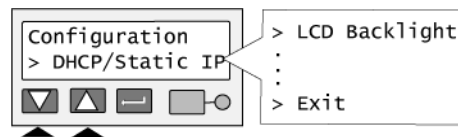
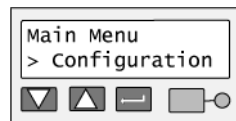

Set up for your card design

The steps to set up for your card design depend on the Data Format you use.

Set up for CP Driver

- 1 Install the CP Driver. Choose “Direct Network” when installing the printer.
- 2 Install *Info Central*.
- 3 Open *Info Central*. In the contents list, locate the “Network Installation” topic in the “Installation” book. Scroll down to the steps for your type of connections—wired or wireless—to complete driver installation.
- 4 In *Info Central*, locate the “Setting up for your card design” book. Follow the guidance provided to complete driver and printer setup.

Set up for the Open Card data format

The Open Card option is required to use the Open Card data format. See ["Features and options" on page 3](#) to determine whether you have the Open Card option.

- 1 Prepare the data by using Open Card commands. (At a minimum, use the Start and End Data commands.)
- 2 Use the Card Layout menus available through the printer Telnet interface to set up a card design.
- 3 See the *Data Formatting Guide* for more information.

SNMP Support

The CP60 Card Printer with the Built-in Ethernet feature supports the following SNMP (simple network management protocol) features:

- The printer has an SNMP agent which supports the printer MIB (management information block) and MIB-II. The agent supports SNMPv1 and SNMPv2c.
- If you connect the printer to the network using a print server, the print server can provide SNMP data about itself (if supported). You cannot obtain SNMP data about the printer through a print server. SNMP data about the printer is only available through the printer Ethernet port; if you require SNMP data about the printer and use a print server to send data, you must also connect the printer Ethernet port to the network to provide the SNMP data.
- The MIB-II is described in RFC (request for comment) 1213 and includes RFC 2233, the Interfaces Group MIB using SMI v2.
- The printer MIB is described in RFC 1759 (which requires inclusion of part of the Host Resources MIB, RFC 1514).
- For more information about SNMP standards, see the RFC pages of the Internet Engineering Task Force Web site at <http://www.ietf.org/rfc.html>.

Print a card

First, make sure the printer is installed and ready (see "[Printer Installation](#)" on page 21). Then, see "[Data formats for the CP60 Card Printer](#)" on page 15 for features of each format.

From the CP Driver

The CP60 printer can receive card data from the CP Driver running on a Windows PC.

- 1 Using the LCD panel, select "CP Driver" as the data format. See "[Set the Data Format](#)" on page 54 for the steps to follow.
- 2 In the application, select the CP Driver as the current printer. (Your printer might have a different name.)
- 3 Choose the printer settings that correspond to the cards.
- 4 Set the paper size to CR80 Card 2.13" x 3.38." Set margins to match the driver.
- 5 Capture, format, and save the card data.
 - Format the text to print using TrueType fonts.
 - Text formatted as Black will print using the K (solid black) ribbon panel.
 - Other colors are printed using the color panels (if you use a full-color print ribbon).
- 6 When the card data is ready, choose Print to send the card to the printer.

The card shown is the sample card printed from the Printer Toolbox. It shows the features available when printing from the CP Driver using a full-color ribbon. (The card has less printing if using a monochrome ribbon.) See *Info Central* for detailed information about set up and printing using the CP Driver.



Using the Open Card data format

A printer with the Open Card feature can receive card data from any host computer that sends an ASCII (text) data stream using TCP/IP. Usually, you use an application on a host computer to collect and prepare the data and then send it.

- 1 Using the LCD panel, select “Open Card” as the data format. See ["Set the Data Format" on page 54](#) for the steps to follow.
 - The Open Card value does not appear in the list if the printer does not have the Open Card option.
- 2 Define the card design or format. This step is part of setup, done before the operator prints cards. Do one of the following:
 - Use an application that sends Open Card commands and data to the printer.
 - Set up a card design using the Card Layout menus, and then use an application that sends data to the printer.
- 3 Capture and save the data.
- 4 Choose Print to send the card to the printer.



See the *Data Formatting Guide* for details about Open Card commands and menus.

The card shown is a sample Open Card design. It shows features available when printing Open Card data.

Cleaning the printer

Run a cleaning card and change the cleaning sleeve when changing the print ribbon. Make sure that all cards sent to the printer have completed printing before cleaning.

- 1 Open the printer cover (1).
- 2 Remove the replaceable cleaning roller and the ribbon cartridge (2).
- 3 Open the input hopper cover (3).
- 4 Remove unprinted cards from the input hopper (4).
- 5 Open the cleaning card package and remove the cleaning card.



- 6 Insert the cleaning card into the input hopper (5), just past the roller.
- 7 On the LCD panel, press the Enter key to view the Main Menu.
- 8 Press the Up Arrow or Down Arrow key to display "Diagnostics" and then press the Enter key.

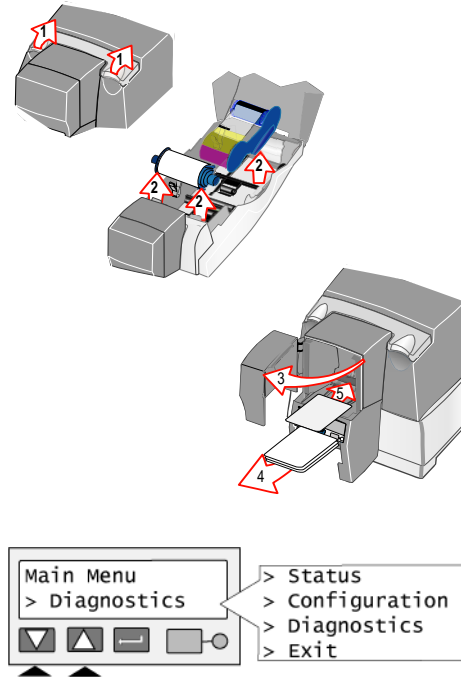

- 9 Make sure "> Cleaning Card" is displayed on the second line of the LCD panel and press the Enter key.

The printer moves the card through the printer several times and ejects the card. Wait a few minutes to allow the rollers to dry for best printer operation and print quality.

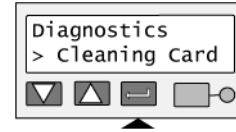

- 10 Slide the used cleaning sleeve off the spindle.
- 11 Discard the used cleaning card and used sleeve.
- 12 Place a new cleaning sleeve on the spindle (1).
- 13 Remove the protective cover from the sleeve (2).
- 14 Insert the replaceable cleaning roller (with a new cleaning sleeve) into the printer (3).
- 15 Replace the ribbon cartridge, close the printer cover, load cards, and resume printing.

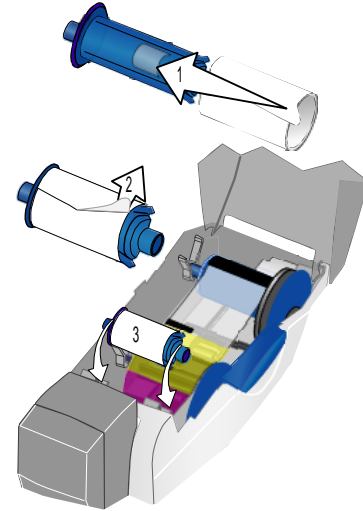

Cleaning tips

- Use the cleaning card as soon as you open the package. The cleaning solution on the card evaporates after a few minutes.
- Some card features, such as signature panels and magnetic stripes, can require more frequent cleaning of the printer.
- If you use StickiCard™ adhesive-backed cards, use a cleaning card more often, such as after printing every 100 cards. The printer might also need additional cleaning. See "Cleaning the printer rollers" on page 41.

Cleaning the printer rollers

The printer rollers move the card during printing or cleaning operations. Clean the rollers when problems occur such as:

- Repeated card jams
- Cards are not being picked, repeatedly
- Colors are not aligned on the printed card

Use the cleaning pen to clean printer rollers.

- 1 Clean the pick roller:
 - a Open the input hopper and remove all cards from the input hopper.
 - b Remove the cap from the cleaning pen. Hold the end of the cleaning pen against the pick roller.
 - c Use the LCD panel to run a cleaning card. See "[Cleaning the printer](#)" on page 39. Do not insert a cleaning card! The printer moves the rollers when it attempts to pick the card.
 - d Slowly move the pen over the surface of the pick roller.
 - e Lightly wipe any dirt from the end of the cleaning pen onto a clean cloth or paper. Move the cleaning pen to another area of the roller.
 - f Repeat steps c through e until no more dirt appears on the pen.

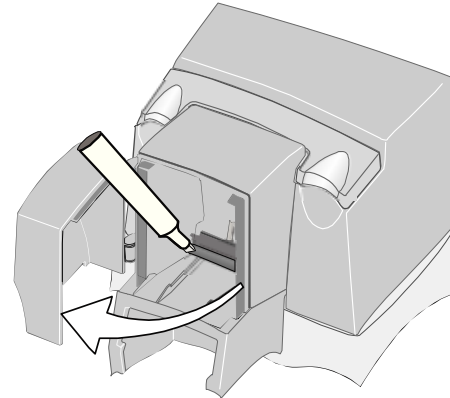

- 2 Clean the permanent cleaning rollers (at location 1), transport area rollers (at locations 2, 3, 4, 5), and duplex rollers (at location 6) following the same procedure used for the pick rollers.
 - Wait a few minutes to allow the rollers to dry for best printer operation and print quality.
- 3 Replace the print ribbon cartridge and replaceable cleaning roller. Close the printer cover.
- 4 Replace cards in the input hopper.
- 5 Print a card to verify the quality of printing.

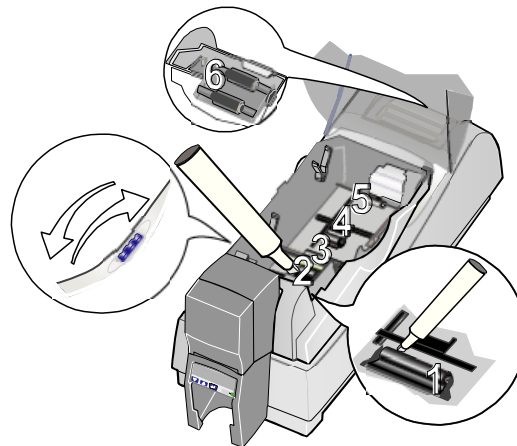

Getting the most out of your printer

To get the best quality cards and to maintain printer performance, follow these tips for success:

- Use the best quality cards available with a smooth, glossy PVC surface and print them only once. Make sure options, such as a signature panel or a magnetic stripe, are high quality.
- Match the card design and the supplies you use to obtain the results you want.
 - Edge to edge printing requires high-quality cards and can require fine-tuning the printer (using the CP Driver) and the card design (using ID software).
 - Locate bar codes at least 0.25 inches from other printing and from the edge of the card. Make sure the color used to print the bar code works in your bar code readers.
 - Do not print closer than 0.1 inch from a signature panel, magnetic stripe, or smart card chip. Obtain information from your card manufacturer about card features and placing design elements on the card.
 - Do not apply topcoat over a magnetic stripe, signature panel, or smart card chip.
 - Avoid placing an image or important data on the other side of the card from a magnetic stripe, smart card chip, or signature panel.
- Follow instructions carefully when replacing supplies, correcting problems, cleaning the printer, and replacing parts.

- Use cables that meet specifications and connect them correctly.
- Keep cards and Datacard[®]-certified supplies on hand and store them safely.
- Keep the printer clean and keep the area around the printer clean.

If you use the CP Driver and a PC to print cards, see *Info Central* for detailed information about:

- Setting up the printer for the card design
- Making cards

If you use the Open Card data format, see the *Data Formatting Guide* for detailed information about:

- Card Layout menus in the printer, used to create a card design
- Open Card commands supported by the printer
- Tools to use when using the Open Card data format

For either data format, see *Info Central* for information about:

- Changing printer settings
- Troubleshooting
- Supplies and parts, and specifications for them

The *Data Formatting Guide* is available on the Open Card CD-ROM shipped with the Open Card option. It is also available to service providers on the PartnerPage.com^(SM) Web site.

Printer LCD settings

Using the LCD panel, you can:

- View settings and data
- Change settings
- Run a cleaning card

Tips for success

- You can access menus where you can view or change settings when the printer displays “Printer Ready” on line 1 of the display.
- If you are using the menus and stop pressing keys, the printer will return to the “Printer Ready” display after 2 minutes of inactivity. Any changes not applied will be lost.
- To leave a selection without changing the value, press the Up or Down Arrow key to scroll to Exit and then press the Enter key.
- If you have the CP Driver installed and communicating with the printer, suspend communication using the Printer Toolbox before changing values. If you change the data format, unexpected cards might be printed. If you change IP addresses, communication with the printer can end unexpectedly.

LCD menu system

The menu system has three major branches. Use the Status menu to view settings and data about the printer. Use the Configuration menu to change settings. Use the Diagnostics menu to run a cleaning card.

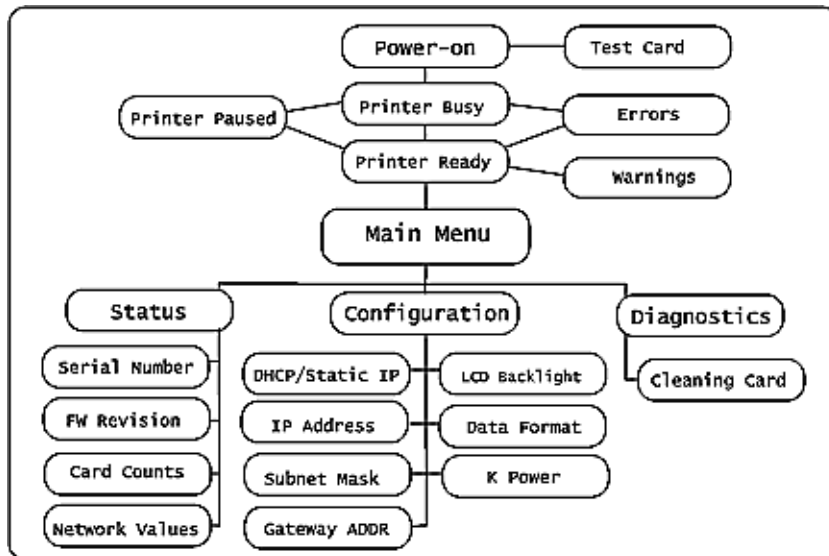

View status settings

Begin when the LCD panel shows “Printer Ready” on line 1 of the display. To view Status information:

- 1 Press the Enter key to enter the menu system.



- 2 Make sure “Status” appears on line 2 and press the Enter key. You are now in the Status Menu.

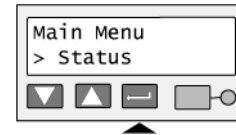

View the Serial Number

- 1 With “Status Menu” displayed on line 1, press the Up or Down Arrow key if needed to display “Serial Number” on line 2.

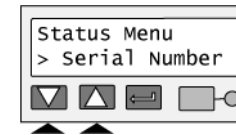

- 2 Press the Enter key. The display shows the serial number.
- 3 Press the Enter key to return to the Status menu.
- 4 Press the Up Arrow or Down Arrow keys to scroll to “Exit” on line 2.
- 5 To print cards, press the Enter key repeatedly (with “Exit” displayed on line 2) to return to the “Printer Ready” display.

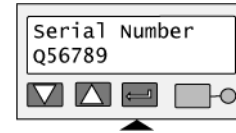

View the Firmware Revision

Use the firmware revision display at the request of your service provider, or to decide whether to use the firmware update utility to update printer firmware.

- 1 With “Status Menu” displayed on line 1, press the Up or Down Arrow key if needed to display “FW Revision” on line 2.
- 2 Press the Enter key. The display shows the firmware revision.
- 3 Press the Enter key to return to the Status menu.
- 4 Press the Up Arrow or Down Arrow keys to scroll to “Exit” on line 2.
- 5 To print cards, press the Enter key repeatedly (with “Exit” displayed on line 2) to return to the “Printer Ready” display.

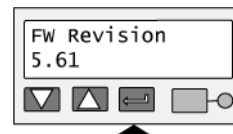
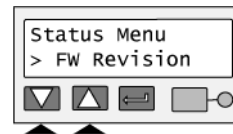

View Card Counts

- 1 With "Status Menu" displayed on line 1, press the Up or Down Arrow key to display "Card Counters" on line 2
- 2 Press the Enter key. "Card Count" appears on line 2.
- 3 Press the Enter key to view the total number of cards printed on this printer.
- 4 Press the Enter key to return to Card Counters. "Cycle Count" appears on line 2.
- 5 Press the Enter key to view the cycle count or press the Up or Down Arrow key to display "Exit" on line 2.
- 6 To print cards, press the Enter key repeatedly to return to the "Printer Ready" display.

A cycle is one pass of the printhead. With monochrome (K) ribbon, one cycle prints the front of the card. A second cycle might print the back of the card. With full-color YMCKT ribbon, each color panel uses one print cycle; the front of the card uses five print cycles.

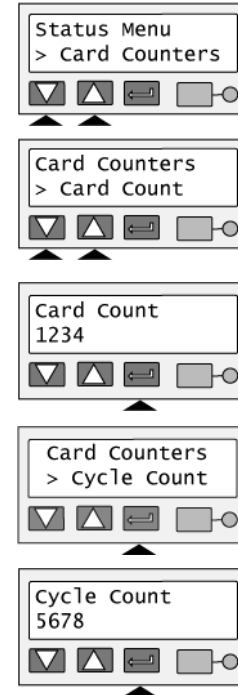

View the Data Format

- 1 With "Status Menu" displayed on line 1, press the Up or Down Arrow key to display "Network" on line 2.
- 2 Press the Enter key. "Address Mode" appears on line 2.
- 3 Press the Up or Down Arrow key to display "Data Format" on line 2.
- 4 Press the Enter key. The data format appears on line 2. Possible values are CP Driver, Open Card, and Reserved.
- 5 Press the Enter key to return to the Network Status menu.
- 6 Press the Up or Down Arrow key to display "Exit" on line 2.
- 7 To print cards, press the Enter key repeatedly to return to the "Printer Ready" display.

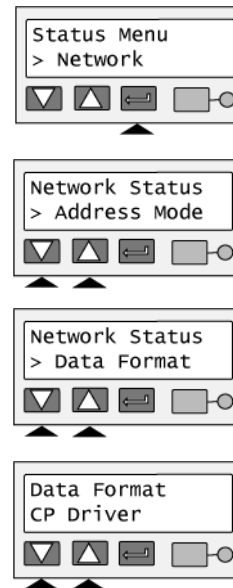

View the Network Address Mode, IP Addresses, and MAC Address

- 1 With "Status Menu" displayed on line 1, press the Up or Down Arrow key to display "Network" on line 2.
- 2 Press the Enter key. "Address Mode" appears on line 2. Press the Enter key to view the address mode. The possible values are DHCP or Static IP.
- 3 Press the Enter key to return to the Status menu. "Data Format" is displayed on line 2.
- 4 Press the Up or Down Arrow key to display "IP Address" on line 2.
- 5 Press the Enter key to display the IP address. If the address mode is DHCP and the printer is not connected to an active DHCP network, the IP address is blank.
- 6 Press the Enter key to return to the Status menu. "Subnet Mask" is displayed on line 2.

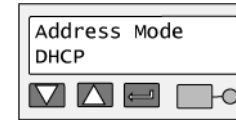
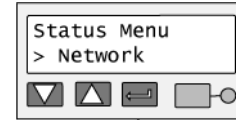

- 7 Press the Enter key to display the subnet mask.
- 8 Press the Enter key to return to the Status menu. "Gateway Addr" is displayed on line 2.

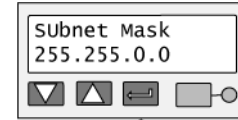

- 9 Press the Enter key to display the gateway address.
- 10 Press the Enter key to return to the Status menu. "MAC Address" is displayed on line 2.



- 11 Press the Enter key. The MAC address, which is set in the factory, is displayed on line 2.
If the MAC address needs to be changed, contact your Datacard® service provider.

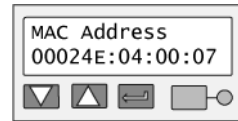

- 12 Press Enter to return to the Status menu. "Exit" is displayed on line 2.
- 13 To print cards, press the Enter key repeatedly to return to the "Printer Ready" display.



Change settings

Begin when the LCD panel shows “Printer Ready” on line 1 of the display. To change settings:

- 1 Press the Enter key to enter the menu system.
- 2 Press the Up or Down Arrow key to scroll to “Configuration” on line 2.
- 3 Press the Enter key. You are now in the Configuration menu.

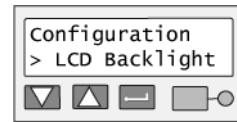

Set LCD Backlighting

- 1 With “Configuration” displayed on line 1, press the Up or Down Arrow key if needed to display “LCD Backlight” on line 2.

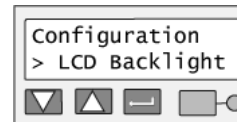

2 Press the Enter key to display the current value.

3 Press the Up or Down Arrow key to change the backlighting. The display changes to show the effect of the new value.

4 When the backlighting reaches the level you want, press the Enter key. The display remains at the new backlighting level and you return to the Configuration menu.

5 Press the Up or Down Arrow key if needed to scroll to “Exit” on line 2.

6 To print cards, press the Enter key repeatedly to return to the “Printer Ready” display.

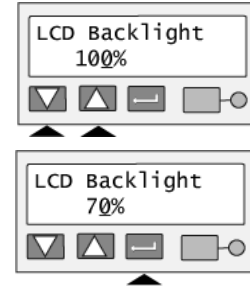

Set the Data Format

Tips for success

- When you choose a data format, the printer might not operate properly if data in another format is sent.
 - If you have the CP Driver installed and connected to the printer, suspend communication using the Printer Toolbox before changing values. If you change the data format, unexpected cards might be printed.
- 1 With “Configuration” displayed on line 1, press the Up or Down Arrow key if needed to display “Data Format” on line 2.
 - 2 Press the Enter key. The current data format value is displayed on line 2.

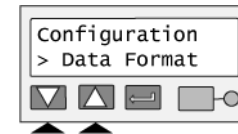

- 3 Press the Up or Down Arrow key to display the data format you want. Possible values are CP Driver, Open Card (requires the Open Card option), and Reserved. The Reserved value is not supported.
- 4 Press the Enter key. "Apply/Restart" appears on line 2.
- 5 Press the Enter key to apply the value(s) and restart the printer.
- 6 If you did not choose a different data format, the display shows "DHCP/Static IP" on line 2. Press the Up or Down Arrow key to scroll to "Exit" on line 2 to leave without making changes.

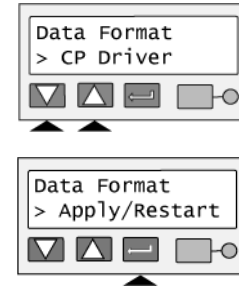

When the printer restarts, the Ready light shows amber (yellow) and then blinks green. Internal printer components move and the LCD panel changes to show "Printer Ready" on the first line.

Set the Address Mode

Tips for success

- When you choose an address mode, you determine how the network address of the printer is assigned. The possible values are DHCP and Static IP. DHCP stands for "Dynamic Host Configuration Protocol" and means that the network assigns the IP address (and other values) to the printer. Static IP means that the IP address is entered following the procedure in ["Set the IP Address, Subnet Mask, and Gateway Address" on page 57](#). Use the address mode requested by your network personnel.
- If you have the CP Driver installed and connected to the printer from any PC, suspend communication using the Printer Toolbox. If you change IP addresses, communication with the printer can end unexpectedly.

1 With "Configuration" displayed on line 1, press the Up or Down Arrow key if needed to display "DHCP/Static IP" on line 2.

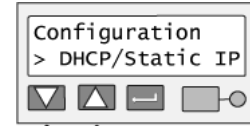

2 Press the Enter key. The current address mode value is displayed on line 2.

3 Press the Up or Down Arrow key to display the address mode you want. Possible values are DHCP and Static IP.



4 Press the Enter key.

5 The next step depends on which address mode you have chosen:

- If you have chosen DHCP, "Apply/Restart" appears on line 2. Press the Enter key to restart the printer. After the printer restarts, see "[View the Network Address Mode, IP Addresses, and MAC Address](#)" on page 51 to retrieve the IP address and other data.
- If you have chosen Static IP, "IP Address" appears on line 2. See "[Set the IP Address, Subnet Mask, and Gateway Address](#)" on page 57 for the steps to follow.
 - You must set the IP address, subnet mask, and gateway IP address for the printer. The printer will restart after you enter these values.
- If you have used the DHCP/Static IP menu selection but did not actually change the address mode, "K Power" appears on line 2. Press the Up or Down Arrow key to display "Exit" on line 2. Press the Enter key repeatedly to return to the "Printer Ready" display.



Set the IP Address, Subnet Mask, and Gateway Address

Tips for Success

- The printer address mode must be “Static IP” to set these values. (If the address mode is DHCP, “IP Addresses” does not appear in the menu.)
 - The menu system moves from one value to the next because these values are related and a change in the IP address usually leads to a change in the subnet mask (and sometimes in the gateway address).
 - If you need to change just one value, you can scroll to the value you need to change in step 2 below.
- 1 With “Configuration” displayed on line 1, press the Up or Down Arrow key if needed to display “IP Addresses” on line 2.

- 2 Press the Enter key to choose the “IP Addresses” list. “IP Address” is displayed on line 2.

- 3 Press the Enter key. The printer shows the current IP address and a cursor appears under the first byte of the address. (The address byte shows 3 digits when it can be changed and the cursor appears under the right-most digit.)

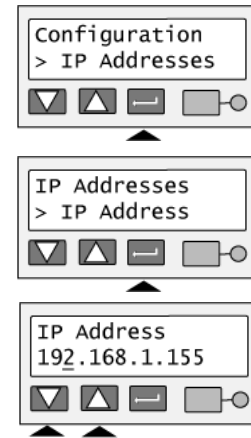

- 4 Press the Up or Down Arrow key to change the IP address. (Press and hold the Up or Down Arrow key to change the value quickly.)
- 5 When the first byte is correct, press the Enter key to move to the second byte.
- 6 Repeat for the third and fourth byte of the IP address. When you press the Enter key after the fourth byte of the address, "Subnet Mask" appears on the second line of the LCD panel.
- 7 Press the Enter key. The current value appears with the cursor under the first byte. Set the subnet mask (using the same process as the the IP address). When you press the Enter key after the fourth byte, "Gateway Addr" appears.
- 8 Press the Enter key. The current value appears with the cursor under the first byte. Set the gateway address (use the same process as the IP address). When you press the Enter key after the fourth byte of the gateway address, "Apply/Restart" appears.
- 9 Press the Enter key to apply the value(s) and restart the printer. Or, press the Up or Down Arrow key to scroll to "Exit" on line 2 to leave without making changes.
The Ready light shows amber (yellow) and then blinks green. Internal printer components move and the LCD panel changes to show "Printer Ready" on the first line.

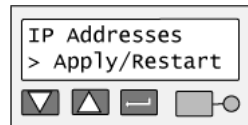
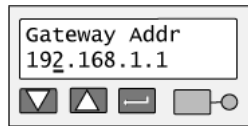
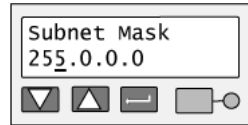
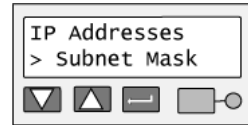
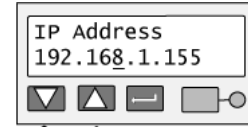

Set the K Power

Tips for Success

- Set the K Power value to change the darkness—or intensity—of printing with monochrome ribbon (or the monochrome–K–panel of full-color ribbon). K power affects the thickness of letters and barcodes; higher intensity prints thicker letters or barcodes.
- A value of “0” for K Power means no change to the factory setting for K power.
- Make small changes in K power and then print a card to view the result. If needed, return to these steps to make additional changes.
- If you print barcodes, make sure the new setting results in barcodes that can be read by readers at your site.

- 1 With “Configuration” displayed on line 1, press the Up or Down Arrow key if needed to display “K Power” on line 2.
- 2 Press the Enter key to display the current value.
- 3 Press the Up or Down Arrow key to change the K Power setting. (Press and hold the Up or Down Arrow key to change the value quickly.) If you press the down arrow key so the value is less than zero (0), a minus (-) sign appears. A plus (+) sign indicates a value greater than zero (0).
- 4 When the K Power reaches the level you want, press the Enter key to return to the Configuration menu.
- 5 Press the Up or Down Arrow key if needed to scroll to “Exit” on line 2.
- 6 To print cards, press the Enter key repeatedly to return to the “Printer Ready” display.

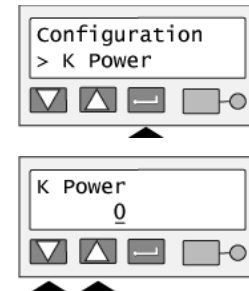

Turn the page for the next section.

Troubleshooting

What is the problem?

- 1 A message appears on the PC or LCD panel.
- 2 The printed cards do not look the way that was intended.
- 3 Cards jam often.
- 4 The ribbon has broken.

Try this:

- Click the Help button on the message box to see possible causes and the solution for each cause. See the “Related Topics” to fix the problem.
 - If you moved the ribbon while the printer was powered off, print another card. If the problem persists, see *Info Central* for detailed information about solving card appearance problems.
 - The brand of cards might be heavily powdered, dirty, or bowed (curved). Consider buying a different brand of cards or clean the printer more often to use the cards.
 - The printer rollers might be dirty. See ["Cleaning the printer rollers" on page 41](#) for steps to clean the printer rollers.
 - Trim the end of the broken ribbon evenly. If ribbon on the take-up spool is not wound firmly or is uneven, remove it. Tape the end of the ribbon onto the *same* take-up spool, making the edges of the ribbon and spool even.
 - If the ribbon breaks repeatedly, settings might not be correct for the card design and ribbon. See Setup in *Info Central*.
-

What is the problem?

- 5 The printer does not respond when printing a card or when clicking “Resume” on the Printer Toolbox.

- 6 The printer cover will not close.

Try this:

- Make sure the printer is plugged in. See ["Power on the printer" on page 9](#).
 - Make sure the printer is connected to the computer. ["Connect the printer to the network" on page 27](#).
 - If the Status Light on the printer is blinking amber (yellow), press the Ready .
 - Power off the printer and power it on to see if communication resumes.
 - See *Info Central* for more detailed communication troubleshooting information.
 - Make sure no extra items are inside the printer.
 - Make sure the print ribbon cartridge is installed correctly. See ["Loading print ribbon" on page 7](#).
 - If you installed or bumped the printhead cartridge, make sure it is installed correctly. See Production in *Info Central*.
 - Push down firmly on the front edge of the cover to latch it.
-

Printer supplies

Datacard[®]-certified ribbon kits and cleaning supplies are available for the printer. Ribbon kits contain a roll of print ribbon, a cleaning card, and a replaceable cleaning sleeve. For best results, run a cleaning card and replace the cleaning sleeve each time you change the print ribbon.

Color print ribbon

Color print ribbon for the CP60 printer is available as follows:

- YMCKT Color Ribbon Kit, part number 552854-304, prints up to 250 images
- YMCKT Color Ribbon Kit, part number 552854-604, prints up to 500 images (also for use on SP60 printers)
- YMCKT-KT Color Ribbon Kit, part number 552854-606, prints up to 300 images (for duplex printing on CP60 and SP60 printers)

Color print ribbons are designed for full-color card printing. The ribbons use the following color panels: Y=yellow, M=magenta, C=cyan/blue, K=black, and T=topcoat (clear). Datacard color print ribbon for CP Series printers uses Advanced Imaging Technology™ for high quality printing.

Monochrome and Topcoat ribbon

Ribbon with alternating Black (K) and Topcoat (T) panels is available as part of the KT Ribbon Kit, part number 552854-509, which prints up to 1000 images.

Monochrome print ribbon

Several colors of monochrome (single-color) print ribbon are available for the CP60 printer. A roll of ribbon prints 1500 or more images. The Ribbon Saver feature is enabled by Datacard[®]-certified monochrome ribbons. Ribbon Saver increases the number of cards printed with each roll of ribbon.

Available monochrome colors include:

Color	Part number	Color	Part Number
Black	552954-501	Gold	552954-508
Dark Blue	552954-502	Scratch-off	552954-513
White	552954-503	Black HQ	552954-701
Red	552954-504	Metallic Silver	552954-607
Green	552954-506	Metallic Gold	552954-608
Silver	552954-507	Metallic Holo Fleck	552954-609

Cleaning supplies

In addition to the cleaning supplies included in the ribbon kit, it is recommended that you order additional cleaning supplies to have on hand to address unusual situations.

- A package of 5 replaceable cleaning sleeves is available. The part number is 549716-002.
- A package of 10 cleaning cards is available. The part number is 552141-002.

See *Info Central* for complete information about supplies and replacement parts for CP60 printers.

Printer messages

The CP60 Card Printer with the Built-in Ethernet displays messages on the LCD panel.

If the Data Format is set to CP Driver, messages (that match up with printer messages) also appear on the PC in message boxes. You might see messages on the LCD panel that do not appear on the PC, because the LCD displays all printer messages while the CP Driver shows the most important message if a group of messages occurs at the same time. In addition, the CP Driver can display messages that begin in the driver (not the printer) and those messages do not appear on the LCD panel.

When a message appears on the LCD panel, do the following:

- 1 Find the message number in this section. Messages are listed in numerical order.
- 2 Use the cause and solution information to fix the problem.
- 3 Make sure cards are loaded and the ribbon is in the printer. Close the printer cover (if it was opened).
- 4 Resume printing:
 - Click a button on the message box on the PC, which might allow you to retry the card.
 - Press the Ready key on the LCD panel to clear the message and cancel printing of the card.
- 5 If another message is displayed, repeat steps 1 through 4. If not, the printer returns to the ready or busy state.

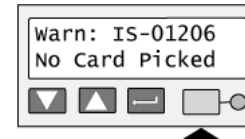

DM-00760 Duplex Error

The duplex mechanism did not reach the correct position.

Possible Cause 1: A card or object is jammed in or near the duplex unit.

Solution 1: Open the duplex module cover at the back of the printer (1). Release any cards or objects stuck in the module (2). Make sure that the duplex mechanism can move freely in the direction shown (3).

Possible Cause 2: The rollers in the duplex mechanism are dirty.

Solution 2: Run a printer cleaning card, and then clean the printer rollers including the duplex module rollers.

If you cannot fix the problem, contact your service representative for assistance.

Related Topics:

["Cleaning the printer" on page 39](#)

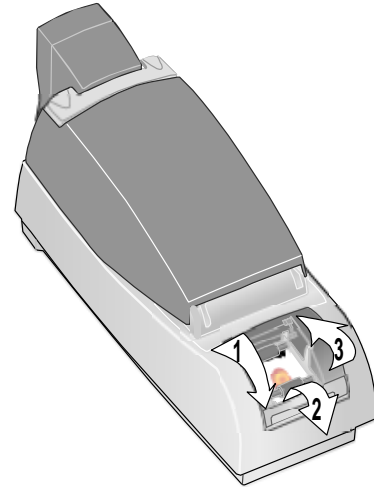

DM-00762 Duplex Jam

The card is stuck in the duplex module.

Possible Cause 1: A card is jammed in or near the duplex unit.

Solution 1: Open the of the printer (1). Release any cards stuck in the module (2). Make sure that the duplex mechanism can move freely in the direction shown (3).

Possible Cause 2: The rollers in the duplex mechanism are dirty.

Solution 2: Run a printer cleaning card, and then clean the printer rollers including the duplex module rollers.

If you cannot fix the problem, contact your service representative for assistance.

Related Topics:

["Cleaning the printer" on page 39](#)

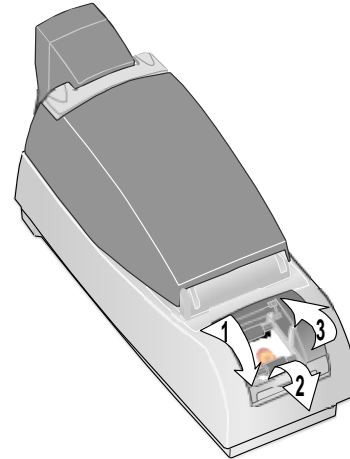

DM-00765 No Duplex

The duplex module is not installed or detected.

Possible Cause 1: The driver was set to use automatic duplex and a duplex module is not installed in the printer.

Solution 1: Send a one-sided card to the printer or set the driver for manual duplex.

Possible Cause 2: The connection between the duplex module and the rest of the printer is damaged.

Solution 2: Check the printer to see whether a duplex module is included in the printer. If it is, power the print off and on; the printer might detect the module when the printer powers up.

If a duplex module is part of the printer and you receive this message, contact your service provider for assistance.

Related Topics:

["Features and options" on page 3](#)

DM-00767 Duplex Jam

The card is lost in the duplex module.

Possible Cause 1: A card is jammed in or near the duplex module.

Solution 1a: Open the of the printer (1). Release any cards stuck in the module (2). Make sure that the duplex mechanism can move freely in the direction shown (3).

Solution 1b: If the card is stuck between the upper and lower duplex units, remove the card from the printer. You might see a “PR 01706” message after removing the card. Clear the message to continue.

Possible Cause 2: The rollers in the duplex mechanism are dirty.

Solution 2: Run a printer cleaning card, and then clean the printer rollers including the duplex module rollers.

If you cannot fix the problem, contact your service provider for assistance.

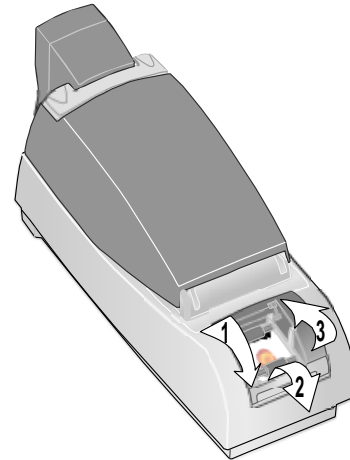

Related Topics:

["Cleaning the printer" on page 39](#)

IS-01206 No Card Picked

A card was not picked successfully.

Possible Cause 1: The input hopper is empty.

Solution 1: Fan the edges of the cards so the printer picks one card at a time and then load cards in the input hopper. Push the input hopper cover closed until it latches.

Possible Cause 2: One or two cards are jammed going into the printer.

Solution 2 a: Release the stuck card(s). Fan the cards in the input hopper again to separate them.

Solution 2 b: Cleaning liquid is making cards slip on the pick roller. Wait one or two minutes with the input hopper open to allow the pick roller to dry.

If the problem occurs again, run a cleaning card, change the cleaning sleeve, and then clean the rollers in the printer.

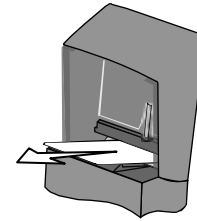
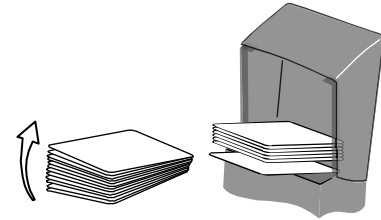

Related Topics:

["Cleaning the printer" on page 39](#)

["Cleaning the printer rollers" on page 41](#)

SY-01305 Data Error

The setting sent to the printer does not match printer features.

Possible Cause 1: A setting was sent to the printer for a module that is not installed or enabled.

Solution 1: Check the printer to see whether options are installed. If the option is not present in the printer, do not send data for the option.

Possible Cause 2: The printer data format is CP Driver and the printer was moved from one PC to another PC.

Solution 2: Open the Properties (98 or Me), Printing Preferences (2000 and XP), or Document Default Properties (NT) dialog box and make sure that settings match the printer that is currently connected. Click OK to make all settings take effect.

Related Topics:

["Features and options" on page 3](#)

SY-01306 Data Error

The setting value you selected is not valid.

Possible Cause 1: The value sent to the printer does not apply to the printer attached.

Solution 1: Use approved programs, such as the printer's Properties or Printing Preferences dialog box, to send values to the printer.

Possible Cause 2: You are using Printer Diagnostics, you have attached another printer, and have not selected the new printer in Printer Diagnostics.

Solution 2: Wait while the driver updates all printer information. Choose the new printer in Printer Diagnostics. Wait a moment while Printer Diagnostics updates to reflect the new printer.

SY-01310 Flash Error

EEPROM flash data error.

Possible Cause 1: A transmission problem occurred.

Solution 1: Send the file or data again. You can repeat this action several times.

Possible Cause 2: Data being sent to the printer is corrupted or incorrect.

Solution 2: Obtain the correct update file (or a new update file) and repeat the process. Be sure to select the correct update file if you are using Printer Diagnostics or the file2prn utility.

If you cannot fix the problem, contact your service provider for assistance.

SY-01312 Flash error

EEPROM flash size error.

Possible cause: A logo was downloaded to the printer (using the file2prn utility) and the logo requires more memory than is available in the printer.

Solution: Press the Ready key on the LCD panel to clear the logo from the printer and make the printer ready. Up to 4 logos can be stored in the printer. Each logo must be smaller than 64K. See the *Data Formatting Guide* to delete logos if needed.

SY-01314 Flash Error

Warning! EEPROM flash write error.

Possible Cause 1: A transmission problem occurred.

Solution 1: Click Retry on the message box to send the file or data again. You can repeat this action several times.

Possible Cause 2: The printer EEPROM does not accept the data or setting.

Solution 2: Power off the printer. Wait one minute, and then power on the printer. Repeat the action again.

Possible Cause 3: The printer EEPROM does not accept the flash file.

Solution 3: Send the file or repeat the action again. *Warning:* Do NOT power off the printer DURING a firmware download.

If you cannot fix the problem, contact your service provider for assistance.

SY-01317 Memory Error

Memory error.

Possible Cause 1: The printer memory does not accept the data.

Solution 1: Power off the printer. Wait one minute, and then power on the printer. Send the file or repeat the action again.

SY-01325 Data Error

The options, ribbon, or supply materials installed do not match settings or card data.

Possible Cause 1: The printer has an unidentified ribbon installed and a full-color card was sent to the printer.

Solution 1: The printer can print only one color if it cannot identify the ribbon. To print full-color cards, install a Datacard®CP60 full-color print ribbon.

Possible Cause 2: A different type of print ribbon (such as from YMCKT to KT) was installed when the "PR-01726" message was displayed.

Solution 2a: To print all cards in progress, install a ribbon that is the same type as the previous ribbon.

Solution 2b: To use the newly installed ribbon, cancel the current card and all cards in progress. Send the cards to print again. The printer driver will prepare the card data for the new ribbon type.

Possible Cause 3: You have made a choice, especially in Printer Diagnostics, that the printer does not support.

Solution 3: Use Printer Diagnostics only with the guidance of your service provider.

Tips for success

- You might have moved the print ribbon while the printer power was off. The next card will print correctly. The printer is designed to allow you to fix problems while the printer power is on.
- If you changed the type of ribbon in the printer, wait several seconds after closing the printer cover before you send the next card.
- Make sure the application supports the format of the graphic (logo or photo). Also make sure that the graphic is not corrupted.

If you cannot fix the problem, contact your service provider for assistance.

Related Topics

["Features and options" on page 3](#)

SY-01327 Data Error

The request sent to the printer is not supported.

Possible Cause 1: The printer features (such as magnetic stripe) have changed. The driver Printer Toolbox, Properties, or Printing Preferences dialog box has not changed to remove settings that are not supported by the printer and you have chosen and applied a setting that the printer does not support.

Solution 1: Close the driver Properties or Printing Preferences dialog box and open it again to display the settings for the printer. On the Printer Toolbox, wait until “The printer type is CP40.”, “The printer type is CP60.”, or “The printer type is CP80.” appears before using buttons or settings in the Printer Toolbox, Printer Diagnostics, or the Properties or Printing Preferences dialog boxes.

Possible Cause 2: For a directly networked printer, the message “A printer has been identified. (DR 00921)” was displayed on the PC and the OK or Close button was used. After that, you used the Printer Toolbox, Printer Diagnostics, or the Properties or Printing Preferences dialog box before settings were updated for this printer.

Solution 2: Do not close the message box. Follow the instruction to wait until the message box closes on its own. If you are using Printer Diagnostics, close it and wait until the message box closes on its own.

SY-01331 Comm Error

Data transmission error.

Possible Cause 1: The system has a temporary communication problem.

Solution 1: Print the card data again.

Possible Cause 2: The host computer and printer have a communication problem.

Solution 2: Troubleshoot a communication problem. See *Info Central* for troubleshooting information.

SY-01332 Hardware Error

General printer fault.

Possible Cause 1: The printhead cable is not attached to the printhead cartridge.

Solution 1: Power off the printer. Make sure the printhead cable is fully seated in the printhead cartridge. Close the printer and power it on.

Possible Cause 2: The printer identified a problem while it was running a diagnostic test.

Solution 2: Power the printer off and on.

If you cannot fix the problem, contact your service provider for assistance.

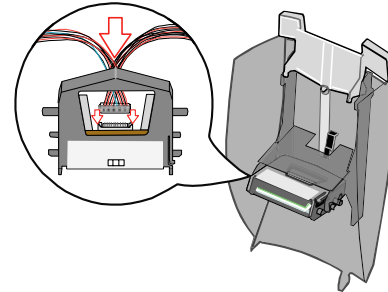

MS-01401, MS-01402, MS-01403 Mag Stripe Data

Data sent does not match requirements for track 1.

Possible Cause 1: Data sent includes more characters than allowed by the magnetic stripe format selected for the track.

Solution 1: Cancel the current print job. Determine the magnetic stripe format for the track. Change the data to be encoded, make sure the application is set to the same format as the track, and resend the print job.

Possible Cause 2: Data sent includes characters not allowed by the magnetic stripe format selected for the track.

Solution 2: Cancel the current print job. Determine the magnetic stripe format for the track. Change the data to be encoded, make sure the application is set to the same format as the track, and resend the print job.

If you cannot fix the problem, contact your service provider for assistance.

MS-01404, MS-01405, MS-01406 Mag Stripe Error

Parity error reading data on track 1, 2 or 3.

What is Parity?

- Parity is special data used when encoding a magnetic stripe. It is not the data you enter.

Possible Cause 1: The card has dirt or damage on the magnetic stripe.

Solution 1: Send the card to print again. If the message appears a second time, run a printer cleaning card.

Possible Cause 2: The magnetic stripe on the card is Low Coercivity material and the High Coercivity setting is selected.

Solution 2: To use the cards you have, choose the Low Coercivity setting. To encode with High Coercivity, obtain High Coercivity cards. *Make sure the cards work with your magnetic stripe reader.*

If you cannot fix the problem, contact your service provider for assistance.

Related Topics:

["Cleaning the printer" on page 39](#)

["Cleaning the printer rollers" on page 41](#)

MS-01407, MS-01408, or MS-01409 Mag Stripe Error

LRC error reading data on track 1, 2, or 3.

What is LRC?

- LRC is special data used when encoding a magnetic stripe. It is not the data you enter.

Possible Cause 1: The card has dirt or damage on the magnetic stripe.

Solution 1: If the message appears a second time, run a printer cleaning card.

Possible Cause 2: The magnetic stripe on the card is Low Coercivity material and the High Coercivity setting is selected.

Solution 2: To use the cards you have, select the Low Coercivity setting. To encode with High Coercivity, obtain High Coercivity cards. *Make sure the cards work with your magnetic stripe reader.*

If you cannot fix the problem, contact your service provider for assistance.

Related Topics:

["Cleaning the printer" on page 39](#)

["Cleaning the printer rollers" on page 41](#)

MS-01410, MS-01411, or MS-01412 Mag Stripe Error

Start Sentinel error reading data on track 1, 2, or 3.

What is a Start Sentinel?

- A Start Sentinel is special data used when encoding a magnetic stripe. It is not the data you enter.

Possible Cause 1: The card has dirt or damage on the magnetic stripe.

Solution 1: Send the card to print again. If the message appears a second time, run a printer cleaning card.

Possible Cause 2: The magnetic stripe on the card is Low Coercivity material and the High Coercivity setting is selected.

Solution 2: To use the cards you have, select the Low Coercivity setting (in Diagnostics). To encode with High Coercivity, obtain High Coercivity cards. *Make sure the cards work with your magnetic stripe reader.*

If you cannot fix the problem, contact your service provider for assistance.

Related Topics:

["Cleaning the printer" on page 39](#)

["Cleaning the printer rollers" on page 41](#)

MS-01413, MS-01414, or MS-01415 Mag Stripe Error

End Sentinel error reading data on track 1, 2, or 3.

What is an End Sentinel?

- An End Sentinel is special data used when encoding a magnetic stripe. It is not the data you enter.

Possible Cause 1: The card has dirt or damage on the magnetic stripe.

Solution 1: Send the card to print again. If the message appears a second time, run a printer cleaning card.

Possible Cause 2: The magnetic stripe on the card is Low Coercivity material and the High Coercivity setting is selected.

Solution 2: To use the cards you have, select the Low Coercivity setting (in Diagnostics). To encode with High Coercivity, obtain High Coercivity cards.
Make sure the cards work with your magnetic stripe reader.

If you cannot fix the problem, contact your service provider for assistance.

Related Topics:

["Cleaning the printer" on page 39](#)

["Cleaning the printer rollers" on page 41](#)

MS-01417, MS-01418, MS-01419, MS-01420, MS-01421 Card Jam

A card was stuck when attempting to read or write magnetic stripe data on the card.

Possible Cause 1: The card is stuck in or near the magnetic stripe module.

Solution 1a: Remove the stuck card. Send the card to print again.

Solution 1b: Make sure cards are free of dirt or oil.

Solution 1c: If the message appears again, run a cleaning card, change the cleaning sleeve, and then clean the rollers in the printer.

If you cannot fix the problem, contact your service provider for assistance.

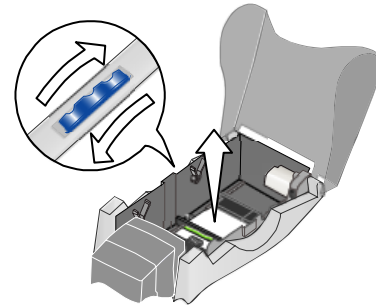

Related Topics:

["Cleaning the printer" on page 39](#)

["Cleaning the printer rollers" on page 41](#)

Turn the page to see information about the next message.

MS-01424 Mag Stripe Error

Unable to read any data from the card.

Possible Cause 1: The cards in the input hopper do not have a magnetic stripe.

Solution 1: Load magnetic stripe cards in the input hopper.

Possible Cause 2: The magnetic stripe cards in the input hopper are not oriented correctly.

Solution 2: Load magnetic stripe cards correctly in the input hopper.

Possible Cause 3: The magnetic stripe on the card is High Coercivity material and the printer is set to Low Coercivity.

Solution 3: To use the cards you have, set the printer to use High Coercivity (using Printer Diagnostics). To encode with Low Coercivity, obtain Low Coercivity cards. *Make sure the cards work with your magnetic stripe reader.*

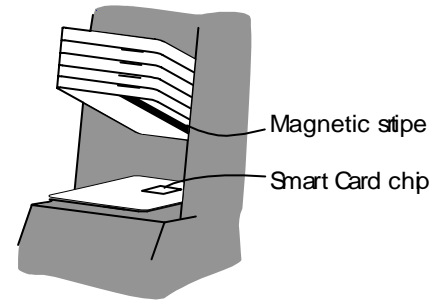

Tips for success:

- If the magnetic stripe card does not have stripe material to match the tracks sent, this message can appear. For example, this message appears if you use a two-track card and send three tracks of magnetic stripe data.

- This message can appear if the automatic start sentinel adjustment (autoSSA) command does not complete successfully. See the information displayed by Printer Diagnostics to address the problem.

If you cannot fix the problem, contact your service provider for assistance.

MS-01425 Mag Stripe Error

Unexpected magnetic stripe coercivity value.

Possible Cause: The magnetic stripe module received an unexpected value that it cannot use.

Solution: Power the printer off and on to restore the default values.
(Disconnect the power cord from the printer power supply and then connect it again.)

MS-01426 EEPROM Error

Magnetic stripe module settings EEPROM read or write error.

Possible Cause: The magnetic stripe module had a temporary failure.

Solution: Power the printer off and on. (Disconnect the power cord from the printer power supply and then connect it again.) If the printer resumes and operates, the problem was temporary.

If you cannot fix the problem, contact your service provider for assistance.

MS-01427 or MS-01428 Mag Stripe Error

Configuration information passed through by the printer driver was not accepted by the magnetic stripe module.

Possible Cause: An application sent configuration information to the magnetic stripe module that could not be used.

Solution: Change the information sent by the application if possible.

If you cannot change the configuration information, contact your service provider for assistance. If you are developing an application, see the Software Developer's Manual.

MS-01429 Mag Stripe Data

Data sent to a track does not match the requirements for that track.

Possible Cause 1: Data sent uses a different encoding format than the one set for the track.

Solution 1: Determine the magnetic stripe formats for the tracks you use. Change the encoding format(s) in the application so it is set to the same format as the track(s), make sure the data characters are allowed for the track(s), and resend the print job.

Possible Cause 2: Data sent uses an encoding format that is not supported by the magnetic stripe module.

Solution 2: Determine the magnetic stripe formats for the tracks you use. Change the encoding format(s) in the application so it is set to the same format as the track(s), make sure the data characters are allowed for the track(s), and resend the print job.

The magnetic stripe module and cards must be capable of accepting and encoding each track of data the application sends.

If you cannot fix the problem, contact your service provider for assistance.

MS-01430 Mag Stripe Error

Control information passed through by the printer driver was not accepted by the magnetic stripe module.

Possible Cause: An application sent control information to the magnetic stripe module that could not be used.

Solution: Change the information sent by the application if possible.

If you cannot change the control information, contact your service provider for assistance. If you are developing an application, see the Software Developer's Manual.

MS-01435 No Mag Stripe

The magnetic stripe module is not installed or detected.

Possible Cause 1: Magnetic stripe data was sent to the printer and a magnetic stripe module is not installed.

Solution 1: Remove the magnetic stripe components of the card design. Print cards without sending magnetic stripe data to the printer.

Possible Cause 2: The magnetic stripe module is not communicating with the rest of the printer.

Solution 2: Check the printer to see whether a magnetic stripe module is included in the printer. If it is, power the printer off and on (disconnect the power cord from the printer power supply and then connect it again) so the printer can detect the module when the printer powers up.

If a magnetic stripe module is part of the printer and you receive this message, contact your service provider for assistance.

Related Topics:

["Features and options" on page 3](#)

PR-01703 Printhead Error

The printhead cam is not in the correct position to print.

Possible Cause: An internal printer component is stuck in the wrong position.

Solution: Fix the printer by clearing any obstructions from inside the print area. Power the printer off and on. (Disconnect the power cord from the printer power supply and then connect it again.) Send the card to print again.

If you cannot fix the problem, contact your service provider for assistance.

Turn the page for information about the next message.

PR-01705, PR-01706 Card Jam

The card is stuck or lost in the printer.

Possible Cause: The card is stuck in the print area.

Solution: Release the card so it can move.

- 1 Open the top cover of the printer.
- 2 Remove the ribbon cartridge.
- 3 Locate the card inside the print area. The card might be stuck near the cleaning roller, the printhead, near the optional magnetic stripe or smart card module, or at the end of the card track.
- 4 Turn the Manual Advance Knob to move the card.
- 5 If needed, grasp an end of the card and pull to remove the card.
- 6 Replace the ribbon cartridge and close the printer cover.
- 7 to clear the printer.

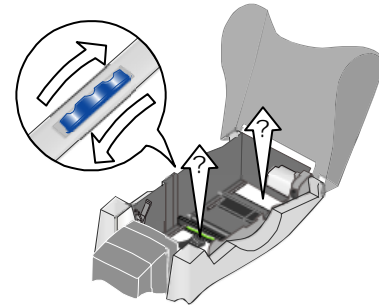

Tips for success:

- If the print ribbon is torn, fix the print ribbon.
- If the printer picks two cards, fan cards before loading the input hopper.
- If you are printing on StickiCard™ adhesive-backed plastic cards, this message can appear. For best results, clean the printer more often, such as after every 100 cards that are printed.

- If cards get stuck often, replace the cleaning roller and run a cleaning card. If the problem remains, clean the printer rollers.

If you cannot fix the problem, contact your service provider for assistance.

Related Topics:

["Cleaning the printer" on page 39](#)

["Cleaning the printer rollers" on page 41](#)

PR-01710 EEPROM Error

Factory settings read problem.

Possible Cause: The printer had a temporary failure.

Solution: Power the printer off and on. If the printer resumes and operates, the problem was temporary.

If you cannot fix the problem, contact your service provider for assistance.

PR-01715, PR-01716 Cover Open

The cover was opened during printing.

Possible Cause: The top cover was not closed securely or was opened during printing.

Solution: Push down firmly on the front edge of the top cover until it clicks closed.

If the cover does not close...

- Open the printer and make sure the print ribbon cartridge is installed correctly.
- Check for any items inside the printer, such as a cleaning roller that is out of place. Fix any problems that you see.
- Make sure that no cards are stuck in the printer. Remove any cards from inside the printer.
- Make sure the printhead cartridge is installed correctly. The top cover will not close if the printhead cartridge is not installed correctly.
- Make sure that nothing outside the printer prevents the cover from closing.

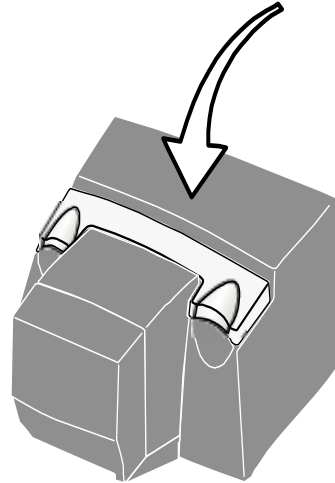

PR-01718 Printhead Temp

The printhead temperature is too high.

Possible Cause: The printer detects a temporary heat buildup while printing.

Solution: The card in process was printed. Wait a few minutes to allow the printer to cool down.

If the message occurs often:

- Clear any items around the printer and make sure that air can circulate around the printer.
- If the printer is operating in an environment above 95° F (35° C) for a short time, power off the printer and resume printing when the temperature reaches 95° F (35° C) or lower.
- If the printer often operates in an environment above 95° F (35° C), power off and disconnect the printer. Move the printer, PC, and any other equipment (such as a camera) to an environment with a temperature consistently at or below 95° F (35° C).

If you cannot fix the problem, contact your service provider for assistance.

PR-01719 Printhead Error

The printhead is not installed or detected.

Possible Cause: The printhead cartridge is not installed or the cables are not attached to the printhead cartridge correctly.

Solution: Power off the printer. Attach the printhead cable to the printhead cartridge. Make sure the plug is pushed all the way into the receptacle.

Replace the printhead cartridge in the cover arm, close the printer, and power on the printer.

- If the printer cover does not close, make sure the printhead cartridge is installed correctly. The cover will not close if the printhead cartridge is not installed correctly.

See *Info Central* for steps to attach the printhead cable and to replace the printhead.

If you cannot fix the problem, contact your service provider for assistance.

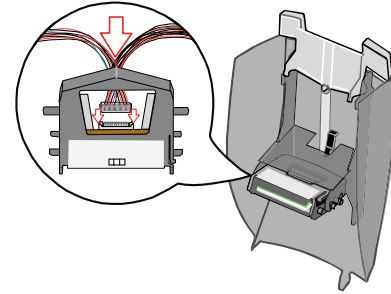

PR-01720 Ribbon Error

The print ribbon index mark was not found.

Possible Cause 1: The print ribbon is not installed correctly.

Solution 1: Remove and reinstall the print ribbon. Make sure the print ribbon cartridge is fully seated.

Possible Cause 2: The print ribbon is folded on the take-up spool.

Solution 2: Remove and re-install the print ribbon on the cartridge; cut the print ribbon, removed used ribbon from the take-up spool, and fasten the cut end of the ribbon to the empty take-up spool.

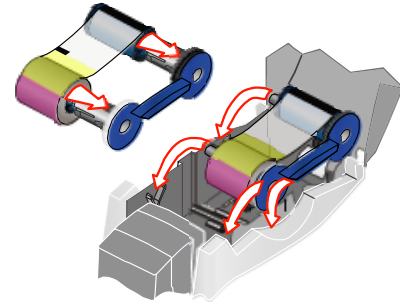

Tips for success

- Make sure the print ribbon cartridge is seated correctly in the cover arm.
- Make sure the reflective label on the printhead is not dirty. Clean it with a soft cloth if needed.
- You might have moved the print ribbon while the printer power was off. The next card will print correctly. The printer is designed to allow you to fix problems while the printer power is on.

If you cannot fix the problem, contact your service provider for assistance.

Related Topics:

["Loading print ribbon" on page 7](#)

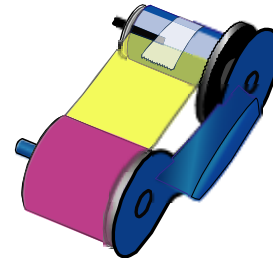

PR-01721 EEPROM Error

Operational settings read error.

Possible Cause: The printer had a temporary failure.

Solution: Power the printer off and on. (Disconnect the power cord from the printer power supply and then connect it again.) If the printer resumes and operates, the problem was temporary.

If you cannot fix the problem, contact your service provider for assistance.

PR-01723 Hardware Error

General printer fault.

Possible Cause: The printer had a temporary failure.

Solution: Power the printer off and on. (Disconnect the power cord from the printer power supply and then connect it again.) If the printer resumes and operates, the problem was temporary.

If you cannot fix the problem, contact your service provider for assistance.

Turn the page to see information about the next message.

PR-01724 Ribbon Break

The print ribbon is broken.

Possible Cause 1: The print ribbon has broken or is not installed.

Solution 1: Trim the broken ribbon evenly and tape the cut end of the ribbon to the ribbon on the take-up spool. Install the ribbon cartridge.

NOTE: Do not switch take-up spools when fixing.

Possible Cause 2: If the ribbon type is K or KT, the print ribbon is at the end of the roll.

Solution 2: Load a new roll of monochrome print ribbon.

Possible Cause 3: The transparent wheel of the print ribbon cartridge is not in the correct position.

Solution 3: Load the print ribbon cartridge with the transparent wheel in the slot. If it does not go in easily, it is damaged; obtain a new print ribbon cartridge.

Technical issues:

- If you have recently changed edge-to-edge settings using the driver, printing might be too close to the edge of the card. Change edge to edge settings.

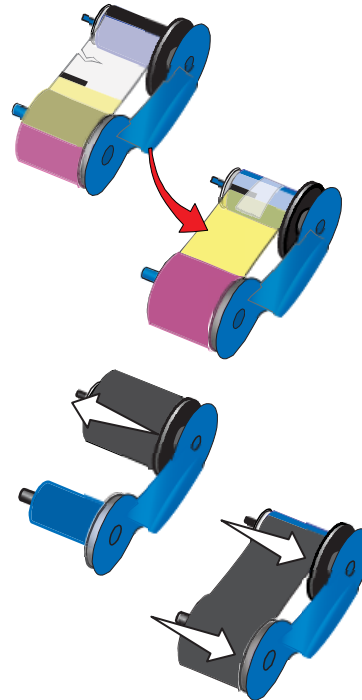

- You might have moved the print ribbon while the printer power was off. The next card will print correctly. The printer is designed to allow you to fix problems while the printer power is on.
- If the print ribbon is stuck to the card, the Intensity setting might be so high that printing causes the ribbon to stick to the card. Lower the Intensity or power setting.
- The card design might be longer than the card size. Change the card design to be less than or equal to the card size in the long direction (3.37 inches or 85.60 mm).
- Printing might not be positioned properly on the card. Change the “Left/Right” position of printing so the printing begins and ends on the card.

If you cannot fix the problem, contact your service provider for assistance.

Related Topics:

["Open the Printer Toolbox" on page 19](#)

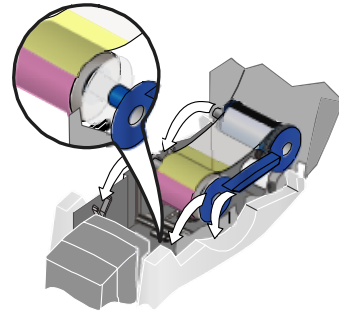

PR-01726 Ribbon Out

Out of print ribbon.

Possible Cause 1: The print ribbon cartridge is empty.

Solution 1: Reload the print ribbon cartridge. Change the cleaning sleeve and replace the cartridge in the printer. Run a cleaning card as soon as printing is completed.

Possible Cause 2: The print ribbon is not loaded correctly.

Solution 2: Load the print ribbon correctly and then close the cover.

Possible Cause 3: This ribbon has been completely used.

Solution 3: Use a new roll of ribbon.

Related Topics

["Loading print ribbon" on page 7](#)

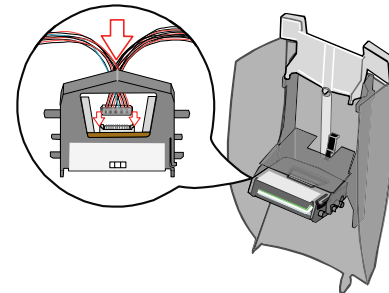
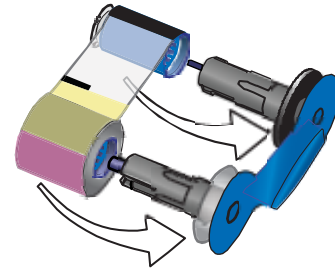

PR-01730 Printhead Error

Unable to read the printhead temperature.

Possible Cause 1: The printhead cable is not attached to the printhead cartridge.

Solution 1: Power off the printer. Attach the printhead cables correctly.

Possible Cause 2: The printhead cable or printhead cartridge is faulty.

Solution 2: If you have another printhead cartridge, you can replace the printhead cartridge to see if that solves the problem.

See *Info Central* for steps to attach the printhead cable and to replace the printhead.

If you cannot fix the problem, contact your service provider for assistance.

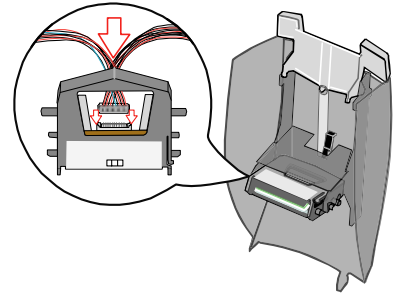

PR-01737 Ribbon Low

The print ribbon is low.

This message does not indicate a problem; it means that at least 90 percent of the print ribbon has been used. This message is for your information so that you can plan to replace the print ribbon.

When you press the Ready key on the LCD panel, or the OK button on the message box, the message is not displayed again even if the condition continues, until you power off and power on the printer.

PR-01738 Ribbon Error

The printer cannot identify the ribbon installed.

Possible Cause 1: You have installed an unsupported print ribbon.

Solution 1: Press the Ready key to print one-color images using settings for monochrome (K) ribbon. (The printer cannot use an unsupported print ribbon to print full-color images.) If the printer is a monochrome printer and you have installed a full-color print ribbon, install a monochrome print ribbon.

Possible Cause 2: You have installed a roll of Datacard-approved print ribbon that is not supported by this printer.

Solution 2: Make sure the new type of ribbon is approved for use with this printer. Run the latest Firmware Update Utility to install support for the new type of ribbon in this printer.

Possible Cause 3: You have installed a defective roll of CP60 print ribbon.

Solution 3: Install another roll of CP60 print ribbon.

Possible Cause 4: You have separated parts of the print ribbon.

Solution 4: Replace missing parts of the print ribbon.

If you cannot fix the problem, contact your service provider for assistance.

SC-01804 No Smart Card

The smart card module is not installed or detected.

Possible Cause 1: Smart card data was sent to the printer and a smart card module is not installed.

Solution 1: Remove the smart card components of the card design. Print cards without sending smart card data to the printer.

Possible Cause 2: The smart card module is not communicating with the rest of the printer.

Solution 2: Check the printer to see whether a smart card module is included in the printer. If it is, power the printer off and on (disconnect the power cord from the printer power supply and then connect it again) so the printer can detect the module when the printer powers up.

If a smart card module is part of the printer and you receive this message, contact your service provider for assistance.

Related Topics:

["Features and options" on page 3](#)

Index

A

address mode
 network set up 30
 setting 55
arrow keys 10
ASCII data stream 38

B

backlighting, LCD 53
built-in Ethernet option 3, 25
built-in Ethernet port 2
button, Ready, see Ready key 13

C

cable
 network 25
cable guides 2
card
 counters 49
 handling 5
 input hopper 1, 4
 load magnetic stripe 6
 load smart card 6
 loading 5

 not picked 41, 70
 preventing jams 41
 printing 37
 printing test card 13
 quality, optimizing 43
card design 35
cleaning 41
 card, part number 64
 frequency 40
 printer rollers 41
 sleeve, part number 64
 supplies 64
cleaning card
 running 39
 when to run 7
cleaning pen, using 41
cleaning roller, location 3
cleaning sleeve
 changing 39
 when to replace 7
color
 alignment problems 41
 monochrome ribbons 63
 printer feature 4
 printer test card 14
command prompt 23

communication error 80

configuration

 LCD menu 53

 network 23

 tools 19

connection

 Ethernet 3, 27

 USB 3, 28

cover 1

cover arm 3

cover open 7, 102

CP Driver

 data format 10

 features supported 20

 set up 35

CP60

 Printer Guide 1

Customer Care Center ii

D

data error 71, 72, 77, 79

data format

 changing 54

 features 16, 19

 on LCD panel 10

 setting up network printer 34

 summary 19

 types 15

 viewing 50

Datacard Customer Care Center ii

DB9 port 4

display, see LCD panel 10

DM messages 66

Down Arrow key 10

driver

 data format 16, 37

 set up 35

 setting data format 54

duplex messages 66

duplex module 1, 4

E

electrical requirements 22

EMC directive 125

Enter key 10

environment, operating 22

errors, see messages 65

Ethernet

 connecting 27

 port 2

 printer SNMP support 36

 support 25

F

- FAQ ii
- FCC notice 124
- features and requirements
 - driver data format 16
 - Open Card 17
- file2prn utility 23, 74
- firmware revision 48
- flash error 73, 75
- full-color
 - identifying printer feature 4
 - print cycles 49
 - support by data format 20

G

- gateway address
 - setting 57
 - viewing 51

H

- handling cards 5
- hardware error 81, 107
- HP
 - print server 27
 - Web Jetadmin utility 23

I

- Info Central ii
- information resources ii
- input hopper
 - card capacity 4
 - loading 5
 - location 1
- installation
 - overview 21
 - using Ethernet port 27
 - with wired print server 28
 - with wireless print server 29
- IP address
 - required address mode 57
 - setting 57
 - view current 51
- IS message 70

J

- jams, preventing 41

K

- K power setting 59
- key, Ready 10

L

latch 1

LCD panel

- backlighting 53
- change settings 53
- components 10
- location 1
- menu 46
- tips for success 45

Linux

- supported operating system 25

loading

- cards 5
- print ribbon 7

lock

- input hopper 4
- security 2

LPD/LPR protocol 17, 19

M

MAC address

- label 3
- viewing on LCD panel 51

magnetic stripe

- messages 82
- module location and type 4

on test cards 13

orientation in input hopper 6

support by data format 20

manual advance knob 2

memory error 76

menu

LCD panel 46

messages

on LCD panel 10, 65

on PC 65

responding to 65

where displayed 19

MIB

printer 36

SNMP support 36

monochrome

identifying printer 4

print cycles 49

print ribbons 63

printing intensity 59

support by data format 20

MS messages 82

N

network

change printer settings 53

network (continued)

- connect data cable 27
- permissions 27
- port 2, 27
- requirements 25
- set up printer 30
- set up tools 23
- view IP address 51

network installation

- connecting to the network 27
- overview 25
- requirements 25
- types of connections 25
- with wired print server 28
- with wireless print server 29

no mag stripe error 96

O

Open Card

- CD-ROM 23
- data format 10, 17, 38
- features supported 20
- option on printer label 3
- printing a card 37
- set up card design 35
- setting data format 54

utilities 23

operating environment 22

operating systems

supported for Open Card feature 25

options 4

output hopper 1

P

permissions

network 27

pick roller, cleaning 41

Ping 23

ports, location 2

power

receptacle location 2

power off the printer 13

power on the printer 9, 13

power supply rating 22

PR errors 97

print ribbon

broken 109

cartridge 3

loading 7

monochrome choices 63

- print server
 - wired 27, 28
 - wireless 27, 29
 - printer
 - cleaning 39
 - cleaning the rollers 41
 - components 1, 3
 - driver set up 35
 - Ethernet option 25
 - firmware revision 48
 - installing 21
 - messages 10, 65
 - monochrome or full color 4
 - network setup 30
 - Open Card 35
 - operating environment 22
 - options 4
 - physical description 22
 - power on 9
 - restart 33
 - SNMP support 36
 - toolbox 37
 - viewing serial number 47
 - Printer Guide ii
 - printhead
 - cartridge 3
 - error 97
 - temperature 103
 - printing a card
 - from a PC 37
 - using Open Card format 38
 - using the driver 37
 - problems
 - colors misaligned 41
 - messages 65
 - repeated card jams 41
 - troubleshooting 61
 - protocols
 - LPD/LPR 19
 - RAW data 19
 - TCP/IP 19
- Q**
- quality, optimizing 43
- R**
- RAW data 19
 - Ready key 1, 10, 13
 - regulatory compliance 124
 - related manuals ii
 - reserved 54

- ribbon
 - see print ribbon 7
- ribbon break message 109
- ribbon cartridge, loading 7
- ribbon error message 105
- ribbon out message 111
- roller
 - cleaning 3
 - pick roller, cleaning 41
- S**
- safety 127
- safety and compliance notification 124
- SC 01804 115
- security lock receptacle 2
- serial number 47
- Service and Support FAQ ii
- set up
 - driver data format 35
 - Open Card format 35
- site requirements 22
- smart card
 - error 115
 - optional serial port 2
 - optional USB port 2
 - orientation in input hopper 6

- printer label 4
- support by data format 20
- SNMP support 36
- starter kit 13
- static IP
 - setting address mode 55
- status light
 - at power on 9
 - location 1
 - restart 33
 - when printing test card 14
- StickiCard 40
- subnet mask
 - setting 57
 - viewing 51
- SY messages 71
- T**
- TCP/IP protocol 19, 25
- Telnet 23
- test card
 - printer 13
 - requirements 13
 - with magnetic stripe 13
- three-track magnetic stripe module 4
- tiff2opencard utility 23

- tools 23
- trademarks 128
- troubleshooting 61
- turning on the printer 9

U

- Up Arrow key 10
- USB port
 - connect print server 28
 - location 2
 - wired print server 28
 - wireless print server 29
- utilities 74
 - file2prn 23
 - HP Web Jetadmin 23
 - operating system 23
 - tiff2opencard 23

W

- where to go for more information ii
- Windows
 - supported operating system 25
- wireless
 - adapter for computer 29

Safety and compliance (FCC)

Regulatory compliance

Notice for USA (FCC notice)

This equipment generates, uses, and can radiate radio frequency energy. If it is not installed and used in accordance with this instruction manual, it may interfere with radio communications. This equipment has been tested and found to be within the limits for Class A computing devices, pursuant to Subpart J of Part 15 of FCC rules, designed to provide reasonable protection against radio interference in a commercial environment. Operation of this equipment in a residential environment may possibly cause interference. In the event of interference, the user, at their own expense, will be required to take whatever measures are necessary to correct the problem.

This equipment has been tested and found to comply with the limits for a Class A digital device, pursuant to part 15 of the FCC Rules. These limits are designed to provide reasonable protection against harmful interference when the equipment is operated in a commercial environment. This equipment generates, uses, and can radiate radio frequency energy and, if not installed and used in accordance with the instruction manual, may cause harmful interference to radio communications. Operation of this equipment in a residential area is likely to cause harmful interference in which case the user will be required to correct the interference at his own expense.

Notice for Canada

This digital apparatus does not exceed the Class A limits for radio noise for digital apparatus set out in the Radio Interference Regulations of the Canadian Department of Communications.

Le présent appareil numérique n'émet pas de bruits radioélectriques dépassant les limites applicables aux appareils numériques de la classe A prescrites dans le Règlement sur le brouillage radioélectrique édicté par le ministère des Communications du Canada.

The term "IC:" before the radio certification number only signifies that Industry Canada Technical specifications were met.

Notice for Europe

We hereby certify that the CP60 Card Printer complies with EMC Directive 89/336/EEC and R&TTE Directive 1999/5/EC. This printer conforms to Class A of EN 55022 and to EN 301 489-5. Operation of this equipment in a residential environment may possibly cause interference. In the event of interference, the user, at their own expense, will be required to take whatever measures are necessary to correct the problem.

Notice for Taiwan

警告使用者：
這是甲類的資訊產品，在居住的
環境中使用時，可能會造成射頻
干擾，在這種情況下，使用者會
被要求採用某些適當的對策。

Notice for Japan

This equipment is in the Class A category of information technology equipment based on the rules of the Voluntary Control Council for Interference by Information Technology Equipment (VCCI). When used in a residential area, radio interference may be caused. In this case, the user may be required to take appropriate corrective actions.

この装置は、クラスA 情報技術装置です。この装置を家庭環境で使用すると電波妨害を引き起こすことがあります。この場合には使用者が適切な対策を講ずるよう要求されることがあります。 VCCI - A

Notice to Users of All CP60 Printers

The printer emits radio-frequency waves and must be used as installed and recommended by Datacard Group, the printer manufacturer. You may not modify the printer or how it is used without the written permission of Datacard Group. You may not operate the printer after modifying it or its method of operation.

Notice to Users of Printers Equipped with Contactless Smart Card Reader

The contactless smart card reader emits radio-frequency waves and must be used as installed and recommended by Datacard Group, the printer manufacturer. You may not modify the reader or how it is used without the written permission of Datacard Group. You may not operate the printer after modifying the reader or its method of operation.

Liability statement

This Datacard® brand product has been built to the high standards of DataCard Corporation (doing business as Datacard Group). Please note and heed the WARNING and CAUTION labels that have been placed on the equipment for your safety. PLEASE DO NOT ATTEMPT TO OPERATE OR REPAIR THIS EQUIPMENT WITHOUT ADEQUATE TRAINING. ANY USE, OPERATION, OR REPAIR IN CONTRAVENTION OF THIS DOCUMENT IS AT YOUR OWN RISK. BY ACCEPTANCE OF THIS SYSTEM YOU HEREBY ASSUME ALL LIABILITY CONSEQUENT TO YOUR USE OR MISUSE OF THIS EQUIPMENT. DATACARD CORPORATION SHALL NOT BE LIABLE FOR ANY INCIDENTAL, INDIRECT, SPECIAL OR CONSEQUENTIAL DAMAGE OF ANY KIND. Equipment specifications, applications and options are subject to change at the sole discretion of DataCard Corporation without notice.

Safety

All Datacard® brand products are built to strict safety and reliability specifications in accordance with UL60950 and Canadian requirements, and the Low Voltage Directive 73/23/EEC. Therefore, safety issues pertaining to operation and repair of Datacard® brand equipment are primarily environmental and human interface.

The following basic safety tips are given to ensure safe installation, operation and maintenance of Datacard® brand equipment and are not to be considered as comprehensive on all matters of safety.

Safe environment

- Connect equipment to a grounded facility power source. Do not defeat or bypass the ground lead.
- Place the equipment on a stable surface (table) and ensure floors in the work area are dry and non-slip. Insulated rubber floor mats are preferred.
- Know the location of equipment branch circuit interrupters or circuit breakers and how to turn them on and off in case of emergency.
- Know the location of fire extinguishers and how to use them. ABC type extinguishers may be used on electrical fires.
- Know local procedures for first aid and emergency assistance at the customer facility.
- Use adequate lighting at the equipment.
- Maintain the recommended range of temperature and humidity in equipment area.

Safe human interface

- Use proper lifting techniques when moving or installing the equipment.
- Use standard electrostatic discharge (ESD) precautions when working on or near electrical circuits.
- Do not defeat or disconnect safety interlocks on covers. Operate the printer with the cover closed.

Acknowledgments

Microsoft, Windows NT, and Windows are trademarks or registered trademarks of Microsoft Corporation.

Advanced Imaging Technology and StickiCard are trademarks of DataCard Corporation in the United States and/or other countries. DatacardDuraGardis a registered trademarks of DataCard Corporation in the United States and/or other countries. PartnerPage is a service mark of DataCard Corporation in the United States and/or other countries. The color blue with Platinum Flecks mark is a registered trademark of DataCard Corporation in the European Union and other countries.

HP, Jetdirect, and Web Jetadmin are trademarks of Hewlett Packard Development Corporation.

SCM is a trademark of SCM Microsystems, Inc.

iCLASS and HID are registered trademarks of HID Corporation.

All other trademarks are the property of their respective owners.

Names and logos on sample cards are fictitious. Any similarity to actual names, trademarks, or trade names is coincidental.

All proprietary information embodied in this product is the property of Datacard Corporation.

Printers with Built-in Ethernet and Open Card features are subject to the following:

- Bar code fonts © 2002 by Rivers Edge Corp.
- Printers with the Open Card feature may contain hp2pbm software. © 1989, 1990, 1991 Chris Lewis. All rights reserved.

Datacard Group

11111 Bren Road West
Minnetonka, MN 55343-9015
952.933.1223
952.933.7971 FAX

Dealer information:

Datacard is a registered trademark of DataCard Corporation.

July 2005

558871-201 Rev. E
