



2019 CATALOG



K I L N S B U I L T T O L A S T

Clean. Precise. Dependable.

L&L Kiln's patented hard ceramic element holders protect your kiln.

- **Fires Clean**
- **Fires Evenly**
- **Easy to Program**
- **Keeps Working**



hotkilns.com/easy-fire



KILNS BUILT TO LAST



INDEX TO L&L KILNS

PROFESSIONAL POLYGONAL KILNS

Easy-Fire Flagship Kilns	4-5
School-Master School Kilns	6
Equad-Pro Production Kilns	7
Jupiter Configurable Sectional Kilns	8-9
Pull-Apart Kilns	10
JH Series Chrystalline Glaze Kilns.....	11

SMALL CRAFT KILNS

DL Series Doll & Test Kilns.....	12
Fuego Craft Kilns	13
Liberty-Belle Craft Kilns.....	14

SQUARE & RECTANGULAR KILNS

Easy-Fire XT Series Square Kilns	15
DaVinci Production Kilns	16-17

FRONT-LOADING KILNS

eFL Series Inexpensive Front-Loading Kilns.....	18-19
Hercules Medium Sized Commercial Front-Loader Kilns.....	20
Easy-Load Large Commercial Front-Loading Kilns.....	21

BELL-LIFT KILNS

DaVinci Large Bell Lift Kilns.....	22
Jumbo 100 Cubic Foot Production / Industrial Kilns	23

INDUSTRIAL KILNS

Car Bottom Kilns.....	24
Large Front-Loading Kilns	24
Large Polygonal Kilns	25
Large Square Kilns.....	25
Alloy Retort Kilns	25

OPTIONS

Vent-Sure Vent and Vent Options.....	26
Control, Power and Thermocouple Options	27
Element Options.....	28
Stand Options	28
Unpowered Sections.....	28
Powered Bottoms	28
Custom Options	28
Kiln Shelves and Posts	29

L&L FEATURES

Signature L&L Features.....	30-31
-----------------------------	-------

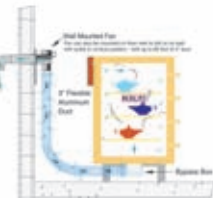

EASY-FIRE KILNS

L&L's Flagship Kilns

This is the classic L&L pottery kiln used by most of our customers. Now with a new angled control panel for easy viewing.



- DynaTrol Dynamic Three Zone Control
- 4 Easy-Fire plus 6 Custom Programs
- Hard Ceramic Element Holders
- Cone 10 • 2350°F • 1290°C (except for single phase e28T-3 models)
- Choice of 2-1/2" or 3" Brick
- Full-View Solid Peephole Plugs
- Stainless Spring Hinge - Wide Open for Easy Loading
- Full-Support Heavy-Duty 14 Gauge Aluminized Stand
- Fold Down Angled Panel for Easy Maintenance
- c-MET-us listed to UL499 Standards

Features & Benefits

CONSTRUCTION

Sectional: Made of 9" high sections with a reversible bottom and a spring-hinged top. The case is stainless steel wrapped around 2-1/2" or 3" of K23 highly insulating firebrick with 3 adjusting screw clamps per section. Easy to move: hotkilns.com/assemble-easy-fire



Brushed stainless steel spring hinge (on 23" & 28" diameter models) makes opening easy while still allowing lid to be supported and providing an unobstructed opening for easy loading. Safety pin prevents lid from closing while loading.



Firebrick is coated with a proprietary anti-dusting, hardening, and reflective coating.

Ceramic element terminals make element changes easy using a wrench.

A heavy 14 gauge full support solid stand with multiple bends for strength. Includes molded plastic feet protectors.

Full-view solid ceramic peephole plugs are 1" diameter non-tapered with heat-locked head. There is one for each section.

ELEMENT HOLDER SYSTEM

Patented hard ceramic element holders protect brick and elements from wear and loading damage. All-ceramic element connection block and hard holders makes changing elements easy.



DYNATROL ZONE CONTROL

DynaTrol with 4 Easy-Fire programs (Slow Bisque, Fast Bisque, Slow Glaze, Fast Glaze), 6 Vary-Fire custom programs, PreHeat, Delay, Program & Segment Review, and Diagnostics. Zone control with 2 or 3 zones. Separate Type K 8 gauge thermocouples with ceramic protection tubes. Genesis touch screen control optional (see page 27).



PIGGY-BACKED COOL-FIRE CONTROL PANEL

All controls and components are in a separate angled control panel that is piggy-backed on top of the element connection box. Both boxes are hinged and open and remove easily. A layer of insulation plus the separate control box keep the controls and relays cool. Power wires are oversized to run cool. On/off switch and control fuse included.

INSTRUCTIONS AND SUPPORT

Complete visual instructions with control reference, process information, assembly, troubleshooting, and parts list. Web videos show how to use the control. (hotkilns.com/videos)

Limited 3 year warranty. (hotkilns.com/warranty)

View all features of L&L Kilns at hotkilns.com/features

Options

FURNITURE KIT

Includes Cone 11 full shelves and half shelves as listed below plus a square post kit which includes six each 1/2", 1", 2", 4", 6" and 8" high 1-1/2" square cordierite posts plus heat-resistant gloves. Prices below.



VENT-SURE DOWNDRAFT KILN VENT (PAGE 26)

Vent-Sure 130 CFM downdraft vent pulls air down to bottom of kiln to improve temperature uniformity and vent corrosive fumes. Bypass collection box mounted on kiln allows adjustment of venting. Fan motor, mounted away from the kilns, stays cool and no vibration transmitted to the kiln. See page 26.

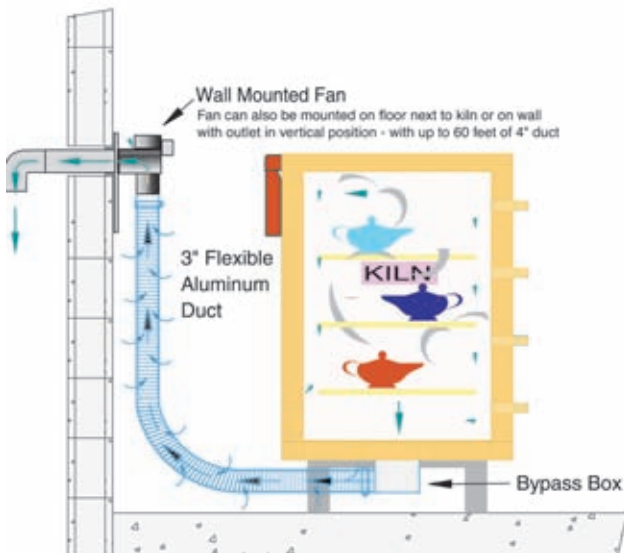

Vent-Sure (120 volts) (M-V-VENT/00)\$520
 Vent Doubler (M-V-VENT/DB)\$155
 Vent Control (M-V-CNTL/00)\$160

VOLTAGE OPTIONS (PAGE 27)

Order 240 or 208 volts, single or three phase, or international voltages. KW, amperage, and fuse size for each voltage below. 480 volts is not available. No Charge for any voltage options.

ROLLING KILN STAND (PAGE 28)



L&L's rolling kiln stand features heavy gauge (14 ga) galvanized steel construction with multiple bends for extra strength, steel swivel locking casters, integrated vent collection box support, and guide rails for the kiln. Each size is fitted to the kiln. See page 28.

Rolling Stand for 8 Sided Kiln (A-J-18RL/00)\$290
 Rolling Stand for 10 Sided Kiln (A-J-23RL/00).....\$345
 Rolling Stand for 12 Sided Kiln (A-J-28RL/00).....\$375

CONTROL OPTIONS (PAGE 27)

Genesis Touch Screen Control (N-G-GENS/OP)\$135
 KISS Computer Software (N-G-KISS/US)\$700
 Door Interlock Switch (K-E-LATC/00)\$320
 Type S Platinum Thermocouples (T-G-SJUP/UG) \$250 each
 Pyrocil metallic Thermocouples (T-G-E23M/UG)\$44 each

ELEMENT OPTIONS (PAGE 28)



Quad Element Option: Four rows of elements for each 9" kiln section. Maximum element life for constant high-firing. See page 28. Prices below.

APM Elements. Priced by Quote.

SEE PAGES 26-29 FOR THESE AND MORE OPTIONS

Model No.	Kiln Price	Furn Kit	Quad Elem	No. Shelves F=full, H=half	Brick Thick	Inside Diam	Inside Height	Cubic Feet	Exterior Dimensions (in)	240/1 KW-Amp-Fuse	240/3 KW-Amp-Fuse	208/1 KW-Amp-Fuse	208/3 KW-Amp-Fuse	Lbs Kiln	Lbs w/Kit
e18S	\$2050	\$340	\$200	15.5" (1F, 4H)	2.5"	17.5"	18"	2.6	29W x 31H x 30D	5.7~23.9~30	5.7~20.7~30	5.0~23.9~30	5.0~20.8~30	190	245
e18S-3	\$2100	\$340	\$200	15" (1F, 4H)	3"	16.5"	18"	2.5	29W x 32H x 30D	5.7~23.9~30	5.7~20.7~30	5.0~23.9~30	5.0~20.8~30	220	255
e18T	\$2700	\$380	\$280	15.5" (2F, 4H)	2.5"	17.5"	27"	3.9	29W x 40H x 30D	8.4~35.0~50	8.4~20.2~30	8.4~40.4~60	8.4~23.3~30	230	305
e18T-3	\$2775	\$380	\$280	15" (2F, 4H)	3"	16.5"	27"	3.7	29W x 41H x 30D	8.4~35.0~50	8.4~20.2~30	8.4~40.4~60	8.4~23.3~30	255	325
e23S	\$2725	\$380	\$230	21" (1F, 4H)	2.5"	23.5"	18"	4.7	31W x 32H x 42D	9.5~39.4~50	9.5~34.1~50	8.3~40.0~50	8.3~34.6~50	265	350
e23S-3	\$2825	\$380	\$230	20" (1F, 4H)	3"	22.5"	18"	4.4	31W x 33H x 42D	9.5~39.4~50	9.5~34.1~50	8.3~40.0~50	8.3~34.6~50	305	375
e23T	\$3375	\$475	\$340	21" (2F, 4H)	2.5"	23.5"	27"	7.0	31W x 41H x 42D	11.5~48.0~60	11.5~27.7~40	10.0~48.0~60	11.0~30.5~40	325	420
e23T-3	\$3450	\$475	\$340	20" (2F, 4H)	3"	22.5"	27"	6.7	31W x 42H x 42D	11.5~48.0~60	11.5~27.7~40	10.0~48.0~60	11.0~30.5~40	360	455
e28S-3	\$3325	\$590	\$305	25-1/2" (6H)	3"	28"	18"	6.8	37W x 33H x 48D	11.5~47.9~60	11.5~41.5~60	10.0~48.0~60	10.0~41.6~60	370	470
e28T-3	\$3950	\$720	\$445	25-1/2" (8H)	3"	28"	27"	10.2	37W x 42H x 48D	11.5~48.0~60	16.6~40.0~50	10.0~48.0~60	14.3~39.8~50	460	565

Cone Rating: All models are rated to Cone 10 except the single phase e28T-3 which is rated to Cone 8 at 240V/1 Phase, Cone 5 at 208V/1 Phase, but Cone 10 for any 3 phase kiln. If planning continuous Cone 6 firings on a 10 cubic foot single phase kiln we recommend the eQuad-Pro eQ2827-3 (page 7) or the Jupiter JD2927-3 (page 8) (both have more KW than the e28T-3 in their single phase versions).

Plugs on US Models only: 6-50 on single phase and 15-50 on three phase.

UL Listing: c-MET-us listed to UL499 standards. **CE Listing:** CE Listed models are available.

More: See Easy-Fire Specification Sheets at hotkilns.com/spec-easy-fire for shipping dimensions, electrical ratings, fuse and wire sizes.

SCHOOL-MASTER

Made For Schools



For busy school teachers who want a simple control.

Features & Benefits

SPECIAL FIVE-YEAR LIMITED WARRANTY

(hotkilns.com/five-year-warranty)

■ ONE-TOUCH™ INTUITIVE KILN CONTROL

The One-Touch™ Control is designed for busy school teachers - One touch and you are ready to fire the bisque and glaze programs typically used in schools. (It is also easy to adjust simple parameters like cone, delay, hold, heat-up and cool-down rates). You can even create four custom ramp/hold programs. hotkilns.com/one-touch



- Cone 6 • 2230°F • 1220°C (except for 208 volt single phase SM28T-3 model)
- Single zone with graded elements
- Includes all other features of the Easy-Fire Kiln Series

Options

FURNITURE KIT

Includes Cone 11 full shelves and half shelves as listed below plus a square post kit which includes six each 1/2", 1", 2", 4", 6" and 8" high 1-1/2" square cordierite posts plus heat-resistant gloves. Prices below.

POWERFUL VENT-SURE DOWNDRAFT KILN VENT (PAGE 26)

Vent-Sure (120 volts) (M-V-VENT/00).\$520
 Vent Doubler (M-V-VENT/DB)\$155
 (NOTE: The vent control is not available on this kiln)

VOLTAGE & CONTROL OPTIONS

Voltage: Order 240 or 208 volts, single or three phase, or international voltages. KW, amperage, and fuse size for each voltage below. 480 volts is not available. No Charge for any voltage options.

Door Interlock Switch (Page 27)..... \$320

SEE PAGES 26-29 FOR THESE AND MORE OPTIONS

Vent options and rolling stand.

SCHOOL-MASTER KILNS ARE WARRANTED FOR FIVE YEARS!

School-Master Kilns are super-durable and include all of the easy-maintenance features of the Easy-Fire kilns. For simplicity, however, School-Master kilns feature the intuitive One-Touch™ kiln control that has a standard Bisque and Glaze program tuned to the needs of most K-12 programs. Temperature, heating and cooling rate, delay time and soak time can all be easily modified for the two main programs and remain set that way until deliberately changed. In addition, for more advanced users, there are four custom programs. The control is single zone and the kilns have graded elements. Because there are only two sizes the element resistance is well-tuned for good performance. The School-Master kilns are limited to Cone 6 operation even though the construction of the kilns can handle higher temperatures.

Model No.	Kiln Price	Furn Kit	No. of Shelves F=full, H=half	Brick Thick	Inside Diam	Inside Height	Cubic Feet	Exterior Dimensions	240/1 KW-Amp-Fuse	240/3 KW-Amp-Fuse	208/1 KW-Amp-Fuse	208/3 KW-Amp-Fuse	Lbs Kiln	Lbs w/Kit
SM23T	\$3275	\$475	21" (2F, 4H)	2.5"	23.5"	27"	7.0	31W x 41H x 42D	11.5~48.0~60	11.5~27.7~40	10.0~48.0~60	11.0~30.5~40	325	420
SM23T-3	\$3350	\$475	20" (2F, 4H)	3"	22.5"	27"	6.7	31W x 42H x 42D	11.5~48.0~60	11.5~27.7~40	10.0~48.0~60	11.0~30.5~40	360	455
SM28T-3	\$3850	\$720	25.5" (8H)	3"	28"	27"	10.2	37W x 42H x 48D	11.5~48.0~60	16.6~40.0~50	10.0~48.0~60	14.3~39.8~50	460	565

Cone Rating: All models rated for Cone 6 except for the single phase 208 volt SM28T-3, which is rated for Cone 5. If planning continuous Cone 6 firings on a 10 cubic foot single phase kiln we recommend the eQuad-Pro eQ2827-3 (page 7) or the Jupiter JD2927-3 (page 8) because they have more power. **Plugs on US Models only:** 6-50 on single phase and 15-50 on three phase. **UL Listing:** c-MET-us listed to UL499 standards. **CE Listing:** CE Listed models are available. **More:** See hotkilns.com/spec-school-master for shipping dimensions, electrical ratings, fuse and wire sizes.

eQUAD-PRO KILNS

Super-Duty High Production Kilns



The eQuad-Pro sets a new standard in production kilns.

Not UL499 listed

Features & Benefits

- Cone 10 • 2350°F • 1290°C - with extra power with branch fusing for high production and dense loads
- Quad element system (four rows of super heavy gauge elements per 9" high section)
- 3" K23 brick with proprietary reflective brick coating that protects brick and minimizes dusting
- DynaTrol with Dynamic Zone Control (3 Zones). Genesis Touch Screen Control is optional (see page 27).
- Piggy-back cool-fire control panel like Easy-Fire
- Hard ceramic element holders
- Type K 8 GA thermocouples with ceramic protection tubes
- Full support 14 gauge aluminized steel stand
- Solid peephole plugs with full 1" view
- "Easy-Lift, Easy-Load" stainless steel spring hinge system with full-support when door is up and tilted back (there are no support bars to get in the way of loading)
- Three-year Limited Warranty

Options

FURNITURE KIT

Cone 11 full shelves and half shelves as listed below plus a square post kit plus heat-resistant gloves. Prices below.

VENT-SURE DOWNDRAFT KILN VENT (PAGE 26)

Vent-Sure 130 CFM downdraft vent\$520

VOLTAGE & CONTROL OPTIONS (PAGE 27)

Voltage: Order 240 or 208 volts, single or three phase, or international voltages. KW, amperage, and fuse size for each voltage below. 480 volts is not available. No Charge for any voltage options.

Genesis Touch Screen Control (N-G-GENS/OP)\$135
 KISS Computer Software (N-G-KISS/US)\$700
 Type S Platinum Thermocouples (T-G-SJUP/UG) \$250 each
 Pyrocl metallic Thermocouples (T-G-E23M/UG)\$44 each

SEE PAGES 26-29 FOR THESE AND MORE OPTIONS

Genesis control, KISS software, vent options, rolling stand and more.



QUAD ELEMENT SYSTEM INCLUDED

This photograph shows the inside of an eQuad-Pro while firing. Notice how the element holders glow and disperse the radiant heat. The large diameter elements (both of the wire gauge and outside diameter of the element coil), coupled with the unique glowing feature of the hard dense ceramic element holders make these elements last for a very long time. (hotkilns.com/quad) **Optional APM Elements:** Priced by Quote.

Model No.	Kiln Price	Furn Kit	No. of Shelves F=full, H=half	Inside Diam	Inside Height	Cubic Feet	Exterior Dimensions	240/1 KW-Amp-Fuse	240/3 KW-Amp-Fuse	208/1 KW-Amp-Fuse	208/3 KW-Amp-Fuse	Lbs Kiln	Lbs w/Kit
eQ2327-3	\$4275	\$475	20" (2F, 4H)	22.5"	27"	6.7	31W x 42H x 42D	13.4~56.0~70	13.4~32.4~50	11.7~56.0~70	11.7~32.4~50	365	485
eQ2827-3	\$4950	\$720	25.5" (8H)	28"	27"	10.2	37W x 42H x 48D	15.0~62.3~80	15.0~36.0~50	15.0~71.9~90	15.0~41.5~60	480	585
eQ2836-3	\$5800	\$855	25.5" (10H)	28"	36"	13.6	37W x 51H x 48D	19.0~79.2~100	19.0~51.5~70	19.0~91.3~125*	19.0~60.4~80	595	725

*Note: Special model eQ2836-X-208-1P is available with 16.6 KW, 208 Volt/1 Phase, 80 amps for a 100 amp fuse.

More: See hotkilns.com/spec-equad-pro for additional information like shipping dimensions, electrical ratings, fuse sizes and wire connection sizes. All models are direct wired with no cords. For controls see hotkilns.com/dynatrol and hotkilns.com/zone.

Listings: These kilns are not yet UL499 Listed.

JUPITER KILNS

Easy To Take Apart & Highly Customizable

Jupiter kilns are easy-to stack and disassemble because of the plug-in sections.



- Sections can be added later or removed for smaller loads
- DynaTrol with Dynamic Zone Control (2 zones in 18" high models, 3 zone in all other models)
- Hard Ceramic Element Holders
- Most Models are Cone 10 • 2350°F • 1290°C (See grid)
- Choice of 2-1/2" or 3" Brick
- Full-View Solid Peephole Plugs
- Stainless "Easy-Lift, Easy-Load" Spring Hinge
- Wide Open Easy Loading
- Heavy-Duty 14 Gauge Aluminized Stand
- Removable Panel for Easy Maintenance
- c-MET-us listed to UL499 Standards

Features and Benefits

CONSTRUCTION

Sectional: Made of 9" high sections with a reversible bottom and a spring-hinged top (23" & 28" models). The case is stainless steel wrapped around 2-1/2" or 3" of K23 highly insulating firebrick with 3 adjusting screw clamps per section.



Brushed stainless steel spring hinge (on 23" & 28" diameter models) makes opening easy while still allowing lid to be supported while providing an unobstructed opening for easy loading. Safety pin prevents lid from closing while loading.

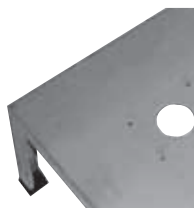

Firebrick is coated with a proprietary anti-dusting, hardening, and reflective coating.

Ceramic element terminals make element changes easy using a wrench.

A heavy 14 gauge full support solid stand with multiple bends for strength. Includes molded plastic feet protectors.

Full-view solid ceramic peephole plugs are 1" diameter non-tapered with heat-locked head. There is one for each section.

ELEMENT HOLDER SYSTEM

Patented hard ceramic element holders protect brick and elements from wear and loading damage. All-ceramic element connection block and hard holders makes changing elements easy.

DYNAMIC ZONE CONTROL

DynaTrol with 4 Easy-Fire programs (Slow Bisque, Fast Bisque, Slow Glaze, Fast Glaze), 6 Vary-Fire custom programs, PreHeat, Delay, Program & Segment Review, and Diagnostics. Zone control with 2 or 3 zones. Separate Type K 8 gauge thermocouples with ceramic protection tubes. Genesis touch screen control optional (see page 27).



SEPARATE PLUG-IN CONTROL PANEL

The Jupiter control panel is separate from the kiln. Keeps controls and relays cool. All sections plug into it. Hinged and removable for easy maintenance. On/off switch and control fuse included.

INSTRUCTIONS AND SUPPORT

Complete visual instructions with control reference, process information, assembly, troubleshooting, and parts list. Web videos show how to use the control. (hotkilns.com/videos)

Limited 3 year warranty. (hotkilns.com/warranty)

You can view all features of L&L Kilns at hotkilns.com/features

Options

FURNITURE KIT

Includes Cone 11 full shelves and half shelves as listed below plus a post kit which includes six each 1/2", 1", 2", 4", 6" and 8" high 1-1/2" square cordierite posts plus heat-resistant gloves. Prices below.



VENT-SURE DOWNDRAFT KILN VENT (PAGE 26)

Vent-Sure 130 CFM downdraft vent pulls air down to bottom of kiln to improve temperature uniformity and vent corrosive fumes. Bypass collection box mounted on kiln allows adjustment of venting. Fan motor, mounted away from the kilns, stays cool and no vibration transmitted to the kiln. See page 26.

Vent-Sure (120 volts) (M-V-VENT/00)\$520
 Vent Doubler (M-V-VENT/DB)\$155
 Vent Control (M-V-CNTL/00)\$160

VOLTAGE OPTIONS (PAGE 27)

240 or 208 volts, single or three phase, or international voltages. KW, amperage, and fuse size for each voltage below. No Charge except for 480 volts.

480 volts/3 phase (available only on JD2900 Series)\$750
 NEMA 1 Panel (required for MET-us Listing)\$750

SEE PAGES 26-29 FOR THESE AND MORE OPTIONS

Genesis control, KISS software, High Limit Control, Back up contactors, vent options, rolling stand and more.

ROLLING KILN STAND (PAGE 28)



L&L's rolling kiln stand features heavy gauge (14 ga) galvanized steel construction with multiple bends for extra strength, steel swivel locking casters, integrated vent collection box support, and guide rails for the kiln. Each size is fitted to the kiln. See page 28.

Rolling Stand for 8 Sided Kiln (A-J-18RL/00)\$290
 Rolling Stand for 10 Sided Kiln (A-J-23RL/00).....\$345
 Rolling Stand for 12 Sided Kiln (A-J-28RL/00).....\$375

CONTROL OPTIONS (PAGE 27)

Genesis Touch Screen Control (N-G-GENS/OP)\$135
 KISS Computer Software (N-G-KISS/US)\$700
 Type S Platinum Thermocouples (T-G-SJUP/UG)\$250 each
 Pyroclil metallic Thermocouples (T-G-E23M/UG)\$44 each
 High Limit Back Up Control (N-G-PKHL/00)\$640
 Back up Contactors Two-Section Kilns (N-G-BCJ2/00)\$170
 Back up Contactors Three-Section Kilns (N-G-BCJ3/00).....\$225
 Back up Contactors Four-Section Kilns (N-G-BCJ4/00).....\$280
 Back up Contactors Five-Section Kilns (N-G-BCJ5/00)\$340

ELEMENT OPTIONS (PAGE 28)



Quad Element Option: Four rows of elements for each 9" kiln section. Maximum element life for constant high-firing. See page 28. Prices below.

APM Elements. Priced by Quote.

Model No.	Kiln Price	Powered Bottom	Furn Kit	Quad Elem	No. of Shelves F=full, H=half	Inside Diam	Inside Height	Cubic Feet	Cone Rating	240/1 KW-Amp-Fuse	240/3 KW-Amp-Fuse	208/1 KW-Amp-Fuse	208/3 KW-Amp-Fuse	Lbs Kiln	L b s w/Kit
-----------	------------	----------------	----------	-----------	-------------------------------	-------------	---------------	------------	-------------	-------------------	-------------------	-------------------	-------------------	----------	-------------

JD JUPITER KILNS WITH 2.5" BRICK

JD18	\$2050	n/a	\$340	\$200	15.5" (1F, 4H)	17.5"	18"	2.6	10	5.5~23.0~30	5.5~19.9~30	5.5~26.5~30	5.5~23.0~30	200	245
JD18X	\$2850	n/a	\$380	\$280	15.5" (2F, 4H)	17.5"	27"	3.9	10	8.3~34.5~50	8.3~19.9~30	8.3~39.8~50	8.3~23.0~30	245	295
JD23V	\$2725	\$525	\$380	\$225	21" (1F, 4H)	23.5"	18"	4.7	5	7.0~29.3~40	7.0~25.4~40	6.1~29.3~40	6.1~25.4~40	275	350
JD230V	\$3375	\$525	\$475	\$340	21" (2F, 4H)	23.5"	27"	7.0	10	10.6~44.0~60	10.6~25.4~40	9.1~44.0~60	9.1~25.4~40	330	425
JD236V	\$4050	\$525	\$545	\$440	21" (3F, 4H)	23.5"	36"	9.4	10	14.1~58.6~80	14.1~38.1~50	12.2~58.6~80	12.2~38.1~50	360	455
JD245V	\$4750	\$525	\$635	\$555	21" (4F, 4H)	23.5"	45"	11.8	10	17.6~73.3~100	17.6~50.8~70	15.2~73.3~100	15.2~50.8~70	445	560

JD JUPITER KILNS WITH 3" BRICK

JD18-3	\$2125	n/a	\$340	\$200	15" (1F, 4H)	16.5"	18"	2.5	10	5.5~23.0~30	5.5~19.9~30	5.5~26.5~30	5.5~23.0~30	230	280
JD18X-3	\$2975	n/a	\$380	\$280	15" (2F, 4H)	16.5"	27"	3.7	10	8.3~34.5~50	8.3~19.9~30	8.3~39.8~50	8.3~23.0~30	270	320
JD23V-3	\$2850	\$525	\$380	\$225	20" (1F, 4H)	22.5"	18"	4.5	5	7.0~29.3~40	7.0~25.4~40	6.1~29.3~40	6.1~25.4~40	315	340
JD230V-3	\$3525	\$525	\$475	\$340	20" (2F, 4H)	22.5"	27"	6.7	10	10.6~44.0~60	10.6~25.4~40	9.1~44.0~60	9.1~25.4~40	385	470
JD236V-3	\$4250	\$525	\$545	\$440	20" (3F, 4H)	22.5"	36"	8.9	10	14.1~58.6~80	14.1~38.1~50	12.2~58.6~80	12.2~38.1~50	460	545
JD245V-3	\$5000	\$525	\$635	\$555	20" (4F, 4H)	22.5"	45"	11.1	10	17.6~73.3~100	17.6~50.8~70	15.2~73.3~100	15.2~50.8~70	540	650
JD2918-3	\$3950	\$675	\$590	\$280	25.5" (6H)	28"	18"	6.8	5	9.1~38.0~50	9.1~32.9~50	8.3~40.0~50	8.3~34.6~50	380	480
JD2927-3	\$4925	\$675	\$720	\$390	25.5" (8H)	28"	27"	10.2	10	13.7~57.0~80	13.7~32.9~50	12.5~60.0~80	12.5~34.6~50	450	575
JD2936-3	\$6275	\$675	\$855	\$530	25.5" (10H)	28"	36"	13.6	10	18.2~76.0~100	18.2~49.3~70	16.6~80.0~100	16.6~52.0~70	565	715
JD2945-3	\$7425	\$675	\$985	\$640	25.5" (12H)	28"	45"	17.0	10	22.8~95.0~125	22.8~65.8~90	20.8~100.0~125	20.8~69.3~90	645	820

Note About EZ Models: All the J2300 series are available with higher watts "EZ" elements (the same elements used in the e23T kilns) at no extra charge. See web and specification sheet for details.

Cone Rating: See above chart. **More:** See various Jupiter Automatic specification sheets at hotkilns.com/spec-jupiter-auto for additional information like shipping dimensions, electrical ratings, fuse sizes and wire connection sizes. **Power Hookup:** Plugs on kilns that have less than 48 amps, otherwise direct wired. For controls see hotkilns.com/dynatrol and hotkilns.com/zone.

PULL APART KILNS

For Sculpture and Large Structural Ceramics



PULL-APART OPTION FOR SCULPTURE

Any Jupiter or DaVinci kiln can be made with the Pull-Apart Option.

Includes floor mount stand for control panel, lift off lid with extra handles but no hinge.

This option allows the entire kiln to be dismantled to make it easy to load large sculptural pieces. The kiln sections are unplugged and then taken off one at a time.

There is no charge for this option. However, If you want the "Easy-Lift, Easy-Load" spring hinge on the Jupiter Series there is a \$235 extra charge.

More at hotkilns.com/pull-apart-kilns



An example of a super large special DaVinci Pull-Apart kiln that is 42" square by 85" high

JH SERIES

Crystalline Glaze Kilns

This is the "Thoroughbred" of kilns. Designed specifically for Crystalline Glaze firing - high, fast, responsive and precise.



Not
UL499
Listed

Features & Benefits

- Designed specifically for firing crystalline glaze with fast heat up, fast cool down to freeze crystals and the ability to soak without prematurely aging elements
- Cone 12 • 2400°F • 1315°C
- Includes 2-1/2" of K25 2500°F firebrick on sides and bottom with a 3" thick top
- Approximately 25% more power than base models
- Quad element holder system with super heavy-duty elements
- Type S platinum thermocouples included as standard
- DynaTrol with Dynamic Zone Control. (Optional Genesis touch screen control. See page 27).
- Includes other features that are standard on the base models
- Three-year Limited Warranty

Options

FURNITURE KIT

Cone 11 full shelves and half shelves as listed below plus a square post kit plus heat-resistant gloves. Prices below.

VENT-SURE DOWNDRAFT KILN VENT (PAGE 26)

- Vent-Sure (120 volts) (M-V-VENT/00)\$520
- Vent Doubler (M-V-VENT/DB)\$155
- Vent Control (M-V-CNTL/00)\$160

VOLTAGE, CONTROL AND ELEMENT OPTIONS (PAGE 27)

Voltage: Order 240 or 208 volts, single or three phase, or international voltages. KW, amperage, and fuse size for each voltage below. 480 volts is not available. No Charge for any voltage options.

- Genesis Touch Screen Control (N-G-GENS/OP)\$135
- KISS Computer Software (N-G-KISS/US)\$700
- SSR Power Controls Priced by Quote
- APM ElementsPrices below

SEE PAGES 26-29 FOR THESE AND MORE OPTIONS

A SPECIAL KILN DESIGNED JUST FOR CRYSTALLINE GLAZE FIRING

The JH kilns feature special higher temperature K25 firebrick for extra high cone 12 firing (and faster cool-down), extra power for fast heat up, "Quad" element configuration for extra element area, super heavy-duty thick elements to hold up to the special rigors of crystalline firing, minimal insulation to allow for fast cool down, and type S thermocouples for long life. Custom variations on the basic design such as more insulation, APM elements, more power and special sizes are available by special quote.

Note that the JD2927-JH uses a floor standing large DaVinci control panel and also includes a lid brace because of the 2.5" brick insulation.

Model No.	Kiln Price	APM Elements	Furn Kit	No. of Shelves F=full, H=half	Inside Diam	Inside Height	Cubic Feet	240/1 KW-Amp-Fuse	240/3 KW-Amp-Fuse	208/1 KW-Amp-Fuse	208/3 KW-Amp-Fuse	Lbs Kiln	Lbs w/Kit
JD18-JH	\$3050	\$665	\$340	15.5" (1F, 4H)	17.5"	18"	2.6	8.8~36.7~60	8.8~31.7~50	8.8~42.3~60	8.8~36.8~50	255	300
e23S-JH	\$3550	\$785	\$380	21" full (1F, 4H)	23.5"	18"	4.7	10.5~47.9~60	10.5~41.5~50	10.0~48.0~60	10.0~41.6~50	280	365
JD230-JH	\$5625	\$1175	\$475	21" full (2F, 4H)	23.5"	27"	7.0	13.7~57.0~80	13.7~32.9~50	12.5~60.0~80	12.5~34.7~50	400	505
JD2927-JH	\$7175	\$1225	\$720	25.5" (8H)	29"	27"	10.3	18.0~75.2~100	18.0~43.5~60	18.0~86.7~125	18.0~50.1~70	580	710

More: See hotkilns.com/spec-jh for additional information like shipping dimensions, electrical ratings, fuse sizes and wire connection sizes. For controls see hotkilns.com/dynatrol and hotkilns.com/zone. Plugs vary with model, voltage and phase. See Specification sheet.

Listings: These kilns are not yet UL499 Listed

DL SERIES

11"D x 9"H
Test Kilns



Not
UL499
Listed

Features & Benefits

The DL Series is a small test kiln available in 120, 208 or 240 volts and with either a One-Touch or DynaTrol program control. It has the full range of premium L&L features such as hard ceramic element holders, Type K 8 gauge thermocouple with ceramic protection tube, full support 14 gauge aluminized steel stand, solid peephole plug with full 1" view, proprietary reflective brick coating that protects brick and minimizes dusting, and three-year limited warranty. Now features 3" Top & bottom.

Specifications

Temperature: (See below)

Cubic Feet: 0.5

Inside Diameter: 11" **Inside Height:** 9"

Outside Dimensions: 19" W x 25" D x 22" H

More: See hotkilns.com/spec-doll for additional information like shipping dimensions, electrical ratings, fuse sizes and wire connection sizes.

NOTE: The 240 or 208 volt versions are highly recommended for high fire applications.

Options

Furniture Kit: Includes two 9" diameter full shelves and four each of 1/2", 1", 1-1/2", 2", 2-1/2", 3" and 4" triangular posts.

Controls: Choice of DynaTrol, Genesis touch screen control, or One-Touch Control (see below for prices and see opposite page for description of the controls).

Quad Element System (watts & amps do not change - there are four rows of elements with Quad system). Prices below.

Model No.	Kiln Price	Furn Kit	Quad Elements	Temperature Control	Cone Rating	Watts	Amps	Volts	Fuse	Plug	Lbs Kiln	Lbs w/Kit
DL11-DB	\$1250	\$135	\$130	One-Touch	5	1800	15	120	20	5-15	110	130
DLH11-DB	\$1250	\$135	\$130	One-Touch	6	2160	18	120	25	5-20	110	130
DL11-D	\$1400	\$135	\$130	DynaTrol	5	1800	15	120	20	5-15	110	130
DLH11-D	\$1400	\$135	\$130	DynaTrol	6	2160	18	120	25	5-20	110	130
DLH11-DXB-240	\$1250	\$135	\$130	One-Touch	10	2800	11.7	240	15	14-30	110	130
DLH11-DXB-208	\$1250	\$135	\$130	One-Touch	10	2800	13.5	208	20	14-30	110	130
DLH11-DX-240	\$1400	\$135	\$130	DynaTrol	10	2800	11.7	240	15	14-30	110	130
DLH11-DX-208	\$1400	\$135	\$130	DynaTrol	10	2800	13.5	208	20	14-30	110	130

Listings: These kilns are not yet UL499 Listed.

FUEGO

13.5"D x 18"H
20 Amp
Cone 10
Craft Kilns



Not
 UL499
 Listed

Features & Benefits

The Fuego kiln has been used for years internationally and is now offered in the USA with even more power for faster heat up and longer element life.

The Fuego Craft Kiln reaches Cone 10 with power to spare. This ideally sized home craft kiln uses a minimal 240 volt 20 amp circuit. Includes simple One-Touch program control (or optional DynaTrol). Great for apartments or houses with smaller power systems.

L&L Premium Features: hard ceramic element holders, Type K 8 gauge thermocouple with ceramic protection tube (single zone), full support 14 gauge aluminized steel stand, two solid peephole plugs with full 1" view, proprietary reflective brick coating that protects brick and minimizes dusting, and three-year limited warranty.

Special Features: Brick thickness is 3" and also includes a layer of non-RCF fiber between the stainless steel case and firebrick for extra insulation, a door shut-off switch for the elements, and an extra peephole plug in the top for manual venting.

Specifications

Temperature: 2350°F, Cone 10

Cubic Feet: 1.5

Inside Diameter: 13.5" **Inside Height:** 18"

Outside Dimensions: 22" W x 27" D x 31" H

Options

Furniture Kit: Includes three 12" diameter full shelves and four each of 1", 2", 4" and 6" triangular posts.

240, 220 or 208 single phase are all standard options. 3 phase not available. No Charge for any voltage options.

Quad Element System (watts & amps do not change - elements doubled & more massive with Quad system). Prices below.

Controls: Choice of DynaTrol, Genesis touch screen control, or One-Touch Control.



ONE-TOUCH CONTROL

One touch and you are ready to fire your bisque and glaze programs (It is easy to adjust simple parameters like cone, delay, hold, heat-up and

cool-down rates). You can even create four custom ramp/hold programs. hotkilns.com/one-touch



DYNATROL ZONE CONTROL

DynaTrol with 4 Easy-Fire programs (Slow Bisque, Fast Bisque, Slow Glaze, Fast Glaze), 6 Vary-Fire custom programs, PreHeat, Delay, Program & Segment Review, and Diagnostics. Zone control with 2 or 3 zones. Separate Type K 8 gauge thermocouples with ceramic protection tubes. hotkilns.com/dynatrol Genesis touch screen control optional (see page 27).

Model No.	Kiln Price	Furn Kit	Quad Elem	Control	Inside Diam	Inside Height	Cubic Feet	Exterior Dimensions	240V KW-Amp-Fuse	208V KW-Amp-Fuse	Ship Lbs	Lbs w/Kit
F1418-3	\$1600	\$155	\$175	One-Touch	13.5"	18"	1.5	22W x 31H x 27D	3.8-16-20	3.8-18.5-25	150	175
F1418-3-D	\$1750	\$155	\$175	DynaTrol	13.5"	18"	1.5	22W x 31H x 27D	3.8-16-20	3.8-18.5-25	150	175

More: See hotkilns.com/spec-fuego-usa for additional information like shipping dimensions, electrical ratings, fuse sizes and wire connection sizes. **Listings:** These kilns are not yet UL499 Listed.

LIBERTY-BELLE

16.5 or 17.5"D x 18"H

2.5 Cubic Feet

Plugs into Dryer Outlet

The perfect craft kiln and great for people who need to stay portable. The 12 foot cord plugs into your 30 amp dryer outlet!



Features & Benefits

This kiln is designed for the home. Sized at 2.5 cubic feet (16-1/2" diameter by 18" high) it features the intuitive One-Touch™ control, 3" of energy saving brick, a 12 foot long cord that plugs into a 30 amp dryer outlet, sectional construction for easy set up, cone 10 operation, fast heat up, ceramic element holders for durability and many other features. Easy to use and easy to move.

One-Touch™ Intuitive Kiln Control



Easily fire bisque and glaze programs (easy to adjust cone, delay, hold, heat-up and cool-down rates). Or create 4 custom ramp/hold programs. hotkilns.com/one-touch

- 12 foot long cord with Nema 14-30 dryer type plug
- Cone 10 • 2350°F • 1290°C
- Hard ceramic element holders
- Full support 14 gauge aluminized steel stand
- Solid peephole plugs with full 1" view
- Proprietary reflective brick coating
- c-MET-us listed to UL499 standards
- Three-year Limited Warranty

Options

Furniture Kit: Includes Cone 11 shelves. One full round and four half round shelves as listed above plus four each of 1", 2", 4" and 6" triangular posts. Prices below.

240, 220 or 208 single phase are all standard options. 3 phase not available. No Charge for any voltage options.

Quad Element System (watts & amps do not change - elements doubled & more massive with Quad system). Prices below.

Vent-Sure Vent 120 Volt. (Page 26).....\$520
(NOTE: The vent control is not available on this kiln)

ROLLING STAND

Rolling stand with locking casters (see page 28).....\$290

PLUG & CORD OPTIONS

Standard Nema 12 foot long 14-30 plug can be changed by customer to NEMA 14-50 (hardware is included to do this).

A 12 foot NEMA 6-30 plug, NEMA 15-50 or 6-50, NEMA 10-30 or NEMA 10-50 plug is available for prices below. A 6 foot long 6-50 plug available at no charge. All plugs can be changed in the field.

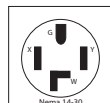

Standard

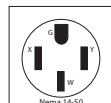

Standard

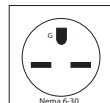

No charge

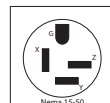

\$70

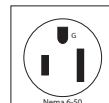

\$70

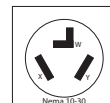

\$70

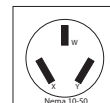

\$70

Model No.	Kiln Price	Furn Kit	Quad Elem	No. of Shelves F=full, H=half	Brick Thick	Inside Diam	Inside Height	Cubic Feet	Exterior Dimensions	240V KW~Amp~Fuse	208V KW~Amp~Fuse	Ship Lbs	Lbs w/Kit
LB18	\$1850	\$200	\$200	15.5" (1F, 4H)	2.5"	17.5"	18"	2.6	29W x 31H x 30D	5.7~23.9~30	5.0~23.9~30	200	240
LB18-3	\$1900	\$200	\$200	15" (1F, 4H)	3"	16.5"	18"	2.5	29W x 32H x 30D	5.7~23.9~30	5.0~23.9~30	215	250

More: See hotkilns.com/spec-liberty-belle for additional information like shipping dimensions, electrical ratings, fuse sizes and wire connection sizes. **UL499:** Listed by MET to UL499 Standards.

EASY-FIRE XT

Square Kilns with Easy-Fire Control Panel



Not
UL499
Listed

Features & Benefits

- DynaTrol Dynamic Three Zone Control (Genesis touch screen control optional. See page 27).
- 4 Easy-Fire plus 6 Custom Programs
- Hard Ceramic Element Holders
- Cone 10 • 2350°F • 1290°C
- Full-View Solid Peephole Plugs
- Stainless Spring Hinge - Wide Open for Easy Loading
- Full-Support Heavy-Duty 14 Gauge Aluminized Stand
- Fold Down Angled Panel for Easy Maintenance
- Same square body shape used in our DaVinci Series with strong arched sides with extra space added to interior dimensions for good air circulation
- 6-50 or 15-50 plug on most models (some are direct wired - see specification sheet)
- Three-year Limited Warranty

Options

Furniture Kit: Includes Cone 11 full shelves and half shelves as listed below plus a square post kit which includes six each 1/2", 1", 2", 4", 6" and 8" high 1-1/2" square cordierite posts plus heat-resistant gloves. Prices below.

Vent-Sure (120 volts) (M-V-VENT/00)\$520
 Vent Doubler (M-V-VENT/DB)\$155
 Vent Control (M-V-CNTL/00)\$160

Voltage Options: Order 240 or 208 volts, single or three phase, or international voltages. KW, amperage, and fuse size for each voltage below. 480 volts is not available. No Charge for any voltage options.

CONTROL OPTIONS

Genesis Touch Screen Control (N-G-GENS/OP)\$135
 KISS Computer Software (N-G-KISS/US)\$700
 Type S Platinum Thermocouples (T-G-SJUP/UG) \$250 each
 Pyrocil metallic Thermocouples (T-G-E23M/UG) \$44 each

ELEMENT OPTIONS (PAGE 28)

Quad Element Option: Four rows of elements for each 9" kiln section. Maximum element life for constant high-firing. Pricing below.

APM Elements: Priced by Quote.

SEE PAGES 26-29 FOR THESE AND MORE OPTIONS

Model No.	Kiln Price	Furn Kit	Quad Elem	Shelves in Furn Kit	Inside W x D	Inside Height	Cubic Feet	External Dimensions	Stand KW	240/1 Amp-Fuse	240/3 Amp-Fuse	208/1 Amp-Fuse	208/3 Amp-Fuse	Lbs Kiln	Lbs w/Kit
E2318-XT	\$4100	\$405	\$290	(4) 20" x 10"	22" Square	18"	5.0	40W x 32H x 42D	9.5	39.4~50	34.1~50	45.5~60	39.4~50	500	550
E2327-XT	\$4625	\$515	\$400	(6) 20" x 10"	22" Square	27"	8.1	40W x 41H x 42D	11.5	48.8~60	27.1~40	48.0~60*	32.0~40	600	665

Furniture Kit: Includes Cone 11 shelves listed above plus Large Square Post Kit and insulated gloves for unloading.

Cone Rating: All e2318-XT kilns are Cone 10. All e2327-XT kilns are cone 10 except the 208 volt, single phase version which only has 10 KW because of the 48 amp limitation. All models have cords. **Listings:** These kilns are not yet UL499 Listed.

DAVINCI KILNS

Square & Rectangular Top-Loading Kilns

This is L&L's classic production kiln. Also great for Universities and high volume High School programs.



- DynaTrol with Dynamic Zone Control (2 zones in 18" high models, 3 zone in all other models)
- Cone 10 • 2350°F • 1290°C (All models)
- Counterbalanced Lid with springs inside of tubes
- Safety Latches for Lid
- Welded angle-iron powder-coated stand and hinge
- 3" brick with all brick construction (including lid)
- Strong arched sides with extra space added to interior dimensions for good air circulation
- Three elements per 9" section
- Ceramic Element Terminals
- Hard ceramic element holders
- Plug in kiln sections (except 480 volt models)
- Floor mounted control panel (except for X2300 series)
- c-MET-us listed to UL499 Standards

Features & Benefits

CONSTRUCTION

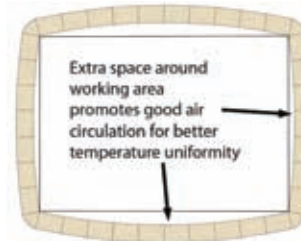

Sectional: Made of 9" high sections with a reversible bottom. The case is stainless steel wrapped around 3" of K23 highly insulating firebrick with 3 adjusting screw clamps per section.

Strong arched sides with extra space added to interior dimensions for good air circulation.

Spring-hinged counterbalanced top. Safety latch prevents lid from closing while loading. Design allows extra sections to be added and adjusted.

Firebrick is coated with a proprietary anti-dusting, hardening, & reflective coating.

Full-view solid ceramic peephole plugs are 1" diameter non-tapered with heat-locked head. There is one for each section.



ELEMENT HOLDER SYSTEM

Patented hard ceramic element holders protect brick and elements from wear and loading damage. All-ceramic element connection block and hard holders makes changing elements easy.

DYNAMIC ZONE CONTROL

DynaTrol with 4 Easy-Fire programs (Slow Bisque, Fast Bisque, Slow Glaze, Fast Glaze), 6 Vary-Fire custom programs, PreHeat, Delay, Program & Segment Review, and Diagnostics. Zone control with 2 or 3 zones. Separate Type K 8 gauge thermocouples with ceramic protection tubes. Genesis touch screen control optional (see page 27).

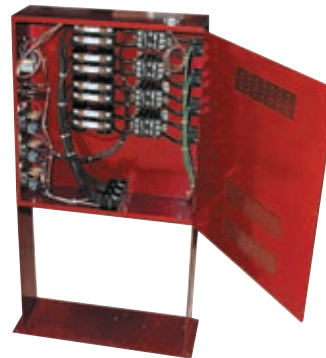

FLOOR STANDING PANEL

All controls and components are mounted in a separate control box mounted on the floor away from the kiln. Branch fused and neatly laid out circuits. On/off switch and control fuse included.

INSTRUCTIONS AND SUPPORT

Complete visual instructions with control reference, process information, assembly, troubleshooting, and parts list. Web videos show how to use the control. (hotkilns.com/videos)

Limited 3 year warranty. (hotkilns.com/warranty)

You can view all features of L&L Kilns at hotkilns.com/features

Options

FURNITURE KIT

Includes Cone 11 shelves as listed below plus one to three post kits which includes six each 1/2", 1", 2", 4", 6" and 8" high 1-1/2" square cordierite posts plus heat-resistant gloves. Prices below.



CONTROL OPTIONS (PAGE 27)

- Genesis Touch Screen Control (N-G-GENS/OP)\$135
- KISS Computer Software (N-G-KISS/US)\$700
- Type S Platinum Thermocouples (T-G-SJUP/UG) \$250 each
- Pyrociil metallic Thermocouples (T-G-E23M/UG) \$44 each
- High Limit Back Up Control (N-G-PKHL/00)\$640
- Back up Contactors Two-Section Kilns (N-G-BCX2/00).....\$390
- Back up Contactors Three-Section Kilns (N-G-BCX3/00) ...\$480
- Back up Contactors Four-Section Kilns (N-G-BCX4/00).....\$555
- Back up Contactors Five-Section Kilns (N-G-BCX5/00).....\$640

VENT OPTIONS

- Vent-Sure (120 volts) (M-V-VENT/00)\$520
- Vent Doubler (M-V-VENT/DB)\$155
- Vent Control (M-V-CNTL/00)\$160

SEE PAGES 26-29 FOR THESE AND MORE OPTIONS

VOLTAGE & POWER OPTIONS (PAGE 27)

XB and TB elements, which have a higher KW rating, are available on the 27", 36" and 45" high DaVinci kilns.

High Power OptionSee High Power prices below.

240 or 208 volts, single or three phase, or international voltages. KW, amperage, and fuse size for each voltage below. No Charge except for 480 volts. See page 27 for 480 volt description.

- 480 volts/3 phase\$750
- NEMA 1 Panel (required for MET-us Listing)\$750

CERAMIC FIBER LIDS

The lid firebrick is replaced with ceramic fiber modules mounted to a metal welded frame. 2600°F ceramic fiber is folded and formed into 4" thick modules that have an alloy support system inside. The internal support of the module is stud-welded to a metal frame that matches the



normal metal frame that we use in the firebrick lid. These lids will never crack or spall. The ceramic fiber is rated in temperature higher than the kiln rating so there is no concern about shrinkage of the fiber.

These fiber lids are available as either new equipment or as retrofit kits to fit older kilns. hotkilns.com/fiber-lid

- T2300 Fiber Lid for a new kiln (P-T-23FB/NW)\$1,325
- T3400 Fiber Lid for a new kiln (P-T-34FB/NW)\$1,450
- X3200 Fiber Lid for a new kiln (P-X-32FB/NW)\$1,225

Model No.	Kiln Price	Power Botm	High Power	Furn Kit	Quad Elem	Shelves in Furn Kit	Post Kits	Inside W x D	Inside Height	Inside Cubic Feet	External Dimensions	Stand KW	High KW	240/1 Fuse	240/3 Fuse	208/1 Fuse	208/3 Fuse	Lbs Kiln	Lbs w/Kit
XB2318-D	\$5200	n/a	n/a	\$405	\$280	(4) 20" x 10"	(1)	22" Square	18"	5.0	40W x 32H x 42D	8.9	n/a	50	40	60	50	600	650
X2327-D	\$5725	n/a	\$45	\$515	\$390	(6) 20" x 10"	(1)	22" Square	27"	8.1	40W x 41H x 42D	11.7	13.4	60	40	70	40	700	765
X2336-D	\$6550	n/a	\$85	\$785	\$520	(8) 20" x 10"	(2)	22" Square	36"	10.8	40W x 50H x 42D	15.6	17.9	80	60	90	60	775	870
X2345-D	\$7200	n/a	\$120	\$890	\$640	(10) 20" x 10"	(2)	22" Square	45"	13.5	40W x 59H x 42D	19.5	22.3	100	40	125	80	875	985
XB2818-D	\$6125	\$825	n/a	\$440	\$305	(4) 23" x 11.5"	(1)	26.5" Square	18"	7.8	45W x 32H x 43D	11.6	n/a	60	60	70	60	725	795
X2827-D	\$7375	\$825	\$65	\$570	\$440	(6) 23" x 11.5"	(1)	26.5" Square	27"	11.7	45W x 41H x 43D	14.9	17.4	80	50	90	60	835	935
X2836-D	\$8250	\$825	\$110	\$890	\$580	(8) 23" x 11.5"	(2)	26.5" Square	36"	15.6	45W x 50H x 43D	19.9	23.2	100	70	125	80	935	1075
X2845-D	\$9100	\$825	\$140	\$1020	\$755	(10) 23" x 11.5"	(2)	26.5" Square	45"	19.5	45W x 59H x 43D	24.9	29.0	125	90	150	100	1050	1220
XB3218-D	\$7000	\$990	n/a	\$535	\$365	(4) 28" x 14"	(1)	30.5" Square	18"	10.0	49W x 32H x 49D	14.2	n/a	80	70	90	80	880	985
X3227-D	\$8200	\$990	\$135	\$705	\$555	(6) 28" x 14"	(1)	30.5" Square	27"	15.0	49W x 41H x 49D	18.0	21.3	100	60	125	70	1000	1150
X3236-D	\$9325	\$990	\$155	\$1050	\$755	(8) 28" x 14"	(2)	30.5" Square	36"	20.0	49W x 50H x 49D	24.4	28.4	125	80	150	100	1135	1340
X3245-D	\$10,350	\$990	\$200	\$1225	\$920	(10) 28" x 14"	(2)	30.5" Square	45"	25.0	49W x 59H x 49D	30.5	35.5	175	125	200	125	1275	1525
TB2318-D	\$6925	\$1135	n/a	\$550	\$365	(6) 22" x 11"	(1)	26.5" x 34.75"	18"	9.7	54W x 32H x 43D	15.3	n/a	80	70	100	80	900	995
T2327-D	\$8100	\$1135	\$140	\$745	\$555	(9) 22" x 11"	(1)	26.5" x 34.75"	27"	14.6	54W x 41H x 43D	19.5	23.0	100	60	125	70	1035	1175
T2336-D	\$8925	\$1135	\$160	\$1100	\$755	(12) 22" x 11"	(2)	26.5" x 34.75"	36"	19.4	54W x 50H x 43D	26.0	30.7	125	90	150	100	1165	1355
T2345-D	\$10,050	\$1135	\$210	\$1300	\$920	(15) 22" x 11"	(2)	26.5" x 34.75"	45"	24.3	54W x 59H x 43D	32.5	38.4	175	125	200	125	1300	1530
TB3418-D	\$7475	\$1350	n/a	\$820	\$440	(6) 28" x 14"	(2)	30.5" x 43.5"	18"	13.8	62W x 32H x 49D	19.9	n/a	100	90	125	100	1065	1225
T3427-D	\$8750	\$1350	\$150	\$1085	\$670	(9) 28" x 14"	(2)	30.5" x 43.5"	27"	20.7	62W x 41H x 49D	24.9	36.5	125	80	150	90	1225	1455
T3436-D	\$10,125	\$1350	\$210	\$1330	\$895	(12) 28" x 14"	(2)	30.5" x 43.5"	36"	27.6	62W x 50H x 49D	33.3	39.9	175	125	200	125	1475	1775
T3445-D	\$11,900	\$1350	\$230	\$1815	\$1125	(15) 28" x 14"	(3)	30.5" x 43.5"	45"	34.5	62W x 59H x 49D	41.6	49.8	200	150	225	175	1675	2050

More: See various DaVinci specification sheets at hotkilns.com/spec-davinci for additional information like shipping dimensions, electrical ratings, fuse sizes and wire connection sizes. **Power Hookup:** Direct wired - no plugs. For controls see hotkilns.com/dynatrol and hotkilns.com/zone. **UL499:** Listed by MET to UL499 Standards.

Crating: Protected with wood crate and foam-in-place packaging for shipment by Common Carrier. Depending on the model there are either two or three crates. Some smaller models can ship in skidded cartons.

eFL SERIES KILNS

Front-Loading Kilns



- Front-Loading
- Arched Sides and Top (like DaVinci Kilns)
- Built-In Shelves and Kiln Shelf Storage
- DynaTrol Dynamic Three Zone Control
- 4 Easy-Fire plus 6 Custom Programs
- Hard Ceramic Element Holders
- Cone 10 • 2350°F • 1290°C
- Full-View Solid Peephole Plug
- Fold Down Panel for Easy Maintenance
- Door Switch

Features & Benefits

CONSTRUCTION

Door: Horizontal swing door. Heavy-gauge metal case with easily changed brick section. Hinge is adjustable in two planes. Includes extra insulation, and easy-to-use toggle clamps. The entire door is removable and swings 180 degrees to the case for easy moving of the kiln through doors.

Stand: Heavy gauge stand with two shelves. Levelling bolts and anchor holes included. Stand comes assembled in the US and Canada but can be disassembled for compact air shipment.

Optional Built-In Shelf Rack: A built in stainless steel shelf rack and shelf for posts saves space and hundreds of dollars. (Included for free with Furniture Kit.)

Construction: Stainless steel wrapped around brick clamped with adjustable screw clamps. Sides and top are arched for super-strength.

Assembly: Door is easily removable. All models fit through a 31" wide by 75" high door. Stand is removable.

Insulation: 3" K23 firebrick. Extra 1" of microporus super backup insulation on door to balance heat distribution.

Brick Coating: Proprietary reflective brick coating included. This

helps firebrick stay strong on the surface and helps prevent dusting.

Door Element Safety Switch: Honeywell limit switch turns power off to elements when the door is open. Included as standard equipment.

Peephole Plug: One solid ceramic plug with heat-locked head. 1" diameter full-view non-tapered. Located in door center.

ELEMENT HOLDER SYSTEM

Element Holder: Patented hard ceramic element holders protect brick and elements from wear and loading damage.

Element Design: Quad heavy-duty elements on sides and back. Low watt density for long life.

Element Connections: Proprietary all-ceramic element connection block makes changing elements easy.

DYNATROL ZONE CONTROL IN PIGGY-BACKED COOL-FIRE CONTROL PANEL

Uses the Easy-Fire Control panel (see page 2)

INSTRUCTIONS AND SUPPORT

Complete visual instructions. Web videos show how to use the control. (hotkilns.com/videos)

Limited 3 year warranty. (hotkilns.com/warranty)

Options

Furniture/Shelves Kit: Shelves are cone 11 high alumina shelves. Each post kit includes six each 1/2", 1", 2" 4", 6" and 8" high 1-1/2" square cordierite posts. All furniture kits include heat-resistant gloves. See below for pricing.

VENT-SURE DOWNDRAFT KILN VENT

Vent-Sure (120 volts) (M-V-VENT/00)\$520
 Vent Doubler (M-V-VENT/DB)\$155
 Vent Control (M-V-CNTL/00)\$160

This kiln comes with a special bypass collection box with a long tube protruding from the back of the kiln base.

VOLTAGE OPTIONS

Order 240 or 208 volts, single or three phase, or international voltages. KW, amperage, and fuse size for each voltage below. 480 volts is not available. No Charge for any voltage options.

CONTROL OPTIONS

Genesis Touch Screen Control (N-G-GENS/OP)\$135
 KISS Computer Software (N-G-KISS/US)\$700
 Type S Platinum Thermocouples (T-G-SJUP/UG) \$250 each
 Pyrocil metallic Thermocouples (T-G-E23M/UG)\$44 each

ROLLING CASTER SYSTEM

Locking Swivel Casters\$430

SEE PAGES 26-29 FOR THESE AND MORE OPTIONS

Genesis control, KISS software, vent options and more.

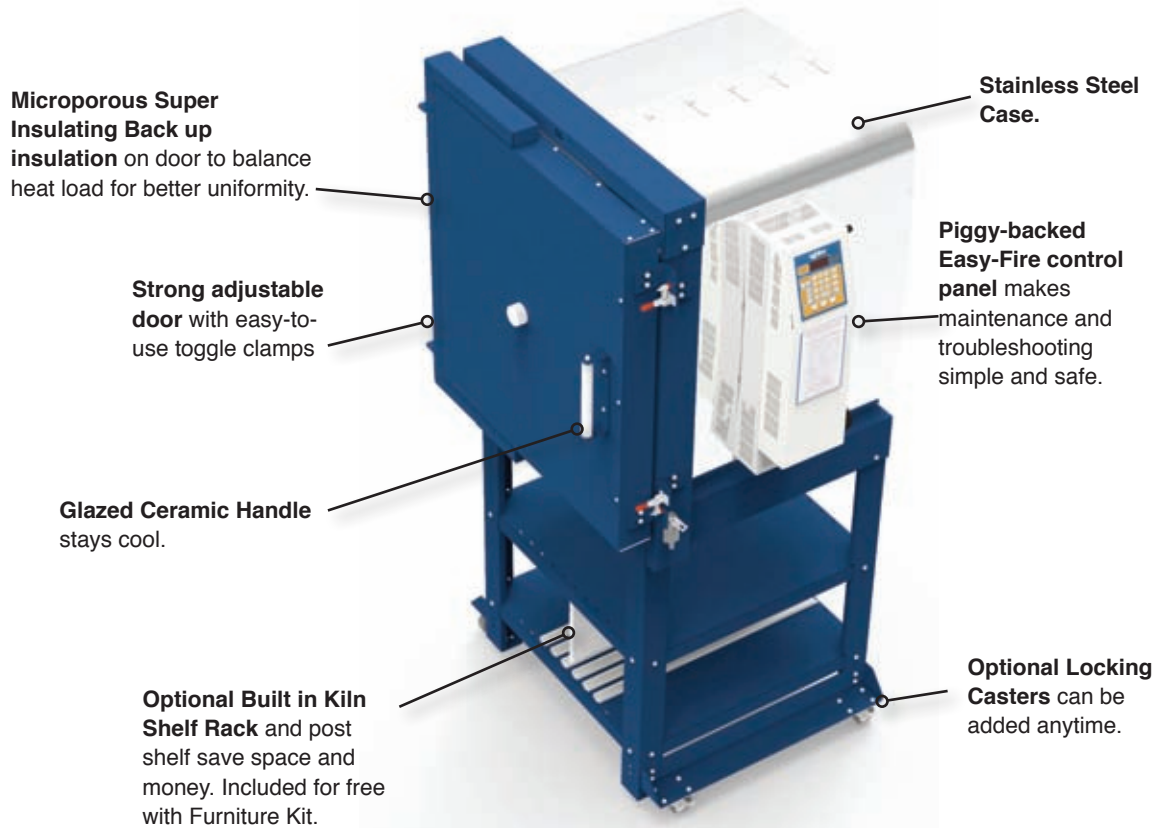

Model Number	Kiln Price	Furn Kit	Number of Shelves	Cubic Feet	Hearth Height	Inside Dimensions	Exterior Dimensions	240/1 KW-Amp-Fuse	240/3 KW-Amp-Fuse	208/1 KW-Amp-Fuse	208/3 KW-Amp-Fuse	Lbs Kiln	Lbs w/Kit
eFL1616	\$3900	\$320	(2) 14"x 24"	4.0	40"	17W x 16H x 26D	33W x 64H x 33D	9.0~37.5~50	9.0~32.5~50	9.0~43.3~60	9.0~37.5~50	390	445
eFL1626	\$4775	\$480	(3) 14"x 24"	6.6	40"	17W x 26H x 26D	33W x 73H x 33D	11.5~48.0~60	12.5~30.1~40	10.0~48.0~60*	12.5~34.7~50	560	655
eFL2026	\$5325	\$560	(6) 10"x 24"	8.6	40"	20W x 26H x 26D	38W x 73H x 33D	13.3~55.4~70	13.3~32.0~40	13.3~64.0~80	13.3~36.9~50	570	670
eFL2626	\$5900	\$670	(6) 12"x 24"	10.2	40"	26W x 26H x 26D	43W x 73H x 33D	15.4~64.0~80	15.4~37.0~50	15.4~73.9~100	15.4~42.6~60	600	700
eFL2635	\$6675	\$800	(8) 12"x 24"	13.7	32"	26W x 35H x 26D	43W x 74H x 33D	19.2~80.0~100	19.2~52.9~70	19.2~92.3~125	19.2~61.1~80	660	765

All models are rated to Cone 10 except the 208 volt single phase eFL1626 which is rated to Cone 5. * A special model eFL1626-208-X is rated at Cone 10 but has 56.0 amps with a 70 amp fuse and is wired direct. **Plugs on US Models only:** 6-50 on single phase and 15-50 on three phase for all eFL1616 models, all eFL1626 models except the special eFL1626-208-X, 3 phase eFL2026, and 3 phase eFL2626. All other models are direct wired. **More:** See eFL Specification Sheets at hotkilns.com/spec-eFl for shipping dimensions, electrical ratings, fuse and wire sizes. **Listings:** These kilns are not yet UL499 Listed.

HERCULES KILNS

Professional Medium Front-Loading Kilns



This medium-sized front-loading kiln has elements in the door, gasketed door with plug heat lock, 4-1/2" arched brick roof, door shut-off switch, removable stand, separated cool-firing control panel, powder-coated heavy fabricated case and more.



Woven tadpole fiberglass door gasket for superior door seal



4-1/2" thick K25 Full Arch for extra strength



Door Elements for Even Heating



Thick Powder-Coated Steel Case



Welded Stand (can be removed on Hercules kilns). Move by pallet jack from all four sides.



Safety Door Switch shuts off power when door is opened.

Features & Benefits for Hercules & Easy-Load

- Adjustable door with plug seal and fiberglass tadpole gasket for tight seal
- Heavy 12 and 10 gauge welded powder-coated case with stand and leveling pads
- Extra-tough High Temperature 2500°F 4-1/2" firebrick arch. Other insulation is 3" of K23 brick with 2" of mineral wool backup insulation
- Elements on door, sides and back for even firing
- Door power safety shut-off switch
- Hard ceramic element holders
- DynaTrol with Dynamic Zone Control (2 zones for EL2424-H, 3 zones for all others). (Optional Genesis touch screen control. See page 27).
- Type K 8 gauge thermocouples with ceramic protection tubes
- Control panel mounted with air space between it and the case
- Branch fusing in control panel
- Solid peephole plugs with full 1" view in the door (2 for EL2424H, 3 for all others)
- Proprietary reflective brick coating that protects brick and minimizes dusting
- MET-us listed to UL499 standards

MANUAL VENTILATION AND COOLING SYSTEM

There is a 2-3/4" by 1-7/8" brick plug on the top of the kiln and a sliding damper on the bottom to allow you to introduce cool air into the kiln without opening the door. (Note: this is not meant to

Model No.	Furn Price	Inside Kit	Dimensions	Cubic Feet	Hearth Size	Shelves in Furn Kit	Hearth Height	KW	240/1 Amp-Fuse	240/3 Amp-Fuse	208/1 Amp-Fuse	208/3 Amp-Fuse	480/3 Amp-Fuse	Lbs Kiln	Lbs w/Kit
EL2424H	\$9375	\$405	25W x 25D x 24H	8	22" x 22"	(4) 11" x 22"	30"	15.0	63.0~80	55.0~70	73.0~100	63.0~80	28.0~40	1075	1250
EL2427H	\$10,275	\$525	25W x 25D x 27H	9	22" x 22"	(6) 11" x 22"	30"	15.0	68.8~90	39.6~50	79.3~100	45.7~60	19.8~25	1200	1450

Furniture Kit: Includes the Cone 11 shelves listed above plus the Large Square Post Kit and insulated gloves for unloading. **More:** See hotkilns.com/spec-hercules for additional information like shipping dimensions, electrical ratings, fuse sizes and wire connection sizes.

Power Hookup: Direct wired. For controls see hotkilns.com/dynatrol and hotkilns.com/zone. **UL499:** Listed by MET to UL499 Standards.

EASY-LOAD KILNS

Professional Large Front-Loading Kilns



These are excellent kilns for large studios, universities, and advanced high schools as well as for industrial applications. This is a fully loaded EL2436.

Big, strong, well-built - if you need a large front-loading kiln we have it. L&L has been building front-loading kilns for over 65 years. Includes the same features as the Hercules.

Options for Hercules & Easy-Load

FURNITURE KIT

Includes Cone 11 full shelves and half shelves as listed below plus a post kit which includes six each 1/2", 1", 2" 4", 6" and 8" high 1-1/2" square cordierite posts plus heat-resistant gloves. Prices below.

VENT-SURE DOWNDRAFT KILN VENT (PAGE 26)

Vent-Sure (120 volts) (M-V-VENT/00)\$520
 Vent Doubler (M-V-VENT/DB)\$155
 Vent Control (M-V-CNTL/00)\$160

SPECIAL HINGE MOUNTING

Hinge mounted on right. Note: Control panel stays on the right-hand side. (Allow 4 weeks extra production time).....\$1020

CONTROL OPTIONS (PAGE 27)

Genesis Touch Screen Control (N-G-GENS/OP)\$135
 KISS Computer Software (N-G-KISS/US)\$700
 Type S Platinum Thermocouples (T-G-SJUP/UG) \$250 each
 Pyrocil metallic Thermocouples (T-G-E23M/UG)\$44 each
 High Limit Back Up Control (N-G-PKHL/00)\$640
 Back up Contactors EL2424 (N-G-BCE2/00)\$390
 Back up Contactors (All other models) (N-G-BCE3/00)\$480

VOLTAGE OPTIONS (PAGE 27)

240 or 208 volts, single or three phase, or international voltages. KW, amperage, and fuse size for each voltage below. No Charge except for 480 volts.

480 volts/3 phase\$750
 NEMA 1 Panel (required for MET-us Listing)\$750

Model No.	Price	Furn Kit	Inside Dimensions	Cubic Feet	Hearth Size	Shelves in Furn Kit	Hearth Height	KW	240/1 Amp-Fuse	240/3 Amp-Fuse	208/1 Amp-Fuse	208/3 Amp-Fuse	480/3 Amp-Fuse	Lbs Kiln	Lbs w/Kit
EL2436	\$15,075	\$815	25W x 25D x 36H	12	22" x 22"	(8) 11" x 22"	29"	19.0	80.0~100	46.0~60	92.0~125	53.0~70	24.0~30	1350	1500
EL2448	\$18,400	\$935	25W x 25D x 48H	16	22" x 22"	(10) 11" x 22"	18"	24.2	101.0~125	59.0~80	117.0~150	68.0~90	30.0~40	1500	1750
EL2848	\$19,750	\$1250	31W x 25D x 48H	20	28" x 24"	(12) 14" x 24"	18"	27.0	113.0~150	66.0~90	130.0~175	75.0~100	33.0~50	1750	2000
EL3048	\$22,875	\$1300	31W x 31D x 48H	25	28" x 28"	(12) 14" x 28"	18"	31.5	132.0~175	76.0~100	152.0~200	88.0~125	39.0~50	2000	2300

Furniture Kit: Includes Cone 11 shelves listed above plus 2 Large Square Post Kits and insulated gloves for unloading. **More:** See hotkilns.com/spec-easy-load for additional information like shipping dimensions, electrical ratings, fuse sizes and wire connection sizes. **Power Hookup:** Direct wired. For controls see hotkilns.com/dynatrol and hotkilns.com/zone. **UL499:** Listed by MET to UL499 Standards.

Shipping & Moving: All the kilns except the EL3048 will go through a 34-1/2" wide by 75" high door. The EL3048 needs a minimum door size of 40-1/2" wide by 76" high. All Easy-Load and Hercules kilns can be moved with a pallet-jack from any side. Crated with interior support and air-cushion skids. Shipping by air-ride truck. Fill out installation checklist prior to order: hotkilns.com/front-load-checklist.

DAVINCI BELL-LIFT KILNS

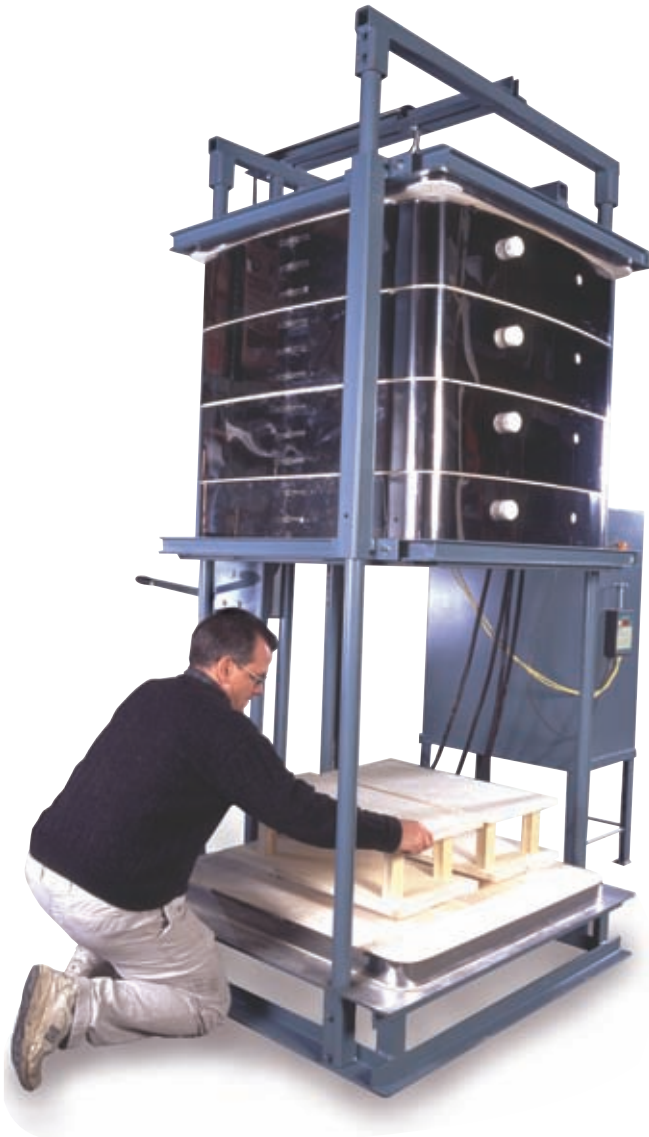

Features & Benefits

Availability: DaVinci X3200-D & T3400-D Kiln Series. Also a special version exists for much larger kilns (TB644754-D).

Application: A common complaint concerning top loading kilns, the larger ones in particular, is that it is difficult to load them. This is especially true for larger pieces, and in a production environment this labor intensive job can become very expensive over time. Moreover, some people simply aren't capable of doing this strenuous and heavy lifting. Front loading kilns are often desired because they seem to be easier to load, however, it is still a strain to put a heavy piece into the back of a front-loading kiln and these kilns are generally more expensive and difficult to move. Shuttle kilns or envelope kilns work well for loading but they are also very expensive. Bell-lift kilns are one good solution for this problem.

How it Works: The Bell-Lift accessory lifts the whole kiln up as a unit exposing the bottom of the kiln for loading from all four sides. The kiln sections and top are held together as one unit with a metal support frame. This unit is lifted up with a ratcheted hand winch mounted on the external frame. (Electric winches are available as an upgrade.) There are manual safety pins that lock the kiln in place when the kiln is fully raised.

Construction: This whole support frame is made from powder-coated heavy duty welded parts that are easily assembled on site so that the system can be easily broken down for inexpensive common carrier shipping. (It is a two to three person job to assemble the kiln. Only simple tools, like wrenches are required).

Dimensions

Height: A 18", 27" or 36" high kiln (interior) will be 105" high, and a 45" high kiln will be 123" high.

Specification sheet: hotkilns.com/spec-bell-lift

Options

For Electric Winch see hotkilns.com/bell-lift-electric-winch-video.

Motorized Winch (instead of hand winch)\$1325

Model No.	Kiln Price	Power Botm	High Power	Furn Kit	Quad Elem	Shelves in Furn	Post Kits	Inside W x D	Inside Height	Inside Cubic Feet	External Dimensions	Stand KW	High KW	240/1 Fuse	240/3 Fuse	208/1 Fuse	208/3 Fuse	Lbs Kiln	Lbs w/Kit
XB3218-BL	\$12,875	\$990	n/a	\$535	\$365	(4) 28" x 14"	(1)	30.5" Square	18"	10.0	49W x 105H x 49D	14.2	n/a	80	70	90	80	1630	1735
X3227-BL	\$13,090	\$990	\$135	\$705	\$555	(6) 28" x 14"	(1)	30.5" Square	27"	15.0	49W x 105H x 49D	18.0	21.3	100	60	125	70	1750	1900
X3236-BL	\$14,150	\$990	\$155	\$1050	\$755	(8) 28" x 14"	(2)	30.5" Square	36"	20.0	49W x 105H x 49D	24.4	28.4	125	80	150	100	1885	2090
X3245-BL	\$15,145	\$990	\$200	\$1225	\$920	(10) 28" x 14"	(2)	30.5" Square	45"	25.0	49W x 123H x 49D	30.5	35.5	175	125	200	125	2075	2325
TB3418-BL	\$12,375	\$1350	n/a	\$820	\$440	(6) 28" x 14"	(2)	30.5" x 43.5"	18"	13.8	62W x 105H x 49D	19.9	n/a	100	90	125	100	1815	1975
T3427-BL	\$14,150	\$1350	\$150	\$1085	\$670	(9) 28" x 14"	(2)	30.5" x 43.5"	27"	20.7	62W x 105H x 49D	24.9	36.5	125	80	150	90	1975	2205
T3436-BL	\$15,525	\$1350	\$210	\$1330	\$895	(12) 28" x 14"	(2)	30.5" x 43.5"	36"	27.6	62W x 105H x 49D	33.3	39.9	175	125	200	125	2225	2525
T3445-BL	\$17,300	\$1350	\$230	\$1815	\$1125	(15) 28" x 14"	(3)	30.5" x 43.5"	45"	34.5	62W x 123H x 49D	41.6	49.8	200	150	225	175	2475	2850

More: See various DaVinci specification sheets at hotkilns.com/spec-davinci for additional information like shipping dimensions, electrical ratings, fuse sizes and wire connection sizes. **Power Hookup:** Direct wired - no plugs. For controls see hotkilns.com/dynatrol and hotkilns.com/zone.

Crating: Protected with wood crate and foam-in-place packaging for shipment by Common Carrier. Depending on the model there are either two or three crates. Some smaller models can ship in skidded cartons.

JUMBO BELL-LIFT KILNS

100 Cubic Foot Industrial Kiln

Model TB644754



MORE INFORMATION

General Dimension Drawings:

See hotkilns.com/general-dimension-drawing-tb644754

See hotkilns.com/jumbo-bell-lift-kilns for more photos and assembly information.

Pricing..... Priced by Quote

Features & Benefits

Temperature Rating: Cone 10, 2350°F, 1290°C

Loading: The kiln lifts up with an electric winch. Safety latches hold the kiln in place while kiln is loaded.

Assembly: 9" high sections stack on top of each other. Frame easily bolts together. A forklift or overhead crane should be used in the assembly.

Kiln Construction: Unique shallow side arches create super-strong sides and allow for plenty of space for air circulation.

Insulation: 3" K23 firebrick on sides and top. 4" ceramic fiber module top (RCF or Non-RCF depending on maximum temperature required).

Brick Coating: Reflective coating protects brick and reduces dusting.

Element Holders: Ceramic holders protect brick.

Elements: Heavy-duty. 3 elements per 9" high section.

Control Panel: Floor mounted NEMA 1 panel separate from kiln. Kiln sections attached to panel with 105°C cords. Mechanical contactors with control relays. Branch fusing. An On/Off switch and control fuse are included. Direct electrical hook-up to terminal block.

Control: DynaTrol with 4 Easy-Fire programs, 6 Vary-Fire programs, PreHeat, Delay, Program & Segment Review, and Diagnostics. (Others available - see Control options on page 27)

Zone Control: Three zone.

Peephole Plugs: Non-fragile solid ceramic with heat-locked head. 1" diameter full-view non-tapered. One per section.

Thermocouples: Type K 8 gauge with ceramic protection tubes.

Relays: Mercury free relays.

Instructions: Complete instructions with control reference, troubleshooting, and parts list. Web videos show how use the control. There is also a video showing the bell-lift raising and lowering. (hotkilns.com/jumbo-bell-kilns-raising)

Warranty: Limited 3 year warranty. (See hotkilns.com/warranty.pdf).

Specifications

Voltage: 480/3P **KW:** 87.8

Amps: 106 **Fuse:** 150 amps **Wire Size:** 2/0

Inside Dimensions: 66" W x 47"D x 54"H

Outside Dimensions: 96" W x 74" D x 160" H

Minimum Space Requirements: 120" wide by 98" deep by 165" high.

Ship Weight: 4000 lbs. Ships on a dedicated truck.

CUSTOM, INDUSTRIAL & COMMERCIAL KILNS

Years of Custom Design Experience



L&L kilns are used in many industries including advanced industrial ceramics, abrasives, aerospace, piezo ceramics, optical glass, heating processes, melting, preheating for welding, annealing, stress-relieving, solution hardening, calcining, and steel heat treating.

The wide range of standard designs and built-in heavy-duty durability features allow L&L to quickly and economically configure many designs for rigorous production use.

Special industrial controls are available from Eurotherm, Honeywell, Watlow and others.

Our sister company, L&L Special Furnace Co., Inc., makes aerospace grade heat treating furnaces.

Call L&L to discuss your needs. We have years of experience to share.

hotkilns.com/industry

LARGE FRONT-LOAD KILNS



hotkilns.com/large-custom-front-loading-kilns

We design and build special larger front-loading kilns beyond the standard EL sizes.

CAR BOTTOM KILNS

hotkilns.com/car-bottom-kilns



The ELC3648 Car Kiln works with a standard pallet jack for easy moving of the car and great sealing.

L&L also makes large traditional car bottom and shuttle kilns.

CUSTOM LARGE POLYGONAL KILNS

hotkilns.com/large-polygonal-kilns

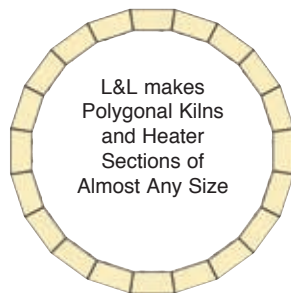

L&L makes
Polygonal Kilns
and Heater
Sections of
Almost Any Size



Custom polygonal kilns with 4-1/2" of firebrick are available by special quote. L&L can make almost any diameter and any height in multiples of 9" high sections. There are three elements per 9" high section. The base is made of welded angle-iron with leveling bolts. The bottom is typically 4-1/2" of K23 brick. These are typically cemented in sections and then held together with a stainless steel band. The top is typically made of 4" thick folded and formed ceramic fiber modules. Temperatures are limited to 2350°F (1285°C).



LARGE SQUARE & RECTANGULAR KILNS

hotkilns.com/custom-davinci-kilns

L&L designs and builds custom square and rectangular DaVinci kilns. Sizes are very flexible. The top is typically made of 4" thick ceramic fiber modules.



SPECIAL ALLOY RETORTS FOR ATMOSPHERE CONTROL

We design special high temperature retorts using various alloys like 316, 330 and Inconel 601 for high temperature work in a controlled environment.

Industrial kilns are all by special quote and are only sold direct by the factory. Send an email with your requirements. Be sure to include process, size and temperature requirements. Send email to industry@hotkilns.com

OPTIONS AND ACCESSORIES

VENT-SURE DOWNDRAFT KILN VENT SYSTEM

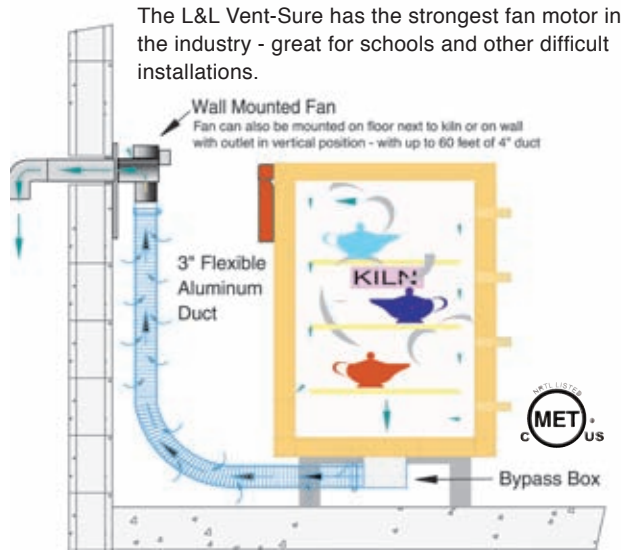

MORE INFORMATION: hotkilns.com/vent-sure

Features

- Downdraft venting pulls air down to bottom of kiln
- Improves temperature uniformity inside the kiln
- Powerful 130 CFM fan motor, typically mounted on wall, allows fumes to be under vacuum in your studio
- The strong fan motor helps overcome static pressure in long exhaust lines. The duct may be up to 60 feet in length, and include up to four 90° bends
- 120 volts with on/off switch on cord (240 volts available)
- 15 foot long flexible aluminum duct
- Bypass collection box mounted on kiln allows adjustment of venting.
- Fan motor, mounted away from the kilns, stays cool and no vibration transmitted to the kiln
- Three-year Limited Warranty
- c-MET-us Listed to UL499 standards for use on c-MET-us L&L Kilns (Easy-fire, School-Master, Jupiter, Davinci, Ergo-Lift). MET-us Listed to UL499 standards on Hercules, and Easy-Load kilns).

PRICES

Vent-Sure for 120 Volts (primarily used in the USA)
M-V-VENT/00\$520

Vent-Sure for 220-240 Volts (Usually non-USA)
M-V-VENT/EU\$570

VENT OPTIONS

MULTI-MOUNT BRACKET



A special Multi-mounting bracket is available to mount the vent motor on the floor or point the outlet vertically for ceiling installations. (hotkilns.com/multi-mounting)
M-V-MULT/00\$28

VENT DOUBLER

You can get a vent doubler option which allows you to vent two kilns that are each up to 10 cubic feet. (Note: Consider buying the Multi-Mount Bracket). Includes all parts necessary to vent two kilns - up to 10 cubic feet each with one vent.

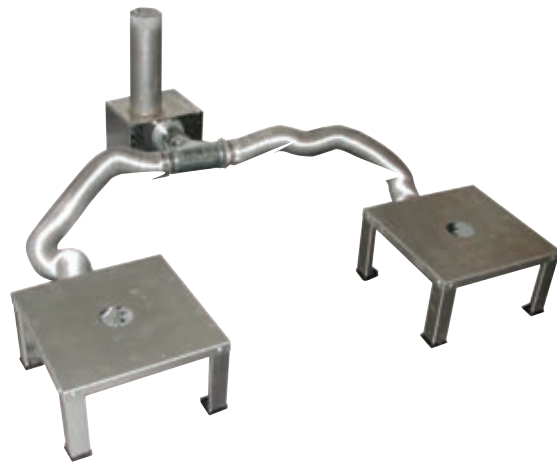

(hotkilns.com/doubler)
M-V-VENT/DB\$155

VENT CONTROL



The Vent Control allows you to automatically control the operation of the Vent-Sure kiln vent with one of the outputs from the DynaTrol (or Genesis). (hotkilns.com/vent-control)
M-V-CNTL/00\$160

CONTROL & POWER OPTIONS

GENESIS TOUCH SCREEN CONTROL

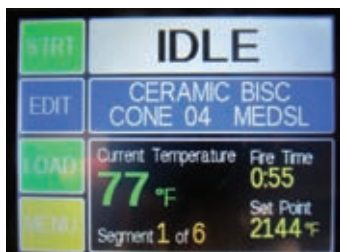

The Genesis control from Bartlett includes a touch screen interface and WIFI connectivity added to the proven software of the DynaTrol. Available on any kiln that would get a DynaTrol. Now includes a phone app that monitors temperatures in the kiln.

(hotkilns.com/genesis-touch-screen-control)
N-G-GENS/OP\$135

KISS SOFTWARE

Kiss (kiln interface software system) connects up to 50 DynaTrol controllers to a personal computer running Windows. Monitor and control kiln remotely. For the DynaTrol and Genesis only.

(hotkilns.com/kiss)
Kiln Kit Package for Extra Kilns (N-G-KISS/KK)\$68
KISS Starter Kit with USB Connection (N-G-KISS/US).....\$700

HIGH LIMIT BACK UP CONTROL

Bartlett High Limit Control with latching relay acts as a back up to the main control. If the main control fails for any reason then this acts as a "back stop" and shuts the kiln down. Available on Jupiter, DaVinci, Hercules and Easy-Load kilns only.

(hotkilns.com/high-limit)
N-G-PKHL/00\$640

BACK UP CONTACTORS

Actuated by the High Limit Back Up Digital Control, back up contactors are completely redundant power contactors so that if one or more contactors fail in a closed position then the kiln still cannot climb above the High Limit set point. Needs a large box. Available on Jupiter, DaVinci, Hercules and Easy-Load kilns only.

(hotkilns.com/high-limit)
Jupiter Two-Section Kilns (N-G-BCJ2/00).....\$170
Jupiter Three-Section Kilns (N-G-BCJ3/00).....\$225
Jupiter Four-Section Kilns (N-G-BCJ4/00).....\$280
Jupiter Five-Section Kilns (N-G-BCJ5/00)\$340
DaVinci Two-Section Kilns (N-G-BCX2/00).....\$390
DaVinci Three-Section Kilns (N-G-BCX3/00).....\$480
DaVinci Four-Section Kilns (N-G-BCX4/00).....\$555
DaVinci Five-Section Kilns (N-G-BCX5/00)\$640
EL2424 (N-G-BCE2/00)\$390
EL2427 & All Easy-Load Kilns (N-G-BCE3/00).....\$480

120 VOLT POWER SUPPLY

If there are problems with short power outages, voltage spikes, voltage drops, or excessive environmental line noise, this can cause unpredictable behavior in the electronic control. With this option the control is powered by a separate 120 volt line (with a standard 6 foot long cord) and that voltage is filtered through an EMI (Electrical Magnetic Interference) noise filter. Available on all kilns. (hotkilns.com/noise) L-G-EMIF/00\$220

SOLID STATE RELAYS

Optional Solid State Relays..... Priced by Quote

INDUSTRIAL CONTROLS

Eurotherm and other industrial controls are available. Available on DaVinci, Jupiter and Easy-Load kilns only. (hotkilns.com/eurotherm3) Priced by Quote

480 VOLTS/3 PHASE



Available for Jupiter 28" diameter kilns, DaVinci kilns, Hercules, and Easy-Load kilns. Kiln sections are hard wired to power box with flexible cords. (hotkilns.com/480)\$750

NEMA 1 CONTROL BOX:

480 volts becomes MET-us listed with this extra option. Also used in industrial applications.....\$750

THE POSITIVE DOOR INTERLOCK SWITCH



Features a strong mechanical latch that must be turned before the door can be opened. The turning of this latch breaks all power to the kiln as if you had used an external power disconnect switch or pulled the power cord from its socket.

Only available on Easy-Fire and School-Master kilns. (hotkilns.com/door-interlock) K-E-LATC/00\$320

THERMOCOUPLE OPTIONS

TYPE S THERMOCOUPLES

The best thermocouple for constant high fire applications. No thermocouple drift. Priced per thermocouple. For a single zone control you will need one, a two zone kiln two, a three zone control three. Note that kilns with four or more sections still only have a three zone control. (hotkilns.com/type-s)
T-G-SJUP/UG (Price per thermocouple).....\$250

PYROCIL SHEATHED THERMOCOUPLES

For greater sensitivity to temperature change. Use below 2200°F for sensitivity (glass is a good example). See above note about quantity required for Type S thermocouples. (hotkilns.com/pyrocil-tc) T-G-E23M/UG (Price per thermocouple)\$44

OPTIONS AND ACCESSORIES

ELEMENT OPTIONS

QUAD ELEMENT OPTION

Four rows of elements for each 9" kiln section. For maximum high-fire element life. The combination of 1/2" diameter element coils, the doubled surface area of the Quad element design, and superior heat transfer of L&L's patented ceramic element holders, make this the best element system in the world today. Available on most L&L kilns as an option. Standard on eQuad-Pro and JH Series. (hotkilns.com/quad) See Price Grids



APM SINTERED ELEMENTS

Available as a special option. Increases element life in certain situations. (hotkilns.com/apm) Priced by Quote

UNPOWERED SHORT SECTIONS

These rings are 4-1/2" high and can be put anywhere on the sectional Jupiter and DaVinci kilns.

(hotkilns.com/unpowered-sections-jupiter-kilns)

(hotkilns.com/unpowered-sections-davinci-kilns)

See hotkilns.com/parts and filter for unpowered sections to get pricing.

POWERED BOTTOMS

Available on some Jupiter and DaVinci kilns See price grids



STAND OPTIONS

ROLLING KILN STAND

L&L's rolling kiln stand features heavy gauge (14 ga) galvanized steel construction with multiple bends for extra strength, steel swivel locking casters, integrated vent collection box support, and guide rails for the kiln. Each size is fitted to the kiln.

Important special caution plates are riveted to three sides of the stand. The vent collection box is not included but, when you order a Vent-Sure vent system the longer duct is included with the system.



Rolling Stand for 8 Sided Kiln (A-J-18RL/00)\$290

Rolling Stand for 10 Sided Kiln (A-J-23RL/00).....\$345

Rolling Stand for 12 Sided Kiln (A-J-28RL/00).....\$375

SEISMIC KILN RACK AND BRACE

This special stand is designed to prevent a top-loading sectional kiln from falling over during an earthquake.

(hotkilns.com/earthquake-resistant-brace)

Seismic Stand for any 14" to 28" polygonal kiln

up to 45" high\$525

Other kilns Priced by Quote

CUSTOM OPTIONS

Discuss your custom needs with us. We customize our kilns for industrial applications and special ceramic needs. We can make very tall kilns, very large diameter kilns, add special holes, make ceramic fiber tops, use mercury relays and SSRs, add insulation. We have many years of industrial and special design experience.

SUPERIOR KILN FURNITURE



SQUARE POSTS ARE CUT SQUARE

L&L sells the highest grade ceramic extruded posts. They are very straight (even in lengths up to 12" long), precision cut for squareness (which makes shelves stable), and are strong without being excessively thick.

Posts & Post Kits

POST KITS

Large Square Post Kit

(Six each 1/2", 1", 2", 4", 6" & 8" square posts) (C-G-SPKT/LG) \$175

Small Square Post Kit

(Four each 1/2", 1", 2", 4", 6" & 8" square posts) (C-G-SPKT/SM)..... \$115

DL Series Post Kit

(Four each of 1/2", 1", 1-1/2", 2", 2-1/2", 3" and 4" triangular posts) (C-G-TPKT/DB)..... \$72

Liberty-Belle Post Kit

(Four each 1", 2", 4" & 6" triangular posts) (C-G-TPKT/LB) \$48

Large Triangular Post Kit

(Six each 1/2", 1", 1-1/2", 2", 2-1/2", 3", 4", 5" & 6" triangular posts) (C-G-TPKT/01)..... \$140

Small Triangular Post Kit

(Four each 1", 2", 3", 4", 5" & 6" triangular posts) (C-G-TPKT/00) \$76

SQUARE POSTS (1-1/2" SQUARE)

1/2" Square Post (C-G-S005/00) \$2.85
 1" Square Post (C-G-S010/00) \$3.90
 2" Square Post (C-G-S020/00) \$4.40
 4" Square Post (C-G-S040/00) \$4.95
 6" Square Post (C-G-S060/00) \$6.00
 8" Square Post (C-G-S080/00) \$7.00

TRIANGULAR POSTS

NOTE: Single triangular posts are available on the web.

FREIGHT FOR SHELVES AND FURNITURE KITS

Depending on the quantity and size of shelves, posts and furniture kit(s) ordered, the order may have to ship by common carrier freight. Skid/carton charge..... \$50

Round & Polygonal Shelves

11" DIAMETER KILNS

For Doll/Test Kilns

Full Round 9" diameter shelf (3/8" thick) (H-D-9000/00) \$30

14" DIAMETER KILNS

For Fuego Kilns (with 3" brick)

Full Round 12" diameter (1/2" thick) (H-J-1200/00) \$35

For J14 Kilns (with 2-1/2" brick)

Full Round 13" diameter (1/2" thick) (H-J-1300/00) \$35

Half Round 13" diameter (1/2" thick)

(H-J-1350/00) \$21

16-1/2" DIAMETER KILNS

For LB18-3, e18S-3 & e18T-3, and J18-3 kilns with 3" brick

Full Round 15" diameter (5/8" thick) (H-J-150A/00) \$44

Half Round 15" diameter (5/8" thick)

(H-J-155A/00) \$26

17-1/2" DIAMETER KILNS

For LB18, e18S & T, and J18 kilns with 2-1/2" brick

Full Octagonal 15-1/2" diameter (5/8" thick) (H-J-1500/00) \$44

Half Octagonal 15-1/2" diameter (5/8" thick)

(H-J-1550/00) \$26

22" DIAMETER KILNS

For e23S-3, e23T-3, SM23T-3, & J2300-3 kilns with 3" brick

Full Round 20" diameter (3/4" thick) (H-J-2000/00) \$84

Half Round 20" diameter (3/4" thick)

(H-J-2050/00) \$43

23" DIAMETER KILNS

For e23S, e23T, SM23T & J2300 kilns with 2-1/2" brick

Full Round 21" diameter (3/4" thick) (H-J-2100/00) \$85

Half Round 21" diameter (3/4" thick)

(H-J-2150/00) \$44

28" & 29" DIAMETER KILNS

For e28S, e28T, SM28T, J2900 Series with 2-1/2" or 3" brick

Half Round 25-1/2" diameter (3/4" thick) (H-J-2650/00) \$73



HIGH ALUMINA SHELF MATERIAL CONE 11 RATING

All shelves are made of a press-molded (not cast) high alumina cordierite body that holds up to Cone 11 firing with little warping.

Rectangular Shelves

SQ1818, SQ1827, EL1824, EL3648 X1800 SERIES

8" x 16" rectangular (5/8" thick) (H-S-1608/00) \$38

16" x 16" square (3/4" thick)

(H-S-1616/00) \$73

X2300 SERIES, E2318XT, E2327XT

10" x 20" rectangular (5/8" thick)

(H-X-2010/00) \$51

X2800 SERIES, E2818XT, E2827XT

11-1/2" x 23" rectangular (3/4" thick)

(H-X-2311/00) \$64

T2300 SERIES, EL2424-H, EL2427-H, EL2436 & EL2448

11" x 22" rectangular (3/4" thick)

(H-X-2211/00) \$62

EFL2026

10" x 24" rectangular (3/4" thick)

(H-X-2410/00) \$62

EFL2626, EFL2635

12" x 24" rectangular (3/4" thick)

(H-X-2412/00) \$64

EL2848, EFL1616, EFL1626

14" x 24" rectangular (3/4" thick)

(H-X-2414/00) \$76

X3200 SERIES, T3400 SERIES & EL3048

28" x 14" rectangular (3/4" thick)

(H-X-2814/00) \$82

SIGNATURE L&L FEATURES

HARD CERAMIC ELEMENT HOLDERS - KEY TO L&L'S DURABILITY

The smooth, hard surface of the inside ceramic channel allows the elements to expand and contract freely. No pins! This prevents catastrophic element failure. Elements do not droop out of broken firebrick channels. The dense ceramic DynaGlow holders extend element life because they do not insulate the hot elements from the kiln interior.

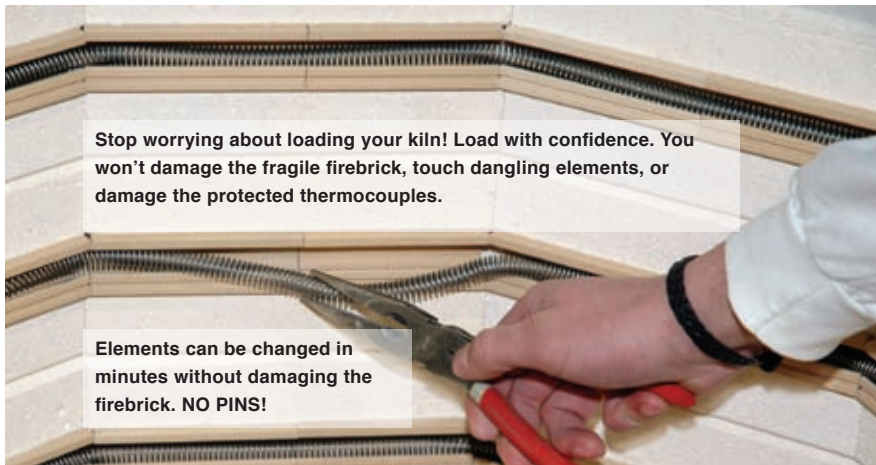

OTHER DURABILITY FEATURES

PROTECTED THERMOCOUPLES

L&L thermocouples are shielded from corrosion by a ceramic protection tube. We use the finest "special limit" aerospace-grade heavy-gauge thermocouple wire. The protection tube prevents black dust from the thermocouple end from discolouring your work. (hotkilns.com/tc-protection)



CERAMIC ELEMENT TERMINALS

Ceramic element terminals make element changes easy. (hotkilns.com/ceramic-terminal)



SOLID PEEP PLUGS

Solid straight ceramic peephole plugs are strong and will not slip out like tapered, fragile, slip-cast plugs. (hotkilns.com/peephole-plugs)



CORROSION RESISTANCE

Stainless steel, aluminized, and galvanealed steel are used where needed. All other metal is powder-coated which also resists corrosion. (hotkilns.com/corrosion-resistant)

PROPRIETARY BRICK COATING

L&L's proprietary reflective brick coating protects the surface of the firebrick and keeps dusting down inside the kiln. (hotkilns.com/reflective-coating)

LID BRICK IS SECURED WITH CLIPS

Stainless "U" brackets secure lids - not friction. (hotkilns.com/lid-clips)

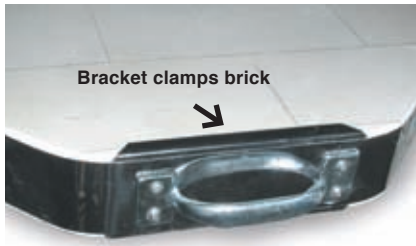

FULL-SUPPORT STANDS

On all polygonal kilns we use a Full-support 14 gauge aluminized steel stand is stronger than hollow frame stands and provides important support in the center of the bottom. (hotkilns.com/full-stand)

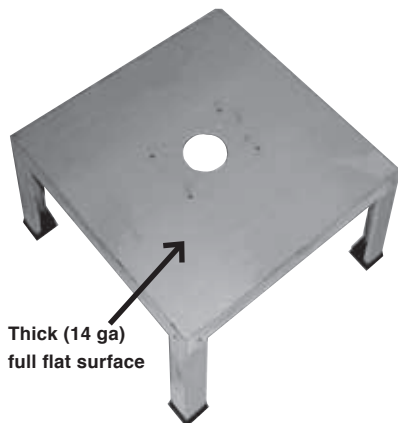

PERFORMANCE

DYNATROL IS EASY AND POWERFUL



DynaTrol with 4 Easy-Fire programs (Slow Bisque, Fast Bisque, Slow Glaze, Fast Glaze), 6 custom programs, PreHeat, Delay, Program, Segment Review, and Diagnostics. (hotkilns.com/dynatrol) Also see optional controls on page 27.

DYNAMIC ZONE CONTROL

The DynaTrol separately measures temperatures in the bottom, middle and top of the kiln and automatically adjusts the heat output of three zones during the entire firing. Kiln temperatures are automatically evened out to within 1/2 cone or better top to bottom. Zone control automatically compensates for many loading issues and element changes over time. Even on kilns where we use graded elements, L&L kilns are fundamentally uniform because the element holders radiate the heat more evenly. (hotkilns.com/zone)

"EASY-OPEN, EASY-LOAD" LID OPENS WIDE FOR LOADING

The whole kiln supports the lid (not just one section). Our positive safety pin secures the lid safely. No support bars (like other kilns) get in the way of loading when the lid is fully tilted back. (hotkilns.com/spring-hinge)

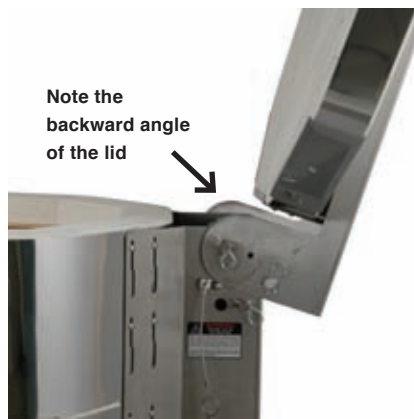

SAFETY

UL499 LISTING

Most L&L kilns are c-MET-us listed to UL499 standards. See each kiln series for details. (hotkilns.com/ul499)



SAFE MATERIALS

No asbestos, mercury, lead, or other hazardous materials are used in L&L kilns.

SAFETY LATCHES ON LIDS

All lids and lifting devices include a safety latching system. On/Off & safety switches.

MAINTAINABILITY

L&L KILNS ARE EASY TO TROUBLESHOOT

Open up any L&L kiln control panel and see how easy it is to check amps, element resistance, and voltage. No other kiln can be serviced as quickly, easily, or inexpensively as an L&L kiln.

SECTIONAL CONSTRUCTION MAKES REPAIR WORK EASY

All top-loading L&L kilns are sectional. Even the large 35 cubic foot standard DaVinci kiln is easy to move, set up, and repair.

THREE-YEAR WARRANTY

See hotkilns.com/warranty. Free email, web and phone support forever.

IN-DEPTH SUPPORT

One customer said: "I am truly impressed with your website, it is more than informative and your products are well designed. The fact that all the information, including repair manuals, are listed, speaks well of your dedication to customer service." Our website has thousands of pages of technical help - all easily searchable - plus we provide expert free support with phone and email.



VISUAL INSTRUCTIONS

No one has a better or more complete instruction manual. Our visual instructions address the needs of the artist, the installer, and the repair person. You get a fully illustrated operation and service manual. Various instructional videos are available. (hotkilns.com/videos)

WHAT L&L CUSTOMERS SAY



BILL CAMPBELL

"I make a living out of my five L&L kilns. I really beat them up, firing them at least three times a week to Cone 10. They take a real beating and keep on going."

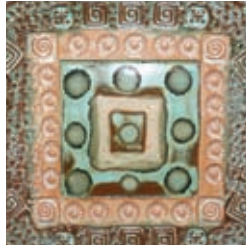

DIANE EMERSON

"I switched to L&L because of the deterioration of the element channels in my last kiln. I load larger tiles and I need the extra durability on the face of the firebrick."



FRANK GIORGINI

"My original L&L (J2927) has provided outstanding service and reliability through the firing of countless pots, tiles, udu drums, sculptures and two New York City MTA Subway projects. It's still in service right next to my DaVinci kiln."



More Information & Support at hotkilns.com

Prices in this catalog are subject to change without notice. Prices are always current on our web site. Find complete specifications, support videos, photos, parts, PDF Library, and thousands of pages of knowledgebase information easily, using our sophisticated search engine.



505 Sharptown Road • Swedesboro, NJ 08085
 Phone: 856.294.0077 • Fax: 856.294.0070
 sales@hotkilns.com • hotkilns.com

KILNS BUILT TO LAST

Prices Effective January 1, 2019 Bulletin No: CAT-1-19C